

DRIVELINE COMPONENTS CATALOGUE 2023

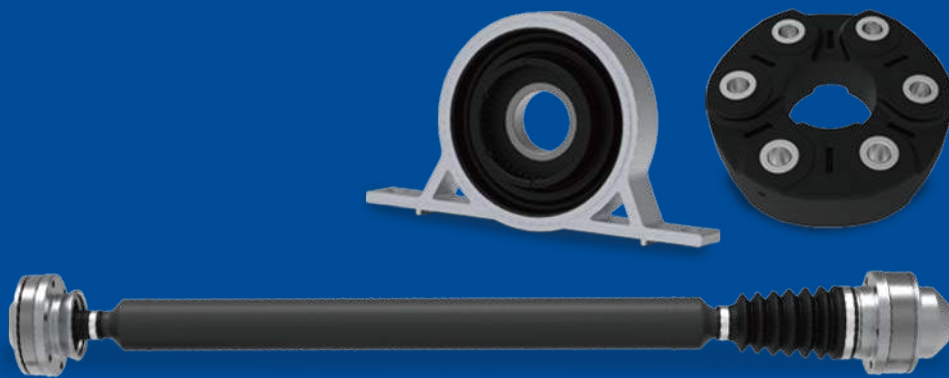

GS[®]P

GSP AUTOMOTIVE GROUP



GSP Automotive Group is a leading manufacturer for automotive parts for the worldwide aftermarket. Since 1985, GSP continues to produce constant velocity joints, drive shafts, hub assemblies, rubber-to-metal parts as well as steering & suspension parts.

The GSP team supports over 120 countries and counting. With our diverse range of native professionals, we bring customer care and expertise to each market.

WIDE RANGE PRODUCTS

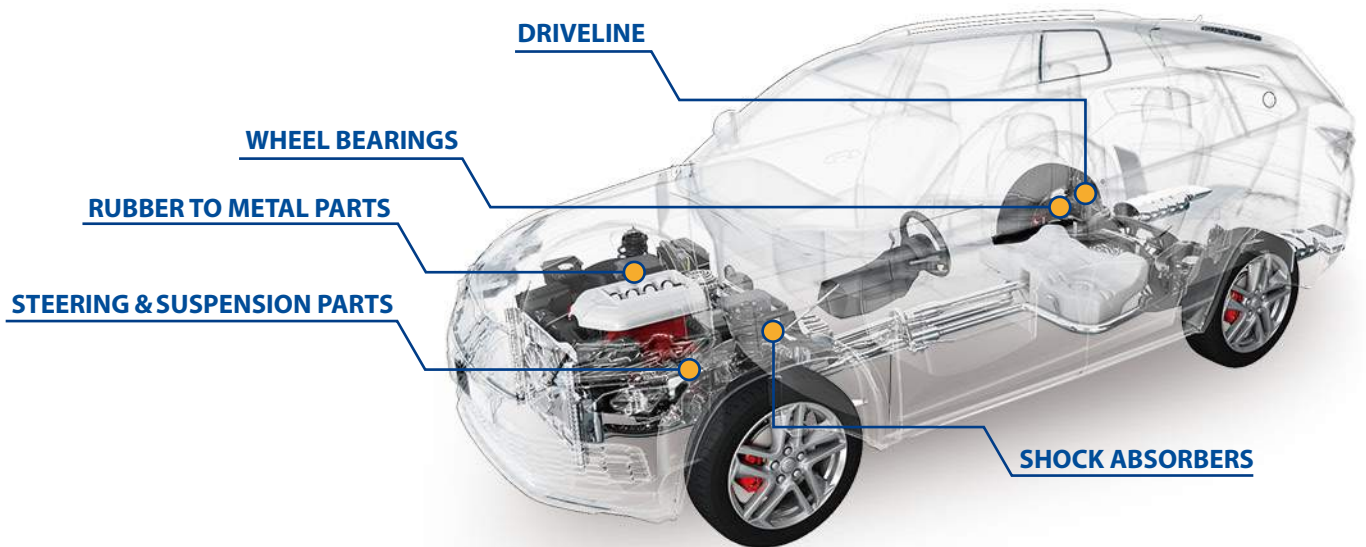

- Models covered over 95% of the worldwide automotive market
- One-stop solution for the automotive aftermarket
- Small batch sourcing with a variety of categories

WORLDWIDE LOCATION

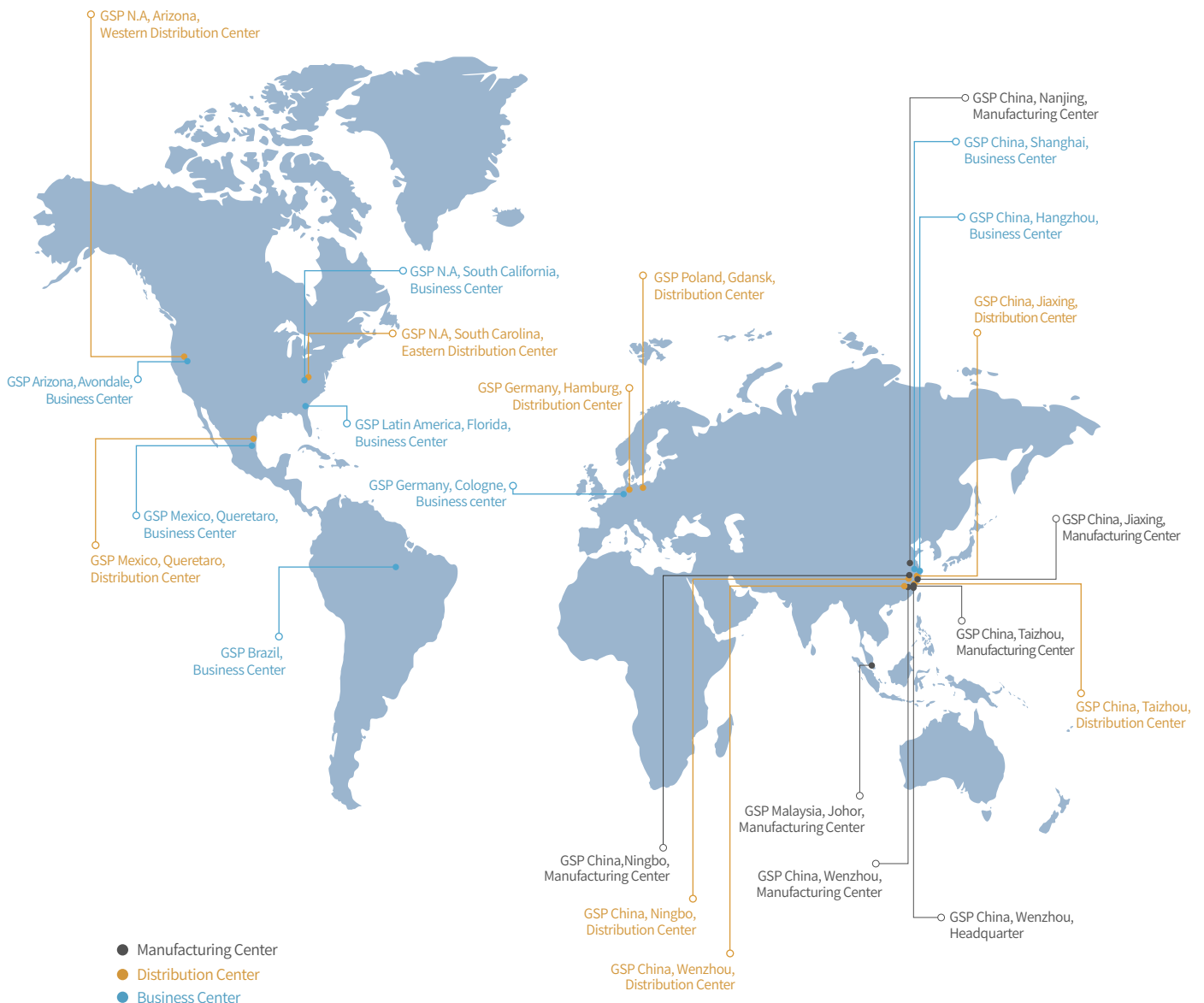

PREMIUM QUALITY



GSP has been certified by ISO 14001, ISO 45001 and IATF 16949, etc. With the strict screening and monitoring of the raw material, GSP is carrying out quality control on the whole product production process.

CUSTOMER SERVICES



Worldwide customer services teams support nine majority languages and provide localized service to customers.

Trackable data from raw material sourcing to sales that offered consistently services to each customer.



GENERAL INDEX

Vehicle Index.....	page.I-VI
Applications.....	page.001-272
Cross References List And Photo.....	page.273-318
Basic Dimension Table-GSP to Dimension.....	page.319-327
New applications (compared with catalogue 2022).....	page.328-328

MAKE-MODEL	PAGE	MAKE-MODEL	PAGE	MAKE-MODEL	PAGE
ALFA ROMEO		BMW		BMW	
75	1	228i Cabrio	21	330d xDrive	43
SZ	1	228i Coupe	21	330d xDrive Coupe	43
AUDI		228i xDrive Gran Coupe	21	330d xDrive Gran Turismo	44
A3 Cabrio Quattro	1	230i Cabrio	21	330d xDrive Touring	44
A3 Quattro	1	230i Coupe	21	330e	44
A3 Sportback Quattro	2	3 ActiveHybrid	21	330i	44
A3/S3 Limousine quattro	2	316d	21	330i Cabrio	44
A4 Allroad Quattro	3	316d Touring	21	330i Coupe	44
A4 Quattro	3	316i	21	330i Gran Turismo	45
A6 Allroad Quattro	3	316i Compact	22	330i Touring	45
A6 Quattro	3	316i Coupe	22	330i xDrive	45
A7 Sportback Quattro	4	316i Touring	23	330i xDrive Coupe	45
Q2 Quattro	4	318d	23	330i xDrive Gran Turismo	46
Q3	5	318d Compact	24	330i xDrive Touring	46
Q3 Quattro	5	318d Gran Turismo	24	335d	46
Q5	6	318d Touring	24	335d Coupe	46
Q5 Quattro	6	318d xDrive	25	335d Touring	46
Q7 Quattro	7	318d xDrive Touring	25	335d xDrive	46
RS4 Quattro	7	318i	25	335d xDrive Gran Turismo	46
RSQ3 Quattro	7	318i Cabrio	26	335d xDrive Touring	46
S1 Quattro	7	318i Compact	26	335i	46
S1 Sportback Quattro	7	318i Coupe	26	335i Cabrio	46
S3 Cabrio Quattro	7	318i Touring	27	335i Coupe	47
S3 Quattro	8	320d	27	335i Gran Turismo	47
S3 Sportback Quattro	8	320d Cabrio	28	335i Touring	47
S4 Quattro	9	320d Compact	29	335i xDrive	47
S6 Quattro	9	320d Coupe	29	335i xDrive Coupe	47
S7 Sportback Quattro	9	320d Gran Turismo	29	335i xDrive Gran Turismo	47
SQ5 Quattro	9	320d Touring	30	335i xDrive Touring	48
TT Quattro	9	320d xDrive	30	340i	48
TTS Quattro	10	320d xDrive Coupe	31	340i Gran Turismo	48
AUDI (FAW)		320d xDrive Gran Turismo	31	340i Touring	48
A6L Quattro	10	320d xDrive Touring	31	340i xDrive	48
BMW		320i	32	340i xDrive Gran Turismo	48
114d	10	320i Cabrio	33	340i xDrive Touring	48
114i	10	320i Coupe	33	418d Coupe	48
116d	10	320i Gran Turismo	34	418d Gran Coupe	48
116i	11	320i Touring	34	418i Coupe	48
118d	12	320i xDrive	35	418i Gran Coupe	49
118d Cabrio	13	320i xDrive Gran Turismo	35	420d Cabrio	49
118d Coupe	13	320i xDrive Touring	35	420d Coupe	49
118d xDrive	13	323i	35	420d Gran Coupe	49
118i	13	323i Cabrio	36	420d xDrive Coupe	50
118i Cabrio	14	323i Compact	36	420d xDrive Gran Coupe	50
120d	14	323i Coupe	36	420i Cabrio	50
120d Cabrio	15	323i Touring	36	420i Coupe	50
120d Coupe	16	324d Touring	36	420i Gran Coupe	51
120d xDrive	16	325d	36	420i xDrive Coupe	51
120i	16	325d Cabrio	37	420i xDrive Gran Coupe	51
120i Cabrio	17	325d Coupe	37	425d Cabrio	51
120i Coupe	17	325d Gran Turismo	37	425d Gran Coupe	52
123d	17	325d Touring	37	428i Cabrio	52
123d Cabrio	18	325i	38	428i Coupe	52
123d Coupe	18	325i Cabrio	38	428i Gran Coupe	52
125d	18	325i Compact	39	428i xDrive Cabrio	52
125i	18	325i Coupe	39	428i xDrive Coupe	52
125i Cabrio	18	325i Touring	39	428i xDrive Gran Coupe	52
125i Coupe	18	325i xDrive	40	430d Cabrio	52
128i Cabrio	18	325i xDrive Coupe	40	430d Coupe	52
130i	19	325i xDrive Touring	40	430d Gran Coupe	52
135i Cabrio	19	328i	40	430d xDrive Coupe	52
135i Coupe	19	328i Cabrio	41	430d xDrive Gran Coupe	53
218d Cabrio	19	328i Coupe	41	430i Cabrio	53
218d Coupe	19	328i Gran Turismo	41	430i Coupe	53
218i Cabrio	19	328i Touring	41	430i Gran Coupe	53
218i Coupe	19	328i xDrive	41	430i xDrive Cabrio	53
220d Cabrio	20	328i xDrive Coupe	41	430i xDrive Coupe	53
220d Coupe	20	328i xDrive Gran Turismo	41	430i xDrive Gran Coupe	53
220d xDrive Coupe	20	328i xDrive Touring	41	435d xDrive Cabrio	53
220d xDrive Grand Coupe	20	330d	41	435d xDrive Coupe	53
220i Cabrio	20	330d Cabrio	42	435d xDrive Gran Coupe	53
220i Coupe	20	330d Coupe	42	435i Cabrio	53
225d Cabrio	21	330d Gran Turismo	43	435i Coupe	53
225d Coupe	21	330d Touring	43	435i Gran Coupe	53



MAKE-MODEL	PAGE	MAKE-MODEL	PAGE	MAKE-MODEL	PAGE
BMW		BMW		BMW	
435i xDrive Cabrio	54	630d Gran Turismo	67	M760i xDrive	74
435i xDrive Coupe	54	630d xDrive Gran Turismo	68	M850i xDrive Cabrio	74
435i xDrive Gran Coupe	54	630i Cabrio	68	M850i xDrive Coupe	74
440i Cabrio	54	630i Coupe	68	M850i xDrive Gran Coupe	74
440i Coupe	54	630i Gran Turismo	68	X1 sDrive 16d	74
440i Gran Coupe	54	635d Cabrio	68	X1 sDrive 16i	74
440i xDrive Cabrio	54	635d Coupe	68	X1 sDrive 18d	74
440i xDrive Coupe	54	640d Cabrio	68	X1 sDrive 18i	75
440i xDrive Gran Coupe	54	640d Coupe	68	X1 sDrive 20d	75
5 ActiveHybrid	54	640d Gran Coupe	68	X1 sDrive 20i	75
518d	54	640d xDrive Cabrio	68	X1 xDrive 18d	75
518d Touring	55	640d xDrive Coupe	68	X1 xDrive 20d	75
518i	55	640d xDrive Gran Coupe	68	X1 xDrive 20i	76
518i Touring	55	640d xDrive Gran Turismo	68	X1 xDrive 23d	76
520d	55	640i Cabrio	68	X1 xDrive 25d	76
520d Gran Turismo	56	640i Coupe	68	X1 xDrive 25e	76
520d Touring	56	640i Gran Coupe	69	X1 xDrive 25i	76
520d xDrive	56	640i Gran Turismo	69	X1 xDrive 28i	76
520d xDrive Touring	56	640i xDrive Cabrio	69	X2 xDrive 18d	76
520i	57	640i xDrive Coupe	69	X2 xDrive 20d	76
520i Touring	58	640i xDrive Gran Coupe	69	X2 xDrive 20i	76
523i	58	640i xDrive Gran Turismo	69	X2 xDrive 25d	76
523i Touring	59	645i Cabrio	69	X3	76
525d	59	645i Coupe	69	X3 M	77
525d Touring	60	650i Cabrio	69	X3 sDrive 18d	77
525d xDrive	60	650i Coupe	69	X3 sDrive 20i	77
525d xDrive Touring	60	650i Gran Coupe	69	X3 xDrive 18d	77
525i	60	650i xDrive Cabrio	69	X3 xDrive 20d	77
525i Touring	61	650i xDrive Coupe	70	X3 xDrive 20i	78
525i xDrive	61	650i xDrive Gran Coupe	70	X3 xDrive 25d	78
525i xDrive Touring	61	7 ActiveHybrid	70	X3 xDrive 25i	78
528i	61	725d	70	X3 xDrive 28i	78
528i Gran Turismo	62	728i	70	X3 xDrive 30d	78
528i Touring	62	730d	70	X3 xDrive 30i	78
528i xDrive	62	730d xDrive	70	X3 xDrive 35d	78
528i xDrive Touring	62	730i	70	X3 xDrive 35i	78
530d	62	735i	71	X3 xDrive M40i	78
530d Gran Turismo	63	740d	71	X4 M	78
530d Touring	63	740d xDrive	71	X4 xDrive 20d	79
530d xDrive	63	740e	71	X4 xDrive 20i	79
530d xDrive Gran Turismo	63	740i	71	X4 xDrive 25d	79
530d xDrive Touring	63	740i xDrive	72	X4 xDrive 28i	79
530e	64	745d	72	X4 xDrive 30d	79
530i	64	745i	72	X4 xDrive 30i	79
530i Touring	64	750d xDrive	72	X4 xDrive 35d	79
530i xDrive	65	750i	72	X4 xDrive 35i	79
530i xDrive Touring	65	750i xDrive	72	X4 xDrive M40d	79
535d	65	760i	72	X4 xDrive M40i	79
535d Gran Turismo	65	840d xDrive Cabrio	73	X5	79
535d Touring	65	840d xDrive Coupe	73	X5 M	81
535d xDrive	65	840d xDrive Gran Coupe	73	X5 M50i xDrive	81
535d xDrive Gran Turismo	65	840i	73	X5 sDrive 25d	81
535d xDrive Touring	65	840i Gran Coupe	73	X5 sDrive 35i	81
535i	65	840i xDrive Gran Coupe	73	X5 xDrive 25d	81
535i Gran Turismo	66	M Coupe	73	X5 xDrive 30d	81
535i Touring	66	M135i	73	X5 xDrive 30i	82
535i xDrive	66	M135i xDrive	73	X5 xDrive 35d	82
535i xDrive Gran Turismo	66	M140i	73	X5 xDrive 35i	82
535i xDrive Touring	66	M140i xDrive	73	X5 xDrive 40d	82
540d xDrive	66	M235i Cabrio	73	X5 xDrive 40i	82
540d xDrive Touring	66	M235i Coupe	73	X5 xDrive 48i	82
540i	66	M235i xDrive Coupe	73	X5 xDrive 50i	82
540i Touring	66	M240i Cabrio	73	X5 xDrive M50d	82
540i xDrive	66	M240i Coupe	73	X6 ActiveHybrid	83
540i xDrive Touring	67	M240i xDrive Cabrio	73	X6 M	83
545i	67	M240i xDrive Coupe	73	X6 xDrive 30d	83
545i Touring	67	M340i xDrive	73	X6 xDrive 35d	83
550i	67	M340i xDrive Touring	74	X6 xDrive 35i	83
550i Gran Turismo	67	M5	74	X6 xDrive 40d	84
550i Touring	67	M5 Touring	74	X6 xDrive 40i	84
550i xDrive	67	M550d xDrive	74	X6 xDrive 50i	84
550i xDrive Gran Turismo	67	M550d xDrive Touring	74	X6 xDrive M50d	84
620d Gran Turismo	67	M550i xDrive	74	X6 xDrive M50i	84
620d xDrive Gran Turismo	67	M6 Gran Coupe	74	X7 xDrive 30d	84



MAKE-MODEL	PAGE	MAKE-MODEL	PAGE	MAKE-MODEL	PAGE
BMW		FORD		ISUZU	
X7 xDrive 40i	84	Scorpio	92	Ascender	113
X7 xDrive 50i	84	Transit	92	Rodeo	113
X7 xDrive M50d	84	Transit 100	92	IVECO	
X7 xDrive M50i	84	Transit 120	93	Daily 29L15	113
Z3 Cabrio	84	Transit 150	94	Daily 29L15P	113
Z3 Coupe	85	Transit 190	94	Daily 35C11	113
Z4 Cabrio	85	Transit 230	95	Daily 35C11P	113
Z4 Coupe	85	Transit 260	95	Daily 35C13	113
Z4 M40i Cabrio	86	Transit 280	95	Daily 35C13P	113
Z4 sDrive 18i Cabrio	86	Transit 300	96	Daily 35C15	113
Z4 sDrive 20i Cabrio	86	Transit 310	97	Daily 35C15P	113
Z4 sDrive 23i Cabrio	86	Transit 330	98	Daily 35C9	113
Z4 sDrive 28i Cabrio	86	Transit 350	100	Daily 35C9P	113
Z4 sDrive 30i Cabrio	86	Transit 370	104	Daily 35S11	113
Z4 sDrive 35i Cabrio	86	Transit 410	104	Daily 35S11P	113
Z4 sDrive 35is Cabrio	86	Transit 430	104	Daily 35S13	114
Z8 Cabrio	86	Transit 460	105	Daily 35S13P	114
BMW (BRILLIANCE)		Transit 470	106	Daily 35S15	114
330Li xDrive	86	Transit 80	106	Daily 35S15P	114
335Li	86	Transit Tourneo	107	Daily 35S9	114
520Li	86	FORD USA		Daily 35S9P	114
523Li	86	Edge	107	Daily 40C15	114
528Li	86	Escape	107	Daily 40C15P	114
528Li xDrive	86	Expedition	107	Daily 45C15	114
530Le	86	Explorer	107	Daily 45C15P	114
530Li	86	Explorer Sport Trac	107	Daily 50C11	114
535Li	86	F-150 Extended Cab	107	Daily 50C11P	114
BUICK		F-150 Standard Cab	108	Daily 50C13	114
Rainier	86	F150	108	Daily 50C13P	114
CADILLAC		Mustang	108	Daily 50C15	114
SRX	86	Ranger	108	Daily 50C15P	114
CHEVROLET		Ranger Extended Cab	108	Daily 60C13	114
Astro	87	Ranger Standard Cab	108	Daily 60C15	114
Astro Extended Cargo	87	GMC		Daily 60C15P	115
Blazer	87	Envoy	108	Daily 65C13	115
Captiva	87	Jimmy	108	Daily 65C15	115
Captiva Sport	87	Safar Extended Cargo Van	108	Daily 65C15P	115
Equinox	87	Safar Extended Passenger Van	108	Daily 65C17	115
S10	87	Safar Standard Cargo Van	108	Daily 65C17P	115
Trailblazer	87	Safar Standard Passenger Van	108	Daily 65C18	115
CHRYSLER		Safari	108	Daily 65C18P	115
300C	88	Sonoma	108	Daily 70C15	115
CUPRA		HONDA		Daily 70C15P	115
Ateca	88	Civic	109	Daily 70C17	115
Formentor	88	CR-V	109	Daily 70C17P	115
Leon Sportstourer	88	CR-V IV	109	Eurocargo	115
DACIA		Elysion	109	JEEP	
Duster	88	HR-V	109	Cherokee	115
DAF		Integra	109	Cherokee Classic	115
65	88	HUMMER		Commander	115
65 CF	88	H3	109	Compass	116
75 CF	88	HYUNDAI		Grand Cherokee	116
85 CF	89	Grand Starex	109	Patriot	117
CF 65	89	H1	109	Wrangler	117
CF 75	89	iX35	109	KIA	
CF 85	89	iX55	110	Sorento	117
XF 95	89	Santa Fe	110	Sportage	117
DAIHATSU		Tucson	111	Sportage R	118
Hijet	90	Tucson iX35	112	KIA (DYK)	
Terios	90	Veracruz	112	Sportage	119
DODGE		HYUNDAI (BEIJING)		LANCIA	
Ram 1500	90	Tucson	112	Y10 (Ypsilon)	119
Ram 1500 Crew Cab	90	HYUNDAI (HUATAI)		LAND ROVER	
Ram 1500 Standard Cab	90	Santa Fe	112	Defender	119
FIAT		INFINITI		Defender 110	119
Panda	90	EX30d	112	Defender 130	119
Panda Classic	91	FX30d	112	Defender 90	120
Panda Van	91	FX35	112	Discovery	120
FORD		FX45	112	Discovery I	122
Fiesta	91	G	112	Discovery III	122
Galaxy	91	G37	113	Freelander	122
Granada	91	M37	113	Range Rover	122
Mondeo	91	Q45	113	Range Rover Evoque	124
Mondeo Estate/Wagon	92	QX4	113	Range Rover Sport	124



MAKE-MODEL	PAGE	MAKE-MODEL	PAGE	MAKE-MODEL	PAGE
LEXUS		MERCEDES-BENZ		MERCEDES-BENZ	
GS 250	126	420	139	CLS400	157
GS 300	126	500	139	CLS450	158
GS 300h	126	500GE	139	CLS500	158
GS 400	126	600	139	CLS53 AMG	158
GS 430	126	A160	139	CLS55 AMG	158
GS 450h	126	A180	139	CLS550	158
GS 460	126	A200	139	CLS63 AMG	158
GS F	126	A220	139	E180	159
IS 200	126	A250	139	E200	159
IS 200d	126	A45 AMG	140	E220	161
IS 220d	126	AMG GT 43	140	E230	163
IS 250	126	Atego	140	E240	163
IS 300	126	Atego 2	140	E250	164
IS 300h	126	Atego 3	140	E270	165
ISF	126	B160	140	E280	165
LS 400	126	B180	140	E290	166
LS 430	126	B200	140	E300	166
LS 460	126	B220	140	E320	168
LS 600h	127	B250	141	E350	169
NX 200t	127	C160	141	E36 AMG	172
RC 300h	127	C180	141	E400	172
RCF	127	C200	142	E420	173
RX 200t	127	C220	144	E43 AMG	173
RX 300	127	C230	146	E430	173
RX 330	127	C240	147	E450	173
RX 350	127	C250	148	E50 AMG	173
RX 400h	127	C270	148	E500	173
RX 450h	127	C280	148	E55	174
SC 430	127	C300	149	E55 AMG	174
LINCOLN		C32 AMG	150	E550	174
Navigator	127	C320	150	E60 AMG	174
MAN		C350	150	E63 AMG	174
F2000	127	C36 AMG	151	G270	175
F90	128	C400	151	G300	175
L2000	131	C43 AMG	151	G320	175
M2000 L	131	C450 AMG	151	G350	175
M2000 M	131	C55 AMG	152	G36 AMG	175
MAZDA		C63 AMG	152	G400	175
B1600	131	CL420	152	G500	175
B2000	131	CL500	152	G55 AMG	175
B2200	131	CL55 AMG	152	G63 AMG	175
B2500	131	CL600	152	G65 AMG	175
B2600	132	CL63 AMG	153	GL320	175
BT-50	132	CL65 AMG	153	GL350	175
BT50	132	CLA180	153	GL400	176
CX7	132	CLA200	153	GL420	176
CX9	132	CLA220	153	GL450	176
MX5	132	CLA250	153	GL500	176
MERCEDES-BENZ		CLC160	153	GL550	176
190	132	CLC180	153	GLC200	176
190E II	133	CLC200	154	GLC220	176
200	134	CLC220	154	GLC250	177
208D	134	CLC230	154	GLC260	177
210	134	CLC250	154	GLC300	177
210D	134	CLC350	154	GLC350	177
220	135	CLK200	154	GLC400	177
230	135	CLK220	155	GLC43 AMG	177
230GE	135	CLK230	155	GLC63 AMG	177
250	135	CLK240	155	GLE250	177
250GD	136	CLK270	155	GLE320	177
260	136	CLK280	155	GLE350	177
280	136	CLK320	155	GLE400	178
300	136	CLK350	155	GLE43 AMG	178
300GD	138	CLK430	156	GLE450 AMG	178
300GE	138	CLK500	156	GLE500	178
308D	138	CLK55 AMG	156	GLE53 AMG	178
310	138	CLK63 AMG	156	GLE580	178
310D	138	CLS220	156	GLK200	178
320	138	CLS250	156	GLK220	178
350	138	CLS260	156	GLK250	178
350GD	138	CLS280	156	GLK280	178
400	138	CLS300	156	GLK300	178
410	138	CLS320	157	GLK320	179
410D	139	CLS350	157	GLK350	179

MAKE-MODEL	PAGE	MAKE-MODEL	PAGE	MAKE-MODEL	PAGE
MERCEDES-BENZ		MERCEDES-BENZ		MITSUBISHI	
GLS350	179	Sprinter 213D	189	ASX	214
GLS400	179	Sprinter 214	189	Challenger	214
GLS450	179	Sprinter 214 NGT	189	Challenger/Pajero Sport/Montero Sport	214
GLS500	179	Sprinter 214D	189	Chariot	214
GLS580	179	Sprinter 215D	190	Chariot Grandis	214
ML230	179	Sprinter 216	190	Eclipse	214
ML250	179	Sprinter 216D	190	Expo LRV/RVR	214
ML270	179	Sprinter 218D	191	G-Wagon	214
ML280	179	Sprinter 219D	191	Galant	214
ML300	179	Sprinter 224	191	GTO	214
ML320	179	Sprinter 308D	191	I.O	214
ML350	180	Sprinter 309D	191	L200	214
ML400	180	Sprinter 310D	192	L200/Triton/Hunter	215
ML420	180	Sprinter 311D	192	L400	215
ML430	180	Sprinter 312D	194	Lancer	215
ML450	180	Sprinter 313D	194	Lancer Evolution	215
ML500	180	Sprinter 314	195	Montero	216
ML55 AMG	180	Sprinter 314 NGT	195	Montero I.O	216
ML550	180	Sprinter 314D	195	Montero Sport	216
ML63 AMG	180	Sprinter 315D	196	Outlander	216
R280	181	Sprinter 316	196	Pajero	216
R300	181	Sprinter 316 NGT	196	Pajero I.O	216
R320	181	Sprinter 316D	197	Pajero Mini	217
R350	181	Sprinter 318D	197	Pajero Pinin	217
R500	181	Sprinter 319D	198	Pajero Pinin/Pajero TR4	217
R63 AMG	181	Sprinter 324	198	Pajero Sport	217
S280	181	Sprinter 408D	199	Shogun	217
S300	181	Sprinter 410D	199	Shogun Pinin	217
S320	181	Sprinter 411D	199	Shogun Sport	217
S350	182	Sprinter 412D	199	Space Runner	217
S400	182	Sprinter 413D	200	Space Wagon	217
S400 Maybach	183	Sprinter 414	200	Strada	217
S420	183	Sprinter 414D	200	Strakar	217
S430	183	Sprinter 415D	200	Triton	217
S450	183	Sprinter 416D	201	NISSAN	
S500	183	Sprinter 418D	201	Camiones	217
S500 Maybach	184	Sprinter 419D	201	Datsun	217
S55 AMG	184	Sprinter 424	202	Dualis	217
S550	184	Sprinter 509D	202	Largo	217
S560	184	Sprinter 510D	202	Murano	217
S560 Maybach	185	Sprinter 511D	202	Navara	218
S600	185	Sprinter 513D	203	NP300	218
S63 AMG	185	Sprinter 514D	204	NP300 Navara	218
S65 AMG	185	Sprinter 515D	204	Pathfinder	218
SL280	185	Sprinter 516	204	Pick Up (D22)	218
SL300	185	Sprinter 516 NGT	204	Pick Up (King Cab)	218
SL320	185	Sprinter 516D	204	Pick Up/Datsun	219
SL350	185	Sprinter 518D	205	Primera	219
SL500	185	Sprinter 519D	205	Qashqai	219
SL55 AMG	186	Sprinter 524	206	Qashqai+2	219
SL60 AMG	186	Sprinter 616D	206	Serena	219
SL600	186	T-Model	206	Silvia	219
SL63 AMG	186	T-Model E350	206	Sunny	219
SL65 AMG	186	T-Model E400	206	Sunny Estate/Wagon	219
SL73 AMG	186	Viano	206	Terrano	219
SLC180	186	Vito 109	208	Terrano (Pick Up)	219
SLC200	186	Vito 110	209	Vanette Cargo	219
SLC250	186	Vito 111	209	X-Trail	220
SLC260	186	Vito 113	210	Xterra	220
SLC300	186	Vito 115	210	OLDSMOBILE	
SLC43 AMG	186	Vito 116	211	Bravada	220
SLK200	186	Vito 119	212	OPEL	
SLK230	187	Vito 120	212	Antara	220
SLK250	187	Vito 122	212	Omega	220
SLK280	187	Vito 123	213	PIAGGIO	
SLK300	187	Vito 126	213	Porter	221
SLK32 AMG	187	MERCURY		PONTIAC	
SLK320	187	Mountaineer	213	Solstice	221
SLK350	187	MINI		Torrent	221
Sprinter 208D	187	Mini Countryman	213	PORSCHE	
Sprinter 209D	188	Mini Paceman	213	Cayenne	221
Sprinter 210D	188	MITSUBISHI		Macan	222
Sprinter 211D	188	3000 GT	214	Panamera	223
Sprinter 212D	189	Airtrek	214		



MAKE-MODEL	PAGE	MAKE-MODEL	PAGE	MAKE-MODEL	PAGE
RAM		TOYOTA		TOYOTA	
1500	223	Aristo	233	Succeed	242
1500 Crew Cab	223	Avanza	233	Supra	242
1500 Extended Cab	223	bB	233	Tacoma	242
1500 Standard Cab	223	Caldina	233	Tercel	242
RENAULT		Celsior	233	Tundra	242
Duster	223	Chaser	233	Verossa	242
Kangoo	223	Coaster	233	Vitz	242
Kangoo Express	223	Corolla	233	Voxy	242
Kangoo Rapid	223	Corolla Altis	233	Will Cypha	242
Koleos	223	Corolla Axio	234	Will VS	242
Megane Scenic	224	Corolla Estate/Wagon	234	Wish	243
Scenic RX4	224	Corolla Fielder	234	TOYOTA (FAW)	
SATURN		Corolla II	234	Corolla	243
Sky	224	Corolla Levin	234	Land Cruiser	243
Vue	224	Corolla RunX	234	Land Cruiser 200	243
SEAT		Corolla Spacio	234	Land Cruiser Prado	243
Alhambra	224	Corona	234	VAUXHALL	
Altea Freetrack	224	Corsa	234	Omega	243
Altea XL	224	Crown	234	VOLVO	
Ateca	224	Crown Majesta	234	240	243
Leon	225	Dyna	234	240 Estate/Combi	243
Leon ST	225	Dyna 150	234	740	243
Tarraco	225	Dyna 200	234	740 Estate/Combi	244
SKODA		Dyna 300	234	760	244
Karoq	226	Dyna 400	234	940	244
Karoq Scout	226	Estima	234	940 Estate/Combi	244
Kodiaq	226	Estima Emina	235	960	244
Kodiaq Scout	226	Estima Lucida	235	960 Estate/Combi	245
Octavia	226	Fortuner	235	S60	245
Octavia Scout	227	Harrier	236	S70	245
Superb	228	Hiace	236	S80	245
Yeti	229	Highlander	236	S90	245
SSANGYONG		Highlander Hybrid	236	V60	245
Actyon	229	Hilux	236	V70	246
Actyon Sports	229	Hilux Surf	238	V70 XC	246
Chairman CM600S	229	Innova	239	V90	246
Korando	229	Innova/Kijanginnova/Zace	239	XC60	246
Korando Sports	229	Ipsum	239	XC70	246
Kyron	229	Isis	239	XC90	246
Musso	230	IST	239	VW	
Musso Grand	230	Kluger	239	Amarok	247
Rexton	230	Land Cruiser	239	Arteon	247
REXTON	230	Land Cruiser 100	239	Bora	247
Rexton	230	Land Cruiser 200	239	Bora Estate/Variant	247
Rexton II	230	Land Cruiser 400	239	Caddy	247
Rexton Sports	230	Land Cruiser 70	239	Caddy Maxi	248
Rexton Sports XL	230	Land Cruiser 80	239	California	248
Rexton W	230	Land Cruiser 90	240	Campmobile	248
Rodius	231	Land Cruiser Amazon	240	Caravelle	249
Stavic	231	Land Cruiser Cygnus	240	CC	250
Turismo	231	Land Cruiser Prado	240	Crafter 28	250
SUBARU		Land Cruiser V8	240	Crafter 30	250
Forester	231	Land Cruiser V8 Van	240	Crafter 32	252
Impreza	231	Mark II	240	Crafter 35	252
Impreza WRX	231	Matrix	240	Crafter 46	254
Legacy	231	Opa	240	Crafter 50	255
Legacy Estate/Wagon	231	Platz	240	Golf	255
Outback	231	Porte	240	Golf Alltrack	257
XV	232	Prado	240	Golf Estate/Variant	257
SUZUKI		Premio	240	Golf Van (Hatchback)	258
Equator	232	Previa	240	Golf Van (Variant)	258
Grand Escudo	232	Previa (Nato)	240	LT 28	258
Grand Vitara	232	Probox	240	LT 32	260
Grand Vitara II	232	Raum	240	LT 35	260
Grand Vitara II/Grand Escudo	232	RAV 4	241	LT 46	261
SX4	232	RAV 4L	241	Multivan	262
SX4 S-Cross	232	Royal	241	New Beetle	263
TOYOTA		Rush	241	Passat	263
4 Runner	232	Sienna	241	Passat Alltrack	264
Allex	232	Soarer	242	Passat CC	264
Allion	232	Sprinter	242	Passat Estate/Variant	265
Alphard	233	Sprinter Carib	242	Sharan	265
Altezza	233	Sprinter Cielo	242	T-Roc	265
Altezza Gita	233	Starlet	242	Teramont	265



	 YEAR	TRANSM.	FITTING POSITION	BODY STYLE & DRIVE TYPE & ENGINE	REMARKS	 PRODUCT	GSP Ref.
ALFA ROMEO							
75							
1.6 (81 kw)	1985.05-1992.02		-	Saloon RWD AR06100/AR61101	Transmission End	Joint,propshaft	602001
1.8 (88 kw)	1988.09-1992.02		-	Saloon RWD AR06168/AR06202	Transmission End	Joint,propshaft	602001
1.8 (90 kw)	1989.08-1992.12		-	Saloon RWD AR61201	Transmission End	Joint,propshaft	602001
1.8 (95 kw)	1989.05-1992.02		-	Saloon RWD AR67101	Transmission End	Joint,propshaft	602001
2.0 (70 kw)	1985.05-1992.09		-	Saloon RWD VM80A	Transmission End	Joint,propshaft	602001
2.0 (107 kw)	1987.04-1992.02		-	Saloon RWD AR06166	Transmission End	Joint,propshaft	602001
2.0 (109 kw)	1985.05-1992.02		-	Saloon RWD AR06224	Transmission End	Joint,propshaft	602001
SZ							
3.0 (152 kw)	1988.09-1994.08		Centre	Coupe RWD AR61501		Center Bearing Support	514783
AUDI							
A3 Cabrio Quattro							
1.8 (132 kw)	2014.03-2016.07		Front	Cabriolet 4WD CJSB		Flexible Coupling	537626
	2014.03-2016.07		Rear	Cabriolet 4WD CJSB		Flexible Coupling	533882
	2014.03-2016.07		Front	Cabriolet 4WD CJSB		Flexible Coupling Kit	537626S
	2014.03-2016.07		Rear	Cabriolet 4WD CJSB		Flexible Coupling Kit	533882S
2.0 (110 kw)	2014.03-2020.10		Front	Cabriolet 4WD CRLB/DCYA		Flexible Coupling	537626
	2014.03-2020.10		Rear	Cabriolet 4WD CRLB/DCYA		Flexible Coupling	533882
	2014.03-2020.10		Front	Cabriolet 4WD CRLB/DCYA		Flexible Coupling Kit	537626S
	2014.03-2020.10		Rear	Cabriolet 4WD CRLB/DCYA		Flexible Coupling Kit	533882S
2.0 (135 kw)	2014.05-2020.10		Front	Cabriolet 4WD CUNA/DGCA		Flexible Coupling	537626
	2014.05-2020.10		Rear	Cabriolet 4WD CUNA/DGCA		Flexible Coupling	533882
	2014.05-2020.10		Front	Cabriolet 4WD CUNA/DGCA		Flexible Coupling Kit	537626S
	2014.05-2020.10		Rear	Cabriolet 4WD CUNA/DGCA		Flexible Coupling Kit	533882S
2.0 (140 kw)	2016.05-2020.10		Front	Cabriolet 4WD CZPB/DKZA		Flexible Coupling	537626
	2016.05-2020.10		Rear	Cabriolet 4WD CZPB/DKZA		Flexible Coupling	533882
	2016.05-2020.10		Front	Cabriolet 4WD CZPB/DKZA		Flexible Coupling Kit	537626S
	2016.05-2020.10		Rear	Cabriolet 4WD CZPB/DKZA		Flexible Coupling Kit	533882S
2.0 (162 kw)	2016.08-2020.10		Front	Cabriolet 4WD CNTC		Flexible Coupling	537626
	2016.08-2020.10		Rear	Cabriolet 4WD CNTC		Flexible Coupling	533882
	2016.08-2020.10		Front	Cabriolet 4WD CNTC		Flexible Coupling Kit	537626S
	2016.08-2020.10		Rear	Cabriolet 4WD CNTC		Flexible Coupling Kit	533882S
A3 Quattro							
1.6 (81 kw)	2015.05-2016.08		Front	Saloon 4WD CXXB		Flexible Coupling	537626
	2015.05-2016.08		Rear	Saloon 4WD CXXB		Flexible Coupling	533882
	2015.05-2016.08		Front	Saloon 4WD CXXB		Flexible Coupling Kit	537626S
	2015.05-2016.08		Rear	Saloon 4WD CXXB		Flexible Coupling Kit	533882S
1.8 (110 kw)	1997.08-2003.06		Front	Hatchback 4WD AGU/AQA/ARX		Flexible Coupling	537626
	1997.08-2003.06		Front	Hatchback 4WD AGU/AQA/ARX		Flexible Coupling Kit	537626S
1.8 (132 kw)	1998.11-2003.06		Front	Hatchback 4WD AJQ/ARY		Flexible Coupling	537626
	1998.11-2003.06		Front	Hatchback 4WD AJQ/ARY		Flexible Coupling Kit	537626S
	2012.08-2016.08		Centre	Hatchback 4WD CJSB		Center Bearing Support	514808
	2012.08-2016.08		Front	Hatchback 4WD CJSB		Flexible Coupling	537626
	2012.08-2016.08		Rear	Hatchback 4WD CJSB		Flexible Coupling	533882
	2012.08-2016.08		Front	Hatchback 4WD CJSB		Flexible Coupling Kit	537626S
	2012.08-2016.08		Rear	Hatchback 4WD CJSB		Flexible Coupling Kit	533882S
	2013.09-2016.08		Front	Saloon 4WD CJSB		Flexible Coupling	537626
	2013.09-2016.08		Rear	Saloon 4WD CJSB		Flexible Coupling	533882
	2013.09-2016.08		Front	Saloon 4WD CJSB		Flexible Coupling Kit	537626S
1.9 (96 kw)	2000.05-2003.06		Front	Hatchback 4WD ASZ		Flexible Coupling	537626
	2000.05-2003.06		Front	Hatchback 4WD ASZ		Flexible Coupling Kit	537626S
2.0 (100 kw)	2003.06-2008.06		Front	Hatchback 4WD AZV		Flexible Coupling	537626
	2003.06-2008.06		Rear	Hatchback 4WD AZV		Flexible Coupling	533882
2.0 (103 kw)	2004.08-2012.08		Front	Hatchback 4WD BKD/CBAB/CFFB		Flexible Coupling	537626
	2004.08-2012.08		Rear	Hatchback 4WD BKD/CBAB/CFFB		Flexible Coupling	533882
	2006.01-2007.05		Rear	Hatchback 4WD BMM		Flexible Coupling	533882
2.0 (110 kw)	2012.10-2017.12		Centre	Hatchback 4WD CRBC/CRLB/DCYA		Center Bearing Support	514808
	2012.10-2017.12		Front	Hatchback 4WD CRBC/CRLB/DCYA		Flexible Coupling	537626
	2012.10-2017.12		Rear	Hatchback 4WD CRBC/CRLB/DCYA		Flexible Coupling	533882
	2012.10-2017.12		Front	Hatchback 4WD CRBC/CRLB/DCYA		Flexible Coupling Kit	537626S
	2012.10-2017.12		Rear	Hatchback 4WD CRBC/CRLB/DCYA		Flexible Coupling Kit	533882S
	2013.10-2020.10		Front	Saloon 4WD CRBC/CRLB/DCYA		Flexible Coupling	537626
	2013.10-2020.10		Rear	Saloon 4WD CRBC/CRLB/DCYA		Flexible Coupling	533882
	2013.10-2020.10		Front	Saloon 4WD CRBC/CRLB/DCYA		Flexible Coupling Kit	537626S



	 YEAR	TRANSM.	FITTING POSITION	BODY STYLE & DRIVE TYPE & ENGINE	REMARKS	 PRODUCT	GSP Ref.
AUDI A3 Quattro							
2.0 (110 kw)	2013.10-2020.10		Rear	Saloon 4WD CRBC/CRLB/DCYA		Flexible Coupling Kit	533882S
2.0 (125 kw)	2006.02-2012.08		Front	Hatchback 4WD BMN/CBBB/CFGB		Flexible Coupling	537626
	2006.02-2012.08		Rear	Hatchback 4WD BMN/CBBB/CFGB		Flexible Coupling	533882
2.0 (135 kw)	2013.05-2017.12		Centre	Hatchback 4WD CUNA/DGCA		Center Bearing Support	514808
	2013.05-2017.12		Front	Hatchback 4WD CUNA/DGCA		Flexible Coupling	537626
	2013.05-2017.12		Rear	Hatchback 4WD CUNA/DGCA		Flexible Coupling	533882
	2013.05-2017.12		Front	Hatchback 4WD CUNA/DGCA		Flexible Coupling Kit	537626S
	2013.05-2017.12		Rear	Hatchback 4WD CUNA/DGCA		Flexible Coupling Kit	533882S
	2014.05-2019.07		Front	Saloon 4WD CUNA/DGCA/DJGA		Flexible Coupling	537626
	2014.05-2019.07		Rear	Saloon 4WD CUNA/DGCA/DJGA		Flexible Coupling	533882
	2014.05-2019.07		Front	Saloon 4WD CUNA/DGCA/DJGA		Flexible Coupling Kit	537626S
	2014.05-2019.07		Rear	Saloon 4WD CUNA/DGCA/DJGA		Flexible Coupling Kit	533882S
2.0 (140 kw)	2016.05-2017.12		Front	Hatchback 4WD CZPB		Flexible Coupling	537626
	2016.05-2017.12		Rear	Hatchback 4WD CZPB		Flexible Coupling	533882
	2016.05-2017.12		Front	Hatchback 4WD CZPB		Flexible Coupling Kit	537626S
	2016.05-2017.12		Rear	Hatchback 4WD CZPB		Flexible Coupling Kit	533882S
	2016.05-2020.10		Front	Saloon 4WD CZPB/DKZA		Flexible Coupling	537626
	2016.05-2020.10		Rear	Saloon 4WD CZPB/DKZA		Flexible Coupling	533882
	2016.05-2020.10		Front	Saloon 4WD CZPB/DKZA		Flexible Coupling Kit	537626S
	2016.05-2020.10		Rear	Saloon 4WD CZPB/DKZA		Flexible Coupling Kit	533882S
2.0 (147 kw)	2004.09-2012.08		Front	Hatchback 4WD AXB/BWA/CCZA		Flexible Coupling	537626
	2004.09-2012.08		Rear	Hatchback 4WD AXB/BWA/CCZA		Flexible Coupling	533882
3.2 (184 kw)	2003.07-2009.05		-	Hatchback 4WD BDB/BMJ/BUB		Propshaft	PS900102
	2003.07-2009.05		Front	Hatchback 4WD BDB/BMJ/BUB		Flexible Coupling	537626
	2003.07-2009.05		Rear	Hatchback 4WD BDB/BMJ/BUB		Flexible Coupling	533882
A3 Sportback Quattro							
1.6 (81 kw)	2015.05-2016.08		Front	Hatchback 4WD CXXB		Flexible Coupling	537626
	2015.05-2016.08		Rear	Hatchback 4WD CXXB		Flexible Coupling	533882
	2015.05-2016.08		Front	Hatchback 4WD CXXB		Flexible Coupling Kit	537626S
	2015.05-2016.08		Rear	Hatchback 4WD CXXB		Flexible Coupling Kit	533882S
	2015.05-2016.08		Rear	Hatchback 4WD CXXB		Flexible Coupling Kit	533882S
1.8 (132 kw)	2013.05-2016.08		Front	Hatchback 4WD CJSB		Flexible Coupling	537626
	2013.05-2016.08		Rear	Hatchback 4WD CJSB		Flexible Coupling	533882
	2013.05-2016.08		Front	Hatchback 4WD CJSB		Flexible Coupling Kit	537626S
	2013.05-2016.08		Rear	Hatchback 4WD CJSB		Flexible Coupling Kit	533882S
2.0 (103 kw)	2005.11-2013.03		Front	Hatchback 4WD BKD/CBAB/CFFB		Flexible Coupling	537626
	2005.11-2013.03		Rear	Hatchback 4WD BKD/CBAB/CFFB		Flexible Coupling	533882
	2007.06-2008.06		Front	Hatchback 4WD BMM		Flexible Coupling	537626
	2007.06-2008.06		Rear	Hatchback 4WD BMM		Flexible Coupling	533882
2.0 (110 kw)	2013.02-2020.10		Front	Hatchback 4WD CRBC/CRLB/DCYA		Flexible Coupling	537626
	2013.02-2020.10		Rear	Hatchback 4WD CRBC/CRLB/DCYA		Flexible Coupling	533882
	2013.02-2020.10		Front	Hatchback 4WD CRBC/CRLB/DCYA		Flexible Coupling Kit	537626S
	2013.02-2020.10		Rear	Hatchback 4WD CRBC/CRLB/DCYA		Flexible Coupling Kit	533882S
2.0 (125 kw)	2006.02-2013.03		Front	Hatchback 4WD BMN/CBBB/CFGB		Flexible Coupling	537626
	2006.02-2013.03		Rear	Hatchback 4WD BMN/CBBB/CFGB		Flexible Coupling	533882
2.0 (135 kw)	2013.05-2020.10		Rear	Hatchback 4WD CUNA/DGCA/DJGA		Propshaft	PS900585
	2013.05-2020.10		Front	Hatchback 4WD CUNA/DGCA/DJGA		Flexible Coupling	537626
	2013.05-2020.10		Rear	Hatchback 4WD CUNA/DGCA/DJGA		Flexible Coupling	533882
	2013.05-2020.10		Front	Hatchback 4WD CUNA/DGCA/DJGA		Flexible Coupling Kit	537626S
	2013.05-2020.10		Rear	Hatchback 4WD CUNA/DGCA/DJGA		Flexible Coupling Kit	533882S
2.0 (140 kw)	2016.05-2020.10		Front	Hatchback 4WD CZPB/DKZA		Flexible Coupling	537626
	2016.05-2020.10		Rear	Hatchback 4WD CZPB/DKZA		Flexible Coupling	533882
	2016.05-2020.10		Front	Hatchback 4WD CZPB/DKZA		Flexible Coupling Kit	537626S
	2016.05-2020.10		Rear	Hatchback 4WD CZPB/DKZA		Flexible Coupling Kit	533882S
2.0 (147 kw)	2004.06-2013.03		Front	Hatchback 4WD AXB/BPY/BWA/CCZA		Flexible Coupling	537626
	2004.06-2013.03		Rear	Hatchback 4WD AXB/BPY/BWA/CCZA		Flexible Coupling	533882
3.2 (184 kw)	2003.07-2009.05		Front	Hatchback 4WD BDB/BMJ/BUB		Flexible Coupling	537626
	2003.07-2009.05		Rear	Hatchback 4WD BDB/BMJ/BUB		Flexible Coupling	533882
A3/S3 Limousine quattro							
2.0 (162 kw)	2013.11-		Front	Saloon AWD CNTC		Flexible Coupling	537626
	2013.11-		Rear	Saloon AWD CNTC		Flexible Coupling	533882
	2013.11-		Front	Saloon AWD CNTC		Flexible Coupling Kit	537626S
	2013.11-		Rear	Saloon AWD CNTC		Flexible Coupling Kit	533882S



	 YEAR	TRANSM.	FITTING POSITION	BODY STYLE & DRIVE TYPE & ENGINE	REMARKS	 PRODUCT	GSP Ref.
AUDI							
A4 Allroad Quattro							
2.0 (105 kw)	2009.09-2016.05	7AT	-	Estate 4WD CAGA/CJCA	Date From:2010.06	Propshaft	PS900103
2.0 (120 kw)	2009.04-2016.05	7AT	-	Estate 4WD CAHB/CGLD/CNHC	Date From:2010.06	Propshaft	PS900103
2.0 (130 kw)	2011.11-2016.05	7AT	-	Estate 4WD CGLC		Propshaft	PS900103
2.0 (140 kw)	2013.09-2016.05	7AT	-	Estate 4WD CNHA		Propshaft	PS900103
2.0 (155 kw)	2009.04-2016.05	7AT	-	Estate 4WD CDNC/CPMA	Date From:2010.06	Propshaft	PS900103
2.0 (165 kw)	2013.05-2016.05	7AT	-	Estate 4WD CNCD		Propshaft	PS900103
3.0 (176 kw)	2009.04-2012.01	7AT	-	Estate 4WD CCWA	Date From:2010.06	Propshaft	PS900103
3.0 (180 kw)	2012.01-2016.05	7AT	-	Estate 4WD CDUC/CKVB/CKVC		Propshaft	PS900103
A4 Quattro							
2.0 (130 kw)	2011.11-2015.12	7AT	-	Estate 4WD CGLC		Propshaft	PS900103
	2011.11-2015.12	7AT	-	Saloon 4WD CGLC		Propshaft	PS900103
2.0 (140 kw)	2013.09-2015.12	7AT	-	Estate 4WD CNHA		Propshaft	PS900103
	2013.09-2015.12	7AT	-	Saloon 4WD CNHA		Propshaft	PS900103
2.0 (155 kw)	2008.06-2015.12	7AT	-	Estate 4WD CDNC	Date From:2010.06	Propshaft	PS900103
	2008.06-2015.12	7AT	-	Saloon 4WD CAEB/CDNC/CPMA	Date From:2010.06	Propshaft	PS900103
2.0 (165 kw)	2013.05-2015.12	7AT	-	Saloon 4WD CNCD		Propshaft	PS900103
	2013.05-2015.12	7AT	-	Estate 4WD CNCD		Propshaft	PS900103
3.0 (155 kw)	2008.06-2010.05	7AT	-	Saloon 4WD CCWB		Propshaft	PS900103
3.0 (176 kw)	2007.11-2012.03	7AT	-	Saloon 4WD CAPA/CCLA/CCWA	Date From:2010.06	Propshaft	PS900103
	2008.04-2012.03	7AT	-	Estate 4WD CAPA/CCLA/CCWA	Date From:2010.06	Propshaft	PS900103
3.0 (180 kw)	2011.11-2015.12	7AT	-	Estate 4WD CDUC/CKVB/CKVC		Propshaft	PS900103
	2011.11-2015.12	7AT	-	Saloon 4WD CDUC/CKVB/CKVC		Propshaft	PS900103
3.0 (200 kw)	2012.02-2015.12	7AT	-	Estate 4WD CMUA/CREC		Propshaft	PS900103
	2012.02-2015.12	7AT	-	Saloon 4WD CMUA/CREC		Propshaft	PS900103
A6 Allroad Quattro							
2.7 (120 kw)	2006.05-2011.08	6AT	Rear	Estate 4WD BSG/CAND		Propshaft	PS900105
2.7 (132 kw)	2006.03-2008.10		Rear	Estate 4WD BPP		Propshaft	PS900105
2.7 (140 kw)	2008.10-2011.08	6AT	Rear	Estate 4WD CANC		Propshaft	PS900105
3.0 (140 kw)	2015.11-2018.09	7AT	Rear	Estate 4WD CZVF		Propshaft	PS900581
3.0 (150 kw)	2012.01-2014.12	7AT	Rear	Estate 4WD CLAA	for PR code:G1D	Propshaft	PS900581
3.0 (155 kw)	2006.05-2011.08	AT	Rear	Estate 4WD BNG/CDYB		Propshaft	PS900105
	2014.09-2018.09	7AT	Rear	Estate 4WD CRTF/CZVC	for PR code:G1D	Propshaft	PS900581
3.0 (160 kw)	2014.09-2018.09	7AT	Rear	Estate 4WD CRTE/CZVA	for PR code:G1D	Propshaft	PS900581
3.0 (176 kw)	2008.10-2011.08	6AT	Rear	Estate 4WD CDYA/CDYC		Propshaft	PS900105
3.0 (180 kw)	2012.01-2016.06	7AT	Rear	Estate 4WD CDUD/CKVC	for PR code:G1D	Propshaft	PS900581
3.0 (200 kw)	2014.09-2018.09	7AT	Rear	Estate 4WD CRTD	for PR code:G1D	Propshaft	PS900581
3.0 (213 kw)	2008.10-2011.08	6AT	Rear	Estate 4WD CAJA		Propshaft	PS900105
3.0 (228 kw)	2012.01-2014.12	7AT	Rear	Estate 4WD CGWD	for PR code:G1D	Propshaft	PS900581
3.0 (245 kw)	2014.09-2018.09	7AT	Rear	Estate 4WD CREC	for PR code:G1D	Propshaft	PS900581
3.2 (188 kw)	2006.05-2008.10	6AT/6MT	Rear	Estate 4WD AUK	For PR code:G0L/G03	Propshaft	PS900105
4.2 (257 kw)	2006.05-2010.12	6AT	Rear	Estate 4WD BVJ		Propshaft	PS900105
A6 Quattro							
2.0 (140 kw)	2015.04-2018.09	7AT	Rear	Estate 4WD CNHA/DDDA	for PR code:G1D	Propshaft	PS900581
	2015.04-2018.09	7AT	Rear	Saloon 4WD CNHA/DDDA	for PR code:G1D	Propshaft	PS900581
2.0 (183 kw)	2015.05-2018.09	7AT	Rear	Saloon 4WD CYPB	for PR code:G1D	Propshaft	PS900581
	2015.05-2018.09	7AT	Rear	Estate 4WD CYPB	for PR code:G1D	Propshaft	PS900581
2.0 (185 kw)	2014.11-2018.09	7AT	Rear	Saloon 4WD CYNB/CYPA	Date From:2014.11,for PR code:G1D	Propshaft	PS900581
	2015.05-2018.09	7AT	Rear	Estate 4WD CYPA	for PR code:G1D	Propshaft	PS900581
2.4 (130 kw)	2005.01-2008.10	6AT/6MT	Rear	Saloon 4WD BDW		Propshaft	PS900105
	2005.03-2008.09	6AT/6MT	Rear	Estate 4WD BDW		Propshaft	PS900105
2.7 (120 kw)	2005.06-2011.03	6AT	Rear	Saloon 4WD BSG/CAND		Propshaft	PS900105
	2005.06-2011.08	6AT	Rear	Estate 4WD BSG/CAND		Propshaft	PS900105
2.7 (132 kw)	2004.11-2008.10	6AT	Rear	Estate 4WD BPP		Propshaft	PS900105
	2005.06-2008.10	6AT	Rear	Saloon 4WD BPP	Date From:2005.06	Propshaft	PS900105
2.7 (140 kw)	2008.10-2011.03	6AT	Rear	Saloon 4WD CANC		Propshaft	PS900105
	2008.10-2011.08	6AT	Rear	Estate 4WD CANC		Propshaft	PS900105
2.7 (169 kw)	1999.02-2001.05	5MT	Rear	Saloon 4WD AJK/AZA	Chassis no. to:4B-Y-100 000	Propshaft	PS900104
2.8 (140 kw)	2008.10-2011.03	6MT	Rear	Saloon 4WD CCDA		Propshaft	PS900105
	2008.10-2011.08	6MT	Rear	Estate 4WD CCDA		Propshaft	PS900105
2.8 (142 kw)	1997.04-2001.05	5MT	Rear	Saloon 4WD ACK/ALG/AMX/APR/AOD	Chassis no. to:4B-Y-100 000	Propshaft	PS900104
2.8 (150 kw)	2010.11-2015.04	7AT	Rear	Saloon 4WD CHVA	for PR code:G1D	Propshaft	PS900581
	2011.05-2015.04	7AT	Rear	Estate 4WD CHVA	for PR code:G1D	Propshaft	PS900581
2.8 (154 kw)	2007.06-2008.09	6AT	Rear	Estate 4WD BDX		Propshaft	PS900105
	2007.06-2008.10	6AT	Rear	Saloon 4WD BDX		Propshaft	PS900105

	 YEAR	TRANSM.	FITTING POSITION	BODY STYLE & DRIVE TYPE & ENGINE	REMARKS	 PRODUCT	GSP Ref.
AUDI A6 Quattro							
2.8 (162 kw)	2008.10-2011.03	6AT	Rear	Saloon 4WD CCEA		Propshaft	PS900105
	2008.10-2011.08	6AT	Rear	Estate 4WD CCEA		Propshaft	PS900105
	2014.09-2018.09	7AT	Rear	Saloon 4WD CVPA	for PR code:G1D	Propshaft	PS900581
	2014.09-2018.09	7AT	Rear	Estate 4WD CVPA	for PR code:G1D	Propshaft	PS900581
3.0 (150 kw)	2011.02-2015.04	7AT	Rear	Saloon 4WD CLAA	Date To:2015.04,for PR code:G1D	Propshaft	PS900581
	2011.05-2015.04	7AT	Rear	Estate 4WD CLAA	Date To:2015.04,for PR code:G1D	Propshaft	PS900581
3.0 (155 kw)	2005.02-2011.03	AT	Rear	Saloon 4WD BNG/CDYB	Date From:2005.02	Propshaft	PS900105
	2005.03-2011.08	AT	Rear	Estate 4WD BNG/CDYB		Propshaft	PS900105
	2014.09-2018.09	7AT	Rear	Estate 4WD CRTF/CZVC	for PR code:G1D	Propshaft	PS900581
	2014.09-2018.09	7AT	Rear	Saloon 4WD CRTF/CZVC	for PR code:G1D	Propshaft	PS900581
3.0 (160 kw)	2004.04-2006.05	6AT	Rear	Saloon 4WD BBJ	For PR code:G0R	Propshaft	PS900105
	2005.03-2006.05	6AT	Rear	Estate 4WD BBJ	For PR code:G0R	Propshaft	PS900105
	2014.09-2018.09	7AT	Rear	Estate 4WD CRTE/CZVA	for PR code:G1D	Propshaft	PS900581
	2014.09-2018.09	7AT	Rear	Saloon 4WD CRTE/CZVA	for PR code:G1D	Propshaft	PS900581
3.0 (165 kw)	2004.04-2006.05	6AT	Rear	Saloon 4WD BMK		Propshaft	PS900105
	2005.03-2006.05	AT/MT	Rear	Estate 4WD BMK		Propshaft	PS900105
3.0 (176 kw)	2008.10-2011.03	6AT	Rear	Saloon 4WD CDYA/CDYC		Propshaft	PS900105
	2008.10-2011.08	6AT	Rear	Estate 4WD CDYA/CDYC		Propshaft	PS900105
3.0 (180 kw)	2010.11-2015.04	7AT	Rear	Saloon 4WD CDUC/CDUD/CKVB/CKVC	Date To:2015.04,for PR code:G1D	Propshaft	PS900581
	2011.05-2015.04	7AT	Rear	Estate 4WD CDUC/CDUD/CKVB/CKVC	Date To:2015.04,for PR code:G1D	Propshaft	PS900581
3.0 (200 kw)	2014.09-2018.09	7AT	Rear	Estate 4WD CRTD	for PR code:G1D	Propshaft	PS900581
	2014.09-2018.09	7AT	Rear	Saloon 4WD CRTD	for PR code:G1D	Propshaft	PS900581
3.0 (213 kw)	2008.10-2011.08	6AT	Rear	Estate 4WD CAJA		Propshaft	PS900105
	2008.10-2011.08	6AT	Rear	Saloon 4WD CAJA		Propshaft	PS900105
3.0 (220 kw)	2008.10-2011.03	6AT	Rear	Saloon 4WD CCAA		Propshaft	PS900105
	2008.10-2011.08	6AT	Rear	Estate 4WD CCAA		Propshaft	PS900105
	2010.11-2012.05	7AT	Rear	Saloon 4WD CGWB	for PR code:G1D	Propshaft	PS900581
	2011.05-2014.12	7AT	Rear	Estate 4WD CGWB	for PR code:G1D	Propshaft	PS900581
3.0 (228 kw)	2011.03-2015.04	7AT	Rear	Saloon 4WD CGWD/CGXB/CTUA	Date To:2015.04	Propshaft	PS900581
	2011.11-2015.04	7AT	Rear	Estate 4WD CGWD	Date To:2015.04,for PR code:G1D	Propshaft	PS900581
3.0 (245 kw)	2014.09-2018.09	7AT	Rear	Estate 4WD CREC	for PR code:G1D	Propshaft	PS900581
	2014.09-2018.09	7AT	Rear	Saloon 4WD CREC	for PR code:G1D	Propshaft	PS900581
3.2 (183 kw)	2006.09-2008.10	6AT	Rear	Saloon 4WD BYU		Propshaft	PS900105
3.2 (188 kw)	2004.04-2008.10	6AT/6MT	Rear	Saloon 4WD AUK/BKH	For PR code:G0L/G03	Propshaft	PS900105
	2005.03-2008.10	6AT/6MT	Rear	Estate 4WD AUK/BKH	For PR code:G0L/G03	Propshaft	PS900105
4.2 (220 kw)	1999.04-2005.01	5MT	Rear	Saloon 4WD ARS/ASG	Chassis no. to:4B-Y-100 000	Propshaft	PS900104
4.2 (246 kw)	2004.04-2006.05	6AT	Rear	Saloon 4WD BAT		Propshaft	PS900105
	2005.03-2006.05	6AT	Rear	Estate 4WD BAT		Propshaft	PS900105
4.2 (257 kw)	2006.06-2011.03	6AT	Rear	Saloon 4WD BVJ		Propshaft	PS900105
	2006.06-2011.08	6AT	Rear	Estate 4WD BVJ		Propshaft	PS900105
A7 Sportback Quattro							
2.0 (183 kw)	2015.05-2018.05	7AT	Rear	Hatchback 4WD CYPB		Propshaft	PS900581
2.0 (185 kw)	2015.05-2018.05	7AT	Rear	Hatchback 4WD CYNB/CYPA		Propshaft	PS900581
2.8 (162 kw)	2014.09-2018.05	7AT	Rear	Hatchback 4WD CVPA		Propshaft	PS900581
3.0 (140 kw)	2015.11-2018.05	7AT	Rear	Hatchback 4WD CZVE/CZVF		Propshaft	PS900581
3.0 (150 kw)	2010.12-2015.03	7AT	Rear	Hatchback 4WD CLAA		Propshaft	PS900581
3.0 (155 kw)	2014.07-2018.12	7AT	Rear	Hatchback 4WD CRTF/CTCB/CZVC		Propshaft	PS900581
3.0 (160 kw)	2014.07-2018.05	7AT	Rear	Hatchback 4WD CRTE/CZVA		Propshaft	PS900581
3.0 (180 kw)	2010.07-2016.06	7AT	Rear	Hatchback 4WD CDUC/CDUD/CKVB/CKVC		Propshaft	PS900581
3.0 (200 kw)	2014.05-2018.05	7AT	Rear	Hatchback 4WD CRTD		Propshaft	PS900581
3.0 (220 kw)	2010.07-2012.05	7AT	Rear	Hatchback 4WD CGWB		Propshaft	PS900581
3.0 (228 kw)	2011.11-2015.03	7AT	Rear	Hatchback 4WD CGWD/CGXB/CTTA	Date From:2011.11	Propshaft	PS900581
3.0 (245 kw)	2014.05-2018.05	7AT	Rear	Hatchback 4WD CREC		Propshaft	PS900581
Q2 Quattro							
2.0 (110 kw)	2016.09-		Front	SUV 4WD DFGA/DTTC		Flexible Coupling	537626
	2016.09-		Rear	SUV 4WD DFGA/DTTC		Flexible Coupling	533882
	2016.09-		Front	SUV 4WD DFGA/DTTC		Flexible Coupling Kit	537626S
	2016.09-		Rear	SUV 4WD DFGA/DTTC		Flexible Coupling Kit	533882S
2.0 (140 kw)	2016.07-2018.08		Rear	SUV 4WD DFHA		Propshaft	PS900584
	2016.07-2018.08		Front	SUV 4WD DFHA		Flexible Coupling	537626
	2016.07-2018.08		Rear	SUV 4WD DFHA		Flexible Coupling	533882
	2016.07-2018.08		Front	SUV 4WD DFHA		Flexible Coupling Kit	537626S
	2016.07-2018.08		Rear	SUV 4WD DFHA		Flexible Coupling Kit	533882S
	2017.05-		Front	SUV 4WD CZPB/DKZA		Flexible Coupling	537626



	 YEAR	TRANSM.	FITTING POSITION	BODY STYLE & DRIVE TYPE & ENGINE	REMARKS	 PRODUCT	GSP Ref.
AUDI Q2 Quattro							
2.0 (140 kw)	2017.05-		Rear	SUV 4WD CZPB/DKZA		Flexible Coupling	533882
	2017.05-		Front	SUV 4WD CZPB/DKZA		Flexible Coupling Kit	537626S
	2017.05-		Rear	SUV 4WD CZPB/DKZA		Flexible Coupling Kit	533882S
Q3							
1.4 (110 kw)	2013.10-2018.10		Centre	SUV FWD CHPB/CZDA/CZEA		Center Bearing Support	514808
2.0 (100 kw)	2011.09-2018.10		Centre	SUV FWD CFFA/CUVB/DFTB		Center Bearing Support	514808
2.0 (103 kw)	2011.09-2015.04		Centre	SUV FWD CFFB/CLJA		Center Bearing Support	514808
2.0 (110 kw)	2014.11-2018.10		Centre	SUV FWD CUVB/DBBA/DFTA		Center Bearing Support	514808
2.0 (130 kw)	2013.05-2015.04		Centre	SUV FWD CFGC		Center Bearing Support	514808
2.0 (132 kw)	2015.05-2018.10		Centre	SUV FWD CULB		Center Bearing Support	514808
2.0 (135 kw)	2015.05-2018.10		Centre	SUV FWD CUWA/DFUA		Center Bearing Support	514808
Q3 Quattro							
2.0 (103 kw)	2012.01-2015.04	6MT	Rear	SUV 4WD CFFB	Date To:2015.04,Trans. code:MQ500	Propshaft	PS900520
	2012.01-2015.04	7AT	Rear	SUV 4WD CFFB	Date To:2015.04	Propshaft	PS900520
	2012.01-2015.04		Centre	SUV 4WD CFFB		Center Bearing Support	514808
	2012.01-2015.04		Centre	SUV 4WD CFFB	Date to:2014	Center Bearing Support Kit	514808S
	2012.01-2015.04		Centre	SUV 4WD CFFB		Center Bearing Support Kit	514808S
	2012.01-2015.04		Rear	SUV 4WD CFFB		Flexible Coupling	533882
2.0 (110 kw)	2014.11-2018.10	6MT	Rear	SUV 4WD CUVB/DFTA	Trans. code:MQ500	Propshaft	PS900520
	2014.11-2018.10	7AT	Rear	SUV 4WD CUVB/DFTA		Propshaft	PS900520
	2014.11-2018.10		Centre	SUV 4WD CUVB/DFTA		Center Bearing Support	514808
	2014.11-2018.10		Centre	SUV 4WD CUVB/DFTA	Date from:2015	Center Bearing Support Kit	514808S
	2014.11-2018.10		Centre	SUV 4WD CUVB/DFTA		Center Bearing Support Kit	514808S
	2014.11-2018.10		Rear	SUV 4WD CUVB/DFTA		Flexible Coupling	533882
	2018.07-		Front	SUV 4WD DFGA/DTSA/DTSB		Flexible Coupling	537626
	2018.07-		Rear	SUV 4WD DFGA/DTSA/DTSB		Flexible Coupling	533882
	2018.07-		Front	SUV 4WD DFGA/DTSA/DTSB		Flexible Coupling Kit	537626S
	2018.07-		Rear	SUV 4WD DFGA/DTSA/DTSB		Flexible Coupling Kit	533882S
2.0 (120 kw)	2011.06-2015.04	6MT	Rear	SUV 4WD CFGD	Trans. code:MQ500	Propshaft	PS900520
	2011.06-2015.04	7AT	Rear	SUV 4WD CFGD		Propshaft	PS900520
	2011.06-2015.04		Centre	SUV 4WD CFGD	Date from-to:2012-2014	Center Bearing Support Kit	514808S
	2011.06-2015.04		Centre	SUV 4WD CFGD		Center Bearing Support Kit	514808S
	2011.06-2015.04		Rear	SUV 4WD CFGD		Flexible Coupling	533882
2.0 (125 kw)	2011.06-2015.04	6MT	Rear	SUV 4WD CCZC	Trans. code:MQ500	Propshaft	PS900520
	2011.06-2015.04	7AT	Rear	SUV 4WD CCZC		Propshaft	PS900520
	2011.06-2015.04		Centre	SUV 4WD CCZC		Center Bearing Support	514808
	2011.06-2015.04		Centre	SUV 4WD CCZC	Date from-to: 2012-2014	Center Bearing Support Kit	514808S
	2011.06-2015.04		Rear	SUV 4WD CCZC		Flexible Coupling	533882
2.0 (130 kw)	2011.06-2015.04	6MT	Rear	SUV 4WD CFGC/CLLB	Date To:2015.04,Trans. code:MQ500	Propshaft	PS900520
	2011.06-2015.04	7AT	Rear	SUV 4WD CFGC/CLLB	Date To:2015.04	Propshaft	PS900520
	2011.06-2015.04		Centre	SUV 4WD CFGC/CLLB		Center Bearing Support	514808
	2011.06-2015.04		Centre	SUV 4WD CFGC/CLLB	Date from-to: 2012-2014	Center Bearing Support Kit	514808S
	2011.06-2015.04		Rear	SUV 4WD CFGC/CLLB		Flexible Coupling	533882
2.0 (132 kw)	2015.01-2018.12	6MT	Rear	SUV 4WD CULB	Trans. code:MQ500	Propshaft	PS900520
	2015.01-2018.12	7AT	Rear	SUV 4WD CULB		Propshaft	PS900520
	2015.01-2018.12		Centre	SUV 4WD CULB		Center Bearing Support	514808
	2015.01-2018.12		Centre	SUV 4WD CULB	Date from:2015	Center Bearing Support Kit	514808S
	2015.01-2018.12		Rear	SUV 4WD CULB		Flexible Coupling	533882
2.0 (135 kw)	2014.11-2018.10	6MT	Rear	SUV 4WD CUWA/CYLA/DFUA	Trans. code:MQ500	Propshaft	PS900520
	2014.11-2018.10	7AT	Rear	SUV 4WD CUWA/CYLA/DFUA		Propshaft	PS900520
	2014.11-2018.10		Centre	SUV 4WD CUWA/CYLA/DFUA		Center Bearing Support	514808
	2014.11-2018.10		Centre	SUV 4WD CUWA/CYLA/DFUA	Date from:2015	Center Bearing Support Kit	514808S
	2014.11-2018.10		Rear	SUV 4WD CUWA/CYLA/DFUA		Flexible Coupling	533882
2.0 (140 kw)	2018.09-		Front	SUV 4WD DKTC/DNNA		Flexible Coupling	537626
	2018.09-		Rear	SUV 4WD DKTC/DNNA		Flexible Coupling	533882
	2018.09-		Front	SUV 4WD DKTC/DNNA		Flexible Coupling Kit	537626S
	2018.09-		Rear	SUV 4WD DKTC/DNNA		Flexible Coupling Kit	533882S
	2018.10-		Front	SUV 4WD DFHA		Flexible Coupling	537626
	2018.10-		Rear	SUV 4WD DFHA		Flexible Coupling	533882
	2018.10-		Front	SUV 4WD DFHA		Flexible Coupling Kit	537626S
	2018.10-		Rear	SUV 4WD DFHA		Flexible Coupling Kit	533882S
2.0 (147 kw)	2014.04-2018.10	6MT	Rear	SUV 4WD CCTA	Trans. code:MQ500	Propshaft	PS900520
	2014.04-2018.10	7AT	Rear	SUV 4WD CCTA		Propshaft	PS900520
	2014.04-2018.10		Centre	SUV 4WD CCTA	for model year:2015	Center Bearing Support Kit	514808S



	 YEAR	TRANSM.	FITTING POSITION	BODY STYLE & DRIVE TYPE & ENGINE	REMARKS	 PRODUCT	GSP Ref.
AUDI Q3 Quattro							
2.0 (147 kw)	2014.04-2018.10		Centre	SUV 4WD CCTA		Center Bearing Support Kit	514808S
	2014.04-2018.10		Rear	SUV 4WD CCTA		Flexible Coupling	533882
2.0 (155 kw)	2011.06-2015.04	6MT	Rear	SUV 4WD CPSA	Trans. code:MQ500	Propshaft	PS900520
	2011.06-2015.04	7AT	Rear	SUV 4WD CPSA		Propshaft	PS900520
	2011.06-2015.04		Centre	SUV 4WD CPSA		Center Bearing Support	514808
	2011.06-2015.04		Centre	SUV 4WD CPSA	Date from-to: 2012-2014	Center Bearing Support Kit	514808S
	2011.06-2015.04		Rear	SUV 4WD CPSA		Flexible Coupling	533882
2.0 (162 kw)	2014.11-2018.10	6MT	Rear	SUV 4WD CULC	Trans. code:MQ500	Propshaft	PS900520
	2014.11-2018.10	7AT	Rear	SUV 4WD CULC		Propshaft	PS900520
	2014.11-2018.10		Centre	SUV 4WD CULC		Center Bearing Support	514808
	2014.11-2018.10		Centre	SUV 4WD CULC	Date from:2015	Center Bearing Support Kit	514808S
	2014.11-2018.10		Centre	SUV 4WD CULC		Center Bearing Support Kit	514808S
	2014.11-2018.10		Rear	SUV 4WD CULC		Flexible Coupling	533882
2.0 (169 kw)	2018.07-		Front	SUV 4WD DKTA		Flexible Coupling	537626
	2018.07-		Rear	SUV 4WD DKTA		Flexible Coupling	533882
	2018.07-		Front	SUV 4WD DKTA		Flexible Coupling Kit	537626S
	2018.07-		Rear	SUV 4WD DKTA		Flexible Coupling Kit	533882S
Q5							
2.0 (140 kw)	2015.09-2017.05		-	SUV FWD CNHA		Joint,propshaft	661093
Q5 Quattro							
2.0 (100 kw)	2009.08-2017.05	6MT	Rear	SUV 4WD CAGB/CJCB/CSUB	Date From:2010.06	Propshaft	PS900590
	2009.08-2017.05		-	SUV 4WD CAGB/CJCB/CSUB		Joint,propshaft	661093
2.0 (105 kw)	2009.08-2013.05	6MT	Rear	SUV 4WD CAGA/CJCA	Date From:2010.06	Propshaft	PS900590
	2009.08-2013.05		-	SUV 4WD CAGA/CJCA		Joint,propshaft	661093
2.0 (110 kw)	2012.11-2017.05	6MT	Rear	SUV 4WD CJCD/CSUA		Propshaft	PS900590
	2012.11-2017.05		-	SUV 4WD CJCD/CSUA		Joint,propshaft	661093
2.0 (120 kw)	2008.11-2017.05	6MT	Rear	SUV 4WD CAHB/CGLA/CGLD/CNHC	Date From:2010.06	Propshaft	PS900590
	2008.11-2017.05	DCT	Rear	SUV 4WD CAHB/CGLA/CGLD/CNHC	Date To:2010.05	Propshaft	PS900107
	2008.11-2017.05	DCT	Rear	SUV 4WD CAHB/CGLA/CGLD/CNHC	Date From:2010.06	Propshaft	PS900552
	2008.11-2017.05		-	SUV 4WD CAHB/CGLA/CGLD/CNHC		Joint,propshaft	661093
2.0 (125 kw)	2008.11-2012.09	6MT	Rear	SUV 4WD CAHA/CGLB/CMGA	Date From:2010.06	Propshaft	PS900590
	2008.11-2012.09	DCT	Rear	SUV 4WD CAHA/CGLB/CMGA	Date To:2010.05	Propshaft	PS900107
	2008.11-2012.09	DCT	Rear	SUV 4WD CAHA/CGLB/CMGA	Date From:2010.06	Propshaft	PS900552
	2008.11-2012.09		Rear	SUV 4WD CAHA/CGLB/CMGA		Joint,propshaft	661093
2.0 (130 kw)	2012.06-2017.05	6MT	Rear	SUV 4WD CGLC/CMGB		Propshaft	PS900590
	2012.06-2017.05	DCT	Rear	SUV 4WD CGLC/CMGB		Propshaft	PS900552
	2012.06-2017.05		Rear	SUV 4WD CGLC/CMGB		Joint,propshaft	661093
2.0 (132 kw)	2009.08-2017.05	6MT	Rear	SUV 4WD CDNB/CNCB	Date From:2010.06	Propshaft	PS900590
	2009.08-2017.05	8AT	Rear	SUV 4WD CDNB/CNCB		Propshaft	PS900108
	2009.08-2017.05		-	SUV 4WD CDNB/CNCB		Joint,propshaft	661093
2.0 (140 kw)	2014.04-2017.05	6MT	Rear	SUV 4WD CNHA	Date From:2014.04	Propshaft	PS900590
	2014.04-2017.05	DCT	Rear	SUV 4WD CNHA	Date From:2014.04	Propshaft	PS900552
	2014.04-2017.05		Rear	SUV 4WD CNHA		Joint,propshaft	661093
2.0 (155 kw)	2008.11-2012.09	6MT	Rear	SUV 4WD CAEB/CDNC	Date From:2010.06	Propshaft	PS900590
	2008.11-2012.09	8AT	Rear	SUV 4WD CAEB/CDNC		Propshaft	PS900108
	2008.11-2012.09	DCT	Rear	SUV 4WD CAEB/CDNC	Date To:2010.05	Propshaft	PS900107
	2008.11-2012.09	DCT	Rear	SUV 4WD CAEB/CDNC	Date From:2010.06	Propshaft	PS900552
	2008.11-2012.09		Rear	SUV 4WD CAEB/CDNC		Joint,propshaft	661093
	2011.06-2016.06	8AT	Rear	SUV 4WD CHJA		Propshaft	PS900108
	2011.06-2016.06		-	SUV 4WD CHJA		Joint,propshaft	661093
2.0 (162 kw)	2013.05-2017.05	8AT	Rear	SUV 4WD CPMB		Propshaft	PS900108
2.0 (165 kw)	2012.06-2016.05	6MT	Rear	SUV 4WD CNCD		Propshaft	PS900590
	2012.06-2016.05	8AT	Rear	SUV 4WD CNCD		Propshaft	PS900108
	2012.06-2016.05		-	SUV 4WD CNCD		Joint,propshaft	661093
2.0 (169 kw)	2015.08-2017.05	6MT	Rear	SUV 4WD CNCE		Propshaft	PS900590
	2015.08-2017.05	8AT	Rear	SUV 4WD CNCE		Propshaft	PS900108
2.0 (183 kw)	2017.01-2020.11		-	SUV 4WD DAXC		Joint,propshaft	661093
2.0 (185 kw)	2016.06-2020.11		-	SUV 4WD DAXB/DAYB		Joint,propshaft	661093
3.0 (155 kw)	2008.11-2012.09	DCT	Rear	SUV 4WD CCWB	Date To:2010.05	Propshaft	PS900107
	2008.11-2012.09	DCT	Rear	SUV 4WD CCWB	Date From:2010.06	Propshaft	PS900552
	2008.11-2012.09		-	SUV 4WD CCWB		Joint,propshaft	661093
3.0 (176 kw)	2008.11-2017.05	8AT	Rear	SUV 4WD CCWA/CPNB		Propshaft	PS900108
	2008.11-2017.05	DCT	Rear	SUV 4WD CCWA/CPNB	Date To:2010.05	Propshaft	PS900107
	2008.11-2017.05	DCT	Rear	SUV 4WD CCWA/CPNB	Date From:2010.06	Propshaft	PS900552



	 YEAR	TRANSM.	FITTING POSITION	BODY STYLE & DRIVE TYPE & ENGINE	REMARKS	 PRODUCT	GSP Ref.
AUDI Q5 Quattro							
3.0 (176 kw)	2008.11-2017.05		Rear	SUV 4WD CCWA/CPNB		Joint,propshaft	661093
3.0 (180 kw)	2012.06-2017.05	DCT	Rear	SUV 4WD CDUD		Propshaft	PS900552
	2012.06-2017.05		Rear	SUV 4WD CDUD		Joint,propshaft	661093
3.0 (184 kw)	2014.01-2017.05	DCT	Rear	SUV 4WD CTBC	Date From:2014.01	Propshaft	PS900552
3.0 (190 kw)	2013.11-2017.05	DCT	Rear	SUV 4WD CTBA		Propshaft	PS900552
	2013.11-2017.05		Rear	SUV 4WD CTBA		Joint,propshaft	661093
3.0 (200 kw)	2012.06-2017.12	8AT	Rear	SUV 4WD CTUC/CTVA		Propshaft	PS900108
	2012.06-2017.12		-	SUV 4WD CTUC/CTVA		Joint,propshaft	661093
3.2 (199 kw)	2008.11-2012.09	DCT	Rear	SUV 4WD CALB	Date To:2010.05	Propshaft	PS900107
	2008.11-2012.09	DCT	Rear	SUV 4WD CALB	Date From:2010.06 to 2012.09	Propshaft	PS900552
	2008.11-2012.09		-	SUV 4WD CALB		Joint,propshaft	661093
Q7 Quattro							
2.0 (185 kw)	2015.08-2019.12		Rear	SUV 4WD CYRB	Date To:2017.09,for PR Code:T2G/T2H	Propshaft	PS900595
3.0 (150 kw)	2010.05-2015.08	AT/MT	Front	SUV 4WD CJGC/CJMA		Propshaft	PS900111
3.0 (155 kw)	2006.03-2010.05		Front	SUV 4WD BUN/CASB	For Engine Code:BUN,For PR code:T8T/T41/TA0/TE1	Propshaft	PS900525
	2006.03-2010.05		Front	SUV 4WD BUN/CASB	For Engine Code:BUN,For PR code:T8T/T41/TA0/TE1	Joint,propshaft	661094
	2015.08-2019.12		Rear	SUV 4WD CRTE/CZZA/CZZB	Date To:2017.09,for PR Code:TS8/OK0	Propshaft	PS900595
3.0 (160 kw)	2015.08-2019.12		Rear	SUV 4WD CRTE/CZZA/CZZB	Date From:2015.08,Date To:2017.09,for PR Code:TS8/OK0	Propshaft	PS900595
3.0 (165 kw)	2009.06-2012.05		Front	SUV 4WD CATA	Date From:2011.01	Propshaft	PS900111
	2009.06-2012.05		Front	SUV 4WD CATA	Date To:2010.12	Propshaft	PS900525
	2009.06-2012.05		Front	SUV 4WD CATA	Date To:2010.12	Joint,propshaft	661094
3.0 (171 kw)	2006.03-2008.05		Front	SUV 4WD BUG	For PR code:T8T/T41/TA0/TE1	Propshaft	PS900525
	2006.03-2008.05		Front	SUV 4WD BUG	For PR code:T8T/T41/TA0/TE1	Joint,propshaft	661094
3.0 (176 kw)	2007.11-2015.08		Front	SUV 4WD CASA/CCMA/CJGA/CNRB	Date From:2011.01	Propshaft	PS900111
	2007.11-2015.08		Front	SUV 4WD CASA/CCMA/CJGA/CNRB	Date To:2010.12,For PR Code:T41/TE1	Propshaft	PS900525
	2007.11-2015.08		Front	SUV 4WD CASA/CCMA/CJGA/CNRB	Date To:2010.12,For PR Code:T41/TE1	Joint,propshaft	661094
3.0 (180 kw)	2011.05-2015.08	AT/MT	Front	SUV 4WD CJGD/CLZB/CRCA		Propshaft	PS900111
3.0 (183 kw)	2015.06-		Rear	SUV 4WD CVMD	Date To:2017.09,for PR Code:TS8/OK0	Propshaft	PS900595
3.0 (190 kw)	2015.06-2019.12		Rear	SUV 4WD CUEA	Date To:2017.09,for PR Code:TS8/OK0	Propshaft	PS900595
	2015.08-2019.12		Rear	SUV 4WD CVZA	Date To:2017.09,for PR Code:TS8/OK0	Propshaft	PS900595
3.0 (200 kw)	2010.05-2015.08	AT/MT	Front	SUV 4WD CJTC/CJWC		Propshaft	PS900111
	2010.05-2015.08	AT	Rear	SUV 4WD CJTC/CJWC		Propshaft	PS900110
	2015.01-2019.12		Rear	SUV 4WD CRTC	Date To:2017.09,for PR Code:TS8/OK0	Propshaft	PS900595
3.0 (206 kw)	2011.05-2015.08	AT/MT	Front	SUV 4WD CJWE/CTWB		Propshaft	PS900111
	2011.05-2015.08	AT	Rear	SUV 4WD CJWE/CTWB		Propshaft	PS900110
3.0 (245 kw)	2010.05-2015.08	AT/MT	Front	SUV 4WD CJTB/CJWB/CNAA/CTWA		Propshaft	PS900111
	2010.05-2015.08	AT	Rear	SUV 4WD CJTB/CJWB/CNAA/CTWA		Propshaft	PS900110
3.6 (206 kw)	2006.08-2010.05		Front	SUV 4WD BHK	For PR code:T8T/T41/TA0/TE1	Propshaft	PS900525
	2006.08-2010.05		Rear	SUV 4WD BHK		Propshaft	PS900109
	2006.08-2010.05		Front	SUV 4WD BHK	For PR code:T8T/T41/TA0/TE1	Joint,propshaft	661094
4.2 (257 kw)	2006.03-2010.05		Front	SUV 4WD BAR	For PR code:T8T/T41/TA0/TE1	Propshaft	PS900525
	2006.03-2010.05		Front	SUV 4WD BAR	Date To:2010.05,For PR code:T8T/T41/TA0/TE1	Propshaft	PS900525
	2006.03-2010.05		Rear	SUV 4WD BAR		Propshaft	PS900109
	2006.03-2010.05		Rear	SUV 4WD BAR	Date To:2010.05	Propshaft	PS900109
	2006.03-2010.05		Front	SUV 4WD BAR	For PR code:T8T/T41/TA0/TE1	Joint,propshaft	661094
	2006.03-2010.05		Front	SUV 4WD BAR	Date To:2010.05,For PR code:T8T/T41/TA0/TE1	Joint,propshaft	661094
RS4 Quattro							
4.2 (331 kw)	2012.05-2015.08	7AT	-	Estate 4WD CFSA		Propshaft	PS900103
RSQ3 Quattro							
2.5 (228 kw)	2013.05-2018.10		Centre	SUV 4WD CTSA		Center Bearing Support Kit	514808S
2.5 (250 kw)	2013.05-2018.10		Centre	SUV 4WD CZGA		Center Bearing Support Kit	514808S
S1 Quattro							
2.0 (170 kw)	2014.01-2018.10		Rear	Hatchback 4WD CWZA		Flexible Coupling	533882
	2014.01-2018.10		Rear	Hatchback 4WD CWZA		Flexible Coupling Kit	533882S
S1 Sportback Quattro							
2.0 (170 kw)	2014.01-2018.10		Rear	Hatchback 4WD CWZA		Flexible Coupling	533882
	2014.01-2018.10		Rear	Hatchback 4WD CWZA		Flexible Coupling Kit	533882S
S3 Cabrio Quattro							
2.0 (210 kw)	2014.05-2016.07		Front	Cabriolet 4WD CJXF		Flexible Coupling	537626
	2014.05-2016.07		Rear	Cabriolet 4WD CJXF		Flexible Coupling	533882
	2014.05-2016.07		Front	Cabriolet 4WD CJXF		Flexible Coupling Kit	537626S
	2014.05-2016.07		Rear	Cabriolet 4WD CJXF		Flexible Coupling Kit	533882S
2.0 (221 kw)	2014.05-2020.10		Front	Cabriolet 4WD CJXC/DNUE		Flexible Coupling	537626
	2014.05-2020.10		Rear	Cabriolet 4WD CJXC/DNUE		Flexible Coupling	533882



	 YEAR	TRANSM.	FITTING POSITION	BODY STYLE & DRIVE TYPE & ENGINE	REMARKS	 PRODUCT	GSP Ref.
AUDI							
S3 Cabrio Quattro							
2.0 (221 kw)	2014.05-2020.10		Front	Cabriolet 4WD CJXC/DNUE		Flexible Coupling Kit	537626S
	2014.05-2020.10		Rear	Cabriolet 4WD CJXC/DNUE		Flexible Coupling Kit	533882S
2.0 (228 kw)	2016.07-2020.10		Front	Cabriolet 4WD DJHA		Flexible Coupling	537626
	2016.07-2020.10		Rear	Cabriolet 4WD DJHA		Flexible Coupling	533882
	2016.07-2020.10		Front	Cabriolet 4WD DJHA		Flexible Coupling Kit	537626S
	2016.07-2020.10		Rear	Cabriolet 4WD DJHA		Flexible Coupling Kit	533882S
S3 Quattro							
1.8 (154 kw)	1998.11-2002.04		Front	Hatchback 4WD AMK/APY/AUL		Flexible Coupling	537626
	1998.11-2002.04		Front	Hatchback 4WD AMK/APY/AUL		Flexible Coupling Kit	537626S
1.8 (165 kw)	2001.08-2003.06		Front	Hatchback 4WD BAM		Flexible Coupling	537626
	2001.08-2003.06		Front	Hatchback 4WD BAM		Flexible Coupling Kit	537626S
2.0 (188 kw)	2007.02-2012.08		Front	Hatchback 4WD BZC/CDLC		Flexible Coupling	537626
2.0 (195 kw)	2006.11-2012.08		Front	Hatchback 4WD BHZ/CDLA		Flexible Coupling	537626
	2006.11-2012.08		Rear	Hatchback 4WD BHZ/CDLA		Flexible Coupling	533882
2.0 (206 kw)	2012.10-2014.05		Front	Hatchback 4WD CJXB		Flexible Coupling	537626
	2012.10-2014.05		Rear	Hatchback 4WD CJXB		Flexible Coupling	533882
	2012.10-2014.05		Front	Hatchback 4WD CJXB		Flexible Coupling Kit	537626S
	2012.10-2014.05		Rear	Hatchback 4WD CJXB		Flexible Coupling Kit	533882S
	2013.10-2014.05		Front	Saloon 4WD CJXB		Flexible Coupling	537626
	2013.10-2014.05		Rear	Saloon 4WD CJXB		Flexible Coupling	533882
	2013.10-2014.05		Front	Saloon 4WD CJXB		Flexible Coupling Kit	537626S
	2013.10-2014.05		Rear	Saloon 4WD CJXB		Flexible Coupling Kit	533882S
2.0 (210 kw)	2014.05-2016.08		Front	Saloon 4WD CJXF		Flexible Coupling	537626
	2014.05-2016.08		Front	Hatchback 4WD CJXF		Flexible Coupling	537626
	2014.05-2016.08		Rear	Saloon 4WD CJXF		Flexible Coupling	533882
	2014.05-2016.08		Rear	Hatchback 4WD CJXF		Flexible Coupling	533882
	2014.05-2016.08		Front	Saloon 4WD CJXF		Flexible Coupling Kit	537626S
	2014.05-2016.08		Front	Hatchback 4WD CJXF		Flexible Coupling Kit	537626S
	2014.05-2016.08		Rear	Saloon 4WD CJXF		Flexible Coupling Kit	533882S
	2014.05-2016.08		Rear	Hatchback 4WD CJXF		Flexible Coupling Kit	533882S
2.0 (213 kw)	2016.07-2017.12		Front	Hatchback 4WD CJXD/DJHB		Flexible Coupling	537626
	2016.07-2017.12		Rear	Hatchback 4WD CJXD/DJHB		Flexible Coupling	533882
	2016.07-2017.12		Front	Hatchback 4WD CJXD/DJHB		Flexible Coupling Kit	537626S
	2016.07-2017.12		Rear	Hatchback 4WD CJXD/DJHB		Flexible Coupling Kit	533882S
	2016.08-2020.10		Front	Saloon 4WD CJXD/DJHB		Flexible Coupling	537626
	2016.08-2020.10		Rear	Saloon 4WD CJXD/DJHB		Flexible Coupling	533882
	2016.08-2020.10		Front	Saloon 4WD CJXD/DJHB		Flexible Coupling Kit	537626S
	2016.08-2020.10		Rear	Saloon 4WD CJXD/DJHB		Flexible Coupling Kit	533882S
2.0 (215 kw)	2014.05-2016.08		Front	Saloon 4WD CYFB		Flexible Coupling	537626
	2014.05-2016.08		Rear	Saloon 4WD CYFB		Flexible Coupling	533882
	2014.05-2016.08		Front	Saloon 4WD CYFB		Flexible Coupling Kit	537626S
	2014.05-2016.08		Rear	Saloon 4WD CYFB		Flexible Coupling Kit	533882S
2.0 (221 kw)	2012.10-2016.08		Front	Hatchback 4WD CJXC		Flexible Coupling	537626
	2012.10-2016.08		Rear	Hatchback 4WD CJXC		Flexible Coupling	533882
	2012.10-2016.08		Front	Hatchback 4WD CJXC		Flexible Coupling Kit	537626S
	2012.10-2016.08		Rear	Hatchback 4WD CJXC		Flexible Coupling Kit	533882S
	2013.05-2020.10		Front	Saloon 4WD CJXC/DNUE		Flexible Coupling	537626
	2013.05-2020.10		Rear	Saloon 4WD CJXC/DNUE		Flexible Coupling	533882
	2013.05-2020.10		Front	Saloon 4WD CJXC/DNUE		Flexible Coupling Kit	537626S
	2013.05-2020.10		Rear	Saloon 4WD CJXC/DNUE		Flexible Coupling Kit	533882S
2.0 (228 kw)	2016.06-2017.12		Front	Hatchback 4WD CJXG/DJHA		Flexible Coupling	537626
	2016.06-2017.12		Rear	Hatchback 4WD CJXG/DJHA		Flexible Coupling	533882
	2016.06-2017.12		Front	Hatchback 4WD CJXG/DJHA		Flexible Coupling Kit	537626S
	2016.06-2017.12		Rear	Hatchback 4WD CJXG/DJHA		Flexible Coupling Kit	533882S
	2016.06-2020.10		Front	Saloon 4WD CJXG/DJHA		Flexible Coupling	537626
	2016.06-2020.10		Rear	Saloon 4WD CJXG/DJHA		Flexible Coupling	533882
	2016.06-2020.10		Front	Saloon 4WD CJXG/DJHA		Flexible Coupling Kit	537626S
2016.06-2020.10		Rear	Saloon 4WD CJXG/DJHA		Flexible Coupling Kit	533882S	
S3 Sportback Quattro							
2.0 (206 kw)	2012.10-2014.05		Rear	Hatchback 4WD CJXB		Propshaft	PS900584
	2012.10-2014.05		Front	Hatchback 4WD CJXB		Flexible Coupling	537626
	2012.10-2014.05		Rear	Hatchback 4WD CJXB		Flexible Coupling	533882
	2012.10-2014.05		Front	Hatchback 4WD CJXB		Flexible Coupling Kit	537626S
	2012.10-2014.05		Rear	Hatchback 4WD CJXB		Flexible Coupling Kit	533882S



	 YEAR	TRANSM.	FITTING POSITION	BODY STYLE & DRIVE TYPE & ENGINE	REMARKS	 PRODUCT	GSP Ref.
AUDI							
S3 Sportback Quattro							
2.0 (210 kw)	2014.05-2016.08		Front	Hatchback 4WD CJXF		Flexible Coupling	537626
	2014.05-2016.08		Rear	Hatchback 4WD CJXF		Flexible Coupling	533882
	2014.05-2016.08		Front	Hatchback 4WD CJXF		Flexible Coupling Kit	537626S
	2014.05-2016.08		Rear	Hatchback 4WD CJXF		Flexible Coupling Kit	533882S
2.0 (213 kw)	2016.07-2020.10		Front	Hatchback 4WD CJXD/DJHB		Flexible Coupling	537626
	2016.07-2020.10		Rear	Hatchback 4WD CJXD/DJHB		Flexible Coupling	533882
	2016.07-2020.10		Front	Hatchback 4WD CJXD/DJHB		Flexible Coupling Kit	537626S
2.0 (221 kw)	2013.05-2020.10		Rear	Hatchback 4WD CJXD/DJHB		Flexible Coupling Kit	533882S
	2013.05-2020.10		Front	Hatchback 4WD CJXC/DNUE		Flexible Coupling	537626
	2013.05-2020.10		Rear	Hatchback 4WD CJXC/DNUE		Flexible Coupling	533882
	2013.05-2020.10		Front	Hatchback 4WD CJXC/DNUE		Flexible Coupling Kit	537626S
2.0 (228 kw)	2013.05-2020.10		Rear	Hatchback 4WD CJXC/DNUE		Flexible Coupling Kit	533882S
	2016.06-2020.10		Rear	Hatchback 4WD CJXG/DJHA		Propshaft	PS900585
	2016.06-2020.10		Front	Hatchback 4WD CJXG/DJHA		Flexible Coupling	537626
	2016.06-2020.10		Rear	Hatchback 4WD CJXG/DJHA		Flexible Coupling	533882
2.0 (228 kw)	2016.06-2020.10		Front	Hatchback 4WD CJXG/DJHA		Flexible Coupling Kit	537626S
	2016.06-2020.10		Rear	Hatchback 4WD CJXG/DJHA		Flexible Coupling Kit	533882S
	2016.06-2020.10		Front	Hatchback 4WD CJXG/DJHA		Flexible Coupling Kit	537626S
	2016.06-2020.10		Rear	Hatchback 4WD CJXG/DJHA		Flexible Coupling Kit	533882S
S4 Quattro							
3.0 (245 kw)	2009.03-2015.12	7AT	-	Estate 4WD CAKA/CBA/CGW/CJGX/CJREC/CTUB	Date From:2010.06	Propshaft	PS900103
	2009.03-2015.12	7AT	-	Saloon 4WD CAKA/CBA/CGW/CJGX/CJREC/CTUB	Date From:2010.06	Propshaft	PS900103
S6 Quattro							
4.0 (309 kw)	2012.04-2015.04	7AT	Rear	Estate 4WD CEUC	Date To:2015.04,for PR code:G1D	Propshaft	PS900581
	2012.04-2015.04	7AT	Rear	Saloon 4WD CEUC	Date To:2015.04,for PR code:G1D	Propshaft	PS900581
4.0 (331 kw)	2014.10-2018.09	7AT	Rear	Estate 4WD CTGE	for PR code:G1D	Propshaft	PS900581
	2014.10-2018.09	7AT	Rear	Saloon 4WD CTGE	for PR code:G1D	Propshaft	PS900581
S7 Sportback Quattro							
4.0 (309 kw)	2012.02-2015.03	7AT	Rear	Hatchback 4WD CEUC	Date From:2013.01,for PR code:G1D	Propshaft	PS900581
4.0 (331 kw)	2014.07-2018.05	7AT	Rear	Hatchback 4WD CTGE		Propshaft	PS900581
SQ5 Quattro							
3.0 (230 kw)	2012.12-2015.11	8AT	Rear	SUV 4WD CGQB/CVUC		Propshaft	PS900108
	2012.12-2015.11		Rear	SUV 4WD CGQB/CVUC		Joint,propshaft	661093
3.0 (240 kw)	2015.04-2017.05	8AT	Rear	SUV 4WD CVUB		Propshaft	PS900108
3.0 (250 kw)	2015.11-2017.05	8AT	Rear	SUV 4WD DEHA		Propshaft	PS900108
3.0 (260 kw)	2013.05-2017.05	8AT	Rear	SUV 4WD CTUD/CTXA		Propshaft	PS900108
	2013.05-2017.05		-	SUV 4WD CTUD/CTXA		Joint,propshaft	661093
TT Quattro							
1.8 (132 kw)	1998.10-2006.06		Front	Cabriolet 4WD AJQ/ARY/AUQ		Flexible Coupling	537626
	1998.10-2006.06		Front	Coupe 4WD AJQ/ARY/ATC/AUQ		Flexible Coupling	537626
1.8 (134 kw)	1999.09-2006.06		Front	Coupe AWD AWP		Flexible Coupling	537626
	2000.09-2002.08		Front	Cabriolet 4WD AWP		Flexible Coupling	537626
1.8 (140 kw)	2005.09-2006.06		Front	Cabriolet 4WD BVR		Flexible Coupling	537626
	2005.09-2006.06		Front	Coupe 4WD BVR		Flexible Coupling	537626
1.8 (165 kw)	1998.10-2006.06		Front	Cabriolet 4WD APX/BAM		Flexible Coupling	537626
	1998.10-2006.06		Front	Coupe 4WD APX/BAM		Flexible Coupling	537626
1.8 (168 kw)	2000.01-2002.12		Front	Coupe 4WD AMU		Flexible Coupling	537626
1.8 (180 kw)	2005.03-2006.06		Front	Coupe 4WD BFV		Flexible Coupling	537626
2.0 (135 kw)	2017.01-		Front	Cabriolet 4WD CUNA		Flexible Coupling	537626
	2017.01-		Front	Coupe 4WD CUNA		Flexible Coupling	537626
	2017.01-		Rear	Cabriolet 4WD CUNA		Flexible Coupling	533882
	2017.01-		Rear	Coupe 4WD CUNA		Flexible Coupling	533882
	2017.01-		Front	Cabriolet 4WD CUNA		Flexible Coupling Kit	537626S
	2017.01-		Front	Coupe 4WD CUNA		Flexible Coupling Kit	537626S
	2017.01-		Rear	Cabriolet 4WD CUNA		Flexible Coupling Kit	533882S
	2017.01-		Rear	Coupe 4WD CUNA		Flexible Coupling Kit	533882S
2.0 (162 kw)	2015.04-		Front	Coupe 4WD CNTC		Flexible Coupling	537626
	2015.04-		Front	Cabriolet 4WD CNTC		Flexible Coupling	537626
	2015.04-		Rear	Coupe 4WD CNTC		Flexible Coupling	533882
	2015.04-		Rear	Cabriolet 4WD CNTC		Flexible Coupling	533882
	2015.04-		Front	Coupe 4WD CNTC		Flexible Coupling Kit	537626S
	2015.04-		Front	Cabriolet 4WD CNTC		Flexible Coupling Kit	537626S
	2015.04-		Rear	Coupe 4WD CNTC		Flexible Coupling Kit	533882S
2.0 (169 kw)	2015.04-		Rear	Cabriolet 4WD CNTC		Flexible Coupling Kit	533882S
	2014.07-		Front	Coupe 4WD CHHC		Flexible Coupling	537626
	2014.07-		Rear	Coupe 4WD CHHC		Flexible Coupling	533882



	 YEAR	TRANSM.	FITTING POSITION	BODY STYLE & DRIVE TYPE & ENGINE	REMARKS	 PRODUCT	GSP Ref.
AUDI							
TT Quattro							
2.0 (169 kw)	2014.07-		Front	Coupe 4WD CHHC		Flexible Coupling Kit	537626S
	2014.07-		Rear	Coupe 4WD CHHC		Flexible Coupling Kit	533882S
	2014.11-		Front	Cabriolet 4WD CHHC		Flexible Coupling	537626
	2014.11-		Rear	Cabriolet 4WD CHHC		Flexible Coupling	533882
	2014.11-		Front	Cabriolet 4WD CHHC		Flexible Coupling Kit	537626S
	2014.11-		Rear	Cabriolet 4WD CHHC		Flexible Coupling Kit	533882S
3.2 (184 kw)	2003.07-2006.12		Front	Cabriolet 4WD BHE/BPF		Flexible Coupling	537626
	2003.07-2006.12		Front	Coupe 4WD BHE/BPF		Flexible Coupling	537626
TTS Quattro							
2.0 (210 kw)	2015.02-		Front	Coupe 4WD CJXF		Flexible Coupling	537626
	2015.02-		Front	Cabriolet 4WD CJXF		Flexible Coupling	537626
	2015.02-		Rear	Coupe 4WD CJXF		Flexible Coupling	533882
	2015.02-		Rear	Cabriolet 4WD CJXF		Flexible Coupling	533882
	2015.02-		Front	Coupe 4WD CJXF		Flexible Coupling Kit	537626S
	2015.02-		Front	Cabriolet 4WD CJXF		Flexible Coupling Kit	537626S
	2015.02-		Rear	Coupe 4WD CJXF		Flexible Coupling Kit	533882S
	2015.02-		Rear	Cabriolet 4WD CJXF		Flexible Coupling Kit	533882S
2.0 (215 kw)	2015.07-		Front	Coupe 4WD CYFB		Flexible Coupling	537626
	2015.07-		Rear	Coupe 4WD CYFB		Flexible Coupling	533882
	2015.07-		Front	Coupe 4WD CYFB		Flexible Coupling Kit	537626S
	2015.07-		Rear	Coupe 4WD CYFB		Flexible Coupling Kit	533882S
2.0 (228 kw)	2014.11-		Front	Cabriolet 4WD CJXG		Flexible Coupling	537626
	2014.11-		Front	Coupe 4WD CJXG		Flexible Coupling	537626
	2014.11-		Rear	Cabriolet 4WD CJXG		Flexible Coupling	533882
	2014.11-		Rear	Coupe 4WD CJXG		Flexible Coupling	533882
	2014.11-		Front	Cabriolet 4WD CJXG		Flexible Coupling Kit	537626S
	2014.11-		Front	Coupe 4WD CJXG		Flexible Coupling Kit	537626S
	2014.11-		Rear	Cabriolet 4WD CJXG		Flexible Coupling Kit	533882S
	2014.11-		Rear	Coupe 4WD CJXG		Flexible Coupling Kit	533882S
AUDI (FAW)							
A6L Quattro							
2.8 (162 kw)	2009.06-2011.12		Rear	Saloon 4WD CCEA		Propshaft	PS900572
3.0 (160 kw)	2005.03-2006.12		Rear	Saloon 4WD BBJ		Propshaft	PS900572
3.0 (213 kw)	2008.11-2011.12		Rear	Saloon 4WD CAJA		Propshaft	PS900572
3.2 (188 kw)	2006.11-2008.08		Rear	Saloon 4WD AUK		Propshaft	PS900572
4.2 (246 kw)	2004.08-2011.12		Rear	Saloon 4WD BAT		Propshaft	PS900572
4.2 (257 kw)	2006.11-2008.10		Rear	Saloon 4WD BVJ		Propshaft	PS900572
BMW							
114d							
1.5 (70 kw)	2015.06-		Front	Hatchback RWD B37D15A		Flexible Coupling	510596
	2015.06-		Front	Hatchback RWD B37D15A		Flexible Coupling Kit	510596S
	2015.06-		Rear	Hatchback RWD B37D15A		Flexible Coupling Kit	537625S
	2015.07-2019.06		Front	Hatchback RWD B37D15A		Flexible Coupling	510596
	2015.07-2019.06		Front	Hatchback RWD B37D15A		Flexible Coupling Kit	510596S
	2015.07-2019.06		Rear	Hatchback RWD B37D15A		Flexible Coupling Kit	537625S
1.6 (70 kw)	2012.07-		Front	Hatchback RWD N47D16A		Flexible Coupling	510596
	2012.07-		Rear	Hatchback RWD N47D16A		Flexible Coupling	537625
	2012.07-		Front	Hatchback RWD N47D16A		Flexible Coupling Kit	510596S
	2012.07-		Rear	Hatchback RWD N47D16A		Flexible Coupling Kit	537625S
	2012.11-2015.06		Front	Hatchback RWD N47D16A		Flexible Coupling	510596
	2012.11-2015.06		Rear	Hatchback RWD N47D16A		Flexible Coupling	537625
	2012.11-2015.06		Front	Hatchback RWD N47D16A		Flexible Coupling Kit	510596S
	2012.11-2015.06		Rear	Hatchback RWD N47D16A		Flexible Coupling Kit	537625S
114i							
1.6 (75 kw)	2011.11-		Front	Hatchback RWD N13B16A		Flexible Coupling	510597
	2011.11-		Rear	Hatchback RWD N13B16A		Flexible Coupling	537625
	2011.11-		Rear	Hatchback RWD N13B16A		Flexible Coupling Kit	537625S
	2012.07-2015.02		Front	Hatchback RWD N13B16A		Flexible Coupling	510597
	2012.07-2015.02		Rear	Hatchback RWD N13B16A		Flexible Coupling	537625
	2012.07-2015.02		Rear	Hatchback RWD N13B16A		Flexible Coupling Kit	537625S
116d							
1.5 (85 kw)	2015.03-		Front	Hatchback RWD B37D15A		Flexible Coupling	510596
	2015.03-		Front	Hatchback RWD B37D15A		Flexible Coupling Kit	510596S
	2015.03-		Rear	Hatchback RWD B37D15A		Flexible Coupling Kit	537625S



	 YEAR	TRANSM.	FITTING POSITION	BODY STYLE & DRIVE TYPE & ENGINE	REMARKS	 PRODUCT	GSP Ref.	
BMW 116d								
1.5 (85 kw)	2015.03-2019.06		Front	Hatchback RWD B37D15A		Flexible Coupling	510596	
	2015.03-2019.06		Front	Hatchback RWD B37D15A		Flexible Coupling Kit	510596S	
	2015.03-2019.06		Rear	Hatchback RWD B37D15A		Flexible Coupling Kit	537625S	
1.6 (85 kw)	2012.02-2015.02		Front	Hatchback RWD N47D16A		Flexible Coupling	510596	
	2012.02-2015.02		Rear	Hatchback RWD N47D16A		Flexible Coupling	537625	
	2012.02-2015.02		Front	Hatchback RWD N47D16A		Flexible Coupling Kit	510596S	
	2012.02-2015.02		Rear	Hatchback RWD N47D16A		Flexible Coupling Kit	537625S	
	2012.03-2015.02		Front	Hatchback RWD N47D16A		Flexible Coupling	510596	
	2012.03-2015.02		Rear	Hatchback RWD N47D16A		Flexible Coupling	537625	
	2012.03-2015.02		Front	Hatchback RWD N47D16A		Flexible Coupling Kit	510596S	
	2012.03-2015.02		Rear	Hatchback RWD N47D16A		Flexible Coupling Kit	537625S	
2.0 (66 kw)	2011.01-2011.12		Front	Hatchback RWD N47D20C		Flexible Coupling	510596	
	2011.01-2011.12		Rear	Hatchback RWD N47D20C		Flexible Coupling	533878	
	2011.01-2011.12		Front	Hatchback RWD N47D20C		Flexible Coupling Kit	510596S	
2.0 (85 kw)	2009.03-2011.06	MT	Rear	Hatchback RWD N47D20A/N47D20C		Propshaft	PS900610	
	2009.03-2011.06		Centre	Hatchback RWD N47D20A/N47D20C		Center Bearing Support	530151	
	2009.03-2011.06		Front	Hatchback RWD N47D20A/N47D20C		Flexible Coupling	510596	
	2009.03-2011.06		Rear	Hatchback RWD N47D20A/N47D20C		Flexible Coupling	533878	
	2009.03-2011.06		Front	Hatchback RWD N47D20A/N47D20C		Flexible Coupling Kit	510596S	
	2009.03-2012.09	MT	Rear	Hatchback RWD N47D20A/N47D20C		Propshaft	PS900610	
	2009.03-2012.09		Centre	Hatchback RWD N47D20A/N47D20C		Center Bearing Support	530151	
	2009.03-2012.09		Front	Hatchback RWD N47D20A/N47D20C		Flexible Coupling	510596	
	2009.03-2012.09		Rear	Hatchback RWD N47D20A/N47D20C		Flexible Coupling	533878	
	2009.03-2012.09		Front	Hatchback RWD N47D20A/N47D20C		Flexible Coupling Kit	510596S	
	2011.06-2015.02		Front	Hatchback RWD N47D20C		Flexible Coupling	510596	
	2011.06-2015.02		Rear	Hatchback RWD N47D20C		Flexible Coupling	537625	
	2011.06-2015.02		Front	Hatchback RWD N47D20C		Flexible Coupling Kit	510596S	
	2011.06-2015.02		Rear	Hatchback RWD N47D20C		Flexible Coupling Kit	537625S	
	2011.07-2015.02		Front	Hatchback RWD N47D20C		Flexible Coupling	510596	
	2011.07-2015.02		Rear	Hatchback RWD N47D20C		Flexible Coupling	537625	
	2011.07-2015.02		Front	Hatchback RWD N47D20C		Flexible Coupling Kit	510596S	
	2011.07-2015.02		Rear	Hatchback RWD N47D20C		Flexible Coupling Kit	537625S	
	116i							
	1.5 (80 kw)	2015.03-		Rear	Hatchback RWD B38B15A		Flexible Coupling	537625
2015.03-			Front	Hatchback RWD B38B15A		Flexible Coupling Kit	510596S	
2015.03-			Rear	Hatchback RWD B38B15A		Flexible Coupling Kit	537625S	
2015.03-2019.06			Rear	Hatchback RWD B38B15A		Flexible Coupling	537625	
2015.03-2019.06			Front	Hatchback RWD B38B15A		Flexible Coupling Kit	510596S	
2015.03-2019.06			Rear	Hatchback RWD B38B15A		Flexible Coupling Kit	537625S	
2015.03-2019.06			Front	Hatchback RWD B38B15A		Flexible Coupling Kit	510596S	
1.6 (85 kw)	2004.06-2011.06		Centre	Hatchback RWD N45B16A		Center Bearing Support	530151	
	2004.06-2011.06		Front	Hatchback RWD N45B16A		Flexible Coupling	510596	
	2004.06-2011.06		Front	Hatchback RWD N45B16A		Flexible Coupling	510641	
	2004.06-2011.06		Front	Hatchback RWD N45B16A		Flexible Coupling Kit	510596S	
	2004.06-2011.06		Front	Hatchback RWD N45B16A		Flexible Coupling Kit	510641S	
	2007.09-2011.12		Centre	Hatchback RWD N45B16A		Center Bearing Support	530151	
	2007.09-2011.12		Front	Hatchback RWD N45B16A		Flexible Coupling	510596	
	2007.09-2011.12		Front	Hatchback RWD N45B16A		Flexible Coupling	510641	
	2007.09-2011.12		Front	Hatchback RWD N45B16A		Flexible Coupling Kit	510596S	
	2007.09-2011.12		Front	Hatchback RWD N45B16A		Flexible Coupling Kit	510641S	
1.6 (90 kw)	2007.03-2011.12		Centre	Hatchback RWD N43B16AA		Center Bearing Support	530151	
	2007.03-2011.12		Front	Hatchback RWD N43B16AA		Flexible Coupling	510596	
	2007.03-2011.12		Front	Hatchback RWD N43B16AA		Flexible Coupling	510641	
	2007.03-2011.12		Front	Hatchback RWD N43B16AA		Flexible Coupling Kit	510596S	
	2007.03-2011.12		Front	Hatchback RWD N43B16AA		Flexible Coupling Kit	510641S	
	2007.09-2011.06		Centre	Hatchback RWD N43B16AA		Center Bearing Support	530151	
	2007.09-2011.06		Front	Hatchback RWD N43B16AA		Flexible Coupling	510596	
	2007.09-2011.06		Front	Hatchback RWD N43B16AA		Flexible Coupling	510641	
	2007.09-2011.06		Front	Hatchback RWD N43B16AA		Flexible Coupling Kit	510596S	
	2007.09-2011.06		Front	Hatchback RWD N43B16AA		Flexible Coupling Kit	510641S	
1.6 (100 kw)	2011.07-2015.02		Front	Hatchback RWD N13B16A		Flexible Coupling	510596	
	2011.07-2015.02		Front	Hatchback RWD N13B16A		Flexible Coupling	510597	
	2011.07-2015.02		Rear	Hatchback RWD N13B16A		Flexible Coupling	537625	
	2011.07-2015.02		Front	Hatchback RWD N13B16A		Flexible Coupling Kit	510596S	
	2011.07-2015.02		Rear	Hatchback RWD N13B16A		Flexible Coupling Kit	537625S	
	2011.07-2015.02		Rear	Hatchback RWD N13B16A		Flexible Coupling Kit	537625S	



	 YEAR	TRANSM.	FITTING POSITION	BODY STYLE & DRIVE TYPE & ENGINE	REMARKS	 PRODUCT	GSP Ref.	
BMW								
116i								
1.6 (100 kw)	2011.12-2015.02		Front	Hatchback RWD N13B16A		Flexible Coupling	510596	
	2011.12-2015.02		Front	Hatchback RWD N13B16A		Flexible Coupling	510597	
	2011.12-2015.02		Rear	Hatchback RWD N13B16A		Flexible Coupling	537625	
	2011.12-2015.02		Front	Hatchback RWD N13B16A		Flexible Coupling Kit	510596S	
	2011.12-2015.02		Rear	Hatchback RWD N13B16A		Flexible Coupling Kit	537625S	
2.0 (90 kw)	2007.10-2012.09		Centre	Hatchback RWD N43B20A		Center Bearing Support	530151	
	2007.10-2012.09		Front	Hatchback RWD N43B20A		Flexible Coupling	510596	
	2007.10-2012.09		Front	Hatchback RWD N43B20A		Flexible Coupling	510641	
	2007.10-2012.09		Front	Hatchback RWD N43B20A		Flexible Coupling Kit	510596S	
	2007.10-2012.09		Front	Hatchback RWD N43B20A		Flexible Coupling Kit	510641S	
	2009.01-2012.09		Centre	Hatchback RWD N43B20A		Center Bearing Support	530151	
	2009.01-2012.09		Front	Hatchback RWD N43B20A		Flexible Coupling	510596	
	2009.01-2012.09		Front	Hatchback RWD N43B20A		Flexible Coupling	510641	
	2009.01-2012.09		Front	Hatchback RWD N43B20A		Flexible Coupling Kit	510596S	
	2009.01-2012.09		Front	Hatchback RWD N43B20A		Flexible Coupling Kit	510641S	
118d								
2.0 (90 kw)	2004.06-2007.02		Centre	Hatchback RWD M47D204D4		Center Bearing Support	530151	
	2004.06-2007.02		Front	Hatchback RWD M47D204D4		Flexible Coupling	510596	
	2004.06-2007.02		Front	Hatchback RWD M47D204D4		Flexible Coupling Kit	510596S	
2.0 (100 kw)	2006.09-2012.09	MT	Rear	Hatchback RWD N47D20C		Propshaft	PS900610	
	2006.09-2012.09		Front	Hatchback RWD N47D20C		Flexible Coupling	510596	
	2006.09-2012.09		Rear	Hatchback RWD N47D20C		Flexible Coupling	533878	
	2007.03-2011.06	MT	Rear	Hatchback RWD N47D20A/N47D20C		Propshaft	PS900610	
	2007.03-2011.06		Front	Hatchback RWD N47D20A/N47D20C		Flexible Coupling	510596	
	2007.03-2011.06		Rear	Hatchback RWD N47D20A/N47D20C		Flexible Coupling	533878	
	2007.03-2011.06		Front	Hatchback RWD N47D20A/N47D20C		Flexible Coupling Kit	510596S	
	2011.07-2019.06	AT	Rear	Hatchback RWD B47D20A/N47D20C	Date From:2012.01	Propshaft	PS900611	
	2011.07-2019.06		Front	Hatchback RWD B47D20A/N47D20C		Flexible Coupling	510596	
	2011.07-2019.06		Rear	Hatchback RWD B47D20A/N47D20C		Flexible Coupling	537625	
	2011.07-2019.06		Front	Hatchback RWD B47D20A/N47D20C		Flexible Coupling Kit	510596S	
	2011.07-2019.06		Rear	Hatchback RWD B47D20A/N47D20C		Flexible Coupling Kit	537625S	
	2011.12-		Front	Hatchback RWD B47D20A/N47D20C		Flexible Coupling	510596	
	2011.12-		Rear	Hatchback RWD B47D20A/N47D20C		Flexible Coupling	537625	
	2011.12-		Front	Hatchback RWD B47D20A/N47D20C		Flexible Coupling Kit	510596S	
	2011.12-		Rear	Hatchback RWD B47D20A/N47D20C		Flexible Coupling Kit	537625S	
2.0 (105 kw)	2007.03-2011.06	MT	Rear	Hatchback RWD N47D20A/N47D20C		Propshaft	PS900610	
	2007.03-2011.06		Centre	Hatchback RWD N47D20A/N47D20C		Center Bearing Support	530151	
	2007.03-2011.06		Front	Hatchback RWD N47D20A/N47D20C		Flexible Coupling	510596	
	2007.03-2011.06		Rear	Hatchback RWD N47D20A/N47D20C		Flexible Coupling	533878	
	2007.03-2011.06		Front	Hatchback RWD N47D20A/N47D20C		Flexible Coupling Kit	510596S	
	2007.03-2012.09	MT	Rear	Hatchback RWD N47D20A/N47D20C		Propshaft	PS900610	
	2007.03-2012.09		Centre	Hatchback RWD N47D20A/N47D20C		Center Bearing Support	530151	
	2007.03-2012.09		Front	Hatchback RWD N47D20A/N47D20C		Flexible Coupling	510596	
	2007.03-2012.09		Rear	Hatchback RWD N47D20A/N47D20C		Flexible Coupling	533878	
	2007.03-2012.09		Front	Hatchback RWD N47D20A/N47D20C		Flexible Coupling Kit	510596S	
	2011.06-2015.02		Front	Hatchback RWD N47D20C		Flexible Coupling	510596	
	2011.06-2015.02		Rear	Hatchback RWD N47D20C		Flexible Coupling	537625	
	2011.06-2015.02		Front	Hatchback RWD N47D20C		Flexible Coupling Kit	510596S	
	2011.06-2015.02		Rear	Hatchback RWD N47D20C		Flexible Coupling Kit	537625S	
	2011.07-2015.02		Front	Hatchback RWD N47D20C		Flexible Coupling	510596	
	2011.07-2015.02		Rear	Hatchback RWD N47D20C		Flexible Coupling	537625	
	2011.07-2015.02		Front	Hatchback RWD N47D20C		Flexible Coupling Kit	510596S	
	2011.07-2015.02		Rear	Hatchback RWD N47D20C		Flexible Coupling Kit	537625S	
	2.0 (110 kw)	2015.03-	AT	Rear	Hatchback RWD B47D20A		Propshaft	PS900611
		2015.03-		Front	Hatchback RWD B47D20A		Flexible Coupling	510596
2015.03-			Rear	Hatchback RWD B47D20A		Flexible Coupling	537625	
2015.03-			Front	Hatchback RWD B47D20A		Flexible Coupling Kit	510596S	
2015.03-			Rear	Hatchback RWD B47D20A		Flexible Coupling Kit	537625S	
2015.03-2019.06		AT	Rear	Hatchback RWD B47D20A		Propshaft	PS900611	
2015.03-2019.06			Front	Hatchback RWD B47D20A		Flexible Coupling	510596	
2015.03-2019.06			Rear	Hatchback RWD B47D20A		Flexible Coupling	537625	
2015.03-2019.06			Front	Hatchback RWD B47D20A		Flexible Coupling Kit	510596S	
2015.03-2019.06			Rear	Hatchback RWD B47D20A		Flexible Coupling Kit	537625S	



	 YEAR	TRANSM.	FITTING POSITION	BODY STYLE & DRIVE TYPE & ENGINE	REMARKS	 PRODUCT	GSP Ref.
BMW							
118d Cabrio							
2.0 (100 kw)	2008.09-2013.12	MT	Rear	Cabriolet RWD N47D20A		Propshaft	PS900610
	2008.09-2013.12		Front	Cabriolet RWD N47D20A		Flexible Coupling	510596
	2008.09-2013.12		Rear	Cabriolet RWD N47D20A		Flexible Coupling	533878
2.0 (105 kw)	2008.09-2013.12	MT	Rear	Cabriolet RWD N47D20A/N47D20C		Propshaft	PS900610
	2008.09-2013.12		Centre	Cabriolet RWD N47D20A/N47D20C		Center Bearing Support	530151
	2008.09-2013.12		Front	Cabriolet RWD N47D20A/N47D20C		Flexible Coupling	510596
	2008.09-2013.12		Rear	Cabriolet RWD N47D20A/N47D20C		Flexible Coupling	533878
	2008.09-2013.12		Front	Cabriolet RWD N47D20A/N47D20C		Flexible Coupling Kit	510596S
118d Coupe							
2.0 (100 kw)	2009.09-2013.10	MT	Rear	Coupe RWD N47D20C		Propshaft	PS900610
	2009.09-2013.10		Front	Coupe RWD N47D20C		Flexible Coupling	510596
	2009.09-2013.10		Rear	Coupe RWD N47D20C		Flexible Coupling	533878
2.0 (105 kw)	2009.09-2013.10	MT	Rear	Coupe RWD N47D20C		Propshaft	PS900610
	2009.09-2013.10		Centre	Coupe RWD N47D20C		Center Bearing Support	530151
	2009.09-2013.10		Front	Coupe RWD N47D20C		Flexible Coupling	510596
	2009.09-2013.10		Rear	Coupe RWD N47D20C		Flexible Coupling	533878
	2009.09-2013.10		Front	Coupe RWD N47D20C		Flexible Coupling Kit	510596S
118d xDrive							
2.0 (105 kw)	2013.07-2015.02		Rear	Hatchback 4WD N47D20C		Flexible Coupling	537625
	2013.07-2015.02		Front;Rear	Hatchback 4WD N47D20C		Flexible Coupling	517955
	2013.07-2015.02		Front	Hatchback 4WD N47D20C		Flexible Coupling Kit	517955S
	2013.07-2015.02		Rear	Hatchback 4WD N47D20C		Flexible Coupling Kit	537625S
2.0 (110 kw)	2015.03-		Front	Hatchback 4WD B47D20A		Flexible Coupling	510596
	2015.03-		Front;Rear	Hatchback 4WD B47D20A		Flexible Coupling	517955
	2015.03-		Rear	Hatchback 4WD B47D20A		Flexible Coupling Kit	537625S
	2015.03-2019.06		Front	Hatchback 4WD B47D20A		Flexible Coupling	510596
	2015.03-2019.06		Rear	Hatchback 4WD B47D20A		Flexible Coupling	537625
	2015.03-2019.06		Front;Rear	Hatchback 4WD B47D20A		Flexible Coupling	517955
	2015.03-2019.06		Front	Hatchback 4WD B47D20A		Flexible Coupling Kit	517955S
	2015.03-2019.06		Rear	Hatchback 4WD B47D20A		Flexible Coupling Kit	537625S
118i							
1.5 (100 kw)	2015.03-		Front	Hatchback RWD B38B15A		Flexible Coupling	510596
	2015.03-		Rear	Hatchback RWD B38B15A		Flexible Coupling	537625
	2015.03-		Front	Hatchback RWD B38B15A		Flexible Coupling Kit	510596S
	2015.03-		Rear	Hatchback RWD B38B15A		Flexible Coupling Kit	537625S
	2015.07-2019.06		Front	Hatchback RWD B38B15A		Flexible Coupling	510596
	2015.07-2019.06		Rear	Hatchback RWD B38B15A		Flexible Coupling	537625
	2015.07-2019.06		Front	Hatchback RWD B38B15A		Flexible Coupling Kit	510596S
	2015.07-2019.06		Rear	Hatchback RWD B38B15A		Flexible Coupling Kit	537625S
1.6 (100 kw)	2015.03-		Front	Hatchback RWD N13B16A		Flexible Coupling	510596
	2015.03-		Rear	Hatchback RWD N13B16A		Flexible Coupling	537625
	2015.03-		Front	Hatchback RWD N13B16A		Flexible Coupling Kit	510596S
	2015.03-		Rear	Hatchback RWD N13B16A		Flexible Coupling Kit	537625S
	2015.03-2015.06		Front	Hatchback RWD N13B16A		Flexible Coupling	510596
	2015.03-2015.06		Rear	Hatchback RWD N13B16A		Flexible Coupling	537625
	2015.03-2015.06		Front	Hatchback RWD N13B16A		Flexible Coupling Kit	510596S
	2015.03-2015.06		Rear	Hatchback RWD N13B16A		Flexible Coupling Kit	537625S
1.6 (125 kw)	2011.06-		Front	Hatchback RWD N13B16A		Flexible Coupling	510596
	2011.06-		Front	Hatchback RWD N13B16A		Flexible Coupling	510597
	2011.06-		Rear	Hatchback RWD N13B16A		Flexible Coupling	537625
	2011.06-		Front	Hatchback RWD N13B16A		Flexible Coupling Kit	510596S
	2011.06-		Rear	Hatchback RWD N13B16A		Flexible Coupling Kit	537625S
	2011.06-2015.11		Front	Hatchback RWD N13B16A		Flexible Coupling	510596
	2011.06-2015.11		Front	Hatchback RWD N13B16A		Flexible Coupling	510597
	2011.06-2015.11		Rear	Hatchback RWD N13B16A		Flexible Coupling	537625
	2011.06-2015.11		Front	Hatchback RWD N13B16A		Flexible Coupling Kit	510596S
	2011.06-2015.11		Rear	Hatchback RWD N13B16A		Flexible Coupling Kit	537625S
2.0 (95 kw)	2004.07-2008.02		Centre	Hatchback RWD N46B20B		Center Bearing Support	530151
	2004.07-2008.02		Front	Hatchback RWD N46B20B		Flexible Coupling	510596
	2004.07-2008.02		Front	Hatchback RWD N46B20B		Flexible Coupling	510641
	2004.07-2008.02		Front	Hatchback RWD N46B20B		Flexible Coupling Kit	510596S
	2004.07-2008.02		Front	Hatchback RWD N46B20B		Flexible Coupling Kit	510641S
	2004.09-2008.02		Centre	Hatchback RWD N46B20B		Center Bearing Support	530151
	2004.09-2008.02		Front	Hatchback RWD N46B20B		Flexible Coupling	510596



	 YEAR	TRANSM.	FITTING POSITION	BODY STYLE & DRIVE TYPE & ENGINE	REMARKS	 PRODUCT	GSP Ref.
BMW							
118i							
2.0 (95 kw)	2004.09-2008.02		Front	Hatchback RWD N46B20B		Flexible Coupling	510641
	2004.09-2008.02		Front	Hatchback RWD N46B20B		Flexible Coupling Kit	510596S
	2004.09-2008.02		Front	Hatchback RWD N46B20B		Flexible Coupling Kit	510641S
2.0 (100 kw)	2006.09-2011.12		Front	Hatchback RWD N46B20B		Flexible Coupling	510596
	2006.10-2012.09		Centre	Hatchback RWD N46B20B		Center Bearing Support	530151
	2006.10-2012.09		Front	Hatchback RWD N46B20B		Flexible Coupling	510596
	2006.10-2012.09		Front	Hatchback RWD N46B20B		Flexible Coupling	510641
	2006.10-2012.09		Front	Hatchback RWD N46B20B		Flexible Coupling Kit	510596S
2.0 (105 kw)	2006.10-2012.09		Front	Hatchback RWD N46B20B		Flexible Coupling Kit	510641S
	2006.09-2012.09		Centre	Hatchback RWD N43B20A		Center Bearing Support	530151
	2006.09-2012.09		Front	Hatchback RWD N43B20A		Flexible Coupling	510596
	2006.09-2012.09		Front	Hatchback RWD N43B20A		Flexible Coupling	510641
	2006.09-2012.09		Front	Hatchback RWD N43B20A		Flexible Coupling Kit	510596S
	2006.09-2012.09		Front	Hatchback RWD N43B20A		Flexible Coupling Kit	510641S
	2007.03-2012.09		Centre	Hatchback RWD N43B20A		Center Bearing Support	530151
	2007.03-2012.09		Front	Hatchback RWD N43B20A		Flexible Coupling	510596
	2007.03-2012.09		Front	Hatchback RWD N43B20A		Flexible Coupling	510641
	2007.03-2012.09		Front	Hatchback RWD N43B20A		Flexible Coupling Kit	510596S
2.0 (125 kw)	2007.03-2012.09		Front	Hatchback RWD N43B20A		Flexible Coupling Kit	510641S
	2007.03-2012.12		Front	Hatchback RWD N43B20A		Flexible Coupling	510596
	2007.03-2012.12		Front	Hatchback RWD N43B20A		Flexible Coupling Kit	510596S
118i Cabrio							
2.0 (100 kw)	2008.09-2013.12		Front	Cabriolet RWD N46B20B		Flexible Coupling	510596
	2008.09-2013.12		Front	Cabriolet RWD N46B20B		Flexible Coupling	510641
	2008.09-2013.12		Front	Cabriolet RWD N46B20B		Flexible Coupling Kit	510596S
	2008.09-2013.12		Front	Cabriolet RWD N46B20B		Flexible Coupling Kit	510641S
2.0 (105 kw)	2007.09-		Centre	Cabriolet RWD N43B20A		Center Bearing Support	530151
	2007.09-		Front	Cabriolet RWD N43B20A		Flexible Coupling	510596
	2007.09-		Front	Cabriolet RWD N43B20A		Flexible Coupling	510641
	2007.09-		Front	Cabriolet RWD N43B20A		Flexible Coupling Kit	510596S
	2007.09-		Front	Cabriolet RWD N43B20A		Flexible Coupling Kit	510641S
120d							
2.0 (110 kw)	2004.06-2007.02		Front	Hatchback RWD M47D204D4		Flexible Coupling	510596
	2004.06-2007.02		Rear	Hatchback RWD M47D204D4		Flexible Coupling	533878
	2004.06-2007.02		Front	Hatchback RWD M47D204D4		Flexible Coupling Kit	510596S
2.0 (115 kw)	2006.05-2007.02		Front	Hatchback RWD M47 D20(204D4)		Flexible Coupling Kit	510596S
2.0 (120 kw)	2004.06-2011.06		Centre	Hatchback RWD M47D204D4/N47D20A		Center Bearing Support	530151
	2004.06-2011.06		Front	Hatchback RWD M47D204D4/N47D20A		Flexible Coupling	510596
	2004.06-2011.06		Rear	Hatchback RWD M47D204D4/N47D20A		Flexible Coupling	533878
	2004.06-2011.06		Front	Hatchback RWD M47D204D4/N47D20A		Flexible Coupling Kit	510596S
	2007.03-2011.12	MT	Rear	Hatchback RWD N47D20A/N47D20C		Propshaft	PS900613
	2007.03-2011.12		Centre	Hatchback RWD N47D20A/N47D20C		Center Bearing Support	530151
	2007.03-2011.12		Front	Hatchback RWD N47D20A/N47D20C		Flexible Coupling	510596
	2007.03-2011.12		Rear	Hatchback RWD N47D20A/N47D20C		Flexible Coupling	533878
	2007.03-2011.12		Front;Rear	Hatchback RWD N47D20A/N47D20C		Flexible Coupling	517955
	2007.03-2011.12		Front	Hatchback RWD N47D20A/N47D20C		Flexible Coupling Kit	510596S
	2011.07-2019.06	AT	Rear	Hatchback RWD B47D20A/N47D20C	Date From:2012.01	Propshaft	PS900611
	2011.07-2019.06		Front	Hatchback RWD B47D20A/N47D20C		Flexible Coupling	510596
	2011.07-2019.06		Rear	Hatchback RWD B47D20A/N47D20C		Flexible Coupling	537625
	2011.07-2019.06		Front;Rear	Hatchback RWD B47D20A/N47D20C		Flexible Coupling	517955
	2011.07-2019.06		Front	Hatchback RWD B47D20A/N47D20C		Flexible Coupling Kit	510596S
	2011.07-2019.06		Front	Hatchback RWD B47D20A/N47D20C		Flexible Coupling Kit	517955S
	2011.07-2019.06		Rear	Hatchback RWD B47D20A/N47D20C		Flexible Coupling Kit	537625S
	2013.07-		Front	Hatchback RWD B47D20A/N47D20C		Flexible Coupling	510596
	2013.07-		Rear	Hatchback RWD B47D20A/N47D20C		Flexible Coupling	537625
	2013.07-		Front;Rear	Hatchback RWD B47D20A/N47D20C		Flexible Coupling	517955
2013.07-		Front	Hatchback RWD B47D20A/N47D20C		Flexible Coupling Kit	510596S	
2013.07-		Front	Hatchback RWD B47D20A/N47D20C		Flexible Coupling Kit	517955S	
2013.07-		Rear	Hatchback RWD B47D20A/N47D20C		Flexible Coupling Kit	537625S	
2.0 (125 kw)	2007.03-2010.10		Front	Hatchback RWD N47 D20 A		Flexible Coupling Kit	510596S
2.0 (130 kw)	2007.03-2011.06		Centre	Hatchback RWD N47D20A/N47D20C		Center Bearing Support	530151
	2007.03-2011.06		Front	Hatchback RWD N47D20A/N47D20C		Flexible Coupling	510596
	2007.03-2011.06		Rear	Hatchback RWD N47D20A/N47D20C		Flexible Coupling	533878
	2007.03-2011.06		Front;Rear	Hatchback RWD N47D20A/N47D20C		Flexible Coupling	517955



	 YEAR	TRANSM.	FITTING POSITION	BODY STYLE & DRIVE TYPE & ENGINE	REMARKS	 PRODUCT	GSP Ref.
BMW							
120d							
2.0 (130 kw)	2007.03-2011.06		Front	Hatchback RWD N47D20A/N47D20C		Flexible Coupling Kit	510596S
	2007.03-2011.06		Front	Hatchback RWD N47D20A/N47D20C		Flexible Coupling Kit	517955S
	2007.03-2011.12	MT	Rear	Hatchback RWD N47D20A/N47D20C		Propshaft	PS900613
	2007.03-2011.12		Centre	Hatchback RWD N47D20A/N47D20C		Center Bearing Support	530151
	2007.03-2011.12		Front	Hatchback RWD N47D20A/N47D20C		Flexible Coupling	510596
	2007.03-2011.12		Rear	Hatchback RWD N47D20A/N47D20C		Flexible Coupling	533878
	2007.03-2011.12		Front;Rear	Hatchback RWD N47D20A/N47D20C		Flexible Coupling	517955
2.0 (135 kw)	2011.07-2015.02		Front	Hatchback RWD N47D20C		Flexible Coupling	510596
	2011.07-2015.02		Rear	Hatchback RWD N47D20C		Flexible Coupling	537625
	2011.07-2015.02		Front;Rear	Hatchback RWD N47D20C		Flexible Coupling	517955
	2011.07-2015.02		Front	Hatchback RWD N47D20C		Flexible Coupling Kit	510596S
	2011.07-2015.02		Front	Hatchback RWD N47D20C		Flexible Coupling Kit	517955S
	2011.07-2015.02		Rear	Hatchback RWD N47D20C		Flexible Coupling Kit	537625S
	2012.08-2015.02		Front	Hatchback RWD N47D20C		Flexible Coupling	510596
	2012.08-2015.02		Rear	Hatchback RWD N47D20C		Flexible Coupling	537625
	2012.08-2015.02		Front;Rear	Hatchback RWD N47D20C		Flexible Coupling	517955
	2012.08-2015.02		Front	Hatchback RWD N47D20C		Flexible Coupling Kit	510596S
	2012.08-2015.02		Front	Hatchback RWD N47D20C		Flexible Coupling Kit	517955S
2.0 (140 kw)	2015.03-	AT	Rear	Hatchback RWD B47D20A		Propshaft	PS900611
	2015.03-		Front	Hatchback RWD B47D20A		Flexible Coupling	510596
	2015.03-		Rear	Hatchback RWD B47D20A		Flexible Coupling	537625
	2015.03-		Front	Hatchback RWD B47D20A		Flexible Coupling Kit	510596S
	2015.03-		Rear	Hatchback RWD B47D20A		Flexible Coupling Kit	537625S
	2015.03-2019.06	AT	Rear	Hatchback RWD B47D20A		Propshaft	PS900611
	2015.03-2019.06		Front	Hatchback RWD B47D20A		Flexible Coupling	510596
	2015.03-2019.06		Rear	Hatchback RWD B47D20A		Flexible Coupling	537625
	2015.03-2019.06		Front	Hatchback RWD B47D20A		Flexible Coupling Kit	510596S
	2015.03-2019.06		Rear	Hatchback RWD B47D20A		Flexible Coupling Kit	537625S
2.0 (145 kw)	2007.03-2011.12		Centre	Hatchback RWD N47D20A/N47D20C		Center Bearing Support	530151
	2007.03-2011.12		Front	Hatchback RWD N47D20A/N47D20C		Flexible Coupling	510596
	2007.03-2011.12		Rear	Hatchback RWD N47D20A/N47D20C		Flexible Coupling	533878
	2007.03-2011.12		Front;Rear	Hatchback RWD N47D20A/N47D20C		Flexible Coupling	517955
	2007.03-2011.12		Front	Hatchback RWD N47D20A/N47D20C		Flexible Coupling Kit	510596S
2.0 (147 kw)	2011.07-2015.02		Front	Hatchback RWD N47D20C		Flexible Coupling	510596
	2011.07-2015.02		Rear	Hatchback RWD N47D20C		Flexible Coupling	537625
	2011.07-2015.02		Front;Rear	Hatchback RWD N47D20C		Flexible Coupling	517955
	2011.07-2015.02		Front	Hatchback RWD N47D20C		Flexible Coupling Kit	510596S
	2011.07-2015.02		Front	Hatchback RWD N47D20C		Flexible Coupling Kit	517955S
	2011.07-2015.02		Rear	Hatchback RWD N47D20C		Flexible Coupling Kit	537625S
	2012.01-2015.02		Front	Hatchback RWD N47D20C		Flexible Coupling	510596
	2012.01-2015.02		Rear	Hatchback RWD N47D20C		Flexible Coupling	537625
	2012.01-2015.02		Front;Rear	Hatchback RWD N47D20C		Flexible Coupling	517955
	2012.01-2015.02		Front	Hatchback RWD N47D20C		Flexible Coupling Kit	510596S
	2012.01-2015.02		Front	Hatchback RWD N47D20C		Flexible Coupling Kit	517955S
	2012.01-2015.02		Rear	Hatchback RWD N47D20C		Flexible Coupling Kit	537625S
	120d Cabrio						
2.0 (120 kw)	2008.03-2013.12	MT	Rear	Cabriolet RWD N47D20A		Propshaft	PS900613
	2008.03-2013.12		Rear	Cabriolet RWD N47D20A		Flexible Coupling	533878
	2008.03-2013.12		Front;Rear	Cabriolet RWD N47D20A		Flexible Coupling	517955
	2008.03-2013.12		Front	Cabriolet RWD N47D20A		Flexible Coupling Kit	517955S
2.0 (130 kw)	2008.03-2013.12	MT	Rear	Cabriolet RWD N47D20A/N47D20C		Propshaft	PS900613
	2008.03-2013.12		Centre	Cabriolet RWD N47D20A/N47D20C		Center Bearing Support	530151
	2008.03-2013.12		Front	Cabriolet RWD N47D20A/N47D20C		Flexible Coupling	510596
	2008.03-2013.12		Rear	Cabriolet RWD N47D20A/N47D20C		Flexible Coupling	533878
	2008.03-2013.12		Front;Rear	Cabriolet RWD N47D20A/N47D20C		Flexible Coupling	517955
	2008.03-2013.12		Front	Cabriolet RWD N47D20A/N47D20C		Flexible Coupling Kit	510596S
	2008.03-2013.12		Front	Cabriolet RWD N47D20A/N47D20C		Flexible Coupling Kit	517955S
	2008.03-2013.12		Front	Cabriolet RWD N47D20A/N47D20C		Flexible Coupling Kit	517955S
2.0 (145 kw)	2008.03-2012.12		Rear	Cabriolet RWD N47D20C		Flexible Coupling	533878
	2008.03-2012.12		Front;Rear	Cabriolet RWD N47D20C		Flexible Coupling	517955
	2008.03-2012.12		Front	Cabriolet RWD N47D20C		Flexible Coupling Kit	517955S



	 YEAR	TRANSM.	FITTING POSITION	BODY STYLE & DRIVE TYPE & ENGINE	REMARKS	 PRODUCT	GSP Ref.
BMW							
120d Coupe							
2.0 (120 kw)	2007.10-	MT	Rear	Coupe RWD N47D20A		Propshaft	PS900613
	2007.10-		Front	Coupe RWD N47D20A		Flexible Coupling	510596
	2007.10-		Rear	Coupe RWD N47D20A		Flexible Coupling	533878
	2007.10-		Front;Rear	Coupe RWD N47D20A		Flexible Coupling	517955
	2007.10-		Front	Coupe RWD N47D20A		Flexible Coupling Kit	517955S
2.0 (130 kw)	2007.09-2013.10	MT	Rear	Coupe RWD N47D20A/N47D20C		Propshaft	PS900613
	2007.09-2013.10		Centre	Coupe RWD N47D20A/N47D20C		Center Bearing Support	530151
	2007.09-2013.10		Front	Coupe RWD N47D20A/N47D20C		Flexible Coupling	510596
	2007.09-2013.10		Rear	Coupe RWD N47D20A/N47D20C		Flexible Coupling	533878
	2007.09-2013.10		Front;Rear	Coupe RWD N47D20A/N47D20C		Flexible Coupling	517955
	2007.09-2013.10		Front	Coupe RWD N47D20A/N47D20C		Flexible Coupling Kit	510596S
	2007.09-2013.10		Front	Coupe RWD N47D20A/N47D20C		Flexible Coupling Kit	517955S
2.0 (145 kw)	2007.09-2013.10		Centre	Coupe RWD N47D20A/N47D20C		Center Bearing Support	530151
	2007.09-2013.10		Front	Coupe RWD N47D20A/N47D20C		Flexible Coupling	510596
	2007.09-2013.10		Rear	Coupe RWD N47D20A/N47D20C		Flexible Coupling	533878
	2007.09-2013.10		Front;Rear	Coupe RWD N47D20A/N47D20C		Flexible Coupling	517955
	2007.09-2013.10		Front	Coupe RWD N47D20A/N47D20C		Flexible Coupling Kit	510596S
2007.09-2013.10		Front	Coupe RWD N47D20A/N47D20C		Flexible Coupling Kit	517955S	
120d xDrive							
2.0 (135 kw)	2012.02-2015.02		Rear	Hatchback 4WD N47D20C		Flexible Coupling	537625
	2012.02-2015.02		Front;Rear	Hatchback 4WD N47D20C		Flexible Coupling	517955
	2012.02-2015.02		Rear	Hatchback 4WD N47D20C		Flexible Coupling Kit	537625S
	2012.11-2015.02		Rear	Hatchback 4WD N47D20C		Flexible Coupling	537625
	2012.11-2015.02		Front;Rear	Hatchback 4WD N47D20C		Flexible Coupling	517955
	2012.11-2015.02		Front	Hatchback 4WD N47D20C		Flexible Coupling Kit	517955S
	2012.11-2015.02		Rear	Hatchback 4WD N47D20C		Flexible Coupling Kit	537625S
2.0 (140 kw)	2015.03-		Front	Hatchback 4WD B47D20A		Flexible Coupling	510596
	2015.03-		Rear	Hatchback 4WD B47D20A		Flexible Coupling	537625
	2015.03-		Front;Rear	Hatchback 4WD B47D20A		Flexible Coupling	517955
	2015.03-		Rear	Hatchback 4WD B47D20A		Flexible Coupling Kit	537625S
	2015.03-2019.06		Front	Hatchback 4WD B47D20A		Flexible Coupling	510596
	2015.03-2019.06		Rear	Hatchback 4WD B47D20A		Flexible Coupling	537625
	2015.03-2019.06		Front;Rear	Hatchback 4WD B47D20A		Flexible Coupling	517955
	2015.03-2019.06		Front	Hatchback 4WD B47D20A		Flexible Coupling Kit	517955S
	2015.03-2019.06		Rear	Hatchback 4WD B47D20A		Flexible Coupling Kit	537625S
2019.07-		Front	Hatchback 4WD B47C20B		Flexible Coupling	510597	
2.0 (147 kw)	2012.02-2015.02		Rear	Hatchback 4WD N47D20C		Flexible Coupling	537625
	2012.02-2015.02		Front;Rear	Hatchback 4WD N47D20C		Flexible Coupling	517955
	2012.02-2015.02		Rear	Hatchback 4WD N47D20C		Flexible Coupling Kit	537625S
	2012.11-2015.02		Rear	Hatchback 4WD N47D20C		Flexible Coupling	537625
	2012.11-2015.02		Front;Rear	Hatchback 4WD N47D20C		Flexible Coupling	517955
	2012.11-2015.02		Front	Hatchback 4WD N47D20C		Flexible Coupling Kit	517955S
2012.11-2015.02		Rear	Hatchback 4WD N47D20C		Flexible Coupling Kit	537625S	
120i							
1.6 (130 kw)	2015.03-		Front	Hatchback RWD N13B16A		Flexible Coupling	510596
	2015.03-		Rear	Hatchback RWD N13B16A		Flexible Coupling	537625
	2015.03-		Front	Hatchback RWD N13B16A		Flexible Coupling Kit	510596S
	2015.03-		Rear	Hatchback RWD N13B16A		Flexible Coupling Kit	537625S
	2015.03-2016.06		Front	Hatchback RWD N13B16A		Flexible Coupling	510596
	2015.03-2016.06		Rear	Hatchback RWD N13B16A		Flexible Coupling	537625
	2015.03-2016.06		Front	Hatchback RWD N13B16A		Flexible Coupling Kit	510596S
	2015.03-2016.06		Rear	Hatchback RWD N13B16A		Flexible Coupling Kit	537625S
2.0 (110 kw)	2004.06-2007.02		Centre	Hatchback RWD N46B20B/N46B20C		Center Bearing Support	530151
	2004.06-2007.02		Front	Hatchback RWD N46B20B/N46B20C		Flexible Coupling	510596
	2004.06-2007.02		Front	Hatchback RWD N46B20B/N46B20C		Flexible Coupling	510641
	2004.06-2007.02		Front	Hatchback RWD N46B20B/N46B20C		Flexible Coupling Kit	510596S
	2004.06-2007.02		Front	Hatchback RWD N46B20B/N46B20C		Flexible Coupling Kit	510641S
2.0 (115 kw)	2007.03-2011.06		Centre	Hatchback RWD N46B20B/N46B20C		Center Bearing Support	530151
	2007.03-2011.06		Front	Hatchback RWD N46B20B/N46B20C		Flexible Coupling	510596
	2007.03-2011.06		Front	Hatchback RWD N46B20B/N46B20C		Flexible Coupling	510641
	2007.03-2011.06		Front	Hatchback RWD N46B20B/N46B20C		Flexible Coupling Kit	510596S
	2007.03-2011.06		Front	Hatchback RWD N46B20B/N46B20C		Flexible Coupling Kit	510641S
	2007.03-2011.12		Centre	Hatchback RWD N46B20B/N46B20C		Center Bearing Support	530151
	2007.03-2011.12		Front	Hatchback RWD N46B20B/N46B20C		Flexible Coupling	510596



	 YEAR	TRANSM.	FITTING POSITION	BODY STYLE & DRIVE TYPE & ENGINE	REMARKS	 PRODUCT	GSP Ref.
BMW 120i							
2.0 (115 kw)	2007.03-2011.12		Front	Hatchback RWD N46B20B/N46B20C		Flexible Coupling	510641
	2007.03-2011.12		Front	Hatchback RWD N46B20B/N46B20C		Flexible Coupling Kit	510596S
	2007.03-2011.12		Front	Hatchback RWD N46B20B/N46B20C		Flexible Coupling Kit	510641S
2.0 (120 kw)	2007.03-2011.06		Front	Hatchback RWD N43B20A		Flexible Coupling	510596
	2007.03-2011.06		Front	Hatchback RWD N43B20A		Flexible Coupling	510641
	2007.03-2011.06		Front	Hatchback RWD N43B20A		Flexible Coupling Kit	510596S
	2007.03-2012.09		Front	Hatchback RWD N43B20A		Flexible Coupling	510596
	2007.03-2012.09		Front	Hatchback RWD N43B20A		Flexible Coupling	510641
2.0 (125 kw)	2007.03-2011.06		Centre	Hatchback RWD N43B20A		Center Bearing Support	530151
	2007.03-2011.06		Front	Hatchback RWD N43B20A		Flexible Coupling	510596
	2007.03-2011.06		Front	Hatchback RWD N43B20A		Flexible Coupling	510641
	2007.03-2011.06		Front	Hatchback RWD N43B20A		Flexible Coupling Kit	510596S
	2007.03-2011.06		Front	Hatchback RWD N43B20A		Flexible Coupling Kit	510641S
	2007.03-2012.09		Centre	Hatchback RWD N43B20A		Center Bearing Support	530151
	2007.03-2012.09		Front	Hatchback RWD N43B20A		Flexible Coupling	510596
	2007.03-2012.09		Front	Hatchback RWD N43B20A		Flexible Coupling	510641
	2007.03-2012.09		Front	Hatchback RWD N43B20A		Flexible Coupling Kit	510596S
2.0 (135 kw)	2016.07-		Front	Hatchback RWD B48B20A		Flexible Coupling	510596
	2016.07-		Rear	Hatchback RWD B48B20A		Flexible Coupling	537625
	2016.07-		Front	Hatchback RWD B48B20A		Flexible Coupling Kit	510596S
	2016.07-		Rear	Hatchback RWD B48B20A		Flexible Coupling Kit	537625S
	2016.07-2019.06		Front	Hatchback RWD B48B20A		Flexible Coupling	510596
	2016.07-2019.06		Rear	Hatchback RWD B48B20A		Flexible Coupling	537625
	2016.07-2019.06		Front	Hatchback RWD B48B20A		Flexible Coupling Kit	510596S
	2016.07-2019.06		Rear	Hatchback RWD B48B20A		Flexible Coupling Kit	537625S
120i Cabrio							
2.0 (115 kw)	2008.03-2013.12		Centre	Cabriolet RWD N46B20B/N46B20C		Center Bearing Support	530151
	2008.03-2013.12		Front	Cabriolet RWD N46B20B/N46B20C		Flexible Coupling	510596
	2008.03-2013.12		Front	Cabriolet RWD N46B20B/N46B20C		Flexible Coupling	510641
	2008.03-2013.12		Front	Cabriolet RWD N46B20B/N46B20C		Flexible Coupling Kit	510596S
	2008.03-2013.12		Front	Cabriolet RWD N46B20B/N46B20C		Flexible Coupling Kit	510641S
2.0 (120 kw)	2008.03-2013.12		Front	Cabriolet RWD N43B20A		Flexible Coupling	510596
	2008.03-2013.12		Front	Cabriolet RWD N43B20A		Flexible Coupling	510641
2.0 (125 kw)	2007.12-2013.10		Centre	Cabriolet RWD N43B20A		Center Bearing Support	530151
	2007.12-2013.10		Front	Cabriolet RWD N43B20A		Flexible Coupling	510596
	2007.12-2013.10		Front	Cabriolet RWD N43B20A		Flexible Coupling	510641
	2007.12-2013.10		Front	Cabriolet RWD N43B20A		Flexible Coupling Kit	510596S
	2007.12-2013.10		Front	Cabriolet RWD N43B20A		Flexible Coupling Kit	510641S
120i Coupe							
2.0 (115 kw)	2009.09-2013.10		Centre	Coupe RWD N46B20B/N46B20C		Center Bearing Support	530151
	2009.09-2013.10		Front	Coupe RWD N46B20B/N46B20C		Flexible Coupling	510596
	2009.09-2013.10		Front	Coupe RWD N46B20B/N46B20C		Flexible Coupling	510641
	2009.09-2013.10		Front	Coupe RWD N46B20B/N46B20C		Flexible Coupling Kit	510596S
	2009.09-2013.10		Front	Coupe RWD N46B20B/N46B20C		Flexible Coupling Kit	510641S
2.0 (125 kw)	2009.06-		Centre	Coupe RWD N43B20A		Center Bearing Support	530151
	2009.06-		Front	Coupe RWD N43B20A		Flexible Coupling	510596
	2009.06-		Front	Coupe RWD N43B20A		Flexible Coupling	510641
	2009.06-		Front	Coupe RWD N43B20A		Flexible Coupling Kit	510596S
	2009.06-		Front	Coupe RWD N43B20A		Flexible Coupling Kit	510641S
123d							
2.0 (150 kw)	2007.07-2011.06		Centre	Hatchback RWD N47D20B/N47D20D		Center Bearing Support	530151
	2007.07-2011.06		Centre	Hatchback RWD N47D20B/N47D20D		Center Bearing Support	530152
	2007.07-2011.06		Front	Hatchback RWD N47D20B/N47D20D		Flexible Coupling	530758
	2007.07-2011.06		Front;Rear	Hatchback RWD N47D20B/N47D20D		Flexible Coupling	517955
	2007.07-2011.06		Front;Rear	Hatchback RWD N47D20B/N47D20D		Flexible Coupling	537668
	2007.07-2011.06		Front	Hatchback RWD N47D20B/N47D20D		Flexible Coupling Kit	517955S
	2007.07-2012.09		Centre	Hatchback RWD N47D20B/N47D20D		Center Bearing Support	530151
	2007.07-2012.09		Centre	Hatchback RWD N47D20B/N47D20D		Center Bearing Support	530152
	2007.07-2012.09		Front	Hatchback RWD N47D20B/N47D20D		Flexible Coupling	530758
	2007.07-2012.09		Front;Rear	Hatchback RWD N47D20B/N47D20D		Flexible Coupling	517955
	2007.07-2012.09		Front;Rear	Hatchback RWD N47D20B/N47D20D		Flexible Coupling	537668
	2007.07-2012.09		Front	Hatchback RWD N47D20B/N47D20D		Flexible Coupling Kit	517955S



	 YEAR	TRANSM.	FITTING POSITION	BODY STYLE & DRIVE TYPE & ENGINE	REMARKS	 PRODUCT	GSP Ref.
BMW							
123d Cabrio							
2.0 (150 kw)	2008.09-2013.12		Centre	Cabriolet RWD N47D20B/N47D20D		Center Bearing Support	530151
	2008.09-2013.12		Centre	Cabriolet RWD N47D20B/N47D20D		Center Bearing Support	530152
	2008.09-2013.12		Front	Cabriolet RWD N47D20B/N47D20D		Flexible Coupling	530758
	2008.09-2013.12		Front;Rear	Cabriolet RWD N47D20B/N47D20D		Flexible Coupling	517955
	2008.09-2013.12		Front;Rear	Cabriolet RWD N47D20B/N47D20D		Flexible Coupling	537668
	2008.09-2013.12		Front	Cabriolet RWD N47D20B/N47D20D		Flexible Coupling Kit	517955S
123d Coupe							
2.0 (150 kw)	2007.09-		Centre	Coupe RWD N47D20B/N47D20D		Center Bearing Support	530151
	2007.09-		Centre	Coupe RWD N47D20B/N47D20D		Center Bearing Support	530152
	2007.09-		Front	Coupe RWD N47D20B/N47D20D		Flexible Coupling	530758
	2007.09-		Front;Rear	Coupe RWD N47D20B/N47D20D		Flexible Coupling	517955
	2007.09-		Front;Rear	Coupe RWD N47D20B/N47D20D		Flexible Coupling	537668
	2007.09-		Front	Coupe RWD N47D20B/N47D20D		Flexible Coupling Kit	517955S
125d							
2.0 (155 kw)	2011.12-		Front;Rear	Hatchback RWD B47D20B/N47D20D		Flexible Coupling	517955
	2011.12-		Front	Hatchback RWD B47D20B/N47D20D		Flexible Coupling Kit	517955S
	2012.03-2019.06		Front;Rear	Hatchback RWD B47D20B/N47D20D		Flexible Coupling	517955
	2012.03-2019.06		Front	Hatchback RWD B47D20B/N47D20D		Flexible Coupling Kit	517955S
2.0 (160 kw)	2012.02-2015.02		Front	Hatchback RWD N47D20D		Flexible Coupling	537631
	2012.02-2015.02		Front;Rear	Hatchback RWD N47D20D		Flexible Coupling	517955
	2012.02-2015.02		Front	Hatchback RWD N47D20D		Flexible Coupling Kit	517955S
	2012.03-2015.02		Front	Hatchback RWD N47D20D		Flexible Coupling	537631
	2012.03-2015.02		Front;Rear	Hatchback RWD N47D20D		Flexible Coupling	517955
	2012.03-2015.02		Front	Hatchback RWD N47D20D		Flexible Coupling Kit	517955S
2.0 (165 kw)	2015.03-		Front;Rear	Hatchback RWD B47D20B		Flexible Coupling	517955
	2015.03-		Front	Hatchback RWD B47D20B		Flexible Coupling Kit	517955S
	2015.03-2019.06		Front;Rear	Hatchback RWD B47D20B		Flexible Coupling	517955
	2015.03-2019.06		Front	Hatchback RWD B47D20B		Flexible Coupling Kit	517955S
125i							
2.0 (160 kw)	2011.12-2019.12		Front	Hatchback RWD N20B20A		Flexible Coupling	510596
	2011.12-2019.12		Rear	Hatchback RWD N20B20A		Flexible Coupling	537625
	2011.12-2019.12		Front	Hatchback RWD N20B20A		Flexible Coupling Kit	510596S
	2011.12-2019.12		Rear	Hatchback RWD N20B20A		Flexible Coupling Kit	537625S
	2012.03-2017.11		Front	Hatchback RWD N20B20A		Flexible Coupling	510596
	2012.03-2017.11		Rear	Hatchback RWD N20B20A		Flexible Coupling	537625
	2012.03-2017.11		Front	Hatchback RWD N20B20A		Flexible Coupling Kit	510596S
	2012.03-2017.11		Rear	Hatchback RWD N20B20A		Flexible Coupling Kit	537625S
2.0 (165 kw)	2015.10-		Front	Hatchback RWD B48B20B		Flexible Coupling	510596
	2015.10-		Rear	Hatchback RWD B48B20B		Flexible Coupling	537625
	2015.10-		Front	Hatchback RWD B48B20B		Flexible Coupling Kit	510596S
	2015.10-		Rear	Hatchback RWD B48B20B		Flexible Coupling Kit	537625S
	2016.07-2019.06		Front	Hatchback RWD B48B20B		Flexible Coupling	510596
	2016.07-2019.06		Rear	Hatchback RWD B48B20B		Flexible Coupling	537625
	2016.07-2019.06		Front	Hatchback RWD B48B20B		Flexible Coupling Kit	510596S
	2016.07-2019.06		Rear	Hatchback RWD B48B20B		Flexible Coupling Kit	537625S
2.0 (175 kw)	2012.03-2017.11		Front	Hatchback RWD N20B20A		Flexible Coupling	510596
	2012.03-2017.11		Rear	Hatchback RWD N20B20A		Flexible Coupling	537625
	2012.03-2017.11		Front	Hatchback RWD N20B20A		Flexible Coupling Kit	510596S
	2012.03-2017.11		Rear	Hatchback RWD N20B20A		Flexible Coupling Kit	537625S
	2012.07-		Front	Hatchback RWD N20B20A		Flexible Coupling	510596
	2012.07-		Rear	Hatchback RWD N20B20A		Flexible Coupling	537625
	2012.07-		Front	Hatchback RWD N20B20A		Flexible Coupling Kit	510596S
	2012.07-		Rear	Hatchback RWD N20B20A		Flexible Coupling Kit	537625S
125i Cabrio							
3.0 (160 kw)	2007.12-2013.10		Centre	Cabriolet RWD N52B30A/N52B30B/N52B30BF		Center Bearing Support	530151
	2007.12-2013.10		Front	Cabriolet RWD N52B30A/N52B30B/N52B30BF		Flexible Coupling	510596
	2007.12-2013.10		Front	Cabriolet RWD N52B30A/N52B30B/N52B30BF		Flexible Coupling Kit	510596S
125i Coupe							
3.0 (160 kw)	2008.03-2013.10		Centre	Coupe RWD N52B30A/N52B30B/N52B30BF		Center Bearing Support	530151
	2008.03-2013.10		Front	Coupe RWD N52B30A/N52B30B/N52B30BF		Flexible Coupling	510596
	2008.03-2013.10		Front	Coupe RWD N52B30A/N52B30B/N52B30BF		Flexible Coupling Kit	510596S
128i Cabrio							
3.0 (172 kw)	2007.12-2013.10		Front	Cabriolet RWD N52B30A		Flexible Coupling	510596

	 YEAR	TRANSM.	FITTING POSITION	BODY STYLE & DRIVE TYPE & ENGINE	REMARKS	 PRODUCT	GSP Ref.
BMW							
130i							
3.0 (190 kw)	2005.03-2012.09		Centre	Hatchback RWD N52B30A/N52B30B/N52B30BF		Center Bearing Support	530151
	2005.03-2012.09		Front	Hatchback RWD N52B30A/N52B30B/N52B30BF		Flexible Coupling	510596
	2005.03-2012.09		Rear	Hatchback RWD N52B30A/N52B30B/N52B30BF		Flexible Coupling	533878
	2005.03-2012.09		Front	Hatchback RWD N52B30A/N52B30B/N52B30BF		Flexible Coupling Kit	510596S
	2007.03-2011.06		Centre	Hatchback RWD N52B30A/N52B30B/N52B30BF		Center Bearing Support	530151
	2007.03-2011.06		Front	Hatchback RWD N52B30A/N52B30B/N52B30BF		Flexible Coupling	510596
	2007.03-2011.06		Rear	Hatchback RWD N52B30A/N52B30B/N52B30BF		Flexible Coupling	533878
	2007.03-2011.06		Front	Hatchback RWD N52B30A/N52B30B/N52B30BF		Flexible Coupling Kit	510596S
3.0 (195 kw)	2005.09-2007.02		Centre	Hatchback RWD N52B30A/N52B30BF		Center Bearing Support	530151
	2005.09-2007.02		Front	Hatchback RWD N52B30A/N52B30BF		Flexible Coupling	510596
	2005.09-2007.02		Rear	Hatchback RWD N52B30A/N52B30BF		Flexible Coupling	533878
	2005.09-2007.02		Front	Hatchback RWD N52B30A/N52B30BF		Flexible Coupling Kit	510596S
	2007.03-2012.09		Centre	Hatchback RWD N52B30A/N52B30B/N52B30BF		Center Bearing Support	530151
	2007.03-2012.09		Front	Hatchback RWD N52B30A/N52B30B/N52B30BF		Flexible Coupling	510596
	2007.03-2012.09		Rear	Hatchback RWD N52B30A/N52B30B/N52B30BF		Flexible Coupling	533878
	2007.03-2012.09		Front	Hatchback RWD N52B30A/N52B30B/N52B30BF		Flexible Coupling Kit	510596S
135i Cabrio							
3.0 (225 kw)	2008.03-2013.10		Centre	Cabriolet RWD N54B30A/N55B30A		Center Bearing Support	530151
	2008.03-2013.10		Centre	Cabriolet RWD N54B30A/N55B30A		Center Bearing Support	530152
	2008.03-2013.10		Front;Rear	Cabriolet RWD N54B30A/N55B30A		Flexible Coupling	517955
	2008.03-2013.10		Front	Cabriolet RWD N54B30A/N55B30A		Flexible Coupling Kit	517955S
3.0 (240 kw)	2008.03-2013.08		Front;Rear	Cabriolet RWD N55B30A		Flexible Coupling	517955
	2008.03-2013.08		Front	Cabriolet RWD N55B30A		Flexible Coupling Kit	517955S
135i Coupe							
3.0 (225 kw)	2007.09-2013.10		Centre	Coupe RWD N54B30A/N55B30A		Center Bearing Support	530151
	2007.09-2013.10		Centre	Coupe RWD N54B30A/N55B30A		Center Bearing Support	530152
	2007.09-2013.10		Front;Rear	Coupe RWD N54B30A/N55B30A		Flexible Coupling	517955
	2007.09-2013.10		Front	Coupe RWD N54B30A/N55B30A		Flexible Coupling Kit	517955S
3.0 (240 kw)	2007.10-2013.10		Front;Rear	Coupe RWD N55B30A		Flexible Coupling	517955
	2007.10-2013.10		Front	Coupe RWD N55B30A		Flexible Coupling Kit	517955S
218d Cabrio							
2.0 (100 kw)	2015.07-	AT	Rear	Cabriolet RWD B47D20A	Date From:2016.01	Propshaft	PS900611
	2015.07-		Front	Cabriolet RWD B47D20A		Flexible Coupling	510596
	2015.07-		Rear	Cabriolet RWD B47D20A		Flexible Coupling	537625
	2015.07-		Front	Cabriolet RWD B47D20A		Flexible Coupling Kit	510596S
	2015.07-		Rear	Cabriolet RWD B47D20A		Flexible Coupling Kit	537625S
2.0 (110 kw)	2015.07-	AT	Rear	Cabriolet RWD B47D20A	Date From:2016.01	Propshaft	PS900611
	2015.07-		Front	Cabriolet RWD B47D20A		Flexible Coupling	510596
	2015.07-		Rear	Cabriolet RWD B47D20A		Flexible Coupling	537625
	2015.07-		Front	Cabriolet RWD B47D20A		Flexible Coupling Kit	510596S
	2015.07-		Rear	Cabriolet RWD B47D20A		Flexible Coupling Kit	537625S
218d Coupe							
2.0 (100 kw)	2014.03-	AT	Rear	Coupe RWD B47D20A/N47D20C		Propshaft	PS900611
	2014.03-		Front	Coupe RWD B47D20A/N47D20C		Flexible Coupling	510596
	2014.03-		Rear	Coupe RWD B47D20A/N47D20C		Flexible Coupling	537625
	2014.03-		Front	Coupe RWD B47D20A/N47D20C		Flexible Coupling Kit	510596S
	2014.03-		Rear	Coupe RWD B47D20A/N47D20C		Flexible Coupling Kit	537625S
2.0 (105 kw)	2014.03-2015.06		Front	Coupe RWD N47D20C		Flexible Coupling	510596
	2014.03-2015.06		Rear	Coupe RWD N47D20C		Flexible Coupling	537625
	2014.03-2015.06		Front	Coupe RWD N47D20C		Flexible Coupling Kit	510596S
	2014.03-2015.06		Rear	Coupe RWD N47D20C		Flexible Coupling Kit	537625S
2.0 (110 kw)	2015.07-	AT	Rear	Coupe RWD B47D20A	Date From:2016.01	Propshaft	PS900611
	2015.07-		Front	Coupe RWD B47D20A		Flexible Coupling	510596
	2015.07-		Rear	Coupe RWD B47D20A		Flexible Coupling	537625
	2015.07-		Front	Coupe RWD B47D20A		Flexible Coupling Kit	510596S
	2015.07-		Rear	Coupe RWD B47D20A		Flexible Coupling Kit	537625S
218i Cabrio							
1.5 (100 kw)	2015.01-		Front	Cabriolet RWD B38B15A		Flexible Coupling	510596
	2015.01-		Rear	Cabriolet RWD B38B15A		Flexible Coupling	537625
	2015.01-		Front	Cabriolet RWD B38B15A		Flexible Coupling Kit	510596S
	2015.01-		Rear	Cabriolet RWD B38B15A		Flexible Coupling Kit	537625S
218i Coupe							
1.5 (100 kw)	2015.01-		Front	Coupe RWD B38B15A		Flexible Coupling	510596
	2015.01-		Rear	Coupe RWD B38B15A		Flexible Coupling	537625



	 YEAR	TRANSM.	FITTING POSITION	BODY STYLE & DRIVE TYPE & ENGINE	REMARKS	 PRODUCT	GSP Ref.
BMW							
218i Coupe							
1.5 (100 kw)	2015.01-		Front	Coupe RWD B38B15A		Flexible Coupling Kit	510596S
	2015.01-		Rear	Coupe RWD B38B15A		Flexible Coupling Kit	537625S
220d Cabrio							
2.0 (120 kw)	2014.11-	AT	Rear	Cabriolet RWD B47D20A		Propshaft	PS900611
	2014.11-		Front	Cabriolet RWD B47D20A		Flexible Coupling	510596
	2014.11-		Rear	Cabriolet RWD B47D20A		Flexible Coupling	537625
	2014.11-		Front;Rear	Cabriolet RWD B47D20A		Flexible Coupling	517955
	2014.11-		Front	Cabriolet RWD B47D20A		Flexible Coupling Kit	510596S
	2014.11-		Rear	Cabriolet RWD B47D20A		Flexible Coupling Kit	537625S
2.0 (140 kw)	2014.10-	AT	Rear	Cabriolet RWD B47D20A		Propshaft	PS900611
	2014.10-		Front	Cabriolet RWD B47D20A		Flexible Coupling	510596
	2014.10-		Rear	Cabriolet RWD B47D20A		Flexible Coupling	537625
	2014.10-		Front;Rear	Cabriolet RWD B47D20A		Flexible Coupling	517955
	2014.10-		Front	Cabriolet RWD B47D20A		Flexible Coupling Kit	510596S
	2014.10-		Rear	Cabriolet RWD B47D20A		Flexible Coupling Kit	537625S
220d Coupe							
2.0 (120 kw)	2014.11-	AT	Rear	Coupe RWD B47D20A/N47D20C	Date From:2015.01	Propshaft	PS900611
	2014.11-		Front	Coupe RWD B47D20A/N47D20C		Flexible Coupling	510596
	2014.11-		Rear	Coupe RWD B47D20A/N47D20C		Flexible Coupling	537625
	2014.11-		Front;Rear	Coupe RWD B47D20A/N47D20C		Flexible Coupling	517955
	2014.11-		Front	Coupe RWD B47D20A/N47D20C		Flexible Coupling Kit	510596S
	2014.11-		Rear	Coupe RWD B47D20A/N47D20C		Flexible Coupling Kit	537625S
2.0 (135 kw)	2013.10-		Front	Coupe RWD N47D20C		Flexible Coupling	510596
	2013.10-		Rear	Coupe RWD N47D20C		Flexible Coupling	537625
	2013.10-		Front;Rear	Coupe RWD N47D20C		Flexible Coupling	517955
	2013.10-		Front	Coupe RWD N47D20C		Flexible Coupling Kit	510596S
	2013.10-		Rear	Coupe RWD N47D20C		Flexible Coupling Kit	537625S
2.0 (140 kw)	2014.11-	AT	Rear	Coupe RWD B47D20A		Propshaft	PS900611
	2014.11-		Front	Coupe RWD B47D20A		Flexible Coupling	510596
	2014.11-		Rear	Coupe RWD B47D20A		Flexible Coupling	537625
	2014.11-		Front;Rear	Coupe RWD B47D20A		Flexible Coupling	517955
	2014.11-		Front	Coupe RWD B47D20A		Flexible Coupling Kit	510596S
	2014.11-		Rear	Coupe RWD B47D20A		Flexible Coupling Kit	537625S
2.0 (147 kw)	2014.03-		Front	Coupe RWD N47D20C		Flexible Coupling	510596
	2014.03-		Rear	Coupe RWD N47D20C		Flexible Coupling	537625
	2014.03-		Front;Rear	Coupe RWD N47D20C		Flexible Coupling	517955
	2014.03-		Front	Coupe RWD N47D20C		Flexible Coupling Kit	510596S
	2014.03-		Rear	Coupe RWD N47D20C		Flexible Coupling Kit	537625S
220d xDrive Coupe							
2.0 (120 kw)	2015.03-		Rear	Coupe 4WD B47D20A		Flexible Coupling	537625
	2015.03-		Rear	Coupe 4WD B47D20A		Flexible Coupling Kit	537625S
2.0 (140 kw)	2015.01-		Rear	Coupe 4WD B47D20A		Flexible Coupling	537625
	2015.01-		Rear	Coupe 4WD B47D20A		Flexible Coupling Kit	537625S
220d xDrive Grand Coupe							
2.0 (140 kw)	2019.11-		Front	Coupe 4WD B47C20B		Flexible Coupling	510597
	2019.11-		Front	Coupe 4WD B47C20B		Flexible Coupling Kit	510597S
220i Cabrio							
2.0 (135 kw)	2014.10-		Front	Cabriolet RWD N20B20A/N20B20B		Flexible Coupling	510596
	2014.10-		Front	Cabriolet RWD N20B20A/N20B20B		Flexible Coupling	510597
	2014.10-		Rear	Cabriolet RWD N20B20A/N20B20B		Flexible Coupling	537625
	2014.10-		Front	Cabriolet RWD N20B20A/N20B20B		Flexible Coupling Kit	510596S
	2014.10-		Rear	Cabriolet RWD N20B20A/N20B20B		Flexible Coupling Kit	537625S
	2015.09-		Front	Cabriolet RWD B48B20A		Flexible Coupling	510596
	2015.09-		Rear	Cabriolet RWD B48B20A		Flexible Coupling	537625
	2015.09-		Front	Cabriolet RWD B48B20A		Flexible Coupling Kit	510596S
	2015.09-		Rear	Cabriolet RWD B48B20A		Flexible Coupling Kit	537625S
220i Coupe							
2.0 (135 kw)	2013.10-		Front	Coupe RWD N20B20A/N20B20B		Flexible Coupling	510596
	2013.10-		Front	Coupe RWD N20B20A/N20B20B		Flexible Coupling	510597
	2013.10-		Rear	Coupe RWD N20B20A/N20B20B		Flexible Coupling	537625
	2013.10-		Front	Coupe RWD N20B20A/N20B20B		Flexible Coupling Kit	510596S
	2013.10-		Rear	Coupe RWD N20B20A/N20B20B		Flexible Coupling Kit	537625S
	2015.09-		Front	Coupe RWD B48B20A		Flexible Coupling	510596
	2015.09-		Rear	Coupe RWD B48B20A		Flexible Coupling	537625



	 YEAR	TRANSM.	FITTING POSITION	BODY STYLE & DRIVE TYPE & ENGINE	REMARKS	 PRODUCT	GSP Ref.
BMW							
220i Coupe							
2.0 (135 kw)	2015.09-		Front	Coupe RWD B48B20A		Flexible Coupling Kit	510596S
	2015.09-		Rear	Coupe RWD B48B20A		Flexible Coupling Kit	537625S
225d Cabrio							
2.0 (165 kw)	2015.07-		Front;Rear	Cabriolet RWD B47D20B		Flexible Coupling	517955
	2015.07-		Front	Cabriolet RWD B47D20B		Flexible Coupling Kit	517955S
225d Coupe							
2.0 (160 kw)	2014.01-		Front;Rear	Coupe RWD N47D20D		Flexible Coupling	517955
	2014.01-		Front	Coupe RWD N47D20D		Flexible Coupling Kit	517955S
2.0 (165 kw)	2015.07-		Front;Rear	Coupe RWD B47D20B		Flexible Coupling	517955
	2015.07-		Front	Coupe RWD B47D20B		Flexible Coupling Kit	517955S
228i Cabrio							
2.0 (180 kw)	2014.10-	AT	Rear	Cabriolet RWD N20B20A	Date From:2015.01	Propshaft	PS900611
	2014.10-		Front	Cabriolet RWD N20B20A		Flexible Coupling	510596
	2014.10-		Rear	Cabriolet RWD N20B20A		Flexible Coupling	537625
	2014.10-		Front;Rear	Cabriolet RWD N20B20A		Flexible Coupling	517955
	2014.10-		Front	Cabriolet RWD N20B20A		Flexible Coupling Kit	510596S
	2014.10-		Front	Cabriolet RWD N20B20A		Flexible Coupling Kit	517955S
	2014.10-		Rear	Cabriolet RWD N20B20A		Flexible Coupling Kit	537625S
228i Coupe							
2.0 (180 kw)	2014.07-		Front	Coupe RWD N20B20A		Flexible Coupling	510596
	2014.07-		Rear	Coupe RWD N20B20A		Flexible Coupling	537625
	2014.07-		Front	Coupe RWD N20B20A		Flexible Coupling Kit	510596S
	2014.07-		Rear	Coupe RWD N20B20A		Flexible Coupling Kit	537625S
228i xDrive Gran Coupe							
2.0 (170 kw)	2019.11-		Front	Coupe AWD B46A20B		Flexible Coupling Kit	510597S
230i Cabrio							
2.0 (185 kw)	2016.07-		Front	Cabriolet RWD B48B20B		Flexible Coupling	510596
	2016.07-		Rear	Cabriolet RWD B48B20B		Flexible Coupling	537625
	2016.07-		Front	Cabriolet RWD B48B20B		Flexible Coupling Kit	510596S
	2016.07-		Rear	Cabriolet RWD B48B20B		Flexible Coupling Kit	537625S
230i Coupe							
2.0 (185 kw)	2016.07-		Front	Coupe RWD B48B20B		Flexible Coupling	510596
	2016.07-		Rear	Coupe RWD B48B20B		Flexible Coupling	537625
	2016.07-		Front	Coupe RWD B48B20B		Flexible Coupling Kit	510596S
	2016.07-		Rear	Coupe RWD B48B20B		Flexible Coupling Kit	537625S
3 ActiveHybrid							
3.0 (225 kw)	2012.07-2015.06		Front;Rear	Saloon RWD N55B30A		Flexible Coupling	517955
	2012.07-2015.06		Front	Saloon RWD N55B30A		Flexible Coupling Kit	517955S
316d							
2.0 (85 kw)	2009.07-2011.12		Centre	Saloon RWD N47D20C		Center Bearing Support	530151
	2009.07-2011.12		Front	Saloon RWD N47D20C		Flexible Coupling	510596
	2009.07-2011.12		Rear	Saloon RWD N47D20C		Flexible Coupling	533878
	2009.07-2011.12		Front	Saloon RWD N47D20C		Flexible Coupling Kit	510596S
	2012.03-2018.10		Centre	Saloon RWD B47D20A/N47D20C		Center Bearing Support	530151
	2012.03-2018.10		Front	Saloon RWD B47D20A/N47D20C		Flexible Coupling	510596
	2012.03-2018.10		Rear	Saloon RWD B47D20A/N47D20C		Flexible Coupling	537625
	2012.03-2018.10		Front	Saloon RWD B47D20A/N47D20C		Flexible Coupling Kit	510596S
	2012.03-2018.10		Rear	Saloon RWD B47D20A/N47D20C		Flexible Coupling Kit	537625S
	316d Touring						
2.0 (85 kw)	2009.09-2012.10		Front	Estate RWD N47D20C		Flexible Coupling	510596
	2009.09-2012.10		Rear	Estate RWD N47D20C		Flexible Coupling	533878
	2009.09-2012.10		Front	Estate RWD N47D20C		Flexible Coupling Kit	510596S
	2012.11-2019.06		Front	Estate RWD B47D20A/N47D20C		Flexible Coupling	510596
	2012.11-2019.06		Rear	Estate RWD B47D20A/N47D20C		Flexible Coupling	537625
	2012.11-2019.06		Front	Estate RWD B47D20A/N47D20C		Flexible Coupling Kit	510596S
	2012.11-2019.06		Rear	Estate RWD B47D20A/N47D20C		Flexible Coupling Kit	537625S
316i							
1.6 (73 kw)	1991.03-1993.08		Centre	Saloon RWD M40B164E1		Center Bearing Support	510659
	1991.03-1993.08		Front	Saloon RWD M40B164E1		Flexible Coupling	510597
	1991.03-1993.08		Front	Saloon RWD M40B164E1		Flexible Coupling	510641
	1991.03-1993.08		Front	Saloon RWD M40B164E1		Flexible Coupling Kit	510597S
1.6 (75 kw)	1993.09-1998.05		Centre	Saloon RWD M43B164E2		Center Bearing Support	510659
	1993.09-1998.05		Front	Saloon RWD M43B164E2		Flexible Coupling	510597
	1993.09-1998.05		Front	Saloon RWD M43B164E2		Flexible Coupling	510641



	 YEAR	TRANSM.	FITTING POSITION	BODY STYLE & DRIVE TYPE & ENGINE	REMARKS	 PRODUCT	GSP Ref.
BMW 316i							
1.6 (77 kw)	2000.04-2005.02		Centre	Saloon RWD M43B164E3		Center Bearing Support	512301
	2000.04-2005.02		Front	Saloon RWD M43B164E3		Flexible Coupling	510597
	2000.04-2005.02		Front	Saloon RWD M43B164E3		Flexible Coupling Kit	510597S
1.6 (85 kw)	2002.06-2005.02		Centre	Saloon RWD N40B16A/N45B16A		Center Bearing Support	510659
	2002.06-2005.02		Centre	Saloon RWD N40B16A/N45B16A		Center Bearing Support	530154
	2002.06-2005.02		Front	Saloon RWD N40B16A/N45B16A		Flexible Coupling	510641
	2002.06-2005.02		Front	Saloon RWD N40B16A/N45B16A		Flexible Coupling Kit	510641S
	2005.09-2011.10	AT	Rear	Saloon RWD N45B16A/N45B16AC	Date From:2006.01	Propshaft	PS900125
	2005.09-2011.10		Centre	Saloon RWD N45B16A/N45B16AC		Center Bearing Support	530151
	2005.09-2011.10		Front	Saloon RWD N45B16A/N45B16AC		Flexible Coupling	510596
	2005.09-2011.10		Front	Saloon RWD N45B16A/N45B16AC		Flexible Coupling	510641
	2005.09-2011.10		Front	Saloon RWD N45B16A/N45B16AC		Flexible Coupling Kit	510596S
	2005.09-2011.10		Front	Saloon RWD N45B16A/N45B16AC		Flexible Coupling Kit	510641S
1.6 (90 kw)	2007.09-2011.10	AT	Rear	Saloon RWD N43B16A/N43B16AA		Propshaft	PS900125
	2007.09-2011.10		Centre	Saloon RWD N43B16A/N43B16AA		Center Bearing Support	530151
	2007.09-2011.10		Front	Saloon RWD N43B16A/N43B16AA		Flexible Coupling	510596
	2007.09-2011.10		Front	Saloon RWD N43B16A/N43B16AA		Flexible Coupling	510641
	2007.09-2011.10		Front	Saloon RWD N43B16A/N43B16AA		Flexible Coupling Kit	510596S
	2007.09-2011.10		Front	Saloon RWD N43B16A/N43B16AA		Flexible Coupling Kit	510641S
1.6 (100 kw)	2012.07-2016.08		Centre	Saloon RWD N13B16A		Center Bearing Support	530151
	2012.07-2016.08		Front	Saloon RWD N13B16A		Flexible Coupling	510596
	2012.07-2016.08		Front	Saloon RWD N13B16A		Flexible Coupling	510597
	2012.07-2016.08		Rear	Saloon RWD N13B16A		Flexible Coupling	537625
	2012.07-2016.08		Front	Saloon RWD N13B16A		Flexible Coupling Kit	510596S
	2012.07-2016.08		Rear	Saloon RWD N13B16A		Flexible Coupling Kit	537625S
1.8 (85 kw)	2001.07-2005.02	AT	Rear	Saloon RWD N42B18A/N46B18A		Propshaft	PS900116
	2001.07-2005.02		Centre	Saloon RWD N42B18A/N46B18A	AT	Center Bearing Support	512301
	2001.07-2005.02		Centre	Saloon RWD N42B18A/N46B18A	MT	Center Bearing Support	530154
	2001.07-2005.02		Front	Saloon RWD N42B18A/N46B18A	AT	Flexible Coupling	510596
	2001.07-2005.02		Front	Saloon RWD N42B18A/N46B18A	MT	Flexible Coupling	510597
	2001.07-2005.02		Front	Saloon RWD N42B18A/N46B18A	MT	Flexible Coupling	510641
	2001.07-2005.02		Front	Saloon RWD N42B18A/N46B18A		Flexible Coupling Kit	510596S
	2001.07-2005.02		Front	Saloon RWD N42B18A/N46B18A		Flexible Coupling Kit	510597S
1.9 (77 kw)	1998.12-2002.02		Centre	Saloon RWD M43B194E1		Center Bearing Support	510659
	1998.12-2002.02		Centre	Saloon RWD M43B194E1		Center Bearing Support	512301
	1998.12-2002.02		Front	Saloon RWD M43B194E1		Flexible Coupling	510597
	1998.12-2002.02		Front	Saloon RWD M43B194E1		Flexible Coupling Kit	510597S
316i Compact							
1.6 (75 kw)	1994.01-2000.08		Centre	Hatchback RWD M43B164E2		Center Bearing Support	510659
	1994.01-2000.08		Front	Hatchback RWD M43B164E2		Flexible Coupling	510597
	1994.01-2000.08		Front	Hatchback RWD M43B164E2		Flexible Coupling	510641
	1996.02-2000.08		Centre	Hatchback RWD M43B164E2CNG		Center Bearing Support	510659
	1996.02-2000.08		Front	Hatchback RWD M43B164E2CNG		Flexible Coupling	510597
1.6 (77 kw)	2002.06-2005.02		Centre	Hatchback RWD N40B16A/N45B16A		Center Bearing Support	530154
	2002.06-2005.02		Front	Hatchback RWD N40B16A/N45B16A		Flexible Coupling	510597
	2002.06-2005.02		Front	Hatchback RWD N40B16A/N45B16A		Flexible Coupling Kit	510597S
1.6 (85 kw)	2002.06-2005.02		Centre	Hatchback RWD N40B16A/N45B16A		Center Bearing Support	530154
	2002.06-2005.02		Front	Hatchback RWD N40B16A/N45B16A		Flexible Coupling	510641
	2002.06-2005.02		Front	Hatchback RWD N40B16A/N45B16A		Flexible Coupling Kit	510641S
1.8 (85 kw)	2001.06-2005.02		Centre	Hatchback RWD N42B18A/N46B18A		Center Bearing Support	512301
	2001.06-2005.02		Centre	Hatchback RWD N42B18A/N46B18A		Center Bearing Support	530154
	2001.06-2005.02		Front	Hatchback RWD N42B18A/N46B18A		Flexible Coupling	510596
	2001.06-2005.02		Front	Hatchback RWD N42B18A/N46B18A		Flexible Coupling	510597
	2001.06-2005.02		Front	Hatchback RWD N42B18A/N46B18A		Flexible Coupling	510641
	2001.06-2005.02		Front	Hatchback RWD N42B18A/N46B18A		Flexible Coupling Kit	510596S
	2001.06-2005.02		Front	Hatchback RWD N42B18A/N46B18A		Flexible Coupling Kit	510597S
1.9 (77 kw)	1999.01-2000.08		Centre	Hatchback RWD M43B194E1		Center Bearing Support	510659
	1999.01-2000.08		Front	Hatchback RWD M43B194E1		Flexible Coupling	510597
	1999.01-2000.08		Front	Hatchback RWD M43B194E1		Flexible Coupling	510641
316i Coupe							
1.6 (75 kw)	1993.09-1998.11		Centre	Coupe RWD M43B164E2		Center Bearing Support	510659
	1993.09-1998.11		Front	Coupe RWD M43B164E2		Flexible Coupling	510597



	 YEAR	TRANSM.	FITTING POSITION	BODY STYLE & DRIVE TYPE & ENGINE	REMARKS	 PRODUCT	GSP Ref.
BMW							
316i Coupe							
1.6 (75 kw)	1993.09-1998.11		Front	Coupe RWD M43B164E2		Flexible Coupling	510641
	1993.09-1998.11		Front	Coupe RWD M43B164E2		Flexible Coupling Kit	510597S
1.6 (77 kw)	2000.04-2003.10		Centre	Coupe RWD M43B164E3		Center Bearing Support	512301
	2000.04-2003.10		Front	Coupe RWD M43B164E3		Flexible Coupling	510597
1.6 (85 kw)	2002.06-2006.07		Centre	Coupe RWD N45B16A		Center Bearing Support	530154
	2002.06-2006.07		Front	Coupe RWD N45B16A		Flexible Coupling	510641
	2002.06-2006.07		Front	Coupe RWD N45B16A		Flexible Coupling Kit	510641S
1.6 (90 kw)	2007.09-2013.06	AT	Rear	Coupe RWD N43B16AA		Propshaft	PS900125
	2007.09-2013.06		Centre	Coupe RWD N43B16AA		Center Bearing Support	530151
	2007.09-2013.06		Front	Coupe RWD N43B16AA		Flexible Coupling	510596
	2007.09-2013.06		Front	Coupe RWD N43B16AA		Flexible Coupling	510641
	2007.09-2013.06		Front	Coupe RWD N43B16AA		Flexible Coupling Kit	510596S
	2007.09-2013.06		Front	Coupe RWD N43B16AA		Flexible Coupling Kit	510641S
316i Touring							
1.6 (73 kw)	1991.06-1994.10		Centre	Estate RWD M40B164E1		Center Bearing Support	510599
	1991.06-1994.10		Front	Estate RWD M40B164E1		Flexible Coupling	510641
1.6 (75 kw)	1991.09-1994.06		Centre	Estate RWD M40B164E1		Center Bearing Support	510599
	1991.09-1994.06		Front	Estate RWD M40B164E1		Flexible Coupling	510641
	1997.03-1999.05		Centre	Estate RWD M43B164E2		Center Bearing Support	510659
	1997.03-1999.05		Front	Estate RWD M43B164E2		Flexible Coupling	510597
	1997.03-1999.05		Front	Estate RWD M43B164E2		Flexible Coupling	510641
1.6 (90 kw)	2008.09-2012.06	AT	Rear	Estate RWD N43B16AA		Propshaft	PS900125
	2008.09-2012.06		Centre	Estate RWD N43B16AA		Center Bearing Support	530151
	2008.09-2012.06		Front	Estate RWD N43B16AA		Flexible Coupling	510596
	2008.09-2012.06		Front	Estate RWD N43B16AA		Flexible Coupling	510641
	2008.09-2012.06		Front	Estate RWD N43B16AA		Flexible Coupling Kit	510596S
	2008.09-2012.06		Front	Estate RWD N43B16AA		Flexible Coupling Kit	510641S
1.6 (100 kw)	2013.03-2015.06		Front	Estate RWD N13B16A		Flexible Coupling	510596
	2013.03-2015.06		Front	Estate RWD N13B16A		Flexible Coupling	510597
	2013.03-2015.06		Rear	Estate RWD N13B16A		Flexible Coupling	537625
	2013.03-2015.06		Front	Estate RWD N13B16A		Flexible Coupling Kit	510596S
	2013.03-2015.06		Rear	Estate RWD N13B16A		Flexible Coupling Kit	537625S
1.8 (85 kw)	2001.07-2005.02		Centre	Estate RWD N42B18A/N46B18A		Center Bearing Support	512301
	2001.07-2005.02		Centre	Estate RWD N42B18A/N46B18A		Center Bearing Support	530154
	2001.07-2005.02		Front	Estate RWD N42B18A/N46B18A		Flexible Coupling	510596
	2001.07-2005.02		Front	Estate RWD N42B18A/N46B18A		Flexible Coupling	510597
	2001.07-2005.02		Front	Estate RWD N42B18A/N46B18A		Flexible Coupling	510641
	2001.07-2005.02		Front	Estate RWD N42B18A/N46B18A		Flexible Coupling Kit	510596S
	2001.07-2005.02		Front	Estate RWD N42B18A/N46B18A		Flexible Coupling Kit	510597S
	2001.07-2005.02		Front	Estate RWD N42B18A/N46B18A		Flexible Coupling Kit	510641S
318d							
1.7 (66 kw)	1994.08-1998.01		Centre	Saloon RWD M41D174T1		Center Bearing Support	510659
	1994.08-1998.01		Front	Saloon RWD M41D174T1		Flexible Coupling	510597
2.0 (85 kw)	2001.07-2003.02	MT	Rear	Saloon RWD M47D204D1		Propshaft	PS900121
	2001.07-2003.02		Centre	Saloon RWD M47D204D1		Center Bearing Support	530154
	2001.07-2003.02		Front	Saloon RWD M47D204D1		Flexible Coupling	510596
	2001.07-2003.02		Front	Saloon RWD M47D204D1		Flexible Coupling Kit	510596S
	2003.03-2005.02	MT	Rear	Saloon RWD M47D204D4		Propshaft	PS900121
	2003.03-2005.02		Centre	Saloon RWD M47D204D4	AT	Center Bearing Support	512301
	2003.03-2005.02		Centre	Saloon RWD M47D204D4	MT	Center Bearing Support	530154
	2003.03-2005.02		Front	Saloon RWD M47D204D4		Flexible Coupling	510596
	2003.03-2005.02		Front	Saloon RWD M47D204D4		Flexible Coupling Kit	510596S
2.0 (90 kw)	2005.03-2007.08		Centre	Saloon RWD M47D204D4		Center Bearing Support	530151
	2005.03-2007.08		Front	Saloon RWD M47D204D4		Flexible Coupling	510596
	2005.03-2007.08		Rear	Saloon RWD M47D204D4		Flexible Coupling	533878
	2005.03-2007.08		Front	Saloon RWD M47D204D4		Flexible Coupling Kit	510596S
2.0 (100 kw)	2007.09-2011.10		Front	Saloon RWD N47D20A/N47D20C		Flexible Coupling	510596
	2007.09-2011.10		Rear	Saloon RWD N47D20A/N47D20C		Flexible Coupling	533878
	2012.03-2018.10		Front	Saloon RWD B47D20A/N47D20C		Flexible Coupling	510596
	2012.03-2018.10		Rear	Saloon RWD B47D20A/N47D20C		Flexible Coupling	537625
	2012.03-2018.10		Front	Saloon RWD B47D20A/N47D20C		Flexible Coupling Kit	510596S
	2012.03-2018.10		Rear	Saloon RWD B47D20A/N47D20C		Flexible Coupling Kit	537625S
	2019.03-2020.03		Front	Saloon RWD B47D20B		Flexible Coupling	533422
	2019.03-2020.03		Rear	Saloon RWD B47D20B		Flexible Coupling	537625



	 YEAR	TRANSM.	FITTING POSITION	BODY STYLE & DRIVE TYPE & ENGINE	REMARKS	 PRODUCT	GSP Ref.
BMW 318d							
2.0 (105 kw)	2007.02-2011.10		Centre	Saloon RWD N47D20A/N47D20C		Center Bearing Support	530151
	2007.02-2011.10		Front	Saloon RWD N47D20A/N47D20C		Flexible Coupling	510596
	2007.02-2011.10		Rear	Saloon RWD N47D20A/N47D20C		Flexible Coupling	533878
	2007.02-2011.10		Front	Saloon RWD N47D20A/N47D20C		Flexible Coupling Kit	510596S
	2012.03-2015.06		Centre	Saloon RWD N47D20C		Center Bearing Support	530151
	2012.03-2015.06		Front	Saloon RWD N47D20C		Flexible Coupling	510596
	2012.03-2015.06		Rear	Saloon RWD N47D20C		Flexible Coupling	537625
	2012.03-2015.06		Front	Saloon RWD N47D20C		Flexible Coupling Kit	510596S
2.0 (110 kw)	2015.07-2018.10		Front	Saloon RWD B47D20A		Flexible Coupling	510596
	2015.07-2018.10		Rear	Saloon RWD B47D20A		Flexible Coupling	537625
	2015.07-2018.10		Front	Saloon RWD B47D20A		Flexible Coupling Kit	510596S
	2015.07-2018.10		Rear	Saloon RWD B47D20A		Flexible Coupling Kit	537625S
	2019.03-2020.03		Front	Saloon RWD B47D20B		Flexible Coupling	533422
2019.03-2020.03		Rear	Saloon RWD B47D20B		Flexible Coupling	537625	
318d Compact							
1.7 (66 kw)	1995.06-2000.08		Centre	Hatchback RWD M41D174T1		Center Bearing Support	530154
	1995.06-2000.08		Front	Hatchback RWD M41D174T1		Flexible Coupling	510597
2.0 (85 kw)	2003.02-2005.02		Centre	Hatchback RWD M47D204D4		Center Bearing Support	530154
	2003.02-2005.02		Front	Hatchback RWD M47D204D4		Flexible Coupling	510596
	2003.02-2005.02		Front	Hatchback RWD M47D204D4		Flexible Coupling Kit	510596S
318d Gran Turismo							
2.0 (100 kw)	2013.03-		Front	Hatchback RWD B47D20A/N47D20C		Flexible Coupling	510596
	2013.03-		Rear	Hatchback RWD B47D20A/N47D20C		Flexible Coupling	537625
	2013.03-		Front;Rear	Hatchback RWD B47D20A/N47D20C		Flexible Coupling	517955
	2013.03-		Front	Hatchback RWD B47D20A/N47D20C		Flexible Coupling Kit	510596S
	2013.03-		Rear	Hatchback RWD B47D20A/N47D20C		Flexible Coupling Kit	537625S
2.0 (105 kw)	2013.03-2015.06		Front	Hatchback RWD N47D20C		Flexible Coupling	510596
	2013.03-2015.06		Rear	Hatchback RWD N47D20C		Flexible Coupling	537625
	2013.03-2015.06		Front	Hatchback RWD N47D20C		Flexible Coupling Kit	510596S
	2013.03-2015.06		Rear	Hatchback RWD N47D20C		Flexible Coupling Kit	537625S
2.0 (110 kw)	2016.06-		Front	Hatchback RWD B47D20A		Flexible Coupling	510596
	2016.06-		Rear	Hatchback RWD B47D20A		Flexible Coupling	537625
	2016.06-		Front	Hatchback RWD B47D20A		Flexible Coupling Kit	510596S
	2016.06-		Rear	Hatchback RWD B47D20A		Flexible Coupling Kit	537625S
318d Touring							
1.7 (66 kw)	1995.03-1999.04		Centre	Estate RWD M41D174T1		Center Bearing Support	510659
	1995.03-1999.04		Front	Estate RWD M41D174T1		Flexible Coupling	510597
2.0 (85 kw)	2001.07-2003.02		Centre	Estate RWD M47D204D1		Center Bearing Support	530154
	2001.07-2003.02		Front	Estate RWD M47D204D1		Flexible Coupling	510596
	2001.07-2003.02		Front	Estate RWD M47D204D1		Flexible Coupling Kit	510596S
	2003.03-2005.02		Centre	Estate RWD M47D204D4		Center Bearing Support	510659
	2003.03-2005.02		Centre	Estate RWD M47D204D4		Center Bearing Support	512301
	2003.03-2005.02		Front	Estate RWD M47D204D4		Flexible Coupling	510596
	2003.03-2005.02		Front	Estate RWD M47D204D4		Flexible Coupling Kit	510596S
2.0 (90 kw)	2005.09-2007.08		Centre	Estate RWD M47D204D4		Center Bearing Support	530151
	2005.09-2007.08		Front	Estate RWD M47D204D4		Flexible Coupling	510596
	2005.09-2007.08		Rear	Estate RWD M47D204D4		Flexible Coupling	533878
	2005.09-2007.08		Front	Estate RWD M47D204D4		Flexible Coupling Kit	510596S
2.0 (100 kw)	2007.09-2012.06		Front	Estate RWD N47D20A/N47D20C		Flexible Coupling	510596
	2007.09-2012.06		Rear	Estate RWD N47D20A/N47D20C		Flexible Coupling	533878
	2012.06-2019.06		Front	Estate RWD B47D20A/N47D20C		Flexible Coupling	510596
	2012.06-2019.06		Rear	Estate RWD B47D20A/N47D20C		Flexible Coupling	537625
	2012.06-2019.06		Front	Estate RWD B47D20A/N47D20C		Flexible Coupling Kit	510596S
	2012.06-2019.06		Rear	Estate RWD B47D20A/N47D20C		Flexible Coupling Kit	537625S
2.0 (105 kw)	2007.09-2012.06		Centre	Estate RWD N47D20A/N47D20C		Center Bearing Support	530151
	2007.09-2012.06		Front	Estate RWD N47D20A/N47D20C		Flexible Coupling	510596
	2007.09-2012.06		Rear	Estate RWD N47D20A/N47D20C		Flexible Coupling	533878
	2007.09-2012.06		Front	Estate RWD N47D20A/N47D20C		Flexible Coupling Kit	510596S
	2012.11-2015.06		Front	Estate RWD N47D20C		Flexible Coupling	510596
	2012.11-2015.06		Rear	Estate RWD N47D20C		Flexible Coupling	537625
	2012.11-2015.06		Front	Estate RWD N47D20C		Flexible Coupling Kit	510596S
	2012.11-2015.06		Rear	Estate RWD N47D20C		Flexible Coupling Kit	537625S



	 YEAR	TRANSM.	FITTING POSITION	BODY STYLE & DRIVE TYPE & ENGINE	REMARKS	 PRODUCT	GSP Ref.
BMW							
318d Touring							
2.0 (110 kw)	2015.07-2019.06		Front	Estate RWD B47D20A		Flexible Coupling	510596
	2015.07-2019.06		Rear	Estate RWD B47D20A		Flexible Coupling	537625
	2015.07-2019.06		Front	Estate RWD B47D20A		Flexible Coupling Kit	510596S
	2015.07-2019.06		Rear	Estate RWD B47D20A		Flexible Coupling Kit	537625S
318d xDrive							
2.0 (105 kw)	2013.07-2015.06	AT/MT	Front	Saloon 4WD N47D20C	Date From:2014.01	Propshaft	PS900112
	2013.07-2015.06		Rear	Saloon 4WD N47D20C		Flexible Coupling	537625
	2013.07-2015.06		Front;Rear	Saloon 4WD N47D20C		Flexible Coupling	517955
	2013.07-2015.06		Front	Saloon 4WD N47D20C		Flexible Coupling Kit	517955S
	2013.07-2015.06		Rear	Saloon 4WD N47D20C		Flexible Coupling Kit	537625S
2.0 (110 kw)	2015.07-2018.02		Front	Saloon 4WD B47D20A		Flexible Coupling	510596
	2015.07-2018.02		Rear	Saloon 4WD B47D20A		Flexible Coupling	537625
	2015.07-2018.02		Rear	Saloon 4WD B47D20A		Flexible Coupling Kit	537625S
318d xDrive Touring							
2.0 (105 kw)	2013.07-2015.06		Rear	Estate 4WD N47D20C		Flexible Coupling	537625
	2013.07-2015.06		Front;Rear	Estate 4WD N47D20C		Flexible Coupling	517955
	2013.07-2015.06		Front	Estate 4WD N47D20C		Flexible Coupling Kit	517955S
	2013.07-2015.06		Rear	Estate 4WD N47D20C		Flexible Coupling Kit	537625S
2.0 (110 kw)	2015.07-2018.02		Front	Estate 4WD B47D20A		Flexible Coupling	510596
	2015.07-2018.02		Rear	Estate 4WD B47D20A		Flexible Coupling	537625
	2015.07-2018.02		Rear	Estate 4WD B47D20A		Flexible Coupling Kit	537625S
318i							
1.5 (100 kw)	2015.07-2018.10		Front	Saloon RWD B38B15A		Flexible Coupling	510596
	2015.07-2018.10		Rear	Saloon RWD B38B15A		Flexible Coupling	537625
	2015.07-2018.10		Front	Saloon RWD B38B15A		Flexible Coupling Kit	510596S
1.8 (83 kw)	1990.09-1993.08		Centre	Saloon RWD M40B184E1		Center Bearing Support	510659
	1990.09-1993.08		Front	Saloon RWD M40B184E1		Flexible Coupling	510597
	1990.09-1993.08		Front	Saloon RWD M40B184E1		Flexible Coupling	510641
	1990.09-1993.08		Front	Saloon RWD M40B184E1		Flexible Coupling Kit	510597S
1.8 (85 kw)	1993.09-1998.11		Centre	Saloon RWD M43B184E2		Center Bearing Support	510659
	1993.09-1998.11		Front	Saloon RWD M43B184E2		Flexible Coupling	510597
	1993.09-1998.11		Front	Saloon RWD M43B184E2		Flexible Coupling	510641
1.8 (103 kw)	1993.09-1995.12		Centre	Saloon RWD M42B184S1		Center Bearing Support	510659
	1993.09-1995.12		Front	Saloon RWD M42B184S1		Flexible Coupling	510597
	1993.09-1995.12		Front	Saloon RWD M42B184S1		Flexible Coupling	510641
	1993.09-1995.12		Front	Saloon RWD M42B184S1		Flexible Coupling Kit	510597S
	1993.09-1995.12		Front	Saloon RWD M42B184S1		Flexible Coupling Kit	510641S
1.9 (87 kw)	1997.12-2001.09		Centre	Saloon RWD M43B194E1		Center Bearing Support	510659
	1997.12-2001.09		Centre	Saloon RWD M43B194E1		Center Bearing Support	512301
	1997.12-2001.09		Front	Saloon RWD M43B194E1		Flexible Coupling	510597
	1997.12-2001.09		Front	Saloon RWD M43B194E1		Flexible Coupling Kit	510597S
1.9 (103 kw)	1996.01-1998.05		Centre	Saloon RWD M44B194S1		Center Bearing Support	510659
	1996.01-1998.05		Front	Saloon RWD M44B194S1		Flexible Coupling	510597
	1996.01-1998.05		Front	Saloon RWD M44B194S1		Flexible Coupling	510641
	1996.01-1998.05		Front	Saloon RWD M44B194S1		Flexible Coupling Kit	510641S
2.0 (95 kw)	2005.03-2007.08	AT	Rear	Saloon RWD N46B20B		Propshaft	PS900125
	2005.03-2007.08		Centre	Saloon RWD N46B20B		Center Bearing Support	530151
	2005.03-2007.08		Front	Saloon RWD N46B20B		Flexible Coupling	510596
	2005.03-2007.08		Front	Saloon RWD N46B20B		Flexible Coupling	510641
	2005.03-2007.08		Front	Saloon RWD N46B20B		Flexible Coupling Kit	510596S
	2005.03-2007.08		Front	Saloon RWD N46B20B		Flexible Coupling Kit	510641S
2.0 (100 kw)	2001.09-2005.02		Front	Saloon RWD N42B20A		Flexible Coupling	510596
	2007.09-2011.10		Front	Saloon RWD N46B20B		Flexible Coupling	510596
2.0 (105 kw)	2001.09-2005.02	AT	Rear	Saloon RWD N42B20A/N46B20A/N46B20C		Propshaft	PS900116
	2001.09-2005.02		Centre	Saloon RWD N42B20A/N46B20A/N46B20C	AT	Center Bearing Support	512301
	2001.09-2005.02		Centre	Saloon RWD N42B20A/N46B20A/N46B20C	MT	Center Bearing Support	530154
	2001.09-2005.02		Front	Saloon RWD N42B20A/N46B20A/N46B20C	AT	Flexible Coupling	510596
	2001.09-2005.02		Front	Saloon RWD N42B20A/N46B20A/N46B20C	MT	Flexible Coupling	510597
	2001.09-2005.02		Front	Saloon RWD N42B20A/N46B20A/N46B20C	MT	Flexible Coupling	510641
	2001.09-2005.02		Front	Saloon RWD N42B20A/N46B20A/N46B20C		Flexible Coupling Kit	510596S
	2001.09-2005.02		Front	Saloon RWD N42B20A/N46B20A/N46B20C		Flexible Coupling Kit	510597S
	2007.09-2011.10	AT	Rear	Saloon RWD N43B20A		Propshaft	PS900125
	2007.09-2011.10		Centre	Saloon RWD N43B20A		Center Bearing Support	530151
2007.09-2011.10		Front	Saloon RWD N43B20A		Flexible Coupling	510596	



	 YEAR	TRANSM.	FITTING POSITION	BODY STYLE & DRIVE TYPE & ENGINE	REMARKS	 PRODUCT	GSP Ref.
BMW 318i							
2.0 (105 kw)	2007.09-2011.10		Front	Saloon RWD N43B20A		Flexible Coupling	510641
	2007.09-2011.10		Front	Saloon RWD N43B20A		Flexible Coupling Kit	510596S
	2007.09-2011.10		Front	Saloon RWD N43B20A		Flexible Coupling Kit	510641S
318i Cabrio							
1.8 (83 kw)	1990.07-1993.08		Centre	Cabriolet RWD M40B184E1		Center Bearing Support	510599
	1990.07-1993.08		Front	Cabriolet RWD M40B184E1		Flexible Coupling	510641
1.8 (85 kw)	1994.03-1999.11		Centre	Cabriolet RWD M43B184E2		Center Bearing Support	510659
	1994.03-1999.11		Front	Cabriolet RWD M43B184E2		Flexible Coupling	510597
	1994.03-1999.11		Front	Cabriolet RWD M43B184E2		Flexible Coupling	510641
1.8 (103 kw)	1990.10-1992.12		Centre	Cabriolet RWD M42B184S1		Center Bearing Support	510599
2.0 (100 kw)	2001.09-2006.12		Front	Cabriolet RWD N42B20A/N46B20A		Flexible Coupling	510596
	2001.09-2006.12		Front	Cabriolet RWD N42B20A/N46B20A		Flexible Coupling	510597
	2001.09-2006.12		Front	Cabriolet RWD N42B20A/N46B20A		Flexible Coupling	510641
	2001.09-2006.12		Front	Cabriolet RWD N42B20A/N46B20A		Flexible Coupling Kit	510597S
	2001.09-2006.12		Front	Cabriolet RWD N42B20A/N46B20A		Flexible Coupling Kit	510641S
2.0 (105 kw)	2001.09-2006.12		Centre	Cabriolet RWD N42B20A/N46B20A		Center Bearing Support	512301
	2001.09-2006.12		Centre	Cabriolet RWD N42B20A/N46B20A		Center Bearing Support	530154
	2001.09-2006.12		Front	Cabriolet RWD N42B20A/N46B20A		Flexible Coupling	510596
	2001.09-2006.12		Front	Cabriolet RWD N42B20A/N46B20A		Flexible Coupling	510597
	2001.09-2006.12		Front	Cabriolet RWD N42B20A/N46B20A		Flexible Coupling	510641
	2001.09-2006.12		Front	Cabriolet RWD N42B20A/N46B20A		Flexible Coupling Kit	510596S
	2001.09-2006.12		Front	Cabriolet RWD N42B20A/N46B20A		Flexible Coupling Kit	510597S
	2001.09-2006.12		Front	Cabriolet RWD N42B20A/N46B20A		Flexible Coupling Kit	510641S
	2010.03-2013.12		Centre	Cabriolet RWD N43B20A		Center Bearing Support	530151
	2010.03-2013.12		Front	Cabriolet RWD N43B20A		Flexible Coupling	510641
2.0 (110 kw)	2004.03-2006.08		Centre	Cabriolet RWD N46B20A/N46B20C		Center Bearing Support	530154
	2004.03-2006.08		Front	Cabriolet RWD N46B20A/N46B20C		Flexible Coupling	510596
	2004.03-2006.08		Front	Cabriolet RWD N46B20A/N46B20C		Flexible Coupling	510641
	2004.03-2006.08		Front	Cabriolet RWD N46B20A/N46B20C		Flexible Coupling Kit	510596S
	2004.03-2006.08		Front	Cabriolet RWD N46B20A/N46B20C		Flexible Coupling Kit	510641S
318i Compact							
1.8 (103 kw)	1994.09-1995.12		Centre	Hatchback RWD M42B184S1		Center Bearing Support	510659
	1994.09-1995.12		Front	Hatchback RWD M42B184S1		Flexible Coupling	510597
	1994.09-1995.12		Front	Hatchback RWD M42B184S1		Flexible Coupling	510641
	1994.09-1995.12		Front	Hatchback RWD M42B184S1		Flexible Coupling Kit	510597S
	1994.09-1995.12		Front	Hatchback RWD M42B184S1		Flexible Coupling Kit	510641S
1.9 (103 kw)	1996.01-1999.01		Centre	Hatchback RWD M44B194S1		Center Bearing Support	510659
	1996.01-1999.01		Front	Hatchback RWD M44B194S1		Flexible Coupling	510597
	1996.01-1999.01		Front	Hatchback RWD M44B194S1		Flexible Coupling	510641
	1996.01-1999.01		Front	Hatchback RWD M44B194S1		Flexible Coupling Kit	510597S
	1996.01-1999.01		Front	Hatchback RWD M44B194S1		Flexible Coupling Kit	510641S
2.0 (100 kw)	2001.03-2004.12		Front	Hatchback RWD N42B20A/N46B20A		Flexible Coupling	510596
2.0 (105 kw)	2001.09-2005.02		Centre	Hatchback RWD N42B20A/N46B20A		Center Bearing Support	512301
	2001.09-2005.02		Centre	Hatchback RWD N42B20A/N46B20A		Center Bearing Support	530154
	2001.09-2005.02		Front	Hatchback RWD N42B20A/N46B20A		Flexible Coupling	510596
	2001.09-2005.02		Front	Hatchback RWD N42B20A/N46B20A		Flexible Coupling	510597
	2001.09-2005.02		Front	Hatchback RWD N42B20A/N46B20A		Flexible Coupling	510641
	2001.09-2005.02		Front	Hatchback RWD N42B20A/N46B20A		Flexible Coupling Kit	510596S
	2001.09-2005.02		Front	Hatchback RWD N42B20A/N46B20A		Flexible Coupling Kit	510597S
	2001.09-2005.02		Front	Hatchback RWD N42B20A/N46B20A		Flexible Coupling Kit	510641S
318i Coupe							
1.8 (103 kw)	1992.01-1995.12		Centre	Coupe RWD M42B184S1		Center Bearing Support	510659
	1992.01-1995.12		Front	Coupe RWD M42B184S1		Flexible Coupling	510597
	1992.01-1995.12		Front	Coupe RWD M42B184S1		Flexible Coupling	510641
	1992.01-1995.12		Front	Coupe RWD M42B184S1		Flexible Coupling Kit	510597S
	1992.01-1995.12		Front	Coupe RWD M42B184S1		Flexible Coupling Kit	510641S
1.9 (87 kw)	1999.12-2001.08		Centre	Coupe RWD M43B194E1		Center Bearing Support	510659
	1999.12-2001.08		Centre	Coupe RWD M43B194E1		Center Bearing Support	512301
	1999.12-2001.08		Front	Coupe RWD M43B194E1		Flexible Coupling	510597
	1999.12-2001.08		Front	Coupe RWD M43B194E1		Flexible Coupling Kit	510597S
1.9 (103 kw)	1995.04-1999.12		Centre	Coupe RWD M44B194S1		Center Bearing Support	510659
	1995.04-1999.12		Front	Coupe RWD M44B194S1		Flexible Coupling	510597
	1995.04-1999.12		Front	Coupe RWD M44B194S1		Flexible Coupling	510641



	 YEAR	TRANSM.	FITTING POSITION	BODY STYLE & DRIVE TYPE & ENGINE	REMARKS	 PRODUCT	GSP Ref.
BMW							
318i Coupe							
1.9 (103 kw)	1995.04-1999.12		Front	Coupe RWD M44B194S1		Flexible Coupling Kit	510597S
	1995.04-1999.12		Front	Coupe RWD M44B194S1		Flexible Coupling Kit	510641S
2.0 (100 kw)	2003.01-2004.12		Front	Coupe RWD N42B20A		Flexible Coupling	510596
2.0 (105 kw)	2001.09-2004.02		Centre	Coupe RWD N42B20A		Center Bearing Support	512301
	2001.09-2004.02		Centre	Coupe RWD N42B20A		Center Bearing Support	530154
	2001.09-2004.02		Front	Coupe RWD N42B20A		Flexible Coupling	510596
	2001.09-2004.02		Front	Coupe RWD N42B20A		Flexible Coupling	510597
	2001.09-2004.02		Front	Coupe RWD N42B20A		Flexible Coupling Kit	510596S
	2001.09-2004.02		Front	Coupe RWD N42B20A		Flexible Coupling Kit	510597S
	2010.03-	AT	Rear	Coupe RWD N43B20A		Propshaft	PS900125
	2010.03-		Front	Coupe RWD N43B20A		Flexible Coupling	510641
	2010.03-		Front	Coupe RWD N43B20A		Flexible Coupling Kit	510641S
2.0 (110 kw)	2004.03-2006.05		Centre	Coupe RWD N46B20A/N46B20C		Center Bearing Support	530154
	2004.03-2006.05		Front	Coupe RWD N46B20A/N46B20C		Flexible Coupling	510596
	2004.03-2006.05		Front	Coupe RWD N46B20A/N46B20C		Flexible Coupling	510641
318i Touring							
1.5 (100 kw)	2015.07-2019.06		Front	Estate RWD B38B15A		Flexible Coupling	510596
	2015.07-2019.06		Rear	Estate RWD B38B15A		Flexible Coupling	537625
	2015.07-2019.06		Front	Estate RWD B38B15A		Flexible Coupling Kit	510596S
	2015.07-2019.06		Rear	Estate RWD B38B15A		Flexible Coupling Kit	537625S
1.8 (83 kw)	1988.09-1994.10		Centre	Estate RWD M40B184E1		Center Bearing Support	510599
	1988.09-1994.10		Front	Estate RWD M40B184E1		Flexible Coupling	510641
1.8 (85 kw)	1995.09-1999.04		Centre	Estate RWD M43B184E2		Center Bearing Support	510659
	1995.09-1999.04		Front	Estate RWD M43B184E2		Flexible Coupling	510597
	1995.09-1999.04		Front	Estate RWD M43B184E2		Flexible Coupling	510641
1.9 (85 kw)	1999.10-2001.09		Centre	Estate RWD M43B194E1		Center Bearing Support	510659
1.9 (87 kw)	1999.08-2001.06		Centre	Estate RWD M43B194E1		Center Bearing Support	510659
	1999.08-2001.06		Centre	Estate RWD M43B194E1		Center Bearing Support	512301
	1999.08-2001.06		Front	Estate RWD M43B194E1		Flexible Coupling	510597
	1999.08-2001.06		Front	Estate RWD M43B194E1		Flexible Coupling Kit	510597S
2.0 (95 kw)	2006.01-2007.08	AT	Rear	Estate RWD N46B20B		Propshaft	PS900125
	2006.01-2007.08		Centre	Estate RWD N46B20B		Center Bearing Support	530151
	2006.01-2007.08		Front	Estate RWD N46B20B		Flexible Coupling	510596
	2006.01-2007.08		Front	Estate RWD N46B20B		Flexible Coupling	510641
	2006.01-2007.08		Front	Estate RWD N46B20B		Flexible Coupling Kit	510596S
	2006.01-2007.08		Front	Estate RWD N46B20B		Flexible Coupling Kit	510641S
2.0 (105 kw)	2001.09-2005.07		Centre	Estate RWD N42B20A/N46B20A/N46B20C		Center Bearing Support	512301
	2001.09-2005.07		Centre	Estate RWD N42B20A/N46B20A/N46B20C		Center Bearing Support	530154
	2001.09-2005.07		Front	Estate RWD N42B20A/N46B20A/N46B20C		Flexible Coupling	510596
	2001.09-2005.07		Front	Estate RWD N42B20A/N46B20A/N46B20C		Flexible Coupling	510597
	2001.09-2005.07		Front	Estate RWD N42B20A/N46B20A/N46B20C		Flexible Coupling	510641
	2001.09-2005.07		Front	Estate RWD N42B20A/N46B20A/N46B20C		Flexible Coupling Kit	510596S
	2001.09-2005.07		Front	Estate RWD N42B20A/N46B20A/N46B20C		Flexible Coupling Kit	510597S
	2001.09-2005.07		Front	Estate RWD N42B20A/N46B20A/N46B20C		Flexible Coupling Kit	510641S
	2007.06-2012.12	AT	Rear	Estate RWD N43B20A		Propshaft	PS900125
	2007.06-2012.12		Centre	Estate RWD N43B20A		Center Bearing Support	530151
	2007.06-2012.12		Front	Estate RWD N43B20A		Flexible Coupling	510596
	2007.06-2012.12		Front	Estate RWD N43B20A		Flexible Coupling	510641
	2007.06-2012.12		Front	Estate RWD N43B20A		Flexible Coupling Kit	510596S
	2007.06-2012.12		Front	Estate RWD N43B20A		Flexible Coupling Kit	510641S
320d							
2.0 (95 kw)	1998.02-2001.08	MT	Rear	Saloon RWD M47D204D1		Propshaft	PS900121
	1998.02-2001.08		Front	Saloon RWD M47D204D1		Flexible Coupling	510596
	1998.02-2001.08		Front	Saloon RWD M47D204D1		Flexible Coupling Kit	510596S
2.0 (100 kw)	1998.02-2001.06	MT	Rear	Saloon RWD M47D204D1		Propshaft	PS900121
	1998.02-2001.06		Centre	Saloon RWD M47D204D1		Center Bearing Support	530154
	1998.02-2001.06		Front	Saloon RWD M47D204D1		Flexible Coupling	510596
	1998.02-2001.06		Front	Saloon RWD M47D204D1		Flexible Coupling Kit	510596S
2.0 (110 kw)	2001.09-2005.05	MT	Rear	Saloon RWD M47D204D4		Propshaft	PS900121
	2001.09-2005.05		Centre	Saloon RWD M47D204D4	Date from:2002.09	Center Bearing Support	512301
	2001.09-2005.05		Centre	Saloon RWD M47D204D4	Date to:2002.09	Center Bearing Support	530154
	2001.09-2005.05		Front	Saloon RWD M47D204D4		Flexible Coupling	510596
	2001.09-2005.05		Front	Saloon RWD M47D204D4		Flexible Coupling Kit	510596S
	2004.06-2007.09		Centre	Saloon RWD M47D204D4		Center Bearing Support	530151



	 YEAR	TRANSM.	FITTING POSITION	BODY STYLE & DRIVE TYPE & ENGINE	REMARKS	 PRODUCT	GSP Ref.
BMW 320d							
2.0 (110 kw)	2004.06-2007.09		Front	Saloon RWD M47D204D4		Flexible Coupling	510596
	2004.06-2007.09		Rear	Saloon RWD M47D204D4		Flexible Coupling	533878
	2004.06-2007.09		Front	Saloon RWD M47D204D4		Flexible Coupling Kit	510596S
2.0 (120 kw)	2004.12-2011.10		Centre	Saloon RWD M47D204D4/N47D20A/N47D20C		Center Bearing Support	530151
	2004.12-2011.10		Front	Saloon RWD M47D204D4/N47D20A/N47D20C		Flexible Coupling	510596
	2004.12-2011.10		Rear	Saloon RWD M47D204D4/N47D20A/N47D20C		Flexible Coupling	533878
	2004.12-2011.10		Front;Rear	Saloon RWD M47D204D4/N47D20A/N47D20C		Flexible Coupling	517955
	2004.12-2011.10		Front	Saloon RWD M47D204D4/N47D20A/N47D20C		Flexible Coupling Kit	510596S
	2004.12-2011.10		Front	Saloon RWD M47D204D4/N47D20A/N47D20C		Flexible Coupling Kit	517955S
	2011.11-2018.10		Centre	Saloon RWD B47D20A/N47D20C		Center Bearing Support	530151
	2011.11-2018.10		Front	Saloon RWD B47D20A/N47D20C		Flexible Coupling	510596
	2011.11-2018.10		Rear	Saloon RWD B47D20A/N47D20C		Flexible Coupling	537625
	2011.11-2018.10		Front;Rear	Saloon RWD B47D20A/N47D20C		Flexible Coupling	517955
	2011.11-2018.10		Front	Saloon RWD B47D20A/N47D20C		Flexible Coupling Kit	510596S
	2011.11-2018.10		Front	Saloon RWD B47D20A/N47D20C		Flexible Coupling Kit	517955S
	2011.11-2018.10		Rear	Saloon RWD B47D20A/N47D20C		Flexible Coupling Kit	537625S
2.0 (130 kw)	2007.09-2010.02		Centre	Saloon RWD N47D20A/N47D20C		Center Bearing Support	530151
	2007.09-2010.02		Front	Saloon RWD N47D20A/N47D20C		Flexible Coupling	510596
	2007.09-2010.02		Rear	Saloon RWD N47D20A/N47D20C		Flexible Coupling	533878
	2007.09-2010.02		Front;Rear	Saloon RWD N47D20A/N47D20C		Flexible Coupling	517955
	2007.09-2010.02		Front	Saloon RWD N47D20A/N47D20C		Flexible Coupling Kit	510596S
	2007.09-2010.02		Front	Saloon RWD N47D20A/N47D20C		Flexible Coupling Kit	517955S
	2007.09-2010.02		Front	Saloon RWD N47D20A/N47D20C		Flexible Coupling Kit	517955S
2.0 (135 kw)	2010.03-2011.10		Front	Saloon RWD N47D20C		Flexible Coupling	510596
	2010.03-2011.10		Rear	Saloon RWD N47D20C		Flexible Coupling	533878
	2010.03-2011.10		Front;Rear	Saloon RWD N47D20C		Flexible Coupling	517955
	2010.03-2011.10		Front	Saloon RWD N47D20C		Flexible Coupling Kit	510596S
	2010.03-2011.10		Front	Saloon RWD N47D20C		Flexible Coupling Kit	517955S
	2011.11-2016.03		Centre	Saloon RWD N47D20C		Center Bearing Support	530151
	2011.11-2016.03		Front	Saloon RWD N47D20C		Flexible Coupling	510596
	2011.11-2016.03		Rear	Saloon RWD N47D20C		Flexible Coupling	537625
	2011.11-2016.03		Front;Rear	Saloon RWD N47D20C		Flexible Coupling	517955
	2011.11-2016.03		Front	Saloon RWD N47D20C		Flexible Coupling Kit	510596S
	2011.11-2016.03		Front	Saloon RWD N47D20C		Flexible Coupling Kit	517955S
2.0 (140 kw)	2015.07-2018.10		Front	Saloon RWD B47D20A		Flexible Coupling	510596
	2015.07-2018.10		Rear	Saloon RWD B47D20A		Flexible Coupling	537625
	2015.07-2018.10		Rear	Saloon RWD B47D20A		Flexible Coupling Kit	537625S
	2018.11-2020.02		Front;Rear	Saloon RWD B47D20B		Flexible Coupling	517955
	2018.11-2020.02		Front	Saloon RWD B47D20B		Flexible Coupling Kit	517955S
	2018.11-2020.02		Front	Saloon RWD B47D20B		Flexible Coupling Kit	517955S
2.0 (147 kw)	2011.11-2016.03		Front	Saloon RWD N47D20C		Flexible Coupling	510596
	2011.11-2016.03		Rear	Saloon RWD N47D20C		Flexible Coupling	537625
	2011.11-2016.03		Front;Rear	Saloon RWD N47D20C		Flexible Coupling	517955
	2011.11-2016.03		Front	Saloon RWD N47D20C		Flexible Coupling Kit	517955S
	2011.11-2016.03		Rear	Saloon RWD N47D20C		Flexible Coupling Kit	537625S
320d Cabrio							
2.0 (110 kw)	2004.11-2007.02		Centre	Cabriolet RWD M47D204D4		Center Bearing Support	512301
	2004.11-2007.02		Front	Cabriolet RWD M47D204D4		Flexible Coupling	510596
	2004.11-2007.02		Front	Cabriolet RWD M47D204D4		Flexible Coupling Kit	510596S
2.0 (120 kw)	2008.01-2013.12		Front	Cabriolet RWD N47D20A/N47D20C		Flexible Coupling	510596
	2008.01-2013.12		Rear	Cabriolet RWD N47D20A/N47D20C		Flexible Coupling	533878
	2008.01-2013.12		Front;Rear	Cabriolet RWD N47D20A/N47D20C		Flexible Coupling	517955
	2008.01-2013.12		Front	Cabriolet RWD N47D20A/N47D20C		Flexible Coupling Kit	517955S
2.0 (130 kw)	2008.03-2010.02		Centre	Cabriolet RWD N47D20A/N47D20C		Center Bearing Support	530151
	2008.03-2010.02		Front	Cabriolet RWD N47D20A/N47D20C		Flexible Coupling	510596
	2008.03-2010.02		Front	Cabriolet RWD N47D20A/N47D20C		Flexible Coupling	517956
	2008.03-2010.02		Rear	Cabriolet RWD N47D20A/N47D20C		Flexible Coupling	533878
	2008.03-2010.02		Front;Rear	Cabriolet RWD N47D20A/N47D20C		Flexible Coupling	517955
	2008.03-2010.02		Front	Cabriolet RWD N47D20A/N47D20C		Flexible Coupling Kit	510596S
2.0 (135 kw)	2010.03-		Centre	Cabriolet RWD N47D20C		Center Bearing Support	530151
	2010.03-		Front	Cabriolet RWD N47D20C		Flexible Coupling	510596
	2010.03-		Rear	Cabriolet RWD N47D20C		Flexible Coupling	533878



	 YEAR	TRANSM.	FITTING POSITION	BODY STYLE & DRIVE TYPE & ENGINE	REMARKS	 PRODUCT	GSP Ref.	
BMW								
320d Cabrio								
2.0 (135 kw)	2010.03-		Front;Rear	Cabriolet RWD N47D20C		Flexible Coupling	517955	
	2010.03-		Front	Cabriolet RWD N47D20C		Flexible Coupling Kit	510596S	
	2010.03-		Front	Cabriolet RWD N47D20C		Flexible Coupling Kit	517955S	
2.0 (145 kw)	2007.09-2010.02		Front	Cabriolet RWD N47D20A/N47D20C		Flexible Coupling	510596	
	2007.09-2010.02		Rear	Cabriolet RWD N47D20A/N47D20C		Flexible Coupling	533878	
	2007.09-2010.02		Front;Rear	Cabriolet RWD N47D20A/N47D20C		Flexible Coupling	517955	
	2007.09-2010.02		Front	Cabriolet RWD N47D20A/N47D20C		Flexible Coupling Kit	517955S	
2.0 (147 kw)	2010.03-2013.10		Front	Cabriolet RWD N47D20C		Flexible Coupling	510596	
	2010.03-2013.10		Rear	Cabriolet RWD N47D20C		Flexible Coupling	533878	
	2010.03-2013.10		Front;Rear	Cabriolet RWD N47D20C		Flexible Coupling	517955	
	2010.03-2013.10		Front	Cabriolet RWD N47D20C		Flexible Coupling Kit	517955S	
320d Compact								
2.0 (110 kw)	2001.10-2005.02		Centre	Hatchback RWD M47D204D4		Center Bearing Support	512301	
	2001.10-2005.02		Centre	Hatchback RWD M47D204D4		Center Bearing Support	530154	
	2001.10-2005.02		Front	Hatchback RWD M47D204D4		Flexible Coupling	510596	
	2001.10-2005.02		Front	Hatchback RWD M47D204D4		Flexible Coupling Kit	510596S	
320d Coupe								
2.0 (110 kw)	2003.08-2006.07		Centre	Coupe RWD M47D204D4		Center Bearing Support	512301	
	2003.08-2006.07		Front	Coupe RWD M47D204D4		Flexible Coupling	510596	
	2003.08-2006.07		Front	Coupe RWD M47D204D4		Flexible Coupling Kit	510596S	
2.0 (120 kw)	2007.03-2013.06		Front	Coupe RWD N47D20A/N47D20C		Flexible Coupling	510596	
	2007.03-2013.06		Rear	Coupe RWD N47D20A/N47D20C		Flexible Coupling	533878	
	2007.03-2013.06		Front;Rear	Coupe RWD N47D20A/N47D20C		Flexible Coupling	517955	
	2007.03-2013.06		Front	Coupe RWD N47D20A/N47D20C		Flexible Coupling Kit	517955S	
2.0 (130 kw)	2006.09-2010.02		Centre	Coupe RWD N47D20A/N47D20C		Center Bearing Support	530151	
	2006.09-2010.02		Front	Coupe RWD N47D20A/N47D20C		Flexible Coupling	510596	
	2006.09-2010.02		Rear	Coupe RWD N47D20A/N47D20C		Flexible Coupling	533878	
	2006.09-2010.02		Front;Rear	Coupe RWD N47D20A/N47D20C		Flexible Coupling	517955	
	2006.09-2010.02		Front	Coupe RWD N47D20A/N47D20C		Flexible Coupling Kit	510596S	
	2006.09-2010.02		Front	Coupe RWD N47D20A/N47D20C		Flexible Coupling Kit	517955S	
2.0 (135 kw)	2010.03-		Centre	Coupe RWD N47D20C		Center Bearing Support	530151	
	2010.03-		Front	Coupe RWD N47D20C		Flexible Coupling	510596	
	2010.03-		Rear	Coupe RWD N47D20C		Flexible Coupling	533878	
	2010.03-		Front;Rear	Coupe RWD N47D20C		Flexible Coupling	517955	
	2010.03-		Front	Coupe RWD N47D20C		Flexible Coupling Kit	510596S	
	2010.03-		Front	Coupe RWD N47D20C		Flexible Coupling Kit	517955S	
2.0 (145 kw)	2006.09-2010.02		Front	Coupe RWD N47D20A/N47D20C		Flexible Coupling	510596	
	2006.09-2010.02		Rear	Coupe RWD N47D20A/N47D20C		Flexible Coupling	533878	
	2006.09-2010.02		Front;Rear	Coupe RWD N47D20A/N47D20C		Flexible Coupling	517955	
	2006.09-2010.02		Front	Coupe RWD N47D20A/N47D20C		Flexible Coupling Kit	517955S	
2.0 (147 kw)	2010.03-2013.06		Rear	Coupe RWD N47D20C		Flexible Coupling	533878	
	2010.03-2013.06		Front;Rear	Coupe RWD N47D20C		Flexible Coupling	517955	
	2010.03-2013.06		Front	Coupe RWD N47D20C		Flexible Coupling Kit	517955S	
320d Gran Turismo								
2.0 (120 kw)	2013.03-		Front	Hatchback RWD B47D20A/N47D20C		Flexible Coupling	510596	
	2013.03-		Rear	Hatchback RWD B47D20A/N47D20C		Flexible Coupling	537625	
	2013.03-		Front;Rear	Hatchback RWD B47D20A/N47D20C		Flexible Coupling	517955	
	2013.03-		Front	Hatchback RWD B47D20A/N47D20C		Flexible Coupling Kit	517955S	
	2013.03-		Rear	Hatchback RWD B47D20A/N47D20C		Flexible Coupling Kit	537625S	
2.0 (135 kw)	2013.03-2015.06		Front	Hatchback RWD N47D20C		Flexible Coupling	510596	
	2013.03-2015.06		Rear	Hatchback RWD N47D20C		Flexible Coupling	537625	
	2013.03-2015.06		Front;Rear	Hatchback RWD N47D20C		Flexible Coupling	517955	
	2013.03-2015.06		Front	Hatchback RWD N47D20C		Flexible Coupling Kit	510596S	
	2013.03-2015.06		Front	Hatchback RWD N47D20C		Flexible Coupling Kit	517955S	
2.0 (140 kw)	2015.07-		Front	Hatchback RWD B47D20A		Flexible Coupling	510596	
	2015.07-		Rear	Hatchback RWD B47D20A		Flexible Coupling	537625	
	2015.07-		Rear	Hatchback RWD B47D20A		Flexible Coupling Kit	537625S	
	2.0 (147 kw)	2013.03-2015.06		Front	Hatchback RWD N47D20C		Flexible Coupling	510596
		2013.03-2015.06		Rear	Hatchback RWD N47D20C		Flexible Coupling	537625
2013.03-2015.06			Front;Rear	Hatchback RWD N47D20C		Flexible Coupling	517955	
2013.03-2015.06			Front	Hatchback RWD N47D20C		Flexible Coupling Kit	517955S	
2013.03-2015.06		Rear	Hatchback RWD N47D20C		Flexible Coupling Kit	537625S		



	 YEAR	TRANSM.	FITTING POSITION	BODY STYLE & DRIVE TYPE & ENGINE	REMARKS	 PRODUCT	GSP Ref.
BMW							
320d Touring							
2.0 (100 kw)	1999.08-2001.06		Centre	Estate RWD M47D204D1		Center Bearing Support	512301
	1999.08-2001.06		Centre	Estate RWD M47D204D1		Center Bearing Support	530154
	1999.08-2001.06		Front	Estate RWD M47D204D1		Flexible Coupling	510596
	1999.08-2001.06		Front	Estate RWD M47D204D1		Flexible Coupling Kit	510596S
2.0 (110 kw)	2001.09-2005.02		Centre	Estate RWD M47D204D4		Center Bearing Support	512301
	2001.09-2005.02		Centre	Estate RWD M47D204D4		Center Bearing Support	530154
	2001.09-2005.02		Front	Estate RWD M47D204D4		Flexible Coupling	510596
	2001.09-2005.02		Front	Estate RWD M47D204D4		Flexible Coupling Kit	510596S
	2004.12-2007.08		Centre	Estate RWD M47D204D4		Center Bearing Support	530151
	2004.12-2007.08		Front	Estate RWD M47D204D4		Flexible Coupling	510596
	2004.12-2007.08		Rear	Estate RWD M47D204D4		Flexible Coupling	533878
	2004.12-2007.08		Front	Estate RWD M47D204D4		Flexible Coupling Kit	510596S
	2004.12-2007.08		Front	Estate RWD M47D204D4		Flexible Coupling Kit	510596S
2.0 (120 kw)	2005.06-2012.06		Centre	Estate RWD M47D204D4/N47D20A/N47D20C		Center Bearing Support	530151
	2005.06-2012.06		Front	Estate RWD M47D204D4/N47D20A/N47D20C		Flexible Coupling	510596
	2005.06-2012.06		Rear	Estate RWD M47D204D4/N47D20A/N47D20C		Flexible Coupling	533878
	2005.06-2012.06		Front;Rear	Estate RWD M47D204D4/N47D20A/N47D20C		Flexible Coupling	517955
	2005.06-2012.06		Front	Estate RWD M47D204D4/N47D20A/N47D20C		Flexible Coupling Kit	510596S
	2005.06-2012.06		Front	Estate RWD M47D204D4/N47D20A/N47D20C		Flexible Coupling Kit	517955S
	2012.07-2019.06		Front	Estate RWD B47D20A/N47D20C		Flexible Coupling	510596
	2012.07-2019.06		Rear	Estate RWD B47D20A/N47D20C		Flexible Coupling	537625
	2012.07-2019.06		Front;Rear	Estate RWD B47D20A/N47D20C		Flexible Coupling	517955
	2012.07-2019.06		Front	Estate RWD B47D20A/N47D20C		Flexible Coupling Kit	510596S
	2012.07-2019.06		Front	Estate RWD B47D20A/N47D20C		Flexible Coupling Kit	517955S
	2012.07-2019.06		Rear	Estate RWD B47D20A/N47D20C		Flexible Coupling Kit	537625S
	2012.07-2019.06		Rear	Estate RWD B47D20A/N47D20C		Flexible Coupling Kit	537625S
2.0 (130 kw)	2007.06-2012.10		Centre	Estate RWD N47D20A/N47D20C		Center Bearing Support	530151
	2007.06-2012.10		Front	Estate RWD N47D20A/N47D20C		Flexible Coupling	510596
	2007.06-2012.10		Rear	Estate RWD N47D20A/N47D20C		Flexible Coupling	533878
	2007.06-2012.10		Front;Rear	Estate RWD N47D20A/N47D20C		Flexible Coupling	517955
	2007.06-2012.10		Front	Estate RWD N47D20A/N47D20C		Flexible Coupling Kit	510596S
	2007.06-2012.10		Front	Estate RWD N47D20A/N47D20C		Flexible Coupling Kit	517955S
2.0 (135 kw)	2010.03-2012.10		Centre	Estate RWD N47D20C		Center Bearing Support	530151
	2010.03-2012.10		Front	Estate RWD N47D20C		Flexible Coupling	510596
	2010.03-2012.10		Rear	Estate RWD N47D20C		Flexible Coupling	533878
	2010.03-2012.10		Front;Rear	Estate RWD N47D20C		Flexible Coupling	517955
	2010.03-2012.10		Front	Estate RWD N47D20C		Flexible Coupling Kit	510596S
	2010.03-2012.10		Front	Estate RWD N47D20C		Flexible Coupling Kit	517955S
	2012.07-2016.02		Front	Estate RWD N47D20C		Flexible Coupling	510596
	2012.07-2016.02		Rear	Estate RWD N47D20C		Flexible Coupling	537625
	2012.07-2016.02		Front;Rear	Estate RWD N47D20C		Flexible Coupling	517955
	2012.07-2016.02		Front	Estate RWD N47D20C		Flexible Coupling Kit	510596S
	2012.07-2016.02		Front	Estate RWD N47D20C		Flexible Coupling Kit	517955S
	2012.07-2016.02		Rear	Estate RWD N47D20C		Flexible Coupling Kit	537625S
	2012.07-2016.02		Rear	Estate RWD N47D20C		Flexible Coupling Kit	537625S
2.0 (140 kw)	2015.07-2019.06		Front	Estate RWD B47D20A		Flexible Coupling	510596
	2015.07-2019.06		Rear	Estate RWD B47D20A		Flexible Coupling	537625
	2015.07-2019.06		Front;Rear	Estate RWD B47D20A		Flexible Coupling	517955
	2015.07-2019.06		Front	Estate RWD B47D20A		Flexible Coupling Kit	517955S
	2015.07-2019.06		Rear	Estate RWD B47D20A		Flexible Coupling Kit	537625S
2.0 (145 kw)	2007.02-2010.02		Front	Estate RWD N47D20A/N47D20C		Flexible Coupling	510596
	2007.02-2010.02		Rear	Estate RWD N47D20A/N47D20C		Flexible Coupling	533878
	2007.02-2010.02		Front;Rear	Estate RWD N47D20A/N47D20C		Flexible Coupling	517955
	2007.02-2010.02		Front	Estate RWD N47D20A/N47D20C		Flexible Coupling Kit	517955S
2.0 (147 kw)	2010.03-2012.05		Front	Estate RWD N47D20C		Flexible Coupling	510596
	2010.03-2012.05		Rear	Estate RWD N47D20C		Flexible Coupling	533878
	2010.03-2012.05		Front;Rear	Estate RWD N47D20C		Flexible Coupling	517955
	2010.03-2012.05		Front	Estate RWD N47D20C		Flexible Coupling Kit	517955S
	2012.07-2016.02		Front	Estate RWD N47D20C		Flexible Coupling	510596
	2012.07-2016.02		Rear	Estate RWD N47D20C		Flexible Coupling	537625
	2012.07-2016.02		Front;Rear	Estate RWD N47D20C		Flexible Coupling	517955
	2012.07-2016.02		Front	Estate RWD N47D20C		Flexible Coupling Kit	517955S
2012.07-2016.02		Rear	Estate RWD N47D20C		Flexible Coupling Kit	537625S	
320d xDrive							
2.0 (120 kw)	2008.07-2011.12		Rear	Saloon 4WD N47D20C		Flexible Coupling	533878
	2012.08-2018.10		Centre	Saloon 4WD B47D20A/N47D20C		Center Bearing Support	530151
	2012.08-2018.10		Rear	Saloon 4WD B47D20A/N47D20C		Flexible Coupling	537625



	 YEAR	TRANSM.	FITTING POSITION	BODY STYLE & DRIVE TYPE & ENGINE	REMARKS	 PRODUCT	GSP Ref.
BMW							
320d xDrive							
2.0 (120 kw)	2012.08-2018.10		Front;Rear	Saloon 4WD B47D20A/N47D20C		Flexible Coupling	517955
	2012.08-2018.10		Front	Saloon 4WD B47D20A/N47D20C		Flexible Coupling Kit	517955S
	2012.08-2018.10		Rear	Saloon 4WD B47D20A/N47D20C		Flexible Coupling Kit	537625S
	2018.11-2020.02	AT	Front	Saloon 4WD B47D20B		Propshaft	PS900139
	2018.11-2020.02		Front	Saloon 4WD B47D20B		Flexible Coupling	537631
2.0 (130 kw)	2018.11-2020.02		Rear	Saloon 4WD B47D20B		Flexible Coupling	537625
	2008.09-2010.02		Centre	Saloon 4WD N47D20A/N47D20C		Center Bearing Support	530151
2.0 (135 kw)	2008.09-2010.02		Front	Saloon 4WD N47D20A/N47D20C		Flexible Coupling	517956
	2008.09-2010.02		Rear	Saloon 4WD N47D20A/N47D20C		Flexible Coupling	533878
	2010.03-2011.10		Front	Saloon 4WD N47D20C		Flexible Coupling	517956
2.0 (140 kw)	2010.03-2011.10		Rear	Saloon 4WD N47D20C		Flexible Coupling	533878
	2012.08-2015.06	AT/MT	Front	Saloon 4WD N47D20C	Date From:2013.01	Propshaft	PS900112
	2012.08-2015.06		Centre	Saloon 4WD N47D20C		Center Bearing Support	530151
	2012.08-2015.06		Rear	Saloon 4WD N47D20C		Flexible Coupling	537625
	2012.08-2015.06		Front;Rear	Saloon 4WD N47D20C		Flexible Coupling	517955
	2012.08-2015.06		Front	Saloon 4WD N47D20C		Flexible Coupling Kit	517955S
	2012.08-2015.06		Rear	Saloon 4WD N47D20C		Flexible Coupling Kit	537625S
	2012.08-2015.06		Rear	Saloon 4WD N47D20C		Flexible Coupling	537625
2.0 (147 kw)	2015.07-2018.10		Front	Saloon 4WD B47D20A		Flexible Coupling	510596
	2015.07-2018.10		Rear	Saloon 4WD B47D20A		Flexible Coupling	537625
	2015.07-2018.10		Rear	Saloon 4WD B47D20A		Flexible Coupling Kit	537625S
	2018.11-2020.02	AT	Front	Saloon 4WD B47D20B		Propshaft	PS900139
	2018.11-2020.02		Front	Saloon 4WD B47D20B		Flexible Coupling	537631
2.0 (147 kw)	2018.11-2020.02		Rear	Saloon 4WD B47D20B		Flexible Coupling	537625
	2012.08-2015.06	AT/MT	Front	Saloon 4WD N47D20C	Date From:2013.01	Propshaft	PS900112
	2012.08-2015.06		Rear	Saloon 4WD N47D20C		Flexible Coupling	537625
	2012.08-2015.06		Front;Rear	Saloon 4WD N47D20C		Flexible Coupling	517955
	2012.08-2015.06		Front	Saloon 4WD N47D20C		Flexible Coupling Kit	517955S
2012.08-2015.06		Rear	Saloon 4WD N47D20C		Flexible Coupling Kit	537625S	
320d xDrive Coupe							
2.0 (120 kw)	2008.09-2013.06		Rear	Coupe 4WD N47D20C		Flexible Coupling	533878
2.0 (130 kw)	2008.09-2010.02		Rear	Coupe 4WD N47D20C		Flexible Coupling	533878
2.0 (135 kw)	2010.03-2013.06		Centre	Coupe 4WD N47D20C		Center Bearing Support	530151
	2010.03-2013.06		Front	Coupe 4WD N47D20C		Flexible Coupling	517956
	2010.03-2013.06		Rear	Coupe 4WD N47D20C		Flexible Coupling	533878
2.0 (145 kw)	2008.09-2010.02		Rear	Coupe 4WD N47D20C		Flexible Coupling	533878
2.0 (147 kw)	2010.03-2013.06		Rear	Coupe 4WD N47D20C		Flexible Coupling	533878
320d xDrive Gran Turismo							
2.0 (120 kw)	2013.07-		Rear	Hatchback 4WD B47D20A/N47D20C		Flexible Coupling	537625
	2013.07-		Front;Rear	Hatchback 4WD B47D20A/N47D20C		Flexible Coupling	517955
	2013.07-		Front	Hatchback 4WD B47D20A/N47D20C		Flexible Coupling Kit	517955S
	2013.07-		Rear	Hatchback 4WD B47D20A/N47D20C		Flexible Coupling Kit	537625S
2.0 (135 kw)	2013.07-2015.06		Rear	Hatchback 4WD N47D20C		Flexible Coupling	537625
	2013.07-2015.06		Front;Rear	Hatchback 4WD N47D20C		Flexible Coupling	517955
	2013.07-2015.06		Front	Hatchback 4WD N47D20C		Flexible Coupling Kit	517955S
	2013.07-2015.06		Rear	Hatchback 4WD N47D20C		Flexible Coupling Kit	537625S
2.0 (140 kw)	2015.07-		Rear	Hatchback 4WD B47D20A		Flexible Coupling	537625
	2015.07-		Rear	Hatchback 4WD B47D20A		Flexible Coupling Kit	537625S
2.0 (147 kw)	2013.07-2015.06		Rear	Hatchback 4WD N47D20C		Flexible Coupling	537625
	2013.07-2015.06		Front;Rear	Hatchback 4WD N47D20C		Flexible Coupling	517955
	2013.07-2015.06		Front	Hatchback 4WD N47D20C		Flexible Coupling Kit	517955S
	2013.07-2015.06		Rear	Hatchback 4WD N47D20C		Flexible Coupling Kit	537625S
320d xDrive Touring							
2.0 (120 kw)	2009.07-2012.10		Rear	Estate 4WD N47D20C		Flexible Coupling	533878
	2012.06-2019.06		Front	Estate 4WD B47D20A/N47D20C		Flexible Coupling	510596
	2012.06-2019.06		Rear	Estate 4WD B47D20A/N47D20C		Flexible Coupling	537625
	2012.06-2019.06		Front;Rear	Estate 4WD B47D20A/N47D20C		Flexible Coupling	517955
	2012.06-2019.06		Front	Estate 4WD B47D20A/N47D20C		Flexible Coupling Kit	517955S
	2012.06-2019.06		Rear	Estate 4WD B47D20A/N47D20C		Flexible Coupling Kit	537625S
	2019.07-2020.02	AT	Front	Estate 4WD B47D20B		Propshaft	PS900139
	2019.07-2020.02		Rear	Estate 4WD B47D20B		Flexible Coupling	537625
2.0 (130 kw)	2008.09-2010.02		Centre	Estate 4WD N47D20C		Center Bearing Support	530151
	2008.09-2010.02		Front	Estate 4WD N47D20C		Flexible Coupling	517956
	2008.09-2010.02		Rear	Estate 4WD N47D20C		Flexible Coupling	533878

	 YEAR	TRANSM.	FITTING POSITION	BODY STYLE & DRIVE TYPE & ENGINE	REMARKS	 PRODUCT	GSP Ref.
BMW							
320d xDrive Touring							
2.0 (135 kw)	2010.03-2012.06		Centre	Estate 4WD N47D20C		Center Bearing Support	530151
	2010.03-2012.06		Front	Estate 4WD N47D20C		Flexible Coupling	517956
	2010.03-2012.06		Rear	Estate 4WD N47D20C		Flexible Coupling	533878
	2013.03-2015.06		Rear	Estate 4WD N47D20C		Flexible Coupling	537625
	2013.03-2015.06		Front;Rear	Estate 4WD N47D20C		Flexible Coupling	517955
	2013.03-2015.06		Front	Estate 4WD N47D20C		Flexible Coupling Kit	517955S
	2013.03-2015.06		Rear	Estate 4WD N47D20C		Flexible Coupling Kit	537625S
2.0 (140 kw)	2015.07-2019.06		Front	Estate 4WD B47D20A		Flexible Coupling	510596
	2015.07-2019.06		Rear	Estate 4WD B47D20A		Flexible Coupling	537625
	2015.07-2019.06		Rear	Estate 4WD B47D20A		Flexible Coupling Kit	537625S
	2019.07-2020.02	AT	Front	Estate 4WD B47D20B		Propshaft	PS900139
	2019.07-2020.02	AT	Front	Combi van 4WD B47D20B		Propshaft	PS900139
	2019.07-2020.02		Rear	Estate 4WD B47D20B		Flexible Coupling	537625
2.0 (147 kw)	2010.03-2012.05		Rear	Estate 4WD N47D20C		Flexible Coupling	533878
	2013.03-2015.06		Rear	Estate 4WD N47D20C		Flexible Coupling	537625
	2013.03-2015.06		Front;Rear	Estate 4WD N47D20C		Flexible Coupling	517955
	2013.03-2015.06		Front	Estate 4WD N47D20C		Flexible Coupling Kit	517955S
	2013.03-2015.06		Rear	Estate 4WD N47D20C		Flexible Coupling Kit	537625S
320i							
1.6 (125 kw)	2012.11-2016.06		Front	Saloon RWD N13B16A		Flexible Coupling	510596
	2012.11-2016.06		Rear	Saloon RWD N13B16A		Flexible Coupling	537625
	2012.11-2016.06		Front	Saloon RWD N13B16A		Flexible Coupling Kit	510596S
	2012.11-2016.06		Rear	Saloon RWD N13B16A		Flexible Coupling Kit	537625S
	2019.03-		Front	Saloon RWD B48B16A		Flexible Coupling	533422
	2019.03-		Rear	Saloon RWD B48B16A		Flexible Coupling	537625
2.0 (110 kw)	1991.01-1998.02		Centre	Saloon RWD M50B206S1/M50B206S2/M52B206S3		Center Bearing Support	510659
	1991.01-1998.02		Front	Saloon RWD M50B206S1/M50B206S2/M52B206S3		Flexible Coupling	510597
	1991.01-1998.02		Front	Saloon RWD M50B206S1/M50B206S2/M52B206S3		Flexible Coupling	510641
	1991.01-1998.02		Front	Saloon RWD M50B206S1/M50B206S2/M52B206S3		Flexible Coupling Kit	510597S
	1991.01-1998.02		Front	Saloon RWD M50B206S1/M50B206S2/M52B206S3		Flexible Coupling Kit	510641S
	1998.02-2000.07		Centre	Saloon RWD M52B206S4		Center Bearing Support	512301
	1998.02-2000.07		Front	Saloon RWD M52B206S4		Flexible Coupling	510596
	1998.02-2000.07		Front	Saloon RWD M52B206S4		Flexible Coupling	510597
	1998.02-2000.07		Front	Saloon RWD M52B206S4		Flexible Coupling Kit	510596S
	1998.02-2000.07		Front	Saloon RWD M52B206S4		Flexible Coupling Kit	510597S
	2004.12-2007.08	AT	Rear	Saloon RWD N46B20B/N46B20C/N46B20CB	Date From:2005.01	Propshaft	PS900125
	2004.12-2007.08		Centre	Saloon RWD N46B20B/N46B20C/N46B20CB		Center Bearing Support	530151
	2004.12-2007.08		Front	Saloon RWD N46B20B/N46B20C/N46B20CB		Flexible Coupling	510596
2.0 (115 kw)	2007.02-2011.12	AT	Rear	Saloon RWD N46B20B/N46B20C		Propshaft	PS900125
	2007.02-2011.12		Front	Saloon RWD N46B20B/N46B20C		Flexible Coupling	510596
	2007.02-2011.12		Front	Saloon RWD N46B20B/N46B20C		Flexible Coupling	510641
2.0 (120 kw)	2007.03-2011.12		Front	Saloon RWD N43B20A		Flexible Coupling	510596
	2007.03-2011.12		Front	Saloon RWD N43B20A		Flexible Coupling	510641
2.0 (125 kw)	2009.07-2011.10	AT	Rear	Saloon RWD N43B20A		Propshaft	PS900125
	2009.07-2011.10		Centre	Saloon RWD N43B20A		Center Bearing Support	530151
	2009.07-2011.10		Front	Saloon RWD N43B20A		Flexible Coupling	510596
	2009.07-2011.10		Front	Saloon RWD N43B20A		Flexible Coupling	510641
	2009.07-2011.10		Front	Saloon RWD N43B20A		Flexible Coupling Kit	510596S
	2009.07-2011.10		Front	Saloon RWD N43B20A		Flexible Coupling Kit	510641S
2.0 (127 kw)	2005.09-2006.08	AT	Rear	Saloon RWD N45B20A		Propshaft	PS900125
	2005.09-2006.08		Centre	Saloon RWD N45B20A		Center Bearing Support	530151
	2005.09-2006.08		Front	Saloon RWD N45B20A		Flexible Coupling	510641
	2005.09-2006.08		Front	Saloon RWD N45B20A		Flexible Coupling Kit	510641S
2.0 (134 kw)	2012.03-2018.10		Front	Saloon RWD N20B20A		Flexible Coupling Kit	510596S
	2012.03-2018.10		Rear	Saloon RWD N20B20A		Flexible Coupling Kit	537625S
2.0 (135 kw)	2012.03-2018.10		Centre	Saloon RWD N20B20A/N20B20B		Center Bearing Support	530151
	2012.03-2018.10		Front	Saloon RWD N20B20A/N20B20B		Flexible Coupling	510596
	2012.03-2018.10		Front	Saloon RWD N20B20A/N20B20B		Flexible Coupling	510597
	2012.03-2018.10		Rear	Saloon RWD N20B20A/N20B20B		Flexible Coupling	537625
	2012.03-2018.10		Front	Saloon RWD N20B20A/N20B20B		Flexible Coupling Kit	510596S
	2012.03-2018.10		Rear	Saloon RWD N20B20A/N20B20B		Flexible Coupling Kit	537625S
	2015.07-2018.10		Front	Saloon RWD B48B20A		Flexible Coupling	510596
	2015.07-2018.10		Rear	Saloon RWD B48B20A		Flexible Coupling	537625
	2015.07-2018.10		Front	Saloon RWD B48B20A		Flexible Coupling Kit	510596S
	2015.07-2018.10		Front	Saloon RWD B48B20A		Flexible Coupling Kit	510596S



	 YEAR	TRANSM.	FITTING POSITION	BODY STYLE & DRIVE TYPE & ENGINE	REMARKS	 PRODUCT	GSP Ref.
BMW 320i							
2.0 (135 kw)	2015.07-2018.10		Rear	Saloon RWD B48B20A		Flexible Coupling Kit	537625S
2.2 (120 kw)	2000.08-2005.02	MT	Rear	Saloon RWD M54B226S1		Propshaft	PS900114
	2000.08-2005.02		Front	Saloon RWD M54B226S1		Flexible Coupling	510596
2.2 (125 kw)	2000.09-2005.02	MT	Rear	Saloon RWD M54B226S1		Propshaft	PS900114
	2000.09-2005.02		Centre	Saloon RWD M54B226S1		Center Bearing Support	512301
	2000.09-2005.02		Front	Saloon RWD M54B226S1		Flexible Coupling	510596
	2000.09-2005.02		Front	Saloon RWD M54B226S1	MT	Flexible Coupling	510597
	2000.09-2005.02		Front	Saloon RWD M54B226S1		Flexible Coupling Kit	510596S
	2000.09-2005.02		Front	Saloon RWD M54B226S1		Flexible Coupling Kit	510597S
320i Cabrio							
2.0 (93 kw)	1987.07-1993.10		Front	Cabriolet RWD M20B206KA		Flexible Coupling	510641
2.0 (95 kw)	1986.04-1993.10		Centre	Cabriolet RWD M20B206EB/M20B206EE/M20B206KA		Center Bearing Support	510599
	1986.04-1993.10		Centre	Cabriolet RWD M20B206EB/M20B206EE/M20B206KA		Center Bearing Support	510627
	1986.04-1993.10		Front	Cabriolet RWD M20B206EB/M20B206EE/M20B206KA		Flexible Coupling	510641
2.0 (110 kw)	1993.12-1999.11		Centre	Cabriolet RWD M50B206S2/M52B206S3		Center Bearing Support	510659
	1993.12-1999.11		Front	Cabriolet RWD M50B206S2/M52B206S3		Flexible Coupling	510597
	1993.12-1999.11		Front	Cabriolet RWD M50B206S2/M52B206S3		Flexible Coupling	510641
	1993.12-1999.11		Front	Cabriolet RWD M50B206S2/M52B206S3		Flexible Coupling Kit	510597S
	1993.12-1999.11		Front	Cabriolet RWD M50B206S2/M52B206S3		Flexible Coupling Kit	510641S
2.0 (115 kw)	2007.01-2013.08		Front	Cabriolet RWD N46B20B		Flexible Coupling	510596
	2007.01-2013.08		Front	Cabriolet RWD N46B20B		Flexible Coupling	510641
2.0 (120 kw)	2007.01-		Front	Cabriolet RWD N43B20A		Flexible Coupling	510596
	2007.01-		Front	Cabriolet RWD N43B20A		Flexible Coupling	510641
2.0 (125 kw)	2007.03-2013.10		Centre	Cabriolet RWD N43B20A		Center Bearing Support	530151
	2007.03-2013.10		Front	Cabriolet RWD N43B20A		Flexible Coupling	510596
	2007.03-2013.10		Front	Cabriolet RWD N43B20A		Flexible Coupling	510641
	2007.03-2013.10		Front	Cabriolet RWD N43B20A		Flexible Coupling Kit	510596S
	2007.03-2013.10		Front	Cabriolet RWD N43B20A		Flexible Coupling Kit	510641S
2.2 (120 kw)	2000.08-2007.12	MT	Rear	Cabriolet RWD M54B226S1		Propshaft	PS900114
	2000.08-2007.12		Front	Cabriolet RWD M54B226S1		Flexible Coupling	510596
2.2 (125 kw)	2000.08-2007.02	MT	Rear	Cabriolet RWD M54B226S1		Propshaft	PS900114
	2000.08-2007.02		Centre	Cabriolet RWD M54B226S1		Center Bearing Support	512301
	2000.08-2007.02		Front	Cabriolet RWD M54B226S1		Flexible Coupling	510596
	2000.08-2007.02		Front	Cabriolet RWD M54B226S1	MT	Flexible Coupling	510597
	2000.08-2007.02		Front	Cabriolet RWD M54B226S1		Flexible Coupling Kit	510596S
	2000.08-2007.02		Front	Cabriolet RWD M54B226S1		Flexible Coupling Kit	510597S
320i Coupe							
2.0 (110 kw)	1991.12-1998.11		Centre	Coupe RWD M50B206S1/M50B206S2/M52B206S3		Center Bearing Support	510659
	1991.12-1998.11		Front	Coupe RWD M50B206S1/M50B206S2/M52B206S3		Flexible Coupling	510597
	1991.12-1998.11		Front	Coupe RWD M50B206S1/M50B206S2/M52B206S3		Flexible Coupling	510641
	1991.12-1998.11		Front	Coupe RWD M50B206S1/M50B206S2/M52B206S3		Flexible Coupling Kit	510597S
	1991.12-1998.11		Front	Coupe RWD M50B206S1/M50B206S2/M52B206S3		Flexible Coupling Kit	510641S
	1999.07-2000.07		Centre	Coupe RWD M52B206S4		Center Bearing Support	512301
	1999.07-2000.07		Front	Coupe RWD M52B206S4		Flexible Coupling	510596
	1999.07-2000.07		Front	Coupe RWD M52B206S4		Flexible Coupling	510597
	1999.07-2000.07		Front	Coupe RWD M52B206S4		Flexible Coupling Kit	510596S
	1999.07-2000.07		Front	Coupe RWD M52B206S4		Flexible Coupling Kit	510597S
2.0 (115 kw)	2007.06-2013.12	AT	Rear	Coupe RWD N46B20B		Propshaft	PS900125
	2007.06-2013.12		Front	Coupe RWD N46B20B		Flexible Coupling	510596
2.0 (120 kw)	2008.09-	AT	Rear	Coupe RWD N43B20A	Date From:2008.01	Propshaft	PS900125
	2008.09-		Front	Coupe RWD N43B20A		Flexible Coupling	510596
	2008.09-		Front	Coupe RWD N43B20A		Flexible Coupling	510641
2.0 (125 kw)	2007.06-	AT	Rear	Coupe RWD N43B20A		Propshaft	PS900125
	2007.06-		Centre	Coupe RWD N43B20A		Center Bearing Support	530151
	2007.06-		Front	Coupe RWD N43B20A		Flexible Coupling	510596
	2007.06-		Front	Coupe RWD N43B20A		Flexible Coupling	510641
	2007.06-		Front	Coupe RWD N43B20A		Flexible Coupling Kit	510596S
	2007.06-		Front	Coupe RWD N43B20A		Flexible Coupling Kit	510641S
2.2 (120 kw)	2001.01-2003.12	MT	Rear	Coupe RWD M54B226S1		Propshaft	PS900114
	2001.01-2003.12		Front	Coupe RWD M54B226S1		Flexible Coupling	510596
2.2 (125 kw)	2000.08-2006.07	MT	Rear	Coupe RWD M54B226S1		Propshaft	PS900114
	2000.08-2006.07		Centre	Coupe RWD M54B226S1		Center Bearing Support	512301
	2000.08-2006.07		Front	Coupe RWD M54B226S1		Flexible Coupling	510596
	2000.08-2006.07		Front	Coupe RWD M54B226S1	MT	Flexible Coupling	510597



	 YEAR	TRANSM.	FITTING POSITION	BODY STYLE & DRIVE TYPE & ENGINE	REMARKS	 PRODUCT	GSP Ref.
BMW							
320i Coupe							
2.2 (125 kw)	2000.08-2006.07		Front	Coupe RWD M54B226S1		Flexible Coupling Kit	510596S
	2000.08-2006.07		Front	Coupe RWD M54B226S1		Flexible Coupling Kit	510597S
320i Gran Turismo							
2.0 (120 kw)	2013.03-2016.06		Front	Hatchback RWD N20B20A		Flexible Coupling	510596
	2013.03-2016.06		Rear	Hatchback RWD N20B20A		Flexible Coupling	537625
	2013.03-2016.06		Front	Hatchback RWD N20B20A		Flexible Coupling Kit	510596S
	2013.03-2016.06		Rear	Hatchback RWD N20B20A		Flexible Coupling Kit	537625S
	2016.06-		Front	Hatchback RWD B48B20A		Flexible Coupling	510596
	2016.06-		Rear	Hatchback RWD B48B20A		Flexible Coupling	537625
2.0 (135 kw)	2013.03-2017.05		Front	Hatchback RWD N20B20A/N20B20B		Flexible Coupling	510596
	2013.03-2017.05		Front	Hatchback RWD N20B20A/N20B20B		Flexible Coupling	510597
	2013.03-2017.05		Rear	Hatchback RWD N20B20A/N20B20B		Flexible Coupling	537625
	2013.03-2017.05		Front	Hatchback RWD N20B20A/N20B20B		Flexible Coupling Kit	510596S
	2013.03-2017.05		Rear	Hatchback RWD N20B20A/N20B20B		Flexible Coupling Kit	537625S
	2016.06-		Front	Hatchback RWD B48B20A		Flexible Coupling	510596
	2016.06-		Rear	Hatchback RWD B48B20A		Flexible Coupling	537625
	2016.06-		Front	Hatchback RWD B48B20A		Flexible Coupling Kit	510596S
	2016.06-		Rear	Hatchback RWD B48B20A		Flexible Coupling Kit	537625S
320i Touring							
2.0 (110 kw)	1995.01-1999.04		Centre	Estate RWD M52B206S3		Center Bearing Support	510659
	1995.01-1999.04		Front	Estate RWD M52B206S3		Flexible Coupling	510597
	1995.01-1999.04		Front	Estate RWD M52B206S3		Flexible Coupling	510641
	1995.01-1999.04		Front	Estate RWD M52B206S3		Flexible Coupling Kit	510597S
	1995.01-1999.04		Front	Estate RWD M52B206S3		Flexible Coupling Kit	510641S
	1999.08-2000.07		Centre	Estate RWD M52B206S4		Center Bearing Support	512301
	1999.08-2000.07		Front	Estate RWD M52B206S4		Flexible Coupling	510596
	1999.08-2000.07		Front	Estate RWD M52B206S4		Flexible Coupling	510597
	1999.08-2000.07		Front	Estate RWD M52B206S4		Flexible Coupling Kit	510596S
	1999.08-2000.07		Front	Estate RWD M52B206S4		Flexible Coupling Kit	510597S
	2005.09-2012.12	AT	Rear	Estate RWD N46B20B/N46B20C		Propshaft	PS900125
	2005.09-2012.12		Centre	Estate RWD N46B20B/N46B20C		Center Bearing Support	530151
	2005.09-2012.12		Front	Estate RWD N46B20B/N46B20C		Flexible Coupling	510596
	2005.09-2012.12		Front	Estate RWD N46B20B/N46B20C		Flexible Coupling	510641
	2005.09-2012.12		Front	Estate RWD N46B20B/N46B20C		Flexible Coupling Kit	510596S
	2005.09-2012.12		Front	Estate RWD N46B20B/N46B20C		Flexible Coupling Kit	510641S
2.0 (120 kw)	2007.06-2012.05	AT	Rear	Estate RWD N43B20A		Propshaft	PS900125
	2007.06-2012.05		Front	Estate RWD N43B20A		Flexible Coupling	510596
	2007.06-2012.05		Front	Estate RWD N43B20A		Flexible Coupling	510641
	2012.11-2015.06		Front	Estate RWD N20B20B		Flexible Coupling	510596
	2012.11-2015.06		Rear	Estate RWD N20B20B		Flexible Coupling	537625
	2012.11-2015.06		Front	Estate RWD N20B20B		Flexible Coupling Kit	510596S
	2012.11-2015.06		Rear	Estate RWD N20B20B		Flexible Coupling Kit	537625S
2.0 (125 kw)	2007.06-2012.10	AT	Rear	Estate RWD N43B20A		Propshaft	PS900125
	2007.06-2012.10		Centre	Estate RWD N43B20A		Center Bearing Support	530151
	2007.06-2012.10		Front	Estate RWD N43B20A		Flexible Coupling	510596
	2007.06-2012.10		Front	Estate RWD N43B20A		Flexible Coupling	510641
	2007.06-2012.10		Front	Estate RWD N43B20A		Flexible Coupling Kit	510596S
	2007.06-2012.10		Front	Estate RWD N43B20A		Flexible Coupling Kit	510641S
2.0 (135 kw)	2012.11-2015.06		Front	Estate RWD N20B20B		Flexible Coupling	510596
	2012.11-2015.06		Front	Estate RWD N20B20B		Flexible Coupling	510597
	2012.11-2015.06		Rear	Estate RWD N20B20B		Flexible Coupling	537625
	2012.11-2015.06		Front	Estate RWD N20B20B		Flexible Coupling Kit	510596S
	2012.11-2015.06		Rear	Estate RWD N20B20B		Flexible Coupling Kit	537625S
	2015.07-2019.06		Front	Estate RWD B48B20A		Flexible Coupling	510596
	2015.07-2019.06		Rear	Estate RWD B48B20A		Flexible Coupling	537625
	2015.07-2019.06		Front	Estate RWD B48B20A		Flexible Coupling Kit	510596S
	2015.07-2019.06		Rear	Estate RWD B48B20A		Flexible Coupling Kit	537625S
2.2 (120 kw)	2000.09-2005.02	MT	Rear	Estate RWD M54B226S1		Propshaft	PS900114
	2000.09-2005.02		Front	Estate RWD M54B226S1		Flexible Coupling	510596
2.2 (125 kw)	2000.08-2005.02	MT	Rear	Estate RWD M54B226S1		Propshaft	PS900114
	2000.08-2005.02		Centre	Estate RWD M54B226S1		Center Bearing Support	512301
	2000.08-2005.02		Front	Estate RWD M54B226S1		Flexible Coupling	510596
	2000.08-2005.02		Front	Estate RWD M54B226S1	MT	Flexible Coupling	510597
	2000.08-2005.02		Front	Estate RWD M54B226S1		Flexible Coupling Kit	510596S



	 YEAR	TRANSM.	FITTING POSITION	BODY STYLE & DRIVE TYPE & ENGINE	REMARKS	 PRODUCT	GSP Ref.
BMW							
320i Touring							
2.2 (125 kw)	2000.08-2005.02		Front	Estate RWD M54B226S1		Flexible Coupling Kit	510597S
320i xDrive							
2.0 (135 kw)	2012.07-2018.10	AT/MT	Front	Saloon 4WD N20B20A/N20B20B	Date From:2013.01	Propshaft	PS900112
	2012.07-2018.10		Centre	Saloon 4WD N20B20A/N20B20B		Center Bearing Support	530151
	2012.07-2018.10		Rear	Saloon 4WD N20B20A/N20B20B		Flexible Coupling	537625
	2012.07-2018.10		Front;Rear	Saloon 4WD N20B20A/N20B20B		Flexible Coupling	517955
	2012.07-2018.10		Front	Saloon 4WD N20B20A/N20B20B		Flexible Coupling Kit	517955S
	2012.07-2018.10		Rear	Saloon 4WD N20B20A/N20B20B		Flexible Coupling Kit	537625S
	2015.07-2018.10		Front	Saloon 4WD B48B20A		Flexible Coupling	510596
	2015.07-2018.10		Rear	Saloon 4WD B48B20A		Flexible Coupling	537625
	2015.07-2018.10		Rear	Saloon 4WD B48B20A		Flexible Coupling Kit	537625S
	2019.07-		Front	Saloon 4WD B48B20A		Flexible Coupling	537631
	2019.07-		Rear	Saloon 4WD B48B20A		Flexible Coupling	537625
320i xDrive Gran Turismo							
2.0 (120 kw)	2013.07-2016.06		Rear	Hatchback 4WD N20B20A		Flexible Coupling	537625
	2013.07-2016.06		Front;Rear	Hatchback 4WD N20B20A		Flexible Coupling	517955
	2013.07-2016.06		Front	Hatchback 4WD N20B20A		Flexible Coupling Kit	517955S
	2013.07-2016.06		Rear	Hatchback 4WD N20B20A		Flexible Coupling Kit	537625S
	2016.07-		Front	Hatchback 4WD B48B20A		Flexible Coupling	510596
	2016.07-		Rear	Hatchback 4WD B48B20A		Flexible Coupling	537625
2.0 (135 kw)	2013.07-2016.06		Rear	Hatchback 4WD N20B20A		Flexible Coupling	537625
	2013.07-2016.06		Front;Rear	Hatchback 4WD N20B20A		Flexible Coupling	517955
	2013.07-2016.06		Front	Hatchback 4WD N20B20A		Flexible Coupling Kit	517955S
	2013.07-2016.06		Rear	Hatchback 4WD N20B20A		Flexible Coupling Kit	537625S
	2016.07-		Front	Hatchback 4WD B48B20A		Flexible Coupling	510596
	2016.07-		Rear	Hatchback 4WD B48B20A		Flexible Coupling	537625
	2016.07-		Front	Hatchback 4WD B48B20A		Flexible Coupling Kit	510596S
	2016.07-		Rear	Hatchback 4WD B48B20A		Flexible Coupling Kit	537625S
320i xDrive Touring							
2.0 (120 kw)	2013.03-2015.06		Rear	Estate 4WD N20B20B		Flexible Coupling	537625
	2013.03-2015.06		Front;Rear	Estate 4WD N20B20B		Flexible Coupling	517955
	2013.03-2015.06		Front	Estate 4WD N20B20B		Flexible Coupling Kit	517955S
	2013.03-2015.06		Rear	Estate 4WD N20B20B		Flexible Coupling Kit	537625S
2.0 (135 kw)	2013.03-2015.06		Rear	Estate 4WD N20B20B		Flexible Coupling	537625
	2013.03-2015.06		Front;Rear	Estate 4WD N20B20B		Flexible Coupling	517955
	2013.03-2015.06		Front	Estate 4WD N20B20B		Flexible Coupling Kit	517955S
	2013.03-2015.06		Rear	Estate 4WD N20B20B		Flexible Coupling Kit	537625S
	2015.07-2019.06		Front	Estate 4WD B48B20A		Flexible Coupling	510596
	2015.07-2019.06		Rear	Estate 4WD B48B20A		Flexible Coupling	537625
	2015.07-2019.06		Rear	Estate 4WD B48B20A		Flexible Coupling Kit	537625S
323i							
2.5 (120 kw)	1998.03-2000.09	AT	Rear	Saloon RWD M52B256S4	Total Length:1353mm	Propshaft	PS900113
	1998.03-2000.09	MT	Rear	Saloon RWD M52B256S4	Total Length:1554mm	Propshaft	PS900114
	1998.03-2000.09		Front	Saloon RWD M52B256S4		Flexible Coupling	510596
2.5 (125 kw)	1995.05-1998.11		Centre	Saloon RWD M52B256S3		Center Bearing Support	510659
	1995.05-1998.11		Front	Saloon RWD M52B256S3		Flexible Coupling	510596
	1995.05-1998.11		Front	Saloon RWD M52B256S3		Flexible Coupling	510597
	1995.05-1998.11		Front	Saloon RWD M52B256S3		Flexible Coupling Kit	510596S
	1995.05-1998.11		Front	Saloon RWD M52B256S3		Flexible Coupling Kit	510597S
	1998.03-2000.09	AT	Rear	Saloon RWD M52B256S4	Total Length:1353mm	Propshaft	PS900113
	1998.03-2000.09	MT	Rear	Saloon RWD M52B256S4	Total Length:1554mm	Propshaft	PS900114
	1998.03-2000.09		Centre	Saloon RWD M52B256S4		Center Bearing Support	512301
	1998.03-2000.09		Front	Saloon RWD M52B256S4		Flexible Coupling	510596
	1998.03-2000.09		Front	Saloon RWD M52B256S4	MT	Flexible Coupling	510597
	1998.03-2000.09		Front	Saloon RWD M52B256S4		Flexible Coupling Kit	510596S
	1998.03-2000.09		Front	Saloon RWD M52B256S4		Flexible Coupling Kit	510597S
2.5 (130 kw)	2005.03-2007.03		Centre	Saloon RWD N52B25A/N52B25BF		Center Bearing Support	530151
	2005.03-2007.03		Front	Saloon RWD N52B25A/N52B25BF		Flexible Coupling	510596
	2005.03-2007.03		Front	Saloon RWD N52B25A/N52B25BF		Flexible Coupling Kit	510596S
2.5 (140 kw)	2006.09-2011.12		Centre	Saloon RWD N52B25A/N52B25BF		Center Bearing Support	530151
	2006.09-2011.12		Front	Saloon RWD N52B25A/N52B25BF		Flexible Coupling	510596
	2006.09-2011.12		Front	Saloon RWD N52B25A/N52B25BF		Flexible Coupling	517956
	2006.09-2011.12		Front	Saloon RWD N52B25A/N52B25BF		Flexible Coupling Kit	510596S

	 YEAR	TRANSM.	FITTING POSITION	BODY STYLE & DRIVE TYPE & ENGINE	REMARKS	 PRODUCT	GSP Ref.
BMW							
323i Cabrio							
2.5 (120 kw)	2000.04-2000.09	MT	Rear	Cabriolet RWD M52B256S4		Propshaft	PS900114
	2000.04-2000.09		Front	Cabriolet RWD M52B256S4		Flexible Coupling	510596
2.5 (125 kw)	1995.05-1999.11		Centre	Cabriolet RWD M52B256S3		Center Bearing Support	510659
	1995.05-1999.11		Front	Cabriolet RWD M52B256S3		Flexible Coupling	510596
	1995.05-1999.11		Front	Cabriolet RWD M52B256S3		Flexible Coupling	510597
	1995.05-1999.11		Front	Cabriolet RWD M52B256S3		Flexible Coupling Kit	510596S
	1998.01-2000.09	MT	Rear	Cabriolet RWD M52B256S4		Propshaft	PS900114
	1998.01-2000.09		Centre	Cabriolet RWD M52B256S4		Center Bearing Support	512301
	1998.01-2000.09		Front	Cabriolet RWD M52B256S4		Flexible Coupling	510596
	1998.01-2000.09		Front	Cabriolet RWD M52B256S4	MT	Flexible Coupling	510597
	1998.01-2000.09		Front	Cabriolet RWD M52B256S4		Flexible Coupling Kit	510596S
2.5 (130 kw)	2006.08-2008.08		Front	Cabriolet RWD N52B25A		Flexible Coupling Kit	510596S
2.5 (140 kw)	2010.03-2011.09		Front	Cabriolet RWD N52B25A		Flexible Coupling	510596
323i Compact							
2.5 (125 kw)	1997.09-2000.08		Centre	Hatchback RWD M52B256S3		Center Bearing Support	510659
	1997.09-2000.08		Front	Hatchback RWD M52B256S3		Flexible Coupling	510596
	1997.09-2000.08		Front	Hatchback RWD M52B256S3		Flexible Coupling	510597
	1997.09-2000.08		Front	Hatchback RWD M52B256S3		Flexible Coupling Kit	510596S
	1997.09-2000.08		Front	Hatchback RWD M52B256S3		Flexible Coupling Kit	510597S
323i Coupe							
2.5 (120 kw)	1999.04-2000.09	MT	Rear	Coupe RWD M52B256S4		Propshaft	PS900114
	1999.04-2000.09		Front	Coupe RWD M52B256S4		Flexible Coupling	510596
2.5 (125 kw)	1995.05-1999.05		Centre	Coupe RWD M52B256S3		Center Bearing Support	510659
	1995.05-1999.05		Front	Coupe RWD M52B256S3		Flexible Coupling	510596
	1995.05-1999.05		Front	Coupe RWD M52B256S3		Flexible Coupling	510597
	1995.05-1999.05		Front	Coupe RWD M52B256S3		Flexible Coupling Kit	510596S
	1999.06-2000.09	MT	Rear	Coupe RWD M52B256S4		Propshaft	PS900114
	1999.06-2000.09		Centre	Coupe RWD M52B256S4		Center Bearing Support	512301
	1999.06-2000.09		Front	Coupe RWD M52B256S4		Flexible Coupling	510596
	1999.06-2000.09		Front	Coupe RWD M52B256S4	MT	Flexible Coupling	510597
	1999.06-2000.09		Front	Coupe RWD M52B256S4		Flexible Coupling Kit	510596S
	1999.06-2000.09		Front	Coupe RWD M52B256S4		Flexible Coupling Kit	510597S
2.5 (127 kw)	1998.01-2000.12		Front	Coupe RWD M52		Flexible Coupling Kit	510597S
2.5 (130 kw)	2006.06-2008.08		Front	Coupe RWD N52B25A		Flexible Coupling Kit	510596S
2.5 (140 kw)	2008.03-2011.12		Front	Coupe RWD N52B25A		Flexible Coupling	510596
323i Touring							
2.5 (125 kw)	1995.12-1999.04		Centre	Estate RWD M52B256S3		Center Bearing Support	510659
	1995.12-1999.04		Front	Estate RWD M52B256S3		Flexible Coupling	510596
	1995.12-1999.04		Front	Estate RWD M52B256S3		Flexible Coupling Kit	510596S
2.5 (130 kw)	2006.04-2007.06		Centre	Estate RWD N52B25A		Center Bearing Support	530151
	2006.04-2007.06		Front	Estate RWD N52B25A		Flexible Coupling	510596
	2006.04-2007.06		Front	Estate RWD N52B25A		Flexible Coupling Kit	510596S
2.5 (140 kw)	2006.04-2008.07		Front	Estate RWD N52B25A		Flexible Coupling	510596
324d Touring							
2.4 (85 kw)	1988.06-1993.02		Centre	Estate RWD M21D246TB		Center Bearing Support	510599
	1988.06-1993.02		Front	Estate RWD M21D246TB		Flexible Coupling	510596
	1988.06-1993.02		Front	Estate RWD M21D246TB		Flexible Coupling	510641
	1988.06-1993.02		Front	Estate RWD M21D246TB		Flexible Coupling Kit	510596S
325d							
2.0 (155 kw)	2013.03-2016.02		Front;Rear	Saloon RWD N47D20D		Flexible Coupling	517955
	2013.03-2016.02		Front	Saloon RWD N47D20D		Flexible Coupling Kit	517955S
2.0 (160 kw)	2013.03-2016.02		Front;Rear	Saloon RWD N47D20D		Flexible Coupling	517955
	2013.03-2016.02		Front	Saloon RWD N47D20D		Flexible Coupling Kit	517955S
2.0 (165 kw)	2016.03-2018.02		Front;Rear	Saloon RWD B47D20B		Flexible Coupling	517955
	2016.03-2018.02		Front	Saloon RWD B47D20B		Flexible Coupling Kit	517955S
2.5 (85 kw)	1991.09-1998.02		Centre	Saloon RWD M51D256T1		Center Bearing Support	510659
	1991.09-1998.02		Front	Saloon RWD M51D256T1		Flexible Coupling	510596
	1991.09-1998.02		Front	Saloon RWD M51D256T1		Flexible Coupling	510597
	1991.09-1998.02		Front	Saloon RWD M51D256T1		Flexible Coupling Kit	510596S
	1991.09-1998.02		Front	Saloon RWD M51D256T1		Flexible Coupling Kit	510597S
2.5 (105 kw)	1993.03-1998.01		Centre	Saloon RWD M51D256T1		Center Bearing Support	510659
	1993.03-1998.01		Front	Saloon RWD M51D256T1		Flexible Coupling	510596
	1993.03-1998.01		Front	Saloon RWD M51D256T1		Flexible Coupling Kit	510596S



	 YEAR	TRANSM.	FITTING POSITION	BODY STYLE & DRIVE TYPE & ENGINE	REMARKS	 PRODUCT	GSP Ref.
BMW 325d							
3.0 (145 kw)	2006.09-2010.02		Centre	Saloon RWD M57D306D3		Center Bearing Support	530151
	2006.09-2010.02		Centre	Saloon RWD M57D306D3		Center Bearing Support	530152
	2006.09-2010.02		Front	Saloon RWD M57D306D3		Flexible Coupling	530758
	2006.09-2010.02		Front	Saloon RWD M57D306D3		Flexible Coupling	537669
	2006.09-2010.02		Front;Rear	Saloon RWD M57D306D3		Flexible Coupling	517955
	2006.09-2010.02		Front	Saloon RWD M57D306D3		Flexible Coupling Kit	517955S
	2006.09-2010.02		Front	Saloon RWD M57D306D3		Flexible Coupling Kit	537669S
3.0 (150 kw)	2010.03-2011.10		Centre	Saloon RWD N57D30A		Center Bearing Support	530152
	2010.03-2011.10		Front	Saloon RWD N57D30A		Flexible Coupling	530758
	2010.03-2011.10		Front	Saloon RWD N57D30A		Flexible Coupling	537669
	2010.03-2011.10		Front;Rear	Saloon RWD N57D30A		Flexible Coupling	517955
	2010.03-2011.10		Front	Saloon RWD N57D30A		Flexible Coupling Kit	517955S
	2010.03-2011.10		Front	Saloon RWD N57D30A		Flexible Coupling Kit	537669S
325d Cabrio							
3.0 (145 kw)	2007.07-2010.02		Centre	Cabriolet RWD M57D306D3		Center Bearing Support	530152
	2007.07-2010.02		Front	Cabriolet RWD M57D306D3		Flexible Coupling	530758
	2007.07-2010.02		Front	Cabriolet RWD M57D306D3		Flexible Coupling	537669
	2007.07-2010.02		Front;Rear	Cabriolet RWD M57D306D3		Flexible Coupling	517955
	2007.07-2010.02		Front	Cabriolet RWD M57D306D3		Flexible Coupling Kit	517955S
	2007.07-2010.02		Front	Cabriolet RWD M57D306D3		Flexible Coupling Kit	537669S
3.0 (150 kw)	2010.03-		Centre	Cabriolet RWD N57D30A		Center Bearing Support	530152
	2010.03-		Front	Cabriolet RWD N57D30A		Flexible Coupling	530758
	2010.03-		Front	Cabriolet RWD N57D30A		Flexible Coupling	537669
	2010.03-		Front;Rear	Cabriolet RWD N57D30A		Flexible Coupling	517955
	2010.03-		Front	Cabriolet RWD N57D30A		Flexible Coupling Kit	517955S
	2010.03-		Front	Cabriolet RWD N57D30A		Flexible Coupling Kit	537669S
3.0 (155 kw)	2007.01-2009.12		Front;Rear	Cabriolet RWD M57D306D3		Flexible Coupling	517955
	2007.01-2009.12		Front	Cabriolet RWD M57D306D3		Flexible Coupling Kit	517955S
325d Coupe							
3.0 (145 kw)	2006.09-2010.03		Centre	Coupe RWD M57D306D3		Center Bearing Support	530152
	2006.09-2010.03		Front	Coupe RWD M57D306D3		Flexible Coupling	530758
	2006.09-2010.03		Front	Coupe RWD M57D306D3		Flexible Coupling	537669
	2006.09-2010.03		Front;Rear	Coupe RWD M57D306D3		Flexible Coupling	517955
	2006.09-2010.03		Front	Coupe RWD M57D306D3		Flexible Coupling Kit	517955S
	2006.09-2010.03		Front	Coupe RWD M57D306D3		Flexible Coupling Kit	537669S
3.0 (150 kw)	2010.04-		Centre	Coupe RWD N57D30A		Center Bearing Support	530152
	2010.04-		Front	Coupe RWD N57D30A		Flexible Coupling	530758
	2010.04-		Front	Coupe RWD N57D30A		Flexible Coupling	537669
	2010.04-		Front;Rear	Coupe RWD N57D30A		Flexible Coupling	517955
	2010.04-		Front	Coupe RWD N57D30A		Flexible Coupling Kit	517955S
	2010.04-		Front	Coupe RWD N57D30A		Flexible Coupling Kit	537669S
325d Gran Turismo							
2.0 (155 kw)	2013.07-2016.06		Front;Rear	Hatchback RWD N47D20D		Flexible Coupling	517955
	2013.07-2016.06		Front	Hatchback RWD N47D20D		Flexible Coupling Kit	517955S
2.0 (160 kw)	2013.07-2016.06		Front;Rear	Hatchback RWD N47D20D		Flexible Coupling	517955
	2013.07-2016.06		Front	Hatchback RWD N47D20D		Flexible Coupling Kit	517955S
2.0 (165 kw)	2016.07-2018.02		Front;Rear	Hatchback RWD B47D20B		Flexible Coupling	517955
	2016.07-2018.02		Front	Hatchback RWD B47D20B		Flexible Coupling Kit	517955S
325d Touring							
2.0 (155 kw)	2013.03-2016.02		Front;Rear	Estate RWD N47D20D		Flexible Coupling	517955
	2013.03-2016.02		Front	Estate RWD N47D20D		Flexible Coupling Kit	517955S
2.0 (160 kw)	2013.03-2016.02		Front;Rear	Estate RWD N47D20D		Flexible Coupling	517955
	2013.03-2016.02		Front	Estate RWD N47D20D		Flexible Coupling Kit	517955S
2.0 (165 kw)	2016.03-2018.02		Front;Rear	Estate RWD B47D20B		Flexible Coupling	517955
	2016.03-2018.02		Front	Estate RWD B47D20B		Flexible Coupling Kit	517955S
2.5 (105 kw)	1995.03-1999.04		Centre	Estate RWD M51D256T1		Center Bearing Support	510659
	1995.03-1999.04		Front	Estate RWD M51D256T1		Flexible Coupling	510596
	1995.03-1999.04		Front	Estate RWD M51D256T1		Flexible Coupling Kit	510596S
3.0 (145 kw)	2006.09-2012.06		Centre	Estate RWD M57D306D3		Center Bearing Support	530151
	2006.09-2012.06		Centre	Estate RWD M57D306D3		Center Bearing Support	530152
	2006.09-2012.06		Front	Estate RWD M57D306D3		Flexible Coupling	530758
	2006.09-2012.06		Front	Estate RWD M57D306D3		Flexible Coupling	537669
	2006.09-2012.06		Front;Rear	Estate RWD M57D306D3		Flexible Coupling	517955
	2006.09-2012.06		Front	Estate RWD M57D306D3		Flexible Coupling Kit	517955S

	 YEAR	TRANSM.	FITTING POSITION	BODY STYLE & DRIVE TYPE & ENGINE	REMARKS	 PRODUCT	GSP Ref.	
BMW								
325d Touring								
3.0 (145 kw)	2006.09-2012.06		Front	Estate RWD M57D306D3		Flexible Coupling Kit	537669S	
3.0 (150 kw)	2010.04-2012.10		Centre	Estate RWD N57D30A		Center Bearing Support	530151	
	2010.04-2012.10		Centre	Estate RWD N57D30A		Center Bearing Support	530152	
	2010.04-2012.10		Front	Estate RWD N57D30A		Flexible Coupling	530758	
	2010.04-2012.10		Front	Estate RWD N57D30A		Flexible Coupling	537669	
	2010.04-2012.10		Front;Rear	Estate RWD N57D30A		Flexible Coupling	517955	
	2010.04-2012.10		Front	Estate RWD N57D30A		Flexible Coupling Kit	517955S	
	2010.04-2012.10		Front	Estate RWD N57D30A		Flexible Coupling Kit	537669S	
325i								
2.5 (141 kw)	1990.09-1995.07		Centre	Saloon RWD M50B256S1/M50B256S2		Center Bearing Support	510659	
	1990.09-1995.07		Front	Saloon RWD M50B256S1/M50B256S2		Flexible Coupling	510596	
	1990.09-1995.07		Front	Saloon RWD M50B256S1/M50B256S2		Flexible Coupling	510597	
	1990.09-1995.07		Front	Saloon RWD M50B256S1/M50B256S2		Flexible Coupling Kit	510596S	
	1990.09-1995.07		Front	Saloon RWD M50B256S1/M50B256S2		Flexible Coupling Kit	510597S	
	2000.09-2005.02	AT	Rear	Saloon RWD M54B256S5	Total Length:1353mm	Propshaft	PS900113	
	2000.09-2005.02	MT	Rear	Saloon RWD M54B256S5	Total Length:1554mm	Propshaft	PS900114	
	2000.09-2005.02		Centre	Saloon RWD M54B256S5		Center Bearing Support	512301	
	2000.09-2005.02		Centre	Saloon 4WD M54B256S5		Center Bearing Support	530154	
	2000.09-2005.02		Front	Saloon RWD M54B256S5		Flexible Coupling	510596	
	2000.09-2005.02		Front	Saloon RWD M54B256S5	MT	Flexible Coupling	510597	
	2000.09-2005.02		Front	Saloon 4WD M54B256S5		Flexible Coupling	537631	
	2000.09-2005.02		Front	Saloon RWD M54B256S5		Flexible Coupling Kit	510596S	
	2000.09-2005.02		Front	Saloon RWD M54B256S5		Flexible Coupling Kit	510597S	
	2000.09-2005.02		Front	Saloon 4WD M54B256S5		Flexible Coupling Kit	537631S	
	2.5 (155 kw)	2006.01-2007.06	AT	Rear	Saloon RWD N52B25A		Propshaft	PS900117
		2006.01-2007.06		Front	Saloon RWD N52B25A		Flexible Coupling	510596
2.5 (160 kw)	2004.12-2011.12	AT	Rear	Saloon RWD N52B25A/N52B25B/N52B25BF	Date From:2005.01	Propshaft	PS900117	
	2004.12-2011.12		Centre	Saloon RWD N52B25A/N52B25B/N52B25BF		Center Bearing Support	530151	
	2004.12-2011.12		Front	Saloon RWD N52B25A/N52B25B/N52B25BF		Flexible Coupling	510596	
	2004.12-2011.12		Front	Saloon RWD N52B25A/N52B25B/N52B25BF		Flexible Coupling Kit	510596S	
	2005.09-2008.08	AT	Rear	Saloon 4WD N52B25A		Propshaft	PS900123	
	2005.09-2008.08		Centre	Saloon 4WD N52B25A		Center Bearing Support	530151	
	2005.09-2008.08		Front	Saloon 4WD N52B25A		Flexible Coupling	517956	
	2005.09-2008.08		Rear	Saloon 4WD N52B25A		Flexible Coupling	533878	
3.0 (155 kw)	2006.06-2011.12	AT	Rear	Saloon RWD N53B30A		Propshaft	PS900117	
	2006.06-2011.12		Front	Saloon RWD N53B30A		Flexible Coupling	510596	
3.0 (160 kw)	2005.09-2008.08	AT	Rear	Saloon 4WD N52B30A/N53B30A		Propshaft	PS900123	
	2005.09-2008.08		Centre	Saloon 4WD N52B30A/N53B30A		Center Bearing Support	530151	
	2005.09-2008.08		Front	Saloon 4WD N52B30A/N53B30A		Flexible Coupling	517956	
	2005.09-2008.08		Rear	Saloon 4WD N52B30A/N53B30A		Flexible Coupling	533878	
	2007.06-2011.12	AT	Rear	Saloon RWD N53B30A		Propshaft	PS900117	
	2007.06-2011.12		Centre	Saloon RWD N53B30A		Center Bearing Support	530151	
	2007.06-2011.12		Front	Saloon RWD N53B30A		Flexible Coupling	510596	
2007.06-2011.12		Front	Saloon RWD N53B30A		Flexible Coupling Kit	510596S		
325i Cabrio								
2.5 (125 kw)	1986.01-1993.10		Centre	Cabriolet RWD M20B256E1/M20B256E2/M20B256E5X/M20B256K1		Center Bearing Support	510599	
	1986.01-1993.10		Centre	Cabriolet RWD M20B256E1/M20B256E2/M20B256E5X/M20B256K1		Center Bearing Support	510627	
	1986.01-1993.10		Front	Cabriolet RWD M20B256E1/M20B256E2/M20B256E5X/M20B256K1		Flexible Coupling	510641	
2.5 (141 kw)	1993.03-1995.02		Centre	Cabriolet RWD M50B256S2		Center Bearing Support	510659	
	1993.03-1995.02		Front	Cabriolet RWD M50B256S2		Flexible Coupling	510596	
	1993.03-1995.02		Front	Cabriolet RWD M50B256S2		Flexible Coupling	510597	
	1993.03-1995.02		Front	Cabriolet RWD M50B256S2		Flexible Coupling Kit	510596S	
	1993.03-1995.02		Front	Cabriolet RWD M50B256S2		Flexible Coupling Kit	510597S	
	2000.09-2006.08	AT	Rear	Cabriolet RWD M54B256S5	Total Length:1353mm	Propshaft	PS900113	
	2000.09-2006.08	MT	Rear	Cabriolet RWD M54B256S5	Total Length:1554mm	Propshaft	PS900114	
	2000.09-2006.08		Centre	Cabriolet RWD M54B256S5		Center Bearing Support	512301	
	2000.09-2006.08		Front	Cabriolet RWD M54B256S5		Flexible Coupling	510596	
	2000.09-2006.08		Front	Cabriolet RWD M54B256S5	MT	Flexible Coupling	510597	
	2000.09-2006.08		Front	Cabriolet RWD M54B256S5		Flexible Coupling Kit	510596S	
	2000.09-2006.08		Front	Cabriolet RWD M54B256S5		Flexible Coupling Kit	510597S	
2.5 (160 kw)	2006.12-2010.02		Centre	Cabriolet RWD N52B25A		Center Bearing Support	530151	
	2006.12-2010.02		Front	Cabriolet RWD N52B25A		Flexible Coupling	510596	
	2006.12-2010.02		Front	Cabriolet RWD N52B25A		Flexible Coupling Kit	510596S	



	 YEAR	TRANSM.	FITTING POSITION	BODY STYLE & DRIVE TYPE & ENGINE	REMARKS	 PRODUCT	GSP Ref.	
BMW								
325i Cabrio								
3.0 (155 kw)	2006.10-2013.12		Front	Cabriolet RWD N53B30A		Flexible Coupling	510596	
3.0 (160 kw)	2007.03-2013.12		Centre	Cabriolet RWD N53B30A		Center Bearing Support	530151	
	2007.03-2013.12		Front	Cabriolet RWD N53B30A		Flexible Coupling	510596	
	2007.03-2013.12		Front	Cabriolet RWD N53B30A		Flexible Coupling Kit	510596S	
325i Compact								
2.5 (141 kw)	2001.04-2004.12		Centre	Hatchback RWD M54B256S5		Center Bearing Support	512301	
	2001.04-2004.12		Front	Hatchback RWD M54B256S5		Flexible Coupling	510596	
	2001.04-2004.12		Front	Hatchback RWD M54B256S5		Flexible Coupling	510597	
	2001.04-2004.12		Front	Hatchback RWD M54B256S5		Flexible Coupling Kit	510596S	
	2001.04-2004.12		Front	Hatchback RWD M54B256S5		Flexible Coupling Kit	510597S	
325i Coupe								
2.5 (141 kw)	1991.10-1995.02		Centre	Coupe RWD M50B256S1/M50B256S2		Center Bearing Support	510659	
	1991.10-1995.02		Front	Coupe RWD M50B256S1/M50B256S2		Flexible Coupling	510596	
	1991.10-1995.02		Front	Coupe RWD M50B256S1/M50B256S2		Flexible Coupling	510597	
	1991.10-1995.02		Front	Coupe RWD M50B256S1/M50B256S2		Flexible Coupling Kit	510596S	
	1991.10-1995.02		Front	Coupe RWD M50B256S1/M50B256S2		Flexible Coupling Kit	510597S	
	2000.09-2006.05	AT	Rear	Coupe RWD M54B256S5	Total Length:1353mm	Propshaft	PS900113	
	2000.09-2006.05	MT	Rear	Coupe RWD M54B256S5	Total Length:1554mm	Propshaft	PS900114	
	2000.09-2006.05		Centre	Coupe RWD M54B256S5		Center Bearing Support	512301	
	2000.09-2006.05		Front	Coupe RWD M54B256S5		Flexible Coupling	510596	
	2000.09-2006.05		Front	Coupe RWD M54B256S5	MT	Flexible Coupling	510597	
	2000.09-2006.05		Front	Coupe RWD M54B256S5		Flexible Coupling Kit	510596S	
	2000.09-2006.05		Front	Coupe RWD M54B256S5		Flexible Coupling Kit	510597S	
	2.5 (150 kw)	2010.03-2013.10		Front	Coupe RWD N52B25A/N52B25AF/N52B25BF		Flexible Coupling	510596
	2.5 (155 kw)	2010.03-2013.06	AT	Rear	Coupe RWD N52B25A/N52B25AF/N52B25BF		Propshaft	PS900117
2010.03-2013.06			Front	Coupe RWD N52B25A/N52B25AF/N52B25BF		Flexible Coupling	510596	
2.5 (160 kw)	2006.06-2010.02	AT	Rear	Coupe RWD N52B25A/N52B25AF/N52B25BF		Propshaft	PS900117	
	2006.06-2010.02		Centre	Coupe RWD N52B25A/N52B25AF/N52B25BF		Center Bearing Support	530151	
	2006.06-2010.02		Front	Coupe RWD N52B25A/N52B25AF/N52B25BF		Flexible Coupling	510596	
	2006.06-2010.02		Front	Coupe RWD N52B25A/N52B25AF/N52B25BF		Flexible Coupling Kit	510596S	
	2006.09-2010.02	AT/MT	Front	Coupe 4WD N52B25A		Propshaft	PS900124	
	2006.09-2010.02	AT	Rear	Coupe 4WD N52B25A		Propshaft	PS900123	
	2006.09-2010.02		Centre	Coupe 4WD N52B25A		Center Bearing Support	530151	
	2006.09-2010.02		Front	Coupe 4WD N52B25A		Flexible Coupling	517956	
	2006.09-2010.02		Rear	Coupe 4WD N52B25A		Flexible Coupling	533878	
	2006.09-2010.02		Rear	Coupe 4WD N52B25A		Flexible Coupling	533878	
3.0 (155 kw)	2007.09-2008.08	AT	Rear	Coupe 4WD N53B30A		Propshaft	PS900123	
	2010.03-2013.06	AT	Rear	Coupe RWD N53B30A		Propshaft	PS900117	
	2010.03-2013.06		Front	Coupe RWD N53B30A		Flexible Coupling	510596	
3.0 (160 kw)	2007.09-2010.02	AT/MT	Front	Coupe 4WD N53B30A		Propshaft	PS900124	
	2007.09-2010.02	AT	Rear	Coupe 4WD N53B30A		Propshaft	PS900123	
	2007.09-2010.02		Centre	Coupe 4WD N53B30A		Center Bearing Support	530151	
	2007.09-2010.02		Front	Coupe 4WD N53B30A		Flexible Coupling	517956	
	2007.09-2010.02		Rear	Coupe 4WD N53B30A		Flexible Coupling	533878	
	2007.09-2013.06	AT	Rear	Coupe RWD N53B30A		Propshaft	PS900117	
	2007.09-2013.06		Centre	Coupe RWD N53B30A		Center Bearing Support	530151	
	2007.09-2013.06		Front	Coupe RWD N53B30A		Flexible Coupling	510596	
	2007.09-2013.06		Front	Coupe RWD N53B30A		Flexible Coupling Kit	510596S	
325i Touring								
2.5 (125 kw)	1986.09-1994.10		Centre	Estate RWD M20B256EX/M20B256K1		Center Bearing Support	510599	
	1986.09-1994.10		Centre	Estate RWD M20B256EX/M20B256K1		Center Bearing Support	510627	
	1986.09-1994.10		Front	Estate RWD M20B256EX/M20B256K1		Flexible Coupling	510641	
	1988.09-1994.10		Centre	Estate 4WD M20B256K1		Center Bearing Support	510599	
	1988.09-1994.10		Front	Estate 4WD M20B256K1		Flexible Coupling	510596	
	1988.09-1994.10		Front	Estate 4WD M20B256K1		Flexible Coupling	510641	
	1988.09-1994.10		Front	Estate 4WD M20B256K1		Flexible Coupling Kit	510596S	
2.5 (141 kw)	2000.08-2005.02	AT	Rear	Estate RWD M54B256S5	Total Length:1353mm	Propshaft	PS900113	
	2000.08-2005.02	MT	Rear	Estate RWD M54B256S5	Total Length:1554mm	Propshaft	PS900114	
	2000.08-2005.02		Centre	Estate RWD M54B256S5		Center Bearing Support	512301	
	2000.08-2005.02		Centre	Estate 4WD M54B256S5		Center Bearing Support	530154	
	2000.08-2005.02		Front	Estate RWD M54B256S5		Flexible Coupling	510596	
	2000.08-2005.02		Front	Estate RWD M54B256S5	MT	Flexible Coupling	510597	
	2000.08-2005.02		Front	Estate 4WD M54B256S5		Flexible Coupling	537631	
	2000.08-2005.02		Front	Estate RWD M54B256S5		Flexible Coupling Kit	510596S	
	2000.08-2005.02		Front	Estate RWD M54B256S5		Flexible Coupling Kit	510597S	



	 YEAR	TRANSM.	FITTING POSITION	BODY STYLE & DRIVE TYPE & ENGINE	REMARKS	 PRODUCT	GSP Ref.
BMW							
325i Touring							
2.5 (141 kw)	2000.08-2005.02		Front	Estate 4WD M54B256S5		Flexible Coupling Kit	537631S
2.5 (155 kw)	2005.11-2010.12	AT	Rear	Estate RWD N52B25A/N52B25AF	Date From:2005.01	Propshaft	PS900117
	2005.11-2010.12		Front	Estate RWD N52B25A/N52B25AF		Flexible Coupling	510596
2.5 (160 kw)	2004.12-2008.08	AT	Rear	Estate RWD N52B25A		Propshaft	PS900117
	2004.12-2008.08		Centre	Estate RWD N52B25A		Center Bearing Support	530151
	2004.12-2008.08		Front	Estate RWD N52B25A		Flexible Coupling	510596
	2004.12-2008.08		Front	Estate RWD N52B25A		Flexible Coupling Kit	510596S
	2005.08-2008.08	AT/MT	Front	Estate 4WD N52B25A		Propshaft	PS900124
	2005.08-2008.08		Centre	Estate 4WD N52B25A		Center Bearing Support	530151
	2005.08-2008.08		Front	Estate 4WD N52B25A		Flexible Coupling	510597
	2005.08-2008.08		Front	Estate 4WD N52B25A		Flexible Coupling	517956
	2005.08-2008.08		Rear	Estate 4WD N52B25A		Flexible Coupling	533878
3.0 (155 kw)	2007.06-2012.10		Front	Estate RWD N53B30A		Flexible Coupling	510596
	2007.09-2008.08	AT/MT	Front	Estate 4WD N53B30A		Propshaft	PS900124
	2007.09-2008.08		Rear	Estate 4WD N53B30A		Flexible Coupling	533878
3.0 (160 kw)	2006.01-2008.08	AT/MT	Front	Estate 4WD N53B30A		Propshaft	PS900124
	2006.01-2008.08		Centre	Estate 4WD N53B30A		Center Bearing Support	530151
	2006.01-2008.08		Front	Estate 4WD N53B30A		Flexible Coupling	510597
	2006.01-2008.08		Front	Estate 4WD N53B30A		Flexible Coupling	517956
	2006.01-2008.08		Rear	Estate 4WD N53B30A		Flexible Coupling	533878
	2007.06-2012.10		Centre	Estate RWD N53B30A		Center Bearing Support	530151
	2007.06-2012.10		Front	Estate RWD N53B30A		Flexible Coupling	510596
	2007.06-2012.10		Front	Estate RWD N53B30A		Flexible Coupling Kit	510596S
325i xDrive							
3.0 (160 kw)	2008.09-2011.10		Centre	Saloon 4WD N53B30A		Center Bearing Support	530151
	2008.09-2011.10		Rear	Saloon 4WD N53B30A		Flexible Coupling	533878
325i xDrive Coupe							
2.5 (150 kw)	2010.03-2013.06		Rear	Coupe 4WD N52B25A		Flexible Coupling	533878
2.5 (155 kw)	2010.03-2013.04	AT/MT	Front	Coupe 4WD N52B25AF		Propshaft	PS900124
	2010.03-2013.04		Rear	Coupe 4WD N52B25AF		Flexible Coupling	533878
2.5 (160 kw)	2006.09-2012.03	AT/MT	Front	Coupe 4WD N52B25A		Propshaft	PS900124
	2006.09-2012.03	AT	Rear	Coupe 4WD N52B25A		Propshaft	PS900123
	2006.09-2012.03		Centre	Coupe 4WD N52B25A		Center Bearing Support	530151
	2006.09-2012.03		Front	Coupe 4WD N52B25A		Flexible Coupling	517956
	2006.09-2012.03		Rear	Coupe 4WD N52B25A		Flexible Coupling	533878
3.0 (155 kw)	2008.09-2013.06	AT/MT	Front	Coupe 4WD N53B30A		Propshaft	PS900124
	2008.09-2013.06		Rear	Coupe 4WD N53B30A		Flexible Coupling	533878
3.0 (160 kw)	2008.09-2013.12	AT/MT	Front	Coupe 4WD N53B30A	Date From:2009.01	Propshaft	PS900124
	2008.09-2013.12		Front	Coupe 4WD N53B30A		Flexible Coupling	517956
	2008.09-2013.12		Rear	Coupe 4WD N53B30A		Flexible Coupling	533878
325i xDrive Touring							
2.5 (160 kw)	2004.06-2008.08	AT/MT	Front	Estate 4WD N52B25A		Propshaft	PS900124
	2004.06-2008.08		Centre	Estate 4WD N52B25A		Center Bearing Support	530151
	2004.06-2008.08		Front	Estate 4WD N52B25A		Flexible Coupling	510597
	2004.06-2008.08		Front	Estate 4WD N52B25A		Flexible Coupling	517956
	2004.06-2008.08		Rear	Estate 4WD N52B25A		Flexible Coupling	533878
3.0 (155 kw)	2008.09-2012.06	AT/MT	Front	Estate 4WD N53B30A		Propshaft	PS900124
	2008.09-2012.06		Rear	Estate 4WD N53B30A		Flexible Coupling	533878
3.0 (160 kw)	2008.09-2012.10	AT/MT	Front	Estate 4WD N53B30A		Propshaft	PS900124
	2008.09-2012.10		Front	Estate 4WD N53B30A		Flexible Coupling	517956
	2008.09-2012.10		Rear	Estate 4WD N53B30A		Flexible Coupling	533878
328i							
2.0 (180 kw)	2011.11-2018.10		Centre	Saloon RWD N20B20A/N26B20A		Center Bearing Support	530151
	2011.11-2018.10		Front	Saloon RWD N20B20A/N26B20A		Flexible Coupling	510596
	2011.11-2018.10		Rear	Saloon RWD N20B20A/N26B20A		Flexible Coupling	537625
	2011.11-2018.10		Front	Saloon RWD N20B20A/N26B20A		Flexible Coupling Kit	510596S
	2011.11-2018.10		Rear	Saloon RWD N20B20A/N26B20A		Flexible Coupling Kit	537625S
2.8 (142 kw)	1995.01-1998.04		Centre	Saloon RWD M52B286S1		Center Bearing Support	510659
	1995.01-1998.04		Front	Saloon RWD M52B286S1		Flexible Coupling	510596
	1995.01-1998.04		Front	Saloon RWD M52B286S1		Flexible Coupling Kit	510596S
	1997.12-2000.05	AT	Rear	Saloon RWD M52B286S2		Propshaft	PS900113
	1997.12-2000.05		Centre	Saloon RWD M52B286S2		Center Bearing Support	512301
	1997.12-2000.05		Front	Saloon RWD M52B286S2		Flexible Coupling	510596
	1997.12-2000.05		Front	Saloon RWD M52B286S2		Flexible Coupling Kit	510596S



	 YEAR	TRANSM.	FITTING POSITION	BODY STYLE & DRIVE TYPE & ENGINE	REMARKS	 PRODUCT	GSP Ref.
BMW							
328i							
3.0 (172 kw)	2006.09-2011.12		Centre	Saloon RWD N51B30A		Center Bearing Support	530151
	2006.09-2011.12		Front	Saloon RWD N51B30A		Flexible Coupling	510596
	2006.09-2011.12		Front	Saloon RWD N51B30A		Flexible Coupling Kit	510596S
328i Cabrio							
2.8 (142 kw)	1995.01-1999.11		Centre	Cabriolet RWD M52B286S1		Center Bearing Support	510659
	1995.01-1999.11		Front	Cabriolet RWD M52B286S1		Flexible Coupling	510596
	1995.01-1999.11		Front	Cabriolet RWD M52B286S1		Flexible Coupling Kit	510596S
3.0 (172 kw)	2007.03-		Front	Cabriolet RWD N51B30A		Flexible Coupling Kit	510596S
328i Coupe							
2.8 (142 kw)	1995.01-1999.04		Centre	Coupe RWD M52B286S1		Center Bearing Support	510659
	1995.01-1999.04		Front	Coupe RWD M52B286S1		Flexible Coupling	510596
	1995.01-1999.04		Front	Coupe RWD M52B286S1		Flexible Coupling Kit	510596S
	1998.12-2000.05	AT	Rear	Coupe RWD M52B286S2		Propshaft	PS900113
	1998.12-2000.05		Centre	Coupe RWD M52B286S2		Center Bearing Support	512301
	1998.12-2000.05		Front	Coupe RWD M52B286S2		Flexible Coupling	510596
	1998.12-2000.05		Front	Coupe RWD M52B286S2		Flexible Coupling Kit	510596S
3.0 (172 kw)	2006.06-2013.06		Front	Coupe RWD N52B30A		Flexible Coupling	510596
	2006.09-2008.08	AT	Rear	Coupe 4WD N51B30A/N52B30A		Propshaft	PS900123
328i Gran Turismo							
2.0 (180 kw)	2013.03-2016.06		Front	Hatchback RWD N20B20A		Flexible Coupling	510596
	2013.03-2016.06		Rear	Hatchback RWD N20B20A		Flexible Coupling	537625
	2013.03-2016.06		Front	Hatchback RWD N20B20A		Flexible Coupling Kit	510596S
	2013.03-2016.06		Rear	Hatchback RWD N20B20A		Flexible Coupling Kit	537625S
328i Touring							
2.0 (180 kw)	2012.07-2015.06		Front	Estate RWD N20B20A		Flexible Coupling	510596
	2012.07-2015.06		Rear	Estate RWD N20B20A		Flexible Coupling	537625
	2012.07-2015.06		Front	Estate RWD N20B20A		Flexible Coupling Kit	510596S
	2012.07-2015.06		Rear	Estate RWD N20B20A		Flexible Coupling Kit	537625S
2.8 (142 kw)	1995.02-1999.04		Centre	Estate RWD M52B286S1		Center Bearing Support	510659
	1995.02-1999.04		Front	Estate RWD M52B286S1		Flexible Coupling	510596
	1995.02-1999.04		Front	Estate RWD M52B286S1		Flexible Coupling Kit	510596S
	1999.06-2000.05	AT	Rear	Estate RWD M52B286S2		Propshaft	PS900113
	1999.06-2000.05		Centre	Estate RWD M52B286S2		Center Bearing Support	512301
	1999.06-2000.05		Front	Estate RWD M52B286S2		Flexible Coupling	510596
	1999.06-2000.05		Front	Estate RWD M52B286S2		Flexible Coupling Kit	510596S
328i xDrive							
2.0 (179 kw)	2012.07-2015.07		Front	Saloon 4WD N20B20A		Flexible Coupling Kit	517955S
	2012.07-2015.07		Rear	Saloon 4WD N20B20A		Flexible Coupling Kit	537625S
2.0 (180 kw)	2012.07-2016.08	AT/MT	Front	Saloon 4WD N20B20A	Date From:2013.01	Propshaft	PS900112
	2012.07-2016.08		Centre	Saloon 4WD N20B20A		Center Bearing Support	530151
	2012.07-2016.08		Rear	Saloon 4WD N20B20A		Flexible Coupling	537625
	2012.07-2016.08		Front;Rear	Saloon 4WD N20B20A		Flexible Coupling	517955
	2012.07-2016.08		Front	Saloon 4WD N20B20A		Flexible Coupling Kit	517955S
	2012.07-2016.08		Rear	Saloon 4WD N20B20A		Flexible Coupling Kit	537625S
3.0 (172 kw)	2007.01-2013.06	AT	Rear	Saloon 4WD N51B30A/N52		Propshaft	PS900123
328i xDrive Coupe							
3.0 (172 kw)	2008.09-2013.06	AT/MT	Front	Coupe 4WD N51B30A/N52B30A		Propshaft	PS900124
328i xDrive Gran Turismo							
2.0 (180 kw)	2013.07-2016.06		Front	Hatchback 4WD N20B20A		Flexible Coupling	510596
	2013.07-2016.06		Rear	Hatchback 4WD N20B20A		Flexible Coupling	537625
	2013.07-2016.06		Front;Rear	Hatchback 4WD N20B20A		Flexible Coupling	517955
	2013.07-2016.06		Front	Hatchback 4WD N20B20A		Flexible Coupling Kit	517955S
	2013.07-2016.06		Rear	Hatchback 4WD N20B20A		Flexible Coupling Kit	537625S
328i xDrive Touring							
2.0 (180 kw)	2013.03-2015.06		Rear	Estate 4WD N20B20A		Flexible Coupling	537625
	2013.03-2015.06		Front;Rear	Estate 4WD N20B20A		Flexible Coupling	517955
	2013.03-2015.06		Front	Estate 4WD N20B20A		Flexible Coupling Kit	517955S
	2013.03-2015.06		Rear	Estate 4WD N20B20A		Flexible Coupling Kit	537625S
330d							
3.0 (135 kw)	1999.08-2003.02		Centre	Saloon 4WD M57D306D1		Center Bearing Support	530154
	1999.08-2003.02		Centre	Saloon RWD M57D306D1		Center Bearing Support	531031
	1999.08-2003.02		Front	Saloon RWD M57D306D1		Flexible Coupling	510663
	1999.08-2003.02		Front	Saloon RWD M57D306D1		Flexible Coupling	530160
	1999.08-2003.02		Front	Saloon 4WD M57D306D1		Flexible Coupling	537631



	 YEAR	TRANSM.	FITTING POSITION	BODY STYLE & DRIVE TYPE & ENGINE	REMARKS	 PRODUCT	GSP Ref.	
BMW 330d								
3.0 (135 kw)	1999.08-2003.02		Front	Saloon RWD M57D306D1		Flexible Coupling Kit	530160S	
	1999.08-2003.02		Front	Saloon 4WD M57D306D1		Flexible Coupling Kit	537631S	
3.0 (150 kw)	2002.09-2004.12		Centre	Saloon 4WD M57D306D2		Center Bearing Support	530154	
	2002.09-2004.12		Front	Saloon 4WD M57D306D2		Flexible Coupling	537631	
	2002.09-2004.12		Front	Saloon 4WD M57D306D2		Flexible Coupling Kit	537631S	
	2003.03-2005.02		Centre	Saloon RWD M57D306D2		Center Bearing Support	531031	
	2003.03-2005.02		Front	Saloon RWD M57D306D2		Flexible Coupling	510663	
	2003.03-2005.02		Front	Saloon RWD M57D306D2		Flexible Coupling	530160	
3.0 (155 kw)	2004.09-2011.12		Front;Rear	Saloon RWD M57D306D3/N57D30A		Flexible Coupling	517955	
	2004.09-2011.12		Front	Saloon RWD M57D306D3/N57D30A		Flexible Coupling Kit	517955S	
3.0 (170 kw)	2005.03-2008.08		Centre	Saloon 4WD M57D306D3		Center Bearing Support	530151	
	2005.03-2008.08		Centre	Saloon 4WD M57D306D3		Center Bearing Support	530152	
	2005.03-2008.08		Centre	Saloon RWD M57D306D3		Center Bearing Support	530152	
	2005.03-2008.08		Front	Saloon 4WD M57D306D3		Flexible Coupling	517956	
	2005.03-2008.08		Front	Saloon RWD M57D306D3		Flexible Coupling	517956	
	2005.03-2008.08		Front	Saloon RWD M57D306D3		Flexible Coupling	530758	
	2005.03-2008.08		Front	Saloon RWD M57D306D3		Flexible Coupling	537669	
	2005.03-2008.08		Front;Rear	Saloon 4WD M57D306D3		Flexible Coupling	517955	
3.0 (180 kw)	2005.03-2008.08		Front	Saloon RWD M57D306D3		Flexible Coupling Kit	537669S	
	2008.09-2011.10		Centre	Saloon RWD N57D30A		Center Bearing Support	530152	
	2008.09-2011.10		Front	Saloon RWD N57D30A		Flexible Coupling	530758	
	2008.09-2011.10		Front	Saloon RWD N57D30A		Flexible Coupling	537669	
	2008.09-2011.10		Front;Rear	Saloon RWD N57D30A		Flexible Coupling	517955	
	2008.09-2011.10		Front	Saloon RWD N57D30A		Flexible Coupling Kit	517955S	
3.0 (190 kw)	2008.09-2011.10		Front	Saloon RWD N57D30A		Flexible Coupling Kit	537669S	
	2012.07-2018.10		Centre	Saloon RWD N57D30A		Center Bearing Support	530151	
	2012.07-2018.10		Front;Rear	Saloon RWD N57D30A		Flexible Coupling	517955	
	2012.07-2018.10		Front	Saloon RWD N57D30A		Flexible Coupling Kit	517955S	
	3.0 (195 kw)	2019.03-		Front;Rear	Saloon RWD B57D30A		Flexible Coupling	517955
		2019.03-		Front	Saloon RWD B57D30A		Flexible Coupling Kit	517955S
2012.07-2018.10			Front;Rear	Saloon RWD N57D30A		Flexible Coupling	517955	
3.0 (210 kw)	2012.07-2018.10		Front	Saloon RWD N57D30A		Flexible Coupling Kit	517955S	
	2012.07-2018.10		Front	Saloon RWD N57D30A		Flexible Coupling Kit	517955S	
330d Cabrio								
3.0 (150 kw)	2004.10-2007.02		Centre	Cabriolet RWD M57D306D2		Center Bearing Support	531031	
	2004.10-2007.02		Front	Cabriolet RWD M57D306D2		Flexible Coupling	530160	
3.0 (170 kw)	2007.03-2013.12		Centre	Cabriolet RWD M57D306D3		Center Bearing Support	530152	
	2007.03-2013.12		Front	Cabriolet RWD M57D306D3		Flexible Coupling	530758	
	2007.03-2013.12		Front	Cabriolet RWD M57D306D3		Flexible Coupling	537669	
	2007.03-2013.12		Front	Cabriolet RWD M57D306D3		Flexible Coupling Kit	537669S	
3.0 (180 kw)	2009.01-		Centre	Cabriolet RWD N57D30A		Center Bearing Support	530152	
	2009.01-		Front	Cabriolet RWD N57D30A		Flexible Coupling	530758	
	2009.01-		Front	Cabriolet RWD N57D30A		Flexible Coupling	537669	
	2009.01-		Front;Rear	Cabriolet RWD N57D30A		Flexible Coupling	517955	
	2009.01-		Front	Cabriolet RWD N57D30A		Flexible Coupling Kit	517955S	
2009.01-		Front	Cabriolet RWD N57D30A		Flexible Coupling Kit	537669S		
330d Coupe								
3.0 (150 kw)	2003.02-2006.07		Centre	Coupe RWD M57D306D2		Center Bearing Support	531031	
	2003.02-2006.07		Front	Coupe RWD M57D306D2		Flexible Coupling	510663	
	2003.02-2006.07		Front	Coupe RWD M57D306D2		Flexible Coupling	530160	
3.0 (170 kw)	2006.06-2008.08	AT/MT	Front	Coupe 4WD M57D306D3		Propshaft	PS900124	
	2006.06-2008.08		Centre	Coupe 4WD M57D306D3		Center Bearing Support	530151	
	2006.06-2008.08		Centre	Coupe 4WD M57D306D3		Center Bearing Support	530152	
	2006.06-2008.08		Front	Coupe 4WD M57D306D3		Flexible Coupling	537669	
	2006.06-2008.08		Front;Rear	Coupe 4WD M57D306D3		Flexible Coupling	517955	
	2006.09-2008.08		Centre	Coupe RWD M57D306D3		Center Bearing Support	530152	
	2006.09-2008.08		Front	Coupe RWD M57D306D3		Flexible Coupling	517956	
	2006.09-2008.08		Front	Coupe RWD M57D306D3		Flexible Coupling	530758	
	2006.09-2008.08		Front	Coupe RWD M57D306D3		Flexible Coupling	537669	
	2006.09-2008.08		Front	Coupe RWD M57D306D3		Flexible Coupling Kit	537669S	
3.0 (180 kw)	2008.09-		Centre	Coupe RWD N57D30A		Center Bearing Support	530152	
	2008.09-		Front	Coupe RWD N57D30A		Flexible Coupling	530758	
	2008.09-		Front	Coupe RWD N57D30A		Flexible Coupling	537669	
	2008.09-		Front;Rear	Coupe RWD N57D30A		Flexible Coupling	517955	
	2008.09-		Front	Coupe RWD N57D30A		Flexible Coupling Kit	517955S	

	 YEAR	TRANSM.	FITTING POSITION	BODY STYLE & DRIVE TYPE & ENGINE	REMARKS	 PRODUCT	GSP Ref.
BMW							
330d Coupe							
3.0 (180 kw)	2008.09-		Front	Coupe RWD N57D30A		Flexible Coupling Kit	537669S
330d Gran Turismo							
3.0 (190 kw)	2014.03-		Front;Rear	Hatchback RWD N57D30A		Flexible Coupling	517955
	2014.03-		Front	Hatchback RWD N57D30A		Flexible Coupling Kit	517955S
3.0 (210 kw)	2014.03-		Front;Rear	Hatchback RWD N57D30A		Flexible Coupling	517955
	2014.03-		Front	Hatchback RWD N57D30A		Flexible Coupling Kit	517955S
330d Touring							
3.0 (135 kw)	1999.08-2003.02		Centre	Estate RWD M57D306D1		Center Bearing Support	531031
	1999.08-2003.02		Front	Estate RWD M57D306D1		Flexible Coupling	510663
	1999.08-2003.02		Front	Estate RWD M57D306D1		Flexible Coupling	530160
	1999.08-2003.02		Front	Estate RWD M57D306D1		Flexible Coupling Kit	530160S
	2000.08-2003.02		Centre	Estate 4WD M57D306D1		Center Bearing Support	530154
	2000.08-2003.02		Front	Estate 4WD M57D306D1		Flexible Coupling	537631
	2000.08-2003.02		Front	Estate 4WD M57D306D1		Flexible Coupling Kit	537631S
3.0 (150 kw)	2002.08-2005.05		Centre	Estate 4WD M57D306D2		Center Bearing Support	530154
	2002.08-2005.05		Front	Estate 4WD M57D306D2		Flexible Coupling	537631
	2002.08-2005.05		Front	Estate 4WD M57D306D2		Flexible Coupling Kit	537631S
	2003.03-2005.02		Centre	Estate RWD M57D306D2		Center Bearing Support	531031
	2003.03-2005.02		Front	Estate RWD M57D306D2		Flexible Coupling	510663
	2003.03-2005.02		Front	Estate RWD M57D306D2		Flexible Coupling	530160
3.0 (155 kw)	2005.06-2012.05		Front;Rear	Estate RWD M57D306D3/N57D30A		Flexible Coupling	517955
	2005.06-2012.05		Front	Estate RWD M57D306D3/N57D30A		Flexible Coupling Kit	517955S
3.0 (170 kw)	2005.06-2008.08	AT/MT	Front	Estate 4WD M57D306D3		Propshaft	PS900124
	2005.06-2008.08		Centre	Estate 4WD M57D306D3		Center Bearing Support	530151
	2005.06-2008.08		Centre	Estate 4WD M57D306D3		Center Bearing Support	530152
	2005.06-2008.08		Centre	Estate RWD M57D306D3		Center Bearing Support	530152
	2005.06-2008.08		Front	Estate 4WD M57D306D3		Flexible Coupling	517956
	2005.06-2008.08		Front	Estate RWD M57D306D3		Flexible Coupling	517956
	2005.06-2008.08		Front	Estate RWD M57D306D3		Flexible Coupling	530758
	2005.06-2008.08		Front	Estate RWD M57D306D3		Flexible Coupling	537669
	2005.06-2008.08		Front;Rear	Estate 4WD M57D306D3		Flexible Coupling	517955
	2005.06-2008.08		Front	Estate RWD M57D306D3		Flexible Coupling Kit	537669S
3.0 (180 kw)	2008.09-2012.10		Centre	Estate RWD N57D30A		Center Bearing Support	530152
	2008.09-2012.10		Front	Estate RWD N57D30A		Flexible Coupling	530758
	2008.09-2012.10		Front	Estate RWD N57D30A		Flexible Coupling	537669
	2008.09-2012.10		Front;Rear	Estate RWD N57D30A		Flexible Coupling	517955
	2008.09-2012.10		Front	Estate RWD N57D30A		Flexible Coupling Kit	517955S
	2008.09-2012.10		Front	Estate RWD N57D30A		Flexible Coupling Kit	537669S
3.0 (190 kw)	2012.07-2019.06		Front;Rear	Estate RWD N57D30A		Flexible Coupling	517955
	2012.07-2019.06		Front	Estate RWD N57D30A		Flexible Coupling Kit	517955S
3.0 (210 kw)	2012.07-2019.06		Front;Rear	Estate RWD N57D30A		Flexible Coupling	517955
	2012.07-2019.06		Front	Estate RWD N57D30A		Flexible Coupling Kit	517955S
330d xDrive							
3.0 (180 kw)	2008.09-2011.12		Centre	Saloon 4WD N57D30A		Center Bearing Support	530151
	2008.09-2011.12		Centre	Saloon 4WD N57D30A		Center Bearing Support	530152
	2008.09-2011.12		Front	Saloon 4WD N57D30A		Flexible Coupling	517956
	2008.09-2011.12		Front	Saloon 4WD N57D30A		Flexible Coupling	537669
	2008.09-2011.12		Front;Rear	Saloon 4WD N57D30A		Flexible Coupling	517955
	2008.09-2011.12		Front	Saloon 4WD N57D30A		Flexible Coupling Kit	537669S
3.0 (190 kw)	2013.03-2018.10	AT/MT	Front	Saloon 4WD N57D30A		Propshaft	PS900112
	2013.03-2018.10		Front;Rear	Saloon 4WD N57D30A		Flexible Coupling	517955
	2013.03-2018.10		Front	Saloon 4WD N57D30A		Flexible Coupling Kit	517955S
3.0 (195 kw)	2019.07-	AT	Front	Saloon 4WD B57D30A		Propshaft	PS900139
	2019.07-		Front	Saloon 4WD B57D30A		Flexible Coupling	537631
	2019.07-		Rear	Saloon 4WD B57D30A		Flexible Coupling	537625
3.0 (210 kw)	2013.03-2018.10	AT/MT	Front	Saloon 4WD N57D30A		Propshaft	PS900112
	2020.11-	AT	Front	Saloon 4WD B57D30B		Propshaft	PS900139
330d xDrive Coupe							
3.0 (180 kw)	2008.09-		Centre	Coupe 4WD N57D30A		Center Bearing Support	530151
	2008.09-		Centre	Coupe 4WD N57D30A		Center Bearing Support	530152
	2008.09-		Front	Coupe 4WD N57D30A		Flexible Coupling	517956
	2008.09-		Front	Coupe 4WD N57D30A		Flexible Coupling	537669
	2008.09-		Front;Rear	Coupe 4WD N57D30A		Flexible Coupling	517955
	2008.09-		Front	Coupe 4WD N57D30A		Flexible Coupling Kit	537669S



	 YEAR	TRANSM.	FITTING POSITION	BODY STYLE & DRIVE TYPE & ENGINE	REMARKS	 PRODUCT	GSP Ref.
BMW							
330d xDrive Gran Turismo							
3.0 (190 kw)	2014.03-		Front;Rear	Hatchback 4WD N57D30A		Flexible Coupling	517955
	2014.03-		Front	Hatchback 4WD N57D30A		Flexible Coupling Kit	517955S
3.0 (210 kw)	2014.03-		Front;Rear	Hatchback 4WD N57D30A		Flexible Coupling	517955
	2014.03-		Front	Hatchback 4WD N57D30A		Flexible Coupling Kit	517955S
330d xDrive Touring							
3.0 (180 kw)	2008.09-2012.10		Centre	Estate 4WD N57D30A		Center Bearing Support	530151
	2008.09-2012.10		Centre	Estate 4WD N57D30A		Center Bearing Support	530152
	2008.09-2012.10		Front	Estate 4WD N57D30A		Flexible Coupling	517956
	2008.09-2012.10		Front	Estate 4WD N57D30A		Flexible Coupling	537669
	2008.09-2012.10		Front;Rear	Estate 4WD N57D30A		Flexible Coupling	517955
	2008.09-2012.10		Front	Estate 4WD N57D30A		Flexible Coupling Kit	537669S
3.0 (190 kw)	2013.03-2019.06	AT/MT	Front	Estate 4WD N57D30A		Propshaft	PS900112
	2013.03-2019.06	AT/MT	Front	Combi van 4WD N57D30A		Propshaft	PS900112
	2013.03-2019.06		Front;Rear	Estate 4WD N57D30A		Flexible Coupling	517955
	2013.03-2019.06		Front	Estate 4WD N57D30A		Flexible Coupling Kit	517955S
3.0 (195 kw)	2019.07-	AT	Front	Estate 4WD B57D30A		Propshaft	PS900139
	2019.07-	AT	Front	Combi van 4WD B57D30A		Propshaft	PS900139
	2019.07-		Front	Estate 4WD B57D30A		Flexible Coupling	537631
3.0 (210 kw)	2013.03-2019.06	AT/MT	Front	Estate 4WD N57D30A		Propshaft	PS900112
330e							
2.0 (135 kw)	2015.11-2018.10		Front	Saloon RWD B48B20A		Flexible Coupling	510596
	2015.11-2018.10		Front	Saloon RWD B48B20A		Flexible Coupling Kit	510596S
330i							
2.0 (185 kw)	2015.07-2018.10		Front	Saloon RWD B46B20B/B48B20B		Flexible Coupling	510596
	2015.07-2018.10		Rear	Saloon RWD B46B20B/B48B20B		Flexible Coupling	537625
	2015.07-2018.10		Front	Saloon RWD B46B20B/B48B20B		Flexible Coupling Kit	510596S
	2015.07-2018.10		Rear	Saloon RWD B46B20B/B48B20B		Flexible Coupling Kit	537625S
3.0 (168 kw)	2001.01-2005.12		Front	Saloon RWD M54B306S3		Flexible Coupling	510596
3.0 (170 kw)	2000.06-2005.02		Centre	Saloon RWD M54B306S3		Center Bearing Support	512301
	2000.06-2005.02		Centre	Saloon 4WD M54B306S3		Center Bearing Support	530154
	2000.06-2005.02		Front	Saloon RWD M54B306S3		Flexible Coupling	510596
	2000.06-2005.02		Front	Saloon 4WD M54B306S3		Flexible Coupling	537631
	2000.06-2005.02		Front	Saloon RWD M54B306S3		Flexible Coupling Kit	510596S
3.0 (190 kw)	2004.12-2011.10		Centre	Saloon RWD N52B30A/N52B30BF		Center Bearing Support	530151
	2004.12-2011.10		Front	Saloon RWD N52B30A/N52B30BF		Flexible Coupling	510596
	2004.12-2011.10		Rear	Saloon RWD N52B30A/N52B30BF		Flexible Coupling	533878
	2004.12-2011.10		Front	Saloon RWD N52B30A/N52B30BF		Flexible Coupling Kit	510596S
	2005.10-2007.06	AT	Rear	Saloon 4WD N52B30A		Propshaft	PS900123
	2005.10-2007.06		Centre	Saloon 4WD N52B30A		Center Bearing Support	530151
	2005.10-2007.06		Front	Saloon 4WD N52B30A		Flexible Coupling	517956
	2005.10-2007.06		Rear	Saloon 4WD N52B30A		Flexible Coupling	533878
3.0 (200 kw)	2007.03-2008.08	AT	Rear	Saloon 4WD N53B30A		Propshaft	PS900123
	2007.03-2008.08		Centre	Saloon 4WD N53B30A		Center Bearing Support	530151
	2007.03-2008.08		Front	Saloon 4WD N53B30A		Flexible Coupling	517956
	2007.03-2008.08		Rear	Saloon 4WD N53B30A		Flexible Coupling	533878
	2007.03-2011.12		Centre	Saloon RWD N52B30A/N52B30BF/N53B30A		Center Bearing Support	530151
	2007.03-2011.12		Front	Saloon RWD N52B30A/N52B30BF/N53B30A		Flexible Coupling	510596
	2007.03-2011.12		Rear	Saloon RWD N52B30A/N52B30BF/N53B30A		Flexible Coupling	533878
	2007.03-2011.12		Front	Saloon RWD N52B30A/N52B30BF/N53B30A		Flexible Coupling Kit	510596S
330i Cabrio							
3.0 (170 kw)	2000.06-2006.08		Centre	Cabriolet RWD M54B306S3		Center Bearing Support	512301
	2000.06-2006.08		Front	Cabriolet RWD M54B306S3		Flexible Coupling	510596
	2000.06-2006.08		Front	Cabriolet RWD M54B306S3		Flexible Coupling Kit	510596S
3.0 (190 kw)	2010.03-2013.10		Centre	Cabriolet RWD N52B30A		Center Bearing Support	530151
	2010.03-2013.10		Front	Cabriolet RWD N52B30A		Flexible Coupling	510596
	2010.03-2013.10		Rear	Cabriolet RWD N52B30A		Flexible Coupling	533878
	2010.03-2013.10		Front	Cabriolet RWD N52B30A		Flexible Coupling Kit	510596S
3.0 (200 kw)	2007.03-2013.10		Centre	Cabriolet RWD N52B30A/N52B30BF/N53B30A		Center Bearing Support	530151
	2007.03-2013.10		Front	Cabriolet RWD N52B30A/N52B30BF/N53B30A		Flexible Coupling	510596
	2007.03-2013.10		Rear	Cabriolet RWD N52B30A/N52B30BF/N53B30A		Flexible Coupling	533878
	2007.03-2013.10		Front	Cabriolet RWD N52B30A/N52B30BF/N53B30A		Flexible Coupling Kit	510596S
330i Coupe							
3.0 (170 kw)	2000.06-2006.05		Centre	Coupe RWD M54B306S3		Center Bearing Support	512301
	2000.06-2006.05		Front	Coupe RWD M54B306S3		Flexible Coupling	510596



	 YEAR	TRANSM.	FITTING POSITION	BODY STYLE & DRIVE TYPE & ENGINE	REMARKS	 PRODUCT	GSP Ref.
BMW							
330i Coupe							
3.0 (170 kw)	2000.06-2006.05		Front	Coupe RWD M54B306S3		Flexible Coupling Kit	510596S
3.0 (190 kw)	2006.09-2008.09	AT	Rear	Coupe 4WD N52B30A		Propshaft	PS900123
	2006.09-2008.09		Centre	Coupe 4WD N52B30A		Center Bearing Support	530151
	2006.09-2008.09		Rear	Coupe 4WD N52B30A		Flexible Coupling	533878
	2010.03-2013.06		Centre	Coupe RWD N52B30A		Center Bearing Support	530151
	2010.03-2013.06		Front	Coupe RWD N52B30A		Flexible Coupling	510596
	2010.03-2013.06		Rear	Coupe RWD N52B30A		Flexible Coupling	533878
3.0 (200 kw)	2006.09-2010.02	AT/MT	Front	Coupe 4WD N52B30A/N53B30A		Propshaft	PS900124
	2006.09-2010.02	AT	Rear	Coupe 4WD N52B30A/N53B30A		Propshaft	PS900123
	2006.09-2010.02		Centre	Coupe 4WD N52B30A/N53B30A		Center Bearing Support	530151
	2006.09-2010.02		Front	Coupe 4WD N52B30A/N53B30A		Flexible Coupling	517956
	2006.09-2010.02		Rear	Coupe 4WD N52B30A/N53B30A		Flexible Coupling	533878
	2006.09-2013.06		Centre	Coupe RWD N52B30A/N52B30BF/N53B30A		Center Bearing Support	530151
	2006.09-2013.06		Front	Coupe RWD N52B30A/N52B30BF/N53B30A		Flexible Coupling	510596
	2006.09-2013.06		Rear	Coupe RWD N52B30A/N52B30BF/N53B30A		Flexible Coupling	533878
2006.09-2013.06		Front	Coupe RWD N52B30A/N52B30BF/N53B30A		Flexible Coupling Kit	510596S	
330i Gran Turismo							
2.0 (185 kw)	2016.07-		Front	Hatchback RWD B48B20B		Flexible Coupling	510596
	2016.07-		Rear	Hatchback RWD B48B20B		Flexible Coupling	537625
	2016.07-		Front	Hatchback RWD B48B20B		Flexible Coupling Kit	510596S
	2016.07-		Rear	Hatchback RWD B48B20B		Flexible Coupling Kit	537625S
330i Touring							
2.0 (185 kw)	2015.07-2019.06		Front	Estate RWD B48B20B		Flexible Coupling	510596
	2015.07-2019.06		Rear	Estate RWD B48B20B		Flexible Coupling	537625
	2015.07-2019.06		Front	Estate RWD B48B20B		Flexible Coupling Kit	510596S
	2015.07-2019.06		Rear	Estate RWD B48B20B		Flexible Coupling Kit	537625S
3.0 (170 kw)	2000.06-2005.02		Centre	Estate RWD M54B306S3		Center Bearing Support	512301
	2000.06-2005.02		Centre	Estate 4WD M54B306S3		Center Bearing Support	530154
	2000.06-2005.02		Front	Estate RWD M54B306S3		Flexible Coupling	510596
	2000.06-2005.02		Front	Estate 4WD M54B306S3		Flexible Coupling	537631
	2000.06-2005.02		Front	Estate RWD M54B306S3		Flexible Coupling Kit	510596S
	2000.06-2005.02		Front	Estate 4WD M54B306S3		Flexible Coupling Kit	537631S
3.0 (190 kw)	2005.09-2007.08		Centre	Estate RWD N52B30A		Center Bearing Support	530151
	2005.09-2007.08		Front	Estate RWD N52B30A		Flexible Coupling	510596
	2005.09-2007.08		Rear	Estate RWD N52B30A		Flexible Coupling	533878
	2005.09-2007.08		Front	Estate RWD N52B30A		Flexible Coupling Kit	510596S
	2005.10-2007.08	AT/MT	Front	Estate 4WD N52B30A		Propshaft	PS900124
	2005.10-2007.08		Centre	Estate 4WD N52B30A		Center Bearing Support	530151
	2005.10-2007.08		Front	Estate 4WD N52B30A		Flexible Coupling	517956
	2005.10-2007.08		Rear	Estate 4WD N52B30A		Flexible Coupling	533878
3.0 (200 kw)	2007.03-2012.06		Centre	Estate RWD N52B30A/N53B30A		Center Bearing Support	530151
	2007.03-2012.06		Front	Estate RWD N52B30A/N53B30A		Flexible Coupling	510596
	2007.03-2012.06		Rear	Estate RWD N52B30A/N53B30A		Flexible Coupling	533878
	2007.03-2012.06		Front	Estate RWD N52B30A/N53B30A		Flexible Coupling Kit	510596S
	2007.09-2012.10	AT/MT	Front	Estate 4WD N53B30A		Propshaft	PS900124
	2007.09-2012.10		Centre	Estate 4WD N53B30A		Center Bearing Support	530151
	2007.09-2012.10		Front	Estate 4WD N53B30A		Flexible Coupling	517956
	2007.09-2012.10		Rear	Estate 4WD N53B30A		Flexible Coupling	533878
330i xDrive							
2.0 (185 kw)	2015.07-2018.10	AT/MT	Front	Saloon 4WD B48B20B		Propshaft	PS900112
	2015.07-2018.10		Rear	Saloon 4WD B48B20B		Flexible Coupling	537625
	2015.07-2018.10		Front;Rear	Saloon 4WD B48B20B		Flexible Coupling	517955
	2015.07-2018.10		Front	Saloon 4WD B48B20B		Flexible Coupling Kit	517955S
	2015.07-2018.10		Rear	Saloon 4WD B48B20B		Flexible Coupling Kit	537625S
2.0 (190 kw)	2018.11-	AT	Front	Saloon 4WD B46B20B/B48B20B		Propshaft	PS900139
	2018.11-		Front	Saloon 4WD B46B20B/B48B20B		Flexible Coupling	537631
	2018.11-		Rear	Saloon 4WD B46B20B/B48B20B		Flexible Coupling	537625
3.0 (200 kw)	2008.09-2011.12		Centre	Saloon 4WD N53B30A		Center Bearing Support	530151
	2008.09-2011.12		Front	Saloon 4WD N53B30A		Flexible Coupling	517956
	2008.09-2011.12		Rear	Saloon 4WD N53B30A		Flexible Coupling	533878
330i xDrive Coupe							
3.0 (200 kw)	2008.09-	AT/MT	Front	Coupe 4WD N53B30A		Propshaft	PS900124
	2008.09-		Front	Coupe 4WD N53B30A		Flexible Coupling	517956



	 YEAR	TRANSM.	FITTING POSITION	BODY STYLE & DRIVE TYPE & ENGINE	REMARKS	 PRODUCT	GSP Ref.
BMW							
330i xDrive Coupe							
3.0 (200 kw)	2008.09-		Rear	Coupe 4WD N53B30A		Flexible Coupling	533878
330i xDrive Gran Turismo							
2.0 (185 kw)	2016.07-		Front;Rear	Hatchback 4WD B48B20B		Flexible Coupling	517955
	2016.07-		Rear	Hatchback 4WD B48B20B		Flexible Coupling Kit	537625S
330i xDrive Touring							
2.0 (185 kw)	2015.07-2019.06		Front	Estate 4WD B48B20B		Flexible Coupling	510596
	2015.07-2019.06		Rear	Estate 4WD B48B20B		Flexible Coupling	537625
	2015.07-2019.06		Rear	Estate 4WD B48B20B		Flexible Coupling Kit	537625S
2.0 (190 kw)	2019.07-	AT	Front	Estate 4WD B48B20B		Propshaft	PS900139
	2019.07-		Front	Estate 4WD B48B20B		Flexible Coupling	537631
	2019.07-		Rear	Estate 4WD B48B20B		Flexible Coupling	537625
3.0 (200 kw)	2007.09-2012.06	AT/MT	Front	Estate 4WD N53B30A		Propshaft	PS900124
	2007.09-2012.06		Centre	Estate 4WD N53B30A		Center Bearing Support	530151
	2007.09-2012.06		Front	Estate 4WD N53B30A		Flexible Coupling	517956
	2007.09-2012.06		Rear	Estate 4WD N53B30A		Flexible Coupling	533878
335d							
3.0 (210 kw)	2006.07-2011.12		Centre	Saloon RWD M57D306D5		Center Bearing Support	530151
	2006.07-2011.12		Centre	Saloon RWD M57D306D5		Center Bearing Support	530152
	2006.07-2011.12		Front;Rear	Saloon RWD M57D306D5		Flexible Coupling	517955
	2006.07-2011.12		Front	Saloon RWD M57D306D5		Flexible Coupling Kit	517955S
335d Coupe							
3.0 (210 kw)	2006.08-		Centre	Coupe RWD M57D306D5		Center Bearing Support	530151
	2006.08-		Centre	Coupe RWD M57D306D5		Center Bearing Support	530152
	2006.08-		Front;Rear	Coupe RWD M57D306D5		Flexible Coupling	517955
	2006.08-		Front	Coupe RWD M57D306D5		Flexible Coupling Kit	517955S
335d Touring							
3.0 (210 kw)	2006.06-2012.10		Centre	Estate RWD M57D306D5		Center Bearing Support	530151
	2006.06-2012.10		Centre	Estate RWD M57D306D5		Center Bearing Support	530152
	2006.06-2012.10		Front	Estate RWD M57D306D5		Flexible Coupling	530758
	2006.06-2012.10		Front;Rear	Estate RWD M57D306D5		Flexible Coupling	517955
	2006.06-2012.10		Front	Estate RWD M57D306D5		Flexible Coupling Kit	517955S
335d xDrive							
3.0 (230 kw)	2013.07-2018.10	AT/MT	Front	Saloon 4WD N57D30B	Date From:2014.01	Propshaft	PS900112
335d xDrive Gran Turismo							
3.0 (230 kw)	2014.03-		Front;Rear	Hatchback 4WD N57D30B		Flexible Coupling	517955
	2014.03-		Front	Hatchback 4WD N57D30B		Flexible Coupling Kit	517955S
335d xDrive Touring							
3.0 (230 kw)	2013.11-2019.06	AT/MT	Front	Estate 4WD N57D30B	Date From:2014.01	Propshaft	PS900112
	2013.11-2019.06		Front;Rear	Estate 4WD N57D30B		Flexible Coupling	517955
	2013.11-2019.06		Front	Estate 4WD N57D30B		Flexible Coupling Kit	517955S
335i							
3.0 (224 kw)	2007.09-2011.12		Front;Rear	Saloon RWD N54B30A/N55B30A		Flexible Coupling	517955
	2007.09-2011.12		Front	Saloon RWD N54B30A/N55B30A		Flexible Coupling Kit	517955S
3.0 (225 kw)	2006.09-2011.12		Centre	Saloon RWD N54B30A/N55B30A		Center Bearing Support	530151
	2006.09-2011.12		Centre	Saloon RWD N54B30A/N55B30A		Center Bearing Support	530152
	2006.09-2011.12		Front;Rear	Saloon RWD N54B30A/N55B30A		Flexible Coupling	517955
	2006.09-2011.12		Front	Saloon RWD N54B30A/N55B30A		Flexible Coupling Kit	517955S
	2007.03-2008.08	AT/MT	Front	Saloon 4WD N54B30A		Propshaft	PS900124
	2007.03-2008.08		Centre	Saloon 4WD N54B30A		Center Bearing Support	530151
	2007.03-2008.08		Centre	Saloon 4WD N54B30A		Center Bearing Support	530152
	2011.11-2015.07		Centre	Saloon RWD N55B30A		Center Bearing Support	530151
	2011.11-2015.07		Centre	Saloon RWD N55B30A		Center Bearing Support	530152
	2011.11-2015.07		Front;Rear	Saloon RWD N55B30A		Flexible Coupling	517955
	2011.11-2015.07		Front	Saloon RWD N55B30A		Flexible Coupling Kit	517955S
3.0 (240 kw)	2006.03-2011.12		Front;Rear	Saloon RWD N54B30A/N55B30A		Flexible Coupling	517955
	2006.03-2011.12		Front	Saloon RWD N54B30A/N55B30A		Flexible Coupling Kit	517955S
	2011.11-2013.06		Front;Rear	Saloon RWD N55B30A		Flexible Coupling	517955
	2011.11-2013.06		Front	Saloon RWD N55B30A		Flexible Coupling Kit	517955S
3.0 (250 kw)	2013.07-2015.07		Front;Rear	Saloon RWD N55B30A		Flexible Coupling	517955
	2013.07-2015.07		Front	Saloon RWD N55B30A		Flexible Coupling Kit	517955S
335i Cabrio							
3.0 (225 kw)	2006.12-2013.10		Centre	Cabriolet RWD N54B30A/N55B30A		Center Bearing Support	530151
	2006.12-2013.10		Centre	Cabriolet RWD N54B30A/N55B30A		Center Bearing Support	530152
	2006.12-2013.10		Front;Rear	Cabriolet RWD N54B30A/N55B30A		Flexible Coupling	517955

	 YEAR	TRANSM.	FITTING POSITION	BODY STYLE & DRIVE TYPE & ENGINE	REMARKS	 PRODUCT	GSP Ref.
BMW							
335i Cabrio							
3.0 (225 kw)	2006.12-2013.10		Front	Cabriolet RWD N54B30A/N55B30A		Flexible Coupling Kit	517955S
3.0 (240 kw)	2006.06-2013.10		Front;Rear	Cabriolet RWD N54B30A/N55B30A		Flexible Coupling	517955
	2006.06-2013.10		Front	Cabriolet RWD N54B30A/N55B30A		Flexible Coupling Kit	517955S
335i Coupe							
3.0 (225 kw)	2006.06-2013.06		Centre	Coupe RWD N54B30A/N55B30A		Center Bearing Support	530151
	2006.06-2013.06		Centre	Coupe RWD N54B30A/N55B30A		Center Bearing Support	530152
	2006.06-2013.06		Front;Rear	Coupe RWD N54B30A/N55B30A		Flexible Coupling	517955
	2006.06-2013.06		Front	Coupe RWD N54B30A/N55B30A		Flexible Coupling Kit	517955S
	2007.06-2008.12	AT/MT	Front	Coupe 4WD N54B30A		Propshaft	PS900124
	2007.06-2008.12		Centre	Coupe 4WD N54B30A		Center Bearing Support	530151
	2007.06-2008.12		Centre	Coupe 4WD N54B30A		Center Bearing Support	530152
	2007.06-2008.12		Front	Coupe 4WD N54B30A		Flexible Coupling	517956
3.0 (240 kw)	2006.06-2013.06		Front;Rear	Coupe RWD N54B30A/N55B30A		Flexible Coupling	517955
	2006.06-2013.06		Front	Coupe RWD N54B30A/N55B30A		Flexible Coupling Kit	517955S
335i Gran Turismo							
3.0 (225 kw)	2013.03-2016.06		Front;Rear	Hatchback RWD N55B30A		Flexible Coupling	517955
	2013.03-2016.06		Front	Hatchback RWD N55B30A		Flexible Coupling Kit	517955S
3.0 (240 kw)	2013.03-2014.03		Front;Rear	Hatchback RWD N55B30A		Flexible Coupling	517955
	2013.03-2014.03		Front	Hatchback RWD N55B30A		Flexible Coupling Kit	517955S
3.0 (250 kw)	2014.04-2016.06		Front;Rear	Hatchback RWD N55B30A		Flexible Coupling	517955
	2014.04-2016.06		Front	Hatchback RWD N55B30A		Flexible Coupling Kit	517955S
335i Touring							
3.0 (225 kw)	2006.09-2012.06		Centre	Estate RWD N54B30A/N55B30A		Center Bearing Support	530151
	2006.09-2012.06		Centre	Estate RWD N54B30A/N55B30A		Center Bearing Support	530152
	2006.09-2012.06		Front;Rear	Estate RWD N54B30A/N55B30A		Flexible Coupling	517955
	2006.09-2012.06		Front	Estate RWD N54B30A/N55B30A		Flexible Coupling Kit	517955S
	2007.03-2008.08	AT/MT	Front	Estate 4WD N54B30A		Propshaft	PS900124
	2007.03-2008.08		Centre	Estate 4WD N54B30A		Center Bearing Support	530151
	2007.03-2008.08		Centre	Estate 4WD N54B30A		Center Bearing Support	530152
	2007.03-2008.08		Front	Estate 4WD N54B30A		Flexible Coupling	517956
	2013.03-2015.06		Front;Rear	Estate RWD N55B30A		Flexible Coupling	517955
	2013.03-2015.06		Front	Estate RWD N55B30A		Flexible Coupling Kit	517955S
3.0 (240 kw)	2006.09-2008.08	AT/MT	Front	Estate 4WD N54B30A		Propshaft	PS900124
	2006.09-2012.06		Front;Rear	Estate RWD N54B30A/N55B30A		Flexible Coupling	517955
	2006.09-2012.06		Front	Estate RWD N54B30A/N55B30A		Flexible Coupling Kit	517955S
	2013.03-2013.06		Front;Rear	Estate RWD N55B30A		Flexible Coupling	517955
	2013.03-2013.06		Front	Estate RWD N55B30A		Flexible Coupling Kit	517955S
3.0 (250 kw)	2013.07-2015.06		Front;Rear	Estate RWD N55B30A		Flexible Coupling	517955
	2013.07-2015.06		Front	Estate RWD N55B30A		Flexible Coupling Kit	517955S
335i xDrive							
3.0 (225 kw)	2008.09-2011.10		Centre	Saloon 4WD N54B30A/N55B30A		Center Bearing Support	530151
	2008.09-2011.10		Centre	Saloon 4WD N54B30A/N55B30A		Center Bearing Support	530152
	2008.09-2011.10		Front	Saloon 4WD N54B30A/N55B30A		Flexible Coupling	517956
	2012.07-2015.07	AT/MT	Front	Saloon 4WD N55B30A	Date From:2013.01	Propshaft	PS900112
	2012.07-2015.07		Centre	Saloon 4WD N55B30A		Center Bearing Support	530151
	2012.07-2015.07		Front;Rear	Saloon 4WD N55B30A		Flexible Coupling	517955
	2012.07-2015.07		Front	Saloon 4WD N55B30A		Flexible Coupling Kit	517955S
3.0 (240 kw)	2012.07-2013.06	AT/MT	Front	Saloon 4WD N55B30A	Date From:2013.01	Propshaft	PS900112
	2012.07-2013.06		Front;Rear	Saloon 4WD N55B30A		Flexible Coupling	517955
	2012.07-2013.06		Front	Saloon 4WD N55B30A		Flexible Coupling Kit	517955S
3.0 (250 kw)	2012.07-2015.07		Front;Rear	Saloon 4WD N55B30A		Flexible Coupling	517955
	2012.07-2015.07		Front	Saloon 4WD N55B30A		Flexible Coupling Kit	517955S
335i xDrive Coupe							
3.0 (224 kw)	2011.01-	AT/MT	Front	Coupe 4WD N55B30A		Propshaft	PS900124
3.0 (225 kw)	2008.09-	AT/MT	Front	Coupe 4WD N54B30A/N55B30A		Propshaft	PS900124
	2008.09-		Front	Coupe 4WD N54B30A/N55B30A		Flexible Coupling	517956
3.0 (240 kw)	2007.03-2013.06	AT/MT	Front	Coupe 4WD N54B30A/N55B30A		Propshaft	PS900124
335i xDrive Gran Turismo							
3.0 (225 kw)	2013.07-2016.06		Front;Rear	Hatchback 4WD N55B30A		Flexible Coupling	517955
	2013.07-2016.06		Front	Hatchback 4WD N55B30A		Flexible Coupling Kit	517955S
3.0 (240 kw)	2013.03-2014.03		Front;Rear	Hatchback 4WD N55B30A		Flexible Coupling	517955
	2013.03-2014.03		Front	Hatchback 4WD N55B30A		Flexible Coupling Kit	517955S
3.0 (250 kw)	2014.04-2016.05		Front;Rear	Hatchback 4WD N55B30A		Flexible Coupling	517955
	2014.04-2016.05		Front	Hatchback 4WD N55B30A		Flexible Coupling Kit	517955S



	 YEAR	TRANSM.	FITTING POSITION	BODY STYLE & DRIVE TYPE & ENGINE	REMARKS	 PRODUCT	GSP Ref.
BMW							
335i xDrive Touring							
3.0 (225 kw)	2008.09-2012.06		Centre	Estate 4WD N54B30A/N55B30A		Center Bearing Support	530151
	2008.09-2012.06		Centre	Estate 4WD N54B30A/N55B30A		Center Bearing Support	530152
	2008.09-2012.06		Front	Estate 4WD N54B30A/N55B30A		Flexible Coupling	517956
	2013.03-2015.06		Front;Rear	Estate 4WD N55B30A		Flexible Coupling	517955
	2013.03-2015.06		Front	Estate 4WD N55B30A		Flexible Coupling Kit	517955S
3.0 (240 kw)	2008.09-2012.06	AT/MT	Front	Estate 4WD N54B30A/N55B30A		Propshaft	PS900124
	2013.03-2013.06		Front;Rear	Estate 4WD N55B30A		Flexible Coupling	517955
	2013.03-2013.06		Front	Estate 4WD N55B30A		Flexible Coupling Kit	517955S
3.0 (250 kw)	2013.07-2015.06		Front;Rear	Estate 4WD N55B30A		Flexible Coupling	517955
	2013.07-2015.06		Front	Estate 4WD N55B30A		Flexible Coupling Kit	517955S
340i							
3.0 (240 kw)	2015.07-2018.10		Front;Rear	Saloon RWD B58B30A		Flexible Coupling	517955
	2015.07-2018.10		Front	Saloon RWD B58B30A		Flexible Coupling Kit	517955S
3.0 (265 kw)	2015.07-2018.10		Front;Rear	Saloon RWD B58B30A		Flexible Coupling	517955
	2015.07-2018.10		Front	Saloon RWD B58B30A		Flexible Coupling Kit	517955S
340i Gran Turismo							
3.0 (240 kw)	2016.07-		Front;Rear	Hatchback RWD B58B30A		Flexible Coupling	517955
	2016.07-		Front	Hatchback RWD B58B30A		Flexible Coupling Kit	517955S
340i Touring							
3.0 (240 kw)	2015.07-2019.06		Front;Rear	Estate RWD B58B30A		Flexible Coupling	517955
	2015.07-2019.06		Front	Estate RWD B58B30A		Flexible Coupling Kit	517955S
3.0 (265 kw)	2015.07-2019.06		Front;Rear	Estate RWD B58B30A		Flexible Coupling	517955
	2015.07-2019.06		Front	Estate RWD B58B30A		Flexible Coupling Kit	517955S
340i xDrive							
3.0 (240 kw)	2015.07-2018.10	AT/MT	Front	Saloon 4WD B58B30A		Propshaft	PS900112
	2015.07-2018.10		Front;Rear	Saloon 4WD B58B30A		Flexible Coupling	517955
	2015.07-2018.10		Front	Saloon 4WD B58B30A		Flexible Coupling Kit	517955S
3.0 (265 kw)	2015.07-2018.10	AT/MT	Front	Saloon 4WD B58B30A		Propshaft	PS900112
	2015.07-2018.10		Front;Rear	Saloon 4WD B58B30A		Flexible Coupling	517955
	2015.07-2018.10		Front	Saloon 4WD B58B30A		Flexible Coupling Kit	517955S
340i xDrive Gran Turismo							
3.0 (240 kw)	2016.07-		Front;Rear	Hatchback 4WD B58B30A		Flexible Coupling	517955
	2016.07-		Front	Hatchback 4WD B58B30A		Flexible Coupling Kit	517955S
340i xDrive Touring							
3.0 (240 kw)	2015.07-2019.06		Front;Rear	Estate 4WD B58B30A		Flexible Coupling	517955
	2015.07-2019.06		Front	Estate 4WD B58B30A		Flexible Coupling Kit	517955S
3.0 (265 kw)	2015.07-2019.06		Front;Rear	Estate 4WD B58B30A		Flexible Coupling	517955
	2015.07-2019.06		Front	Estate 4WD B58B30A		Flexible Coupling Kit	517955S
418d Coupe							
2.0 (100 kw)	2015.03-2017.10		Front	Coupe RWD B47D20A		Flexible Coupling	510596
	2015.03-2017.10		Rear	Coupe RWD B47D20A		Flexible Coupling	537625
	2015.03-2017.10		Front	Coupe RWD B47D20A		Flexible Coupling Kit	510596S
	2015.03-2017.10		Rear	Coupe RWD B47D20A		Flexible Coupling Kit	537625S
2.0 (110 kw)	2015.03-2017.10		Front	Coupe RWD B47D20A		Flexible Coupling	510596
	2015.03-2017.10		Rear	Coupe RWD B47D20A		Flexible Coupling	537625
	2015.03-2017.10		Front	Coupe RWD B47D20A		Flexible Coupling Kit	510596S
	2015.03-2017.10		Rear	Coupe RWD B47D20A		Flexible Coupling Kit	537625S
418d Gran Coupe							
2.0 (100 kw)	2014.03-2020.12		Front	Coupe RWD B47D20A/N47D20C		Flexible Coupling	510596
	2014.03-2020.12		Rear	Coupe RWD B47D20A/N47D20C		Flexible Coupling	537625
	2014.03-2020.12		Rear	Coupe RWD B47D20A/N47D20C		Flexible Coupling Kit	537625S
2.0 (105 kw)	2014.03-2015.06		Front	Coupe RWD N47D20C		Flexible Coupling	510596
	2014.03-2015.06		Rear	Coupe RWD N47D20C		Flexible Coupling	537625
	2014.03-2015.06		Rear	Coupe RWD N47D20C		Flexible Coupling Kit	537625S
2.0 (110 kw)	2015.07-		Front	Coupe RWD B47D20A		Flexible Coupling	510596
	2015.07-		Rear	Coupe RWD B47D20A		Flexible Coupling	537625
	2015.07-		Rear	Coupe RWD B47D20A		Flexible Coupling Kit	537625S
418i Coupe							
1.5 (100 kw)	2016.03-		Front	Coupe RWD B38B15A		Flexible Coupling	510596
	2016.03-		Rear	Coupe RWD B38B15A		Flexible Coupling	537625
	2016.03-		Front	Coupe RWD B38B15A		Flexible Coupling Kit	510596S
	2016.03-		Rear	Coupe RWD B38B15A		Flexible Coupling Kit	537625S

	 YEAR	TRANSM.	FITTING POSITION	BODY STYLE & DRIVE TYPE & ENGINE	REMARKS	 PRODUCT	GSP Ref.
BMW							
418i Gran Coupe							
1.5 (100 kw)	2015.07-		Front	Coupe RWD B38B15A		Flexible Coupling	510596
	2015.07-		Rear	Coupe RWD B38B15A		Flexible Coupling	537625
	2015.07-		Front	Coupe RWD B38B15A		Flexible Coupling Kit	510596S
	2015.07-		Rear	Coupe RWD B38B15A		Flexible Coupling Kit	537625S
420d Cabrio							
2.0 (120 kw)	2013.10-		Front	Cabriolet RWD B47D20A/N47D20C		Flexible Coupling	510596
	2013.10-		Rear	Cabriolet RWD B47D20A/N47D20C		Flexible Coupling	537625
	2013.10-		Front;Rear	Cabriolet RWD B47D20A/N47D20C		Flexible Coupling	517955
	2013.10-		Front	Cabriolet RWD B47D20A/N47D20C		Flexible Coupling Kit	510596S
	2013.10-		Front	Cabriolet RWD B47D20A/N47D20C		Flexible Coupling Kit	517955S
	2013.10-		Rear	Cabriolet RWD B47D20A/N47D20C		Flexible Coupling Kit	537625S
2.0 (135 kw)	2013.10-2015.06		Front	Cabriolet RWD N47D20C		Flexible Coupling	510596
	2013.10-2015.06		Rear	Cabriolet RWD N47D20C		Flexible Coupling	537625
	2013.10-2015.06		Front;Rear	Cabriolet RWD N47D20C		Flexible Coupling	517955
	2013.10-2015.06		Front	Cabriolet RWD N47D20C		Flexible Coupling Kit	510596S
	2013.10-2015.06		Front	Cabriolet RWD N47D20C		Flexible Coupling Kit	517955S
	2013.10-2015.06		Rear	Cabriolet RWD N47D20C		Flexible Coupling Kit	537625S
2.0 (140 kw)	2015.07-		Front	Cabriolet RWD B47D20A		Flexible Coupling	510596
	2015.07-		Rear	Cabriolet RWD B47D20A		Flexible Coupling	537625
	2015.07-		Front	Cabriolet RWD B47D20A		Flexible Coupling Kit	510596S
	2015.07-		Rear	Cabriolet RWD B47D20A		Flexible Coupling Kit	537625S
2.0 (147 kw)	2013.10-2015.06		Front	Cabriolet RWD N47D20C		Flexible Coupling	510596
	2013.10-2015.06		Rear	Cabriolet RWD N47D20C		Flexible Coupling	537625
	2013.10-2015.06		Front;Rear	Cabriolet RWD N47D20C		Flexible Coupling	517955
	2013.10-2015.06		Front	Cabriolet RWD N47D20C		Flexible Coupling Kit	510596S
	2013.10-2015.06		Front	Cabriolet RWD N47D20C		Flexible Coupling Kit	517955S
	2013.10-2015.06		Rear	Cabriolet RWD N47D20C		Flexible Coupling Kit	537625S
420d Coupe							
2.0 (120 kw)	2013.07-		Front	Coupe RWD B47D20A/N47D20C		Flexible Coupling	510596
	2013.07-		Rear	Coupe RWD B47D20A/N47D20C		Flexible Coupling	537625
	2013.07-		Front;Rear	Coupe RWD B47D20A/N47D20C		Flexible Coupling	517955
	2013.07-		Front	Coupe RWD B47D20A/N47D20C		Flexible Coupling Kit	510596S
	2013.07-		Front	Coupe RWD B47D20A/N47D20C		Flexible Coupling Kit	517955S
	2013.07-		Rear	Coupe RWD B47D20A/N47D20C		Flexible Coupling Kit	537625S
2.0 (135 kw)	2013.07-2015.02		Front	Coupe RWD N47D20C		Flexible Coupling	510596
	2013.07-2015.02		Rear	Coupe RWD N47D20C		Flexible Coupling	537625
	2013.07-2015.02		Front;Rear	Coupe RWD N47D20C		Flexible Coupling	517955
	2013.07-2015.02		Front	Coupe RWD N47D20C		Flexible Coupling Kit	510596S
	2013.07-2015.02		Front	Coupe RWD N47D20C		Flexible Coupling Kit	517955S
	2013.07-2015.02		Rear	Coupe RWD N47D20C		Flexible Coupling Kit	537625S
2.0 (140 kw)	2015.03-		Front	Coupe RWD B47D20A		Flexible Coupling	510596
	2015.03-		Rear	Coupe RWD B47D20A		Flexible Coupling	537625
	2015.03-		Front	Coupe RWD B47D20A		Flexible Coupling Kit	510596S
	2015.03-		Rear	Coupe RWD B47D20A		Flexible Coupling Kit	537625S
2.0 (147 kw)	2013.07-2015.02		Front	Coupe RWD N47D20C		Flexible Coupling	510596
	2013.07-2015.02		Rear	Coupe RWD N47D20C		Flexible Coupling	537625
	2013.07-2015.02		Front;Rear	Coupe RWD N47D20C		Flexible Coupling	517955
	2013.07-2015.02		Front	Coupe RWD N47D20C		Flexible Coupling Kit	510596S
	2013.07-2015.02		Front	Coupe RWD N47D20C		Flexible Coupling Kit	517955S
	2013.07-2015.02		Rear	Coupe RWD N47D20C		Flexible Coupling Kit	537625S
420d Gran Coupe							
2.0 (120 kw)	2014.03-2020.12		Front	Coupe RWD B47D20A/N47D20C		Flexible Coupling	510596
	2014.03-2020.12		Rear	Coupe RWD B47D20A/N47D20C		Flexible Coupling	537625
	2014.03-2020.12		Front;Rear	Coupe RWD B47D20A/N47D20C		Flexible Coupling	517955
	2014.03-2020.12		Front	Coupe RWD B47D20A/N47D20C		Flexible Coupling Kit	517955S
	2014.03-2020.12		Rear	Coupe RWD B47D20A/N47D20C		Flexible Coupling Kit	537625S
2.0 (135 kw)	2014.03-2015.02		Front	Coupe RWD N47D20C		Flexible Coupling	510596
	2014.03-2015.02		Rear	Coupe RWD N47D20C		Flexible Coupling	537625
	2014.03-2015.02		Front;Rear	Coupe RWD N47D20C		Flexible Coupling	517955
	2014.03-2015.02		Front	Coupe RWD N47D20C		Flexible Coupling Kit	517955S
	2014.03-2015.02		Rear	Coupe RWD N47D20C		Flexible Coupling Kit	537625S
2.0 (140 kw)	2015.03-		Front	Coupe RWD B47D20A		Flexible Coupling	510596
	2015.03-		Rear	Coupe RWD B47D20A		Flexible Coupling	537625
	2015.03-		Rear	Coupe RWD B47D20A		Flexible Coupling Kit	537625S



	 YEAR	TRANSM.	FITTING POSITION	BODY STYLE & DRIVE TYPE & ENGINE	REMARKS	 PRODUCT	GSP Ref.
BMW							
420d Gran Coupe							
2.0 (147 kw)	2014.03-2015.02		Front	Coupe RWD N47D20C		Flexible Coupling	510596
	2014.03-2015.02		Rear	Coupe RWD N47D20C		Flexible Coupling	537625
	2014.03-2015.02		Front;Rear	Coupe RWD N47D20C		Flexible Coupling	517955
	2014.03-2015.02		Front	Coupe RWD N47D20C		Flexible Coupling Kit	517955S
	2014.03-2015.02		Rear	Coupe RWD N47D20C		Flexible Coupling Kit	537625S
420d xDrive Coupe							
2.0 (120 kw)	2015.03-		Front	Coupe 4WD B47D20A		Flexible Coupling	510596
	2015.03-		Rear	Coupe 4WD B47D20A		Flexible Coupling	537625
	2015.03-		Rear	Coupe 4WD B47D20A		Flexible Coupling Kit	537625S
2.0 (135 kw)	2013.11-2015.02		Rear	Coupe 4WD N47D20C		Flexible Coupling	537625
	2013.11-2015.02		Front;Rear	Coupe 4WD N47D20C		Flexible Coupling	517955
	2013.11-2015.02		Front	Coupe 4WD N47D20C		Flexible Coupling Kit	517955S
	2013.11-2015.02		Rear	Coupe 4WD N47D20C		Flexible Coupling Kit	537625S
2.0 (140 kw)	2015.03-		Front	Coupe 4WD B47D20A		Flexible Coupling	510596
	2015.03-		Rear	Coupe 4WD B47D20A		Flexible Coupling	537625
	2015.03-		Rear	Coupe 4WD B47D20A		Flexible Coupling Kit	537625S
2.0 (147 kw)	2013.11-2015.02		Rear	Coupe 4WD N47D20C		Flexible Coupling	537625
	2013.11-2015.02		Front;Rear	Coupe 4WD N47D20C		Flexible Coupling	517955
	2013.11-2015.02		Front	Coupe 4WD N47D20C		Flexible Coupling Kit	517955S
	2013.11-2015.02		Rear	Coupe 4WD N47D20C		Flexible Coupling Kit	537625S
420d xDrive Gran Coupe							
2.0 (120 kw)	2014.03-2020.12		Front	Coupe 4WD B47D20A/N47D20C		Flexible Coupling	510596
	2014.03-2020.12		Rear	Coupe 4WD B47D20A/N47D20C		Flexible Coupling	537625
	2014.03-2020.12		Front;Rear	Coupe 4WD B47D20A/N47D20C		Flexible Coupling	517955
	2014.03-2020.12		Front	Coupe 4WD B47D20A/N47D20C		Flexible Coupling Kit	517955S
	2014.03-2020.12		Rear	Coupe 4WD B47D20A/N47D20C		Flexible Coupling Kit	537625S
2.0 (135 kw)	2014.03-2015.02		Rear	Coupe 4WD N47D20C		Flexible Coupling	537625
	2014.03-2015.02		Front;Rear	Coupe 4WD N47D20C		Flexible Coupling	517955
	2014.03-2015.02		Front	Coupe 4WD N47D20C		Flexible Coupling Kit	517955S
	2014.03-2015.02		Rear	Coupe 4WD N47D20C		Flexible Coupling Kit	537625S
2.0 (140 kw)	2015.03-		Front	Coupe 4WD B47D20A		Flexible Coupling	510596
	2015.03-		Rear	Coupe 4WD B47D20A		Flexible Coupling	537625
	2015.03-		Front;Rear	Coupe 4WD B47D20A		Flexible Coupling	517955
	2015.03-		Front	Coupe 4WD B47D20A		Flexible Coupling Kit	517955S
	2015.03-		Rear	Coupe 4WD B47D20A		Flexible Coupling Kit	537625S
2.0 (147 kw)	2014.03-2015.02		Rear	Coupe 4WD N47D20C		Flexible Coupling	537625
	2014.03-2015.02		Front;Rear	Coupe 4WD N47D20C		Flexible Coupling	517955
	2014.03-2015.02		Front	Coupe 4WD N47D20C		Flexible Coupling Kit	517955S
	2014.03-2015.02		Rear	Coupe 4WD N47D20C		Flexible Coupling Kit	537625S
420i Cabrio							
2.0 (120 kw)	2014.07-2016.02		Front	Cabriolet RWD N20B20B		Flexible Coupling	510596
	2014.07-2016.02		Rear	Cabriolet RWD N20B20B		Flexible Coupling	537625
	2014.07-2016.02		Front	Cabriolet RWD N20B20B		Flexible Coupling Kit	510596S
	2014.07-2016.02		Rear	Cabriolet RWD N20B20B		Flexible Coupling Kit	537625S
	2016.03-		Front	Cabriolet RWD B48B20A		Flexible Coupling	510596
	2016.03-		Rear	Cabriolet RWD B48B20A		Flexible Coupling	537625
	2016.03-		Rear	Cabriolet RWD B48B20A		Flexible Coupling Kit	537625S
	2016.03-		Rear	Cabriolet RWD B48B20A		Flexible Coupling Kit	537625S
2.0 (135 kw)	2014.07-2016.02		Front	Cabriolet RWD N20B20B		Flexible Coupling	510596
	2014.07-2016.02		Front	Cabriolet RWD N20B20B		Flexible Coupling	510597
	2014.07-2016.02		Rear	Cabriolet RWD N20B20B		Flexible Coupling	537625
	2014.07-2016.02		Front	Cabriolet RWD N20B20B		Flexible Coupling Kit	510596S
	2014.07-2016.02		Rear	Cabriolet RWD N20B20B		Flexible Coupling Kit	537625S
	2016.03-		Front	Cabriolet RWD B48B20A		Flexible Coupling	510596
	2016.03-		Rear	Cabriolet RWD B48B20A		Flexible Coupling	537625
	2016.03-		Front	Cabriolet RWD B48B20A		Flexible Coupling Kit	510596S
2016.03-		Rear	Cabriolet RWD B48B20A		Flexible Coupling Kit	537625S	
420i Coupe							
2.0 (120 kw)	2013.11-2017.02		Front	Coupe RWD N20B20A/N20B20B		Flexible Coupling	510596
	2013.11-2017.02		Rear	Coupe RWD N20B20A/N20B20B		Flexible Coupling	537625
	2013.11-2017.02		Front	Coupe RWD N20B20A/N20B20B		Flexible Coupling Kit	510596S
	2013.11-2017.02		Rear	Coupe RWD N20B20A/N20B20B		Flexible Coupling Kit	537625S
	2016.03-		Front	Coupe RWD B48B20A		Flexible Coupling	510596
	2016.03-		Rear	Coupe RWD B48B20A		Flexible Coupling	537625
2016.03-		Rear	Coupe RWD B48B20A		Flexible Coupling Kit	537625S	



	 YEAR	TRANSM.	FITTING POSITION	BODY STYLE & DRIVE TYPE & ENGINE	REMARKS	 PRODUCT	GSP Ref.
BMW							
420i Coupe							
2.0 (135 kw)	2013.11-2017.02		Front	Coupe RWD N20B20A/N20B20B		Flexible Coupling	510596
	2013.11-2017.02		Front	Coupe RWD N20B20A/N20B20B		Flexible Coupling	510597
	2013.11-2017.02		Rear	Coupe RWD N20B20A/N20B20B		Flexible Coupling	537625
	2013.11-2017.02		Front	Coupe RWD N20B20A/N20B20B		Flexible Coupling Kit	510596S
	2013.11-2017.02		Rear	Coupe RWD N20B20A/N20B20B		Flexible Coupling Kit	537625S
	2016.03-		Front	Coupe RWD B48B20A		Flexible Coupling	510596
	2016.03-		Rear	Coupe RWD B48B20A		Flexible Coupling	537625
	2016.03-		Front	Coupe RWD B48B20A		Flexible Coupling Kit	510596S
	2016.03-		Rear	Coupe RWD B48B20A		Flexible Coupling Kit	537625S
420i Gran Coupe							
2.0 (120 kw)	2014.03-2017.02		Front	Coupe RWD N20B20B		Flexible Coupling	510596
	2014.03-2017.02		Rear	Coupe RWD N20B20B		Flexible Coupling	537625
	2014.03-2017.02		Front	Coupe RWD N20B20B		Flexible Coupling Kit	510596S
	2014.03-2017.02		Rear	Coupe RWD N20B20B		Flexible Coupling Kit	537625S
	2016.03-		Front	Coupe RWD B48B20A		Flexible Coupling	510596
	2016.03-		Rear	Coupe RWD B48B20A		Flexible Coupling	537625
	2016.03-		Rear	Coupe RWD B48B20A		Flexible Coupling Kit	537625S
2.0 (135 kw)	2014.03-2017.02		Front	Coupe RWD N20B20B		Flexible Coupling	510596
	2014.03-2017.02		Rear	Coupe RWD N20B20B		Flexible Coupling	537625
	2014.03-2017.02		Front	Coupe RWD N20B20B		Flexible Coupling Kit	510596S
	2014.03-2017.02		Rear	Coupe RWD N20B20B		Flexible Coupling Kit	537625S
	2016.03-		Front	Coupe RWD B48B20A		Flexible Coupling	510596
	2016.03-		Rear	Coupe RWD B48B20A		Flexible Coupling	537625
	2016.03-		Front	Coupe RWD B48B20A		Flexible Coupling Kit	510596S
	2016.03-		Rear	Coupe RWD B48B20A		Flexible Coupling Kit	537625S
420i xDrive Coupe							
2.0 (120 kw)	2013.11-2016.02		Front	Coupe 4WD N20B20B		Flexible Coupling	510596
	2013.11-2016.02		Rear	Coupe 4WD N20B20B		Flexible Coupling	537625
	2013.11-2016.02		Front;Rear	Coupe 4WD N20B20B		Flexible Coupling	517955
	2013.11-2016.02		Front	Coupe 4WD N20B20B		Flexible Coupling Kit	517955S
	2013.11-2016.02		Rear	Coupe 4WD N20B20B		Flexible Coupling Kit	537625S
	2016.03-		Front	Coupe 4WD B48B20A		Flexible Coupling	510596
	2016.03-		Rear	Coupe 4WD B48B20A		Flexible Coupling	537625
	2016.03-		Rear	Coupe 4WD B48B20A		Flexible Coupling Kit	537625S
2.0 (135 kw)	2013.11-2016.02		Front	Coupe 4WD N20B20B		Flexible Coupling	510596
	2013.11-2016.02		Rear	Coupe 4WD N20B20B		Flexible Coupling	537625
	2013.11-2016.02		Front;Rear	Coupe 4WD N20B20B		Flexible Coupling	517955
	2013.11-2016.02		Front	Coupe 4WD N20B20B		Flexible Coupling Kit	517955S
	2013.11-2016.02		Rear	Coupe 4WD N20B20B		Flexible Coupling Kit	537625S
	2016.03-		Front	Coupe 4WD B48B20A		Flexible Coupling	510596
	2016.03-		Rear	Coupe 4WD B48B20A		Flexible Coupling	537625
	2016.03-		Rear	Coupe 4WD B48B20A		Flexible Coupling Kit	537625S
420i xDrive Gran Coupe							
2.0 (120 kw)	2014.03-2016.02		Front	Coupe 4WD N20B20B		Flexible Coupling	510596
	2014.03-2016.02		Rear	Coupe 4WD N20B20B		Flexible Coupling	537625
	2014.03-2016.02		Front;Rear	Coupe 4WD N20B20B		Flexible Coupling	517955
	2014.03-2016.02		Front	Coupe 4WD N20B20B		Flexible Coupling Kit	517955S
	2014.03-2016.02		Rear	Coupe 4WD N20B20B		Flexible Coupling Kit	537625S
	2016.03-		Front	Coupe 4WD B48B20A		Flexible Coupling	510596
	2016.03-		Rear	Coupe 4WD B48B20A		Flexible Coupling	537625
	2016.03-		Rear	Coupe 4WD B48B20A		Flexible Coupling Kit	537625S
2.0 (135 kw)	2014.07-2016.02		Front	Coupe 4WD N20B20B		Flexible Coupling	510596
	2014.07-2016.02		Rear	Coupe 4WD N20B20B		Flexible Coupling	537625
	2014.07-2016.02		Front;Rear	Coupe 4WD N20B20B		Flexible Coupling	517955
	2014.07-2016.02		Front	Coupe 4WD N20B20B		Flexible Coupling Kit	517955S
	2014.07-2016.02		Rear	Coupe 4WD N20B20B		Flexible Coupling Kit	537625S
	2016.03-		Front	Coupe 4WD B48B20A		Flexible Coupling	510596
	2016.03-		Rear	Coupe 4WD B48B20A		Flexible Coupling	537625
	2016.03-		Rear	Coupe 4WD B48B20A		Flexible Coupling Kit	537625S
425d Cabrio							
2.0 (155 kw)	2014.07-2016.02		Front;Rear	Cabriolet RWD N47D20D		Flexible Coupling	517955
	2014.07-2016.02		Front	Cabriolet RWD N47D20D		Flexible Coupling Kit	517955S
2.0 (160 kw)	2014.07-2016.02		Front;Rear	Cabriolet RWD N47D20D		Flexible Coupling	517955
	2014.07-2016.02		Front	Cabriolet RWD N47D20D		Flexible Coupling Kit	517955S



	 YEAR	TRANSM.	FITTING POSITION	BODY STYLE & DRIVE TYPE & ENGINE	REMARKS	 PRODUCT	GSP Ref.
BMW							
425d Cabrio							
2.0 (165 kw)	2016.03-2018.02		Front;Rear	Cabriolet RWD B47D20B		Flexible Coupling	517955
	2016.03-2018.02		Front	Cabriolet RWD B47D20B		Flexible Coupling Kit	517955S
425d Gran Coupe							
2.0 (155 kw)	2016.03-2018.02		Front;Rear	Coupe RWD B47D20B		Flexible Coupling	517955
	2016.03-2018.02		Front	Coupe RWD B47D20B		Flexible Coupling Kit	517955S
2.0 (165 kw)	2016.03-2018.02		Front;Rear	Coupe RWD B47D20B		Flexible Coupling	517955
	2016.03-2018.02		Front	Coupe RWD B47D20B		Flexible Coupling Kit	517955S
428i Cabrio							
2.0 (180 kw)	2013.11-2017.02		Front	Cabriolet RWD N20B20A/N26B20A		Flexible Coupling	510596
	2013.11-2017.02		Rear	Cabriolet RWD N20B20A/N26B20A		Flexible Coupling	537625
	2013.11-2017.02		Front	Cabriolet RWD N20B20A/N26B20A		Flexible Coupling Kit	510596S
	2013.11-2017.02		Rear	Cabriolet RWD N20B20A/N26B20A		Flexible Coupling Kit	537625S
428i Coupe							
2.0 (180 kw)	2013.07-2017.12		Front	Coupe RWD N20B20A/N26B20A		Flexible Coupling	510596
	2013.07-2017.12		Rear	Coupe RWD N20B20A/N26B20A		Flexible Coupling	537625
	2013.07-2017.12		Front	Coupe RWD N20B20A/N26B20A		Flexible Coupling Kit	510596S
	2013.07-2017.12		Rear	Coupe RWD N20B20A/N26B20A		Flexible Coupling Kit	537625S
428i Gran Coupe							
2.0 (180 kw)	2014.03-2016.02		Front	Coupe RWD N20B20A		Flexible Coupling	510596
	2014.03-2016.02		Rear	Coupe RWD N20B20A		Flexible Coupling	537625
	2014.03-2016.02		Front	Coupe RWD N20B20A		Flexible Coupling Kit	510596S
	2014.03-2016.02		Rear	Coupe RWD N20B20A		Flexible Coupling Kit	537625S
428i xDrive Cabrio							
2.0 (180 kw)	2014.03-2016.02		Front	Cabriolet 4WD N20B20A		Flexible Coupling	510596
	2014.03-2016.02		Rear	Cabriolet 4WD N20B20A		Flexible Coupling	537625
	2014.03-2016.02		Front;Rear	Cabriolet 4WD N20B20A		Flexible Coupling	517955
	2014.03-2016.02		Front	Cabriolet 4WD N20B20A		Flexible Coupling Kit	517955S
	2014.03-2016.02		Rear	Cabriolet 4WD N20B20A		Flexible Coupling Kit	537625S
428i xDrive Coupe							
2.0 (180 kw)	2013.07-2016.02		Front	Coupe 4WD N20B20A		Flexible Coupling	510596
	2013.07-2016.02		Rear	Coupe 4WD N20B20A		Flexible Coupling	537625
	2013.07-2016.02		Front;Rear	Coupe 4WD N20B20A		Flexible Coupling	517955
	2013.07-2016.02		Front	Coupe 4WD N20B20A		Flexible Coupling Kit	517955S
	2013.07-2016.02		Rear	Coupe 4WD N20B20A		Flexible Coupling Kit	537625S
428i xDrive Gran Coupe							
2.0 (180 kw)	2014.03-2016.02		Front	Coupe 4WD N20B20A		Flexible Coupling	510596
	2014.03-2016.02		Rear	Coupe 4WD N20B20A		Flexible Coupling	537625
	2014.03-2016.02		Front;Rear	Coupe 4WD N20B20A		Flexible Coupling	517955
	2014.03-2016.02		Front	Coupe 4WD N20B20A		Flexible Coupling Kit	517955S
	2014.03-2016.02		Rear	Coupe 4WD N20B20A		Flexible Coupling Kit	537625S
430d Cabrio							
3.0 (190 kw)	2014.07-		Front;Rear	Cabriolet RWD N57D30A		Flexible Coupling	517955
	2014.07-		Front	Cabriolet RWD N57D30A		Flexible Coupling Kit	517955S
3.0 (210 kw)	2014.07-		Front;Rear	Cabriolet RWD N57D30A		Flexible Coupling	517955
	2014.07-		Front	Cabriolet RWD N57D30A		Flexible Coupling Kit	517955S
430d Coupe							
3.0 (190 kw)	2013.11-		Front;Rear	Coupe RWD N57D30A		Flexible Coupling	517955
	2013.11-		Front	Coupe RWD N57D30A		Flexible Coupling Kit	517955S
3.0 (210 kw)	2013.11-		Front;Rear	Coupe RWD N57D30A		Flexible Coupling	517955
	2013.11-		Front	Coupe RWD N57D30A		Flexible Coupling Kit	517955S
430d Gran Coupe							
3.0 (190 kw)	2014.07-		Front;Rear	Coupe RWD N57D30A		Flexible Coupling	517955
	2014.07-		Front	Coupe RWD N57D30A		Flexible Coupling Kit	517955S
3.0 (210 kw)	2014.07-		Front;Rear	Coupe RWD N57D30A		Flexible Coupling	517955
	2014.07-		Front	Coupe RWD N57D30A		Flexible Coupling Kit	517955S
430d xDrive Coupe							
3.0 (190 kw)	2014.03-	AT/MT	Front	Coupe 4WD N57D30A		Propshaft	PS900112
	2014.03-		Front;Rear	Coupe 4WD N57D30A		Flexible Coupling	517955
	2014.03-		Front	Coupe 4WD N57D30A		Flexible Coupling Kit	517955S
	2014.03-	AT/MT	Front	Coupe 4WD N57D30A		Propshaft	PS900112
	2014.03-		Front;Rear	Coupe 4WD N57D30A		Flexible Coupling	517955
3.0 (210 kw)	2014.03-		Front	Coupe 4WD N57D30A		Flexible Coupling Kit	517955S
	2014.03-		Front	Coupe 4WD N57D30A		Flexible Coupling Kit	517955S



	 YEAR	TRANSM.	FITTING POSITION	BODY STYLE & DRIVE TYPE & ENGINE	REMARKS	 PRODUCT	GSP Ref.
BMW							
430d xDrive Gran Coupe							
3.0 (190 kw)	2014.07-	AT/MT	Front	Coupe 4WD N57D30A		Propshaft	PS900112
	2014.07-		Front;Rear	Coupe 4WD N57D30A		Flexible Coupling	517955
	2014.07-		Front	Coupe 4WD N57D30A		Flexible Coupling Kit	517955S
3.0 (210 kw)	2014.07-	AT/MT	Front	Coupe 4WD N57D30A		Propshaft	PS900112
	2014.07-		Front;Rear	Coupe 4WD N57D30A		Flexible Coupling	517955
	2014.07-		Front	Coupe 4WD N57D30A		Flexible Coupling Kit	517955S
430i Cabrio							
2.0 (185 kw)	2016.03-		Front	Cabriolet RWD B48B20B		Flexible Coupling	510596
	2016.03-		Rear	Cabriolet RWD B48B20B		Flexible Coupling	537625
	2016.03-		Front	Cabriolet RWD B48B20B		Flexible Coupling Kit	510596S
	2016.03-		Rear	Cabriolet RWD B48B20B		Flexible Coupling Kit	537625S
430i Coupe							
2.0 (185 kw)	2016.03-		Front	Coupe RWD B46B20B/B48B20B		Flexible Coupling	510596
	2016.03-		Rear	Coupe RWD B46B20B/B48B20B		Flexible Coupling	537625
	2016.03-		Front	Coupe RWD B46B20B/B48B20B		Flexible Coupling Kit	510596S
	2016.03-		Rear	Coupe RWD B46B20B/B48B20B		Flexible Coupling Kit	537625S
430i Gran Coupe							
2.0 (185 kw)	2016.03-		Front	Coupe RWD B48B20B		Flexible Coupling	510596
	2016.03-		Rear	Coupe RWD B48B20B		Flexible Coupling	537625
	2016.03-		Front	Coupe RWD B48B20B		Flexible Coupling Kit	510596S
	2016.03-		Rear	Coupe RWD B48B20B		Flexible Coupling Kit	537625S
430i xDrive Cabrio							
2.0 (185 kw)	2016.03-		Front	Cabriolet 4WD B48B20B		Flexible Coupling	510596
	2016.03-		Rear	Cabriolet 4WD B48B20B		Flexible Coupling	537625
	2016.03-		Front;Rear	Cabriolet 4WD B48B20B		Flexible Coupling	517955
	2016.03-		Front	Cabriolet 4WD B48B20B		Flexible Coupling Kit	517955S
	2016.03-		Rear	Cabriolet 4WD B48B20B		Flexible Coupling Kit	537625S
430i xDrive Coupe							
2.0 (185 kw)	2016.03-		Front	Coupe 4WD B48B20B		Flexible Coupling	510596
	2016.03-		Rear	Coupe 4WD B48B20B		Flexible Coupling	537625
	2016.03-		Front;Rear	Coupe 4WD B48B20B		Flexible Coupling	517955
	2016.03-		Front	Coupe 4WD B48B20B		Flexible Coupling Kit	517955S
	2016.03-		Rear	Coupe 4WD B48B20B		Flexible Coupling Kit	537625S
430i xDrive Gran Coupe							
2.0 (185 kw)	2016.03-		Front	Coupe 4WD B48B20B		Flexible Coupling	510596
	2016.03-		Rear	Coupe 4WD B48B20B		Flexible Coupling	537625
	2016.03-		Front;Rear	Coupe 4WD B48B20B		Flexible Coupling	517955
	2016.03-		Rear	Coupe 4WD B48B20B		Flexible Coupling Kit	537625S
435d xDrive Cabrio							
3.0 (230 kw)	2014.07-	AT/MT	Front	Cabriolet 4WD N57D30B		Propshaft	PS900112
	2014.07-		Front;Rear	Cabriolet 4WD N57D30B		Flexible Coupling	517955
	2014.07-		Front	Cabriolet 4WD N57D30B		Flexible Coupling Kit	517955S
435d xDrive Coupe							
3.0 (230 kw)	2013.11-	AT/MT	Front	Coupe 4WD N57D30B		Propshaft	PS900112
	2013.11-		Front;Rear	Coupe 4WD N57D30B		Flexible Coupling	517955
	2013.11-		Front	Coupe 4WD N57D30B		Flexible Coupling Kit	517955S
435d xDrive Gran Coupe							
3.0 (230 kw)	2014.07-	AT/MT	Front	Coupe 4WD N57D30B		Propshaft	PS900112
	2014.07-		Front;Rear	Coupe 4WD N57D30B		Flexible Coupling	517955
	2014.07-		Front	Coupe 4WD N57D30B		Flexible Coupling Kit	517955S
435i Cabrio							
3.0 (225 kw)	2013.11-2016.02		Front;Rear	Cabriolet RWD N55B30A		Flexible Coupling	517955
	2013.11-2016.02		Front	Cabriolet RWD N55B30A		Flexible Coupling Kit	517955S
3.0 (250 kw)	2013.11-2016.02		Front;Rear	Cabriolet RWD N55B30A		Flexible Coupling	517955
	2013.11-2016.02		Front	Cabriolet RWD N55B30A		Flexible Coupling Kit	517955S
435i Coupe							
3.0 (225 kw)	2013.07-2016.02		Front;Rear	Coupe RWD N55B30A		Flexible Coupling	517955
	2013.07-2016.02		Front	Coupe RWD N55B30A		Flexible Coupling Kit	517955S
3.0 (250 kw)	2013.07-2016.02		Front;Rear	Coupe RWD N55B30A		Flexible Coupling	517955
	2013.07-2016.02		Front	Coupe RWD N55B30A		Flexible Coupling Kit	517955S
435i Gran Coupe							
3.0 (225 kw)	2014.03-2016.02		Front;Rear	Coupe RWD N55B30A		Flexible Coupling	517955
	2014.03-2016.02		Front	Coupe RWD N55B30A		Flexible Coupling Kit	517955S



	 YEAR	TRANSM.	FITTING POSITION	BODY STYLE & DRIVE TYPE & ENGINE	REMARKS	 PRODUCT	GSP Ref.
BMW							
435i Gran Coupe							
3.0 (250 kw)	2014.03-2016.02		Front;Rear	Coupe RWD N55B30A		Flexible Coupling	517955
	2014.03-2016.02		Front	Coupe RWD N55B30A		Flexible Coupling Kit	517955S
435i xDrive Cabrio							
3.0 (225 kw)	2014.07-2016.02		Front;Rear	Cabriolet 4WD N55B30A		Flexible Coupling	517955
	2014.07-2016.02		Front	Cabriolet 4WD N55B30A		Flexible Coupling Kit	517955S
3.0 (250 kw)	2014.07-2016.02		Front;Rear	Cabriolet 4WD N55B30A		Flexible Coupling	517955
	2014.07-2016.02		Front	Cabriolet 4WD N55B30A		Flexible Coupling Kit	517955S
435i xDrive Coupe							
3.0 (225 kw)	2013.07-2016.02		Front;Rear	Coupe 4WD N55B30A		Flexible Coupling	517955
	2013.07-2016.02		Front	Coupe 4WD N55B30A		Flexible Coupling Kit	517955S
3.0 (250 kw)	2013.07-2016.02		Front;Rear	Coupe 4WD N55B30A		Flexible Coupling	517955
	2013.07-2016.02		Front	Coupe 4WD N55B30A		Flexible Coupling Kit	517955S
435i xDrive Gran Coupe							
3.0 (225 kw)	2014.07-2016.02		Front;Rear	Coupe 4WD N55B30A		Flexible Coupling	517955
	2014.07-2016.02		Front	Coupe 4WD N55B30A		Flexible Coupling Kit	517955S
3.0 (250 kw)	2014.07-2016.02		Front;Rear	Coupe 4WD N55B30A		Flexible Coupling	517955
	2014.07-2016.02		Front	Coupe 4WD N55B30A		Flexible Coupling Kit	517955S
440i Cabrio							
3.0 (240 kw)	2016.03-		Front;Rear	Cabriolet RWD B58B30A		Flexible Coupling	517955
	2016.03-		Front	Cabriolet RWD B58B30A		Flexible Coupling Kit	517955S
3.0 (265 kw)	2016.03-		Front;Rear	Cabriolet RWD B58B30A		Flexible Coupling	517955
	2016.03-		Front	Cabriolet RWD B58B30A		Flexible Coupling Kit	517955S
440i Coupe							
3.0 (240 kw)	2016.03-		Front;Rear	Coupe RWD B58B30A		Flexible Coupling	517955
	2016.03-		Front	Coupe RWD B58B30A		Flexible Coupling Kit	517955S
3.0 (265 kw)	2016.03-		Front;Rear	Coupe RWD B58B30A		Flexible Coupling	517955
	2016.03-		Front	Coupe RWD B58B30A		Flexible Coupling Kit	517955S
440i Gran Coupe							
3.0 (240 kw)	2016.03-		Front	Coupe RWD B58B30A		Flexible Coupling Kit	517955S
3.0 (265 kw)	2016.03-		Front	Coupe RWD B58B30A		Flexible Coupling Kit	517955S
440i xDrive Cabrio							
3.0 (240 kw)	2016.03-		Front;Rear	Cabriolet 4WD B58B30A		Flexible Coupling	517955
	2016.03-		Front	Cabriolet 4WD B58B30A		Flexible Coupling Kit	517955S
3.0 (265 kw)	2016.03-		Front;Rear	Cabriolet 4WD B58B30A		Flexible Coupling	517955
	2016.03-		Front	Cabriolet 4WD B58B30A		Flexible Coupling Kit	517955S
440i xDrive Coupe							
3.0 (240 kw)	2016.03-		Front;Rear	Coupe 4WD B58B30A		Flexible Coupling	517955
	2016.03-		Front	Coupe 4WD B58B30A		Flexible Coupling Kit	517955S
3.0 (265 kw)	2016.03-		Front;Rear	Coupe 4WD B58B30A		Flexible Coupling	517955
	2016.03-		Front	Coupe 4WD B58B30A		Flexible Coupling Kit	517955S
440i xDrive Gran Coupe							
3.0 (240 kw)	2016.03-		Front	Coupe 4WD B58B30A		Flexible Coupling Kit	517955S
3.0 (265 kw)	2016.03-		Front	Coupe 4WD B58B30A		Flexible Coupling Kit	517955S
5 ActiveHybrid							
3.0 (225 kw)	2011.12-2016.10		Front;Rear	Saloon RWD N55B30A		Flexible Coupling	517955
	2011.12-2016.10		Front	Saloon RWD N55B30A		Flexible Coupling Kit	517955S
518d							
2.0 (100 kw)	2013.07-2014.06	AT	Rear	Saloon RWD N47D20C	Date From:2014.01	Propshaft	PS900135
	2013.07-2014.06		Front;Rear	Saloon RWD N47D20C		Flexible Coupling	517955
	2013.07-2014.06		Front	Saloon RWD N47D20C		Flexible Coupling Kit	517955S
	2018.07-2020.06		Rear	Saloon RWD B47D20B		Flexible Coupling	537625
	2018.07-2020.06		Front;Rear	Saloon RWD B47D20B		Flexible Coupling	517955
2.0 (105 kw)	2013.07-2014.06	AT	Rear	Saloon RWD N47D20C	Date From:2014.01	Propshaft	PS900135
	2013.07-2014.06		Front;Rear	Saloon RWD N47D20C		Flexible Coupling	517955
	2013.07-2014.06		Front	Saloon RWD N47D20C		Flexible Coupling Kit	517955S
2.0 (110 kw)	2014.07-2016.10	AT	Rear	Saloon RWD B47D20A	Date From:2015.01	Propshaft	PS900135
	2014.07-2016.10		Front;Rear	Saloon RWD B47D20A		Flexible Coupling	517955
	2014.07-2016.10		Front	Saloon RWD B47D20A		Flexible Coupling Kit	517955S
	2018.07-2020.06		Rear	Saloon RWD B47D20B		Flexible Coupling	537625
	2018.07-2020.06		Front;Rear	Saloon RWD B47D20B		Flexible Coupling	517955
2.0 (120 kw)	2013.10-2016.10	AT	Rear	Saloon RWD B47D20A	Date From:2014.01	Propshaft	PS900135
	2013.10-2016.10		Front;Rear	Saloon RWD B47D20A		Flexible Coupling	517955
	2013.10-2016.10		Front	Saloon RWD B47D20A		Flexible Coupling Kit	517955S

	 YEAR	TRANSM.	FITTING POSITION	BODY STYLE & DRIVE TYPE & ENGINE	REMARKS	 PRODUCT	GSP Ref.
BMW							
518d Touring							
2.0 (100 kw)	2013.07-2014.06	AT	Rear	Estate RWD N47D20C	Date From:2014.01	Propshaft	PS900135
	2013.07-2014.06		Front;Rear	Estate RWD N47D20C		Flexible Coupling	517955
	2013.07-2014.06		Front	Estate RWD N47D20C		Flexible Coupling Kit	517955S
	2018.07-2020.06		Front;Rear	Estate RWD B47D20B		Flexible Coupling	517955
	2018.07-2020.06		Front	Estate RWD B47D20B		Flexible Coupling Kit	517955S
2.0 (105 kw)	2013.07-2014.06	AT	Rear	Estate RWD N47D20C		Propshaft	PS900135
	2013.07-2014.06		Front;Rear	Estate RWD N47D20C		Flexible Coupling	517955
	2013.07-2014.06		Front	Estate RWD N47D20C		Flexible Coupling Kit	517955S
2.0 (110 kw)	2014.07-2017.02	AT	Rear	Estate RWD B47D20A	Date From:2015.01	Propshaft	PS900135
	2014.07-2017.02		Front;Rear	Estate RWD B47D20A		Flexible Coupling	517955
	2014.07-2017.02		Front	Estate RWD B47D20A		Flexible Coupling Kit	517955S
	2018.07-2020.06		Front;Rear	Estate RWD B47D20B		Flexible Coupling	517955
	2018.07-2020.06		Front	Estate RWD B47D20B		Flexible Coupling Kit	517955S
2.0 (120 kw)	2014.07-2017.02	AT	Rear	Estate RWD B47D20A	Date From:2015.01	Propshaft	PS900135
	2014.07-2017.02		Front;Rear	Estate RWD B47D20A		Flexible Coupling	517955
	2014.07-2017.02		Front	Estate RWD B47D20A		Flexible Coupling Kit	517955S
518i							
1.8 (83 kw)	1989.09-1994.04		Centre	Saloon RWD M40B184E1		Center Bearing Support	510599
	1989.09-1994.04		Centre	Saloon RWD M40B184E1		Center Bearing Support	510659
	1989.09-1994.04		Front	Saloon RWD M40B184E1		Flexible Coupling	510597
	1989.09-1994.04		Front	Saloon RWD M40B184E1		Flexible Coupling	510641
	1989.09-1994.04		Front	Saloon RWD M40B184E1		Flexible Coupling Kit	510597S
1.8 (85 kw)	1994.05-1995.08		Centre	Saloon RWD M43B184E2		Center Bearing Support	510659
	1994.05-1995.08		Front	Saloon RWD M43B184E2		Flexible Coupling	510597
518i Touring							
1.8 (83 kw)	1993.04-1994.04		Centre	Estate RWD M40B184E1		Center Bearing Support	510599
	1993.04-1994.04		Centre	Estate RWD M40B184E1		Center Bearing Support	510659
	1993.04-1994.04		Front	Estate RWD M40B184E1		Flexible Coupling	510597
1.8 (85 kw)	1994.05-1996.07		Centre	Estate RWD M43B184E2		Center Bearing Support	510659
	1994.05-1996.07		Front	Estate RWD M43B184E2		Flexible Coupling	510597
	1994.05-1996.07		Front	Estate RWD M43B184E2		Flexible Coupling Kit	510597S
520d							
2.0 (100 kw)	1999.09-2003.05	MT	Rear	Saloon RWD M47D204D1		Joint,propshaft	605057
	1999.09-2003.05		Centre	Saloon RWD M47D204D1		Center Bearing Support	517185
	1999.09-2003.05		Front	Saloon RWD M47D204D1		Flexible Coupling	530160
	2013.01-2014.07	AT	Rear	Saloon RWD N47D20C		Propshaft	PS900135
	2013.01-2014.07		Front;Rear	Saloon RWD N47D20C		Flexible Coupling	517955
	2013.01-2014.07		Front	Saloon RWD N47D20C		Flexible Coupling Kit	517955S
2.0 (110 kw)	2005.09-2007.02		Centre	Saloon RWD M47D204D4		Center Bearing Support	531026
	2005.09-2007.02		Front	Saloon RWD M47D204D4		Flexible Coupling	533422
	2005.09-2007.02		Front	Saloon RWD M47D204D4		Flexible Coupling Kit	533422S
2.0 (120 kw)	2005.09-2009.12		Centre	Saloon RWD M47D204D4/N47D20C		Center Bearing Support	531026
	2005.09-2009.12		Front	Saloon RWD M47D204D4/N47D20C		Flexible Coupling	533422
	2005.09-2009.12		Front	Saloon RWD M47D204D4/N47D20C		Flexible Coupling Kit	533422S
	2010.06-2016.10	AT	Rear	Saloon RWD B47D20A/N47D20C	Date From:2011.01	Propshaft	PS900135
	2010.06-2016.10		Front;Rear	Saloon RWD B47D20A/N47D20C		Flexible Coupling	517955
	2010.06-2016.10		Front	Saloon RWD B47D20A/N47D20C		Flexible Coupling Kit	517955S
	2016.09-		Rear	Saloon RWD B47D20A/B47D20B		Flexible Coupling	537625
2016.09-		Front;Rear	Saloon RWD B47D20A/B47D20B		Flexible Coupling	517955	
2.0 (130 kw)	2007.09-2009.12		Centre	Saloon RWD N47D20A/N47D20C		Center Bearing Support	531026
	2007.09-2009.12		Front	Saloon RWD N47D20A/N47D20C		Flexible Coupling	533422
2.0 (135 kw)	2010.06-2014.06	AT	Rear	Saloon RWD N47D20C		Propshaft	PS900135
	2010.06-2014.06		Front;Rear	Saloon RWD N47D20C		Flexible Coupling	517955
	2010.06-2014.06		Front	Saloon RWD N47D20C		Flexible Coupling Kit	517955S
2.0 (140 kw)	2014.07-2016.10	AT	Rear	Saloon RWD B47D20A	Date From:2015.01	Propshaft	PS900135
	2014.07-2016.10		Front;Rear	Saloon RWD B47D20A		Flexible Coupling	517955
	2014.07-2016.10		Front	Saloon RWD B47D20A		Flexible Coupling Kit	517955S
	2016.09-		Rear	Saloon RWD B47D20A		Flexible Coupling	537625
	2016.09-		Front;Rear	Saloon RWD B47D20A		Flexible Coupling	517955
2.0 (147 kw)	2010.06-2014.06	AT	Rear	Saloon RWD N47D20C	Date From:2011.01	Propshaft	PS900135
	2010.06-2014.06		Front;Rear	Saloon RWD N47D20C		Flexible Coupling	517955
	2010.06-2014.06		Front	Saloon RWD N47D20C		Flexible Coupling Kit	517955S
2.0 (151 kw)	2014.07-2016.10	AT	Rear	Saloon RWD B47D20A	Date From:2015.01	Propshaft	PS900135
	2014.07-2016.10		Front;Rear	Saloon RWD B47D20A		Flexible Coupling	517955



	 YEAR	TRANSM.	FITTING POSITION	BODY STYLE & DRIVE TYPE & ENGINE	REMARKS	 PRODUCT	GSP Ref.
BMW 520d							
2.0 (151 kw)	2014.07-2016.10		Front	Saloon RWD B47D20A		Flexible Coupling Kit	517955S
2.0 (155 kw)	2013.10-2016.10	AT	Rear	Saloon RWD B47D20A		Propshaft	PS900135
	2013.10-2016.10		Front;Rear	Saloon RWD B47D20A		Flexible Coupling	517955
	2013.10-2016.10		Front	Saloon RWD B47D20A		Flexible Coupling Kit	517955S
520d Gran Turismo							
2.0 (100 kw)	2013.07-2017.02		Front;Rear	Hatchback RWD N47D20C		Flexible Coupling	517955
	2013.07-2017.02		Front	Hatchback RWD N47D20C		Flexible Coupling Kit	517955S
2.0 (120 kw)	2012.07-2013.06		Front;Rear	Hatchback RWD N47D20C		Flexible Coupling	517955
	2012.07-2013.06		Front	Hatchback RWD N47D20C		Flexible Coupling Kit	517955S
2.0 (135 kw)	2012.07-2017.02		Front;Rear	Hatchback RWD N47D20C		Flexible Coupling	517955
	2012.07-2017.02		Front	Hatchback RWD N47D20C		Flexible Coupling Kit	517955S
520d Touring							
2.0 (100 kw)	1999.09-2004.05	MT	Rear	Estate RWD M47D204D1		Joint,propshaft	605057
	1999.09-2004.05		Centre	Estate RWD M47D204D1		Center Bearing Support	517185
	1999.09-2004.05		Front	Estate RWD M47D204D1		Flexible Coupling	530160
	2010.06-2014.06	AT	Rear	Estate RWD N47D20C	Date From:2011.01	Propshaft	PS900135
	2010.06-2014.06		Front;Rear	Estate RWD N47D20C		Flexible Coupling	517955
	2010.06-2014.06		Front	Estate RWD N47D20C		Flexible Coupling Kit	517955S
2.0 (110 kw)	2005.09-2007.02		Centre	Estate RWD M47D204D4		Center Bearing Support	531026
2.0 (120 kw)	2005.09-2010.05		Centre	Estate RWD M47D204D4/N47D20C		Center Bearing Support	531026
	2005.09-2010.05		Front	Estate RWD M47D204D4/N47D20C		Flexible Coupling	533422
	2005.09-2010.05		Front	Estate RWD M47D204D4/N47D20C		Flexible Coupling Kit	533422S
	2010.06-2017.02	AT	Rear	Estate RWD B47D20A/N47D20C	Date From:2011.01	Propshaft	PS900135
	2010.06-2017.02		Front;Rear	Estate RWD B47D20A/N47D20C		Flexible Coupling	517955
	2010.06-2017.02		Front	Estate RWD B47D20A/N47D20C		Flexible Coupling Kit	517955S
	2017.03-		Rear	Estate RWD B47D20A/B47D20B		Flexible Coupling	537625
	2017.03-		Front;Rear	Estate RWD B47D20A/B47D20B		Flexible Coupling	517955
2.0 (130 kw)	2007.09-2010.05		Centre	Estate RWD N47D20A/N47D20C		Center Bearing Support	531026
	2007.09-2010.05		Front;Rear	Estate RWD N47D20A/N47D20C		Flexible Coupling	517955
	2007.09-2010.05		Front	Estate RWD N47D20A/N47D20C		Flexible Coupling Kit	517955S
	2010.06-2014.06	AT	Rear	Estate RWD N47D20C		Propshaft	PS900135
2.0 (135 kw)	2010.06-2014.06		Front;Rear	Estate RWD N47D20C		Flexible Coupling	517955
	2010.06-2014.06		Front	Estate RWD N47D20C		Flexible Coupling Kit	517955S
	2010.06-2014.06		Front	Estate RWD N47D20C		Flexible Coupling Kit	517955S
2.0 (140 kw)	2014.07-2017.02	AT	Rear	Estate RWD B47D20A	Date From:2015.01	Propshaft	PS900135
	2014.07-2017.02		Front;Rear	Estate RWD B47D20A		Flexible Coupling	517955
	2014.07-2017.02		Front	Estate RWD B47D20A		Flexible Coupling Kit	517955S
	2017.03-		Rear	Estate RWD B47D20A/B47D20B		Flexible Coupling	537625
	2017.03-		Front;Rear	Estate RWD B47D20A/B47D20B		Flexible Coupling	517955
	2017.03-		Rear	Estate RWD B47D20A/B47D20B		Flexible Coupling Kit	537625S
2.0 (147 kw)	2010.06-2014.06	AT	Rear	Estate RWD N47D20C	Date From:2011.01	Propshaft	PS900135
	2010.06-2014.06		Front;Rear	Estate RWD N47D20C		Flexible Coupling	517955
	2010.06-2014.06		Front	Estate RWD N47D20C		Flexible Coupling Kit	517955S
2.0 (151 kw)	2014.07-2017.02	AT	Rear	Estate RWD B47D20A	Date From:2015.01	Propshaft	PS900135
	2014.07-2017.02		Front;Rear	Estate RWD B47D20A		Flexible Coupling	517955
	2014.07-2017.02		Front	Estate RWD B47D20A		Flexible Coupling Kit	517955S
2.0 (155 kw)	2014.07-2017.02	AT	Rear	Estate RWD B47D20A	Date From:2015.01	Propshaft	PS900135
	2014.07-2017.02		Front;Rear	Estate RWD B47D20A		Flexible Coupling	517955
	2014.07-2017.02		Front	Estate RWD B47D20A		Flexible Coupling Kit	517955S
520d xDrive							
2.0 (100 kw)	2013.01-2014.06		Front;Rear	Saloon 4WD N47D20C		Flexible Coupling	517955
2.0 (120 kw)	2013.10-2016.10		Front;Rear	Saloon 4WD B47D20A		Flexible Coupling	517955
	2016.09-		Rear	Saloon 4WD B47D20A/B47D20B		Flexible Coupling	537625
2.0 (135 kw)	2013.07-2014.06		Centre	Saloon 4WD N47D20C		Center Bearing Support	531013
	2013.07-2014.06		Front	Saloon 4WD N47D20C		Flexible Coupling	537631
	2013.07-2014.06		Front;Rear	Saloon 4WD N47D20C		Flexible Coupling	517955
2.0 (140 kw)	2014.07-2016.10		Front;Rear	Saloon 4WD B47D20A		Flexible Coupling	517955
	2016.09-		Rear	Saloon 4WD B47D20A/B47D20B		Flexible Coupling	537625
2.0 (147 kw)	2013.01-2014.06		Front;Rear	Saloon 4WD N47D20C		Flexible Coupling	517955
2.0 (151 kw)	2014.07-2016.10		Front;Rear	Saloon 4WD B47D20A		Flexible Coupling	517955
2.0 (155 kw)	2013.10-2016.10		Front;Rear	Saloon 4WD B47D20A		Flexible Coupling	517955
520d xDrive Touring							
2.0 (100 kw)	2013.07-2014.06		Front;Rear	Estate 4WD N47D20C		Flexible Coupling	517955



	 YEAR	TRANSM.	FITTING POSITION	BODY STYLE & DRIVE TYPE & ENGINE	REMARKS	 PRODUCT	GSP Ref.
BMW							
520d xDrive Touring							
2.0 (120 kw)	2014.07-2017.02		Front;Rear	Estate 4WD B47D20A		Flexible Coupling	517955
	2014.07-2017.02		Front	Estate 4WD B47D20A		Flexible Coupling Kit	517955S
	2017.07-		Rear	Estate 4WD B47D20A/B47D20B		Flexible Coupling	537625
	2017.07-		Rear	Estate 4WD B47D20A/B47D20B		Flexible Coupling Kit	537625S
2.0 (135 kw)	2013.07-2014.06		Centre	Estate 4WD N47D20C		Center Bearing Support	531013
	2013.07-2014.06		Front	Estate 4WD N47D20C		Flexible Coupling	537631
	2013.07-2014.06		Front;Rear	Estate 4WD N47D20C		Flexible Coupling	517955
2.0 (140 kw)	2014.07-2017.02		Front;Rear	Estate 4WD B47D20A		Flexible Coupling	517955
	2014.07-2017.02		Front	Estate 4WD B47D20A		Flexible Coupling Kit	517955S
	2017.07-		Rear	Estate 4WD B47D20A/B47D20B		Flexible Coupling	537625
	2017.07-		Rear	Estate 4WD B47D20A/B47D20B		Flexible Coupling Kit	537625S
2.0 (147 kw)	2013.07-2014.06		Front;Rear	Estate 4WD N47D20C		Flexible Coupling	517955
2.0 (151 kw)	2014.07-2017.02		Front;Rear	Estate 4WD B47D20A		Flexible Coupling	517955
	2014.07-2017.02		Front	Estate 4WD B47D20A		Flexible Coupling Kit	517955S
2.0 (155 kw)	2014.07-2017.02		Front;Rear	Estate 4WD B47D20A		Flexible Coupling	517955
	2014.07-2017.02		Front	Estate 4WD B47D20A		Flexible Coupling Kit	517955S
520i							
1.6 (125 kw)	2013.07-2016.10		Front	Saloon RWD N20B16A		Flexible Coupling	510596
	2013.07-2016.10		Rear	Saloon RWD N20B16A		Flexible Coupling	537625
	2013.07-2016.10		Front	Saloon RWD N20B16A		Flexible Coupling Kit	510596S
	2013.07-2016.10		Rear	Saloon RWD N20B16A		Flexible Coupling Kit	537625S
	2017.07-		Rear	Saloon RWD B48B16A		Flexible Coupling	537625
2.0 (100 kw)	1996.01-2003.06		Centre	Saloon RWD M52B206S3/M52B206S4		Center Bearing Support	510659
2.0 (110 kw)	1990.04-1995.08		Centre	Saloon RWD M50B206S1/M50B206S2		Center Bearing Support	510599
	1990.04-1995.08		Front	Saloon RWD M50B206S1/M50B206S2		Flexible Coupling	510597
	1990.04-1995.08		Front	Saloon RWD M50B206S1/M50B206S2		Flexible Coupling	510641
	1990.04-1995.08		Front	Saloon RWD M50B206S1/M50B206S2		Flexible Coupling Kit	510597S
	1996.01-2003.06		Centre	Saloon RWD M52B206S3/M52B206S4		Center Bearing Support	510659
	1996.01-2003.06		Centre	Saloon RWD M52B206S3/M52B206S4		Center Bearing Support	517185
	1996.01-2003.06		Front	Saloon RWD M52B206S3/M52B206S4		Flexible Coupling	510596
	1996.01-2003.06		Front	Saloon RWD M52B206S3/M52B206S4		Flexible Coupling	510597
	1996.01-2003.06		Front	Saloon RWD M52B206S3/M52B206S4		Flexible Coupling Kit	510597S
	2.0 (115 kw)	2007.09-2010.02		Centre	Saloon RWD N46B20B		Center Bearing Support
2007.09-2010.02			Front	Saloon RWD N46B20B		Flexible Coupling	510641
2007.09-2010.02			Front	Saloon RWD N46B20B		Flexible Coupling	533422
2007.09-2010.02			Front	Saloon RWD N46B20B		Flexible Coupling Kit	510641S
2007.09-2010.02			Front	Saloon RWD N46B20B		Flexible Coupling Kit	533422S
2.0 (120 kw)	2011.09-2016.10		Centre	Saloon RWD N20B20A/N20B20B		Center Bearing Support	531014
	2011.09-2016.10		Front	Saloon RWD N20B20A/N20B20B		Flexible Coupling	510596
	2011.09-2016.10		Rear	Saloon RWD N20B20A/N20B20B		Flexible Coupling	537625
	2011.09-2016.10		Front	Saloon RWD N20B20A/N20B20B		Flexible Coupling Kit	510596S
	2011.09-2016.10		Rear	Saloon RWD N20B20A/N20B20B		Flexible Coupling Kit	537625S
	2017.07-2020.06		Rear	Saloon RWD B48B20A/B48B20B		Flexible Coupling	537625
2.0 (125 kw)	2007.09-2009.12		Centre	Saloon RWD N43B20A		Center Bearing Support	531026
	2007.09-2009.12		Front	Saloon RWD N43B20A		Flexible Coupling	510641
	2007.09-2009.12		Front	Saloon RWD N43B20A		Flexible Coupling	533422
	2007.09-2009.12		Front	Saloon RWD N43B20A		Flexible Coupling Kit	510641S
	2007.09-2009.12		Front	Saloon RWD N43B20A		Flexible Coupling Kit	533422S
2.0 (135 kw)	2011.09-2016.10		Centre	Saloon RWD N20B20A/N20B20B		Center Bearing Support	531014
	2011.09-2016.10		Front	Saloon RWD N20B20A/N20B20B		Flexible Coupling	510596
	2011.09-2016.10		Front	Saloon RWD N20B20A/N20B20B		Flexible Coupling	533422
	2011.09-2016.10		Rear	Saloon RWD N20B20A/N20B20B		Flexible Coupling	537625
	2011.09-2016.10		Front	Saloon RWD N20B20A/N20B20B		Flexible Coupling Kit	510596S
	2011.09-2016.10		Front	Saloon RWD N20B20A/N20B20B		Flexible Coupling Kit	533422S
	2011.09-2016.10		Rear	Saloon RWD N20B20A/N20B20B		Flexible Coupling Kit	537625S
2017.07-2020.06		Rear	Saloon RWD B48B20A/B48B20B		Flexible Coupling	537625	
2.0 (155 kw)	2017.07-2020.06		Rear	Saloon RWD B48B20A/B48B20B		Flexible Coupling	537625
2.2 (125 kw)	2000.09-2003.06		Centre	Saloon RWD M54B226S1		Center Bearing Support	510659
	2000.09-2003.06		Front	Saloon RWD M54B226S1		Flexible Coupling	510596
	2000.09-2003.06		Front	Saloon RWD M54B226S1		Flexible Coupling	510597
	2000.09-2003.06		Front	Saloon RWD M54B226S1		Flexible Coupling Kit	510597S
	2003.06-2005.05	AT	Rear	Saloon RWD M54B226S1		Propshaft	PS900127
	2003.06-2005.05		Centre	Saloon RWD M54B226S1		Center Bearing Support	513771
	2003.06-2005.05		Front	Saloon RWD M54B226S1		Flexible Coupling	533422

	 YEAR	TRANSM.	FITTING POSITION	BODY STYLE & DRIVE TYPE & ENGINE	REMARKS	 PRODUCT	GSP Ref.
BMW 520i							
2.2 (125 kw)	2003.06-2005.05		Front	Saloon RWD M54B226S1		Flexible Coupling Kit	533422S
520i Touring							
2.0 (100 kw)	1997.03-2001.08		Centre	Estate RWD M52B206S3/M52B206S4		Center Bearing Support	510659
2.0 (110 kw)	1991.07-1996.07		Centre	Estate RWD M50B206S1/M50B206S2		Center Bearing Support	510599
	1991.07-1996.07		Front	Estate RWD M50B206S1/M50B206S2		Flexible Coupling	510597
	1991.07-1996.07		Front	Estate RWD M50B206S1/M50B206S2		Flexible Coupling	510641
	1991.07-1996.07		Front	Estate RWD M50B206S1/M50B206S2		Flexible Coupling Kit	510597S
	1997.03-2001.08		Centre	Estate RWD M52B206S3/M52B206S4		Center Bearing Support	510659
	1997.03-2001.08		Centre	Estate RWD M52B206S3/M52B206S4		Center Bearing Support	517185
	1997.03-2001.08		Front	Estate RWD M52B206S3/M52B206S4		Flexible Coupling	510596
	1997.03-2001.08		Front	Estate RWD M52B206S3/M52B206S4		Flexible Coupling	510597
	1997.03-2001.08		Front	Estate RWD M52B206S3/M52B206S4		Flexible Coupling Kit	510597S
2.0 (120 kw)	2007.09-2010.08		Front	Estate RWD N43B20A		Flexible Coupling	510641
	2011.09-2017.02		Centre	Estate RWD N20B20A/N20B20B		Center Bearing Support	531014
	2011.09-2017.02		Front	Estate RWD N20B20A/N20B20B		Flexible Coupling	510596
	2011.09-2017.02		Rear	Estate RWD N20B20A/N20B20B		Flexible Coupling	537625
	2011.09-2017.02		Front	Estate RWD N20B20A/N20B20B		Flexible Coupling Kit	510596S
	2011.09-2017.02		Rear	Estate RWD N20B20A/N20B20B		Flexible Coupling Kit	537625S
	2017.07-2020.06		Rear	Estate RWD B48B20A		Flexible Coupling	537625
	2017.07-2020.06		Rear	Estate RWD B48B20A		Flexible Coupling Kit	537625S
2.0 (125 kw)	2007.08-2010.05		Centre	Estate RWD N43B20A		Center Bearing Support	531026
	2007.08-2010.05		Front	Estate RWD N43B20A		Flexible Coupling	510641
	2007.08-2010.05		Front	Estate RWD N43B20A		Flexible Coupling	533422
	2007.08-2010.05		Front	Estate RWD N43B20A		Flexible Coupling Kit	510641S
	2007.08-2010.05		Front	Estate RWD N43B20A		Flexible Coupling Kit	533422S
2.0 (135 kw)	2011.09-2017.02		Centre	Estate RWD N20B20A/N20B20B		Center Bearing Support	531014
	2011.09-2017.02		Front	Estate RWD N20B20A/N20B20B		Flexible Coupling	510596
	2011.09-2017.02		Front	Estate RWD N20B20A/N20B20B		Flexible Coupling	533422
	2011.09-2017.02		Rear	Estate RWD N20B20A/N20B20B		Flexible Coupling	537625
	2011.09-2017.02		Front	Estate RWD N20B20A/N20B20B		Flexible Coupling Kit	510596S
	2011.09-2017.02		Front	Estate RWD N20B20A/N20B20B		Flexible Coupling Kit	533422S
	2011.09-2017.02		Rear	Estate RWD N20B20A/N20B20B		Flexible Coupling Kit	537625S
	2017.07-2020.06		Rear	Estate RWD B48B20A		Flexible Coupling	537625
2017.07-2020.06		Rear	Estate RWD B48B20A		Flexible Coupling Kit	537625S	
2.0 (155 kw)	2017.07-2020.06		Rear	Estate RWD B48B20A		Flexible Coupling	537625
2.2 (125 kw)	2000.09-2003.12		Centre	Estate RWD M54B226S1		Center Bearing Support	510659
	2000.09-2003.12		Front	Estate RWD M54B226S1		Flexible Coupling	510596
	2000.09-2003.12		Front	Estate RWD M54B226S1		Flexible Coupling	510597
	2000.09-2003.12		Front	Estate RWD M54B226S1		Flexible Coupling Kit	510597S
523i							
2.5 (125 kw)	1995.09-2000.08		Centre	Saloon RWD M52B256S3/M52B256S4		Center Bearing Support	510659
	1995.09-2000.08		Centre	Saloon RWD M52B256S3/M52B256S4		Center Bearing Support	512301
	1995.09-2000.08		Centre	Saloon RWD M52B256S3/M52B256S4		Center Bearing Support	517185
	1995.09-2000.08		Front	Saloon RWD M52B256S3/M52B256S4		Flexible Coupling	510596
2.5 (130 kw)	2004.10-2007.02	AT	Rear	Saloon RWD N52B25A/N52B25BE/N52B25BE		Propshaft	PS900127
	2004.10-2007.02	AT	Rear	Saloon RWD N52B25A/N52B25BE/N52B25BE		Propshaft	PS900132
	2004.10-2007.02		Centre	Saloon RWD N52B25A/N52B25BE/N52B25BE		Center Bearing Support	513771
	2004.10-2007.02		Front	Saloon RWD N52B25A/N52B25BE/N52B25BE		Flexible Coupling	533422
	2004.10-2007.02		Front	Saloon RWD N52B25A/N52B25BE/N52B25BE		Flexible Coupling Kit	533422S
2.5 (140 kw)	2007.03-2009.12	AT	Rear	Saloon RWD N52B25A/N52B25BE/N53B25A		Propshaft	PS900127
	2007.03-2009.12	AT	Rear	Saloon RWD N52B25A/N52B25BE/N53B25A		Propshaft	PS900132
	2007.03-2009.12		Centre	Saloon RWD N52B25A/N52B25BE/N53B25A		Center Bearing Support	513771
	2007.03-2009.12		Front	Saloon RWD N52B25A/N52B25BE/N53B25A		Flexible Coupling	533422
	2007.03-2009.12		Front	Saloon RWD N52B25A/N52B25BE/N53B25A		Flexible Coupling Kit	533422S
2.5 (150 kw)	2010.01-2011.08		Centre	Saloon RWD N52B25A/N52B25AF/N52B25BE/N52B25BF		Center Bearing Support	531014
	2010.01-2011.08		Front	Saloon RWD N52B25A/N52B25AF/N52B25BE/N52B25BF		Flexible Coupling	533422
	2010.01-2011.08		Rear	Saloon RWD N52B25A/N52B25AF/N52B25BE/N52B25BF		Flexible Coupling	533878
	2010.01-2011.08		Front	Saloon RWD N52B25A/N52B25AF/N52B25BE/N52B25BF		Flexible Coupling Kit	533422S
	2010.01-2011.08		Rear	Saloon RWD N52B25A/N52B25AF/N52B25BE/N52B25BF		Flexible Coupling Kit	537625S
3.0 (150 kw)	2010.01-2011.08		Centre	Saloon RWD N53B30A		Center Bearing Support	531014
	2010.01-2011.08		Front	Saloon RWD N53B30A		Flexible Coupling	533422
	2010.01-2011.08		Rear	Saloon RWD N53B30A		Flexible Coupling	533878
	2010.01-2011.08		Rear	Saloon RWD N53B30A		Flexible Coupling	537625
	2010.01-2011.08		Front	Saloon RWD N53B30A		Flexible Coupling Kit	533422S



	 YEAR	TRANSM.	FITTING POSITION	BODY STYLE & DRIVE TYPE & ENGINE	REMARKS	 PRODUCT	GSP Ref.
BMW 523i							
3.0 (150 kw)	2010.01-2011.08		Rear	Saloon RWD N53B30A		Flexible Coupling Kit	537625S
3.0 (155 kw)	2010.01-2011.08		Rear	Saloon RWD N53B30A		Flexible Coupling	533878
	2010.01-2011.08		Rear	Saloon RWD N53B30A		Flexible Coupling	537625
	2010.01-2011.08		Rear	Saloon RWD N53B30A		Flexible Coupling Kit	537625S
523i Touring							
2.5 (120 kw)	1996.06-1998.09		Centre	Estate RWD M52B256S3		Center Bearing Support	510659
	1996.06-1998.09		Centre	Estate RWD M52B256S3		Center Bearing Support	512301
	1996.06-1998.09		Front	Estate RWD M52B256S3		Flexible Coupling	510596
	1996.06-1998.09		Front	Estate RWD M52B256S3		Flexible Coupling	510597
2.5 (125 kw)	1997.03-2000.09		Centre	Estate RWD M52B256S3/M52B256S4		Center Bearing Support	510659
	1997.03-2000.09		Centre	Estate RWD M52B256S3/M52B256S4		Center Bearing Support	517185
	1997.03-2000.09		Front	Estate RWD M52B256S3/M52B256S4		Flexible Coupling	510596
2.5 (130 kw)	2004.10-2007.02	AT	Rear	Estate RWD N52B25A/N52B25B/N52B25BE		Propshaft	PS900127
	2004.10-2007.02		Centre	Estate RWD N52B25A/N52B25B/N52B25BE		Center Bearing Support	513771
	2004.10-2007.02		Front	Estate RWD N52B25A/N52B25B/N52B25BE		Flexible Coupling	533422
	2004.10-2007.02		Front	Estate RWD N52B25A/N52B25B/N52B25BE		Flexible Coupling Kit	533422S
2.5 (140 kw)	2007.03-2010.03	AT	Rear	Estate RWD N52B25A/N53B25A		Propshaft	PS900127
	2007.03-2010.03		Centre	Estate RWD N52B25A/N53B25A		Center Bearing Support	513771
	2007.03-2010.03		Front	Estate RWD N52B25A/N53B25A		Flexible Coupling	533422
	2007.03-2010.03		Front	Estate RWD N52B25A/N53B25A		Flexible Coupling Kit	533422S
2.5 (150 kw)	2009.11-2011.12		Centre	Estate RWD N52B25A/N52B25AF/N52B25B		Center Bearing Support	531014
	2009.11-2011.12		Front	Estate RWD N52B25A/N52B25AF/N52B25B		Flexible Coupling	533422
	2009.11-2011.12		Rear	Estate RWD N52B25A/N52B25AF/N52B25B		Flexible Coupling	533878
	2009.11-2011.12		Rear	Estate RWD N52B25A/N52B25AF/N52B25B		Flexible Coupling	537625
	2009.11-2011.12		Front	Estate RWD N52B25A/N52B25AF/N52B25B		Flexible Coupling Kit	533422S
	2009.11-2011.12		Rear	Estate RWD N52B25A/N52B25AF/N52B25B		Flexible Coupling Kit	537625S
3.0 (150 kw)	2010.09-2011.12		Centre	Estate RWD N53B30A		Center Bearing Support	531014
	2010.09-2011.12		Front	Estate RWD N53B30A		Flexible Coupling	533422
	2010.09-2011.12		Rear	Estate RWD N53B30A		Flexible Coupling	533878
	2010.09-2011.12		Rear	Estate RWD N53B30A		Flexible Coupling	537625
	2010.09-2011.12		Front	Estate RWD N53B30A		Flexible Coupling Kit	533422S
	2010.09-2011.12		Rear	Estate RWD N53B30A		Flexible Coupling Kit	537625S
525d							
2.0 (155 kw)	2011.09-2016.10		Front;Rear	Saloon RWD N47D20D/N47S1D20D		Flexible Coupling	517955
	2011.09-2016.10		Front	Saloon RWD N47D20D/N47S1D20D		Flexible Coupling Kit	517955S
	2017.07-2019.06		Front;Rear	Saloon RWD B47D20B		Flexible Coupling	517955
	2017.07-2019.06		Front	Saloon RWD B47D20B		Flexible Coupling Kit	517955S
2.0 (160 kw)	2011.09-2016.10		Front	Saloon RWD N47D20D		Flexible Coupling	537631
	2011.09-2016.10		Front;Rear	Saloon RWD N47D20D		Flexible Coupling	517955
	2011.09-2016.10		Front	Saloon RWD N47D20D		Flexible Coupling Kit	517955S
2.0 (170 kw)	2017.07-2019.06		Front;Rear	Saloon RWD B47D20B		Flexible Coupling	517955
	2017.07-2019.06		Front	Saloon RWD B47D20B		Flexible Coupling Kit	517955S
2.5 (85 kw)	1993.03-1995.08		Centre	Saloon RWD M51D256T1		Center Bearing Support	510599
	1993.03-1995.08		Front	Saloon RWD M51D256T1		Flexible Coupling	510596
	1993.03-1995.08		Front	Saloon RWD M51D256T1		Flexible Coupling	510597
	1993.03-1995.08		Front	Saloon RWD M51D256T1		Flexible Coupling Kit	510597S
	1997.01-2003.06		Centre	Saloon RWD M51D256T1		Center Bearing Support	510659
	1997.01-2003.06		Centre	Saloon RWD M51D256T1		Center Bearing Support	517185
	1997.01-2003.06		Front	Saloon RWD M51D256T1		Flexible Coupling	510596
2.5 (105 kw)	1991.09-1995.08		Centre	Saloon RWD M51D256T1		Center Bearing Support	510599
	1991.09-1995.08		Front	Saloon RWD M51D256T1		Flexible Coupling	510596
	1996.01-2003.06		Centre	Saloon RWD M51D256T1		Center Bearing Support	510659
	1996.01-2003.06		Centre	Saloon RWD M51D256T1		Center Bearing Support	517185
	1996.01-2003.06		Front	Saloon RWD M51D256T1		Flexible Coupling	510596
2.5 (120 kw)	2000.02-2003.06		Front	Saloon RWD M57D256D1		Flexible Coupling	510663
	2000.02-2003.06		Front	Saloon RWD M57D256D1		Flexible Coupling	530160
2.5 (130 kw)	2004.03-2007.02		Centre	Saloon RWD M57D256D2		Center Bearing Support	513771
	2004.03-2007.02		Centre	Saloon RWD M57D256D2		Center Bearing Support	513772
	2004.03-2007.02		Front	Saloon RWD M57D256D2		Flexible Coupling	530758
	2004.03-2007.02		Front	Saloon RWD M57D256D2		Flexible Coupling Kit	530758S
3.0 (145 kw)	2007.08-2008.08	AT/MT	Front	Saloon 4WD M57D306D3		Propshaft	PS900128
	2007.08-2008.08		Centre	Saloon 4WD M57D306D3		Center Bearing Support	513771
	2007.08-2008.08		Centre	Saloon 4WD M57D306D3		Center Bearing Support	513772
	2007.08-2008.08		Front	Saloon 4WD M57D306D3		Flexible Coupling	517956



	 YEAR	TRANSM.	FITTING POSITION	BODY STYLE & DRIVE TYPE & ENGINE	REMARKS	 PRODUCT	GSP Ref.
BMW 525d							
3.0 (145 kw)	2007.09-2010.02		Centre	Saloon RWD M57D306D3		Center Bearing Support	513771
	2007.09-2010.02		Centre	Saloon RWD M57D306D3		Center Bearing Support	513772
	2007.09-2010.02		Front	Saloon RWD M57D306D3		Flexible Coupling	530758
	2007.09-2010.02		Front	Saloon RWD M57D306D3		Flexible Coupling Kit	530758S
3.0 (150 kw)	2010.03-2013.06		Front;Rear	Saloon RWD N57D30A		Flexible Coupling	517955
	2010.03-2013.06		Front	Saloon RWD N57D30A		Flexible Coupling Kit	517955S
525d Touring							
2.0 (155 kw)	2011.09-2017.02		Front;Rear	Estate RWD N47D20D/N47S1D20D		Flexible Coupling	517955
	2011.09-2017.02		Front	Estate RWD N47D20D/N47S1D20D		Flexible Coupling Kit	517955S
	2017.07-2019.06		Front;Rear	Estate RWD B47D20B		Flexible Coupling	517955
	2017.07-2019.06		Front	Estate RWD B47D20B		Flexible Coupling Kit	517955S
2.0 (160 kw)	2011.09-2017.02		Front	Estate RWD N47D20D		Flexible Coupling	537631
	2011.09-2017.02		Front;Rear	Estate RWD N47D20D		Flexible Coupling	517955
	2011.09-2017.02		Front	Estate RWD N47D20D		Flexible Coupling Kit	517955S
2.0 (170 kw)	2017.07-2019.06		Front;Rear	Estate RWD B47D20B		Flexible Coupling	517955
	2017.07-2019.06		Front	Estate RWD B47D20B		Flexible Coupling Kit	517955S
2.5 (85 kw)	1993.03-1996.07		Centre	Estate RWD M51D256T1		Center Bearing Support	510599
	1993.03-1996.07		Front	Estate RWD M51D256T1		Flexible Coupling	510596
	1993.03-1996.07		Front	Estate RWD M51D256T1		Flexible Coupling	510597
	1993.03-1996.07		Front	Estate RWD M51D256T1		Flexible Coupling Kit	510597S
2.5 (105 kw)	1991.12-1996.07		Centre	Estate RWD M51D256T1		Center Bearing Support	510599
	1991.12-1996.07		Front	Estate RWD M51D256T1		Flexible Coupling	510596
	1997.01-2004.05		Centre	Estate RWD M51D256T1		Center Bearing Support	510659
	1997.01-2004.05		Centre	Estate RWD M51D256T1		Center Bearing Support	517185
	1997.01-2004.05		Front	Estate RWD M51D256T1		Flexible Coupling	510596
2.5 (120 kw)	2000.09-2004.05		Front	Estate RWD M57D256D1		Flexible Coupling	510663
	2000.09-2004.05		Front	Estate RWD M57D256D1		Flexible Coupling	530160
	2004.06-2005.09		Centre	Estate RWD M57D256D2		Center Bearing Support	513771
	2004.06-2005.09		Centre	Estate RWD M57D256D2		Center Bearing Support	513772
	2004.06-2005.09		Front	Estate RWD M57D256D2		Flexible Coupling	530758
	2004.06-2005.09		Front	Estate RWD M57D256D2		Flexible Coupling Kit	530758S
3.0 (145 kw)	2007.03-2010.05		Centre	Estate RWD M57D306D3		Center Bearing Support	513771
	2007.03-2010.05		Centre	Estate RWD M57D306D3		Center Bearing Support	513772
	2007.03-2010.05		Front	Estate RWD M57D306D3		Flexible Coupling	530758
	2007.03-2010.05		Front	Estate RWD M57D306D3		Flexible Coupling Kit	530758S
	2007.05-2008.08	AT/MT	Front	Estate 4WD M57D306D3		Propshaft	PS900128
	2007.05-2008.08		Centre	Estate 4WD M57D306D3		Center Bearing Support	513771
	2007.05-2008.08		Centre	Estate 4WD M57D306D3		Center Bearing Support	513772
	2007.05-2008.08		Front	Estate 4WD M57D306D3		Flexible Coupling	517956
3.0 (150 kw)	2010.09-2011.08		Front;Rear	Estate RWD N57D30A		Flexible Coupling	517955
	2010.09-2011.08		Front	Estate RWD N57D30A		Flexible Coupling Kit	517955S
525d xDrive							
2.0 (155 kw)	2011.09-2016.10		Front;Rear	Saloon 4WD N47D20D		Flexible Coupling	517955
2.0 (160 kw)	2011.09-2016.10		Centre	Saloon 4WD N47D20D		Center Bearing Support	531013
	2011.09-2016.10		Front	Saloon 4WD N47D20D		Flexible Coupling	537631
	2011.09-2016.10		Front;Rear	Saloon 4WD N47D20D		Flexible Coupling	517955
3.0 (145 kw)	2008.09-2010.05	AT/MT	Front	Saloon 4WD M57D306D3		Propshaft	PS900128
525d xDrive Touring							
2.0 (155 kw)	2013.07-2017.02		Centre	Estate 4WD N47D20D		Center Bearing Support	531013
	2013.07-2017.02		Front;Rear	Estate 4WD N47D20D		Flexible Coupling	517955
2.0 (160 kw)	2013.07-2017.02		Centre	Estate 4WD N47D20D		Center Bearing Support	531013
	2013.07-2017.02		Front	Estate 4WD N47D20D		Flexible Coupling	537631
	2013.07-2017.02		Front;Rear	Estate 4WD N47D20D		Flexible Coupling	517955
3.0 (145 kw)	2008.09-2010.05	AT/MT	Front	Estate 4WD M57D306D3		Propshaft	PS900128
525i							
2.5 (137 kw)	2003.07-2009.12	AT	Rear	Saloon RWD M54 B25(256S5)		Propshaft	PS900127
2.5 (141 kw)	1990.03-1995.08		Centre	Saloon RWD M50B256S1/M50B256S2		Center Bearing Support	510599
	1990.03-1995.08		Front	Saloon RWD M50B256S1/M50B256S2		Flexible Coupling	510596
	1991.10-1995.08		Centre	Saloon 4WD M50B256S1/M50B256S2		Center Bearing Support	510599
	1991.10-1995.08		Front	Saloon 4WD M50B256S1/M50B256S2		Flexible Coupling	510596
	1991.10-1995.08		Front	Saloon 4WD M50B256S1/M50B256S2		Flexible Coupling	510641
	1991.10-1995.08		Front	Saloon 4WD M50B256S1/M50B256S2		Flexible Coupling	537631
	2000.09-2003.06		Centre	Saloon RWD M54B256S5		Center Bearing Support	510659
	2000.09-2003.06		Front	Saloon RWD M54B256S5		Flexible Coupling	510596

	 YEAR	TRANSM.	FITTING POSITION	BODY STYLE & DRIVE TYPE & ENGINE	REMARKS	 PRODUCT	GSP Ref.
BMW 525i							
2.5 (141 kw)	2000.09-2003.06		Front	Saloon RWD M54B256S5		Flexible Coupling	510597
	2003.09-2005.02	AT	Rear	Saloon RWD M54B256S5		Propshaft	PS900127
	2003.09-2005.02		Centre	Saloon RWD M54B256S5		Center Bearing Support	513771
	2003.09-2005.02		Front	Saloon RWD M54B256S5		Flexible Coupling	533422
	2003.09-2005.02		Front	Saloon RWD M54B256S5		Flexible Coupling Kit	533422S
2.5 (155 kw)	2005.07-2010.03	AT	Rear	Saloon RWD N52B25A		Propshaft	PS900127
2.5 (160 kw)	2005.03-2009.12	AT	Rear	Saloon RWD N52B25A/N52B25B/N52B25BF		Propshaft	PS900127
	2005.03-2009.12		Centre	Saloon RWD N52B25A/N52B25B/N52B25BF		Center Bearing Support	513771
	2005.03-2009.12		Front	Saloon RWD N52B25A/N52B25B/N52B25BF		Flexible Coupling	533422
	2005.03-2009.12		Front	Saloon RWD N52B25A/N52B25B/N52B25BF		Flexible Coupling Kit	533422S
	2005.04-2007.02	AT/MT	Front	Saloon 4WD N52B25A		Propshaft	PS900128
	2005.04-2007.02	AT	Rear	Saloon 4WD N52B25A		Propshaft	PS900129
	2005.04-2007.02		Centre	Saloon 4WD N52B25A		Center Bearing Support	513771
	2005.04-2007.02		Front	Saloon 4WD N52B25A		Flexible Coupling	517956
3.0 (160 kw)	2005.03-2010.03	AT	Rear	Saloon RWD N52B30A/N53B30A		Propshaft	PS900127
	2005.03-2010.03		Centre	Saloon RWD N52B30A/N53B30A		Center Bearing Support	513771
	2005.03-2010.03		Front	Saloon RWD N52B30A/N53B30A		Flexible Coupling	533422
	2005.03-2010.03		Front	Saloon RWD N52B30A/N53B30A		Flexible Coupling Kit	533422S
	2007.03-2009.12	AT/MT	Front	Saloon 4WD N53B30A		Propshaft	PS900128
	2007.03-2009.12		Centre	Saloon 4WD N53B30A		Center Bearing Support	513771
	2007.03-2009.12		Front	Saloon 4WD N53B30A		Flexible Coupling	517956
525i Touring							
2.5 (141 kw)	1991.07-1996.07		Centre	Estate RWD M50256S1/M50256S2		Center Bearing Support	510599
	1991.07-1996.07		Front	Estate RWD M50256S1/M50256S2		Flexible Coupling	510596
	1992.01-1996.03		Centre	Estate 4WD M50B256S1/M50B256S2		Center Bearing Support	510599
	1992.01-1996.03		Front	Estate 4WD M50B256S1/M50B256S2		Flexible Coupling	510596
	1992.01-1996.03		Front	Estate 4WD M50B256S1/M50B256S2		Flexible Coupling	510641
	1992.01-1996.03		Front	Estate 4WD M50B256S1/M50B256S2		Flexible Coupling	537631
	2000.08-2004.05		Centre	Estate RWD M54B256S5		Center Bearing Support	510659
	2000.08-2004.05		Front	Estate RWD M54B256S5		Flexible Coupling	510596
	2004.06-2005.05	AT	Rear	Estate RWD M54B256S5		Propshaft	PS900127
	2004.06-2005.05		Centre	Estate RWD M54B256S5		Center Bearing Support	513771
	2004.06-2005.05		Front	Estate RWD M54B256S5		Flexible Coupling	533422
	2004.06-2005.05		Front	Estate RWD M54B256S5		Flexible Coupling Kit	533422S
2.5 (155 kw)	2005.03-2010.05	AT	Rear	Estate RWD N52B25A		Propshaft	PS900127
2.5 (160 kw)	2004.10-2010.05	AT	Rear	Estate RWD N52B25A/N52B25B/N52B25BF		Propshaft	PS900127
	2004.10-2010.05		Centre	Estate RWD N52B25A/N52B25B/N52B25BF		Center Bearing Support	513771
	2004.10-2010.05		Front	Estate RWD N52B25A/N52B25B/N52B25BF		Flexible Coupling	533422
	2004.10-2010.05		Front	Estate RWD N52B25A/N52B25B/N52B25BF		Flexible Coupling Kit	533422S
	2005.03-2007.02	AT/MT	Front	Estate 4WD N52B25A		Propshaft	PS900128
	2005.03-2007.02	AT	Rear	Estate 4WD N52B25A		Propshaft	PS900129
	2005.03-2007.02		Centre	Estate 4WD N52B25A		Center Bearing Support	513771
	2005.03-2007.02		Front	Estate 4WD N52B25A		Flexible Coupling	517956
3.0 (160 kw)	2007.09-2008.08	AT/MT	Front	Estate 4WD N53B30A		Propshaft	PS900128
	2007.09-2008.08		Centre	Estate 4WD N53B30A		Center Bearing Support	513771
	2007.09-2008.08		Front	Estate 4WD N53B30A		Flexible Coupling	517956
	2007.09-2010.03		Centre	Estate RWD N53B30A		Center Bearing Support	513771
	2007.09-2010.03		Front	Estate RWD N53B30A		Flexible Coupling	533422
	2007.09-2010.03		Front	Estate RWD N53B30A		Flexible Coupling Kit	533422S
525i xDrive							
3.0 (160 kw)	2008.09-2010.03	AT/MT	Front	Saloon 4WD N53B30A		Propshaft	PS900128
525i xDrive Touring							
3.0 (160 kw)	2008.09-2010.03	AT/MT	Front	Estate 4WD N53B30A		Propshaft	PS900128
528i							
2.0 (180 kw)	2011.09-2016.10		Centre	Saloon RWD N20B20A		Center Bearing Support	531014
	2011.09-2016.10		Front	Saloon RWD N20B20A		Flexible Coupling	510596
	2011.09-2016.10		Front	Saloon RWD N20B20A		Flexible Coupling	533422
	2011.09-2016.10		Rear	Saloon RWD N20B20A		Flexible Coupling	537625
	2011.09-2016.10		Front	Saloon RWD N20B20A		Flexible Coupling Kit	510596S
	2011.09-2016.10		Front	Saloon RWD N20B20A		Flexible Coupling Kit	533422S
	2011.09-2016.10		Rear	Saloon RWD N20B20A		Flexible Coupling Kit	537625S
2.8 (142 kw)	1995.09-2000.08		Centre	Saloon RWD M52B286S1/M52B286S2		Center Bearing Support	510659
	1995.09-2000.08		Centre	Saloon RWD M52B286S1/M52B286S2		Center Bearing Support	517185
	1995.09-2000.08		Front	Saloon RWD M52B286S1/M52B286S2		Flexible Coupling	510596



	 YEAR	TRANSM.	FITTING POSITION	BODY STYLE & DRIVE TYPE & ENGINE	REMARKS	 PRODUCT	GSP Ref.
BMW 528i							
3.0 (190 kw)	2010.03-2011.08		Centre	Saloon RWD N53B30A		Center Bearing Support	531014
	2010.03-2011.08		Front	Saloon RWD N53B30A		Flexible Coupling	533422
	2010.03-2011.08		Rear	Saloon RWD N53B30A		Flexible Coupling	533878
	2010.03-2011.08		Rear	Saloon RWD N53B30A		Flexible Coupling	537625
	2010.03-2011.08		Front	Saloon RWD N53B30A		Flexible Coupling Kit	533422S
	2010.03-2011.08		Rear	Saloon RWD N53B30A		Flexible Coupling Kit	537625S
528i Gran Turismo							
2.0 (180 kw)	2013.07-2017.02		Centre	Hatchback RWD N20B20A		Center Bearing Support	531014
	2013.07-2017.02		Front	Hatchback RWD N20B20A		Flexible Coupling	510596
	2013.07-2017.02		Rear	Hatchback RWD N20B20A		Flexible Coupling	537625
	2013.07-2017.02		Front	Hatchback RWD N20B20A		Flexible Coupling Kit	510596S
	2013.07-2017.02		Rear	Hatchback RWD N20B20A		Flexible Coupling Kit	537625S
528i Touring							
2.0 (180 kw)	2011.09-2017.02		Centre	Estate RWD N20B20A		Center Bearing Support	531014
	2011.09-2017.02		Front	Estate RWD N20B20A		Flexible Coupling	510596
	2011.09-2017.02		Front	Estate RWD N20B20A		Flexible Coupling	533422
	2011.09-2017.02		Rear	Estate RWD N20B20A		Flexible Coupling	537625
	2011.09-2017.02		Front	Estate RWD N20B20A		Flexible Coupling Kit	510596S
	2011.09-2017.02		Front	Estate RWD N20B20A		Flexible Coupling Kit	533422S
	2011.09-2017.02		Rear	Estate RWD N20B20A		Flexible Coupling Kit	537625S
2.8 (142 kw)	1996.11-2000.08	AT/MT	Rear	Estate RWD M52B286S1/M52B286S2	Date To:1998.12	Joint,propshaft	605057
	1996.11-2000.08		Centre	Estate RWD M52B286S1/M52B286S2		Center Bearing Support	510659
	1996.11-2000.08		Centre	Estate RWD M52B286S1/M52B286S2		Center Bearing Support	517185
	1996.11-2000.08		Front	Estate RWD M52B286S1/M52B286S2		Flexible Coupling	510596
3.0 (190 kw)	2010.09-2013.06		Centre	Estate RWD N53B30A		Center Bearing Support	531014
	2010.09-2013.06		Front	Estate RWD N53B30A		Flexible Coupling	533422
	2010.09-2013.06		Rear	Estate RWD N53B30A		Flexible Coupling	533878
	2010.09-2013.06		Rear	Estate RWD N53B30A		Flexible Coupling	537625
	2010.09-2013.06		Front	Estate RWD N53B30A		Flexible Coupling Kit	533422S
	2010.09-2013.06		Rear	Estate RWD N53B30A		Flexible Coupling Kit	537625S
528i xDrive							
2.0 (180 kw)	2011.09-2016.10		Centre	Saloon 4WD N20B20A		Center Bearing Support	531013
	2011.09-2016.10		Front	Saloon 4WD N20B20A		Flexible Coupling	537631
	2011.09-2016.10		Front;Rear	Saloon 4WD N20B20A		Flexible Coupling	517955
528i xDrive Touring							
2.0 (180 kw)	2011.09-2017.02	AT	Front	Estate 4WD N20B20A		Propshaft	PS900138
	2011.09-2017.02		Centre	Estate 4WD N20B20A		Center Bearing Support	531013
	2011.09-2017.02		Front	Estate 4WD N20B20A		Flexible Coupling	537631
	2011.09-2017.02		Front;Rear	Estate 4WD N20B20A		Flexible Coupling	517955
530d							
3.0 (135 kw)	1998.05-2000.08		Front	Saloon RWD M57D306D1		Flexible Coupling	510663
	1998.05-2000.08		Front	Saloon RWD M57D306D1		Flexible Coupling	530160
3.0 (142 kw)	2000.09-2003.05		Front	Saloon RWD M57D306D1		Flexible Coupling	510663
	2000.09-2003.05		Front	Saloon RWD M57D306D1		Flexible Coupling	530160
3.0 (160 kw)	2003.06-2005.09		Centre	Saloon RWD M57D306D2		Center Bearing Support	513772
3.0 (170 kw)	2005.02-2007.02	AT/MT	Front	Saloon 4WD M57D306D3		Propshaft	PS900128
	2005.02-2007.02		Centre	Saloon 4WD M57D306D3		Center Bearing Support	513771
	2005.02-2007.02		Centre	Saloon 4WD M57D306D3		Center Bearing Support	513772
	2005.02-2007.02		Front	Saloon 4WD M57D306D3		Flexible Coupling	517956
	2005.09-2007.03		Centre	Saloon RWD M57D306D3		Center Bearing Support	513772
	2005.09-2007.03		Front	Saloon RWD M57D306D3		Flexible Coupling	530758
	2005.09-2007.03		Front	Saloon RWD M57D306D3		Flexible Coupling Kit	530758S
	2005.09-2007.03		Front	Saloon RWD M57D306D3		Center Bearing Support	513772
3.0 (173 kw)	2007.02-2009.12		Centre	Saloon RWD M57D306D3		Center Bearing Support	513772
	2007.02-2009.12		Front	Saloon RWD M57D306D3		Flexible Coupling	530758
	2007.02-2009.12		Front	Saloon RWD M57D306D3		Flexible Coupling Kit	530758S
	2007.03-2007.08	AT/MT	Front	Saloon 4WD M57D306D3		Propshaft	PS900128
	2007.03-2007.08		Centre	Saloon 4WD M57D306D3		Center Bearing Support	513771
	2007.03-2007.08		Centre	Saloon 4WD M57D306D3		Center Bearing Support	513772
	2007.03-2007.08		Front	Saloon 4WD M57D306D3		Flexible Coupling	517956
3.0 (180 kw)	2010.01-2011.08		Front;Rear	Saloon RWD N57D30A		Flexible Coupling	517955
	2010.01-2011.08		Front;Rear	Saloon RWD N57D30A		Flexible Coupling	537668
	2010.01-2011.08		Front	Saloon RWD N57D30A		Flexible Coupling Kit	517955S
	2010.01-2011.08		Front	Saloon RWD N57D30A		Flexible Coupling Kit	537668S

	 YEAR	TRANSM.	FITTING POSITION	BODY STYLE & DRIVE TYPE & ENGINE	REMARKS	 PRODUCT	GSP Ref.
BMW 530d							
3.0 (190 kw)	2011.09-2016.10		Front;Rear	Saloon RWD N57D30A		Flexible Coupling	517955
	2011.09-2016.10		Front;Rear	Saloon RWD N57D30A		Flexible Coupling	537668
	2011.09-2016.10		Front	Saloon RWD N57D30A		Flexible Coupling Kit	517955S
	2011.09-2016.10		Front	Saloon RWD N57D30A		Flexible Coupling Kit	537668S
3.0 (195 kw)	2016.09-2020.06		Front;Rear	Saloon RWD B57D30A		Flexible Coupling	517955
	2016.09-2020.06		Front	Saloon RWD B57D30A		Flexible Coupling Kit	517955S
3.0 (210 kw)	2010.09-2016.10		Front;Rear	Saloon RWD N57D30A		Flexible Coupling	517955
	2010.09-2016.10		Front	Saloon RWD N57D30A		Flexible Coupling Kit	517955S
530d Gran Turismo							
3.0 (155 kw)	2010.09-2017.02		Front;Rear	Hatchback RWD N57D30A		Flexible Coupling	517955
	2010.09-2017.02		Front	Hatchback RWD N57D30A		Flexible Coupling Kit	517955S
3.0 (180 kw)	2009.08-2012.06		Front;Rear	Hatchback RWD N57D30A		Flexible Coupling	517955
	2009.08-2012.06		Front	Hatchback RWD N57D30A		Flexible Coupling Kit	517955S
3.0 (190 kw)	2012.07-2017.02		Front;Rear	Hatchback RWD N57D30A		Flexible Coupling	517955
	2012.07-2017.02		Front	Hatchback RWD N57D30A		Flexible Coupling Kit	517955S
530d Touring							
3.0 (135 kw)	1998.05-2000.08		Front	Estate RWD M57D306D1		Flexible Coupling	510663
	1998.05-2000.08		Front	Estate RWD M57D306D1		Flexible Coupling	530160
3.0 (142 kw)	1998.09-2004.05		Front	Estate RWD M57D306D1		Flexible Coupling	510663
	1998.09-2004.05		Front	Estate RWD M57D306D1		Flexible Coupling	530160
3.0 (160 kw)	2003.10-2005.09		Centre	Estate RWD M57D306D2		Center Bearing Support	513772
	2003.10-2005.09		Front	Estate RWD M57D306D2		Flexible Coupling	530758
	2003.10-2005.09		Front	Estate RWD M57D306D2		Flexible Coupling Kit	530758S
3.0 (170 kw)	2005.02-2007.02	AT/MT	Front	Estate 4WD M57D306D3		Propshaft	PS900128
	2005.02-2007.02		Centre	Estate 4WD M57D306D3		Center Bearing Support	513771
	2005.02-2007.02		Centre	Estate 4WD M57D306D3		Center Bearing Support	513772
	2005.02-2007.02		Centre	Estate RWD M57D306D3		Center Bearing Support	513772
	2005.02-2007.02		Front	Estate 4WD M57D306D3		Flexible Coupling	517956
	2005.02-2007.02		Front	Estate RWD M57D306D3		Flexible Coupling	530758
	2005.02-2007.02		Front	Estate RWD M57D306D3		Flexible Coupling Kit	530758S
3.0 (173 kw)	2007.02-2010.05		Centre	Estate RWD M57D306D3		Center Bearing Support	513772
	2007.02-2010.05		Front	Estate RWD M57D306D3		Flexible Coupling	530758
	2007.02-2010.05		Front	Estate RWD M57D306D3		Flexible Coupling Kit	530758S
	2007.03-2007.08	AT/MT	Front	Estate 4WD M57D306D3		Propshaft	PS900128
	2007.03-2007.08		Centre	Estate 4WD M57D306D3		Center Bearing Support	513771
	2007.03-2007.08		Centre	Estate 4WD M57D306D3		Center Bearing Support	513772
	2007.03-2007.08		Front	Estate 4WD M57D306D3		Flexible Coupling	517956
3.0 (180 kw)	2010.06-2011.08		Front;Rear	Estate RWD N57D30A		Flexible Coupling	517955
	2010.06-2011.08		Front;Rear	Estate RWD N57D30A		Flexible Coupling	537668
	2010.06-2011.08		Front	Estate RWD N57D30A		Flexible Coupling Kit	517955S
	2010.06-2011.08		Front	Estate RWD N57D30A		Flexible Coupling Kit	537668S
3.0 (190 kw)	2011.09-2017.02		Front;Rear	Estate RWD N57D30A		Flexible Coupling	517955
	2011.09-2017.02		Front;Rear	Estate RWD N57D30A		Flexible Coupling	537668
	2011.09-2017.02		Front	Estate RWD N57D30A		Flexible Coupling Kit	517955S
	2011.09-2017.02		Front	Estate RWD N57D30A		Flexible Coupling Kit	537668S
3.0 (195 kw)	2017.03-2020.06		Front;Rear	Estate RWD B57D30A		Flexible Coupling	517955
	2017.03-2020.06		Front	Estate RWD B57D30A		Flexible Coupling Kit	517955S
3.0 (210 kw)	2011.09-2017.02		Front;Rear	Estate RWD N57D30A		Flexible Coupling	517955
	2011.09-2017.02		Front	Estate RWD N57D30A		Flexible Coupling Kit	517955S
530d xDrive							
3.0 (173 kw)	2007.09-2009.12	AT/MT	Front	Saloon 4WD M57D306D3		Propshaft	PS900128
3.0 (183 kw)	2016.09-2020.06		Front;Rear	Saloon 4WD B57D30A		Flexible Coupling	517955
3.0 (190 kw)	2011.03-2016.10		Front;Rear	Saloon 4WD N57D30A		Flexible Coupling	517955
	2011.03-2016.10		Front	Saloon 4WD N57D30A		Flexible Coupling Kit	517955S
3.0 (195 kw)	2016.09-2020.06		Front;Rear	Saloon 4WD B57D30A		Flexible Coupling	517955
3.0 (210 kw)	2011.03-2016.10		Front;Rear	Saloon 4WD N57D30A		Flexible Coupling	517955
	2011.03-2016.10		Front	Saloon 4WD N57D30A		Flexible Coupling Kit	517955S
530d xDrive Gran Turismo							
3.0 (180 kw)	2010.06-2012.06		Front;Rear	Hatchback 4WD N57D30A		Flexible Coupling	517955
	2010.06-2012.06		Front	Hatchback 4WD N57D30A		Flexible Coupling Kit	517955S
3.0 (190 kw)	2012.07-2017.02		Front;Rear	Hatchback 4WD N57D30A		Flexible Coupling	517955
530d xDrive Touring							
3.0 (173 kw)	2007.09-2010.05	AT/MT	Front	Estate 4WD M57D306D3		Propshaft	PS900128

	 YEAR	TRANSM.	FITTING POSITION	BODY STYLE & DRIVE TYPE & ENGINE	REMARKS	 PRODUCT	GSP Ref.	
BMW								
530d xDrive Touring								
3.0 (190 kw)	2011.03-2017.02		Front;Rear	Estate 4WD N57D30A		Flexible Coupling	517955	
	2011.03-2017.02		Front	Estate 4WD N57D30A		Flexible Coupling Kit	517955S	
3.0 (195 kw)	2017.03-2020.06		Front;Rear	Estate 4WD B57D30A		Flexible Coupling	517955	
3.0 (210 kw)	2011.03-2017.02		Front;Rear	Estate 4WD N57D30A		Flexible Coupling	517955	
	2011.03-2017.02		Front	Estate 4WD N57D30A		Flexible Coupling Kit	517955S	
530e								
2.0 (135 kw)	2017.03-		Front;Rear	Saloon RWD B46B20B/B48B20A/GC1		Flexible Coupling	517955	
	2017.03-		Front	Saloon RWD B46B20B/B48B20A/GC1		Flexible Coupling Kit	517955S	
530i								
2.0 (185 kw)	2016.09-2020.06		Rear	Saloon RWD B46B20B/B48B20B		Flexible Coupling	537625	
3.0 (160 kw)	1992.09-1995.12		Centre	Saloon RWD M60B308S1		Center Bearing Support	510599	
	1992.09-1995.12		Front	Saloon RWD M60B308S1		Flexible Coupling	510596	
3.0 (170 kw)	2000.09-2003.06		Centre	Saloon RWD M54B306S3		Center Bearing Support	510659	
	2000.09-2003.06		Front	Saloon RWD M54B306S3		Flexible Coupling	510596	
	2003.07-2005.03		Centre	Saloon RWD M54B306S3		Center Bearing Support	513771	
	2003.07-2005.03		Front	Saloon RWD M54B306S3		Flexible Coupling	533422	
	2003.07-2005.03		Front	Saloon RWD M54B306S3		Flexible Coupling Kit	533422S	
3.0 (190 kw)	2004.09-2007.02	AT/MT	Front	Saloon 4WD N52B30A		Propshaft	PS900128	
	2004.09-2007.02	AT	Rear	Saloon 4WD N52B30A		Propshaft	PS900129	
	2004.09-2007.02		Centre	Saloon 4WD N52B30A		Center Bearing Support	513771	
	2004.09-2007.02		Front	Saloon 4WD N52B30A		Flexible Coupling	517956	
	2005.03-2007.03		Centre	Saloon RWD N52B30A/N52B30BF		Center Bearing Support	513771	
	2005.03-2007.03		Front	Saloon RWD N52B30A/N52B30BF		Flexible Coupling	533422	
	2005.03-2007.03		Front	Saloon RWD N52B30A/N52B30BF		Flexible Coupling Kit	533422S	
	2010.03-2013.06		Front	Saloon RWD N52B30A/N52B30AF/N52B30BF		Flexible Coupling	510596	
	2010.03-2013.06		Rear	Saloon RWD N52B30A/N52B30AF/N52B30BF		Flexible Coupling	533878	
	2010.03-2013.06		Rear	Saloon RWD N52B30A/N52B30AF/N52B30BF		Flexible Coupling	537625	
	2010.03-2013.06		Rear	Saloon RWD N52B30A/N52B30AF/N52B30BF		Flexible Coupling Kit	537625S	
	3.0 (200 kw)	2007.02-2009.10	AT/MT	Front	Saloon 4WD N52B30A/N53B30A		Propshaft	PS900128
		2007.02-2009.10	AT	Rear	Saloon 4WD N52B30A/N53B30A		Propshaft	PS900129
2007.02-2009.10			Centre	Saloon 4WD N52B30A/N53B30A		Center Bearing Support	513771	
2007.02-2009.10			Front	Saloon 4WD N52B30A/N53B30A		Flexible Coupling	517956	
2007.03-2009.12			Centre	Saloon RWD N52B30A/N52B30BF/N53B30A		Center Bearing Support	513771	
2007.03-2009.12			Front	Saloon RWD N52B30A/N52B30BF/N53B30A		Flexible Coupling	533422	
2007.03-2009.12			Front	Saloon RWD N52B30A/N52B30BF/N53B30A		Flexible Coupling Kit	533422S	
2011.05-2013.06			Centre	Saloon RWD N53B30A		Center Bearing Support	531014	
2011.05-2013.06			Front	Saloon RWD N53B30A		Flexible Coupling	533422	
2011.05-2013.06			Rear	Saloon RWD N53B30A		Flexible Coupling	537625	
2011.05-2013.06			Front	Saloon RWD N53B30A		Flexible Coupling Kit	533422S	
2011.05-2013.06			Rear	Saloon RWD N53B30A		Flexible Coupling Kit	537625S	
530i Touring								
2.0 (185 kw)	2017.03-2020.06		Rear	Estate RWD B48B20B		Flexible Coupling	537625	
	2017.03-2020.06		Rear	Estate RWD B48B20B		Flexible Coupling Kit	537625S	
3.0 (160 kw)	1992.09-1996.09		Centre	Estate RWD M60B308S1		Center Bearing Support	510599	
	1992.09-1996.09		Front	Estate RWD M60B308S1		Flexible Coupling	510596	
3.0 (170 kw)	2000.09-2003.12	AT/MT	Rear	Estate RWD M54B306S3		Joint,propshaft	605057	
	2000.09-2003.12		Centre	Estate RWD M54B306S3		Center Bearing Support	510659	
	2000.09-2003.12		Front	Estate RWD M54B306S3		Flexible Coupling	510596	
3.0 (190 kw)	2004.09-2007.02		Centre	Estate RWD N52B30A/N52B30BF		Center Bearing Support	513771	
	2004.09-2007.02		Front	Estate RWD N52B30A/N52B30BF		Flexible Coupling	533422	
	2004.09-2007.02		Front	Estate RWD N52B30A/N52B30BF		Flexible Coupling Kit	533422S	
	2005.04-2007.02	AT/MT	Front	Estate 4WD N52B30A		Propshaft	PS900128	
	2005.04-2007.02	AT	Rear	Estate 4WD N52B30A		Propshaft	PS900129	
	2005.04-2007.02		Centre	Estate 4WD N52B30A		Center Bearing Support	513771	
	2005.04-2007.02		Front	Estate 4WD N52B30A		Flexible Coupling	517956	
	2010.03-2013.06		Rear	Estate RWD N52B30A/N52B30AF		Flexible Coupling	533878	
	2010.03-2013.06		Rear	Estate RWD N52B30A/N52B30AF		Flexible Coupling	537625	
	2010.03-2013.06		Rear	Estate RWD N52B30A/N52B30AF		Flexible Coupling Kit	537625S	
3.0 (200 kw)	2006.09-2008.09	AT/MT	Front	Estate 4WD N52B30A/N53B30A		Propshaft	PS900128	
	2006.09-2008.09	AT	Rear	Estate 4WD N52B30A/N53B30A		Propshaft	PS900129	
	2006.09-2008.09		Centre	Estate 4WD N52B30A/N53B30A		Center Bearing Support	513771	
	2006.09-2008.09		Front	Estate 4WD N52B30A/N53B30A		Flexible Coupling	517956	
	2007.01-2010.12		Centre	Estate RWD N52B30A/N53B30A		Center Bearing Support	513771	
	2007.01-2010.12		Front	Estate RWD N52B30A/N53B30A		Flexible Coupling	533422	



	 YEAR	TRANSM.	FITTING POSITION	BODY STYLE & DRIVE TYPE & ENGINE	REMARKS	 PRODUCT	GSP Ref.
BMW							
530i Touring							
3.0 (200 kw)	2007.01-2010.12		Front	Estate RWD N52B30A/N53B30A		Flexible Coupling Kit	533422S
	2011.07-2013.06		Centre	Estate RWD N53B30A		Center Bearing Support	531014
	2011.07-2013.06		Front	Estate RWD N53B30A		Flexible Coupling	533422
	2011.07-2013.06		Rear	Estate RWD N53B30A		Flexible Coupling	537625
	2011.07-2013.06		Front	Estate RWD N53B30A		Flexible Coupling Kit	533422S
	2011.07-2013.06		Rear	Estate RWD N53B30A		Flexible Coupling Kit	537625S
530i xDrive							
2.0 (183 kw)	2016.09-		Rear	Saloon 4WD B46B20B		Flexible Coupling	537625
2.0 (185 kw)	2016.09-2020.06		Rear	Saloon 4WD B46B20B/B48B20B		Flexible Coupling	537625
3.0 (200 kw)	2008.09-2009.12	AT/MT	Front	Saloon 4WD N53B30A		Propshaft	PS900128
	2008.09-2009.12		Centre	Saloon 4WD N53B30A		Center Bearing Support	513771
	2008.09-2009.12		Front	Saloon 4WD N53B30A		Flexible Coupling	517956
530i xDrive Touring							
2.0 (185 kw)	2017.07-2020.06		Rear	Estate 4WD B48B20B		Flexible Coupling	537625
	2017.07-2020.06		Rear	Estate 4WD B48B20B		Flexible Coupling Kit	537625S
3.0 (200 kw)	2008.09-2010.03	AT/MT	Front	Estate 4WD N53B30A		Propshaft	PS900128
535d							
3.0 (200 kw)	2004.08-2007.02		Centre	Saloon RWD M57D306D4		Center Bearing Support	513772
	2004.08-2007.02		Front	Saloon RWD M57D306D4		Flexible Coupling	537669
	2004.08-2007.02		Front;Rear	Saloon RWD M57D306D4		Flexible Coupling	537668
3.0 (210 kw)	2007.03-2010.03		Centre	Saloon RWD M57D306D5		Center Bearing Support	513772
	2007.03-2010.03		Front	Saloon RWD M57D306D5		Flexible Coupling	530758
	2007.03-2010.03		Front	Saloon RWD M57D306D5		Flexible Coupling Kit	530758S
3.0 (220 kw)	2010.09-2011.08		Front;Rear	Saloon RWD N57D30B		Flexible Coupling	517955
	2010.09-2011.08		Front;Rear	Saloon RWD N57D30B		Flexible Coupling	537668
3.0 (230 kw)	2011.09-2016.10		Front;Rear	Saloon RWD N57D30B		Flexible Coupling	517955
	2011.09-2016.10		Front;Rear	Saloon RWD N57D30B		Flexible Coupling	537668
	2011.09-2016.10		Front	Saloon RWD N57D30B		Flexible Coupling Kit	517955S
	2011.09-2016.10		Front	Saloon RWD N57D30B		Flexible Coupling Kit	537668S
535d Gran Turismo							
3.0 (220 kw)	2010.03-2012.06		Front;Rear	Hatchback RWD N57D30B		Flexible Coupling	537668
	2010.03-2012.06		Front	Hatchback RWD N57D30B		Flexible Coupling Kit	537668S
3.0 (230 kw)	2012.07-2017.02		Front;Rear	Hatchback RWD N57D30B		Flexible Coupling	537668
	2012.07-2017.02		Front	Hatchback RWD N57D30B		Flexible Coupling Kit	537668S
535d Touring							
3.0 (200 kw)	2004.08-2007.02		Centre	Estate RWD M57D306D4		Center Bearing Support	513772
	2004.08-2007.02		Front	Estate RWD M57D306D4		Flexible Coupling	530758
	2004.08-2007.02		Front	Estate RWD M57D306D4		Flexible Coupling	537669
	2004.08-2007.02		Front;Rear	Estate RWD M57D306D4		Flexible Coupling	537668
3.0 (210 kw)	2007.03-2010.08		Centre	Estate RWD M57D306D5		Center Bearing Support	513772
	2007.03-2010.08		Front	Estate RWD M57D306D5		Flexible Coupling Kit	530758S
3.0 (220 kw)	2010.09-2011.08		Front;Rear	Estate RWD N57D30B		Flexible Coupling	537668
	2010.09-2011.08		Front	Estate RWD N57D30B		Flexible Coupling Kit	537668S
3.0 (230 kw)	2011.09-2017.02		Front;Rear	Estate RWD N57D30B		Flexible Coupling	537668
	2011.09-2017.02		Front	Estate RWD N57D30B		Flexible Coupling Kit	537668S
535d xDrive							
3.0 (230 kw)	2011.02-2016.10		Front;Rear	Saloon 4WD N57D30B		Flexible Coupling	517955
	2011.02-2016.10		Front	Saloon 4WD N57D30B		Flexible Coupling Kit	517955S
535d xDrive Gran Turismo							
3.0 (220 kw)	2010.03-2012.06		Front;Rear	Hatchback 4WD N57D30B		Flexible Coupling	517955
	2010.03-2012.06		Front	Hatchback 4WD N57D30B		Flexible Coupling Kit	517955S
3.0 (230 kw)	2012.07-2017.02		Front;Rear	Hatchback 4WD N57D30B		Flexible Coupling	517955
	2012.07-2017.02		Front	Hatchback 4WD N57D30B		Flexible Coupling Kit	517955S
535d xDrive Touring							
3.0 (230 kw)	2011.09-2017.02	AT	Front	Estate 4WD N57D30B		Propshaft	PS900138
	2011.09-2017.02		Front;Rear	Estate 4WD N57D30B		Flexible Coupling	517955
	2011.09-2017.02		Front	Estate 4WD N57D30B		Flexible Coupling Kit	517955S
535i							
3.0 (224 kw)	2008.01-2009.12		Front	Saloon RWD N54B30A		Flexible Coupling Kit	517955S
3.0 (225 kw)	2010.01-2016.10		Centre	Saloon RWD N55B30A		Center Bearing Support	531018
	2010.01-2016.10		Front;Rear	Saloon RWD N55B30A		Flexible Coupling	517955
	2010.01-2016.10		Front	Saloon RWD N55B30A		Flexible Coupling Kit	517955S
3.0 (240 kw)	2013.07-2016.10		Front	Saloon RWD N55B30A		Flexible Coupling Kit	517955S



	 YEAR	TRANSM.	FITTING POSITION	BODY STYLE & DRIVE TYPE & ENGINE	REMARKS	 PRODUCT	GSP Ref.
BMW 535i							
3.4 (155 kw)	1987.11-1993.02		Centre	Saloon RWD M30B346KB		Center Bearing Support	510599
	1987.11-1993.02		Front	Saloon RWD M30B346KB		Flexible Coupling	510596
3.5 (173 kw)	1996.06-1998.08	AT/MT	Rear	Saloon RWD M62B358S1		Joint,propshaft	605057
	1996.06-1998.08		Front	Saloon RWD M62B358S1		Flexible Coupling	510596
	1996.06-1998.08		Front	Saloon RWD M62B358S1		Flexible Coupling	537631
	1996.06-1998.08		Front	Saloon RWD M62B358S1		Flexible Coupling Kit	537631S
3.5 (180 kw)	1998.09-2003.06	AT/MT	Rear	Saloon RWD M62B358S2		Joint,propshaft	605057
	1998.09-2003.06		Front	Saloon RWD M62B358S2		Flexible Coupling	510596
	1998.09-2003.06		Front	Saloon RWD M62B358S2		Flexible Coupling Kit	537631S
535i Gran Turismo							
3.0 (225 kw)	2009.09-2017.02		Centre	Hatchback RWD N55B30A		Center Bearing Support	531018
	2009.09-2017.02		Front;Rear	Hatchback RWD N55B30A		Flexible Coupling	517955
	2009.09-2017.02		Front	Hatchback RWD N55B30A		Flexible Coupling Kit	517955S
535i Touring							
3.0 (225 kw)	2010.06-2017.02		Centre	Estate RWD N55B30A		Center Bearing Support	531018
	2010.06-2017.02		Front;Rear	Estate RWD N55B30A		Flexible Coupling	517955
	2010.06-2017.02		Front	Estate RWD N55B30A		Flexible Coupling Kit	517955S
3.0 (240 kw)	2013.07-2017.02		Front;Rear	Estate RWD N55B30A		Flexible Coupling	517955
	2013.07-2017.02		Front	Estate RWD N55B30A		Flexible Coupling Kit	517955S
535i xDrive							
3.0 (225 kw)	2011.03-2016.10		Centre	Saloon 4WD N55B30A		Center Bearing Support	531013
	2011.03-2016.10		Front;Rear	Saloon 4WD N55B30A		Flexible Coupling	517955
	2011.03-2016.10		Front	Saloon 4WD N55B30A		Flexible Coupling Kit	537668S
3.0 (240 kw)	2013.07-2016.10	AT	Front	Saloon 4WD N55B30A		Propshaft	PS900138
	2013.07-2016.10		Front;Rear	Saloon 4WD N55B30A		Flexible Coupling	517955
535i xDrive Gran Turismo							
3.0 (225 kw)	2010.09-2017.02		Centre	Hatchback 4WD N55B30A	Date from-to:2010.10-2011.05;For OE No.26 12 7 564 694	Center Bearing Support	531014
	2010.09-2017.02		Centre	Hatchback 4WD N55B30A	For OE No.26 11 7 589 746	Center Bearing Support	533871
	2010.09-2017.02		Front;Rear	Hatchback 4WD N55B30A		Flexible Coupling	517955
535i xDrive Touring							
3.0 (225 kw)	2011.09-2017.02		Centre	Estate 4WD N55B30A		Center Bearing Support	531013
	2011.09-2017.02		Front;Rear	Estate 4WD N55B30A		Flexible Coupling	517955
	2011.09-2017.02		Front	Estate 4WD N55B30A		Flexible Coupling Kit	517955S
3.0 (240 kw)	2013.07-2017.02		Front;Rear	Estate 4WD N55B30A		Flexible Coupling	517955
	2013.07-2017.02		Front	Estate 4WD N55B30A		Flexible Coupling Kit	517955S
540d xDrive							
3.0 (235 kw)	2017.07-2020.06		Front;Rear	Saloon 4WD B57D30B		Flexible Coupling	517955
540d xDrive Touring							
3.0 (235 kw)	2017.07-2020.06		Front;Rear	Estate 4WD B57D30B		Flexible Coupling	517955
540i							
3.0 (250 kw)	2016.09-2020.06		Front;Rear	Saloon RWD B58B30A		Flexible Coupling	517955
3.0 (265 kw)	2016.09-2020.06		Front;Rear	Saloon RWD B58B30A		Flexible Coupling	517955
4.0 (210 kw)	1992.09-1995.12		Centre	Saloon RWD M60B408S1		Center Bearing Support	512692
	1992.09-1995.12		Front	Saloon RWD M60B408S1		Flexible Coupling	510663
4.0 (220 kw)	2005.09-2007.02	AT	Rear	Saloon RWD N62B40A		Propshaft	PS900130
	2005.09-2007.02		Front	Saloon RWD N62B40A		Flexible Coupling Kit	517955S
	2005.09-2007.02		Front	Saloon RWD N62B40A		Flexible Coupling Kit	530758S
4.0 (225 kw)	2007.03-2009.12	AT	Rear	Saloon RWD N62B40A		Propshaft	PS900130
	2007.03-2009.12		Centre	Saloon RWD N62B40A		Center Bearing Support	513771
	2007.03-2009.12		Centre	Saloon RWD N62B40A		Center Bearing Support	513772
	2007.03-2009.12		Front	Saloon RWD N62B40A		Flexible Coupling	530758
	2007.03-2009.12		Front;Rear	Saloon RWD N62B40A		Flexible Coupling	517955
	2007.03-2009.12		Front	Saloon RWD N62B40A		Flexible Coupling Kit	517955S
	2007.03-2009.12		Front	Saloon RWD N62B40A		Flexible Coupling Kit	530758S
4.4 (210 kw)	1996.03-2003.06		Front	Saloon RWD M62B448S1/M62B448S2		Flexible Coupling	510663
540i Touring							
4.0 (210 kw)	1993.09-1996.07		Centre	Estate RWD M60B408S1		Center Bearing Support	512692
	1993.09-1996.07		Front	Estate RWD M60B408S1		Flexible Coupling	510663
4.4 (210 kw)	1997.04-2003.12		Front	Estate RWD M62B448S1/M62B448S2		Flexible Coupling	510663
540i xDrive							
3.0 (250 kw)	2016.09-2020.06		Front;Rear	Saloon 4WD B58B30A		Flexible Coupling	517955
3.0 (265 kw)	2016.09-2020.06		Front;Rear	Saloon 4WD B58B30A		Flexible Coupling	517955
	2016.09-2020.06		Front	Saloon 4WD B58B30A		Flexible Coupling Kit	517955S



	 YEAR	TRANSM.	FITTING POSITION	BODY STYLE & DRIVE TYPE & ENGINE	REMARKS	 PRODUCT	GSP Ref.
BMW							
540i xDrive Touring							
3.0 (250 kw)	2017.03-2020.06		Front;Rear	Estate 4WD B58B30A		Flexible Coupling	517955
3.0 (265 kw)	2017.03-2020.06		Front;Rear	Estate 4WD B58B30A		Flexible Coupling	517955
545i							
4.4 (245 kw)	2003.09-2005.08		Centre	Saloon RWD N62B44A		Center Bearing Support	513772
	2003.09-2005.08		Front	Saloon RWD N62B44A		Flexible Coupling	517956
	2003.09-2005.08		Front	Saloon RWD N62B44A		Flexible Coupling	530758
	2003.09-2005.08		Front	Saloon RWD N62B44A		Flexible Coupling	537669
	2003.09-2005.08		Front;Rear	Saloon RWD N62B44A		Flexible Coupling	537668
545i Touring							
4.4 (245 kw)	2004.06-2005.08		Centre	Estate RWD N62B44A		Center Bearing Support	513772
	2004.06-2005.08		Front	Estate RWD N62B44A		Flexible Coupling	517956
	2004.06-2005.08		Front	Estate RWD N62B44A		Flexible Coupling	530758
	2004.06-2005.08		Front	Estate RWD N62B44A		Flexible Coupling	537669
	2004.06-2005.08		Front;Rear	Estate RWD N62B44A		Flexible Coupling	537668
550i							
4.4 (300 kw)	2010.03-2013.06		Front;Rear	Saloon RWD N63B44A		Flexible Coupling	537668
4.4 (330 kw)	2013.07-2016.10		Front;Rear	Saloon RWD N63B44B		Flexible Coupling	537668
	2013.07-2016.10		Front	Saloon RWD N63B44B		Flexible Coupling Kit	537668S
4.8 (261 kw)	2005.09-2010.03	AT	Rear	Saloon RWD N62B48B		Propshaft	PS900130
4.8 (270 kw)	2005.09-2009.12	AT	Rear	Saloon RWD N62B48B		Propshaft	PS900130
	2005.09-2009.12		Centre	Saloon RWD N62B48B		Center Bearing Support	513771
	2005.09-2009.12		Centre	Saloon RWD N62B48B		Center Bearing Support	513772
	2005.09-2009.12		Front	Saloon RWD N62B48B		Flexible Coupling	530758
	2005.09-2009.12		Front;Rear	Saloon RWD N62B48B		Flexible Coupling	517955
	2005.09-2009.12		Front	Saloon RWD N62B48B		Flexible Coupling Kit	517955S
	2005.09-2009.12		Front	Saloon RWD N62B48B		Flexible Coupling Kit	530758S
550i Gran Turismo							
4.4 (300 kw)	2009.08-2012.06		Front;Rear	Hatchback RWD N63B44A		Flexible Coupling	537668
	2009.08-2012.06		Front	Hatchback RWD N63B44A		Flexible Coupling Kit	537668S
4.4 (330 kw)	2012.07-2017.02		Front;Rear	Hatchback RWD N63B44B		Flexible Coupling	537668
	2012.07-2017.02		Front	Hatchback RWD N63B44B		Flexible Coupling Kit	537668S
550i Touring							
4.4 (300 kw)	2010.03-2013.06		Front;Rear	Estate RWD N63B44A		Flexible Coupling	537668
	2010.03-2013.06		Front	Estate RWD N63B44A		Flexible Coupling Kit	537668S
4.4 (330 kw)	2013.07-2017.02		Front;Rear	Estate RWD N63B44B		Flexible Coupling	537668
	2013.07-2017.02		Front	Estate RWD N63B44B		Flexible Coupling Kit	537668S
4.8 (270 kw)	2005.06-2011.12	AT	Rear	Estate RWD N62B48B		Propshaft	PS900130
	2005.06-2011.12		Centre	Estate RWD N62B48B		Center Bearing Support	513772
	2005.06-2011.12		Front	Estate RWD N62B48B		Flexible Coupling	530758
	2005.06-2011.12		Front;Rear	Estate RWD N62B48B		Flexible Coupling	517955
	2005.06-2011.12		Front	Estate RWD N62B48B		Flexible Coupling Kit	517955S
	2005.06-2011.12		Front	Estate RWD N62B48B		Flexible Coupling Kit	530758S
550i xDrive							
4.4 (300 kw)	2010.09-2015.09	AT	Front	Saloon 4WD N63B44A		Propshaft	PS900138
	2010.09-2015.09		Front;Rear	Saloon 4WD N63B44A		Flexible Coupling	517955
4.4 (330 kw)	2013.07-2016.10	AT	Front	Saloon 4WD N63B44B		Propshaft	PS900138
	2013.07-2016.10		Front;Rear	Saloon 4WD N63B44B		Flexible Coupling	517955
	2013.07-2016.10		Front	Saloon 4WD N63B44B		Flexible Coupling Kit	517955S
550i xDrive Gran Turismo							
4.4 (300 kw)	2010.06-2012.06		Front;Rear	Hatchback 4WD N63B44A		Flexible Coupling	517955
4.4 (330 kw)	2012.07-2017.02	AT	Front	Hatchback 4WD N63B44B		Propshaft	PS900138
	2012.07-2017.02		Front;Rear	Hatchback 4WD N63B44B		Flexible Coupling	517955
620d Gran Turismo							
2.0 (120 kw)	2018.07-2020.06		Front;Rear	Hatchback RWD B47D20B		Flexible Coupling	517955
2.0 (140 kw)	2018.07-2020.06		Front;Rear	Hatchback RWD B47D20B		Flexible Coupling	517955
620d xDrive Gran Turismo							
2.0 (120 kw)	2018.07-2020.06		Front;Rear	Hatchback 4WD B47D20B		Flexible Coupling	517955
2.0 (140 kw)	2018.07-2020.06		Front;Rear	Hatchback 4WD B47D20B		Flexible Coupling	517955
630d Gran Turismo							
3.0 (155 kw)	2017.06-2020.06		Front;Rear	Hatchback RWD B57D30A		Flexible Coupling	517955
	2017.06-2020.06		Front	Hatchback RWD B57D30A		Flexible Coupling Kit	517955S
3.0 (195 kw)	2017.06-2020.06		Front;Rear	Hatchback RWD B57D30A		Flexible Coupling	517955
	2017.06-2020.06		Front	Hatchback RWD B57D30A		Flexible Coupling Kit	517955S

	 YEAR	TRANSM.	FITTING POSITION	BODY STYLE & DRIVE TYPE & ENGINE	REMARKS	 PRODUCT	GSP Ref.
BMW							
630d xDrive Gran Turismo							
3.0 (155 kw)	2017.06-2020.06		Front;Rear	Hatchback 4WD B57D30A		Flexible Coupling	517955
3.0 (183 kw)	2017.06-2020.06		Front;Rear	Hatchback 4WD B57D30A		Flexible Coupling	517955
3.0 (195 kw)	2017.06-2020.06		Front;Rear	Hatchback 4WD B57D30A		Flexible Coupling	517955
630i Cabrio							
3.0 (190 kw)	2004.09-2007.08		Centre	Cabriolet RWD N52B30A/N52B30B/N52B30BF		Center Bearing Support	513771
	2004.09-2007.08		Centre	Cabriolet RWD N52B30A/N52B30B/N52B30BF		Center Bearing Support	530151
	2004.09-2007.08		Front	Cabriolet RWD N52B30A/N52B30B/N52B30BF		Flexible Coupling	533422
	2004.09-2007.08		Front	Cabriolet RWD N52B30A/N52B30B/N52B30BF		Flexible Coupling Kit	533422S
3.0 (200 kw)	2007.09-2010.08		Centre	Cabriolet RWD N52B30A/N52B30B/N52B30BF/N53B30A		Center Bearing Support	513771
	2007.09-2010.08		Centre	Cabriolet RWD N52B30A/N52B30B/N52B30BF/N53B30A		Center Bearing Support	530151
	2007.09-2010.08		Front	Cabriolet RWD N52B30A/N52B30B/N52B30BF/N53B30A		Flexible Coupling	533422
	2007.09-2010.08		Front	Cabriolet RWD N52B30A/N52B30B/N52B30BF/N53B30A		Flexible Coupling Kit	533422S
630i Coupe							
3.0 (190 kw)	2004.09-2007.08		Centre	Coupe RWD N52B30A/N52B30BF		Center Bearing Support	513771
	2004.09-2007.08		Centre	Coupe RWD N52B30A/N52B30BF		Center Bearing Support	530151
	2004.09-2007.08		Front	Coupe RWD N52B30A/N52B30BF		Flexible Coupling	533422
	2004.09-2007.08		Front	Coupe RWD N52B30A/N52B30BF		Flexible Coupling Kit	533422S
3.0 (200 kw)	2007.09-2010.08		Centre	Coupe RWD N52B30A/N52B30B/N52B30BF/N53B30A		Center Bearing Support	513771
	2007.09-2010.08		Centre	Coupe RWD N52B30A/N52B30B/N52B30BF/N53B30A		Center Bearing Support	530151
	2007.09-2010.08		Front	Coupe RWD N52B30A/N52B30B/N52B30BF/N53B30A		Flexible Coupling	533422
	2007.09-2010.08		Front	Coupe RWD N52B30A/N52B30B/N52B30BF/N53B30A		Flexible Coupling Kit	533422S
630i Gran Turismo							
2.0 (183 kw)	2017.06-2020.06		Front	Hatchback RWD B48B20B		Flexible Coupling	533422
	2017.06-2020.06		Rear	Hatchback RWD B48B20B		Flexible Coupling	537625
2.0 (190 kw)	2017.06-2020.06		Front	Hatchback RWD B48B20B		Flexible Coupling	533422
	2017.06-2020.06		Rear	Hatchback RWD B48B20B		Flexible Coupling	537625
	2017.06-2020.06		Rear	Hatchback RWD B48B20B		Flexible Coupling Kit	537625S
635d Cabrio							
3.0 (210 kw)	2007.03-2010.05		Centre	Cabriolet RWD M57D306D5		Center Bearing Support	513772
	2007.03-2010.05		Front	Cabriolet RWD M57D306D5		Flexible Coupling	530758
	2007.03-2010.05		Front	Cabriolet RWD M57D306D5		Flexible Coupling Kit	530758S
635d Coupe							
3.0 (210 kw)	2007.03-2010.05		Centre	Coupe RWD M57D306D5		Center Bearing Support	513772
	2007.03-2010.05		Front	Coupe RWD M57D306D5		Flexible Coupling	530758
	2007.03-2010.05		Front	Coupe RWD M57D306D5		Flexible Coupling Kit	530758S
640d Cabrio							
3.0 (230 kw)	2011.09-2018.06		Front;Rear	Cabriolet RWD N57D30B		Flexible Coupling	537668
	2011.09-2018.06		Front	Cabriolet RWD N57D30B		Flexible Coupling Kit	537668S
640d Coupe							
3.0 (230 kw)	2011.09-2017.10		Front;Rear	Coupe RWD N57D30B		Flexible Coupling	537668
	2011.09-2017.10		Front	Coupe RWD N57D30B		Flexible Coupling Kit	537668S
640d Gran Coupe							
3.0 (230 kw)	2012.03-2018.10		Front;Rear	Coupe RWD N57D30B		Flexible Coupling	537668
	2012.03-2018.10		Front	Coupe RWD N57D30B		Flexible Coupling Kit	537668S
640d xDrive Cabrio							
3.0 (230 kw)	2012.03-2018.06		Front;Rear	Cabriolet 4WD N57D30B		Flexible Coupling	517955
	2012.03-2018.06		Front	Cabriolet 4WD N57D30B		Flexible Coupling Kit	517955S
640d xDrive Coupe							
3.0 (230 kw)	2012.03-2017.10		Front;Rear	Coupe 4WD N57D30B		Flexible Coupling	517955
	2012.03-2017.10		Front	Coupe 4WD N57D30B		Flexible Coupling Kit	517955S
640d xDrive Gran Coupe							
3.0 (230 kw)	2013.03-2018.10		Front;Rear	Coupe 4WD N57D30B		Flexible Coupling	517955
640d xDrive Gran Turismo							
3.0 (235 kw)	2017.11-2020.06		Front;Rear	Hatchback 4WD B57D30B		Flexible Coupling	517955
640i Cabrio							
3.0 (235 kw)	2011.09-2018.06		Centre	Cabriolet RWD N55B30A		Center Bearing Support	531018
	2011.09-2018.06		Front;Rear	Cabriolet RWD N55B30A		Flexible Coupling	517955
	2011.09-2018.06		Front	Cabriolet RWD N55B30A		Flexible Coupling Kit	517955S
640i Coupe							
3.0 (235 kw)	2011.07-2017.10		Centre	Coupe RWD N55B30A		Center Bearing Support	531018
	2011.07-2017.10		Front;Rear	Coupe RWD N55B30A		Flexible Coupling	517955
	2011.07-2017.10		Front	Coupe RWD N55B30A		Flexible Coupling Kit	517955S

	 YEAR	TRANSM.	FITTING POSITION	BODY STYLE & DRIVE TYPE & ENGINE	REMARKS	 PRODUCT	GSP Ref.
BMW							
640i Gran Coupe							
3.0 (235 kw)	2012.03-2018.10		Front;Rear	Coupe RWD N55B30A		Flexible Coupling	517955
	2012.03-2018.10		Front	Coupe RWD N55B30A		Flexible Coupling Kit	517955S
640i Gran Turismo							
3.0 (250 kw)	2017.06-2020.06		Front;Rear	Hatchback RWD B58B30A/B58B30C		Flexible Coupling	517955
	2017.06-2020.06		Front	Hatchback RWD B58B30A/B58B30C		Flexible Coupling Kit	517955S
3.0 (265 kw)	2017.06-2020.06		Front;Rear	Hatchback RWD B58B30A/B58B30C		Flexible Coupling	517955
	2017.06-2020.06		Front	Hatchback RWD B58B30A/B58B30C		Flexible Coupling Kit	517955S
640i xDrive Cabrio							
3.0 (235 kw)	2013.03-2018.06	AT	Front	Cabriolet 4WD N55B30A		Propshaft	PS900138
	2013.03-2018.06		Centre	Cabriolet 4WD N55B30A		Center Bearing Support	531013
	2013.03-2018.06		Front;Rear	Cabriolet 4WD N55B30A		Flexible Coupling	517955
	2013.03-2018.06		Front	Cabriolet 4WD N55B30A		Flexible Coupling Kit	517955S
640i xDrive Coupe							
3.0 (235 kw)	2013.03-2017.10	AT	Front	Coupe 4WD N55B30A		Propshaft	PS900138
	2013.03-2017.10		Centre	Coupe 4WD N55B30A		Center Bearing Support	531013
	2013.03-2017.10		Front;Rear	Coupe 4WD N55B30A		Flexible Coupling	517955
	2013.03-2017.10		Front	Coupe 4WD N55B30A		Flexible Coupling Kit	517955S
640i xDrive Gran Coupe							
3.0 (235 kw)	2013.03-2018.10	AT	Front	Coupe 4WD N55B30A		Propshaft	PS900138
	2013.03-2018.10		Centre	Coupe 4WD N55B30A		Center Bearing Support	531013
	2013.03-2018.10		Front;Rear	Coupe 4WD N55B30A		Flexible Coupling	517955
640i xDrive Gran Turismo							
3.0 (250 kw)	2017.06-2020.06		Front;Rear	Hatchback 4WD B58B30A/B58B30C		Flexible Coupling	517955
3.0 (265 kw)	2017.06-2020.06		Front;Rear	Hatchback 4WD B58B30A/B58B30C		Flexible Coupling	517955
645i Cabrio							
4.4 (245 kw)	2004.03-2005.07		Centre	Cabriolet RWD N62B44A		Center Bearing Support	513772
	2004.03-2005.07		Front	Cabriolet RWD N62B44A		Flexible Coupling	517956
	2004.03-2005.07		Front	Cabriolet RWD N62B44A		Flexible Coupling	530758
	2004.03-2005.07		Front	Cabriolet RWD N62B44A		Flexible Coupling	537669
645i Coupe							
4.4 (245 kw)	2003.09-2005.08		Centre	Coupe RWD N62B44A		Center Bearing Support	513772
	2003.09-2005.08		Front	Coupe RWD N62B44A		Flexible Coupling	517956
	2003.09-2005.08		Front	Coupe RWD N62B44A		Flexible Coupling	530758
	2003.09-2005.08		Front	Coupe RWD N62B44A		Flexible Coupling	537669
	2003.09-2005.08		Front;Rear	Coupe RWD N62B44A		Flexible Coupling	537668
650i Cabrio							
4.4 (298 kw)	2012.01-2012.12		Front;Rear	Cabriolet RWD N63B44A		Flexible Coupling	537668
4.4 (300 kw)	2010.12-2012.06		Front;Rear	Cabriolet RWD N63B44A		Flexible Coupling	537668
	2010.12-2012.06		Front	Cabriolet RWD N63B44A		Flexible Coupling Kit	537668S
4.4 (330 kw)	2012.07-2018.06		Front;Rear	Cabriolet RWD N63B44B		Flexible Coupling	537668
4.8 (270 kw)	2005.09-2010.08		Centre	Cabriolet RWD N62B48B		Center Bearing Support	513772
	2005.09-2010.08		Front	Cabriolet RWD N62B48B		Flexible Coupling	530758
	2005.09-2010.08		Front;Rear	Cabriolet RWD N62B48B		Flexible Coupling	517955
	2005.09-2010.08		Front	Cabriolet RWD N62B48B		Flexible Coupling Kit	517955S
	2005.09-2010.08		Front	Cabriolet RWD N62B48B		Flexible Coupling Kit	530758S
650i Coupe							
4.4 (298 kw)	2012.01-2012.12		Front;Rear	Coupe RWD N63B44A		Flexible Coupling	537668
4.4 (300 kw)	2011.07-2012.06		Front;Rear	Coupe RWD N63B44A		Flexible Coupling	537668
	2011.07-2012.06		Front	Coupe RWD N63B44A		Flexible Coupling Kit	537668S
4.4 (330 kw)	2012.07-2017.10		Front;Rear	Coupe RWD N63B44B		Flexible Coupling	537668
4.8 (270 kw)	2005.09-2010.08		Centre	Coupe RWD N62B48B		Center Bearing Support	513772
	2005.09-2010.08		Front	Coupe RWD N62B48B		Flexible Coupling	530758
	2005.09-2010.08		Front	Coupe RWD N62B48B		Flexible Coupling	537669
	2005.09-2010.08		Front;Rear	Coupe RWD N62B48B		Flexible Coupling	517955
	2005.09-2010.08		Front	Coupe RWD N62B48B		Flexible Coupling Kit	517955S
	2005.09-2010.08		Front	Coupe RWD N62B48B		Flexible Coupling Kit	530758S
650i Gran Coupe							
4.4 (330 kw)	2012.07-2018.10		Front;Rear	Coupe RWD N63B44B		Flexible Coupling	537668
	2012.07-2018.10		Front	Coupe RWD N63B44B		Flexible Coupling Kit	537668S
650i xDrive Cabrio							
4.4 (300 kw)	2011.09-2012.06		Front;Rear	Cabriolet 4WD N63B44A		Flexible Coupling	517955
	2011.09-2012.06		Front	Cabriolet 4WD N63B44A		Flexible Coupling Kit	517955S
4.4 (330 kw)	2012.07-2018.06		Front;Rear	Cabriolet 4WD N63B44B		Flexible Coupling	517955
	2012.07-2018.06		Front	Cabriolet 4WD N63B44B		Flexible Coupling Kit	517955S



	 YEAR	TRANSM.	FITTING POSITION	BODY STYLE & DRIVE TYPE & ENGINE	REMARKS	 PRODUCT	GSP Ref.
BMW							
650i xDrive Coupe							
4.4 (300 kw)	2011.09-2015.02		Front;Rear	Coupe 4WD N63B44A		Flexible Coupling	517955
	2011.09-2015.02		Front	Coupe 4WD N63B44A		Flexible Coupling Kit	517955S
4.4 (330 kw)	2012.07-2017.10		Front;Rear	Coupe 4WD N63B44B		Flexible Coupling	517955
	2012.07-2017.10		Front	Coupe 4WD N63B44B		Flexible Coupling Kit	517955S
650i xDrive Gran Coupe							
4.4 (330 kw)	2012.07-2018.10		Front;Rear	Coupe 4WD N63B44B		Flexible Coupling	517955
	2012.07-2018.10		Front	Coupe 4WD N63B44B		Flexible Coupling Kit	517955S
7 ActiveHybrid							
3.0 (235 kw)	2012.08-2015.06		Front;Rear	Saloon RWD N55B30A		Flexible Coupling	517955
	2012.08-2015.06		Front	Saloon RWD N55B30A		Flexible Coupling Kit	517955S
725d							
2.0 (155 kw)	2017.07-2019.02		Front;Rear	Saloon RWD B47D20B		Flexible Coupling	517955
2.0 (170 kw)	2015.06-2019.02		Front;Rear	Saloon RWD B47D20B		Flexible Coupling	517955
2.5 (105 kw)	1996.02-2000.05	AT/MT	Rear	Saloon RWD M51D256T1		Joint,propshaft	605057
	1996.02-2000.05		Front	Saloon RWD M51D256T1		Flexible Coupling	537631
	1996.02-2000.05		Front	Saloon RWD M51D256T1		Flexible Coupling Kit	537631S
728i							
2.8 (142 kw)	1995.11-2001.09	AT/MT	Rear	Saloon RWD M52B286S1/M52B286S2		Joint,propshaft	605057
	1995.11-2001.09		Front	Saloon RWD M52B286S1/M52B286S2		Flexible Coupling	510596
730d							
3.0 (135 kw)	1998.05-1999.08		Centre	Saloon RWD M57D306D1		Center Bearing Support	510658
	1998.05-1999.08		Front	Saloon RWD M57D306D1		Flexible Coupling	530160
3.0 (142 kw)	1999.09-2002.05		Centre	Saloon RWD M57D306D1		Center Bearing Support	510658
	1999.09-2002.05		Front	Saloon RWD M57D306D1		Flexible Coupling	530160
3.0 (155 kw)	2009.07-2015.08		Front;Rear	Saloon RWD N57D30A		Flexible Coupling	517955
	2009.07-2015.08		Front	Saloon RWD N57D30A		Flexible Coupling Kit	517955S
	2015.09-2020.06		Front;Rear	Saloon RWD B57D30A		Flexible Coupling	517955
	2015.09-2020.06		Front	Saloon RWD B57D30A		Flexible Coupling Kit	517955S
3.0 (160 kw)	2002.06-2005.02		Centre	Saloon RWD M57D306D2		Center Bearing Support	530153
	2002.06-2005.02		Front	Saloon RWD M57D306D2		Flexible Coupling	530160
3.0 (170 kw)	2005.06-2008.08		Centre	Saloon RWD M57D306D3		Center Bearing Support	530153
	2005.06-2008.08		Front	Saloon RWD M57D306D3		Flexible Coupling	530160
	2005.07-2008.08		Centre	Saloon RWD M57D306D3		Center Bearing Support	530153
	2005.07-2008.08		Front	Saloon RWD M57D306D3		Flexible Coupling	530160
3.0 (180 kw)	2008.09-2012.06		Centre	Saloon RWD N57D30A		Center Bearing Support	531018
	2008.09-2012.06		Front;Rear	Saloon RWD N57D30A		Flexible Coupling	517955
	2008.09-2012.06		Front	Saloon RWD N57D30A		Flexible Coupling Kit	517955S
3.0 (190 kw)	2012.07-2015.08		Front;Rear	Saloon RWD N57D30A		Flexible Coupling	517955
	2012.07-2015.08		Front	Saloon RWD N57D30A		Flexible Coupling Kit	517955S
3.0 (195 kw)	2015.09-2020.06		Front;Rear	Saloon RWD B57D30A		Flexible Coupling	517955
	2015.09-2020.06		Front	Saloon RWD B57D30A		Flexible Coupling Kit	517955S
730d xDrive							
3.0 (155 kw)	2013.06-2015.05		Front;Rear	Saloon 4WD N57D30A		Flexible Coupling	517955
	2015.09-2020.06	AT	Front	Saloon 4WD B57D30A		Propshaft	PS900139
	2015.09-2020.06		Front;Rear	Saloon 4WD B57D30A		Flexible Coupling	517955
3.0 (183 kw)	2015.09-2020.06	AT	Front	Saloon 4WD B57D30A		Propshaft	PS900139
	2015.09-2020.06		Front;Rear	Saloon 4WD B57D30A		Flexible Coupling	517955
3.0 (190 kw)	2012.07-2015.08		Front;Rear	Saloon 4WD N57D30A		Flexible Coupling	517955
	2012.07-2015.08		Front	Saloon 4WD N57D30A		Flexible Coupling Kit	517955S
3.0 (195 kw)	2015.09-2020.06	AT	Front	Saloon 4WD B57D30A		Propshaft	PS900139
	2015.09-2020.06		Front;Rear	Saloon 4WD B57D30A		Flexible Coupling	517955
730i							
2.0 (190 kw)	2015.11-2019.02		Rear	Saloon RWD B48B20B		Flexible Coupling	537625
	2015.11-2019.02		Rear	Saloon RWD B48B20B		Flexible Coupling Kit	537625S
3.0 (138 kw)	1987.03-1994.03		Centre	Saloon RWD M30B306KA		Center Bearing Support	510599
	1987.03-1994.03		Front	Saloon RWD M30B306KA		Flexible Coupling	510596
3.0 (155 kw)	1994.10-2001.11		Front	Saloon RWD M60B308S1		Flexible Coupling	510596
	1994.10-2001.11		Front	Saloon RWD M60B308S1		Flexible Coupling	537631
	1994.10-2001.11		Front	Saloon RWD M60B308S1		Flexible Coupling Kit	537631S
3.0 (160 kw)	1991.03-1994.05		Centre	Saloon RWD M60B308S1		Center Bearing Support	510599
	1991.03-1994.05		Front	Saloon RWD M60B308S1		Flexible Coupling	510596
	1991.03-1994.05		Front	Saloon RWD M60B308S1		Flexible Coupling	537631
	1991.03-1994.05		Front	Saloon RWD M60B308S1		Flexible Coupling Kit	537631S
	1994.03-1996.02		Front	Saloon RWD M60B308S1		Flexible Coupling	510596



	 YEAR	TRANSM.	FITTING POSITION	BODY STYLE & DRIVE TYPE & ENGINE	REMARKS	 PRODUCT	GSP Ref.
BMW							
730i							
3.0 (160 kw)	1994.03-1996.02		Front	Saloon RWD M60B308S1		Flexible Coupling	537631
	1994.03-1996.02		Front	Saloon RWD M60B308S1		Flexible Coupling Kit	537631S
3.0 (170 kw)	2003.03-2005.02		Front	Saloon RWD M54B306S3		Flexible Coupling	530160
	2003.03-2005.02		Front	Saloon RWD M54B306S3		Flexible Coupling	530758
3.0 (190 kw)	2005.03-2008.08		Front	Saloon RWD N52B30A/N52B30BF		Flexible Coupling	530758
	2009.06-2015.06	AT	Rear	Saloon RWD N52B30A/N52B30AF/N52B30BF		Propshaft	PS900147
	2009.06-2015.06		Centre	Saloon RWD N52B30A/N52B30AF/N52B30BF		Center Bearing Support	531018
	2009.06-2015.06		Front;Rear	Saloon RWD N52B30A/N52B30AF/N52B30BF		Flexible Coupling	517955
	2009.06-2015.06		Front	Saloon RWD N52B30A/N52B30AF/N52B30BF		Flexible Coupling Kit	517955S
	2009.09-2015.06	AT	Rear	Saloon RWD N52B30A/N52B30AF/N52B30BF		Propshaft	PS900147
	2009.09-2015.06		Centre	Saloon RWD N52B30A/N52B30AF/N52B30BF		Center Bearing Support	531018
	2009.09-2015.06		Front;Rear	Saloon RWD N52B30A/N52B30AF/N52B30BF		Flexible Coupling	517955
	2009.09-2015.06		Front	Saloon RWD N52B30A/N52B30AF/N52B30BF		Flexible Coupling Kit	517955S
735i							
3.4 (155 kw)	1986.06-1992.06		Centre	Saloon RWD M30B346KB		Center Bearing Support	510599
	1986.06-1992.06		Front	Saloon RWD M30B346KB		Flexible Coupling	510596
3.5 (173 kw)	1996.03-1998.08	AT/MT	Rear	Saloon RWD M62B358S1		Joint,propshaft	605057
	1996.03-1998.08		Centre	Saloon RWD M62B358S1		Center Bearing Support	510658
	1996.03-1998.08		Front	Saloon RWD M62B358S1		Flexible Coupling	510596
	1996.03-1998.08		Front	Saloon RWD M62B358S1		Flexible Coupling	537631
	1996.03-1998.08		Front	Saloon RWD M62B358S1		Flexible Coupling Kit	537631S
3.6 (200 kw)	2001.10-2005.02	AT	Rear	Saloon RWD N62B36A		Propshaft	PS900131
	2001.10-2005.02	AT	Rear	Saloon RWD N62B36A		Propshaft	PS900143
	2001.10-2005.02		Centre	Saloon RWD N62B36A		Center Bearing Support	530153
	2001.10-2005.02		Front	Saloon RWD N62B36A		Flexible Coupling	517956
	2001.10-2005.02		Front	Saloon RWD N62B36A		Flexible Coupling	530160
	2001.10-2005.02		Front	Saloon RWD N62B36A		Flexible Coupling Kit	530160S
	2002.06-2005.02	AT	Rear	Saloon RWD N62B36A		Propshaft	PS900131
	2002.06-2005.02	AT	Rear	Saloon RWD N62B36A		Propshaft	PS900143
	2002.06-2005.02		Centre	Saloon RWD N62B36A		Center Bearing Support	530153
	2002.06-2005.02		Front	Saloon RWD N62B36A		Flexible Coupling	517956
	2002.06-2005.02		Front	Saloon RWD N62B36A		Flexible Coupling	530160
2002.06-2005.02		Front	Saloon RWD N62B36A		Flexible Coupling Kit	530160S	
4.0 (225 kw)	2005.03-2008.08	AT	Rear	Saloon RWD N62B40A		Propshaft	PS900131
740d							
3.0 (225 kw)	2009.09-2012.06		Front;Rear	Saloon RWD N57D30B		Flexible Coupling	537668
	2009.09-2012.06		Front	Saloon RWD N57D30B		Flexible Coupling Kit	537668S
3.0 (230 kw)	2012.07-2015.08		Front;Rear	Saloon RWD N57D30B		Flexible Coupling	537668
	2012.07-2015.08		Front	Saloon RWD N57D30B		Flexible Coupling Kit	537668S
3.9 (180 kw)	1999.02-2002.05		Centre	Saloon RWD M67D398D1		Center Bearing Support	510658
	1999.02-2002.05		Front	Saloon RWD M67D398D1		Flexible Coupling	530160
3.9 (190 kw)	2002.06-2005.02		Centre	Saloon RWD M67D398D1		Center Bearing Support	530153
	2002.06-2005.02		Front	Saloon RWD M67D398D1		Flexible Coupling	537669
740d xDrive							
3.0 (225 kw)	2010.03-2012.06		Front;Rear	Saloon 4WD N57D30B		Flexible Coupling	517955
3.0 (230 kw)	2012.07-2015.08		Front;Rear	Saloon 4WD N57D30B		Flexible Coupling	517955
3.0 (235 kw)	2015.11-2020.06	AT	Front	Saloon 4WD B57D30B		Propshaft	PS900139
	2015.11-2020.06		Front;Rear	Saloon 4WD B57D30B		Flexible Coupling	517955
	2015.11-2020.06		Front	Saloon 4WD B57D30B		Flexible Coupling Kit	517955S
740e							
2.0 (190 kw)	2016.04-2019.02		Front;Rear	Saloon RWD B48B20B		Flexible Coupling	517955
	2016.04-2019.02		Front	Saloon RWD B48B20B		Flexible Coupling Kit	517955S
740i							
3.0 (224 kw)	2010.09-2015.12	AT	Rear	Saloon RWD N54B30A		Propshaft	PS900147
3.0 (235 kw)	2010.09-2015.08		Front;Rear	Saloon RWD N55B30A		Flexible Coupling	517955
	2010.09-2015.08		Front	Saloon RWD N55B30A		Flexible Coupling Kit	517955S
	2012.07-2015.08		Front;Rear	Saloon RWD N55B30A		Flexible Coupling	517955
	2012.07-2015.08		Front	Saloon RWD N55B30A		Flexible Coupling Kit	517955S
3.0 (240 kw)	2008.09-2012.06	AT	Rear	Saloon RWD N54B30A		Propshaft	PS900147
	2008.09-2012.06		Centre	Saloon RWD N54B30A		Center Bearing Support	531018
	2008.09-2012.06		Front;Rear	Saloon RWD N54B30A		Flexible Coupling	517955
	2008.09-2012.06		Front	Saloon RWD N54B30A		Flexible Coupling Kit	517955S
	2015.09-2019.02		Front;Rear	Saloon RWD B58B30A		Flexible Coupling	517955
	2015.09-2019.02		Front	Saloon RWD B58B30A		Flexible Coupling Kit	517955S



	 YEAR	TRANSM.	FITTING POSITION	BODY STYLE & DRIVE TYPE & ENGINE	REMARKS	 PRODUCT	GSP Ref.
BMW							
740i							
4.0 (210 kw)	1992.05-1994.03		Centre	Saloon RWD M60B408S1		Center Bearing Support	512692
	1992.05-1994.03		Front	Saloon RWD M60B408S1		Flexible Coupling	510663
	1994.03-1996.02		Centre	Saloon RWD M60B408S1		Center Bearing Support	510658
	1994.03-1996.02		Front	Saloon RWD M60B408S1		Flexible Coupling	510663
4.0 (225 kw)	2005.03-2008.08	AT	Rear	Saloon RWD N62B40A		Propshaft	PS900143
	2005.03-2008.08		Centre	Saloon RWD N62B40A		Center Bearing Support	530153
	2005.03-2008.08		Front	Saloon RWD N62B40A		Flexible Coupling	530758
4.4 (210 kw)	1996.02-2001.07		Centre	Saloon RWD M62B448S1/M62B448S2		Center Bearing Support	510658
	1996.02-2001.07		Front	Saloon RWD M62B448S1/M62B448S2		Flexible Coupling	510663
740i xDrive							
3.0 (235 kw)	2012.07-2015.08	AT	Front	Saloon 4WD N55B30A		Propshaft	PS900138
	2012.07-2015.08		Front;Rear	Saloon 4WD N55B30A		Flexible Coupling	517955
3.0 (240 kw)	2016.03-		Front;Rear	Saloon 4WD B58B30A		Flexible Coupling	517955
745d							
4.4 (220 kw)	2005.03-2005.07		Centre	Saloon RWD M67D448D1		Center Bearing Support	530153
	2005.03-2005.07		Front	Saloon RWD M67D448D1		Flexible Coupling	537669
4.4 (242 kw)	2005.08-2008.08		Centre	Saloon RWD M67D448D1		Center Bearing Support	530153
	2005.08-2008.08		Front	Saloon RWD M67D448D1		Flexible Coupling	537669
745i							
4.4 (245 kw)	2001.07-2005.03	AT	Rear	Saloon RWD N62B44A		Propshaft	PS900131
	2001.07-2005.03	AT	Rear	Saloon RWD N62B44A		Propshaft	PS900143
	2001.07-2005.03		Centre	Saloon RWD N62B44A		Center Bearing Support	530153
	2001.07-2005.03		Front	Saloon RWD N62B44A		Flexible Coupling	517956
	2001.07-2005.03		Front	Saloon RWD N62B44A		Flexible Coupling	530160
	2001.07-2005.03		Front	Saloon RWD N62B44A		Flexible Coupling Kit	530160S
	2002.01-2005.03	AT	Rear	Saloon RWD N62B44A		Propshaft	PS900131
	2002.01-2005.03	AT	Rear	Saloon RWD N62B44A		Propshaft	PS900143
	2002.01-2005.03		Centre	Saloon RWD N62B44A		Center Bearing Support	530153
	2002.01-2005.03		Front	Saloon RWD N62B44A		Flexible Coupling	517956
	2002.01-2005.03		Front	Saloon RWD N62B44A		Flexible Coupling	530160
2002.01-2005.03		Front	Saloon RWD N62B44A		Flexible Coupling Kit	530160S	
750d xDrive							
3.0 (280 kw)	2012.07-2015.08		Front;Rear	Saloon 4WD N57D30C		Flexible Coupling	517955
	2012.07-2015.08		Front;Rear	Saloon 4WD N57D30C		Flexible Coupling	537668
	2012.07-2015.08		Front	Saloon 4WD N57D30C		Flexible Coupling Kit	537668S
3.0 (294 kw)	2016.07-	AT	Front	Saloon 4WD B57D30C		Propshaft	PS900139
	2016.07-		Front;Rear	Saloon 4WD B57D30C		Flexible Coupling	517955
	2016.07-		Front	Saloon 4WD B57D30C		Flexible Coupling Kit	517955S
750i							
4.4 (300 kw)	2008.09-2012.06		Front;Rear	Saloon RWD N63B44A		Flexible Coupling	537668
	2008.09-2012.06		Front	Saloon RWD N63B44A		Flexible Coupling Kit	537668S
4.4 (330 kw)	2012.07-2015.06		Front;Rear	Saloon RWD N63B44B		Flexible Coupling	537668
	2012.07-2015.06		Front	Saloon RWD N63B44B		Flexible Coupling Kit	537668S
4.4 (331 kw)	2012.07-2015.08		Front	Saloon RWD N63B44B		Flexible Coupling Kit	537668S
4.8 (270 kw)	2005.03-2008.08	AT	Rear	Saloon RWD N62B48B		Propshaft	PS900143
	2005.03-2008.08		Centre	Saloon RWD N62B48B		Center Bearing Support	530153
	2005.03-2008.08		Front	Saloon RWD N62B48B		Flexible Coupling	530758
	2005.03-2008.08		Front	Saloon RWD N62B48B		Flexible Coupling Kit	530758S
5.0 (220 kw)	1987.09-1994.12		Centre	Saloon RWD M70B5012A		Center Bearing Support	512692
5.4 (240 kw)	1994.11-2001.07		Centre	Saloon RWD M73B54121/M73B54122		Center Bearing Support	510658
	1994.11-2001.07		Front	Saloon RWD M73B54121/M73B54122		Flexible Coupling	510663
750i xDrive							
4.4 (300 kw)	2009.09-2012.06	AT	Front	Saloon 4WD N63B44A		Propshaft	PS900138
	2009.09-2012.06		Front;Rear	Saloon 4WD N63B44A		Flexible Coupling	517955
4.4 (330 kw)	2012.07-2015.06	AT	Front	Saloon 4WD N63B44B		Propshaft	PS900138
	2012.07-2015.06		Front	Saloon 4WD N63B44B		Flexible Coupling	537669
	2012.07-2015.06		Front;Rear	Saloon 4WD N63B44B		Flexible Coupling	517955
	2012.07-2015.06		Front	Saloon 4WD N63B44B		Flexible Coupling Kit	537669S
	2015.09-2019.02	AT	Front	Saloon 4WD N63B44C		Propshaft	PS900139
4.4 (390 kw)	2019.03-	AT	Front	Saloon 4WD N63B44D		Propshaft	PS900139
760i							
6.0 (327 kw)	2003.01-2008.08	AT	Rear	Saloon RWD N73B60A/N73B60B		Propshaft	PS900145
	2003.01-2008.08		Centre	Saloon RWD N73B60A/N73B60B		Center Bearing Support	530153
	2003.01-2008.08		Front	Saloon RWD N73B60A/N73B60B		Flexible Coupling	537669



	 YEAR	TRANSM.	FITTING POSITION	BODY STYLE & DRIVE TYPE & ENGINE	REMARKS	 PRODUCT	GSP Ref.
BMW 760i							
6.0 (400 kw)	2009.09-2015.08		Centre	Saloon RWD N74B60A		Center Bearing Support	531018
840d xDrive Cabrio							
3.0 (235 kw)	2018.07-2020.10		Front;Rear	Cabriolet 4WD B57D30B		Flexible Coupling	517955
840d xDrive Coupe							
3.0 (235 kw)	2018.07-2020.10		Front;Rear	Coupe 4WD B57D30B		Flexible Coupling	517955
840d xDrive Gran Coupe							
3.0 (235 kw)	2019.07-2020.10		Front;Rear	Coupe 4WD B57D30B		Flexible Coupling	517955
840i							
4.0 (210 kw)	1993.03-1996.02		Front	Coupe RWD M60B408S1		Flexible Coupling	510663
4.4 (210 kw)	1996.03-1999.06		Front	Coupe RWD M62B448S1		Flexible Coupling	510663
840i Gran Coupe							
3.0 (250 kw)	2019.07-2020.10		Front;Rear	Coupe RWD B58B30C		Flexible Coupling	517955
840i xDrive Gran Coupe							
3.0 (250 kw)	2019.07-2020.10		Front	Coupe 4WD B58B30C		Flexible Coupling	537631
	2019.07-2020.10		Front;Rear	Coupe 4WD B58B30C		Flexible Coupling	517955
M Coupe							
3.0 (250 kw)	2011.03-2012.06		Front;Rear	Coupe RWD N54B30A		Flexible Coupling	517955
	2011.03-2012.06		Front	Coupe RWD N54B30A		Flexible Coupling Kit	517955S
M135i							
3.0 (235 kw)	2011.11-		Front;Rear	Hatchback RWD N55B30A		Flexible Coupling	517955
	2011.11-		Front	Hatchback RWD N55B30A		Flexible Coupling Kit	517955S
	2012.07-2015.02		Front;Rear	Hatchback RWD N55B30A		Flexible Coupling	517955
	2012.07-2015.02		Front	Hatchback RWD N55B30A		Flexible Coupling Kit	517955S
3.0 (240 kw)	2015.03-		Front;Rear	Hatchback RWD N55B30A		Flexible Coupling	517955
	2015.03-		Front	Hatchback RWD N55B30A		Flexible Coupling Kit	517955S
	2015.03-2016.06		Front;Rear	Hatchback RWD N55B30A		Flexible Coupling	517955
	2015.03-2016.06		Front	Hatchback RWD N55B30A		Flexible Coupling Kit	517955S
M135i xDrive							
3.0 (235 kw)	2012.02-		Front;Rear	Hatchback 4WD N55B30A		Flexible Coupling	517955
	2012.11-2015.02		Front;Rear	Hatchback 4WD N55B30A		Flexible Coupling	517955
	2012.11-2015.02		Front	Hatchback 4WD N55B30A		Flexible Coupling Kit	517955S
3.0 (240 kw)	2015.03-		Front;Rear	Hatchback 4WD N55B30A		Flexible Coupling	517955
	2015.03-2016.06		Front;Rear	Hatchback 4WD N55B30A		Flexible Coupling	517955
	2015.03-2016.06		Front	Hatchback 4WD N55B30A		Flexible Coupling Kit	517955S
M140i							
3.0 (250 kw)	2015.10-		Front;Rear	Hatchback RWD B58B30A		Flexible Coupling	517955
	2015.10-		Front	Hatchback RWD B58B30A		Flexible Coupling Kit	517955S
	2016.07-2019.06		Front;Rear	Hatchback RWD B58B30A		Flexible Coupling	517955
	2016.07-2019.06		Front	Hatchback RWD B58B30A		Flexible Coupling Kit	517955S
M140i xDrive							
3.0 (250 kw)	2015.09-		Front;Rear	Hatchback 4WD B58B30A		Flexible Coupling	517955
	2016.07-2019.06		Front;Rear	Hatchback 4WD B58B30A		Flexible Coupling	517955
M235i Cabrio							
3.0 (240 kw)	2014.10-		Front;Rear	Cabriolet RWD N55B30A		Flexible Coupling	517955
	2014.10-		Front	Cabriolet RWD N55B30A		Flexible Coupling Kit	517955S
M235i Coupe							
3.0 (235 kw)	2014.03-		Front	Coupe RWD N55B30A		Flexible Coupling Kit	517955S
3.0 (240 kw)	2013.10-		Front;Rear	Coupe RWD N55B30A		Flexible Coupling	517955
	2013.10-		Front	Coupe RWD N55B30A		Flexible Coupling Kit	517955S
M235i xDrive Coupe							
3.0 (240 kw)	2014.07-		Front;Rear	Coupe 4WD N55B30A		Flexible Coupling	517955
M240i Cabrio							
3.0 (250 kw)	2015.09-		Front;Rear	Cabriolet RWD B58B30A		Flexible Coupling	517955
	2015.09-		Front	Cabriolet RWD B58B30A		Flexible Coupling Kit	517955S
M240i Coupe							
3.0 (250 kw)	2015.09-		Front;Rear	Coupe RWD B58B30A		Flexible Coupling	517955
	2015.09-		Front	Coupe RWD B58B30A		Flexible Coupling Kit	517955S
M240i xDrive Cabrio							
3.0 (250 kw)	2015.09-		Front;Rear	Cabriolet 4WD B58B30A		Flexible Coupling	517955
M240i xDrive Coupe							
3.0 (250 kw)	2015.09-		Front;Rear	Coupe 4WD B58B30A		Flexible Coupling	517955
M340i xDrive							
3.0 (275 kw)	2019.07-	AT	Front	Saloon 4WD B58B30B		Propshaft	PS900139
	2019.07-		Front	Saloon 4WD B58B30B		Flexible Coupling	537631



	 YEAR	TRANSM.	FITTING POSITION	BODY STYLE & DRIVE TYPE & ENGINE	REMARKS	 PRODUCT	GSP Ref.
BMW M340i xDrive							
3.0 (275 kw)	2019.07-		Rear	Saloon 4WD B58B30B		Flexible Coupling	537625
3.0 (285 kw)	2019.03-	AT	Front	Saloon 4WD B58B30B		Propshaft	PS900139
	2019.03-		Front	Saloon 4WD B58B30B		Flexible Coupling	537631
	2019.03-		Rear	Saloon 4WD B58B30B		Flexible Coupling	537625
M340i xDrive Touring							
3.0 (275 kw)	2019.11-	AT	Front	Estate 4WD B58B30B		Propshaft	PS900139
	2019.11-	AT	Front	Combi van 4WD B58B30B		Propshaft	PS900139
	2019.11-		Front	Estate 4WD B58B30B		Flexible Coupling	537631
3.0 (285 kw)	2019.11-	AT	Front	Estate 4WD B58B30B		Propshaft	PS900139
M5							
3.5 (232 kw)	1988.09-1992.03		Centre	Saloon RWD S38B366S1		Center Bearing Support	510599
3.8 (250 kw)	1992.01-1995.07		Centre	Saloon RWD S38B386S1		Center Bearing Support	510599
4.4 (412 kw)	2011.09-2016.10	MT	Rear	Saloon RWD S63B44B		Propshaft	PS900137
4.4 (423 kw)	2013.02-2016.10	MT	Rear	Saloon RWD S63B44B		Propshaft	PS900137
4.4 (441 kw)	2014.07-2016.10	MT	Rear	Saloon RWD S63B44B		Propshaft	PS900137
M5 Touring							
3.8 (250 kw)	1992.04-1995.07		Centre	Estate RWD S38B386S1		Center Bearing Support	510599
M550d xDrive							
3.0 (280 kw)	2012.03-2016.10		Front;Rear	Saloon 4WD N57D30C		Flexible Coupling	517955
	2012.03-2016.10		Front;Rear	Saloon 4WD N57D30C		Flexible Coupling	537668
	2012.03-2016.10		Front	Saloon 4WD N57D30C		Flexible Coupling Kit	517955S
	2012.03-2016.10		Front	Saloon 4WD N57D30C		Flexible Coupling Kit	537668S
3.0 (294 kw)	2017.06-	AT	Front	Saloon 4WD B57D30C		Propshaft	PS900139
	2017.06-		Front;Rear	Saloon 4WD B57D30C		Flexible Coupling	517955
M550d xDrive Touring							
3.0 (280 kw)	2012.01-2017.02		Front;Rear	Estate 4WD N57D30C		Flexible Coupling	517955
	2012.01-2017.02		Front;Rear	Estate 4WD N57D30C		Flexible Coupling	537668
	2012.01-2017.02		Front	Estate 4WD N57D30C		Flexible Coupling Kit	517955S
	2012.01-2017.02		Front	Estate 4WD N57D30C		Flexible Coupling Kit	537668S
3.0 (294 kw)	2017.07-	AT	Front	Estate 4WD B57D30C		Propshaft	PS900139
	2017.07-		Front;Rear	Estate 4WD B57D30C		Flexible Coupling	517955
M550i xDrive							
4.4 (340 kw)	2017.03-2019.06	AT	Front	Saloon 4WD N63B44C		Propshaft	PS900139
	2017.03-2019.06		Front;Rear	Saloon 4WD N63B44C		Flexible Coupling	517955
4.4 (390 kw)	2019.07-	AT	Front	Saloon 4WD N63B44D		Propshaft	PS900139
M6 Gran Coupe							
4.4 (412 kw)	2013.03-2018.10	MT	Rear	Coupe RWD S63B44B		Propshaft	PS900137
4.4 (423 kw)	2013.07-2015.02	MT	Rear	Coupe RWD S63B44B		Propshaft	PS900137
4.4 (441 kw)	2015.03-2018.10	MT	Rear	Coupe RWD S63B44B		Propshaft	PS900137
M760i xDrive							
6.6 (430 kw)	2019.03-	AT	Front	Saloon 4WD N74B66C		Propshaft	PS900139
6.6 (448 kw)	2016.07-2019.02	AT	Front	Saloon 4WD N74B66B		Propshaft	PS900139
M850i xDrive Cabrio							
4.4 (390 kw)	2019.03-	AT	Front	Cabriolet 4WD N63B44D		Propshaft	PS900139
	2019.03-		Front;Rear	Cabriolet 4WD N63B44D		Flexible Coupling	517955
M850i xDrive Coupe							
4.4 (390 kw)	2018.10-	AT	Front	Coupe 4WD N63B44D		Propshaft	PS900139
	2018.10-		Front;Rear	Coupe 4WD N63B44D		Flexible Coupling	517955
M850i xDrive Gran Coupe							
4.4 (390 kw)	2019.07-	AT	Front	Coupe 4WD N63B44D		Propshaft	PS900139
	2019.07-		Front;Rear	Coupe 4WD N63B44D		Flexible Coupling	517955
X1 sDrive 16d							
2.0 (85 kw)	2012.07-2015.06		Centre	SUV RWD N47D20C		Center Bearing Support	530151
	2012.07-2015.06		Front	SUV RWD N47D20C		Flexible Coupling	510596
	2012.07-2015.06		Rear	SUV RWD N47D20C		Flexible Coupling	533878
	2012.07-2015.06		Front	SUV RWD N47D20C		Flexible Coupling Kit	510596S
X1 sDrive 16i							
1.6 (105 kw)	2013.03-2015.06		Front	SUV RWD N20B16A		Flexible Coupling	510596
	2013.03-2015.06		Rear	SUV RWD N20B16A		Flexible Coupling	533878
	2013.03-2015.06		Front	SUV RWD N20B16A		Flexible Coupling Kit	510596S
X1 sDrive 18d							
2.0 (100 kw)	2009.12-2015.06		Front	SUV RWD N47D20C		Flexible Coupling	510596
	2009.12-2015.06		Rear	SUV RWD N47D20C		Flexible Coupling	533878
	2009.12-2015.06		Front	SUV RWD N47D20C		Flexible Coupling Kit	510596S



	 YEAR	TRANSM.	FITTING POSITION	BODY STYLE & DRIVE TYPE & ENGINE	REMARKS	 PRODUCT	GSP Ref.
BMW							
X1 sDrive 18d							
2.0 (105 kw)	2009.12-2015.06		Centre	SUV RWD N47D20C		Center Bearing Support	530151
	2009.12-2015.06		Front	SUV RWD N47D20C		Flexible Coupling	510596
	2009.12-2015.06		Rear	SUV RWD N47D20C		Flexible Coupling	533878
	2009.12-2015.06		Front	SUV RWD N47D20C		Flexible Coupling Kit	510596S
X1 sDrive 18i							
2.0 (100 kw)	2010.03-2015.06	AT	Rear	SUV RWD N46B20B	length=1477MM	Propshaft	PS900125
	2010.03-2015.06	AT	Rear	SUV RWD N46B20B	length=1494MM	Propshaft	PS900162
	2010.03-2015.06		Front	SUV RWD N46B20B		Flexible Coupling	510596
	2010.03-2015.06		Front	SUV RWD N46B20B		Flexible Coupling	510641
	2010.03-2015.06		Front	SUV RWD N46B20B		Flexible Coupling Kit	510596S
	2010.03-2015.06		Rear	SUV RWD N46B20B		Flexible Coupling Kit	537625S
2.0 (110 kw)	2010.03-2015.06	AT	Rear	SUV RWD N46B20B/N46B20BD	length=1477MM	Propshaft	PS900125
	2010.03-2015.06	AT	Rear	SUV RWD N46B20B/N46B20BD	length=1494MM	Propshaft	PS900162
	2010.03-2015.06		Centre	SUV RWD N46B20B/N46B20BD		Center Bearing Support	530151
	2010.03-2015.06		Front	SUV RWD N46B20B/N46B20BD		Flexible Coupling	510596
	2010.03-2015.06		Front	SUV RWD N46B20B/N46B20BD		Flexible Coupling	510641
	2010.03-2015.06		Rear	SUV RWD N46B20B/N46B20BD		Flexible Coupling	537625
	2010.03-2015.06		Front	SUV RWD N46B20B/N46B20BD		Flexible Coupling Kit	510596S
	2010.03-2015.06		Front	SUV RWD N46B20B/N46B20BD		Flexible Coupling Kit	510641S
	2010.03-2015.06		Rear	SUV RWD N46B20B/N46B20BD		Flexible Coupling Kit	537625S
	X1 sDrive 20d						
2.0 (120 kw)	2010.03-2015.06		Centre	SUV RWD N47D20C		Center Bearing Support	530151
	2010.03-2015.06		Front	SUV RWD N47D20C		Flexible Coupling	510596
	2010.03-2015.06		Rear	SUV RWD N47D20C		Flexible Coupling	533878
	2010.03-2015.06		Front;Rear	SUV RWD N47D20C		Flexible Coupling	517955
	2010.03-2015.06		Front	SUV RWD N47D20C		Flexible Coupling Kit	510596S
	2010.03-2015.06		Front	SUV RWD N47D20C		Flexible Coupling Kit	517955S
2.0 (130 kw)	2009.10-2015.06		Centre	SUV RWD N47D20C		Center Bearing Support	530151
	2009.10-2015.06		Front	SUV RWD N47D20C		Flexible Coupling	510596
	2009.10-2015.06		Rear	SUV RWD N47D20C		Flexible Coupling	533878
	2009.10-2015.06		Front;Rear	SUV RWD N47D20C		Flexible Coupling	517955
	2009.10-2015.06		Front	SUV RWD N47D20C		Flexible Coupling Kit	510596S
	2009.10-2015.06		Front	SUV RWD N47D20C		Flexible Coupling Kit	517955S
2.0 (135 kw)	2012.07-2015.06		Centre	SUV RWD N47D20C		Center Bearing Support	530151
	2012.07-2015.06		Front	SUV RWD N47D20C		Flexible Coupling	510596
	2012.07-2015.06		Rear	SUV RWD N47D20C		Flexible Coupling	533878
	2012.07-2015.06		Front;Rear	SUV RWD N47D20C		Flexible Coupling	517955
	2012.07-2015.06		Front	SUV RWD N47D20C		Flexible Coupling Kit	510596S
	2012.07-2015.06		Front	SUV RWD N47D20C		Flexible Coupling Kit	517955S
X1 sDrive 20i							
2.0 (135 kw)	2011.09-2015.06		Centre	SUV RWD N20B20A		Center Bearing Support	530151
	2011.09-2015.06		Front	SUV RWD N20B20A		Flexible Coupling	510596
	2011.09-2015.06		Rear	SUV RWD N20B20A		Flexible Coupling	533878
	2011.09-2015.06		Front	SUV RWD N20B20A		Flexible Coupling Kit	510596S
X1 xDrive 18d							
2.0 (100 kw)	2009.12-2015.06	AT	Front	SUV 4WD N47D20C	Date To:2012.12	Propshaft	PS900124
	2009.12-2015.06	AT	Rear	SUV 4WD N47D20C		Propshaft	PS900123
	2009.12-2015.06		Front	SUV 4WD N47D20C		Flexible Coupling	517956
	2009.12-2015.06		Rear	SUV 4WD N47D20C		Flexible Coupling	533878
	2015.11-		Front	SUV 4WD B47C20A		Flexible Coupling	510597
2.0 (105 kw)	2009.10-2015.06	AT	Front	SUV 4WD N47D20C		Propshaft	PS900124
	2009.10-2015.06	AT	Rear	SUV 4WD N47D20C		Propshaft	PS900123
	2009.10-2015.06		Centre	SUV 4WD N47D20C		Center Bearing Support	530151
	2009.10-2015.06		Front	SUV 4WD N47D20C		Flexible Coupling	517956
	2009.10-2015.06		Rear	SUV 4WD N47D20C		Flexible Coupling	533878
2.0 (110 kw)	2015.11-		Front	SUV 4WD B47C20A/B47C20B		Flexible Coupling	510597
X1 xDrive 20d							
2.0 (120 kw)	2010.03-2015.06	AT	Front	SUV 4WD N47D20C		Propshaft	PS900124
	2010.03-2015.06	AT	Rear	SUV 4WD N47D20C		Propshaft	PS900123
	2010.03-2015.06		Rear	SUV 4WD N47D20C		Flexible Coupling	533878
	2015.11-		Front	SUV 4WD B47C20A/B47C20B		Flexible Coupling	510597
2.0 (130 kw)	2009.10-2012.06	AT	Front	SUV 4WD N47D20C	Date From:2010.01	Propshaft	PS900124
	2009.10-2012.06	AT	Rear	SUV 4WD N47D20C		Propshaft	PS900123
	2009.10-2012.06		Centre	SUV 4WD N47D20C		Center Bearing Support	530151



	 YEAR	TRANSM.	FITTING POSITION	BODY STYLE & DRIVE TYPE & ENGINE	REMARKS	 PRODUCT	GSP Ref.
BMW							
X1 xDrive 20d							
2.0 (130 kw)	2009.10-2012.06		Front	SUV 4WD N47D20C		Flexible Coupling	517956
	2009.10-2012.06		Rear	SUV 4WD N47D20C		Flexible Coupling	533878
2.0 (135 kw)	2012.07-2015.06	AT	Front	SUV 4WD N47D20C		Propshaft	PS900124
	2012.07-2015.06	AT	Rear	SUV 4WD N47D20C		Propshaft	PS900123
	2012.07-2015.06		Centre	SUV 4WD N47D20C		Center Bearing Support	530151
	2012.07-2015.06		Front	SUV 4WD N47D20C		Flexible Coupling	517956
	2012.07-2015.06		Rear	SUV 4WD N47D20C		Flexible Coupling	533878
2.0 (140 kw)	2015.11-		Front	SUV 4WD B47C20A/B47C20B		Flexible Coupling	510597
X1 xDrive 20i							
2.0 (131 kw)	2020.11-		Front	SUV 4WD B48A20A/B48A20F		Flexible Coupling	510597
2.0 (135 kw)	2011.09-2015.06	AT	Front	SUV 4WD N20B20A		Propshaft	PS900124
	2011.09-2015.06	AT	Rear	SUV 4WD N20B20A		Propshaft	PS900123
	2011.09-2015.06		Centre	SUV 4WD N20B20A		Center Bearing Support	530151
	2011.09-2015.06		Front	SUV 4WD N20B20A		Flexible Coupling	517956
	2011.09-2015.06		Rear	SUV 4WD N20B20A		Flexible Coupling	533878
2.0 (141 kw)	2015.07-		Front	SUV 4WD B48A20A/B48A20B/B48A20F		Flexible Coupling	510597
X1 xDrive 23d							
2.0 (150 kw)	2009.09-2015.06	AT	Front	SUV 4WD N47D20D		Propshaft	PS900124
	2009.09-2015.06		Centre	SUV 4WD N47D20D		Center Bearing Support	530151
	2009.09-2015.06		Front	SUV 4WD N47D20D		Flexible Coupling	517956
	2009.09-2015.06		Front;Rear	SUV 4WD N47D20D		Flexible Coupling	517955
X1 xDrive 25d							
2.0 (160 kw)	2012.07-2015.06	AT	Front	SUV 4WD N47D20D		Propshaft	PS900124
	2012.07-2015.06		Centre	SUV 4WD N47D20D		Center Bearing Support	530151
	2012.07-2015.06		Front	SUV 4WD N47D20D		Flexible Coupling	517956
	2012.07-2015.06		Front	SUV 4WD N47D20D		Flexible Coupling Kit	517956S
2.0 (170 kw)	2015.09-		Front	SUV 4WD B47C20B		Flexible Coupling	510597
X1 xDrive 25e							
1.5 (92 kw)	2020.03-		Front	SUV 4WD B38A15A		Flexible Coupling	510597
X1 xDrive 25i							
2.0 (170 kw)	2015.07-		Front	SUV 4WD B46A20B/B48A20B		Flexible Coupling	510597
3.0 (160 kw)	2010.03-2011.08	AT	Front	SUV 4WD N52B30A		Propshaft	PS900124
	2010.03-2011.08		Centre	SUV 4WD N52B30A		Center Bearing Support	530151
X1 xDrive 28i							
2.0 (180 kw)	2011.03-2015.06	AT	Front	SUV 4WD N20B20A		Propshaft	PS900124
	2011.03-2015.06	AT	Rear	SUV 4WD N20B20A		Propshaft	PS900123
	2011.03-2015.06		Centre	SUV 4WD N20B20A		Center Bearing Support	530151
	2011.03-2015.06		Front	SUV 4WD N20B20A		Flexible Coupling	517956
3.0 (190 kw)	2009.09-2011.08	AT	Front	SUV 4WD N52B30A	Date From:2010.01	Propshaft	PS900124
	2009.09-2011.08		Centre	SUV 4WD N52B30A		Center Bearing Support	530151
X2 xDrive 18d							
2.0 (100 kw)	2018.03-		Front	SUV 4WD B47C20B		Flexible Coupling	510597
2.0 (110 kw)	2018.03-		Front	SUV 4WD B47C20B		Flexible Coupling	510597
X2 xDrive 20d							
2.0 (120 kw)	2017.11-		Front	SUV 4WD B47C20A		Flexible Coupling	510597
2.0 (140 kw)	2017.11-		Front	SUV 4WD B47C20A/B47C20B		Flexible Coupling	510597
X2 xDrive 20i							
2.0 (141 kw)	2018.03-2020.10		Front	SUV 4WD B48A20A		Flexible Coupling	510597
X2 xDrive 25d							
2.0 (170 kw)	2017.11-		Front	SUV 4WD B47C20B		Flexible Coupling	510597
X3							
2.0 (110 kw)	2004.09-2007.08	AT/MT	Front	SUV 4WD M47D204D4	Date To:2004.10,Date From:2006.10	Propshaft	PS900122
	2004.09-2007.08	AT/MT	Front	SUV 4WD M47D204D4	Date From:2004.10,Date To:2006.12	Propshaft	PS900153
	2004.09-2007.08		Centre	SUV 4WD M47D204D4		Center Bearing Support	531026
	2004.09-2007.08		Front	SUV 4WD M47D204D4		Flexible Coupling	530160
	2004.09-2007.08		Front	SUV 4WD M47D204D4		Flexible Coupling	537631
	2005.09-2008.08		Centre	SUV 4WD N46B20B		Center Bearing Support	518418
	2005.09-2008.08		Front	SUV 4WD N46B20B		Flexible Coupling	537631
2.0 (130 kw)	2007.09-2008.08	AT/MT	Front	SUV 4WD N47D20A		Propshaft	PS900122
	2007.09-2008.08		Centre	SUV 4WD N47D20A		Center Bearing Support	518418
	2007.09-2008.08		Centre	SUV 4WD N47D20A		Center Bearing Support	531026
	2007.09-2008.08		Front	SUV 4WD N47D20A		Flexible Coupling	530758
2.5 (141 kw)	2004.03-2006.07	AT/MT	Front	SUV 4WD M54B256S5	Date To:2005.12	Propshaft	PS900122
	2004.03-2006.07	AT/MT	Front	SUV 4WD M54B256S5	Date From:2005.12	Propshaft	PS900153



	 YEAR	TRANSM.	FITTING POSITION	BODY STYLE & DRIVE TYPE & ENGINE	REMARKS	 PRODUCT	GSP Ref.
BMW X3							
2.5 (141 kw)	2004.03-2006.07		Centre	SUV 4WD M54B256S5		Center Bearing Support	513771
	2004.03-2006.07		Front	SUV 4WD M54B256S5		Flexible Coupling	537631
2.5 (155 kw)	2006.08-2008.08	AT	Rear	SUV 4WD N52B25A/N52B25AF/N52B25BF		Propshaft	PS900156
	2006.08-2008.08	AT	Rear	SUV 4WD N52B25A/N52B25AF/N52B25BF		Propshaft	PS900157
2.5 (160 kw)	2006.08-2008.08	AT	Rear	SUV 4WD N52B25A/N52B25AF/N52B25BF		Propshaft	PS900156
	2006.08-2008.08	AT	Rear	SUV 4WD N52B25A/N52B25AF/N52B25BF		Propshaft	PS900157
	2006.08-2008.08		Centre	SUV 4WD N52B25A/N52B25AF/N52B25BF		Center Bearing Support	513771
	2006.08-2008.08		Centre	SUV 4WD N52B25A/N52B25AF/N52B25BF		Center Bearing Support	518418
	2006.08-2008.08		Front	SUV 4WD N52B25A/N52B25AF/N52B25BF		Flexible Coupling	530758
3.0 (150 kw)	2003.10-2005.08		Front	SUV 4WD M57D306D2		Propshaft	PS900122
	2003.10-2005.08		Centre	SUV 4WD M57D306D2		Center Bearing Support	513771
	2003.10-2005.08		Front	SUV 4WD M57D306D2		Flexible Coupling	537631
3.0 (160 kw)	2004.10-2008.08	AT	Front	SUV 4WD M57D306D3	Date To:2005.12	Propshaft	PS900122
	2004.10-2008.08	AT	Front	SUV 4WD M57D306D3	Date From:2005.12,Date To:2007.12	Propshaft	PS900153
	2004.10-2008.08		Centre	SUV 4WD M57D306D3		Center Bearing Support	513771
3.0 (168 kw)	2004.01-2006.12	AT	Rear	SUV 4WD M54306S3		Propshaft	PS900157
3.0 (170 kw)	2003.09-2006.07	AT/MT	Front	SUV 4WD M54B306S3	Date From:2004.01,Date To:2005.12	Propshaft	PS900122
	2003.09-2006.07	AT/MT	Front	SUV 4WD M54B306S3	Date From:2005.12	Propshaft	PS900153
	2003.09-2006.07	AT	Rear	SUV 4WD M54B306S3		Propshaft	PS900157
	2003.09-2006.07		Centre	SUV 4WD M54B306S3		Center Bearing Support	513771
	2003.09-2006.07		Front	SUV 4WD M54B306S3		Flexible Coupling	537631
3.0 (194 kw)	2007.01-2008.12		Rear	SUV 4WD N52B30A/N52KB30		Propshaft	PS900157
3.0 (200 kw)	2006.08-2008.08		Front	SUV 4WD N52B30A/N52B30BF		Propshaft	PS900122
	2006.08-2008.08		Rear	SUV 4WD N52B30A/N52B30BF		Propshaft	PS900157
	2006.08-2008.08		Centre	SUV 4WD N52B30A/N52B30BF		Center Bearing Support	513771
	2006.08-2008.08		Centre	SUV 4WD N52B30A/N52B30BF		Center Bearing Support	518418
	2006.08-2008.08		Front	SUV 4WD N52B30A/N52B30BF		Flexible Coupling	530758
3.0 (210 kw)	2006.09-2008.08		-	SUV 4WD M57D306D5		Joint,propshaft	630003
	2006.09-2008.08		Centre	SUV 4WD M57D306D5		Center Bearing Support	513771
	2006.09-2008.08		Centre	SUV 4WD M57D306D5		Center Bearing Support	518418
	2006.09-2008.08		Front	SUV 4WD M57D306D5		Flexible Coupling	530758
X3 M							
3.0 (353 kw)	2019.03-	AT	Front	SUV 4WD S58B30A		Propshaft	PS900139
X3 sDrive 18d							
2.0 (100 kw)	2012.10-2014.03		Centre	SUV RWD N47D20C		Center Bearing Support	531016
	2012.10-2014.03		Front;Rear	SUV RWD N47D20C		Flexible Coupling	517955
	2012.10-2014.03		Front	SUV RWD N47D20C		Flexible Coupling Kit	517955S
	2018.04-2020.06		Front	SUV RWD B47D20A/B47D20B		Flexible Coupling	533422
	2018.04-2020.06		Front;Rear	SUV RWD B47D20A/B47D20B		Flexible Coupling	517955
2.0 (105 kw)	2012.10-2014.03		Centre	SUV RWD N47D20C		Center Bearing Support	531016
	2012.10-2014.03		Front;Rear	SUV RWD N47D20C		Flexible Coupling	517955
	2012.10-2014.03		Front	SUV RWD N47D20C		Flexible Coupling Kit	517955S
2.0 (110 kw)	2014.04-2017.08		Front;Rear	SUV RWD B47D20A		Flexible Coupling	517955
	2014.04-2017.08		Front	SUV RWD B47D20A		Flexible Coupling Kit	517955S
	2018.04-		Front	SUV Van RWD B47D20A/B47D20B		Flexible Coupling	533422
	2018.04-2020.06		Front	SUV RWD B47D20A/B47D20B		Flexible Coupling	533422
	2018.04-2020.06		Front;Rear	SUV RWD B47D20A/B47D20B		Flexible Coupling	517955
X3 sDrive 20i							
1.6 (125 kw)	2014.04-2017.08		Front	SUV RWD N20B16A		Flexible Coupling	510596
	2014.04-2017.08		Rear	SUV RWD N20B16A		Flexible Coupling	533878
	2014.04-2017.08		Front	SUV RWD N20B16A		Flexible Coupling Kit	510596S
	2017.12-		Front	SUV RWD B48B16A		Flexible Coupling	533422
2.0 (135 kw)	2014.04-2017.08		Rear	SUV RWD N20B20A		Propshaft	PS900164
	2014.04-2017.08		Front	SUV RWD N20B20A		Flexible Coupling	510596
	2014.04-2017.08		Rear	SUV RWD N20B20A		Flexible Coupling	533878
	2014.04-2017.08		Front	SUV RWD N20B20A		Flexible Coupling Kit	510596S
	2017.12-		Front	SUV RWD B48B20A		Flexible Coupling	533422
X3 xDrive 18d							
2.0 (105 kw)	2008.09-2011.12	AT/MT	Front	SUV 4WD N47D20C		Propshaft	PS900122
	2008.09-2011.12		Centre	SUV 4WD N47D20C		Center Bearing Support	531026
	2008.09-2011.12		Front	SUV 4WD N47D20C		Flexible Coupling	530758
X3 xDrive 20d							
2.0 (120 kw)	2008.09-2010.08	AT/MT	Front	SUV 4WD N47D20A/N47D20C		Propshaft	PS900122
	2010.09-2014.03	AT/MT	Front	SUV 4WD N47D20C		Propshaft	PS900161



	 YEAR	TRANSM.	FITTING POSITION	BODY STYLE & DRIVE TYPE & ENGINE	REMARKS	 PRODUCT	GSP Ref.
BMW							
X3 xDrive 20d							
2.0 (120 kw)	2010.09-2014.03		Front	SUV 4WD N47D20C		Flexible Coupling	510596
	2017.08-2020.03		Front	SUV 4WD B47D20A/B47D20B		Flexible Coupling	537849
2.0 (130 kw)	2008.09-2010.08	AT/MT	Front	SUV 4WD N47D20A/N47D20C		Propshaft	PS900122
2.0 (135 kw)	2010.09-2014.03		Centre	SUV 4WD N47D20C		Center Bearing Support	530151
	2010.09-2014.03		Front	SUV 4WD N47D20C		Flexible Coupling	510596
	2010.09-2014.03		Front	SUV 4WD N47D20C		Flexible Coupling	537631
2.0 (140 kw)	2014.04-2017.08	AT/MT	Front	SUV 4WD B47D20A		Propshaft	PS900161
	2014.04-2017.08		Front	SUV 4WD B47D20A		Flexible Coupling	510596
	2017.08-		Front	SUV Van 4WD B47D20A/B47D20B		Flexible Coupling	537849
	2017.08-2020.03		Front	SUV 4WD B47D20A/B47D20B		Flexible Coupling	537849
X3 xDrive 20i							
2.0 (110 kw)	2008.09-2011.08		Centre	SUV 4WD N46B20B		Center Bearing Support	518418
	2008.09-2011.08		Front	SUV 4WD N46B20B		Flexible Coupling	537631
2.0 (135 kw)	2011.10-2017.08	AT/MT	Front	SUV 4WD N20B20A		Propshaft	PS900161
	2011.10-2017.08		Rear	SUV 4WD N20B20A		Propshaft	PS900164
	2011.10-2017.08		Front	SUV 4WD N20B20A		Flexible Coupling	510596
	2011.10-2017.08		Front	SUV 4WD N20B20A		Flexible Coupling Kit	510596S
	2017.12-		Front	SUV 4WD B48B20A		Flexible Coupling	537849
X3 xDrive 25d							
2.0 (155 kw)	2018.04-		Front	SUV 4WD B47D20B		Flexible Coupling	537631
2.0 (170 kw)	2018.04-		Front	SUV 4WD B47D20B		Flexible Coupling	537631
X3 xDrive 25i							
2.5 (155 kw)	2008.09-2010.08	AT	Rear	SUV 4WD N52B25A/N52B25AF/N52B25BF		Propshaft	PS900156
2.5 (160 kw)	2008.09-2010.08	AT	Rear	SUV 4WD N52B25A/N52B25AF/N52B25BF		Propshaft	PS900156
X3 xDrive 28i							
2.0 (180 kw)	2012.04-2017.08	AT/MT	Front	SUV 4WD N20B20A		Propshaft	PS900161
	2012.04-2017.08		Rear	SUV 4WD N20B20A		Propshaft	PS900164
	2012.04-2017.08		Front	SUV 4WD N20B20A		Flexible Coupling	510596
3.0 (190 kw)	2011.01-2012.10	AT/MT	Front	SUV 4WD N52B30A/N52B30AF/N52B30BF		Propshaft	PS900161
	2011.01-2012.10		Rear	SUV 4WD N52B30A/N52B30AF/N52B30BF		Propshaft	PS900164
	2011.01-2012.10		Centre	SUV 4WD N52B30A/N52B30AF/N52B30BF		Center Bearing Support	530151
	2011.01-2012.10		Front	SUV 4WD N52B30A/N52B30AF/N52B30BF		Flexible Coupling	510596
X3 xDrive 30d							
3.0 (155 kw)	2008.09-2011.04	MT	Front	SUV 4WD M57D306D3		Propshaft	PS900153
	2008.09-2011.04		-	SUV 4WD M57D306D3		Joint,propshaft	630003
	2011.04-2017.08	AT/MT	Front	SUV 4WD N57D30A		Propshaft	PS900161
3.0 (160 kw)	2008.09-2011.04	MT	Front	SUV 4WD M57D306D3		Propshaft	PS900153
	2008.09-2011.04		Rear	SUV 4WD M57D306D3		Joint,propshaft	630003
	2008.09-2011.04		Centre	SUV 4WD M57D306D3		Center Bearing Support	513771
	2008.09-2011.04		Front	SUV 4WD M57D306D3		Flexible Coupling	537631
3.0 (183 kw)	2011.06-2017.08	AT/MT	Front	SUV 4WD N57D30A		Propshaft	PS900161
	2018.04-2020.06		Front;Rear	SUV 4WD B57D30A		Flexible Coupling	517955
3.0 (190 kw)	2011.04-2017.08	AT/MT	Front	SUV 4WD N57D30A	Total Length:733mm	Propshaft	PS900161
	2011.04-2017.08		Front	SUV 4WD N57D30A		Flexible Coupling	537631
3.0 (195 kw)	2017.07-2020.06		Front;Rear	SUV 4WD B57D30A		Flexible Coupling	517955
3.0 (210 kw)	2011.04-2016.05	AT/MT	Front	SUV 4WD N57D30A		Propshaft	PS900161
X3 xDrive 30i							
2.0 (183 kw)	2017.08-		Front	SUV 4WD B48B20B		Flexible Coupling	537849
2.0 (185 kw)	2017.08-		Front	SUV 4WD B48B20B		Flexible Coupling	537849
X3 xDrive 35d							
3.0 (210 kw)	2008.09-2011.08	MT	Front	SUV 4WD M57D306D5		Propshaft	PS900153
3.0 (230 kw)	2011.10-2017.08	AT/MT	Front	SUV 4WD N57D30B	Total Length:733mm	Propshaft	PS900161
	2011.10-2017.08		Front	SUV 4WD N57D30B		Flexible Coupling	537631
X3 xDrive 35i							
3.0 (225 kw)	2010.09-2017.08	AT/MT	Front	SUV 4WD N55B30A		Propshaft	PS900161
	2010.09-2017.08		Rear	SUV 4WD N55B30A		Propshaft	PS900164
	2010.09-2017.08		Centre	SUV 4WD N55B30A		Center Bearing Support	530151
	2010.09-2017.08		Front	SUV 4WD N55B30A		Flexible Coupling	510596
X3 xDrive M40i							
3.0 (260 kw)	2018.09-2019.08		Front	SUV 4WD B58B30A		Flexible Coupling	537849
3.0 (265 kw)	2017.08-		Front	SUV 4WD B58B30A		Flexible Coupling	537849
X4 M							
3.0 (353 kw)	2019.03-	AT	Front	SUV 4WD S58B30A		Propshaft	PS900139

	 YEAR	TRANSM.	FITTING POSITION	BODY STYLE & DRIVE TYPE & ENGINE	REMARKS	 PRODUCT	GSP Ref.
BMW							
X4 xDrive 20d							
2.0 (120 kw)	2014.04-2018.03		Front	SUV 4WD B47D20A		Flexible Coupling	510596
	2018.04-2020.08		Front	SUV 4WD B47D20A/B47D20B		Flexible Coupling	537631
2.0 (140 kw)	2014.04-2018.03	AT/MT	Front	SUV 4WD B47D20A		Propshaft	PS900161
	2014.04-2018.03		Rear	SUV 4WD B47D20A		Propshaft	PS900164
	2014.04-2018.03		Front	SUV 4WD B47D20A		Flexible Coupling	510596
	2018.04-2020.08		Front	SUV 4WD B47D20A/B47D20B	For OE No.26111229080	Flexible Coupling	537631
	2018.04-2020.08		Front	SUV 4WD B47D20A/B47D20B	For OE No. 26118487178	Flexible Coupling	537849
X4 xDrive 20i							
2.0 (135 kw)	2014.04-2018.03	AT/MT	Front	SUV 4WD N20B20A		Propshaft	PS900161
	2014.04-2018.03		Rear	SUV 4WD N20B20A		Propshaft	PS900164
	2014.04-2018.03		Front	SUV 4WD N20B20A		Flexible Coupling	510596
	2018.04-		Front	SUV 4WD B48B20A		Flexible Coupling	537849
X4 xDrive 25d							
2.0 (155 kw)	2018.04-		Front	SUV 4WD B47D20B		Flexible Coupling	537631
2.0 (170 kw)	2018.04-		Front	SUV 4WD B47D20B		Flexible Coupling	537631
X4 xDrive 28i							
2.0 (180 kw)	2014.04-2018.03	AT/MT	Front	SUV 4WD N20B20A		Propshaft	PS900161
	2014.04-2018.03		Rear	SUV 4WD N20B20A		Propshaft	PS900164
	2014.04-2018.03		Front	SUV 4WD N20B20A		Flexible Coupling	510596
X4 xDrive 30d							
3.0 (155 kw)	2014.04-2018.03	AT/MT	Front	SUV 4WD N57D30A		Propshaft	PS900161
3.0 (183 kw)	2015.04-2018.03	AT/MT	Front	SUV 4WD N57D30A		Propshaft	PS900161
	2018.09-2020.06		Front	SUV 4WD B57D30A		Flexible Coupling	537631
	2018.09-2020.06		Front;Rear	SUV 4WD B57D30A		Flexible Coupling	517955
3.0 (190 kw)	2014.04-2018.03	AT/MT	Front	SUV 4WD N57D30A	Total Length:733mm	Propshaft	PS900161
	2014.04-2018.03		Front	SUV 4WD N57D30A		Flexible Coupling	537631
3.0 (195 kw)	2018.04-2020.06		Front	SUV 4WD B57D30A		Flexible Coupling	537631
	2018.04-2020.06		Front;Rear	SUV 4WD B57D30A		Flexible Coupling	517955
3.0 (210 kw)	2014.04-2018.03	AT/MT	Front	SUV 4WD N57D30A		Propshaft	PS900161
X4 xDrive 30i							
2.0 (183 kw)	2018.04-		Front	SUV 4WD B48B20B		Flexible Coupling	537849
2.0 (185 kw)	2018.04-		Front	SUV 4WD B48B20B		Flexible Coupling	537849
X4 xDrive 35d							
3.0 (230 kw)	2014.04-2018.03	AT/MT	Front	SUV 4WD N57D30B		Propshaft	PS900161
	2014.04-2018.03		Front	SUV 4WD N57D30B		Flexible Coupling	537631
X4 xDrive 35i							
3.0 (225 kw)	2014.04-2018.03	AT/MT	Front	SUV 4WD N55B30A		Propshaft	PS900161
	2014.04-2018.03		Rear	SUV 4WD N55B30A		Propshaft	PS900164
	2014.04-2018.03		Front	SUV 4WD N55B30A		Flexible Coupling	510596
X4 xDrive M40d							
3.0 (240 kw)	2018.04-2020.06		Front	SUV 4WD B57D30B		Flexible Coupling	537631
	2018.04-2020.06		Front;Rear	SUV 4WD B57D30B		Flexible Coupling	517955
X4 xDrive M40i							
3.0 (260 kw)	2018.04-2019.08		Front	SUV 4WD B58B30A		Flexible Coupling	537849
3.0 (265 kw)	2015.12-2018.03		Rear	SUV 4WD N55B30A		Propshaft	PS900164
	2015.12-2018.03		Front	SUV 4WD N55B30A		Flexible Coupling	510596
	2015.12-2018.03		Front	SUV 4WD N55B30A		Flexible Coupling Kit	510596S
X5							
3.0 (135 kw)	2001.03-2003.09	5AT	Front	SUV 4WD M57D306D1		Propshaft	PS900149
	2001.03-2003.09		Centre	SUV 4WD M57D306D1		Center Bearing Support	514792
	2001.03-2003.09		Front	SUV 4WD M57D306D1		Flexible Coupling	510596
	2001.03-2003.09		Front	SUV 4WD M57D306D1		Flexible Coupling	510641
	2001.03-2003.09		Front	SUV 4WD M57D306D1		Flexible Coupling Kit	510596S
	2001.03-2003.09		Front	SUV 4WD M57D306D1		Flexible Coupling Kit	537798S
3.0 (155 kw)	2003.09-2006.12	AT	Rear	SUV 4WD M57D306D2		Propshaft	PS900152
	2003.09-2006.12	AT/MT	Rear	SUV 4WD M57D306D2		Joint,propshaft	605057
	2003.09-2006.12		Front	SUV 4WD M57D306D2		Flexible Coupling	537631
	2003.09-2006.12		Front	SUV 4WD M57D306D2		Flexible Coupling Kit	537631S
	2006.12-2008.09	AT	Front	SUV 4WD M57D306D3		Propshaft	PS900159
	2006.12-2008.09	AT	Rear	SUV 4WD M57D306D3	Date From:2009.09	Propshaft	PS900166
3.0 (160 kw)	2006.12-2008.09		Front	SUV 4WD M57D306D3		Flexible Coupling	510596
	2003.12-2006.12	AT/MT	Front	SUV 4WD M57D306D2		Propshaft	PS900150
	2003.12-2006.12	AT	Rear	SUV 4WD M57D306D2		Propshaft	PS900152
	2003.12-2006.12	AT/MT	Rear	SUV 4WD M57D306D2		Joint,propshaft	605057



	 YEAR	TRANSM.	FITTING POSITION	BODY STYLE & DRIVE TYPE & ENGINE	REMARKS	 PRODUCT	GSP Ref.
BMW X5							
3.0 (160 kw)	2003.12-2006.12		Centre	SUV 4WD M57D306D2		Center Bearing Support	514792
	2003.12-2006.12		Front	SUV 4WD M57D306D2		Flexible Coupling	510641
	2003.12-2006.12		Front	SUV 4WD M57D306D2		Flexible Coupling	537631
	2003.12-2006.12		Front	SUV 4WD M57D306D2		Flexible Coupling Kit	537631S
	2003.12-2006.12		Front	SUV 4WD M57D306D2		Flexible Coupling Kit	537798S
3.0 (168 kw)	2000.06-2006.12		Front	SUV AWD M54 B30(306S3)		Flexible Coupling Kit	537798S
3.0 (170 kw)	2000.04-2006.10	AT/MT	Front	SUV 4WD M54B306S3		Propshaft	PS900149
	2000.04-2006.10	AT	Rear	SUV 4WD M54B306S3		Propshaft	PS900152
	2000.04-2006.10	AT/MT	Rear	SUV 4WD M54B306S3		Joint,propshaft	605057
	2000.04-2006.10		Centre	SUV 4WD M54B306S3		Center Bearing Support	514792
	2000.04-2006.10		Front	SUV 4WD M54B306S3		Flexible Coupling	510596
	2000.04-2006.10		Front	SUV 4WD M54B306S3		Flexible Coupling	510641
	2000.04-2006.10		Front	SUV 4WD M54B306S3		Flexible Coupling	537631
	2000.04-2006.10		Front	SUV 4WD M54B306S3		Flexible Coupling Kit	510596S
	2000.04-2006.10		Front	SUV 4WD M54B306S3		Flexible Coupling Kit	537631S
	2000.04-2006.10		Front	SUV 4WD M54B306S3		Flexible Coupling Kit	537798S
3.0 (173 kw)	2007.02-2008.09	AT	Front	SUV 4WD M57D306D3		Propshaft	PS900159
	2007.02-2008.09	AT	Rear	SUV 4WD M57D306D3	Date From:2009.09	Propshaft	PS900166
	2007.02-2008.09		Centre	SUV 4WD M57D306D3		Center Bearing Support	530151
	2007.02-2008.09		Front	SUV 4WD M57D306D3		Flexible Coupling	510596
	2007.02-2008.09		Front	SUV 4WD M57D306D3		Flexible Coupling	510641
	2007.02-2008.09		Front	SUV 4WD M57D306D3		Flexible Coupling	537631
	2007.02-2008.09		Front	SUV 4WD M57D306D3		Flexible Coupling Kit	510596S
	2007.02-2008.09		Front	SUV 4WD M57D306D3		Flexible Coupling Kit	537631S
3.0 (200 kw)	2006.10-2008.09		Centre	SUV 4WD N52B30A/N52B30AF/N52B30BF		Center Bearing Support	530151
	2006.10-2008.09		Front	SUV 4WD N52B30A/N52B30AF/N52B30BF		Flexible Coupling	510596
	2006.10-2008.09		Front	SUV 4WD N52B30A/N52B30AF/N52B30BF		Flexible Coupling	510641
	2006.10-2008.09		Front	SUV 4WD N52B30A/N52B30AF/N52B30BF		Flexible Coupling Kit	510596S
3.0 (210 kw)	2007.10-2008.09	AT	Rear	SUV 4WD M57D306D5	Date From:2009.09	Propshaft	PS900166
	2007.10-2008.09		Centre	SUV 4WD M57D306D5		Center Bearing Support	530151
	2007.10-2008.09		Front	SUV 4WD M57D306D5		Flexible Coupling	510641
	2007.10-2008.09		Front	SUV 4WD M57D306D5		Flexible Coupling	537631
4.4 (210 kw)	2000.01-2003.09	5AT	Front	SUV 4WD M62B448S2		Propshaft	PS900149
	2000.01-2003.09	AT/MT	Rear	SUV 4WD M62B448S2		Joint,propshaft	605057
	2000.01-2003.09		Centre	SUV 4WD M62B448S2		Center Bearing Support	514792
	2000.01-2003.09		Front	SUV 4WD M62B448S2		Flexible Coupling	510596
	2000.01-2003.09		Front	SUV 4WD M62B448S2		Flexible Coupling	510641
	2000.01-2003.09		Front	SUV 4WD M62B448S2		Flexible Coupling	537631
	2000.01-2003.09		Front	SUV 4WD M62B448S2		Flexible Coupling Kit	510596S
	2000.01-2003.09		Front	SUV 4WD M62B448S2		Flexible Coupling Kit	537798S
4.4 (235 kw)	2003.10-2006.10	AT/MT	Front	SUV 4WD N62B44A		Propshaft	PS900150
	2003.10-2006.10	AT	Rear	SUV 4WD N62B44A		Propshaft	PS900152
	2003.10-2006.10	AT/MT	Rear	SUV 4WD N62B44A		Joint,propshaft	605057
	2003.10-2006.10		Centre	SUV 4WD N62B44A		Center Bearing Support	514792
	2003.10-2006.10		Front	SUV 4WD N62B44A		Flexible Coupling	510641
	2003.10-2006.10		Front	SUV 4WD N62B44A		Flexible Coupling	537631
	2003.10-2006.10		Front	SUV 4WD N62B44A		Flexible Coupling Kit	537631S
	2003.10-2006.10		Front	SUV 4WD N62B44A		Flexible Coupling Kit	537798S
4.6 (255 kw)	2001.10-2003.09	5AT	Front	SUV 4WD M62B468S1		Propshaft	PS900149
	2001.10-2003.09	AT/MT	Rear	SUV 4WD M62B468S1		Joint,propshaft	605057
	2001.10-2003.09		Centre	SUV 4WD M62B468S1		Center Bearing Support	514792
	2001.10-2003.09		Front	SUV 4WD M62B468S1		Flexible Coupling	510596
	2001.10-2003.09		Front	SUV 4WD M62B468S1		Flexible Coupling	510641
	2001.10-2003.09		Front	SUV 4WD M62B468S1		Flexible Coupling Kit	510596S
4.8 (261 kw)	2006.10-2008.09	AT	Front	SUV 4WD N62B48B		Propshaft	PS900158
	2006.10-2008.09	AT	Rear	SUV 4WD N62B48B	Date From:2009.09	Propshaft	PS900166
	2006.10-2008.09		Centre	SUV 4WD N62B48B		Center Bearing Support	530151
	2006.10-2008.09		Front	SUV 4WD N62B48B		Flexible Coupling	510596
	2006.10-2008.09		Front	SUV 4WD N62B48B		Flexible Coupling	537631
	2006.10-2008.09		Front	SUV 4WD N62B48B		Flexible Coupling Kit	510596S
	2006.10-2008.09		Front	SUV 4WD N62B48B		Flexible Coupling Kit	537631S

	 YEAR	TRANSM.	FITTING POSITION	BODY STYLE & DRIVE TYPE & ENGINE	REMARKS	 PRODUCT	GSP Ref.
BMW X5							
4.8 (265 kw)	2004.04-2006.09	AT/MT	Front	SUV 4WD N62B48A		Propshaft	PS900150
	2004.04-2006.09	AT/MT	Rear	SUV 4WD N62B48A		Joint,propshaft	605057
	2004.04-2006.09		Centre	SUV 4WD N62B48A		Center Bearing Support	514792
	2004.04-2006.09		Front	SUV 4WD N62B48A		Flexible Coupling	510641
	2004.04-2006.09		Front	SUV 4WD N62B48A		Flexible Coupling	537631
	2004.04-2006.09		Front	SUV 4WD N62B48A		Flexible Coupling Kit	537631S
2004.04-2006.09		Front	SUV 4WD N62B48A		Flexible Coupling Kit	537798S	
X5 M							
4.4 (408 kw)	2009.07-2013.07	AT	Front	SUV 4WD S63B44A	Date To:2010.04	Propshaft	PS900158
	2009.07-2013.07	AT	Front	SUV 4WD S63B44A	Date From:2010.05	Propshaft	PS900159
	2009.07-2013.07	AT	Rear	SUV 4WD S63B44A		Propshaft	PS900166
	2009.07-2013.07		Centre	SUV 4WD S63B44A		Center Bearing Support	530151
	2009.07-2013.07		Front	SUV 4WD S63B44A		Flexible Coupling	537631
4.4 (414 kw)	2010.01-2013.10	AT	Front	SUV 4WD S63B44A		Propshaft	PS900158
X5 M50i xDrive							
4.4 (390 kw)	2019.08-	AT	Front	SUV 4WD N63B44D		Propshaft	PS900139
X5 sDrive 25d							
2.0 (155 kw)	2013.12-2015.07		Centre	SUV RWD N47D20D		Center Bearing Support	531016
	2013.12-2015.07		Front;Rear	SUV RWD N47D20D		Flexible Coupling	517955
	2013.12-2015.07		Front	SUV RWD N47D20D		Flexible Coupling Kit	517955S
2.0 (160 kw)	2013.12-2015.07		Centre	SUV RWD N47D20D		Center Bearing Support	531016
	2013.12-2015.07		Front;Rear	SUV RWD N47D20D		Flexible Coupling	517955
	2013.12-2015.07		Front	SUV RWD N47D20D		Flexible Coupling Kit	517955S
2.0 (170 kw)	2015.08-2018.07		Front;Rear	SUV RWD B47D20B		Flexible Coupling	517955
	2015.08-2018.07		Front	SUV RWD B47D20B		Flexible Coupling Kit	517955S
X5 sDrive 35i							
3.0 (225 kw)	2013.08-2018.07		Front	SUV RWD N55B30A		Flexible Coupling Kit	517955S
X5 xDrive 25d							
2.0 (155 kw)	2013.12-2015.07		Centre	SUV 4WD N47D20D		Center Bearing Support	530151
	2013.12-2015.07		Front	SUV 4WD N47D20D		Flexible Coupling	510596
	2019.08-	AT	Front	SUV 4WD B47D20B		Propshaft	PS900139
2.0 (160 kw)	2013.12-2015.07		Centre	SUV 4WD N47D20D		Center Bearing Support	530151
	2013.12-2015.07		Front	SUV 4WD N47D20D		Flexible Coupling	510596
	2013.12-2015.07		Front	SUV 4WD N47D20D		Flexible Coupling Kit	510596S
2.0 (170 kw)	2015.08-2018.07	AT	Rear	SUV 4WD B47D20B		Propshaft	PS900160
	2015.08-2018.07		Front	SUV 4WD B47D20B		Flexible Coupling	510596
	2019.08-	AT	Front	SUV 4WD B47D20B		Propshaft	PS900139
X5 xDrive 30d							
3.0 (155 kw)	2008.10-2013.07	AT	Front	SUV 4WD M57D306D3/N57D30A		Propshaft	PS900159
	2008.10-2013.07	AT	Rear	SUV 4WD M57D306D3/N57D30A	For vehicles with increased towing capability	Propshaft	PS900160
	2008.10-2013.07	AT	Rear	SUV 4WD M57D306D3/N57D30A	For vehicles with increased towing capability or Adaptive suspension package Dynamic	Propshaft	PS900168
	2008.10-2013.07		Front	SUV 4WD M57D306D3/N57D30A		Flexible Coupling	510596
3.0 (173 kw)	2008.10-2010.03	AT	Front	SUV 4WD M57D306D3		Propshaft	PS900159
	2008.10-2010.03	AT	Rear	SUV 4WD M57D306D3	For vehicles with increased towing capability	Propshaft	PS900160
	2008.10-2010.03	AT	Rear	SUV 4WD M57D306D3	Date From:2009.09	Propshaft	PS900166
	2008.10-2010.03		Centre	SUV 4WD M57D306D3		Center Bearing Support	530151
	2008.10-2010.03		Front	SUV 4WD M57D306D3		Flexible Coupling	510596
	2008.10-2010.03		Front	SUV 4WD M57D306D3		Flexible Coupling	510596
3.0 (180 kw)	2010.04-2013.07	AT	Front	SUV 4WD N57D30A		Propshaft	PS900159
	2010.04-2013.07	AT	Rear	SUV 4WD N57D30A	For vehicles with increased towing capability	Propshaft	PS900160
	2010.04-2013.07	AT	Rear	SUV 4WD N57D30A	For vehicles with increased towing capability or Adaptive suspension package Dynamic	Propshaft	PS900168
	2010.04-2013.07		Centre	SUV 4WD N57D30A		Center Bearing Support	530151
	2010.04-2013.07		Front	SUV 4WD N57D30A		Flexible Coupling	510596
	2010.04-2013.07		Front	SUV 4WD N57D30A		Flexible Coupling	537631
3.0 (183 kw)	2013.12-2018.07	AT	Rear	SUV 4WD N57D30A	For vehicles with increased towing capability	Propshaft	PS900160
	2013.12-2018.07	AT	Rear	SUV 4WD N57D30A	For vehicles with increased towing capability or Adaptive suspension package Dynamic	Propshaft	PS900168
	2013.12-2018.07		Front	SUV 4WD N57D30A		Flexible Coupling	510596
	2018.08-2020.07	AT	Front	SUV 4WD B57D30A		Propshaft	PS900139
	2018.08-2020.07		Front;Rear	SUV 4WD B57D30A		Flexible Coupling	517955
3.0 (190 kw)	2013.08-2018.07	AT	Rear	SUV 4WD N57D30A	For vehicles with increased towing capability	Propshaft	PS900160
	2013.08-2018.07	AT	Rear	SUV 4WD N57D30A	For vehicles with increased towing capability or Adaptive suspension package Dynamic	Propshaft	PS900168
	2013.08-2018.07		Centre	SUV 4WD N57D30A		Center Bearing Support	530151
	2013.08-2018.07		Front	SUV 4WD N57D30A		Flexible Coupling	510596
	2013.08-2018.07		Front	SUV 4WD N57D30A		Flexible Coupling	537631



	 YEAR	TRANSM.	FITTING POSITION	BODY STYLE & DRIVE TYPE & ENGINE	REMARKS	 PRODUCT	GSP Ref.
BMW							
X5 xDrive 30d							
3.0 (195 kw)	2018.08-2020.07	AT	Front	SUV 4WD B57D30A		Propshaft	PS900139
	2018.08-2020.07		Front;Rear	SUV 4WD B57D30A		Flexible Coupling	517955
	2019.11-	AT	Front	SUV Van 4WD B57D30A		Propshaft	PS900139
3.0 (204 kw)	2013.08-2018.07	AT	Rear	SUV 4WD N57D30A	For vehicles with increased towing capability	Propshaft	PS900160
	2013.08-2018.07	AT	Rear	SUV 4WD N57D30A	For vehicles with increased towing capability or Adaptive suspension package Dynamic	Propshaft	PS900168
	2013.08-2018.07		Front	SUV 4WD N57D30A		Flexible Coupling	510596
3.0 (210 kw)	2013.08-2018.07	AT	Rear	SUV 4WD N57D30A	For vehicles with increased towing capability	Propshaft	PS900160
	2013.08-2018.07	AT	Rear	SUV 4WD N57D30A	For vehicles with increased towing capability or Adaptive suspension package Dynamic	Propshaft	PS900168
	2013.08-2018.07		Front	SUV 4WD N57D30A		Flexible Coupling	510596
X5 xDrive 30i							
3.0 (200 kw)	2008.10-2010.03		Front	SUV 4WD N52B30A		Propshaft	PS900155
	2008.10-2010.03		Centre	SUV 4WD N52B30A		Center Bearing Support	530151
	2008.10-2010.03		Front	SUV 4WD N52B30A		Flexible Coupling	510596
X5 xDrive 35d							
3.0 (210 kw)	2008.10-2010.03		Front	SUV 4WD M57D306D5		Propshaft	PS900155
	2008.10-2010.03	AT	Rear	SUV 4WD M57D306D5	Date From:2009.09	Propshaft	PS900166
X5 xDrive 35i							
3.0 (225 kw)	2010.04-2013.07	AT	Rear	SUV 4WD N55B30A	For vehicles with increased towing capability	Propshaft	PS900160
	2010.04-2013.07	AT	Rear	SUV 4WD N55B30A	For vehicles with increased towing capability or Adaptive suspension package Dynamic	Propshaft	PS900168
	2010.04-2013.07		Centre	SUV 4WD N55B30A		Center Bearing Support	530151
	2010.04-2013.07		Front	SUV 4WD N55B30A		Flexible Coupling	510596
	2010.04-2013.07		Front	SUV 4WD N55B30A		Flexible Coupling	537631
	2013.12-2018.07	AT	Rear	SUV 4WD N55B30A	For vehicles with increased towing capability	Propshaft	PS900160
	2013.12-2018.07	AT	Rear	SUV 4WD N55B30A	For vehicles with increased towing capability or Adaptive suspension package Dynamic	Propshaft	PS900168
	2013.12-2018.07		Centre	SUV 4WD N55B30A		Center Bearing Support	530151
	2013.12-2018.07		Front	SUV 4WD N55B30A		Flexible Coupling	510596
3.0 (235 kw)	2012.02-2013.06	AT	Rear	SUV 4WD N55B30A	For vehicles with increased towing capability	Propshaft	PS900160
	2012.02-2013.06	AT	Rear	SUV 4WD N55B30A	For vehicles with increased towing capability or Adaptive suspension package Dynamic	Propshaft	PS900168
	2012.02-2013.06		Front	SUV 4WD N55B30A		Flexible Coupling	510596
3.0 (240 kw)	2013.12-2018.07	AT	Rear	SUV 4WD N55B30A	For vehicles with increased towing capability	Propshaft	PS900160
	2013.12-2018.07	AT	Rear	SUV 4WD N55B30A	For vehicles with increased towing capability or Adaptive suspension package Dynamic	Propshaft	PS900168
	2013.12-2018.07		Front	SUV 4WD N55B30A		Flexible Coupling	510596
X5 xDrive 40d							
3.0 (225 kw)	2010.04-2013.10	AT	Front	SUV 4WD N57D30B		Propshaft	PS900159
	2010.04-2013.10	AT	Rear	SUV 4WD N57D30B	For vehicles with increased towing capability	Propshaft	PS900160
	2010.04-2013.10	AT	Rear	SUV 4WD N57D30B	For vehicles with increased towing capability or Adaptive suspension package Dynamic	Propshaft	PS900168
	2010.04-2013.10		Centre	SUV 4WD N57D30B		Center Bearing Support	530151
	2010.04-2013.10		Front	SUV 4WD N57D30B		Flexible Coupling	537631
3.0 (230 kw)	2013.12-2018.07	AT	Rear	SUV 4WD N57D30B		Propshaft	PS900168
	2013.12-2018.07		Centre	SUV 4WD N57D30B		Center Bearing Support	530151
	2013.12-2018.07		Front	SUV 4WD N57D30B		Flexible Coupling	537631
X5 xDrive 40i							
3.0 (225 kw)	2012.01-2013.12	AT	Rear	SUV 4WD N55B30A		Propshaft	PS900168
X5 xDrive 48i							
4.8 (261 kw)	2008.10-2010.03	AT	Front	SUV 4WD N62B48B		Propshaft	PS900158
	2008.10-2010.03	AT	Rear	SUV 4WD N62B48B	Date From:2009.09	Propshaft	PS900166
	2008.10-2010.03		Centre	SUV 4WD N62B48B		Center Bearing Support	530151
	2008.10-2010.03		Front	SUV 4WD N62B48B		Flexible Coupling	510596
X5 xDrive 50i							
4.0 (300 kw)	2014.02-2018.07	AT	Rear	SUV 4WD N63B40A		Propshaft	PS900168
4.4 (298 kw)	2009.09-2013.06	AT	Rear	SUV AWD N63 B44 A		Propshaft	PS900168
4.4 (300 kw)	2010.04-2013.07	AT	Front	SUV 4WD N63B44A		Propshaft	PS900159
	2010.04-2013.07	AT	Rear	SUV 4WD N63B44A		Propshaft	PS900168
	2010.04-2013.07		Centre	SUV 4WD N63B44A		Center Bearing Support	530151
4.4 (330 kw)	2010.04-2013.07		Front	SUV 4WD N63B44A		Flexible Coupling	537631
	2013.08-2018.07	AT	Rear	SUV 4WD N63B44B		Propshaft	PS900168
4.4 (332 kw)	2013.08-2018.07		Centre	SUV 4WD N63B44B		Center Bearing Support	530151
4.4 (340 kw)	2013.08-2018.07	AT	Rear	SUV AWD N63 B44 B		Propshaft	PS900168
4.4 (340 kw)	2018.08-	AT	Front	SUV 4WD N63B44D		Propshaft	PS900139
X5 xDrive M50d							
3.0 (280 kw)	2012.06-2013.10	AT	Front	SUV 4WD N57D30C		Propshaft	PS900159
	2012.06-2013.10		Front	SUV 4WD N57D30C		Flexible Coupling	537631
	2012.06-2013.10		Front;Rear	SUV 4WD N57D30C		Flexible Coupling	517955

	 YEAR	TRANSM.	FITTING POSITION	BODY STYLE & DRIVE TYPE & ENGINE	REMARKS	 PRODUCT	GSP Ref.
BMW							
X5 xDrive M50d							
3.0 (280 kw)	2013.12-2018.07		Centre	SUV 4WD N57D30C		Center Bearing Support	530151
	2013.12-2018.07		Front	SUV 4WD N57D30C		Flexible Coupling	537631
	2013.12-2018.07		Front;Rear	SUV 4WD N57D30C		Flexible Coupling	517955
3.0 (294 kw)	2018.08-	AT	Front	SUV 4WD B57D30C		Propshaft	PS900139
	2018.08-		Front;Rear	SUV 4WD B57D30C		Flexible Coupling	517955
X6 ActiveHybrid							
4.4 (300 kw)	2009.01-2014.06	AT	Front	SUV 4WD N63B44A		Propshaft	PS900158
	2009.01-2014.06	AT	Rear	SUV 4WD N63B44A	Date To:2010.04	Propshaft	PS900166
	2009.01-2014.06		Centre	SUV 4WD N63B44A		Center Bearing Support	530151
	2009.01-2014.06		Front	SUV 4WD N63B44A		Flexible Coupling	537631
	2009.01-2014.06		Front	SUV 4WD N63B44A		Flexible Coupling Kit	537631S
X6 M							
4.4 (408 kw)	2009.07-2014.07	AT	Front	SUV 4WD S63B44A		Propshaft	PS900159
	2009.07-2014.07	AT	Rear	SUV 4WD S63B44A	Date From:2010.01	Propshaft	PS900166
	2009.07-2014.07		Front	SUV 4WD S63B44A		Flexible Coupling	537631
	2009.07-2014.07		Front;Rear	SUV 4WD S63B44A		Flexible Coupling	517955
X6 xDrive 30d							
3.0 (155 kw)	2010.04-2014.07	AT	Front	SUV 4WD N57D30A		Propshaft	PS900159
	2010.04-2014.07	AT	Rear	SUV 4WD N57D30A		Propshaft	PS900168
	2014.08-2019.07	AT	Rear	SUV 4WD N57D30A	For vehicles with increased towing capability	Propshaft	PS900160
	2014.08-2019.07	AT	Rear	SUV 4WD N57D30A	For vehicles with increased towing capability or Adaptive suspension package Dynamic	Propshaft	PS900168
	2014.08-2019.07		Front	SUV 4WD N57D30A		Flexible Coupling	510596
	2019.08-2020.07	AT	Front	SUV 4WD B57D30A		Propshaft	PS900139
	2019.08-2020.07		Front;Rear	SUV 4WD B57D30A		Flexible Coupling	517955
3.0 (173 kw)	2008.04-2010.03	AT	Front	SUV 4WD M57D306D3		Propshaft	PS900159
	2008.04-2010.03		Centre	SUV 4WD M57D306D3		Center Bearing Support	530151
	2008.04-2010.03		Front	SUV 4WD M57D306D3		Flexible Coupling	510641
	2008.04-2010.03		Front	SUV 4WD M57D306D3		Flexible Coupling	537631
	2008.04-2010.03		Front	SUV 4WD M57D306D3		Flexible Coupling Kit	537631S
3.0 (180 kw)	2010.04-2014.06	AT	Front	SUV 4WD N57D30A		Propshaft	PS900159
	2010.04-2014.06	AT	Rear	SUV 4WD N57D30A		Propshaft	PS900168
	2010.04-2014.06		Centre	SUV 4WD N57D30A		Center Bearing Support	530151
	2010.04-2014.06		Front	SUV 4WD N57D30A		Flexible Coupling	537631
3.0 (183 kw)	2014.12-2019.07	AT	Rear	SUV 4WD N57D30A	For vehicles with increased towing capability	Propshaft	PS900160
	2014.12-2019.07	AT	Rear	SUV 4WD N57D30A	For vehicles with increased towing capability or Adaptive suspension package Dynamic	Propshaft	PS900168
	2014.12-2019.07		Front	SUV 4WD N57D30A		Flexible Coupling	510596
	2019.08-2020.07	AT	Front	SUV 4WD B57D30A		Propshaft	PS900139
	2019.08-2020.07		Front;Rear	SUV 4WD B57D30A		Flexible Coupling	517955
3.0 (190 kw)	2014.08-2019.07	AT	Rear	SUV 4WD N57D30A	For vehicles with increased towing capability	Propshaft	PS900160
	2014.08-2019.07	AT	Rear	SUV 4WD N57D30A	For vehicles with increased towing capability or Adaptive suspension package Dynamic	Propshaft	PS900168
	2014.08-2019.07		Front	SUV 4WD N57D30A		Flexible Coupling	510596
	2014.08-2019.07		Front	SUV 4WD N57D30A		Flexible Coupling	537631
3.0 (195 kw)	2019.08-2020.07	AT	Front	SUV 4WD B57D30A		Propshaft	PS900139
	2019.08-2020.07		Front;Rear	SUV 4WD B57D30A		Flexible Coupling	517955
3.0 (204 kw)	2014.08-2019.07	AT	Rear	SUV 4WD N57D30A	For vehicles with increased towing capability	Propshaft	PS900160
	2014.08-2019.07	AT	Rear	SUV 4WD N57D30A	For vehicles with increased towing capability or Adaptive suspension package Dynamic	Propshaft	PS900168
	2014.08-2019.07		Front	SUV 4WD N57D30A		Flexible Coupling	510596
X6 xDrive 35d							
3.0 (210 kw)	2008.01-2010.03	AT	Rear	SUV 4WD M57D306D5		Propshaft	PS900166
X6 xDrive 35i							
3.0 (224 kw)	2008.01-2014.06	AT	Rear	SUV 4WD N54B30A/N55B30A		Propshaft	PS900168
3.0 (225 kw)	2008.01-2014.07	AT	Rear	SUV 4WD N54B30A/N55B30A		Propshaft	PS900168
	2008.01-2014.07		Centre	SUV 4WD N54B30A/N55B30A		Center Bearing Support	530151
	2008.01-2014.07		Front	SUV 4WD N54B30A/N55B30A		Flexible Coupling	510641
	2008.01-2014.07		Front	SUV 4WD N54B30A/N55B30A		Flexible Coupling	537631
	2008.01-2014.07		Front	SUV 4WD N54B30A/N55B30A		Flexible Coupling Kit	537631S
	2014.08-2019.07	AT	Rear	SUV 4WD N55B30A	For vehicles with increased towing capability	Propshaft	PS900160
	2014.08-2019.07	AT	Rear	SUV 4WD N55B30A	For vehicles with increased towing capability or Adaptive suspension package Dynamic	Propshaft	PS900168
2014.08-2019.07		Front	SUV 4WD N55B30A		Flexible Coupling	510596	
2014.08-2019.07		Front	SUV 4WD N55B30A		Flexible Coupling	537631	
3.0 (235 kw)	2012.01-2014.06	AT	Rear	SUV 4WD N55B30A		Propshaft	PS900168
3.0 (240 kw)	2009.08-2010.03		Front	SUV 4WD N54B30A		Propshaft	PS900155
	2014.08-2019.07	AT	Rear	SUV 4WD N55B30A	For vehicles with increased towing capability	Propshaft	PS900160
	2014.08-2019.07	AT	Rear	SUV 4WD N55B30A	For vehicles with increased towing capability or Adaptive suspension package Dynamic	Propshaft	PS900168



	 YEAR	TRANSM.	FITTING POSITION	BODY STYLE & DRIVE TYPE & ENGINE	REMARKS	 PRODUCT	GSP Ref.
BMW							
X6 xDrive 35i							
3.0 (240 kw)	2014.08-2019.07		Front	SUV 4WD N55B30A		Flexible Coupling	510596
X6 xDrive 40d							
3.0 (225 kw)	2010.04-2014.06	AT	Front	SUV 4WD N57D30B		Propshaft	PS900159
	2010.04-2014.06	AT	Rear	SUV 4WD N57D30B		Propshaft	PS900168
	2010.04-2014.06		Centre	SUV 4WD N57D30B		Center Bearing Support	530151
	2010.04-2014.06		Front	SUV 4WD N57D30B		Flexible Coupling	537631
3.0 (230 kw)	2014.12-2019.07	AT	Rear	SUV 4WD N57D30B		Propshaft	PS900168
	2014.12-2019.07		Front	SUV 4WD N57D30B		Flexible Coupling	510596
	2014.12-2019.07		Front	SUV 4WD N57D30B		Flexible Coupling	537631
X6 xDrive 40i							
3.0 (235 kw)	2012.08-2014.06	AT	Rear	SUV 4WD N55B30A		Propshaft	PS900168
3.0 (250 kw)	2019.08-		Front	SUV 4WD B58B30C		Flexible Coupling	537849
X6 xDrive 50i							
4.0 (300 kw)	2014.08-2019.07	AT	Rear	SUV 4WD N63B40A		Propshaft	PS900168
4.4 (300 kw)	2008.07-2014.07	AT	Front	SUV 4WD N63B44A	Date To:2010.04	Propshaft	PS900158
	2008.07-2014.07	AT	Front	SUV 4WD N63B44A	Date From:2010.05	Propshaft	PS900159
	2008.07-2014.07	AT	Rear	SUV 4WD N63B44A	Date From:2009.01 to 2010.04	Propshaft	PS900166
	2008.07-2014.07	AT	Rear	SUV 4WD N63B44A		Propshaft	PS900168
	2008.07-2014.07		Centre	SUV 4WD N63B44A		Center Bearing Support	530151
	2008.07-2014.07		Front	SUV 4WD N63B44A		Flexible Coupling	537631
	2008.07-2014.07		Front	SUV 4WD N63B44A		Flexible Coupling Kit	537631S
4.4 (330 kw)	2009.08-2014.06	AT	Front	SUV 4WD N63B44A		Propshaft	PS900158
	2009.08-2014.06	AT	Rear	SUV 4WD N63B44A		Propshaft	PS900168
	2014.08-2019.07	AT	Rear	SUV 4WD N63B44B		Propshaft	PS900168
X6 xDrive M50d							
3.0 (280 kw)	2012.04-2014.06	AT	Front	SUV 4WD N57D30C		Propshaft	PS900159
	2012.04-2014.06		Front;Rear	SUV 4WD N57D30C		Flexible Coupling	517955
	2014.08-2019.07		Front;Rear	SUV 4WD N57D30C		Flexible Coupling	517955
3.0 (294 kw)	2019.08-	AT	Front	SUV 4WD B57D30C		Propshaft	PS900139
	2019.08-		Front;Rear	SUV 4WD B57D30C		Flexible Coupling	517955
X6 xDrive M50i							
4.4 (390 kw)	2019.08-	AT	Front	SUV 4WD N63B44D		Propshaft	PS900139
	2019.08-		Front;Rear	SUV 4WD N63B44D		Flexible Coupling	517955
X7 xDrive 30d							
3.0 (155 kw)	2019.03-2020.07	AT	Front	SUV 4WD B57D30A		Propshaft	PS900139
	2019.03-2020.07		Front;Rear	SUV 4WD B57D30A		Flexible Coupling	517955
3.0 (183 kw)	2019.03-	AT	Front	SUV 4WD B57D30A		Propshaft	PS900139
	2019.03-		Front;Rear	SUV 4WD B57D30A		Flexible Coupling	517955
3.0 (195 kw)	2019.03-	AT	Front	SUV 4WD B57D30A		Propshaft	PS900139
	2019.03-		Front;Rear	SUV 4WD B57D30A		Flexible Coupling	517955
X7 xDrive 40i							
3.0 (250 kw)	2019.03-		Front	SUV 4WD B58B30C		Flexible Coupling	537631
X7 xDrive 50i							
4.4 (340 kw)	2019.03-	AT	Front	SUV 4WD N63B44D		Propshaft	PS900139
X7 xDrive M50d							
3.0 (294 kw)	2019.03-	AT	Front	SUV 4WD B57D30C		Propshaft	PS900139
	2019.03-		Front;Rear	SUV 4WD B57D30C		Flexible Coupling	517955
X7 xDrive M50i							
4.4 (390 kw)	2019.07-	AT	Front	SUV 4WD N63B44D		Propshaft	PS900139
	2019.07-		Front;Rear	SUV 4WD N63B44D		Flexible Coupling	517955
Z3 Cabrio							
1.8 (85 kw)	1995.10-1998.10		Centre	Cabriolet RWD M43B184E2		Center Bearing Support	510659
	1995.10-1998.10		Front	Cabriolet RWD M43B184E2		Flexible Coupling	510597
	1995.10-1998.10		Front	Cabriolet RWD M43B184E2		Flexible Coupling Kit	510597S
1.9 (85 kw)	1999.01-2003.01		Centre	Cabriolet RWD M43B194E1		Center Bearing Support	510659
	1999.01-2003.01		Front	Cabriolet RWD M43B194E1		Flexible Coupling	510597
	1999.01-2003.01		Front	Cabriolet RWD M43B194E1		Flexible Coupling	510641
	1999.01-2003.01		Front	Cabriolet RWD M43B194E1		Flexible Coupling Kit	510597S
	1999.01-2003.01		Front	Cabriolet RWD M43B194E1		Flexible Coupling	510659
1.9 (87 kw)	1998.10-2002.10		Centre	Cabriolet RWD M43B194E1		Center Bearing Support	510659
	1998.10-2002.10		Front	Cabriolet RWD M43B194E1		Flexible Coupling	510597
	1998.10-2002.10		Front	Cabriolet RWD M43B194E1		Flexible Coupling	510641
	1998.10-2002.10		Front	Cabriolet RWD M43B194E1		Flexible Coupling Kit	510597S
1.9 (103 kw)	1995.11-1999.03		Centre	Cabriolet RWD M44B194S1		Center Bearing Support	510659
	1995.11-1999.03		Front	Cabriolet RWD M44B194S1		Flexible Coupling	510597



	 YEAR	TRANSM.	FITTING POSITION	BODY STYLE & DRIVE TYPE & ENGINE	REMARKS	 PRODUCT	GSP Ref.
BMW							
Z3 Cabrio							
1.9 (103 kw)	1995.11-1999.03		Front	Cabriolet RWD M44B194S1		Flexible Coupling	510641
	1995.11-1999.03		Front	Cabriolet RWD M44B194S1		Flexible Coupling Kit	510597S
2.0 (110 kw)	1998.09-2000.07		Centre	Cabriolet RWD M52B206S4		Center Bearing Support	510659
	1998.09-2000.07		Front	Cabriolet RWD M52B206S4		Flexible Coupling	510596
	1998.09-2000.07		Front	Cabriolet RWD M52B206S4		Flexible Coupling	510597
	1998.09-2000.07		Front	Cabriolet RWD M52B206S4		Flexible Coupling Kit	510596S
	1998.09-2000.07		Front	Cabriolet RWD M52B206S4		Flexible Coupling Kit	510597S
2.2 (120 kw)	2000.08-2003.01		Front	Cabriolet RWD M54B226S1		Flexible Coupling	510596
2.2 (125 kw)	2000.10-2002.06		Centre	Cabriolet RWD M54B226S1		Center Bearing Support	510659
	2000.10-2002.06		Front	Cabriolet RWD M54B226S1		Flexible Coupling	510596
	2000.10-2002.06		Front	Cabriolet RWD M54B226S1		Flexible Coupling	510597
	2000.10-2002.06		Front	Cabriolet RWD M54B226S1		Flexible Coupling Kit	510596S
	2000.10-2002.06		Front	Cabriolet RWD M54B226S1		Flexible Coupling Kit	510597S
2.8 (142 kw)	1996.11-2000.05		Centre	Cabriolet RWD M52B286S1		Center Bearing Support	510659
	1996.11-2000.05		Front	Cabriolet RWD M52B286S1		Flexible Coupling	510596
	1996.11-2000.05		Front	Cabriolet RWD M52B286S1		Flexible Coupling	510597
	1996.11-2000.05		Front	Cabriolet RWD M52B286S1		Flexible Coupling Kit	510596S
	1996.11-2000.05		Front	Cabriolet RWD M52B286S1		Flexible Coupling Kit	510597S
2.8 (143 kw)	1996.01-2000.07		Centre	Cabriolet RWD M52B286S1/M52B286S2		Center Bearing Support	510659
	1996.01-2000.07		Front	Cabriolet RWD M52B286S1/M52B286S2		Flexible Coupling	510596
	1996.01-2000.07		Front	Cabriolet RWD M52B286S1/M52B286S2		Flexible Coupling	510597
	1996.01-2000.07		Front	Cabriolet RWD M52B286S1/M52B286S2		Flexible Coupling Kit	510597S
3.0 (170 kw)	2000.06-2002.06		Centre	Cabriolet RWD M54B306S3		Center Bearing Support	510659
	2000.06-2002.06		Front	Cabriolet RWD M54B306S3		Flexible Coupling	510596
	2000.06-2002.06		Front	Cabriolet RWD M54B306S3		Flexible Coupling Kit	510596S
Z3 Coupe							
2.8 (142 kw)	1998.01-2000.05		Centre	Coupe RWD M52B286S1/M52B286S2		Center Bearing Support	510659
	1998.01-2000.05		Front	Coupe RWD M52B286S1/M52B286S2		Flexible Coupling	510596
	1998.01-2000.05		Front	Coupe RWD M52B286S1/M52B286S2		Flexible Coupling	510597
	1998.01-2000.05		Front	Coupe RWD M52B286S1/M52B286S2		Flexible Coupling Kit	510596S
	1998.01-2000.05		Front	Coupe RWD M52B286S1/M52B286S2		Flexible Coupling Kit	510597S
3.0 (170 kw)	2000.06-2002.07		Centre	Coupe RWD M54B306S3		Center Bearing Support	510659
	2000.06-2002.07		Front	Coupe RWD M54B306S3		Flexible Coupling	510596
	2000.06-2002.07		Front	Coupe RWD M54B306S3		Flexible Coupling Kit	510596S
Z4 Cabrio							
2.0 (110 kw)	2005.03-2009.02		Centre	Cabriolet RWD N46B20B		Center Bearing Support	512301
	2005.03-2009.02		Front	Cabriolet RWD N46B20B		Flexible Coupling	510641
2.2 (125 kw)	2003.10-2005.10		Centre	Cabriolet RWD M54B226S1		Center Bearing Support	512301
	2003.10-2005.10		Front	Cabriolet RWD M54B226S1		Flexible Coupling	510596
	2003.10-2005.10		Front	Cabriolet RWD M54B226S1		Flexible Coupling	510597
	2003.10-2005.10		Front	Cabriolet RWD M54B226S1		Flexible Coupling Kit	510596S
	2003.10-2005.10		Front	Cabriolet RWD M54B226S1		Flexible Coupling Kit	510597S
2.5 (130 kw)	2005.09-2009.02		Centre	Cabriolet RWD N52B25A		Center Bearing Support	512301
	2005.09-2009.02		Front	Cabriolet RWD N52B25A		Flexible Coupling	510596
	2005.09-2009.02		Front	Cabriolet RWD N52B25A		Flexible Coupling Kit	510596S
2.5 (141 kw)	2002.12-2005.12		Centre	Cabriolet RWD M54B256S5		Center Bearing Support	512301
	2002.12-2005.12		Front	Cabriolet RWD M54B256S5		Flexible Coupling	510596
	2002.12-2005.12		Front	Cabriolet RWD M54B256S5		Flexible Coupling	510597
	2002.12-2005.12		Front	Cabriolet RWD M54B256S5		Flexible Coupling Kit	510596S
	2002.12-2005.12		Front	Cabriolet RWD M54B256S5		Flexible Coupling Kit	510597S
2.5 (155 kw)	2005.09-2009.02		Front	Cabriolet RWD N52B25A		Flexible Coupling	510596
2.5 (160 kw)	2006.01-2008.08		Centre	Cabriolet RWD N52B25A		Center Bearing Support	512301
	2006.01-2008.08		Front	Cabriolet RWD N52B25A		Flexible Coupling	510596
	2006.01-2008.08		Front	Cabriolet RWD N52B25A		Flexible Coupling Kit	510596S
3.0 (170 kw)	2002.12-2005.12		Centre	Cabriolet RWD M54B306S3		Center Bearing Support	512301
	2002.12-2005.12		Front	Cabriolet RWD M54B306S3		Flexible Coupling	510596
	2002.12-2005.12		Front	Cabriolet RWD M54B306S3		Flexible Coupling Kit	510596S
3.0 (190 kw)	2006.01-2008.08		Front	Cabriolet RWD N52B30A		Flexible Coupling Kit	510596S
3.0 (195 kw)	2006.01-2008.08		Centre	Cabriolet RWD N52B30A/N52B30BF		Center Bearing Support	512301
	2006.01-2008.08		Front	Cabriolet RWD N52B30A/N52B30BF		Flexible Coupling	510596
	2006.01-2008.08		Front	Cabriolet RWD N52B30A/N52B30BF		Flexible Coupling Kit	510596S
Z4 Coupe							
3.0 (195 kw)	2006.04-2008.08		Centre	Coupe RWD N52B30A		Center Bearing Support	512301
	2006.04-2008.08		Front	Coupe RWD N52B30A		Flexible Coupling	510596



	 YEAR	TRANSM.	FITTING POSITION	BODY STYLE & DRIVE TYPE & ENGINE	REMARKS	 PRODUCT	GSP Ref.
BMW							
Z4 Coupe							
3.0 (195 kw)	2006.04-2008.08		Front	Coupe RWD N52B30A		Flexible Coupling Kit	510596S
Z4 M40i Cabrio							
3.0 (250 kw)	2018.11-		Front;Rear	Cabriolet RWD B58B30C		Flexible Coupling	517955
Z4 sDrive 18i Cabrio							
2.0 (115 kw)	2013.04-2016.08		Front	Cabriolet RWD N20B20A		Flexible Coupling	510596
	2013.04-2016.08		Front	Cabriolet RWD N20B20A		Flexible Coupling Kit	510596S
Z4 sDrive 20i Cabrio							
2.0 (120 kw)	2011.09-2016.08		Front	Cabriolet RWD N20B20A		Flexible Coupling	510596
	2011.09-2016.08		Front	Cabriolet RWD N20B20A		Flexible Coupling Kit	510596S
	2018.11-		Front	Cabriolet RWD B46B20B/B48B20B		Flexible Coupling	533422
2.0 (135 kw)	2011.09-2016.08		Front	Cabriolet RWD N20B20A		Flexible Coupling	510596
	2011.09-2016.08		Front	Cabriolet RWD N20B20A		Flexible Coupling Kit	510596S
2.0 (145 kw)	2018.11-		Front	Cabriolet RWD B46B20B/B48B20B		Flexible Coupling	533422
Z4 sDrive 23i Cabrio							
2.5 (150 kw)	2009.03-2011.08		Front	Cabriolet RWD N52B25A/N52B25BF		Flexible Coupling	510596
	2009.03-2011.08		Front	Cabriolet RWD N52B25A/N52B25BF		Flexible Coupling Kit	510596S
Z4 sDrive 28i Cabrio							
2.0 (180 kw)	2011.09-2016.08		Front	Cabriolet RWD N20B20A		Flexible Coupling	510596
	2011.09-2016.08		Front	Cabriolet RWD N20B20A		Flexible Coupling Kit	510596S
Z4 sDrive 30i Cabrio							
2.0 (190 kw)	2018.11-		Front	Cabriolet RWD B48B20B		Flexible Coupling	533422
3.0 (190 kw)	2009.02-2011.08		Front	Cabriolet RWD N52B30A/N52B30B/N52B30BF		Flexible Coupling	510596
	2009.02-2011.08		Front	Cabriolet RWD N52B30A/N52B30B/N52B30BF		Flexible Coupling Kit	510596S
Z4 sDrive 35i Cabrio							
3.0 (224 kw)	2009.02-2016.08		Front;Rear	Cabriolet RWD N54B30A		Flexible Coupling	517955
	2009.02-2016.08		Front	Cabriolet RWD N54B30A		Flexible Coupling Kit	517955S
3.0 (225 kw)	2009.02-2016.08		Front;Rear	Cabriolet RWD N54B30A		Flexible Coupling	517955
	2009.02-2016.08		Front	Cabriolet RWD N54B30A		Flexible Coupling Kit	517955S
Z4 sDrive 35is Cabrio							
3.0 (250 kw)	2010.03-2016.08		Front;Rear	Cabriolet RWD N54B30A		Flexible Coupling	517955
	2010.03-2016.08		Front	Cabriolet RWD N54B30A		Flexible Coupling Kit	517955S
Z8 Cabrio							
4.9 (294 kw)	2000.01-2003.12	AT/MT	Rear	Cabriolet RWD S62B508S1		Joint,propshaft	605057
BMW (BRILLIANCE)							
330Li xDrive							
2.0 (190 kw)	2019.11-	AT	Front	Saloon 4WD B48B20D		Propshaft	PS900139
335Li							
3.0 (225 kw)	2013.03-		Front	Saloon RWD N55B30A		Flexible Coupling Kit	517955S
520Li							
2.0 (115 kw)	2009.06-2010.09	6AT/6MT	Rear	Saloon RWD N46B20CD		Propshaft	PS900133
2.0 (135 kw)	2012.08-	AT	Rear	Saloon RWD N20B20D		Propshaft	PS900134
2.5 (130 kw)	2010.12-	AT	Rear	Saloon RWD N52B25AF		Propshaft	PS900134
523Li							
2.5 (150 kw)	2010.08-	AT	Rear	Saloon RWD N52B25AF		Propshaft	PS900134
528Li							
2.0 (180 kw)	2014.05-2017.05	AT	Rear	Saloon RWD N20B20C		Propshaft	PS900134
3.0 (190 kw)	2010.08-	AT	Rear	Saloon RWD N52B30AF		Propshaft	PS900134
528Li xDrive							
2.0 (180 kw)	2014.05-	AT	Rear	Saloon 4WD N20B20C		Propshaft	PS900134
530Le							
2.0 (160 kw)	2015.01-	AT	Rear	Saloon RWD N20B20C		Propshaft	PS900134
530Li							
3.0 (190 kw)	2013.06-	AT	Rear	Saloon RWD N52B30AF		Propshaft	PS900134
535Li							
3.0 (225 kw)	2010.08-	AT	Rear	Saloon RWD N55B30A		Propshaft	PS900134
BUICK							
Rainier							
4.2 (205 kw)	2003.09-2007.12		Front	SUV AWD LL8(254CUL6)		Joint,propshaft	608073
5.3 (224 kw)	2004.09-2007.12		Front	SUV AWD LM4		Joint,propshaft	608073
CADILLAC							
SRX							
2.8 (224 kw)	2009.01-	6AT	Rear	SUV AWD LAU		Propshaft	PS900180
3.0 (183 kw)	2014.01-2016.04	6AT	Rear	SUV 4WD LF1		Propshaft	PS900180



	 YEAR	TRANSM.	FITTING POSITION	BODY STYLE & DRIVE TYPE & ENGINE	REMARKS	 PRODUCT	GSP Ref.
CADILLAC SRX							
3.0 (195 kw)	2009.10-2016.04	6AT	Rear	SUV 4WD LF1		Propshaft	PS900180
3.0 (198 kw)	2010.01-2016.04	6AT	Rear	SUV 4WD LF1		Propshaft	PS900180
3.6 (230 kw)	2012.01-2016.04	6AT	Rear	SUV 4WD LFX		Propshaft	PS900180
3.6 (234 kw)	2012.10-2016.04	6AT	Rear	SUV 4WD LFX		Propshaft	PS900180
CHEVROLET Astro							
4.3 (142 kw)	1994.10-2005.12		Front	VAN 4WD LB4/LU3		Joint,propshaft	699117
	1994.10-2005.12		Front	BUS 4WD LU3		Joint,propshaft	699117
Astro Extended Cargo							
4.3 (123 kw)	1992.09-1994.12		Front	VAN AWD LB4		Joint,propshaft	699117
Blazer							
4.3 (119 kw)	1994.10-1995.09		Front	Terrain cab wagon closed 4WD LB4		Joint,propshaft	699117
4.3 (132 kw)	1996.08-2003.10		Front	Closed Off-Road Vehicle RWD C 43 NE		Propshaft	299304
4.3 (142 kw)	1994.01-2004.09		Front	Terrain cab wagon closed 4WD L35(262CUL6)/LB4		Joint,propshaft	608072
	1994.01-2004.09		Front	Terrain cab wagon closed 4WD L35(262CUL6)/LB4		Joint,propshaft	699117
	1995.01-2005.12		Front	Terrain cab wagon closed RWD L35(262CUL6)		Joint,propshaft	699117
Captiva							
2.0 (93 kw)	2006.10-2009.12		Rear	SUV 4WD LLW		Propshaft	PS900182
	2006.10-2009.12		Centre	SUV 4WD LLW		Center Bearing Support	514802
	2006.10-2009.12		Centre	SUV FWD LLW		Center Bearing Support	514802
2.0 (110 kw)	2006.07-2011.02		Rear	SUV 4WD LLW		Propshaft	PS900182
	2006.07-2011.02		Centre	SUV 4WD LLW		Center Bearing Support	514802
	2006.07-2011.02		Centre	SUV Van 4WD LLW		Center Bearing Support	514802
	2007.09-2011.06		Centre	SUV FWD LLW		Center Bearing Support	514802
2.0 (120 kw)	2011.01-		Centre	SUV 4WD LNP		Center Bearing Support	514802
	2011.01-		Centre	SUV FWD LNP		Center Bearing Support	514802
2.2 (120 kw)	2011.03-		Rear	SUV 4WD LNQ		Propshaft	PS900182
2.2 (135 kw)	2011.03-		Rear	SUV 4WD LNQ		Propshaft	PS900182
2.4 (100 kw)	2006.06-2011.02		Rear	SUV 4WD LD9(147CUL4)		Propshaft	PS900182
	2006.06-2011.02		Centre	SUV 4WD LD9(147CUL4)		Center Bearing Support	514802
	2006.06-2011.02		Centre	SUV FWD LD9(147CUL4)		Center Bearing Support	514802
	2007.01-2011.02		Rear	SUV 4WD LD9(147CUL4)		Propshaft	PS900182
	2007.01-2011.02		Centre	SUV 4WD LD9(147CUL4)		Center Bearing Support	514802
2.4 (103 kw)	2006.12-2011.02		Centre	SUV FWD LD9(147CUL4)		Center Bearing Support	514802
	2006.12-2011.02		Centre	SUV 4WD LD9(147CUL4)		Center Bearing Support	514802
2.4 (105 kw)	2006.12-2011.02		Centre	SUV 4WD LD9(147CUL4)		Center Bearing Support	514802
2.4 (123 kw)	2011.03-		Rear	SUV 4WD LE5		Propshaft	PS900182
	2011.03-		Centre	SUV 4WD LE5		Center Bearing Support	514802
	2011.03-		Centre	SUV FWD LE5		Center Bearing Support	514802
2.4 (126 kw)	2012.11-		Centre	SUV FWD LE9(145CUL4)		Center Bearing Support	514802
3.2 (169 kw)	2006.06-2011.02		Centre	SUV 4WD LU1		Center Bearing Support	514802
Captiva Sport							
3.0 (197 kw)	2012.01-		Centre	SUV 4WD LFW		Center Bearing Support	514802
Equinox							
3.4 (138 kw)	2004.08-2009.09		-	SUV FWD LNJ		Joint,propshaft	635046
	2004.08-2009.09		-	SUV 4WD LNJ		Joint,propshaft	635046
S10							
2.2 (89 kw)	2002.09-2003.12		Front	Pick up AWD LN2		Joint,propshaft	608072
	2002.09-2003.12		Front	Pick up AWD LN2		Joint,propshaft	608073
4.3 (132 kw)	1999.08-2001.03		Front	Closed Off-Road Vehicle AWD C 43 NE		Propshaft	299304
4.3 (142 kw)	1994.10-2002.08		Front	Pick up 4WD L35(262CUL6)/LB4		Joint,propshaft	608072
	1994.10-2002.08		Front	Pick up 4WD L35(262CUL6)/LB4		Joint,propshaft	608073
	1997.10-2004.09		Front	Closed Off-Road Vehicle AWD L35(262CUL6)		Propshaft	299304
	1997.10-2004.09		Front	Closed Off-Road Vehicle AWD L35(262CUL6)		Joint,propshaft	608073
Trailblazer							
4.2 (201 kw)	2001.09-2007.02		Front	SUV 4WD LL8(254CUL6)		Joint,propshaft	608073
4.2 (205 kw)	2003.04-2005.09		Front	SUV 4WD LL8(254CUL6)		Joint,propshaft	608073
4.2 (213 kw)	2007.10-2009.09		Front	SUV 4WD LL8(254CUL6)		Joint,propshaft	608073
4.2 (217 kw)	2005.08-2008.09		Front	SUV 4WD LL8(254CUL6)		Joint,propshaft	608073
5.3 (216 kw)	2002.08-2007.09		Front	SUV 4WD LH6(325CUV8)		Joint,propshaft	608073
6.0 (295 kw)	2006.09-2008.02		Front	SUV 4WD LS2(364CUV8)		Joint,propshaft	608073



	 YEAR	TRANSM.	FITTING POSITION	BODY STYLE & DRIVE TYPE & ENGINE	REMARKS	 PRODUCT	GSP Ref.
CHRYSLER							
300C							
3.0 (155 kw)	2005.09-2011.12		Front	Saloon RWD EXL		Flexible Coupling	512672
	2005.09-2011.12		Rear	Saloon RWD EXL		Flexible Coupling Kit	537848S
3.0 (160 kw)	2005.09-2010.12		Front	Estate RWD EXL		Flexible Coupling	512672
	2005.09-2010.12		Front	Saloon RWD EXL		Flexible Coupling	512672
	2005.09-2010.12		Rear	Estate RWD EXL		Flexible Coupling Kit	537848S
	2005.09-2010.12		Rear	Saloon RWD EXL		Flexible Coupling Kit	537848S
3.5 (186 kw)	2005.01-2010.12	AT	Front	Saloon 4WD EGG		Propshaft	PS900193
5.7 (250 kw)	2004.09-2009.12		Front	Saloon 4WD EZB		Propshaft	PS900193
	2004.09-2010.12		Front;Rear	Saloon RWD EZB/EZD/EZH		Flexible Coupling	512677
5.7 (265 kw)	2009.05-2010.12		Front;Rear	Saloon RWD EZH		Flexible Coupling	512677
5.7 (268 kw)	2009.05-2010.12		Front	Saloon 4WD EZD/EZH		Propshaft	PS900193
CUPRA							
Ateca							
2.0 (221 kw)	2018.09-		Front	SUV 4WD DNFC/DNUE		Flexible Coupling	537626
	2018.09-		Rear	SUV 4WD DNFC/DNUE		Flexible Coupling	533882
	2018.09-		Front	SUV 4WD DNFC/DNUE		Flexible Coupling Kit	537626S
	2018.09-		Rear	SUV 4WD DNFC/DNUE		Flexible Coupling Kit	533882S
Formentor							
2.0 (140 kw)	2021.01-		Front	SUV 4WD DNNA		Flexible Coupling	537626
	2021.01-		Rear	SUV 4WD DNNA		Flexible Coupling	533882
	2021.01-		Front	SUV 4WD DNNA		Flexible Coupling Kit	537626S
2.0 (228 kw)	2020.07-		Front	SUV 4WD DNFB		Flexible Coupling	537626
	2020.07-		Rear	SUV 4WD DNFB		Flexible Coupling	533882
	2020.07-		Front	SUV 4WD DNFB		Flexible Coupling Kit	537626S
Leon Sportstourer							
2.0 (228 kw)	2021.06-		Front	Estate 4WD DNFB		Flexible Coupling	537626
	2021.06-		Rear	Estate 4WD DNFB		Flexible Coupling	533882
DACIA							
Duster							
1.2 (92 kw)	2013.10-		Rear	SUV Van 4WD H5F410	Date From:2015.06 to 2018.01	Propshaft	PS900557
	2015.06-2018.01		Rear	SUV 4WD H5F404		Propshaft	PS900557
	2017.10-		Rear	SUV 4WD H5F410		Propshaft	PS900557
1.3 (96 kw)	2019.01-		Rear	SUV 4WD H5H470/H5H480		Propshaft	PS900557
1.3 (110 kw)	2019.01-		Rear	SUV 4WD H5H470/H5H480		Propshaft	PS900557
1.5 (66 kw)	2010.10-2018.01		Rear	SUV 4WD K9K884/K9K894		Propshaft	PS900557
	2011.04-		Rear	SUV Van 4WD K9K884/K9K894	Date To:2018.01	Propshaft	PS900557
1.5 (80 kw)	2013.04-2018.01		Rear	SUV Van 4WD K9K858	Date To:2018.01	Propshaft	PS900557
	2013.08-2018.01		Rear	SUV 4WD K9K658/K9K856/K9K858/K9K898		Propshaft	PS900557
	2017.10-		Rear	SUV 4WD K9K658		Propshaft	PS900557
1.5 (81 kw)	2010.10-2018.01		Rear	SUV 4WD K9K856/K9K858/K9K896/K9K898		Propshaft	PS900557
1.5 (85 kw)	2017.10-		Rear	SUV 4WD K9K874		Propshaft	PS900557
1.6 (77 kw)	2010.03-2018.01		Rear	SUV 4WD K4M490/K4M606/K4M646/K4M690		Propshaft	PS900557
	2011.04-		Rear	SUV Van 4WD K4M606	Date To:2018.01	Propshaft	PS900557
1.6 (84 kw)	2015.06-2018.01		Rear	SUV 4WD H4M730		Propshaft	PS900557
	2015.06-2018.01		Rear	SUV Van 4WD H4M738	Date To:2018.01	Propshaft	PS900557
	2017.10-		Rear	SUV 4WD H4M738		Propshaft	PS900557
DAF							
65							
6.24 (133 kw)	1993.03-1998.02		-	Platform/Chassis 4x2 NS 133 L/NS 133 M		Center Bearing Support	532840
	1993.03-1998.02		-	Platform/Chassis 4x4 NS 133 L/NS 133 M		Center Bearing Support	532840
6.24 (156 kw)	1993.03-1998.02		-	Platform/Chassis 4x2 NS 156 L/NS 156 M		Center Bearing Support	532840
	1993.03-1998.02		-	Platform/Chassis 4x4 NS 156 L/NS 156 M		Center Bearing Support	532840
6.24 (177 kw)	1996.05-1998.02		-	Platform/Chassis 4x2 NS 177 M		Center Bearing Support	532840
65 CF							
6.24 (133 kw)	1998.02-2000.12		-	Platform/Chassis 4x2 NS 133 M		Center Bearing Support	532840
	1998.02-2000.12		-	Platform/Chassis 4x4 NS 133 M		Center Bearing Support	532840
6.24 (156 kw)	1998.02-2000.12		-	Platform/Chassis 4x2 NS 156 M		Center Bearing Support	532840
	1998.02-2000.12		-	Platform/Chassis 4x4 NS 156 M		Center Bearing Support	532840
6.24 (177 kw)	1998.02-2000.12		-	Platform/Chassis 4x2 NS 177 M		Center Bearing Support	532840
75 CF							
9.2 (183 kw)	1998.02-2000.12		-	Platform/Chassis 4x2 PF 183 M		Center Bearing Support	532840
	1998.02-2000.12		-	Platform/Chassis 6x2/4 PF 183 M		Center Bearing Support	532840
	1998.02-2000.12		-	Platform/Chassis 6x2 PF 183 M		Center Bearing Support	532840
	1998.02-2000.12		-	Platform/Chassis 6x4 PF 183 M		Center Bearing Support	532840

	 YEAR	TRANSM.	FITTING POSITION	BODY STYLE & DRIVE TYPE & ENGINE	REMARKS	 PRODUCT	GSP Ref.
DAF 75 CF							
9.2 (183 kw)	1998.02-2000.12	-	-	Truck Tractor 4x2 PF 183 M		Center Bearing Support	532840
9.2 (212 kw)	1998.02-2000.12	-	-	Platform/Chassis 4x2 PF 212 M		Center Bearing Support	532840
	1998.02-2000.12	-	-	Platform/Chassis 6x2/4 PF 212 M		Center Bearing Support	532840
	1998.02-2000.12	-	-	Platform/Chassis 6x2 PF 212 M		Center Bearing Support	532840
	1998.02-2000.12	-	-	Platform/Chassis 6x4 PF 212 M		Center Bearing Support	532840
	1998.02-2000.12	-	-	Truck Tractor 4x2 PF 212 M		Center Bearing Support	532840
	1998.02-2000.12	-	-	Truck Tractor 4x2 PF 212 M		Center Bearing Support	532840
9.2 (235 kw)	1998.02-2000.12	-	-	Platform/Chassis 4x2 PF 235 M		Center Bearing Support	532840
	1998.02-2000.12	-	-	Platform/Chassis 6x2/4 PF 235 M		Center Bearing Support	532840
	1998.02-2000.12	-	-	Platform/Chassis 6x2 PF 235 M		Center Bearing Support	532840
	1998.02-2000.12	-	-	Platform/Chassis 6x4 PF 235 M		Center Bearing Support	532840
	1998.02-2000.12	-	-	Truck Tractor 4x2 PF 235 M		Center Bearing Support	532840
85 CF							
12.58 (250 kw)	1998.02-2000.12	-	-	Platform/Chassis 4x2 XF 250 M		Center Bearing Support	532840
	1998.02-2000.12	-	-	Platform/Chassis 8x2/4 XF 250 M		Center Bearing Support	532840
	1998.02-2000.12	-	-	Platform/Chassis 8x4/4 XF 250 M		Center Bearing Support	532840
12.58 (280 kw)	1998.02-2000.12	-	-	Platform/Chassis 4x2 XF 280 M		Center Bearing Support	532840
	1998.02-2000.12	-	-	Platform/Chassis 8x2/4 XF 280 M		Center Bearing Support	532840
	1998.02-2000.12	-	-	Platform/Chassis 8x4/4 XF 280 M		Center Bearing Support	532840
12.58 (315 kw)	1998.02-2000.12	-	-	Platform/Chassis 4x2 XF 315 M		Center Bearing Support	532840
	1998.02-2000.12	-	-	Platform/Chassis 8x2/4 XF 315 M		Center Bearing Support	532840
CF 65							
6.691 (220 kw)	2009.01-2013.05	-	-	Platform/Chassis 4x2 GR 220(01.09-)		Center Bearing Support	532840
CF 75							
9.2 (183 kw)	2001.01-2013.05	-	-	Platform/Chassis 4x2 PE 183 C(01.01-)PR 183 S(10.06-)		Center Bearing Support	532840
	2001.01-2013.05	-	-	Platform/Chassis 6x4 PE 183 C(01.01-)PR 183 S(10.06-)		Center Bearing Support	532840
	2001.01-2013.05	-	-	Platform/Chassis 6x2 PE 183 C(01.01-)PR 183 S(10.06-)		Center Bearing Support	532840
	2001.01-2013.05	-	-	Platform/Chassis 6x4 PE 183 C(01.01-)PR 183 S(10.06-)		Center Bearing Support	532840
	2001.01-2013.05	-	-	Truck Tractor 4x2 PE 183 C(01.01-)PR 183 S(10.06-)		Center Bearing Support	532840
9.2 (183-184 kw)	2001.01-2013.05	-	-	Platform/Chassis 8x4/4 PR 183 S(10.06-)		Center Bearing Support	532840
9.2 (228 kw)	2001.01-2013.05	-	-	Platform/Chassis 4x2 PE 228 C(01.01-)PR 228 S(10.06-)		Center Bearing Support	532840
	2001.01-2013.05	-	-	Platform/Chassis 8x4/4 PR 228 S(10.06-)		Center Bearing Support	532840
	2001.01-2013.05	-	-	Platform/Chassis 6x4 PE 228 C(01.01-)PR 228 S(10.06-)		Center Bearing Support	532840
	2001.01-2013.05	-	-	Platform/Chassis 6x2 PE 228 C(01.01-)PR 228 S(10.06-)		Center Bearing Support	532840
	2001.01-2013.05	-	-	Platform/Chassis 6x4 PE 228 C(01.01-)PR 228 S(10.06-)		Center Bearing Support	532840
	2001.01-2013.05	-	-	Truck Tractor 4x2 PE 228 C(01.01-)PR 228 S(10.06-)		Center Bearing Support	532840
	2001.01-2013.05	-	-	Truck Tractor 4x2 PE 228 C(01.01-)PR 228 S(10.06-)		Center Bearing Support	532840
9.2 (265 kw)	2001.01-2013.05	-	-	Platform/Chassis 4x2 PE 265 C(01.01-)PR 265 S(10.06-)		Center Bearing Support	532840
	2001.01-2013.05	-	-	Platform/Chassis 8x4/4 PR 265 S(10.06-)		Center Bearing Support	532840
	2001.01-2013.05	-	-	Platform/Chassis 6x4 PE 265 C(01.01-)PR 265 S(10.06-)		Center Bearing Support	532840
	2001.01-2013.05	-	-	Platform/Chassis 6x2 PE 265 C(01.01-)PR 265 S(10.06-)		Center Bearing Support	532840
	2001.01-2013.05	-	-	Platform/Chassis 6x4 PE 265 C(01.01-)PR 265 S(10.06-)		Center Bearing Support	532840
	2001.01-2013.05	-	-	Truck Tractor 4x2 PE 265 C(01.01-)PR 265 S(10.06-)		Center Bearing Support	532840
	2001.01-2013.05	-	-	Truck Tractor 4x2 PE 265 C(01.01-)PR 265 S(10.06-)		Center Bearing Support	532840
CF 85							
12.58 (250 kw)	2001.01-2013.05	-	-	Platform/Chassis 4x2 XE 250 C(01.01-)		Center Bearing Support	532840
	2001.01-2013.05	-	-	Truck Tractor 6x2 XE 250 C		Center Bearing Support	532840
12.58 (280 kw)	2001.01-2013.05	-	-	Truck Tractor 6x2 XE 280 C(01.01-)		Center Bearing Support	532840
12.58 (315 kw)	2001.01-2013.05	-	-	Truck Tractor 6x2 XE 315 C(01.01-)		Center Bearing Support	532840
12.58 (355 kw)	2001.01-2013.05	-	-	Truck Tractor 6x2/4 XE 355 C(01.01-)		Center Bearing Support	532840
	2001.01-2013.05	-	-	Truck Tractor 6x2 XF 355 M		Center Bearing Support	532840
12.9 (265 kw)	2006.10-2013.05	-	-	Truck Tractor 6x2 MX 265(10.06-)		Center Bearing Support	532840
12.9 (300 kw)	2005.10-2013.05	-	-	Truck Tractor 6x2 MX 300(10.05-)		Center Bearing Support	532840
12.9 (340 kw)	2005.10-2013.05	-	-	Truck Tractor 6x2/4 MX 340(10.05-)		Center Bearing Support	532840
	2005.10-2013.05	-	-	Truck Tractor 6x2 MX 340(10.05-)		Center Bearing Support	532840
12.9 (375 kw)	2005.10-2013.05	-	-	Truck Tractor 6x2/4 MX 375(10.05-)		Center Bearing Support	532840
	2005.10-2013.05	-	-	Truck Tractor 6x2 MX 375(10.05-)		Center Bearing Support	532840
XF 95							
12.58 (280 kw)	2002.01-2006.03	-	-	Truck Tractor 6x4 XE 280 C		Center Bearing Support	532840
	2002.01-2006.12	-	-	Truck Tractor 6x2 XE 280 C		Center Bearing Support	532840
12.58 (315 kw)	2002.01-2006.03	-	-	Truck Tractor 6x4 XE 315 C		Center Bearing Support	532840
	2002.01-2006.12	-	-	Truck Tractor 6x2 XE 315 C		Center Bearing Support	532840
12.58 (355 kw)	2002.01-2006.03	-	-	Truck Tractor 6x4 XE 355 C		Center Bearing Support	532840
	2002.01-2006.12	-	-	Truck Tractor 6x2 XE 355 C		Center Bearing Support	532840
12.58 (390 kw)	2002.09-2006.03	-	-	Truck Tractor 6x2 XE 390 C(09.02-)		Center Bearing Support	532840
	2002.09-2006.03	-	-	Truck Tractor 6x4 XE 390 C(09.02-)		Center Bearing Support	532840

	 YEAR	TRANSM.	FITTING POSITION	BODY STYLE & DRIVE TYPE & ENGINE	REMARKS	 PRODUCT	GSP Ref.
DAIHATSU Hijet							
1.0 (33 kw)	1992.12-1998.05		Front	VAN RWD CB41	Total Length:515.5 mm	Propshaft	PS900195
	1992.12-1998.05		Front	VAN RWD CB41	Total Length:497.5 mm	Propshaft	PS900196
	1992.12-1998.05		Front	VAN RWD CB41	Total Length:625.5 mm	Propshaft	PS900197
	1992.12-1998.05		Front	VAN RWD CB41	Total Length:640.5 mm	Propshaft	PS900198
	1992.12-1998.05		Front	VAN RWD CB41	Total Length:445.5 mm	Propshaft	PS900199
1.0 (35 kw)	1994.10-1998.05		Front	BUS RWD CB42	Total Length:515.5 mm	Propshaft	PS900195
	1994.10-1998.05		Front	VAN RWD CB42	Total Length:515.5 mm	Propshaft	PS900195
	1994.10-1998.05		Front	BUS RWD CB42	Total Length:497.5 mm	Propshaft	PS900196
	1994.10-1998.05		Front	VAN RWD CB42	Total Length:497.5 mm	Propshaft	PS900196
	1994.10-1998.05		Front	BUS RWD CB42	Total Length:625.5 mm	Propshaft	PS900197
	1994.10-1998.05		Front	VAN RWD CB42	Total Length:625.5 mm	Propshaft	PS900197
	1994.10-1998.05		Front	BUS RWD CB42	Total Length:640.5 mm	Propshaft	PS900198
	1994.10-1998.05		Front	VAN RWD CB42	Total Length:640.5 mm	Propshaft	PS900198
	1994.10-1998.05		Front	BUS RWD CB42	Total Length:445.5 mm	Propshaft	PS900199
	1994.10-1998.05		Front	VAN RWD CB42	Total Length:445.5 mm	Propshaft	PS900199
Terios							
1.3 (61 kw)	1997.03-2000.09	AT/MT	Front	Terrain cab wagon closed 4WD HCEJ		Propshaft	PS900470
	1997.03-2000.09		Centre	Terrain cab wagon closed 4WD HCEJ		Center Bearing Support	514785
1.3 (63 kw)	2000.10-2002.09		Centre	Terrain cab wagon closed 4WD K3VE		Center Bearing Support	514785
DODGE Ram 1500							
3.7 (157 kw)	2001.06-2008.09		Front	Pick up RWD EKG		Joint,propshaft	808078
3.7 (160 kw)	2001.09-2008.12		Front	Pick up AWD EKG		Joint,propshaft	808078
3.7 (163 kw)	2001.09-2008.12		Front	Pick up AWD EKG		Joint,propshaft	808078
4.7 (172 kw)	2001.06-2008.09		-	Pick up 4WD EVA		Propshaft	201406
4.7 (175 kw)	2001.08-2008.09		-	Pick up 4WD EVA		Propshaft	201406
	2001.08-2008.09		Front	Pick up 4WD EVA		Joint,propshaft	808078
	2001.09-2007.12		Front	Pick up AWD EVA		Joint,propshaft	808078
	2005.09-2007.12		Front	Pick up AWD EVA		Joint,propshaft	808078
4.7 (230 kw)	2008.10-2012.12		-	Pick up 4WD EVC		Propshaft	201406
5.7 (254 kw)	2003.01-2008.12		Front	Pick up 4WD EZB		Joint,propshaft	808078
5.7 (257 kw)	2003.01-2005.12		Front	Pick up 4WD EZA		Joint,propshaft	808078
	2008.10-2011.12		-	Pick up 4WD EZA		Propshaft	201406
5.9 (180 kw)	2001.06-2008.09		-	Pick up 4WD EML		Propshaft	201406
8.3 (373 kw)	2004.01-2006.12		Front	Pick up RWD EWC		Joint,propshaft	808078
Ram 1500 Crew Cab							
5.9 (183 kw)	2001.09-2003.12		Front	Pick up AWD EML		Joint,propshaft	808078
Ram 1500 Standard Cab							
5.9 (183 kw)	2001.09-2003.12		Front	Pick up AWD EML		Joint,propshaft	808078
FIAT Panda							
0.9 (63 kw)	2012.02-		-	Hatchback FWD 312A2000		Joint,propshaft	635064
	2012.09-	MT	-	Hatchback 4WD 312A2000		Propshaft	PS900222
	2012.09-		-	Hatchback 4WD 312A2000		Joint,propshaft	635064
0.9 (66 kw)	2014.06-	MT	-	Hatchback 4WD 312A7000		Propshaft	PS900222
	2014.06-		-	Hatchback 4WD 312A7000		Joint,propshaft	635064
1.0 (33 kw)	1986.05-1994.12		Front;Rear	Hatchback 4WD 156A2246		Center Bearing Support	518107
1.0 (37 kw)	1985.10-1992.12		Front;Rear	Hatchback 4WD 156A048/156A3000		Center Bearing Support	518107
1.1 (37 kw)	1991.05-1995.03		Front;Rear	Hatchback 4WD 156C046		Center Bearing Support	518107
1.1 (40 kw)	1995.04-2004.07		Front;Rear	Hatchback 4WD 176B2000/187A1000		Center Bearing Support	518107
1.2 (44 kw)	2004.08-2012.12	AT/MT	-	Hatchback 4WD 188A4000	Date To:2012.12	Propshaft	PS900222
	2004.08-2012.12		-	Hatchback 4WD 188A4000		Joint,propshaft	635064
	2004.08-2012.12		Centre	Hatchback 4WD 188A4000		Center Bearing Support	518108
1.2 (51 kw)	2010.03-2012.12		-	Hatchback FWD 169A4000		Joint,propshaft	635064
	2010.04-2012.12	AT/MT	-	Hatchback 4WD 169A4000	Date To:2012.12	Propshaft	PS900222
	2010.04-2012.12		-	Hatchback 4WD 169A4000		Joint,propshaft	635064
1.3 (51 kw)	2004.08-2012.12	AT/MT	-	Hatchback 4WD 188A8000	Date To:2012.12	Propshaft	PS900222
	2004.08-2012.12		-	Hatchback 4WD 188A8000		Joint,propshaft	635064
	2004.08-2012.12		Centre	Hatchback 4WD 188A8000		Center Bearing Support	518108
1.3 (55 kw)	2010.09-2012.12	AT/MT	-	Hatchback 4WD 169A1000	Date To:2012.12	Propshaft	PS900222
	2010.09-2012.12		-	Hatchback 4WD 169A1000		Joint,propshaft	635064
	2012.06-	MT	-	Hatchback 4WD 199A9000		Propshaft	PS900222
	2012.06-		-	Hatchback 4WD 199A9000		Joint,propshaft	635064

	 YEAR	TRANSM.	FITTING POSITION	BODY STYLE & DRIVE TYPE & ENGINE	REMARKS	 PRODUCT	GSP Ref.
FIAT Panda							
1.3 (59 kw)	2014.06-	MT	-	Hatchback 4WD 312A8000		Propshaft	PS900222
	2014.06-		-	Hatchback 4WD 312A8000		Joint,propshaft	635064
1.3 (70 kw)	2015.04-	MT	-	Hatchback 4WD 312B1000		Propshaft	PS900222
Panda Classic							
1.2 (51 kw)	2012.01-2013.08	AT/MT	-	Hatchback 4WD 169A4000	Date From:2012.01	Propshaft	PS900222
	2012.01-2013.08		-	Hatchback FWD 169A4000		Joint,propshaft	635064
	2012.01-2013.08		-	Hatchback 4WD 169A4000		Joint,propshaft	635064
1.3 (55 kw)	2012.01-2013.08	AT/MT	-	Hatchback 4WD 169A5000	Date From:2012.01	Propshaft	PS900222
	2012.01-2013.08		-	Hatchback 4WD 169A5000		Joint,propshaft	635064
Panda Van							
0.9 (63 kw)	2013.01-	MT	-	Hatchback van 4WD 312A2000	Date From:2013.01	Propshaft	PS900222
	2013.01-		-	Hatchback van 4WD 312A2000		Joint,propshaft	635064
1.2 (44 kw)	2004.09-2012.12		-	Hatchback van 4WD 188A4000	Date To:2012.12	Propshaft	PS900222
	2004.09-2012.12		-	Hatchback van 4WD 188A4000		Joint,propshaft	635064
1.2 (51 kw)	2010.09-2012.12		-	Hatchback van 4WD 169A4000	Date To:2012.12	Propshaft	PS900222
	2010.09-2012.12		-	Hatchback van 4WD 169A4000		Joint,propshaft	635064
1.3 (51 kw)	2004.03-2012.12	AT/MT	-	Hatchback van 4WD 188A8000		Propshaft	PS900222
	2004.03-2012.12		-	Hatchback van 4WD 188A8000		Joint,propshaft	635064
1.3 (55 kw)	2006.06-2012.12		-	Hatchback van 4WD 169A1000	Date From:2006.06 to 2012.12	Propshaft	PS900222
	2006.06-2012.12		-	Hatchback van 4WD 169A1000		Joint,propshaft	635064
	2013.01-	MT	-	Hatchback van 4WD 199A9000	Date From:2013.01	Propshaft	PS900222
	2013.01-		-	Hatchback van 4WD 199A9000		Joint,propshaft	635064
1.3 (59 kw)	2015.05-	MT	-	Hatchback van 4WD 225A2000	Date From:2015.05	Propshaft	PS900222
FORD Fiesta							
1.3 (37 kw)	1996.01-2002.04		Centre	Hatchback FWD JJA/JJC/JJE/JJJ/JJK/JJM		Center Bearing Support	514801
1.3 (44 kw)	1995.06-2002.04		Centre	Hatchback FWD J4C/J4J/J4L/J4Q/J4R/J4T		Center Bearing Support	514801
1.4 (66 kw)	1996.01-2002.04		Centre	Hatchback FWD FHA/FHE		Center Bearing Support	514801
1.8 (44 kw)	1995.08-2000.08		Centre	Hatchback FWD RTJ/RTK		Center Bearing Support	514801
Galaxy							
1.9 (66 kw)	1995.02-2006.05		Centre	MPV FWD 1Z/AHU/ANU		Center Bearing Support	514801
1.9 (81 kw)	1997.10-2000.04		Centre	MPV FWD AFN/AVG		Center Bearing Support	514801
1.9 (85 kw)	2000.05-2006.03		Centre	MPV FWD AUY		Center Bearing Support	514801
1.9 (96 kw)	2002.11-2006.03		Centre	MPV FWD ASZ/AVF		Center Bearing Support	514801
1.9 (110 kw)	2005.01-2006.05		Centre	MPV FWD BTB		Center Bearing Support	514801
2.0 (85 kw)	1995.02-2006.03		Centre	MPV FWD NSE/ZVSA		Center Bearing Support	514801
2.3 (103 kw)	2002.11-2006.03		Centre	MPV FWD E5SB		Center Bearing Support	514801
2.3 (107 kw)	1996.09-2002.10		Centre	MPV FWD E5SA/Y5B		Center Bearing Support	514801
2.8 (128 kw)	1995.11-2000.07		Centre	MPV FWD AAA/AMY		Center Bearing Support	514801
	1996.09-2000.04		Centre	MPV 4WD AAA/AMY		Center Bearing Support	514801
2.8 (150 kw)	2000.05-2006.03		Centre	MPV FWD AYL		Center Bearing Support	514801
Granada							
1.8 (66 kw)	1985.04-1992.02	MT	Rear	Hatchback RWD REC	Wheel Side,Transmission End,Rear Axle Left and Right	Joint,propshaft	618001
2.0 (85 kw)	1985.04-1994.09	AT/MT	Rear	Hatchback RWD NRA/NRI	Wheel Side,Transmission End,Rear Axle Left and Right	Joint,propshaft	618001
	1991.09-1994.09	AT/MT	Rear	Estate RWD N9F	Wheel Side,Transmission End,Rear Axle Left and Right	Joint,propshaft	618001
2.0 (88 kw)	1989.05-1992.10	AT/MT	Rear	Saloon RWD N9D	Wheel Side,Transmission End,Rear Axle Left and Right	Joint,propshaft	618001
	1992.09-1994.09	AT/MT	Rear	Estate RWD N9D	Wheel Side,Transmission End,Rear Axle Left and Right	Joint,propshaft	618001
2.0 (92 kw)	1989.05-1992.02	MT	Rear	Saloon RWD DL20EGGE	Wheel Side,Transmission End,Rear Axle Left and Right	Joint,propshaft	618001
2.4 (92 kw)	1988.11-1992.10	AT/MT	Rear	Hatchback RWD ARD	Wheel Side,Transmission End,Rear Axle Left and Right	Joint,propshaft	618001
	1988.11-1992.10	MT	Rear	Saloon RWD ARD	Wheel Side,Transmission End,Rear Axle Left and Right	Joint,propshaft	618001
2.5 (68 kw)	1990.01-1993.08	MT	Rear	Saloon RWD SFA/SFB	Wheel Side,Transmission End,Rear Axle Left and Right	Joint,propshaft	618001
2.5 (85 kw)	1993.08-1994.09	MT	Rear	Hatchback RWD SCB	Wheel Side,Transmission End,Rear Axle Left and Right	Joint,propshaft	618001
	1993.08-1994.09	MT	Rear	Saloon RWD SCB	Wheel Side,Transmission End,Rear Axle Left and Right	Joint,propshaft	618001
	1993.08-1995.03	MT	Rear	Estate RWD SCB	Wheel Side,Transmission End,Rear Axle Left and Right	Joint,propshaft	618001
2.9 (107 kw)	1987.01-1995.03	AT/MT	Rear	Hatchback RWD BRD/BRE/BRF	Wheel Side,Transmission End,Rear Axle Left and Right	Joint,propshaft	618001
	1990.01-1994.12	AT/MT	Rear	Saloon RWD BRD/BRE/BRF	Wheel Side,Transmission End,Rear Axle Left and Right	Joint,propshaft	618001
2.9 (110 kw)	1986.09-1994.09	AT/MT	Rear	Hatchback 4WD BRC	Wheel Side,Transmission End,Rear Axle Left and Right	Joint,propshaft	618001
	1986.09-1994.09	AT/MT	Rear	Hatchback RWD BRC	Wheel Side,Transmission End,Rear Axle Left and Right	Joint,propshaft	618001
2.9 (143 kw)	1991.04-1995.03	AT/MT	Rear	Hatchback RWD BOA	Wheel Side,Transmission End,Rear Axle Left and Right	Joint,propshaft	618001
	1991.08-1994.09	AT/MT	Rear	Saloon RWD BOA	Wheel Side,Transmission End,Rear Axle Left and Right	Joint,propshaft	618001
	1992.11-1994.09	AT/MT	Rear	Estate RWD BOA	Wheel Side,Transmission End,Rear Axle Left and Right	Joint,propshaft	618001
Mondeo							
2.5 (125 kw)	2000.10-2007.02		Centre	Hatchback FWD LCBD		Center Bearing Support	514801
	2000.11-2007.08		Centre	Saloon FWD LCBD		Center Bearing Support	514801



	 YEAR	TRANSM.	FITTING POSITION	BODY STYLE & DRIVE TYPE & ENGINE	REMARKS	 PRODUCT	GSP Ref.
FORD							
Mondeo							
3.0 (150 kw)	2004.09-2007.08		Centre	Hatchback FWD REBA		Center Bearing Support	514801
	2004.09-2007.08		Centre	Saloon FWD REBA		Center Bearing Support	514801
3.0 (166 kw)	2002.02-2007.02		Centre	Hatchback FWD MEBA		Center Bearing Support	514801
	2002.02-2007.02		Centre	Saloon FWD MEBA		Center Bearing Support	514801
Mondeo Estate/Wagon							
2.5 (125 kw)	2000.10-2007.02		Centre	Estate FWD LCBD		Center Bearing Support	514801
3.0 (150 kw)	2004.09-2007.08		Centre	Estate FWD REBA		Center Bearing Support	514801
3.0 (166 kw)	2002.02-2007.02		Centre	Estate FWD MEBA		Center Bearing Support	514801
Scorpio							
1.8 (66 kw)	1985.04-1992.02	MT	Rear	Hatchback RWD REC	Wheel Side,Transmission End,Rear Axle Left and Right	Joint,propshaft	618001
2.0 (85 kw)	1985.04-1992.02	AT/MT	Rear	Hatchback RWD NRA/NRI	Wheel Side,Transmission End,Rear Axle Left and Right	Joint,propshaft	618001
	1991.09-1994.09	AT/MT	Rear	Estate RWD N9F	Wheel Side,Transmission End,Rear Axle Left and Right	Joint,propshaft	618001
	1992.02-1994.09	AT/MT	Rear	Hatchback RWD N9F	Wheel Side,Transmission End,Rear Axle Left and Right	Joint,propshaft	618001
	1994.10-1997.12	AT/MT	Rear	Estate RWD NSD	Wheel Side,Transmission End,Rear Axle Left and Right	Joint,propshaft	618001
	1994.10-1998.08	AT/MT	Rear	Saloon RWD NSD	Wheel Side,Transmission End,Rear Axle Left and Right	Joint,propshaft	618001
2.0 (88 kw)	1989.05-1994.09	AT/MT	Rear	Hatchback RWD N9D	Wheel Side,Transmission End,Rear Axle Left and Right	Joint,propshaft	618001
	1990.03-1994.09	AT/MT	Rear	Saloon RWD N9D	Wheel Side,Transmission End,Rear Axle Left and Right	Joint,propshaft	618001
	1990.10-1994.09	AT/MT	Rear	Estate RWD N9D	Wheel Side,Transmission End,Rear Axle Left and Right	Joint,propshaft	618001
2.4 (92 kw)	1988.10-1994.09	AT/MT	Rear	Hatchback RWD ARD	Wheel Side,Transmission End,Rear Axle Left and Right	Joint,propshaft	618001
	1988.11-1994.09	MT	Rear	Saloon RWD ARD	Wheel Side,Transmission End,Rear Axle Left and Right	Joint,propshaft	618001
	1991.09-1994.09	MT	Rear	Estate RWD ARD	Wheel Side,Transmission End,Rear Axle Left and Right	Joint,propshaft	618001
2.5 (51 kw)	1984.10-1992.08	MT	Rear	Hatchback RWD STR	Wheel Side,Transmission End,Rear Axle Left and Right	Joint,propshaft	618001
2.5 (68 kw)	1988.06-1993.07	MT	Rear	Hatchback RWD SFA/SFB	Wheel Side,Transmission End,Rear Axle Left and Right	Joint,propshaft	618001
	1988.06-1993.07	MT	Rear	Saloon RWD SFA/SFB	Wheel Side,Transmission End,Rear Axle Left and Right	Joint,propshaft	618001
	1991.09-1993.07	MT	Rear	Estate RWD SFA/SFB	Wheel Side,Transmission End,Rear Axle Left and Right	Joint,propshaft	618001
2.5 (85 kw)	1993.08-1994.09	MT	Rear	Estate RWD SCB	Wheel Side,Transmission End,Rear Axle Left and Right	Joint,propshaft	618001
	1993.08-1994.09	MT	Rear	Hatchback RWD SCB	Wheel Side,Transmission End,Rear Axle Left and Right	Joint,propshaft	618001
	1993.08-1994.09	MT	Rear	Saloon RWD SCB	Wheel Side,Transmission End,Rear Axle Left and Right	Joint,propshaft	618001
2.9 (107 kw)	1986.09-1994.09	AT/MT	Rear	Hatchback RWD BRD/BRE/BRF	Wheel Side,Transmission End,Rear Axle Left and Right	Joint,propshaft	618001
	1986.10-1994.09	AT/MT	Rear	Saloon RWD BRD/BRE/BRF	Wheel Side,Transmission End,Rear Axle Left and Right	Joint,propshaft	618001
	1988.11-1994.09	AT/MT	Rear	Estate 4WD BRD/BRE/BRF	Wheel Side,Transmission End,Rear Axle Left and Right	Joint,propshaft	618001
	1988.11-1994.09	AT/MT	Rear	Hatchback 4WD BRD/BRE/BRF	Date From:1988.11;Wheel Side,Transmission End,Rear Axle Left and Right	Joint,propshaft	618001
	1988.11-1994.09	AT/MT	Rear	Saloon 4WD BRD/BRE/BRF	Wheel Side,Transmission End,Rear Axle Left and Right	Joint,propshaft	618001
2.9 (110 kw)	1991.09-1994.09	AT/MT	Rear	Estate RWD BRD/BRE/BRF	Wheel Side,Transmission End,Rear Axle Left and Right	Joint,propshaft	618001
	1986.09-1994.09	AT/MT	Rear	Hatchback 4WD BRC	Wheel Side,Transmission End,Rear Axle Left and Right	Joint,propshaft	618001
2.9 (143 kw)	1986.10-1992.08	AT/MT	Rear	Hatchback RWD BRC	Wheel Side,Transmission End,Rear Axle Left and Right	Joint,propshaft	618001
	1990.02-1994.09	AT/MT	Rear	Estate RWD BOA	Wheel Side,Transmission End,Rear Axle Left and Right	Joint,propshaft	618001
2.9 (143 kw)	1990.02-1994.09	AT/MT	Rear	Hatchback RWD BOA	Wheel Side,Transmission End,Rear Axle Left and Right	Joint,propshaft	618001
	1990.02-1994.09	AT/MT	Rear	Saloon RWD BOA	Wheel Side,Transmission End,Rear Axle Left and Right	Joint,propshaft	618001
Transit							
2.0 (84 kw)	1994.06-2000.03		Centre	BUS RWD NSH		Center Bearing Support	511381
Transit 100							
2.0 (66 kw)	1991.04-1994.07		Centre	BUS RWD NBA		Center Bearing Support	511380
	1991.04-1994.07		Centre	Chassis cabin RWD NBA		Center Bearing Support	511380
	1991.04-1994.07		Centre	BUS RWD NBA		Center Bearing Support	511381
	1991.04-1994.07		Centre	Chassis cabin RWD NBA		Center Bearing Support	511381
	1991.04-1994.12		Centre	VAN RWD NBA		Center Bearing Support	511380
	1991.04-1994.12		Centre	VAN RWD NBA		Center Bearing Support	511381
2.0 (72 kw)	1991.04-1994.07		Centre	BUS RWD NCA		Center Bearing Support	511380
	1991.04-1994.07		Centre	BUS RWD NCA		Center Bearing Support	511381
	1991.04-1994.12		Centre	Chassis cabin RWD NCA		Center Bearing Support	511380
	1991.04-1994.12		Centre	Chassis cabin RWD NCA		Center Bearing Support	511381
	1991.09-1994.12		Centre	VAN RWD NCA		Center Bearing Support	511380
	1991.09-1994.12		Centre	VAN RWD NCA		Center Bearing Support	511381
2.0 (84 kw)	1994.08-2000.03		Centre	BUS RWD NSF/NSG/NSH		Center Bearing Support	511381
	1994.08-2000.03		Centre	Chassis cabin RWD NSF/NSG		Center Bearing Support	511381
	1994.08-2000.03		Centre	VAN RWD NSF/NSG/NSH		Center Bearing Support	511381
2.5 (51 kw)	1991.04-1994.07		Centre	BUS RWD 4BC/4CC/4FA		Center Bearing Support	511380
	1991.04-1994.07		Centre	BUS RWD 4BC/4CC/4FA		Center Bearing Support	511381
	1991.09-1994.08		Centre	Chassis cabin RWD 4BC/4CC		Center Bearing Support	511380
	1991.09-1994.08		Centre	Chassis cabin RWD 4BC/4CC		Center Bearing Support	511381
	1991.10-1994.07		Centre	VAN RWD 4BC/4CC/4FA		Center Bearing Support	511380
	1991.10-1994.07		Centre	VAN RWD 4BC/4CC/4FA		Center Bearing Support	511381
	1994.06-2000.03		Centre	VAN RWD 4FA/4FB/4FC/4FD		Center Bearing Support	511380



	 YEAR	TRANSM.	FITTING POSITION	BODY STYLE & DRIVE TYPE & ENGINE	REMARKS	 PRODUCT	GSP Ref.
FORD							
Transit 100							
2.5 (51 kw)	1994.06-2000.03		Centre	VAN RWD 4FA/4FB/4FC/4FD		Center Bearing Support	511381
	1994.08-2000.03		Centre	Chassis cabin RWD 4FB/4FC/4FD		Center Bearing Support	511381
	1994.08-2000.06		Centre	BUS RWD 4FA/4FB/4FC/4FD		Center Bearing Support	511381
2.5 (55 kw)	1994.06-2000.06		Centre	VAN RWD 4HA/4HD		Center Bearing Support	511381
	1994.08-2000.06		Centre	BUS RWD 4HA/4HD		Center Bearing Support	511381
	1994.08-2000.12		Centre	Chassis cabin RWD 4HA/4HD		Center Bearing Support	511381
2.5 (56 kw)	1994.06-2000.06		Centre	VAN RWD 4HB/4HC		Center Bearing Support	511380
	1994.06-2000.06		Centre	VAN RWD 4HB/4HC		Center Bearing Support	511381
	1994.07-2000.03		Centre	BUS RWD 4HB/4HC		Center Bearing Support	511380
	1994.07-2000.03		Centre	BUS RWD 4HB/4HC		Center Bearing Support	511381
	1994.08-2000.03		Centre	Chassis cabin RWD 4HB/4HC		Center Bearing Support	511381
2.5 (59 kw)	1991.04-2001.07		Centre	BUS RWD 4DA		Center Bearing Support	511380
	1991.04-2001.07		Centre	Chassis cabin RWD 4DA		Center Bearing Support	511380
	1991.04-2001.07		Centre	VAN RWD 4DA		Center Bearing Support	511380
	1991.04-2001.07		Centre	BUS RWD 4DA		Center Bearing Support	511381
	1991.04-2001.07		Centre	Chassis cabin RWD 4DA		Center Bearing Support	511381
	1991.04-2001.07		Centre	VAN RWD 4DA		Center Bearing Support	511381
2.5 (63 kw)	1992.10-1994.07		Centre	BUS RWD 4GA		Center Bearing Support	511380
	1992.10-1994.07		Centre	Chassis cabin RWD 4GA		Center Bearing Support	511380
	1992.10-1994.07		Centre	VAN RWD 4GA		Center Bearing Support	511380
	1992.10-1994.07		Centre	BUS RWD 4GA		Center Bearing Support	511381
	1992.10-1994.07		Centre	Chassis cabin RWD 4GA		Center Bearing Support	511381
	1992.10-1994.07		Centre	VAN RWD 4GA		Center Bearing Support	511381
	1994.06-2000.03		Centre	VAN RWD 4GB/4GC/4GF		Center Bearing Support	511381
	1994.08-2000.10		Centre	BUS RWD 4GA/4GB/4GC/4GD/4GE/4GF		Center Bearing Support	511381
	1994.08-2000.10		Centre	Chassis cabin RWD 4GA/4GB/4GC/4GD/4GE/4GF		Center Bearing Support	511381
2.5 (74 kw)	1994.08-1999.12		Centre	VAN RWD 4EC		Center Bearing Support	511381
	1994.08-1999.12		Centre	Chassis cabin RWD 4EB		Center Bearing Support	511381
2.5 (85 kw)	1998.12-2000.06		Centre	BUS RWD 4ED		Center Bearing Support	511381
	1998.12-2000.06		Centre	VAN RWD 4ED		Center Bearing Support	511381
	1998.12-2000.06		Centre	Chassis cabin RWD 4ED		Center Bearing Support	511381
2.9 (107 kw)	1991.11-1994.07		Centre	BUS RWD BRT		Center Bearing Support	511380
	1991.11-1994.07		Centre	BUS RWD BRT		Center Bearing Support	511381
Transit 120							
2.0 (66 kw)	1991.04-1994.07		Centre	BUS RWD NBA		Center Bearing Support	511380
	1991.04-1994.07		Centre	Chassis cabin RWD NBA		Center Bearing Support	511380
	1991.04-1994.07		Centre	BUS RWD NBA		Center Bearing Support	511381
	1991.04-1994.07		Centre	Chassis cabin RWD NBA		Center Bearing Support	511381
	1991.04-1994.12		Centre	VAN RWD NBA		Center Bearing Support	511380
	1991.04-1994.12		Centre	VAN RWD NBA		Center Bearing Support	511381
2.0 (72 kw)	1991.04-1994.07		Centre	BUS RWD NCA		Center Bearing Support	511380
	1991.04-1994.07		Centre	Chassis cabin RWD NCA		Center Bearing Support	511380
	1991.04-1994.07		Centre	BUS RWD NCA		Center Bearing Support	511381
	1991.04-1994.07		Centre	Chassis cabin RWD NCA		Center Bearing Support	511381
	1991.09-1994.06		Centre	VAN RWD NCA		Center Bearing Support	511380
1991.09-1994.06		Centre	VAN RWD NCA		Center Bearing Support	511381	
2.0 (84 kw)	1994.08-2000.03		Centre	Chassis cabin RWD NSF/NSG		Center Bearing Support	511381
2.5 (51 kw)	1991.04-1994.07		Centre	BUS RWD 4BC/4CC		Center Bearing Support	511380
	1991.04-1994.07		Centre	VAN RWD 4BC/4CC		Center Bearing Support	511380
	1991.04-1994.07		Centre	BUS RWD 4BC/4CC		Center Bearing Support	511381
	1991.04-1994.07		Centre	VAN RWD 4BC/4CC		Center Bearing Support	511381
	1991.09-1994.08		Centre	Chassis cabin RWD 4BC/4CC/4FA		Center Bearing Support	511380
	1991.09-1994.08		Centre	Chassis cabin RWD 4BC/4CC/4FA		Center Bearing Support	511381
	1994.08-2000.03		Centre	Chassis cabin RWD 4FA/4FC/4FD		Center Bearing Support	511381
	1994.08-2000.12		Centre	Chassis cabin RWD 4HA/4HD		Center Bearing Support	511381
2.5 (55 kw)	1994.08-2000.12		Centre	Chassis cabin RWD 4HA/4HD		Center Bearing Support	511381
2.5 (56 kw)	1994.08-2000.03		Centre	Chassis cabin RWD 4HB/4HC		Center Bearing Support	511381
2.5 (59 kw)	1991.04-1994.07		Centre	BUS RWD 4DA		Center Bearing Support	511380
	1991.04-1994.07		Centre	Chassis cabin RWD 4DA		Center Bearing Support	511380
	1991.04-1994.07		Centre	VAN RWD 4DA		Center Bearing Support	511380
	1991.04-1994.07		Centre	BUS RWD 4DA		Center Bearing Support	511381
	1991.04-1994.07		Centre	Chassis cabin RWD 4DA		Center Bearing Support	511381
	1991.04-1994.07		Centre	VAN RWD 4DA		Center Bearing Support	511381
2.5 (63 kw)	1992.10-1994.07		Centre	BUS RWD 4GA		Center Bearing Support	511380
	1992.10-1994.07		Centre	VAN RWD 4GA		Center Bearing Support	511380



	 YEAR	TRANSM.	FITTING POSITION	BODY STYLE & DRIVE TYPE & ENGINE	REMARKS	 PRODUCT	GSP Ref.
FORD							
Transit 120							
2.5 (63 kw)	1992.10-1994.07		Centre	BUS RWD 4GA		Center Bearing Support	511381
	1992.10-1994.07		Centre	VAN RWD 4GA		Center Bearing Support	511381
	1994.08-2000.10		Centre	Chassis cabin RWD 4GA/4GB/4GC/4GD/4GE/4GF		Center Bearing Support	511381
2.5 (74 kw)	1991.04-1994.07		Centre	BUS RWD 4EA		Center Bearing Support	511380
	1991.04-1994.07		Centre	VAN RWD 4EA		Center Bearing Support	511380
	1991.04-1994.07		Centre	BUS RWD 4EA		Center Bearing Support	511381
	1991.04-1994.07		Centre	VAN RWD 4EA		Center Bearing Support	511381
Transit 150							
2.0 (66 kw)	1991.04-1994.06		Centre	VAN RWD NBA		Center Bearing Support	511380
	1991.04-1994.06		Centre	VAN RWD NBA		Center Bearing Support	511381
	1991.04-2001.07		Centre	Chassis cabin RWD NBA		Center Bearing Support	511380
	1991.04-2001.07		Centre	Chassis cabin RWD NBA		Center Bearing Support	511381
2.0 (72 kw)	1991.04-1994.07		Centre	BUS RWD NCA		Center Bearing Support	511380
	1991.04-1994.07		Centre	Chassis cabin RWD NCA		Center Bearing Support	511380
	1991.04-1994.07		Centre	BUS RWD NCA		Center Bearing Support	511381
2.0 (84 kw)	1991.04-1994.07		Centre	Chassis cabin RWD NCA		Center Bearing Support	511381
	1994.08-2000.03		Centre	BUS RWD NSF/NSG/NSH		Center Bearing Support	511381
	1994.08-2000.03		Centre	Chassis cabin RWD NSF/NSG		Center Bearing Support	511381
2.5 (51 kw)	1994.08-2000.03		Centre	VAN RWD NSF/NSG/NSH		Center Bearing Support	511381
	1991.04-1994.07		Centre	BUS RWD 4BC/4CC		Center Bearing Support	511380
	1991.04-1994.07		Centre	VAN RWD 4CC/4FA		Center Bearing Support	511380
2.5 (55 kw)	1991.04-1994.07		Centre	BUS RWD 4BC/4CC		Center Bearing Support	511381
	1991.04-1994.07		Centre	VAN RWD 4CC/4FA		Center Bearing Support	511381
	1991.04-1994.07		Centre	BUS RWD 4BC/4CC		Center Bearing Support	511381
	1991.04-1994.07		Centre	VAN RWD 4CC/4FA		Center Bearing Support	511381
	1991.04-1994.08		Centre	Chassis cabin RWD 4BC/4CC/4FA		Center Bearing Support	511380
2.5 (56 kw)	1991.04-1994.08		Centre	Chassis cabin RWD 4BC/4CC/4FA		Center Bearing Support	511381
	1994.08-2000.06		Centre	BUS RWD 4HA/4HD		Center Bearing Support	511381
	1994.08-2000.06		Centre	VAN RWD 4HA/4HD		Center Bearing Support	511381
2.5 (59 kw)	1994.08-2000.12		Centre	Chassis cabin RWD 4HA/4HD		Center Bearing Support	511381
	1994.08-2000.06		Centre	VAN RWD 4HC		Center Bearing Support	511380
	1994.08-2000.06		Centre	VAN RWD 4HC		Center Bearing Support	511381
2.5 (63 kw)	1991.04-2001.07		Centre	BUS RWD 4DA		Center Bearing Support	511380
	1991.04-2001.07		Centre	Chassis cabin RWD 4DA		Center Bearing Support	511380
	1991.04-2001.07		Centre	BUS RWD 4DA		Center Bearing Support	511381
	1991.04-2001.07		Centre	Chassis cabin RWD 4DA		Center Bearing Support	511381
2.5 (74 kw)	1992.10-1994.07		Centre	BUS RWD 4GA		Center Bearing Support	511380
	1992.10-1994.07		Centre	VAN RWD 4GA		Center Bearing Support	511380
	1992.10-1994.07		Centre	BUS RWD 4GA		Center Bearing Support	511381
	1992.10-1994.07		Centre	VAN RWD 4GA		Center Bearing Support	511381
	1994.06-2000.03		Centre	VAN RWD 4GA/4GB/4GC/4GD/4GE/4GF		Center Bearing Support	511381
	1994.08-2000.10		Centre	BUS RWD 4GA/4GB/4GC/4GD/4GE/4GF		Center Bearing Support	511381
	1994.08-2000.10		Centre	Chassis cabin RWD 4GA/4GB/4GC/4GD/4GE/4GF		Center Bearing Support	511381
2.5 (85 kw)	1994.08-1999.12		Centre	BUS RWD 4EB/4EC		Center Bearing Support	511381
	1994.08-1999.12		Centre	Chassis cabin RWD 4EB		Center Bearing Support	511381
	1994.08-1999.12		Centre	VAN RWD 4EB/4EC		Center Bearing Support	511381
2.5 (85 kw)	1998.12-2000.06		Centre	BUS RWD 4ED		Center Bearing Support	511381
	1998.12-2000.06		Centre	VAN RWD 4ED		Center Bearing Support	511381
	1998.12-2000.06		Centre	Chassis cabin RWD 4ED		Center Bearing Support	511381
Transit 190							
2.0 (66 kw)	1991.04-1994.06		Centre	VAN RWD NBA		Center Bearing Support	511380
	1991.04-1994.06		Centre	VAN RWD NBA		Center Bearing Support	511381
	1991.04-1994.07		Centre	Chassis cabin RWD NBA		Center Bearing Support	511380
	1991.04-1994.07		Centre	Chassis cabin RWD NBA		Center Bearing Support	511381
2.0 (72 kw)	1991.04-1994.07		Centre	Chassis cabin RWD NCA		Center Bearing Support	511380
	1991.04-1994.07		Centre	Chassis cabin RWD NCA		Center Bearing Support	511381
	1991.09-1994.06		Centre	VAN RWD NCA		Center Bearing Support	511380
2.0 (84 kw)	1991.09-1994.06		Centre	VAN RWD NCA		Center Bearing Support	511381
	1994.08-2000.03		Centre	Chassis cabin RWD NSF/NSG		Center Bearing Support	511381
	1994.08-2000.03		Centre	VAN RWD NSF/NSG/NSH		Center Bearing Support	511381
2.5 (51 kw)	1991.04-1994.06		Centre	VAN RWD 4BC/4FA		Center Bearing Support	511380
	1991.04-1994.06		Centre	VAN RWD 4BC/4FA		Center Bearing Support	511381
	1991.04-1994.07		Centre	BUS RWD 4FA		Center Bearing Support	511380
	1991.04-1994.07		Centre	BUS RWD 4FA		Center Bearing Support	511381
	1991.04-2001.07		Centre	Chassis cabin RWD 4BC/4CC/4FA		Center Bearing Support	511380
	1991.04-2001.07		Centre	Chassis cabin RWD 4BC/4CC/4FA		Center Bearing Support	511381



	 YEAR	TRANSM.	FITTING POSITION	BODY STYLE & DRIVE TYPE & ENGINE	REMARKS	 PRODUCT	GSP Ref.
FORD							
Transit 190							
2.5 (55 kw)	1994.08-1997.10		Centre	Chassis cabin RWD 4HA/4HD		Center Bearing Support	511381
2.5 (56 kw)	1994.08-1997.10		Centre	VAN RWD 4HC		Center Bearing Support	511380
	1994.08-1997.10		Centre	VAN RWD 4HC		Center Bearing Support	511381
2.5 (59 kw)	1991.04-2001.07		Centre	VAN RWD 4DA		Center Bearing Support	511380
	1991.04-2001.07		Centre	Chassis cabin RWD 4DA		Center Bearing Support	511380
	1991.04-2001.07		Centre	VAN RWD 4DA		Center Bearing Support	511381
	1991.04-2001.07		Centre	Chassis cabin RWD 4DA		Center Bearing Support	511381
2.5 (63 kw)	1994.06-2000.03		Centre	VAN RWD 4GA/4GB/4GC/4GD/4GE/4GF		Center Bearing Support	511381
	1994.08-2000.10		Centre	Chassis cabin RWD 4GA/4GB/4GC/4GD/4GE/4GF		Center Bearing Support	511381
2.5 (74 kw)	1991.04-1994.07		Centre	VAN RWD 4EA		Center Bearing Support	511380
	1991.04-1994.07		Centre	Chassis cabin RWD 4EA		Center Bearing Support	511380
	1991.04-1994.07		Centre	VAN RWD 4EA		Center Bearing Support	511381
	1991.04-1994.07		Centre	Chassis cabin RWD 4EA		Center Bearing Support	511381
	1994.06-2000.08		Centre	VAN RWD 4EB/4EC		Center Bearing Support	511381
2.5 (85 kw)	1994.08-2000.08		Centre	Chassis cabin RWD 4EB/4EC		Center Bearing Support	511381
	1998.12-2000.06		Centre	BUS RWD 4ED		Center Bearing Support	511381
	1998.12-2000.06		Centre	VAN RWD 4ED		Center Bearing Support	511381
	1998.12-2000.06		Centre	Chassis cabin RWD 4ED		Center Bearing Support	511381
Transit 230							
2.5 (63 kw)	1994.08-2000.10		Centre	Chassis cabin RWD 4GA/4GB/4GC/4GD/4GE/4GF		Center Bearing Support	511381
2.5 (74 kw)	1995.02-2000.08		Centre	Chassis cabin RWD 4EC		Center Bearing Support	511381
	1995.02-2000.08		Centre	VAN RWD 4EB/4EC		Center Bearing Support	511381
Transit 260							
2.0 (55 kw)	2000.06-2003.08		Centre	BUS FWD D3FA		Center Bearing Support	511381
	2000.06-2006.03		Centre	VAN FWD D3FA		Center Bearing Support	511381
	2000.08-2006.05		Centre	Chassis cabin FWD D3FA		Center Bearing Support	511381
2.0 (63 kw)	2000.06-2006.03		Centre	BUS FWD F3FA		Center Bearing Support	511381
	2000.06-2006.03		Centre	Chassis cabin FWD F3FA		Center Bearing Support	511381
	2000.06-2006.03		Centre	VAN FWD F3FA		Center Bearing Support	511381
2.0 (74 kw)	2000.06-2006.03		Centre	BUS FWD ABFA		Center Bearing Support	511381
	2000.06-2006.03		Centre	Chassis cabin FWD ABFA		Center Bearing Support	511381
	2000.06-2006.03		Centre	VAN FWD ABFA		Center Bearing Support	511381
2.0 (92 kw)	2002.03-2006.03		Centre	VAN FWD F1FA		Center Bearing Support	511381
2.2 (63 kw)	2006.04-2014.08		Centre	VAN FWD P8FA		Center Bearing Support	511381
	2006.04-2014.08		Centre	VAN FWD P8FA		Center Bearing Support Kit	537769
2.2 (81 kw)	2006.04-2014.08		Centre	VAN FWD QVFA		Center Bearing Support	511381
	2006.04-2014.08		Centre	VAN FWD QVFA		Center Bearing Support Kit	537769
2.2 (85 kw)	2008.10-2014.08		Centre	VAN FWD SRFA/SRFB/SRFC/SRFD/SRFE		Center Bearing Support Kit	537769
2.2 (96 kw)	2006.04-2014.08		Centre	VAN FWD QWFA		Center Bearing Support	511381
	2006.04-2014.08		Centre	VAN FWD QWFA		Center Bearing Support Kit	537769
2.2 (103 kw)	2007.09-2014.08		Centre	VAN FWD PGFA/PGFB/UHFA/UHFB/UHFC		Center Bearing Support Kit	537769
2.4 (88 kw)	2000.08-2003.08		Centre	Chassis cabin RWD D4FA		Center Bearing Support	511381
	2000.08-2003.08		Centre	VAN RWD D4FA		Center Bearing Support	511381
	2000.08-2003.08		Front	Chassis cabin RWD D4FA	6MT,Transm.Type:MT82	Flexible Coupling	533418
	2000.08-2003.08		Front	VAN RWD D4FA	6MT,Transm.Type:MT82	Flexible Coupling	533418
	2000.08-2003.08		Front	Chassis cabin RWD D4FA	Transm. Type:MT75,5MT	Flexible Coupling	533420
	2000.08-2003.08		Front	VAN RWD D4FA	Transm. Type:MT75,5MT	Flexible Coupling	533420
Transit 280							
2.0 (55 kw)	2000.06-2003.08		Centre	BUS FWD D3FA		Center Bearing Support	511381
	2000.06-2003.08		Centre	Chassis cabin FWD D3FA		Center Bearing Support	511381
	2000.06-2003.08		Centre	VAN FWD D3FA		Center Bearing Support	511381
2.0 (63 kw)	2000.06-2006.03		Centre	BUS FWD F3FA		Center Bearing Support	511381
	2000.06-2006.03		Centre	Chassis cabin FWD F3FA		Center Bearing Support	511381
	2000.06-2006.03		Centre	VAN FWD F3FA		Center Bearing Support	511381
2.0 (74 kw)	2000.06-2006.03		Centre	BUS FWD ABFA		Center Bearing Support	511381
	2000.06-2006.03		Centre	Chassis cabin FWD ABFA		Center Bearing Support	511381
	2000.06-2006.03		Centre	VAN FWD ABFA		Center Bearing Support	511381
2.0 (92 kw)	2002.03-2006.03		Centre	BUS FWD F1FA		Center Bearing Support	511381
	2002.03-2006.03		Centre	Chassis cabin FWD F1FA		Center Bearing Support	511381
	2002.03-2006.03		Centre	VAN FWD F1FA		Center Bearing Support	511381
2.2 (63 kw)	2006.04-2014.08		Centre	BUS FWD P8FA/P8FB		Center Bearing Support	511381
	2006.04-2014.08		Centre	VAN FWD P8FA		Center Bearing Support	511381
	2006.04-2014.08		Centre	BUS FWD P8FA/P8FB		Center Bearing Support Kit	537769
	2006.04-2014.08		Centre	VAN FWD P8FA		Center Bearing Support Kit	537769



	 YEAR	TRANSM.	FITTING POSITION	BODY STYLE & DRIVE TYPE & ENGINE	REMARKS	 PRODUCT	GSP Ref.
FORD							
Transit 280							
2.2 (81 kw)	2006.04-2014.08		Centre	BUS FWD QVFA		Center Bearing Support	511381
	2006.04-2014.08		Centre	VAN FWD QVFA		Center Bearing Support	511381
	2006.04-2014.08		Centre	BUS FWD QVFA		Center Bearing Support Kit	537769
	2006.04-2014.08		Centre	VAN FWD QVFA		Center Bearing Support Kit	537769
2.2 (85 kw)	2008.10-2014.08		Centre	BUS FWD SRFA/SRFB/SRFC/SRFD/SRFE		Center Bearing Support Kit	537769
	2008.10-2014.08		Centre	VAN FWD SRFA/SRFB/SRFC/SRFD/SRFE		Center Bearing Support Kit	537769
2.2 (96 kw)	2006.04-2014.08		Centre	BUS FWD QWFA		Center Bearing Support	511381
	2006.04-2014.08		Centre	VAN FWD QWFA		Center Bearing Support	511381
	2006.04-2014.08		Centre	BUS FWD QWFA		Center Bearing Support Kit	537769
	2006.04-2014.08		Centre	VAN FWD QWFA		Center Bearing Support Kit	537769
2.2 (103 kw)	2007.09-2014.08		Centre	BUS FWD PGFA/PGFB/UHFA/UHFB/UHFC		Center Bearing Support Kit	537769
	2007.09-2014.08		Centre	VAN FWD PGFA/PGFB/UHFA/UHFB/UHFC		Center Bearing Support Kit	537769
2.4 (88 kw)	2000.08-2003.08		Centre	Chassis cabin RWD D4FA		Center Bearing Support	511381
	2000.08-2003.08		Centre	VAN RWD D4FA		Center Bearing Support	511381
	2000.08-2003.08		Front	Chassis cabin RWD D4FA	6MT,Transm.Type:MT82	Flexible Coupling	533418
	2000.08-2003.08		Front	VAN RWD D4FA	6MT,Transm.Type:MT82	Flexible Coupling	533418
	2000.08-2003.08		Front	Chassis cabin RWD D4FA	Transm. Type:MT75,5MT	Flexible Coupling	533420
	2000.08-2003.08		Front	VAN RWD D4FA	Transm. Type:MT75,5MT	Flexible Coupling	533420
Transit 300							
2.0 (55 kw)	2000.06-2003.08		Centre	Chassis cabin FWD D3FA		Center Bearing Support	511381
	2000.09-2003.08		Centre	BUS FWD D3FA		Center Bearing Support	511381
2.0 (63 kw)	2000.06-2006.03		Centre	BUS FWD F3FA		Center Bearing Support	511381
	2000.06-2006.03		Centre	Chassis cabin FWD F3FA		Center Bearing Support	511381
	2000.06-2006.03		Centre	VAN FWD F3FA		Center Bearing Support	511381
2.0 (74 kw)	2000.06-2006.03		Centre	BUS FWD ABFA		Center Bearing Support	511381
	2000.06-2006.03		Centre	Chassis cabin FWD ABFA		Center Bearing Support	511381
	2000.06-2006.03		Centre	VAN FWD ABFA		Center Bearing Support	511381
2.0 (92 kw)	2002.09-2006.03		Centre	BUS FWD F1FA		Center Bearing Support	511381
	2002.09-2006.03		Centre	Chassis cabin FWD F1FA		Center Bearing Support	511381
	2002.09-2006.03		Centre	VAN FWD F1FA		Center Bearing Support	511381
2.2 (63 kw)	2006.04-2014.08		Centre	BUS FWD P8FA/P8FB		Center Bearing Support	511381
	2006.04-2014.08		Centre	Chassis cabin FWD P8FA/P8FB		Center Bearing Support	511381
	2006.04-2014.08		Centre	VAN FWD P8FA/P8FB		Center Bearing Support	511381
	2006.04-2014.08		Centre	BUS FWD P8FA/P8FB		Center Bearing Support Kit	537769
	2006.04-2014.08		Centre	Chassis cabin FWD P8FA/P8FB		Center Bearing Support Kit	537769
	2006.04-2014.08		Centre	VAN FWD P8FA/P8FB		Center Bearing Support Kit	537769
2.2 (74 kw)	2011.10-2014.08		Front	Chassis cabin RWD DRRR/DRRB/DRRC	6MT	Flexible Coupling	533418
	2011.10-2014.08		Front	VAN RWD DRRR/DRRB/DRRC	6MT	Flexible Coupling	533418
	2011.10-2014.08		Front	Chassis cabin RWD DRRR/DRRB/DRRC	Transm. Type:MT75,5MT	Flexible Coupling	533420
	2011.10-2014.08		Front	VAN RWD DRRR/DRRB/DRRC	Transm. Type:MT75,5MT	Flexible Coupling	533420
2.2 (81 kw)	2006.04-2014.08		Centre	BUS FWD QVFA		Center Bearing Support	511381
	2006.04-2014.08		Centre	Chassis cabin FWD QVFA		Center Bearing Support	511381
	2006.04-2014.08		Centre	VAN FWD QVFA		Center Bearing Support	511381
	2006.04-2014.08		Centre	BUS FWD QVFA		Center Bearing Support Kit	537769
	2006.04-2014.08		Centre	Chassis cabin FWD QVFA		Center Bearing Support Kit	537769
	2006.04-2014.08		Centre	VAN FWD QVFA		Center Bearing Support Kit	537769
2.2 (85 kw)	2008.10-2014.08		Centre	BUS FWD SRFA/SRFB/SRFC/SRFD/SRFE		Center Bearing Support Kit	537769
	2008.10-2014.08		Centre	Chassis cabin FWD SRFA/SRFB/SRFC/SRFD/SRFE		Center Bearing Support Kit	537769
	2008.10-2014.08		Centre	VAN FWD SRFA/SRFB/SRFC/SRFD/SRFE		Center Bearing Support Kit	537769
2.2 (92 kw)	2011.09-2014.12		Front	VAN RWD CYRA	6MT	Flexible Coupling	533418
	2011.09-2014.12		Front	VAN RWD CYRA	Transm. Type:MT75,5MT	Flexible Coupling	533420
2.2 (96 kw)	2006.04-2014.08		Centre	BUS FWD QWFA		Center Bearing Support	511381
	2006.04-2014.08		Centre	Chassis cabin FWD QWFA		Center Bearing Support	511381
	2006.04-2014.08		Centre	VAN FWD QWFA		Center Bearing Support	511381
	2006.04-2014.08		Centre	BUS FWD QWFA		Center Bearing Support Kit	537769
	2006.04-2014.08		Centre	Chassis cabin FWD QWFA		Center Bearing Support Kit	537769
	2006.04-2014.08		Centre	VAN FWD QWFA		Center Bearing Support Kit	537769
2.2 (103 kw)	2007.09-2014.08		Centre	BUS FWD PGFA/PGFB/UHFA/UHFB/UHFC		Center Bearing Support Kit	537769
	2007.09-2014.08		Centre	Chassis cabin FWD PGFA/PGFB/UHFA/UHFB/UHFC		Center Bearing Support Kit	537769
	2007.09-2014.08		Centre	VAN FWD PGFA/PGFB/UHFA/UHFB/UHFC		Center Bearing Support Kit	537769
2.3 (100 kw)	2006.04-2014.08		Centre	Chassis cabin RWD GZFC		Center Bearing Support	511381
	2006.04-2014.08		Centre	VAN RWD GZFC		Center Bearing Support	511381
	2006.04-2014.08		Front	Chassis cabin RWD GZFC	6MT	Flexible Coupling	533418
	2006.04-2014.08		Front	VAN RWD GZFC	6MT	Flexible Coupling	533418



	 YEAR	TRANSM.	FITTING POSITION	BODY STYLE & DRIVE TYPE & ENGINE	REMARKS	 PRODUCT	GSP Ref.
FORD Transit 300							
2.3 (100 kw)	2006.04-2014.08		Front	Chassis cabin RWD GZFC	For OE No.4393343	Flexible Coupling	533420
	2006.04-2014.08		Front	VAN RWD GZFC	For OE No.4393343	Flexible Coupling	533420
2.3 (105 kw)	2001.03-2006.03		Front	VAN RWD E5FC	For OE No.4165078	Flexible Coupling	533418
	2001.03-2006.03		Front	VAN RWD E5FC	For OE No.4393343	Flexible Coupling	533420
2.3 (107 kw)	2006.04-2014.08		Centre	Chassis cabin RWD GZFA/GZFB/GZFC		Center Bearing Support	511381
	2006.04-2014.08		Centre	Chassis cabin RWD GZFC		Center Bearing Support	511381
	2006.04-2014.08		Centre	VAN RWD GZFC		Center Bearing Support	511381
	2006.04-2014.08		Front	Chassis cabin RWD GZFA/GZFB/GZFC	6MT,Transm.Type:MT82	Flexible Coupling	533418
	2006.04-2014.08		Front	Chassis cabin RWD GZFC	6MT	Flexible Coupling	533418
	2006.04-2014.08		Front	VAN RWD GZFC	6MT	Flexible Coupling	533418
	2006.04-2014.08		Front	Chassis cabin RWD GZFA/GZFB/GZFC	Transm. Type:MT75,5MT	Flexible Coupling	533420
	2006.04-2014.08		Front	Chassis cabin RWD GZFC	For OE No.4393343	Flexible Coupling	533420
	2006.04-2014.08		Front	VAN RWD GZFC	For OE No.4393343	Flexible Coupling	533420
	2006.06-2014.08		Centre	VAN RWD GZFA/GZFB/GZFC		Center Bearing Support	511381
	2006.06-2014.08		Front	VAN RWD GZFA/GZFB/GZFC	6MT,Transm.Type:MT82	Flexible Coupling	533418
	2006.06-2014.08		Front	VAN RWD GZFA/GZFB/GZFC	Transm. Type:MT75,5MT	Flexible Coupling	533420
2.4 (66 kw)	2000.01-2006.05		Centre	Chassis cabin RWD D2FA/D2FB		Center Bearing Support	511381
	2000.01-2006.05		Front	Chassis cabin RWD D2FA/D2FB	6MT	Flexible Coupling	533418
	2000.01-2006.05		Front	Chassis cabin RWD D2FA/D2FB	Transm. Type:MT75,5MT	Flexible Coupling	533420
	2001.10-2006.03		Centre	VAN RWD D2FA		Center Bearing Support	511381
	2001.10-2006.03		Front	VAN RWD D2FA	6MT	Flexible Coupling	533418
2.4 (74 kw)	2001.10-2006.03		Front	VAN RWD D2FA	Transm. Type:MT75,5MT	Flexible Coupling	533420
	2006.04-2014.08		Centre	Chassis cabin RWD PHFA/PHFC		Center Bearing Support	511381
	2006.04-2014.08		Centre	VAN RWD PHFA/PHFC		Center Bearing Support	511381
	2006.04-2014.08		Centre	Chassis cabin RWD PHFA/PHFC		Center Bearing Support Kit	537769
	2006.04-2014.08		Centre	VAN RWD PHFA/PHFC		Center Bearing Support Kit	537769
	2006.04-2014.08		Front	Chassis cabin RWD PHFA/PHFC	6MT	Flexible Coupling	533418
	2006.04-2014.08		Front	VAN RWD PHFA/PHFC	6MT	Flexible Coupling	533418
2.4 (85 kw)	2006.04-2014.08		Front	Chassis cabin RWD PHFA/PHFC	Transm. Type:MT75,5MT	Flexible Coupling	533420
	2006.04-2014.08		Front	VAN RWD PHFA/PHFC	Transm. Type:MT75,5MT	Flexible Coupling	533420
	2004.01-2006.03		Centre	BUS RWD FXFA		Center Bearing Support	511381
	2004.01-2006.03		Centre	Chassis cabin RWD FXFA		Center Bearing Support	511381
	2004.01-2006.03		Centre	VAN RWD FXFA		Center Bearing Support	511381
	2004.01-2006.03		Front	BUS RWD FXFA	6MT	Flexible Coupling	533418
	2004.01-2006.03		Front	Chassis cabin RWD FXFA	6MT	Flexible Coupling	533418
	2004.01-2006.03		Front	VAN RWD FXFA	6MT	Flexible Coupling	533418
	2004.01-2006.03		Front	BUS RWD FXFA	Transm. Type:MT75,5MT	Flexible Coupling	533420
	2004.01-2006.03		Front	Chassis cabin RWD FXFA	Transm. Type:MT75,5MT	Flexible Coupling	533420
	2004.01-2006.03		Front	VAN RWD FXFA	Transm. Type:MT75,5MT	Flexible Coupling	533420
	2006.04-2014.08		Centre	VAN RWD JXFA/JXFC		Center Bearing Support	511381
2006.04-2014.08		Centre	VAN RWD JXFA/JXFC		Center Bearing Support Kit	537769	
2006.04-2014.08		Front	VAN RWD JXFA/JXFC	6MT	Flexible Coupling	533418	
2006.04-2014.08		Front	VAN RWD JXFA/JXFC	Transm. Type:MT75,5MT	Flexible Coupling	533420	
2.4 (92 kw)	2001.10-2006.03		Centre	VAN RWD DOFA		Center Bearing Support	511381
	2001.10-2006.03		Front	VAN RWD DOFA	6MT	Flexible Coupling	533418
	2001.10-2006.03		Front	VAN RWD DOFA	Transm. Type:MT75,5MT	Flexible Coupling	533420
Transit 310							
2.0 (77 kw)	2016.03-		Centre	Chassis cabin RWD YLR6		Center Bearing Support	511381
	2016.03-		Front	Chassis cabin RWD YLR6		Flexible Coupling	533418
2.0 (96 kw)	2016.03-		Centre	Chassis cabin 4WD YMR6		Center Bearing Support	511381
	2016.03-		Centre	Chassis cabin RWD YMR6		Center Bearing Support	511381
	2016.03-		Front	Chassis cabin 4WD YMR6		Flexible Coupling	533418
	2016.03-		Front	Chassis cabin RWD YMR6		Flexible Coupling	533418
	2019.05-		Centre	Chassis cabin RWD BKRB		Center Bearing Support	511381
	2019.05-		Front	Chassis cabin RWD BKRB		Flexible Coupling	533418
2.0 (125 kw)	2019.05-		Centre	Chassis cabin RWD BLHA		Center Bearing Support	511381
	2019.05-		Front	Chassis cabin RWD BLHA		Flexible Coupling	533418
2.2 (74 kw)	2013.08-2018.12		Centre	Chassis cabin RWD DRR5		Center Bearing Support	511381
	2013.08-2018.12		Front	Chassis cabin RWD DRR5		Flexible Coupling	533418
2.2 (92 kw)	2013.08-2018.12		Centre	Chassis cabin RWD CYR5/USR6		Center Bearing Support	511381
	2013.08-2018.12		Front	Chassis cabin RWD CYR5/USR6		Flexible Coupling	533418
2.2 (114 kw)	2013.08-2018.12		Centre	Chassis cabin RWD CV24/CVR5/UUR6		Center Bearing Support	511381
	2013.08-2018.12		Front	Chassis cabin RWD CV24/CVR5/UUR6		Flexible Coupling	533418



	 YEAR	TRANSM.	FITTING POSITION	BODY STYLE & DRIVE TYPE & ENGINE	REMARKS	 PRODUCT	GSP Ref.
FORD Transit 330							
2.0 (74 kw)	2000.06-2006.05		Centre	Chassis cabin FWD ABFA		Center Bearing Support	511381
	2000.06-2006.05		Centre	VAN FWD ABFA		Center Bearing Support	511381
2.0 (77 kw)	2016.03-		Centre	Chassis cabin RWD YLR6		Center Bearing Support	511381
	2016.03-		Front	Chassis cabin RWD YLR6		Flexible Coupling	533418
2.0 (92 kw)	2000.06-2006.05		Centre	Chassis cabin FWD FIFA		Center Bearing Support	511381
	2000.06-2006.05		Centre	VAN FWD FIFA		Center Bearing Support	511381
2.0 (96 kw)	2016.03-		Centre	Chassis cabin 4WD BKRA/YMR6/YMRA		Center Bearing Support	511381
	2016.03-		Centre	Chassis cabin RWD BKRA/YMR6		Center Bearing Support	511381
	2016.03-		Front	Chassis cabin 4WD BKRA/YMR6/YMRA		Flexible Coupling	533418
	2016.03-		Front	Chassis cabin RWD BKRA/YMR6		Flexible Coupling	533418
	2019.05-		Centre	Chassis cabin RWD BKR6		Center Bearing Support	511381
	2019.05-		Front	Chassis cabin RWD BKR6		Flexible Coupling	533418
2.0 (125 kw)	2019.05-		Centre	Chassis cabin 4WD BLRA		Center Bearing Support	511381
	2019.05-		Centre	Chassis cabin RWD BLHA		Center Bearing Support	511381
	2019.05-		Front	Chassis cabin 4WD BLRA		Flexible Coupling	533418
	2019.05-		Front	Chassis cabin RWD BLHA		Flexible Coupling	533418
2.2 (74 kw)	2011.10-2014.08		Front	BUS RWD DRR4/DRRB/DRRC	6MT	Flexible Coupling	533418
	2011.10-2014.08		Front	VAN RWD DRR4/DRRB/DRRC	6MT	Flexible Coupling	533418
	2011.10-2014.08		Front	Chassis cabin RWD DRR4/DRRB/DRRC	6MT	Flexible Coupling	533418
	2011.10-2014.08		Front	BUS RWD DRR4/DRRB/DRRC	Transm.Type:MT75,5MT	Flexible Coupling	533420
	2011.10-2014.08		Front	VAN RWD DRR4/DRRB/DRRC	Transm.Type:MT75,5MT	Flexible Coupling	533420
	2011.10-2014.08		Front	Chassis cabin RWD DRR4/DRRB/DRRC	Transm.Type:MT75,5MT	Flexible Coupling	533420
	2013.08-2018.12		Centre	Chassis cabin RWD DRR5		Center Bearing Support	511381
	2013.08-2018.12		Front	Chassis cabin RWD DRR5		Flexible Coupling	533418
2.2 (81 kw)	2006.04-2014.08		Centre	BUS FWD QVFA		Center Bearing Support	511381
	2006.04-2014.08		Centre	VAN FWD QVFA		Center Bearing Support	511381
	2006.04-2014.08		Centre	BUS FWD QVFA		Center Bearing Support Kit	537769
	2006.04-2014.08		Centre	VAN FWD QVFA		Center Bearing Support Kit	537769
2.2 (85 kw)	2008.10-2014.08		Centre	BUS FWD SRFA/SRFB/SRFC/SRFD/SRFE		Center Bearing Support Kit	537769
	2008.10-2014.08		Centre	VAN FWD SRFA/SRFB/SRFC/SRFD/SRFE		Center Bearing Support Kit	537769
	2008.10-2014.08		Centre	Chassis cabin FWD SRFA/SRFB/SRFC/SRFD/SRFE		Center Bearing Support Kit	537769
2.2 (92 kw)	2011.09-2014.12		Front	BUS RWD CYRA	6MT	Flexible Coupling	533418
	2011.09-2014.12		Front	VAN RWD CYRA	6MT	Flexible Coupling	533418
	2011.09-2014.12		Front	BUS RWD CYRA	Transm.Type:MT75,5MT	Flexible Coupling	533420
	2011.09-2014.12		Front	VAN RWD CYRA	Transm.Type:MT75,5MT	Flexible Coupling	533420
	2011.10-2014.08		Front	VAN 4WD CYRB/CYRC	6MT	Flexible Coupling	533418
	2011.10-2014.08		Front	Chassis cabin 4WD CYRB/CYRC	6MT	Flexible Coupling	533418
	2011.10-2014.08		Front	Chassis cabin RWD CYRA	6MT	Flexible Coupling	533418
	2011.10-2014.08		Front	VAN 4WD CYRB/CYRC	Transm.Type:MT75,5MT	Flexible Coupling	533420
	2011.10-2014.08		Front	Chassis cabin 4WD CYRB/CYRC	Transm.Type:MT75,5MT	Flexible Coupling	533420
	2011.10-2014.08		Front	Chassis cabin RWD CYRA	Transm.Type:MT75,5MT	Flexible Coupling	533420
	2013.08-2018.12		Centre	Chassis cabin 4WD CY24/CYR5		Center Bearing Support	511381
	2013.08-2018.12		Centre	Chassis cabin RWD CYR5/USR6		Center Bearing Support	511381
	2013.08-2018.12		Front	Chassis cabin 4WD CY24/CYR5		Flexible Coupling	533418
	2013.08-2018.12		Front	Chassis cabin RWD CYR5/USR6		Flexible Coupling	533418
2.2 (96 kw)	2006.04-2014.08		Centre	BUS FWD QWFA		Center Bearing Support	511381
	2006.04-2014.08		Centre	VAN FWD QWFA		Center Bearing Support	511381
	2006.04-2014.08		Centre	BUS FWD QWFA		Center Bearing Support Kit	537769
	2006.04-2014.08		Centre	VAN FWD QWFA		Center Bearing Support Kit	537769
2.2 (103 kw)	2007.09-2014.08		Centre	BUS FWD PGFA/PGFB/UHFA/UHFB/UHFC		Center Bearing Support Kit	537769
	2007.09-2014.08		Centre	VAN FWD PGFA/PGFB/UHFA/UHFB/UHFC		Center Bearing Support Kit	537769
	2007.10-2014.08		Centre	Chassis cabin FWD PGFA/PGFB/UHFA/UHFB/UHFC		Center Bearing Support Kit	537769
2.2 (114 kw)	2011.10-2014.08		Front	Chassis cabin RWD CVRA/CVRB/CVRC	6MT	Flexible Coupling	533418
	2011.10-2014.08		Front	VAN RWD CVRA/CVRB/CVRC	6MT	Flexible Coupling	533418
	2011.10-2014.08		Front	Chassis cabin RWD CVRA/CVRB/CVRC	Transm.Type:MT75,5MT	Flexible Coupling	533420
	2011.10-2014.08		Front	VAN RWD CVRA/CVRB/CVRC	Transm.Type:MT75,5MT	Flexible Coupling	533420
	2013.08-2018.12		Centre	Chassis cabin RWD CV24/CVR5/UYR6		Center Bearing Support	511381
	2013.08-2018.12		Front	Chassis cabin RWD CV24/CVR5/UYR6		Flexible Coupling	533418
2.3 (105 kw)	2001.03-2006.03		Front	VAN RWD E5FC	For OE No.4165078	Flexible Coupling	533418
	2001.03-2006.03		Front	VAN RWD E5FC	For OE No.4393343	Flexible Coupling	533420
2.3 (107 kw)	2000.08-2006.03		Front	BUS RWD E5FA/E5FC	6MT,Transm.Type:MT82	Flexible Coupling	533418
	2000.08-2006.03		Front	BUS RWD E5FA/E5FC	Transm.Type:MT75,5MT	Flexible Coupling	533420
	2001.03-2006.05		Front	Chassis cabin RWD E5FA/E5FC	6MT,Transm.Type:MT82	Flexible Coupling	533418
	2001.03-2006.05		Front	VAN RWD E5FA/E5FC	6MT,Transm.Type:MT82	Flexible Coupling	533418



	 YEAR	TRANSM.	FITTING POSITION	BODY STYLE & DRIVE TYPE & ENGINE	REMARKS	 PRODUCT	GSP Ref.	
FORD Transit 330								
2.3 (107 kw)	2001.03-2006.05		Front	Chassis cabin RWD E5FA/E5FC	Transm.Type:MT75,5MT	Flexible Coupling	533420	
	2001.03-2006.05		Front	VAN RWD E5FA/E5FC	Transm.Type:MT75,5MT	Flexible Coupling	533420	
	2006.04-2014.08		Centre	Chassis cabin RWD GZFB		Center Bearing Support	511381	
	2006.04-2014.08		Front	Chassis cabin RWD GZFB	6MT	Flexible Coupling	533418	
	2006.04-2014.08		Front	Chassis cabin RWD GZFB	Transm.Type:MT75,5MT	Flexible Coupling	533420	
	2006.07-2014.08		Centre	VAN RWD GZFA		Center Bearing Support	511381	
	2006.07-2014.08		Front	VAN RWD GZFA	6MT	Flexible Coupling	533418	
	2006.07-2014.08		Front	VAN RWD GZFA	Transm.Type:MT75,5MT	Flexible Coupling	533420	
2.4 (55 kw)	2000.01-2003.08		Centre	Chassis cabin RWD F4FA		Center Bearing Support	511381	
	2000.01-2003.08		Front	Chassis cabin RWD F4FA	6MT,Transm.Type:MT82	Flexible Coupling	533418	
	2000.01-2003.08		Front	Chassis cabin RWD F4FA	Transm.Type:MT75,5MT	Flexible Coupling	533420	
	2000.08-2003.08		Centre	BUS RWD F4FA		Center Bearing Support	511381	
	2000.08-2003.08		Front	BUS RWD F4FA	6MT,Transm.Type:MT82	Flexible Coupling	533418	
	2000.08-2003.08		Front	BUS RWD F4FA	Transm.Type:MT75,5MT	Flexible Coupling	533420	
2.4 (66 kw)	2000.01-2006.03		Centre	VAN RWD D2FA/D2FB		Center Bearing Support	511381	
	2000.01-2006.03		Front	VAN RWD D2FA/D2FB	6MT,Transm.Type:MT82	Flexible Coupling	533418	
	2000.01-2006.03		Front	VAN RWD D2FA/D2FB	Transm.Type:MT75,5MT	Flexible Coupling	533420	
	2000.01-2006.05		Centre	Chassis cabin RWD D2FA/D2FB		Center Bearing Support	511381	
	2000.01-2006.05		Front	Chassis cabin RWD D2FA/D2FB	6MT,Transm.Type:MT82	Flexible Coupling	533418	
	2000.01-2006.05		Front	Chassis cabin RWD D2FA/D2FB	Transm.Type:MT75,5MT	Flexible Coupling	533420	
	2001.10-2006.03		Centre	BUS RWD D2FA/D2FB		Center Bearing Support	511381	
	2001.10-2006.03		Front	BUS RWD D2FA/D2FB	6MT,Transm.Type:MT82	Flexible Coupling	533418	
	2001.10-2006.03		Front	BUS RWD D2FA/D2FB	Transm.Type:MT75,5MT	Flexible Coupling	533420	
	2.4 (74 kw)	2006.04-2014.08		Centre	BUS RWD PHFA/PHFC		Center Bearing Support	511381
2006.04-2014.08			Centre	Chassis cabin RWD PHFA/PHFC		Center Bearing Support	511381	
2006.04-2014.08			Centre	VAN RWD PHFA/PHFC		Center Bearing Support	511381	
2006.04-2014.08			Centre	BUS RWD PHFA/PHFC		Center Bearing Support Kit	537769	
2006.04-2014.08			Centre	Chassis cabin RWD PHFA/PHFC		Center Bearing Support Kit	537769	
2006.04-2014.08			Centre	VAN RWD PHFA/PHFC		Center Bearing Support Kit	537769	
2006.04-2014.08			Front	BUS RWD PHFA/PHFC	6MT,Transm.Type:MT82	Flexible Coupling	533418	
2006.04-2014.08			Front	Chassis cabin RWD PHFA/PHFC	6MT	Flexible Coupling	533418	
2006.04-2014.08			Front	VAN RWD PHFA/PHFC	6MT	Flexible Coupling	533418	
2006.04-2014.08			Front	BUS RWD PHFA/PHFC	Transm.Type:MT75,5MT	Flexible Coupling	533420	
2006.04-2014.08			Front	Chassis cabin RWD PHFA/PHFC	Transm.Type:MT75,5MT	Flexible Coupling	533420	
2006.04-2014.08			Front	VAN RWD PHFA/PHFC	Transm.Type:MT75,5MT	Flexible Coupling	533420	
2.4 (85 kw)		2004.01-2006.03		Centre	BUS RWD FXFA		Center Bearing Support	511381
		2004.01-2006.03		Centre	Chassis cabin RWD FXFA		Center Bearing Support	511381
	2004.01-2006.03		Centre	VAN RWD FXFA		Center Bearing Support	511381	
	2004.01-2006.03		Front	BUS RWD FXFA	6MT,Transm.Type:MT82	Flexible Coupling	533418	
	2004.01-2006.03		Front	Chassis cabin RWD FXFA	6MT,Transm.Type:MT82	Flexible Coupling	533418	
	2004.01-2006.03		Front	VAN RWD FXFA	6MT,Transm.Type:MT82	Flexible Coupling	533418	
	2004.01-2006.03		Front	BUS RWD FXFA	Transm.Type:MT75,5MT	Flexible Coupling	533420	
	2004.01-2006.03		Front	Chassis cabin RWD FXFA	Transm.Type:MT75,5MT	Flexible Coupling	533420	
	2004.01-2006.03		Front	VAN RWD FXFA	Transm.Type:MT75,5MT	Flexible Coupling	533420	
	2006.04-2014.08		Centre	BUS RWD JXFA/JXFC		Center Bearing Support	511381	
	2006.04-2014.08		Centre	Chassis cabin RWD JXFA/JXFC		Center Bearing Support	511381	
	2006.04-2014.08		Centre	VAN RWD JXFA/JXFC		Center Bearing Support	511381	
	2006.04-2014.08		Centre	BUS RWD JXFA/JXFC		Center Bearing Support Kit	537769	
	2006.04-2014.08		Centre	Chassis cabin RWD JXFA/JXFC		Center Bearing Support Kit	537769	
	2006.04-2014.08		Centre	VAN RWD JXFA/JXFC		Center Bearing Support Kit	537769	
	2006.04-2014.08		Front	BUS RWD JXFA/JXFC	6MT,Transm.Type:MT82	Flexible Coupling	533418	
	2006.04-2014.08		Front	Chassis cabin RWD JXFA/JXFC	6MT	Flexible Coupling	533418	
	2006.04-2014.08		Front	VAN RWD JXFA/JXFC	6MT	Flexible Coupling	533418	
	2006.04-2014.08		Front	BUS RWD JXFA/JXFC	Transm.Type:MT75,5MT	Flexible Coupling	533420	
	2006.04-2014.08		Front	Chassis cabin RWD JXFA/JXFC	Transm.Type:MT75,5MT	Flexible Coupling	533420	
	2006.04-2014.08		Front	VAN RWD JXFA/JXFC	Transm.Type:MT75,5MT	Flexible Coupling	533420	
	2.4 (88 kw)	2000.01-2006.05		Centre	BUS RWD D4FA		Center Bearing Support	511381
2000.01-2006.05			Centre	Chassis cabin RWD D4FA		Center Bearing Support	511381	
2000.01-2006.05			Centre	VAN RWD D4FA		Center Bearing Support	511381	
2000.01-2006.05			Front	BUS RWD D4FA	6MT,Transm.Type:MT82	Flexible Coupling	533418	
2000.01-2006.05			Front	Chassis cabin RWD D4FA	6MT,Transm.Type:MT82	Flexible Coupling	533418	
2000.01-2006.05			Front	VAN RWD D4FA	6MT,Transm.Type:MT82	Flexible Coupling	533418	
2000.01-2006.05			Front	BUS RWD D4FA	Transm.Type:MT75,5MT	Flexible Coupling	533420	
2000.01-2006.05			Front	Chassis cabin RWD D4FA	Transm.Type:MT75,5MT	Flexible Coupling	533420	
2000.01-2006.05			Front	VAN RWD D4FA	Transm.Type:MT75,5MT	Flexible Coupling	533420	



	 YEAR	TRANSM.	FITTING POSITION	BODY STYLE & DRIVE TYPE & ENGINE	REMARKS	 PRODUCT	GSP Ref.
FORD Transit 330							
2.4 (88 kw)	2000.01-2006.05		Front	VAN RWD D4FA	Transm.Type:MT75,5MT	Flexible Coupling	533420
2.4 (92 kw)	2001.07-2006.05		Centre	Chassis cabin RWD DOFA		Center Bearing Support	511381
	2001.07-2006.05		Front	Chassis cabin RWD DOFA	6MT,Transm.Type:MT82	Flexible Coupling	533418
	2001.07-2006.05		Front	Chassis cabin RWD DOFA	Transm.Type:MT75,5MT	Flexible Coupling	533420
	2001.10-2006.03		Centre	BUS RWD DOFA		Center Bearing Support	511381
	2001.10-2006.03		Centre	VAN RWD DOFA		Center Bearing Support	511381
	2001.10-2006.03		Front	BUS RWD DOFA	6MT,Transm.Type:MT82	Flexible Coupling	533418
	2001.10-2006.03		Front	VAN RWD DOFA	6MT,Transm.Type:MT82	Flexible Coupling	533418
	2001.10-2006.03		Front	BUS RWD DOFA	Transm.Type:MT75,5MT	Flexible Coupling	533420
2.4 (101 kw)	2001.10-2006.03		Front	VAN RWD DOFA	Transm.Type:MT75,5MT	Flexible Coupling	533420
	2003.09-2006.03		Centre	BUS RWD H9FA		Center Bearing Support	511381
	2003.09-2006.03		Centre	VAN RWD H9FA		Center Bearing Support	511381
	2003.09-2006.03		Front	BUS RWD H9FA	6MT,Transm.Type:MT82	Flexible Coupling	533418
	2003.09-2006.03		Front	VAN RWD H9FA	6MT,Transm.Type:MT82	Flexible Coupling	533418
	2003.09-2006.03		Front	BUS RWD H9FA	Transm.Type:MT75,5MT	Flexible Coupling	533420
	2003.09-2006.03		Front	VAN RWD H9FA	Transm.Type:MT75,5MT	Flexible Coupling	533420
	2004.03-2006.05		Centre	Chassis cabin RWD H9FA		Center Bearing Support	511381
2.4 (103 kw)	2004.03-2006.05		Front	Chassis cabin RWD H9FA	6MT,Transm.Type:MT82	Flexible Coupling	533418
	2004.03-2006.05		Front	Chassis cabin RWD H9FA	Transm.Type:MT75,5MT	Flexible Coupling	533420
	2006.04-2014.08		Centre	BUS RWD H9FD		Center Bearing Support	511381
	2006.04-2014.08		Centre	Chassis cabin RWD H9FD		Center Bearing Support	511381
	2006.04-2014.08		Centre	VAN RWD H9FD		Center Bearing Support	511381
	2006.04-2014.08		Centre	BUS RWD H9FD		Center Bearing Support Kit	537769
	2006.04-2014.08		Centre	Chassis cabin RWD H9FD		Center Bearing Support Kit	537769
	2006.04-2014.08		Centre	VAN RWD H9FD		Center Bearing Support Kit	537769
	2006.04-2014.08		Front	BUS RWD H9FD	6MT,Transm.Type:MT82	Flexible Coupling	533418
	2006.04-2014.08		Front	Chassis cabin RWD H9FD	6MT	Flexible Coupling	533418
	2006.04-2014.08		Front	VAN RWD H9FD	6MT	Flexible Coupling	533418
	2006.04-2014.08		Front	BUS RWD H9FD	Transm.Type:MT75,5MT	Flexible Coupling	533420
	2006.04-2014.08		Front	Chassis cabin RWD H9FD	Transm.Type:MT75,5MT	Flexible Coupling	533420
	2006.04-2014.08		Front	VAN RWD H9FD	Transm.Type:MT75,5MT	Flexible Coupling	533420
	2006.07-2014.08		Centre	BUS 4WD H9FB		Center Bearing Support	511381
	2006.07-2014.08		Centre	BUS 4WD H9FB		Center Bearing Support Kit	537769
	2006.07-2014.08		Front	BUS 4WD H9FB	6MT	Flexible Coupling	533418
	2006.07-2014.08		Front	BUS 4WD H9FB	Transm.Type:MT75,5MT	Flexible Coupling	533420
	2006.11-2014.08		Centre	Chassis cabin 4WD H9FB		Center Bearing Support	511381
	2006.11-2014.08		Centre	VAN 4WD H9FB		Center Bearing Support	511381
2006.11-2014.08		Centre	Chassis cabin 4WD H9FB		Center Bearing Support Kit	537769	
2006.11-2014.08		Centre	VAN 4WD H9FB		Center Bearing Support Kit	537769	
2006.11-2014.08		Front	Chassis cabin 4WD H9FB	6MT	Flexible Coupling	533418	
2006.11-2014.08		Front	VAN 4WD H9FB	6MT	Flexible Coupling	533418	
2006.11-2014.08		Front	Chassis cabin 4WD H9FB	Transm.Type:MT75,5MT	Flexible Coupling	533420	
2006.11-2014.08		Front	VAN 4WD H9FB	Transm.Type:MT75,5MT	Flexible Coupling	533420	
Transit 350							
2.0 (74 kw)	2000.06-2006.05		Centre	Chassis cabin FWD ABFA		Center Bearing Support	511381
	2000.06-2006.05		Centre	VAN FWD ABFA		Center Bearing Support	511381
2.0 (77 kw)	2016.03-		Centre	Chassis cabin RWD YLR6		Center Bearing Support	511381
	2016.03-		Centre	VAN RWD BJRA/YLR6/YLRA		Center Bearing Support	511381
	2016.03-		Front	Chassis cabin RWD YLR6		Flexible Coupling	533418
	2016.03-		Front	VAN RWD BJRA/YLR6/YLRA		Flexible Coupling	533418
2.0 (92 kw)	2000.06-2006.05		Centre	Chassis cabin FWD FIFA		Center Bearing Support	511381
	2000.06-2006.05		Centre	VAN FWD FIFA		Center Bearing Support	511381
2.0 (96 kw)	2016.03-		Centre	Chassis cabin RWD BKRA/YMHA/YMR6		Center Bearing Support	511381
	2016.03-		Centre	VAN 4WD BKRA/YMR6/YMRA		Center Bearing Support	511381
	2016.03-		Front	Chassis cabin RWD BKRA/YMHA/YMR6		Flexible Coupling	533418
	2016.03-		Front	VAN 4WD BKRA/YMR6/YMRA		Flexible Coupling	533418
	2017.01-		Centre	Chassis cabin 4WD BKRA/YMR6/YMRA		Center Bearing Support	511381
	2017.01-		Front	Chassis cabin 4WD BKRA/YMR6/YMRA		Flexible Coupling	533418
	2019.05-		Centre	Chassis cabin RWD BKRB		Center Bearing Support	511381
	2019.05-		Centre	VAN RWD BKRB		Center Bearing Support	511381
	2019.05-		Centre	VAN RWD BKRA/YMHA		Center Bearing Support	511381
	2019.05-		Centre	BUS RWD YMHA		Center Bearing Support	511381
	2019.05-		Front	Chassis cabin RWD BKRB		Flexible Coupling	533418
	2019.05-		Front	VAN RWD BKRB		Flexible Coupling	533418

	 YEAR	TRANSM.	FITTING POSITION	BODY STYLE & DRIVE TYPE & ENGINE	REMARKS	 PRODUCT	GSP Ref.
FORD Transit 350							
2.0 (96 kw)	2019.05-		Front	VAN RWD BKRA/YMHA		Flexible Coupling	533418
	2019.05-		Front	BUS RWD YMHA		Flexible Coupling	533418
2.0 (125 kw)	2016.03-		Centre	Chassis cabin RWD BLHA/BLRA/YNR6		Center Bearing Support	511381
	2016.03-		Centre	VAN RWD BLHA/BLRA/YNR6		Center Bearing Support	511381
	2016.03-		Centre	VAN 4WD BLRA/YNR6/YNRA		Center Bearing Support	511381
	2016.03-		Front	Chassis cabin RWD BLHA/BLRA/YNR6		Flexible Coupling	533418
	2016.03-		Front	VAN RWD BLHA/BLRA/YNR6		Flexible Coupling	533418
	2016.03-		Front	VAN 4WD BLRA/YNR6/YNRA		Flexible Coupling	533418
	2017.01-		Centre	Chassis cabin 4WD BLRA/YNR6/YNRA		Center Bearing Support	511381
	2017.01-		Front	Chassis cabin 4WD BLRA/YNR6/YNRA		Flexible Coupling	533418
	2019.05-		Centre	Chassis cabin RWD BLRB		Center Bearing Support	511381
	2019.05-		Centre	VAN RWD BLRB		Center Bearing Support	511381
	2019.05-		Centre	BUS RWD BLHA		Center Bearing Support	511381
	2019.05-		Front	Chassis cabin RWD BLRB		Flexible Coupling	533418
	2019.05-		Front	VAN RWD BLRB		Flexible Coupling	533418
2019.05-		Front	BUS RWD BLHA		Flexible Coupling	533418	
2.2 (74 kw)	2011.10-2014.08		Front	BUS RWD DRRR/DRRB/DRRC	6MT	Flexible Coupling	533418
	2011.10-2014.08		Front	Chassis cabin RWD DRRR/DRRB/DRRC	6MT	Flexible Coupling	533418
	2011.10-2014.08		Front	VAN RWD DRRR/DRRB/DRRC	6MT	Flexible Coupling	533418
	2011.10-2014.08		Front	BUS RWD DRRR/DRRB/DRRC	Transm.Type:MT75,5MT	Flexible Coupling	533420
	2011.10-2014.08		Front	Chassis cabin RWD DRRR/DRRB/DRRC	Transm.Type:MT75,5MT	Flexible Coupling	533420
	2011.10-2014.08		Front	VAN RWD DRRR/DRRB/DRRC	Transm.Type:MT75,5MT	Flexible Coupling	533420
	2013.08-2018.12		Centre	Chassis cabin RWD DRR5		Center Bearing Support	511381
	2013.08-2018.12		Centre	VAN RWD DRR5		Center Bearing Support	511381
	2013.08-2018.12		Centre	BUS RWD DRR5		Center Bearing Support	511381
	2013.08-2018.12		Front	Chassis cabin RWD DRR5		Flexible Coupling	533418
	2013.08-2018.12		Front	VAN RWD DRR5		Flexible Coupling	533418
	2013.08-2018.12		Front	BUS RWD DRR5		Flexible Coupling	533418
	2013.08-2018.12		Front	BUS RWD DRR5		Flexible Coupling	533418
2.2 (81 kw)	2006.04-2014.08		Centre	BUS FWD QVFA		Center Bearing Support	511381
	2006.04-2014.08		Centre	Chassis cabin FWD QVFA		Center Bearing Support	511381
	2006.04-2014.08		Centre	VAN FWD QVFA		Center Bearing Support	511381
	2006.04-2014.08		Centre	BUS FWD QVFA		Center Bearing Support Kit	537769
	2006.04-2014.08		Centre	Chassis cabin FWD QVFA		Center Bearing Support Kit	537769
	2006.04-2014.08		Centre	VAN FWD QVFA		Center Bearing Support Kit	537769
2.2 (85 kw)	2008.10-2014.08		Centre	BUS FWD SRFA/SRFB/SRFC/SRFD/SRFE		Center Bearing Support Kit	537769
	2008.10-2014.08		Centre	Chassis cabin FWD SRFA/SRFB/SRFC/SRFD/SRFE		Center Bearing Support Kit	537769
	2008.10-2014.08		Centre	VAN FWD SRFA/SRFB/SRFC/SRFD/SRFE		Center Bearing Support Kit	537769
2.2 (92 kw)	2011.09-2014.12		Front	BUS RWD CYRA	6MT	Flexible Coupling	533418
	2011.09-2014.12		Front	VAN RWD CYRA	6MT	Flexible Coupling	533418
	2011.09-2014.12		Front	BUS RWD CYRA	Transm.Type:MT75,5MT	Flexible Coupling	533420
	2011.09-2014.12		Front	VAN RWD CYRA	Transm.Type:MT75,5MT	Flexible Coupling	533420
	2011.10-2014.08		Front	Chassis cabin 4WD CYRB/CYRC	6MT	Flexible Coupling	533418
	2011.10-2014.08		Front	Chassis cabin RWD CYRA	6MT	Flexible Coupling	533418
	2011.10-2014.08		Front	VAN 4WD CYRB/CYRC	6MT	Flexible Coupling	533418
	2011.10-2014.08		Front	Chassis cabin 4WD CYRB/CYRC	Transm.Type:MT75,5MT	Flexible Coupling	533420
	2011.10-2014.08		Front	Chassis cabin RWD CYRA	Transm.Type:MT75,5MT	Flexible Coupling	533420
	2011.10-2014.08		Front	VAN 4WD CYRB/CYRC	Transm.Type:MT75,5MT	Flexible Coupling	533420
	2013.08-2018.12		Centre	BUS RWD USR6		Center Bearing Support	511381
	2013.08-2018.12		Centre	Chassis cabin 4WD CY24/CYR5		Center Bearing Support	511381
	2013.08-2018.12		Centre	Chassis cabin RWD CYR5/USR6		Center Bearing Support	511381
	2013.08-2018.12		Centre	VAN 4WD CY24/CYR5		Center Bearing Support	511381
	2013.08-2018.12		Centre	VAN RWD CYR5/USR6		Center Bearing Support	511381
	2013.08-2018.12		Centre	BUS 4WD CY24/CYR5		Center Bearing Support	511381
	2013.08-2018.12		Front	BUS RWD USR6		Flexible Coupling	533418
	2013.08-2018.12		Front	Chassis cabin 4WD CY24/CYR5		Flexible Coupling	533418
	2013.08-2018.12		Front	Chassis cabin RWD CYR5/USR6		Flexible Coupling	533418
	2013.08-2018.12		Front	VAN 4WD CY24/CYR5		Flexible Coupling	533418
2013.08-2018.12		Front	VAN RWD CYR5/USR6		Flexible Coupling	533418	
2013.08-2018.12		Front	BUS 4WD CY24/CYR5		Flexible Coupling	533418	
2.2 (96 kw)	2006.04-2014.08		Centre	BUS FWD QWFA		Center Bearing Support	511381
	2006.04-2014.08		Centre	Chassis cabin FWD QWFA		Center Bearing Support	511381
	2006.04-2014.08		Centre	VAN FWD QWFA		Center Bearing Support	511381
	2006.04-2014.08		Centre	BUS FWD QWFA		Center Bearing Support Kit	537769
	2006.04-2014.08		Centre	Chassis cabin FWD QWFA		Center Bearing Support Kit	537769

	 YEAR	TRANSM.	FITTING POSITION	BODY STYLE & DRIVE TYPE & ENGINE	REMARKS	 PRODUCT	GSP Ref.	
FORD Transit 350								
2.2 (96 kw)	2006.04-2014.08		Centre	VAN FWD QWFA		Center Bearing Support Kit	537769	
2.2 (100 kw)	2011.09-2014.08		Front	BUS RWD USRA/USRB	6MT	Flexible Coupling	533418	
	2011.09-2014.08		Front	BUS RWD USRA/USRB	Transm.Type:MT75,5MT	Flexible Coupling	533420	
2.2 (103 kw)	2007.09-2014.08		Centre	BUS FWD PGFA/PGFB/UHFA/UHFB/UHFC		Center Bearing Support Kit	537769	
	2007.09-2014.08		Centre	VAN FWD PGFA/PGFB/UHFA/UHFB/UHFC		Center Bearing Support Kit	537769	
	2007.10-2014.08		Centre	Chassis cabin FWD PGFA/PGFB/UHFA/UHFB/UHFC		Center Bearing Support Kit	537769	
	2011.10-2014.08		Front	Chassis cabin RWD CVRA/CVRB/CVRC	6MT	Flexible Coupling	533418	
2.2 (114 kw)	2011.10-2014.08		Front	VAN RWD CVRA/CVRB/CVRC	6MT	Flexible Coupling	533418	
	2011.10-2014.08		Front	Chassis cabin RWD CVRA/CVRB/CVRC	Transm.Type:MT75,5MT	Flexible Coupling	533420	
	2011.10-2014.08		Front	VAN RWD CVRA/CVRB/CVRC	Transm.Type:MT75,5MT	Flexible Coupling	533420	
	2013.08-2018.12		Centre	BUS RWD CV24/CVR5/UJR6		Center Bearing Support	511381	
	2013.08-2018.12		Centre	Chassis cabin 4WD CV24/CVR5		Center Bearing Support	511381	
	2013.08-2018.12		Centre	Chassis cabin RWD CV24/CVR5/UJR6		Center Bearing Support	511381	
	2013.08-2018.12		Centre	VAN RWD CV24/CVR5/UJR6		Center Bearing Support	511381	
	2013.08-2018.12		Front	BUS RWD CV24/CVR5/UJR6		Flexible Coupling	533418	
	2013.08-2018.12		Front	Chassis cabin 4WD CV24/CVR5		Flexible Coupling	533418	
	2013.08-2018.12		Front	Chassis cabin RWD CV24/CVR5/UJR6		Flexible Coupling	533418	
	2013.08-2018.12		Front	VAN RWD CV24/CVR5/UJR6		Flexible Coupling	533418	
	2015.08-2018.12		Centre	VAN 4WD CV24/CVR5		Center Bearing Support	511381	
	2015.08-2018.12		Front	VAN 4WD CV24/CVR5		Flexible Coupling	533418	
	2.3 (105 kw)	2001.03-2006.03		Front	VAN RWD E5FC	For OE No.4165078	Flexible Coupling	533418
		2001.03-2006.03		Front	Chassis cabin RWD E5FC		Flexible Coupling	533420
2001.03-2006.03			Front	VAN RWD E5FC	For OE No.4393343	Flexible Coupling	533420	
2.3 (107 kw)	2000.01-2006.03		Front	Chassis cabin RWD E5FA	6MT,Transm.Type:MT82	Flexible Coupling	533418	
	2000.01-2006.03		Front	Chassis cabin RWD E5FA	Transm.Type:MT75,5MT	Flexible Coupling	533420	
	2000.08-2006.03		Front	BUS RWD E5FA/E5FC	6MT,Transm.Type:MT82	Flexible Coupling	533418	
	2000.08-2006.03		Front	BUS RWD E5FA/E5FC	Transm.Type:MT75,5MT	Flexible Coupling	533420	
	2001.04-2006.05		Front	VAN RWD E5FA/E5FC	6MT,Transm.Type:MT82	Flexible Coupling	533418	
	2001.04-2006.05		Front	VAN RWD E5FA/E5FC	Transm.Type:MT75,5MT	Flexible Coupling	533420	
	2006.04-2014.08		Centre	Chassis cabin RWD GZFB		Center Bearing Support	511381	
	2006.04-2014.08		Front	Chassis cabin RWD GZFB	6MT	Flexible Coupling	533418	
	2006.04-2014.08		Front	Chassis cabin RWD GZFB	Transm.Type:MT75,5MT	Flexible Coupling	533420	
	2006.07-2014.08		Centre	VAN RWD GZFA		Center Bearing Support	511381	
	2006.07-2014.08		Front	VAN RWD GZFA	6MT	Flexible Coupling	533418	
	2006.07-2014.08		Front	VAN RWD GZFA	Transm.Type:MT75,5MT	Flexible Coupling	533420	
2.4 (55 kw)	2000.01-2003.08		Centre	Chassis cabin RWD F4FA		Center Bearing Support	511381	
	2000.01-2003.08		Front	Chassis cabin RWD F4FA	6MT,Transm.Type:MT82	Flexible Coupling	533418	
	2000.01-2003.08		Front	Chassis cabin RWD F4FA	Transm.Type:MT75,5MT	Flexible Coupling	533420	
	2000.01-2006.05		Centre	VAN RWD F4FA		Center Bearing Support	511381	
	2000.01-2006.05		Front	VAN RWD F4FA	6MT,Transm.Type:MT82	Flexible Coupling	533418	
	2000.01-2006.05		Front	VAN RWD F4FA	Transm.Type:MT75,5MT	Flexible Coupling	533420	
	2000.09-2003.08		Centre	BUS RWD F4FA		Center Bearing Support	511381	
	2000.09-2003.08		Front	BUS RWD F4FA	6MT,Transm.Type:MT82	Flexible Coupling	533418	
	2000.09-2003.08		Front	BUS RWD F4FA	Transm.Type:MT75,5MT	Flexible Coupling	533420	
2.4 (66 kw)	2000.01-2006.03		Centre	VAN RWD D2FA/D2FB		Center Bearing Support	511381	
	2000.01-2006.03		Front	VAN RWD D2FA/D2FB	6MT,Transm.Type:MT82	Flexible Coupling	533418	
	2000.01-2006.03		Front	VAN RWD D2FA/D2FB	Transm.Type:MT75,5MT	Flexible Coupling	533420	
	2000.01-2006.05		Centre	Chassis cabin RWD D2FA/D2FB		Center Bearing Support	511381	
	2000.01-2006.05		Front	Chassis cabin RWD D2FA/D2FB	6MT,Transm.Type:MT82	Flexible Coupling	533418	
	2000.01-2006.05		Front	Chassis cabin RWD D2FA/D2FB	Transm.Type:MT75,5MT	Flexible Coupling	533420	
	2001.10-2006.03		Centre	BUS RWD D2FA/D2FB		Center Bearing Support	511381	
	2001.10-2006.03		Front	BUS RWD D2FA/D2FB	6MT,Transm.Type:MT82	Flexible Coupling	533418	
	2001.10-2006.03		Front	BUS RWD D2FA/D2FB	Transm.Type:MT75,5MT	Flexible Coupling	533420	
2.4 (74 kw)	2006.04-2014.08		Centre	BUS RWD PHFA/PHFC		Center Bearing Support	511381	
	2006.04-2014.08		Centre	Chassis cabin RWD PHFA/PHFC		Center Bearing Support	511381	
	2006.04-2014.08		Centre	VAN RWD PHFA/PHFC		Center Bearing Support	511381	
	2006.04-2014.08		Centre	BUS RWD PHFA/PHFC		Center Bearing Support Kit	537769	
	2006.04-2014.08		Centre	Chassis cabin RWD PHFA/PHFC		Center Bearing Support Kit	537769	
	2006.04-2014.08		Centre	VAN RWD PHFA/PHFC		Center Bearing Support Kit	537769	
	2006.04-2014.08		Front	BUS RWD PHFA/PHFC	6MT,Transm.Type:MT82	Flexible Coupling	533418	
	2006.04-2014.08		Front	Chassis cabin RWD PHFA/PHFC	6MT	Flexible Coupling	533418	
	2006.04-2014.08		Front	VAN RWD PHFA/PHFC	6MT	Flexible Coupling	533418	
	2006.04-2014.08		Front	BUS RWD PHFA/PHFC	Transm.Type:MT75,5MT	Flexible Coupling	533420	
	2006.04-2014.08		Front	Chassis cabin RWD PHFA/PHFC	Transm.Type:MT75,5MT	Flexible Coupling	533420	



	 YEAR	TRANSM.	FITTING POSITION	BODY STYLE & DRIVE TYPE & ENGINE	REMARKS	 PRODUCT	GSP Ref.
FORD Transit 350							
2.4 (74 kw)	2006.04-2014.08		Front	VAN RWD PHFA/PHFC	Transm.Type:MT75,5MT	Flexible Coupling	533420
2.4 (85 kw)	2004.01-2006.03		Centre	BUS RWD FXFA		Center Bearing Support	511381
	2004.01-2006.03		Centre	Chassis cabin RWD FXFA		Center Bearing Support	511381
	2004.01-2006.03		Centre	VAN RWD FXFA		Center Bearing Support	511381
	2004.01-2006.03		Front	BUS RWD FXFA	6MT,Transm.Type:MT82	Flexible Coupling	533418
	2004.01-2006.03		Front	Chassis cabin RWD FXFA	6MT,Transm.Type:MT82	Flexible Coupling	533418
	2004.01-2006.03		Front	VAN RWD FXFA	6MT,Transm.Type:MT82	Flexible Coupling	533418
	2004.01-2006.03		Front	BUS RWD FXFA	Transm.Type:MT75,5MT	Flexible Coupling	533420
	2004.01-2006.03		Front	Chassis cabin RWD FXFA	Transm.Type:MT75,5MT	Flexible Coupling	533420
	2004.01-2006.03		Front	VAN RWD FXFA	Transm.Type:MT75,5MT	Flexible Coupling	533420
	2006.04-2014.08		Centre	BUS RWD JXFA/JXFC		Center Bearing Support	511381
	2006.04-2014.08		Centre	Chassis cabin RWD JXFA/JXFC		Center Bearing Support	511381
	2006.04-2014.08		Centre	VAN RWD JXFA/JXFC		Center Bearing Support	511381
	2006.04-2014.08		Centre	BUS RWD JXFA/JXFC		Center Bearing Support Kit	537769
	2006.04-2014.08		Centre	Chassis cabin RWD JXFA/JXFC		Center Bearing Support Kit	537769
	2006.04-2014.08		Centre	VAN RWD JXFA/JXFC		Center Bearing Support Kit	537769
	2006.04-2014.08		Front	BUS RWD JXFA/JXFC	6MT,Transm.Type:MT82	Flexible Coupling	533418
	2006.04-2014.08		Front	Chassis cabin RWD JXFA/JXFC	6MT	Flexible Coupling	533418
	2006.04-2014.08		Front	VAN RWD JXFA/JXFC	6MT	Flexible Coupling	533418
	2006.04-2014.08		Front	BUS RWD JXFA/JXFC	Transm.Type:MT75,5MT	Flexible Coupling	533420
	2006.04-2014.08		Front	Chassis cabin RWD JXFA/JXFC	Transm.Type:MT75,5MT	Flexible Coupling	533420
2006.04-2014.08		Front	VAN RWD JXFA/JXFC	Transm.Type:MT75,5MT	Flexible Coupling	533420	
2.4 (88 kw)	2000.01-2006.05		Centre	BUS RWD D4FA		Center Bearing Support	511381
	2000.01-2006.05		Centre	Chassis cabin RWD D4FA		Center Bearing Support	511381
	2000.01-2006.05		Front	BUS RWD D4FA	6MT,Transm.Type:MT82	Flexible Coupling	533418
	2000.01-2006.05		Front	Chassis cabin RWD D4FA	6MT,Transm.Type:MT82	Flexible Coupling	533418
	2000.01-2006.05		Front	BUS RWD D4FA	Transm.Type:MT75,5MT	Flexible Coupling	533420
	2000.01-2006.05		Front	Chassis cabin RWD D4FA	Transm.Type:MT75,5MT	Flexible Coupling	533420
	2000.08-2003.08		Centre	VAN RWD D4FA		Center Bearing Support	511381
	2000.08-2003.08		Front	VAN RWD D4FA	6MT,Transm.Type:MT82	Flexible Coupling	533418
2000.08-2003.08		Front	VAN RWD D4FA	Transm.Type:MT75,5MT	Flexible Coupling	533420	
2.4 (92 kw)	2001.07-2006.05		Centre	Chassis cabin RWD DOFA		Center Bearing Support	511381
	2001.07-2006.05		Front	Chassis cabin RWD DOFA	6MT,Transm.Type:MT82	Flexible Coupling	533418
	2001.07-2006.05		Front	Chassis cabin RWD DOFA	Transm.Type:MT75,5MT	Flexible Coupling	533420
	2001.10-2006.03		Centre	BUS RWD DOFA		Center Bearing Support	511381
	2001.10-2006.03		Centre	VAN RWD DOFA		Center Bearing Support	511381
	2001.10-2006.03		Front	BUS RWD DOFA	6MT,Transm.Type:MT82	Flexible Coupling	533418
	2001.10-2006.03		Front	VAN RWD DOFA	6MT,Transm.Type:MT82	Flexible Coupling	533418
	2001.10-2006.03		Front	BUS RWD DOFA	Transm.Type:MT75,5MT	Flexible Coupling	533420
	2001.10-2006.03		Front	VAN RWD DOFA	Transm.Type:MT75,5MT	Flexible Coupling	533420
2.4 (101 kw)	2003.09-2006.03		Centre	BUS RWD H9FA		Center Bearing Support	511381
	2003.09-2006.03		Centre	VAN RWD H9FA		Center Bearing Support	511381
	2003.09-2006.03		Front	BUS RWD H9FA	6MT,Transm.Type:MT82	Flexible Coupling	533418
	2003.09-2006.03		Front	VAN RWD H9FA	6MT,Transm.Type:MT82	Flexible Coupling	533418
	2003.09-2006.03		Front	BUS RWD H9FA	Transm.Type:MT75,5MT	Flexible Coupling	533420
	2003.09-2006.03		Front	VAN RWD H9FA	Transm.Type:MT75,5MT	Flexible Coupling	533420
	2004.03-2006.05		Centre	Chassis cabin RWD H9FA		Center Bearing Support	511381
	2004.03-2006.05		Front	Chassis cabin RWD H9FA	6MT,Transm.Type:MT82	Flexible Coupling	533418
2004.03-2006.05		Front	Chassis cabin RWD H9FA	Transm.Type:MT75,5MT	Flexible Coupling	533420	
2.4 (103 kw)	2006.04-2014.08		Centre	BUS RWD H9FD		Center Bearing Support	511381
	2006.04-2014.08		Centre	Chassis cabin RWD H9FB/H9FD		Center Bearing Support	511381
	2006.04-2014.08		Centre	VAN RWD H9FB/H9FD		Center Bearing Support	511381
	2006.04-2014.08		Centre	Chassis cabin 4WD H9FB		Center Bearing Support	511381
	2006.04-2014.08		Centre	VAN 4WD H9FB		Center Bearing Support	511381
	2006.04-2014.08		Centre	BUS RWD H9FD		Center Bearing Support Kit	537769
	2006.04-2014.08		Centre	Chassis cabin RWD H9FB/H9FD		Center Bearing Support Kit	537769
	2006.04-2014.08		Centre	VAN RWD H9FB/H9FD		Center Bearing Support Kit	537769
	2006.04-2014.08		Centre	Chassis cabin 4WD H9FB		Center Bearing Support Kit	537769
	2006.04-2014.08		Centre	VAN 4WD H9FB		Center Bearing Support Kit	537769
	2006.04-2014.08		Front	BUS RWD H9FD	6MT,Transm.Type:MT82	Flexible Coupling	533418
	2006.04-2014.08		Front	Chassis cabin RWD H9FB/H9FD	6MT	Flexible Coupling	533418
	2006.04-2014.08		Front	VAN RWD H9FB/H9FD	6MT	Flexible Coupling	533418
	2006.04-2014.08		Front	Chassis cabin 4WD H9FB	6MT	Flexible Coupling	533418
	2006.04-2014.08		Front	VAN 4WD H9FB	6MT	Flexible Coupling	533418

 YEAR	TRANSM.	FITTING POSITION	BODY STYLE & DRIVE TYPE & ENGINE	REMARKS	 PRODUCT	GSP Ref.	
FORD							
Transit 350							
2.4 (103 kw)	2006.04-2014.08		Front	BUS RWD H9FD	Transm.Type:MT75,5MT	Flexible Coupling	533420
	2006.04-2014.08		Front	Chassis cabin RWD H9FB/H9FD	Transm.Type:MT75,5MT	Flexible Coupling	533420
	2006.04-2014.08		Front	VAN RWD H9FB/H9FD	Transm.Type:MT75,5MT	Flexible Coupling	533420
	2006.04-2014.08		Front	Chassis cabin 4WD H9FB	Transm.Type:MT75,5MT	Flexible Coupling	533420
	2006.04-2014.08		Front	VAN 4WD H9FB	Transm.Type:MT75,5MT	Flexible Coupling	533420
	2006.07-2014.08		Centre	BUS 4WD H9FB		Center Bearing Support	511381
	2006.07-2014.08		Centre	BUS 4WD H9FB		Center Bearing Support Kit	537769
	2006.07-2014.08		Front	BUS 4WD H9FB	6MT	Flexible Coupling	533418
3.2 (147 kw)	2006.07-2014.08		Front	BUS 4WD H9FB	Transm.Type:MT75,5MT	Flexible Coupling	533420
	2007.09-2014.08		Centre	Chassis cabin RWD SAFA/SAFB		Center Bearing Support Kit	537769
	2007.09-2014.08		Centre	VAN RWD SAFA/SAFB		Center Bearing Support Kit	537769
	2007.09-2014.08		Front	Chassis cabin RWD SAFA/SAFB	6MT	Flexible Coupling	533418
	2007.09-2014.08		Front	VAN RWD SAFA/SAFB	6MT	Flexible Coupling	533418
	2007.09-2014.08		Front	Chassis cabin RWD SAFA/SAFB	Transm.Type:MT75,5MT	Flexible Coupling	533420
	2007.09-2014.08		Front	VAN RWD SAFA/SAFB	Transm.Type:MT75,5MT	Flexible Coupling	533420
	2008.02-2014.08		Centre	BUS RWD SAFA/SAFB		Center Bearing Support Kit	537769
2008.02-2014.08		Front	BUS RWD SAFA/SAFB	6MT,Transm.Type:MT82	Flexible Coupling	533418	
		Front	BUS RWD SAFA/SAFB	Transm.Type:MT75,5MT	Flexible Coupling	533420	
Transit 370							
2.2 (92 kw)	2013.08-2018.12		Centre	BUS RWD USR6		Center Bearing Support	511381
	2013.08-2018.12		Front	BUS RWD USR6		Flexible Coupling	533418
2.2 (100 kw)	2011.09-2014.08		Front	BUS RWD USRA/USRB	6MT	Flexible Coupling	533418
	2011.09-2014.08		Front	BUS RWD USRA/USRB	Transm.Type:MT75,5MT	Flexible Coupling	533420
2.2 (114 kw)	2013.08-2018.12		Centre	BUS RWD CV24/CVR5/UJR6		Center Bearing Support	511381
	2013.08-2018.12		Front	BUS RWD CV24/CVR5/UJR6		Flexible Coupling	533418
2.4 (74 kw)	2006.04-2014.08		Centre	BUS RWD PHFA/PHFC		Center Bearing Support	511381
	2006.04-2014.08		Centre	BUS RWD PHFA/PHFC		Center Bearing Support Kit	537769
	2006.04-2014.08		Front	BUS RWD PHFA/PHFC	6MT,Transm.Type:MT82	Flexible Coupling	533418
	2006.04-2014.08		Front	BUS RWD PHFA/PHFC	Transm.Type:MT75,5MT	Flexible Coupling	533420
2.4 (85 kw)	2006.04-2014.08		Centre	BUS RWD JXFA/JXFC		Center Bearing Support	511381
	2006.04-2014.08		Centre	BUS RWD JXFA/JXFC		Center Bearing Support Kit	537769
	2006.04-2014.08		Front	BUS RWD JXFA/JXFC	6MT,Transm.Type:MT82	Flexible Coupling	533418
	2006.04-2014.08		Front	BUS RWD JXFA/JXFC	Transm.Type:MT75,5MT	Flexible Coupling	533420
2.4 (103 kw)	2006.04-2014.08		Centre	BUS RWD H9FD		Center Bearing Support	511381
	2006.04-2014.08		Centre	BUS RWD H9FD		Center Bearing Support Kit	537769
	2006.04-2014.08		Front	BUS RWD H9FD	6MT,Transm.Type:MT82	Flexible Coupling	533418
	2006.04-2014.08		Front	BUS RWD H9FD	Transm.Type:MT75,5MT	Flexible Coupling	533420
	2006.11-2014.08		Centre	BUS 4WD H9FB		Center Bearing Support	511381
	2006.11-2014.08		Centre	BUS 4WD H9FB		Center Bearing Support Kit	537769
	2006.11-2014.08		Front	BUS 4WD H9FB	6MT	Flexible Coupling	533418
	2006.11-2014.08		Front	BUS 4WD H9FB	Transm.Type:MT75,5MT	Flexible Coupling	533420
Transit 410							
2.0 (96 kw)	2019.05-		Centre	BUS RWD YMHA		Center Bearing Support	511381
	2019.05-		Front	BUS RWD YMHA		Flexible Coupling	533418
2.0 (125 kw)	2019.05-		Centre	BUS RWD BLHA		Center Bearing Support	511381
	2019.05-		Front	BUS RWD BLHA		Flexible Coupling	533418
2.2 (92 kw)	2013.08-2018.12		Centre	BUS RWD USR6		Center Bearing Support	511381
	2013.08-2018.12		Front	BUS RWD USR6		Flexible Coupling	533418
2.2 (114 kw)	2013.08-2018.12		Centre	BUS RWD CV24/CVR5/UJR6		Center Bearing Support	511381
	2013.08-2018.12		Front	BUS RWD CV24/CVR5/UJR6		Flexible Coupling	533418
Transit 430							
2.2 (92 kw)	2013.08-2018.12		Centre	VAN RWD CYR5/USR6		Center Bearing Support	511381
	2013.08-2018.12		Centre	Chassis cabin RWD CYR5/USR6		Center Bearing Support	511381
	2013.08-2018.12		Front	VAN RWD CYR5/USR6		Flexible Coupling	533418
	2013.08-2018.12		Front	Chassis cabin RWD CYR5/USR6		Flexible Coupling	533418
2.2 (100 kw)	2011.09-2014.08		Front	BUS RWD USRA/USRB	6MT	Flexible Coupling	533418
	2011.09-2014.08		Front	BUS RWD USRA/USRB	Transm.Type:MT75,5MT	Flexible Coupling	533420
2.2 (114 kw)	2013.08-2018.12		Centre	Chassis cabin RWD CV24/CVR5/UJR6		Center Bearing Support	511381
	2013.08-2018.12		Centre	VAN RWD CV24/CVR5/UJR6		Center Bearing Support	511381
	2013.08-2018.12		Front	Chassis cabin RWD CV24/CVR5/UJR6		Flexible Coupling	533418
	2013.08-2018.12		Front	VAN RWD CV24/CVR5/UJR6		Flexible Coupling	533418
2.4 (66 kw)	2000.01-2006.05		Centre	Chassis cabin RWD D2FA/D2FB		Center Bearing Support	511381
	2000.01-2006.05		Front	Chassis cabin RWD D2FA/D2FB	6MT,Transm.Type:MT82	Flexible Coupling	533418
	2000.01-2006.05		Front	Chassis cabin RWD D2FA/D2FB	Transm.Type:MT75,5MT	Flexible Coupling	533420

	 YEAR	TRANSM.	FITTING POSITION	BODY STYLE & DRIVE TYPE & ENGINE	REMARKS	 PRODUCT	GSP Ref.
FORD							
Transit 430							
2.4 (74 kw)	2006.04-2014.08		Centre	Chassis cabin RWD PHFA/PHFC		Center Bearing Support	511381
	2006.04-2014.08		Centre	VAN RWD PHFA/PHFC		Center Bearing Support	511381
	2006.04-2014.08		Centre	BUS RWD PHFA/PHFC		Center Bearing Support	511381
	2006.04-2014.08		Centre	Chassis cabin RWD PHFA/PHFC		Center Bearing Support Kit	537769
	2006.04-2014.08		Centre	VAN RWD PHFA/PHFC		Center Bearing Support Kit	537769
	2006.04-2014.08		Centre	BUS RWD PHFA/PHFC		Center Bearing Support Kit	537769
	2006.04-2014.08		Front	Chassis cabin RWD PHFA/PHFC	6MT	Flexible Coupling	533418
	2006.04-2014.08		Front	VAN RWD PHFA/PHFC	6MT	Flexible Coupling	533418
	2006.04-2014.08		Front	BUS RWD PHFA/PHFC	6MT,Transm.Type:MT82	Flexible Coupling	533418
	2006.04-2014.08		Front	Chassis cabin RWD PHFA/PHFC	Transm.Type:MT75,5MT	Flexible Coupling	533420
	2006.04-2014.08		Front	VAN RWD PHFA/PHFC	Transm.Type:MT75,5MT	Flexible Coupling	533420
	2006.04-2014.08		Front	BUS RWD PHFA/PHFC	Transm.Type:MT75,5MT	Flexible Coupling	533420
2.4 (85 kw)	2006.04-2014.08		Centre	BUS RWD JXFA/JXFC		Center Bearing Support	511381
	2006.04-2014.08		Centre	Chassis cabin RWD JXFA/JXFC		Center Bearing Support	511381
	2006.04-2014.08		Centre	VAN RWD JXFA/JXFC		Center Bearing Support	511381
	2006.04-2014.08		Centre	BUS RWD JXFA/JXFC		Center Bearing Support Kit	537769
	2006.04-2014.08		Centre	Chassis cabin RWD JXFA/JXFC		Center Bearing Support Kit	537769
	2006.04-2014.08		Centre	VAN RWD JXFA/JXFC		Center Bearing Support Kit	537769
	2006.04-2014.08		Front	BUS RWD JXFA/JXFC	6MT,Transm.Type:MT82	Flexible Coupling	533418
	2006.04-2014.08		Front	Chassis cabin RWD JXFA/JXFC	6MT	Flexible Coupling	533418
	2006.04-2014.08		Front	VAN RWD JXFA/JXFC	6MT	Flexible Coupling	533418
	2006.04-2014.08		Front	BUS RWD JXFA/JXFC	Transm.Type:MT75,5MT	Flexible Coupling	533420
	2006.04-2014.08		Front	Chassis cabin RWD JXFA/JXFC	Transm.Type:MT75,5MT	Flexible Coupling	533420
	2006.04-2014.08		Front	VAN RWD JXFA/JXFC	Transm.Type:MT75,5MT	Flexible Coupling	533420
2.4 (88 kw)	2000.01-2006.05		Centre	Chassis cabin RWD D4FA		Center Bearing Support	511381
	2000.01-2006.05		Front	Chassis cabin RWD D4FA	6MT,Transm.Type:MT82	Flexible Coupling	533418
	2000.01-2006.05		Front	Chassis cabin RWD D4FA	Transm.Type:MT75,5MT	Flexible Coupling	533420
2.4 (92 kw)	2001.07-2006.05		Centre	Chassis cabin RWD DOFA		Center Bearing Support	511381
	2001.07-2006.05		Front	Chassis cabin RWD DOFA	6MT,Transm.Type:MT82	Flexible Coupling	533418
	2001.07-2006.05		Front	Chassis cabin RWD DOFA	Transm.Type:MT75,5MT	Flexible Coupling	533420
2.4 (101 kw)	2004.03-2006.05		Centre	Chassis cabin RWD H9FA		Center Bearing Support	511381
	2004.03-2006.05		Front	Chassis cabin RWD H9FA	6MT,Transm.Type:MT82	Flexible Coupling	533418
	2004.03-2006.05		Front	Chassis cabin RWD H9FA	Transm.Type:MT75,5MT	Flexible Coupling	533420
2.4 (103 kw)	2006.04-2014.08		Centre	VAN RWD H9FD		Center Bearing Support	511381
	2006.04-2014.08		Centre	BUS RWD H9FD		Center Bearing Support	511381
	2006.04-2014.08		Centre	VAN RWD H9FD		Center Bearing Support Kit	537769
	2006.04-2014.08		Centre	BUS RWD H9FD		Center Bearing Support Kit	537769
	2006.04-2014.08		Front	VAN RWD H9FD	6MT	Flexible Coupling	533418
	2006.04-2014.08		Front	BUS RWD H9FD	6MT,Transm.Type:MT82	Flexible Coupling	533418
	2006.04-2014.08		Front	VAN RWD H9FD	Transm.Type:MT75,5MT	Flexible Coupling	533420
	2006.04-2014.08		Front	BUS RWD H9FD	Transm.Type:MT75,5MT	Flexible Coupling	533420
3.2 (147 kw)	2008.02-2014.08		Centre	Chassis cabin RWD SAFA/SAFB		Center Bearing Support Kit	537769
	2008.02-2014.08		Front	Chassis cabin RWD SAFA/SAFB	6MT	Flexible Coupling	533418
	2008.02-2014.08		Front	Chassis cabin RWD SAFA/SAFB	Transm.Type:MT75,5MT	Flexible Coupling	533420
	2010.06-2014.08		Centre	VAN RWD SAFA/SAFB		Center Bearing Support Kit	537769
	2010.06-2014.08		Centre	BUS RWD SAFA/SAFB		Center Bearing Support Kit	537769
	2010.06-2014.08		Front	VAN RWD SAFA/SAFB	6MT	Flexible Coupling	533418
	2010.06-2014.08		Front	BUS RWD SAFA/SAFB	6MT,Transm.Type:MT82	Flexible Coupling	533418
	2010.06-2014.08		Front	VAN RWD SAFA/SAFB	Transm.Type:MT75,5MT	Flexible Coupling	533420
	2010.06-2014.08		Front	BUS RWD SAFA/SAFB	Transm.Type:MT75,5MT	Flexible Coupling	533420
Transit 460							
2.0 (96 kw)	2019.05-		Centre	BUS RWD YMHA		Center Bearing Support	511381
	2019.05-		Front	BUS RWD YMHA		Flexible Coupling	533418
2.0 (125 kw)	2019.05-		Centre	BUS RWD BLHA		Center Bearing Support	511381
	2019.05-		Front	BUS RWD BLHA		Flexible Coupling	533418
2.2 (92 kw)	2011.09-2014.12		Front	VAN RWD CYRA	6MT	Flexible Coupling	533418
	2011.09-2014.12		Front	VAN RWD CYRA	Transm.Type:MT75,5MT	Flexible Coupling	533420
	2011.10-2014.08		Front	Chassis cabin RWD CYRA	6MT	Flexible Coupling	533418
	2011.10-2014.08		Front	Chassis cabin RWD CYRA	Transm.Type:MT75,5MT	Flexible Coupling	533420
	2013.08-2018.12		Centre	BUS RWD USR6		Center Bearing Support	511381
	2013.08-2018.12		Front	BUS RWD USR6		Flexible Coupling	533418
2.2 (99 kw)	2013.08-2018.12		Centre	BUS RWD UHR5		Center Bearing Support	511381
	2013.08-2018.12		Front	BUS RWD UHR5		Flexible Coupling	533418



	 YEAR	TRANSM.	FITTING POSITION	BODY STYLE & DRIVE TYPE & ENGINE	REMARKS	 PRODUCT	GSP Ref.
FORD Transit 460							
2.2 (100 kw)	2011.09-2014.08		Front	BUS RWD USRA/USRB	6MT	Flexible Coupling	533418
	2011.09-2014.08		Front	BUS RWD USRA/USRB	Transm.Type:MT75,5MT	Flexible Coupling	533420
	2011.10-2014.08		Front	VAN RWD USRA/USRB	6MT	Flexible Coupling	533418
	2011.10-2014.08		Front	VAN RWD USRA/USRB	For OE No.4393343	Flexible Coupling	533420
2.2 (114 kw)	2011.10-2014.08		Front	Chassis cabin RWD CVRA/CVRB/CVRC	6MT	Flexible Coupling	533418
	2011.10-2014.08		Front	VAN RWD CVRA/CVRB/CVRC	6MT	Flexible Coupling	533418
	2011.10-2014.08		Front	Chassis cabin RWD CVRA/CVRB/CVRC	Transm.Type:MT75,5MT	Flexible Coupling	533420
	2011.10-2014.08		Front	VAN RWD CVRA/CVRB/CVRC	Transm.Type:MT75,5MT	Flexible Coupling	533420
	2013.08-		Centre	BUS RWD CV24/CVR5/UJR6		Center Bearing Support	511381
	2013.08-		Front	BUS RWD CV24/CVR5/UJR6		Flexible Coupling	533418
2.4 (85 kw)	2006.04-2014.08		Centre	VAN RWD JXFA/JXFC		Center Bearing Support	511381
	2006.04-2014.08		Centre	VAN RWD JXFA/JXFC		Center Bearing Support Kit	537769
	2006.04-2014.08		Front	VAN RWD JXFA/JXFC	6MT	Flexible Coupling	533418
	2006.04-2014.08		Front	VAN RWD JXFA/JXFC	Transm.Type:MT75,5MT	Flexible Coupling	533420
2.4 (103 kw)	2006.04-2014.08		Centre	Chassis cabin RWD H9FD		Center Bearing Support	511381
	2006.04-2014.08		Centre	VAN RWD H9FD		Center Bearing Support	511381
	2006.04-2014.08		Centre	Chassis cabin RWD H9FD		Center Bearing Support Kit	537769
	2006.04-2014.08		Centre	VAN RWD H9FD		Center Bearing Support Kit	537769
	2006.04-2014.08		Front	Chassis cabin RWD H9FD	6MT	Flexible Coupling	533418
	2006.04-2014.08		Front	VAN RWD H9FD	6MT	Flexible Coupling	533418
	2006.04-2014.08		Front	Chassis cabin RWD H9FD	Transm.Type:MT75,5MT	Flexible Coupling	533420
	2006.04-2014.08		Front	VAN RWD H9FD	Transm.Type:MT75,5MT	Flexible Coupling	533420
3.2 (147 kw)	2007.09-2014.08		Centre	Chassis cabin RWD SAFA/SAFB		Center Bearing Support Kit	537769
	2007.09-2014.08		Centre	VAN RWD SAFA/SAFB		Center Bearing Support Kit	537769
	2007.09-2014.08		Front	Chassis cabin RWD SAFA/SAFB	6MT	Flexible Coupling	533418
	2007.09-2014.08		Front	VAN RWD SAFA/SAFB	6MT	Flexible Coupling	533418
	2007.09-2014.08		Front	Chassis cabin RWD SAFA/SAFB	Transm.Type:MT75,5MT	Flexible Coupling	533420
	2007.09-2014.08		Front	VAN RWD SAFA/SAFB	Transm.Type:MT75,5MT	Flexible Coupling	533420
Transit 470							
2.0 (96 kw)	2019.05-		Centre	Chassis cabin RWD YMHA		Center Bearing Support	511381
	2019.05-		Centre	VAN RWD YMHA		Center Bearing Support	511381
	2019.05-		Front	Chassis cabin RWD YMHA		Flexible Coupling	533418
	2019.05-		Front	VAN RWD YMHA		Flexible Coupling	533418
2.0 (125 kw)	2016.03-		Centre	Chassis cabin 4WD YNR6		Center Bearing Support	511381
	2016.03-		Centre	VAN 4WD YNR6		Center Bearing Support	511381
	2016.03-		Centre	Chassis cabin RWD BLHA/YNR6		Center Bearing Support	511381
	2016.03-		Centre	VAN RWD BLHA/YNR6		Center Bearing Support	511381
	2016.03-		Front	Chassis cabin 4WD YNR6		Flexible Coupling	533418
	2016.03-		Front	VAN 4WD YNR6		Flexible Coupling	533418
	2016.03-		Front	Chassis cabin RWD BLHA/YNR6		Flexible Coupling	533418
	2016.03-		Front	VAN RWD BLHA/YNR6		Flexible Coupling	533418
2.2 (92 kw)	2013.08-2018.12		Centre	Chassis cabin RWD CYR5/USR6		Center Bearing Support	511381
	2013.08-2018.12		Centre	VAN RWD CYR5/USR6		Center Bearing Support	511381
	2013.08-2018.12		Front	Chassis cabin RWD CYR5/USR6		Flexible Coupling	533418
	2013.08-2018.12		Front	VAN RWD CYR5/USR6		Flexible Coupling	533418
2.2 (114 kw)	2013.08-2018.12		Centre	Chassis cabin RWD CV24/CVR5/UJR6		Center Bearing Support	511381
	2013.08-2018.12		Centre	VAN RWD CV24/CVR5/UJR6		Center Bearing Support	511381
	2013.08-2018.12		Front	Chassis cabin RWD CV24/CVR5/UJR6		Flexible Coupling	533418
	2013.08-2018.12		Front	VAN RWD CV24/CVR5/UJR6		Flexible Coupling	533418
Transit 80							
2.0 (66 kw)	1991.04-1994.06		Centre	VAN RWD NBA		Center Bearing Support	511380
	1991.04-1994.06		Centre	VAN RWD NBA		Center Bearing Support	511381
	1991.04-1994.07		Centre	BUS RWD NBA		Center Bearing Support	511380
	1991.04-1994.07		Centre	BUS RWD NBA		Center Bearing Support	511381
	1991.04-2001.07		Centre	Chassis cabin RWD NBA		Center Bearing Support	511380
	1991.04-2001.07		Centre	Chassis cabin RWD NBA		Center Bearing Support	511381
2.0 (72 kw)	1991.04-1994.07		Centre	Chassis cabin RWD NCA		Center Bearing Support	511380
	1991.04-1994.07		Centre	Chassis cabin RWD NCA		Center Bearing Support	511381
	1991.09-1994.06		Centre	VAN RWD NCA		Center Bearing Support	511380
	1991.09-1994.06		Centre	VAN RWD NCA		Center Bearing Support	511381
2.0 (84 kw)	1994.08-2000.03		Centre	VAN RWD NSF/NSG/NSH		Center Bearing Support	511381
2.5 (51 kw)	1991.04-1994.07		Centre	BUS RWD 4FA		Center Bearing Support	511380
	1991.04-1994.07		Centre	VAN RWD 4BC/4CC/4FA		Center Bearing Support	511380
	1991.04-1994.07		Centre	BUS RWD 4FA		Center Bearing Support	511381

	 YEAR	TRANSM.	FITTING POSITION	BODY STYLE & DRIVE TYPE & ENGINE	REMARKS	 PRODUCT	GSP Ref.
FORD							
Transit 80							
2.5 (51 kw)	1991.04-1994.07		Centre	VAN RWD 4BC/4CC/4FA		Center Bearing Support	511381
	1991.09-1994.08		Centre	Chassis cabin RWD 4BC/4CC		Center Bearing Support	511380
	1991.09-1994.08		Centre	Chassis cabin RWD 4BC/4CC		Center Bearing Support	511381
	1994.08-2000.11		Centre	VAN RWD 4FA/4FB/4FC		Center Bearing Support	511380
	1994.08-2000.11		Centre	VAN RWD 4FA/4FB/4FC		Center Bearing Support	511381
2.5 (55 kw)	1997.03-2000.09		Centre	VAN RWD 4HD		Center Bearing Support	511381
2.5 (56 kw)	1997.03-2000.09		Centre	VAN RWD 4HB/4HC		Center Bearing Support	511380
	1997.03-2000.09		Centre	VAN RWD 4HB/4HC		Center Bearing Support	511381
2.5 (59 kw)	1991.04-1994.07		Centre	Chassis cabin RWD 4DA		Center Bearing Support	511380
	1991.04-1994.07		Centre	Chassis cabin RWD 4DA		Center Bearing Support	511381
	1991.04-2001.07		Centre	VAN RWD 4DA		Center Bearing Support	511380
	1991.04-2001.07		Centre	VAN RWD 4DA		Center Bearing Support	511381
2.5 (63 kw)	1994.06-2000.03		Centre	VAN RWD 4GB/4GE/4GF		Center Bearing Support	511381
Transit Tourneo							
2.0 (55 kw)	2000.06-2003.08		Centre	BUS FWD D3FA		Center Bearing Support	511381
2.0 (84 kw)	1994.08-2000.12		Centre	BUS RWD NSF/NSG/NSH		Center Bearing Support	511381
2.0 (92 kw)	2002.09-2006.03		Centre	BUS FWD FIFA		Center Bearing Support	511381
2.2 (81 kw)	2006.07-2014.08		Centre	BUS FWD QVFA		Center Bearing Support Kit	537769
2.2 (85 kw)	2008.10-2014.08		Centre	BUS FWD SRFA/SRFB/SRFC/SRFD/SRFE		Center Bearing Support Kit	537769
2.2 (103 kw)	2007.09-2014.08		Centre	BUS FWD PGFA/PGB/UHFA/UHFB/UHFC		Center Bearing Support Kit	537769
			Centre	BUS RWD 4FA/4FB/4FC/4FD		Center Bearing Support	511380
2.5 (51 kw)	1994.11-2000.12		Centre	BUS RWD 4FA/4FB/4FC/4FD		Center Bearing Support	511381
	1994.11-2000.12		Centre	BUS RWD 4FA/4FB/4FC/4FD		Center Bearing Support	511381
2.5 (55 kw)	1994.08-2000.06		Centre	BUS RWD 4HA		Center Bearing Support	511381
2.5 (56 kw)	1994.08-2000.12		Centre	BUS RWD 4HB/4HC		Center Bearing Support	511380
	1994.08-2000.12		Centre	BUS RWD 4HB/4HC		Center Bearing Support	511381
2.5 (63 kw)	1994.11-2000.12		Centre	BUS RWD 4GA/4GB/4GC/4GD		Center Bearing Support	511381
2.5 (74 kw)	1998.04-2000.12		Centre	BUS RWD 4EB/4EC		Center Bearing Support	511381
FORD USA							
Edge							
2.0 (179 kw)	2011.09-2014.12		Front	SUV 4WD T20HDTX		Center Bearing Support	514810
	2011.09-2014.12		Rear	SUV 4WD T20HDTX		Center Bearing Support	514815
	2011.09-2015.06		Front	SUV FWD T20HDTX		Center Bearing Support	514810
	2011.09-2015.06		Rear	SUV FWD T20HDTX		Center Bearing Support	514815
3.5 (198 kw)	2006.08-2014.12		Front	SUV 4WD T35PDED		Center Bearing Support	514810
	2006.08-2014.12		Rear	SUV 4WD T35PDED		Center Bearing Support	514815
	2006.11-2014.12		Front	SUV FWD T35PDED		Center Bearing Support	514810
	2006.11-2014.12		Rear	SUV FWD T35PDED		Center Bearing Support	514815
3.5 (213 kw)	2010.01-2014.12		Front	SUV FWD T35PDED		Center Bearing Support	514810
	2010.01-2014.12		Rear	SUV FWD T35PDED		Center Bearing Support	514815
	2010.01-2015.12		Front	SUV 4WD T35PDED		Center Bearing Support	514810
	2010.01-2015.12		Rear	SUV 4WD T35PDED		Center Bearing Support	514815
Escape							
2.3 (114 kw)	2001.10-2004.12		-	SUV FWD ZH23HYU		Joint,propshaft	635047
Expedition							
5.4 (224 kw)	2006.09-		Front	SUV RWD 995		Propshaft	299302
	2006.09-		Front	SUV 4WD 995		Propshaft	299302
5.4 (231 kw)	2007.01-		Front	SUV RWD 995		Propshaft	299302
	2007.01-		Rear	SUV RWD 995		Joint,propshaft	818279
	2009.01-		Front	SUV RWD T54USEM		Propshaft	299302
	2010.01-		Front	SUV 4WD T54RSEM		Propshaft	299302
	2010.01-		Front	SUV 4WD T54RSEM		Joint,propshaft	818279
Explorer							
4.0 (157 kw)	2001.09-2006.04		Front	SUV 4WD 99EA		Joint,propshaft	661100
	2006.01-2011.05		Front	SUV 4WD 99EA		Propshaft	201972
	2006.05-2011.05		Front	SUV RWD 99EA		Propshaft	201972
4.6 (218 kw)	2006.05-2011.05		Front	SUV RWD 998A		Propshaft	201972
	2006.05-2011.05		Front	SUV 4WD 998A		Propshaft	201972
Explorer Sport Trac							
4.0 (157 kw)	2006.09-2010.12		Front	Pick up 4WD 99EA		Propshaft	201972
4.6 (218 kw)	2006.06-2011.05		Front	Pick up 4WD 998A		Propshaft	201972
F-150 Extended Cab							
3.7 (225 kw)	2013.09-		Front	Pick up AWD 99M		Joint,propshaft	818279
5.4 (231 kw)	2008.09-2010.12		Front	Pick up AWD 99L		Joint,propshaft	818279

	 YEAR	TRANSM.	FITTING POSITION	BODY STYLE & DRIVE TYPE & ENGINE	REMARKS	 PRODUCT	GSP Ref.
FORD USA							
F-150 Extended Cab							
6.2 (306 kw)	2010.09-		Front	Pick up RWD C62RSEM		Joint,propshaft	818279
F-150 Standard Cab							
4.6 (185 kw)	2008.09-2010.12		Front	Pick up AWD 999		Joint,propshaft	818279
F150							
3.5 (272 kw)	2011.01-2014.12		Front	Pick up 4WD T35PDTD		Joint,propshaft	818279
5.0 (268 kw)	2011.01-2014.11		Front	Pick up 4WD 99F		Joint,propshaft	818279
Mustang							
4.6 (224 kw)	2004.12-2010.12		-	Coupe RWD C46USEM		Joint,propshaft	699240
Ranger							
2.2 (88 kw)	2011.04-	6AT	Rear	Pick up RWD GBVAJPF		Propshaft	PS901343
	2011.04-	6MT	Rear	Pick up RWD GBVAJPF		Propshaft	PS901341
2.2 (92 kw)	2011.04-	6AT	Rear	Pick up 4WD GBVAJQW		Propshaft	PS901343
	2011.04-	6AT	Rear	Pick up RWD GBVAJQW		Propshaft	PS901343
	2011.04-	6MT	Rear	Pick up RWD GBVAJQW		Propshaft	PS901341
2.2 (110 kw)	2011.04-	6AT	Rear	Pick up 4WD GBVAJQJ		Propshaft	PS901343
	2011.11-	6AT	Rear	Pick up RWD GBVAJQJ		Propshaft	PS901343
	2011.11-	6MT	Rear	Pick up RWD GBVAJQJ		Propshaft	PS901341
2.3 (107 kw)	2001.01-2012.12		Front	Pick up RWD T23HDEX		Joint,propshaft	661100
2.5 (57 kw)	1998.10-2002.02		Centre	Pick up RWD WL31		Center Bearing Support	532827
2.5 (62 kw)	1998.06-2006.06		Centre	Pick up 4WD WLT		Center Bearing Support Kit	514806S
	1998.06-2006.06		Centre	Pick up RWD WLT		Center Bearing Support Kit	514806S
2.5 (80 kw)	1998.10-2006.06		Centre	Pick up 4WD WLT		Center Bearing Support Kit	514806S
2.5 (105 kw)	2005.06-2011.12		Rear	Pick up 4WD WLAA		Propshaft	PS900583
3.0 (109 kw)	1999.06-2005.09		Front	Pick up 4WD 99U30		Joint,propshaft	661100
3.2 (147 kw)	2011.04-	6AT	Rear	Pick up 4WD SA2R/SA2S/SA2W/SAFA		Propshaft	PS901342
	2011.04-	6AT	Rear	Pick up RWD SAFA		Propshaft	PS901343
	2011.04-	6MT	Rear	Pick up RWD SAFA		Propshaft	PS901341
4.0 (152 kw)	2005.10-2010.09		Front	Pick up 4WD C40VSEX		Joint,propshaft	661100
Ranger Extended Cab							
2.3 (107 kw)	2002.09-2011.12		Front	Pick up AWD T23HDEX		Joint,propshaft	661100
2.5 (89 kw)	1999.09-2001.12		Front	Pick up AWD		Joint,propshaft	661100
4.0 (119 kw)	1997.09-2000.12		Front	Pick up AWD		Joint,propshaft	661100
Ranger Standard Cab							
2.3 (107 kw)	2002.09-2012.12		Front	Pick up AWD T23HDEX		Joint,propshaft	661100
2.5 (87 kw)	1997.09-1999.12		Front	Pick up AWD C25		Joint,propshaft	661100
3.0 (108 kw)	1997.09-1999.12		Front	Pick up AWD T30VVEX		Joint,propshaft	661100
4.0 (154 kw)	2000.09-2011.12		Front	Pick up AWD		Joint,propshaft	661100
GMC							
Envoy							
4.2 (205 kw)	2002.01-2005.12		Front	SUV 4WD LL8(254CUL6)		Joint,propshaft	608073
5.3 (216 kw)	2003.01-2005.12		Front	SUV 4WD LM4		Joint,propshaft	608073
Jimmy							
4.3 (142 kw)	1994.06-2005.05		Front	SUV 4WD L35(262CUL6)/LU3		Joint,propshaft	608072
	1994.06-2005.05		Front	SUV 4WD L35(262CUL6)/LU3		Joint,propshaft	608073
	1994.06-2005.05		Front	SUV 4WD L35(262CUL6)/LU3		Joint,propshaft	699117
	1994.10-2005.05		Front	SUV RWD L35(262CUL6)/LU3		Joint,propshaft	608072
Safar Extended Cargo Van							
4.3 (123 kw)	1992.09-1994.12		Front	VAN AWD LB4		Joint,propshaft	699117
Safar Extended Passenger Van							
4.3 (123 kw)	1992.09-1994.12		Front	BUS AWD LB4		Joint,propshaft	699117
Safar Standard Cargo Van							
4.3 (123 kw)	1992.09-1994.12		Front	VAN AWD LB4		Joint,propshaft	699117
Safar Standard Passenger Van							
4.3 (123 kw)	1992.09-1994.12		Front	BUS AWD LB4		Joint,propshaft	699117
Safari							
4.3 (142 kw)	1994.09-2005.12		Front	VAN AWD L35(262CUL6)/LU3		Joint,propshaft	699117
	1994.09-2005.12		Front	BUS AWD L35(262CUL6)/LU3		Joint,propshaft	699117
	2002.01-2006.12		Front	VAN 4WD LU3		Joint,propshaft	699117
Sonoma							
4.3 (134 kw)	2000.09-2002.12		Front	Pick up RWD L35(262CUL6)		Joint,propshaft	608072
	2000.09-2004.12		Front	Pick up AWD L35(262CUL6)		Joint,propshaft	608073

	 YEAR	TRANSM.	FITTING POSITION	BODY STYLE & DRIVE TYPE & ENGINE	REMARKS	 PRODUCT	GSP Ref.
HONDA Civic							
1.6 (92 kw)	1992.01-1995.10		Centre	Saloon 4WD D16Z7		Center Bearing Support	514782
CR-V							
2.0 (94 kw)	1997.02-2000.12	AT/MT	Rear	SUV 4WD B20B3/B20B9	Date To:1999.12	Propshaft	PS900251
2.0 (108 kw)	1999.01-2002.02	AT/MT	Rear	SUV 4WD B20Z1/B20Z3		Propshaft	PS900251
2.0 (110 kw)	2001.09-2007.03		-	SUV 4WD K20A4		Propshaft	PS900250
	2006.10-2012.06	AT/MT	Rear	SUV 4WD R20A2	Date From:2007.01	Propshaft	PS900252
2.0 (114 kw)	2012.10-	5AT	Rear	SUV 4WD R20A9		Propshaft	PS900253
2.0 (115 kw)	2005.01-2007.07		-	SUV 4WD K20A4/K20A5		Propshaft	PS900250
2.2 (103 kw)	2005.01-2006.09		-	SUV 4WD N22A2		Propshaft	PS900250
	2006.10-2009.09	AT/MT	Rear	SUV 4WD N22A2		Propshaft	PS900252
2.2 (110 kw)	2009.10-2014.12	AT/MT	Rear	SUV 4WD N22B3/N22B4		Propshaft	PS900252
2.4 (118 kw)	2002.03-2006.09		Centre	SUV 4WD K24A1		Center Bearing Support	514816
	2006.10-2012.06	AT/MT	Rear	SUV 4WD K24Z1	Date From:2007.01	Propshaft	PS900252
	2006.10-2012.06		Centre	SUV 4WD K24Z1		Center Bearing Support	514817
2.4 (119 kw)	2001.09-2006.09		Centre	SUV 4WD K24A1		Center Bearing Support	514816
2.4 (122 kw)	2009.09-2012.06	AT/MT	Rear	SUV 4WD K24Z4		Propshaft	PS900252
2.4 (124 kw)	2006.06-2012.06	AT/MT	Rear	SUV 4WD K24Z1		Propshaft	PS900252
2.4 (125 kw)	2007.04-2012.06	AT/MT	Rear	SUV 4WD K24Z1		Propshaft	PS900252
	2012.01-	5AT	Rear	SUV 4WD K24A1		Propshaft	PS900253
2.4 (136 kw)	2012.01-	5AT	Rear	SUV 4WD K24A1		Propshaft	PS900253
CR-V IV							
2.0 (114 kw)	2012.01-2017.12	5AT	Rear	SUV AWD R20A1		Propshaft	PS900253
Elysion							
2.4 (118 kw)	2004.05-2013.10		Centre	MPV FWD K24A6		Center Bearing Support	514816
HR-V							
1.6 (77 kw)	1999.02-2005.09		Centre	SUV 4WD D16W1		Center Bearing Support	514788
1.6 (91 kw)	1999.10-2005.09		Centre	SUV 4WD D16W5		Center Bearing Support	514788
Integra							
1.8 (147 kw)	1993.09-2001.08		Centre	Saloon FWD B18C3		Center Bearing Support	514782
HUMMER H3							
3.7 (180 kw)	2006.09-2010.12		-	Terrain cab wagon closed 4WD LLR		Propshaft	299303
HYUNDAI Grand Starex							
2.5 (103 kw)	2012.10-	5MT	Rear	BUS RWD D4CB		Propshaft	PS900260
H1							
2.5 (81 kw)	2008.02- 2010.07-	5MT 5MT	Rear Rear	VAN RWD D4CB BUS RWD D4CB		Propshaft Propshaft	PS900260 PS900260
2.5 (85 kw)	2008.12- 2011.08-	5MT 5MT	Rear Rear	VAN RWD D4CB BUS RWD D4CB		Propshaft Propshaft	PS900260 PS900260
2.5 (94 kw)	2007.09- 2007.09-	5MT 5MT	Rear Rear	VAN RWD D4CB BUS RWD D4CB		Propshaft Propshaft	PS900260 PS900260
2.5 (100 kw)	2007.09- 2007.09-	5MT 5MT	Rear Rear	BUS RWD D4CB VAN RWD D4CB		Propshaft Propshaft	PS900260 PS900260
2.5 (120 kw)	2008.02- 2008.05-	5MT 5MT	Rear Rear	VAN RWD D4CB BUS RWD D4CB		Propshaft Propshaft	PS900260 PS900260
2.5 (125 kw)	2008.02- 2008.05-	5MT 5MT	Rear Rear	VAN RWD D4CB BUS RWD D4CB		Propshaft Propshaft	PS900260 PS900260
2.5 (129 kw)	2015.01-	5MT	Rear	BUS RWD D4CB		Propshaft	PS900260
ix35							
2.0 (100 kw)	2009.08-2015.12	AT/MT	Rear	SUV 4WD D4HA	Date To:2010.12	Propshaft	PS900271
	2009.08-2015.12	AT/MT	Rear	SUV 4WD D4HA	Date From:2010.12	Propshaft	PS900272
	2009.08-2015.12		Centre	SUV 4WD D4HA		Center Bearing Support	514811
	2009.08-2015.12		Centre	SUV 4WD D4HA		Center Bearing Support Kit	514811S
	2009.08-2015.12		Front;Rear	SUV 4WD D4HA		Flexible Coupling	533419
	2015.05-2015.12		Front;Rear	SUV Van 4WD D4HA		Flexible Coupling	533419
2.0 (110 kw)	2009.08-2013.07	AT/MT	Rear	SUV 4WD G4KD	Date From:2010.01 to 2010.12	Propshaft	PS900271
	2009.08-2013.07	AT/MT	Rear	SUV 4WD G4KD	Date From:2010.01	Propshaft	PS900272
	2009.08-2013.07		Front;Rear	SUV 4WD G4KD		Flexible Coupling	533419
2.0 (120 kw)	2009.08-2013.07	AT/MT	Rear	SUV 4WD G4KD	Date To:2010.12	Propshaft	PS900271
	2009.08-2013.07	AT/MT	Rear	SUV 4WD G4KD	Date From:2010.12	Propshaft	PS900272
	2009.08-2013.07		Centre	SUV 4WD G4KD		Center Bearing Support	514811
	2009.08-2013.07		Centre	SUV 4WD G4KD		Center Bearing Support Kit	514811S
	2009.08-2013.07		Front;Rear	SUV 4WD G4KD		Flexible Coupling	533419



	 YEAR	TRANSM.	FITTING POSITION	BODY STYLE & DRIVE TYPE & ENGINE	REMARKS	 PRODUCT	GSP Ref.
HYUNDAI ix35							
2.0 (122 kw)	2013.08-2015.12		Centre	SUV 4WD G4NC		Center Bearing Support	514811
	2013.08-2015.12		Centre	SUV 4WD G4NC		Center Bearing Support Kit	514811S
2.0 (135 kw)	2009.08-2015.12	AT/MT	Rear	SUV 4WD D4HA	Date To:2010.12	Propshaft	PS900271
	2009.08-2015.12	AT/MT	Rear	SUV 4WD D4HA	Date From:2010.12	Propshaft	PS900272
	2009.08-2015.12		Centre	SUV 4WD D4HA		Center Bearing Support	514811
	2009.08-2015.12		Centre	SUV 4WD D4HA		Center Bearing Support Kit	514811S
	2009.08-2015.12		Front;Rear	SUV 4WD D4HA		Flexible Coupling	533419
2.4 (125 kw)	2014.12-2015.06		Front;Rear	SUV 4WD G4KE		Flexible Coupling	533419
2.4 (130 kw)	2009.08-2015.12	AT/MT	Rear	SUV 4WD G4KE	Date To:2010.12	Propshaft	PS900271
	2009.08-2015.12	AT/MT	Rear	SUV 4WD G4KE	Date From:2010.12	Propshaft	PS900272
	2009.08-2015.12		Front;Rear	SUV 4WD G4KE		Flexible Coupling	533419
ix55							
3.0 (176 kw)	2008.09-2012.11		Front;Rear	SUV 4WD D6EA		Flexible Coupling	533419
3.0 (184 kw)	2011.09-2012.11		Front;Rear	SUV 4WD D6EA		Flexible Coupling	533419
3.8 (191 kw)	2008.09-2012.11		Front;Rear	SUV 4WD G6DA		Flexible Coupling	533419
Santa Fe							
2.0 (83 kw)	2001.04-2006.03		Centre	SUV 4WD D4EA		Center Bearing Support	531680
	2001.04-2006.03		Centre	SUV 4WD D4EA		Center Bearing Support Kit	531679S
	2001.04-2006.03		Rear	SUV 4WD D4EA		Flexible Coupling	519580
	2001.08-2006.03		Centre	SUV FWD D4EA		Center Bearing Support	531680
	2001.08-2006.03		Centre	SUV FWD D4EA		Center Bearing Support Kit	531679S
2.0 (85 kw)	2006.03-2011.12		Centre	SUV 4WD D4EA		Center Bearing Support	531680
	2006.03-2011.12		Centre	SUV 4WD D4EA		Center Bearing Support Kit	514811S
	2006.03-2011.12		Centre	SUV 4WD D4EA	Code:BM,CM,Date to:2009.09	Center Bearing Support Kit	531679S
2.0 (92 kw)	2003.08-2006.03		Centre	SUV 4WD D4EA		Center Bearing Support	531680
	2003.08-2006.03		Centre	SUV Van 4WD D4EA		Center Bearing Support	531680
	2003.08-2006.03		Centre	SUV 4WD D4EA		Center Bearing Support Kit	531679S
	2003.08-2006.03		Centre	SUV Van 4WD D4EA		Center Bearing Support Kit	531679S
	2003.08-2006.03		Rear	SUV 4WD D4EA		Flexible Coupling	519580
2.0 (99 kw)	2000.08-2005.12		Centre	SUV FWD G4JP		Center Bearing Support	531680
	2000.08-2005.12		Centre	SUV FWD G4JP		Center Bearing Support Kit	531679S
2.0 (107 kw)	2003.11-2005.12		Centre	SUV 4WD D4EA		Center Bearing Support	531680
	2003.11-2005.12		Centre	SUV 4WD D4EA		Center Bearing Support Kit	531679S
	2003.11-2005.12		Rear	SUV 4WD D4EA		Flexible Coupling	519580
2.0 (110 kw)	2010.12-2012.12		Centre	SUV 4WD D4HA		Center Bearing Support Kit	514811S
2.0 (135 kw)	2006.03-2012.12		Centre	SUV 4WD D4HA		Center Bearing Support	531680
	2006.03-2012.12		Centre	SUV 4WD D4HA		Center Bearing Support Kit	514811S
	2006.03-2012.12		Centre	SUV 4WD D4HA	Code:CM,BM,Date to:2009.09	Center Bearing Support Kit	531679S
2.2 (102 kw)	2006.03-2007.08	AT/MT	Rear	SUV 4WD D4EB	Date To:2009.02	Propshaft	PS900269
	2006.03-2007.08		Centre	SUV 4WD D4EB		Center Bearing Support	531680
	2006.03-2007.08		Centre	SUV FWD D4EB		Center Bearing Support	531680
	2006.03-2007.08		Centre	SUV 4WD D4EB		Center Bearing Support Kit	514811S
	2006.03-2007.08		Centre	SUV 4WD D4EB	Code:BM,CM,Date to:2009.09	Center Bearing Support Kit	531679S
	2006.03-2007.08		Centre	SUV FWD D4EB		Center Bearing Support Kit	531679S
	2006.03-2007.08		Front;Rear	SUV 4WD D4EB		Flexible Coupling	533419
2.2 (110 kw)	2005.11-2011.12	AT/MT	Rear	SUV 4WD D4EB	Date To:2009.02	Propshaft	PS900269
	2005.11-2011.12		Centre	SUV 4WD D4EB		Center Bearing Support	531680
	2005.11-2011.12		Centre	SUV FWD D4EB		Center Bearing Support	531680
	2005.11-2011.12		Centre	SUV Van 4WD D4EB		Center Bearing Support	531680
	2005.11-2011.12		Centre	SUV 4WD D4EB		Center Bearing Support Kit	514811S
	2005.11-2011.12		Centre	SUV 4WD D4EB	Date to:2009.09	Center Bearing Support Kit	531679S
	2005.11-2011.12		Centre	SUV FWD D4EB		Center Bearing Support Kit	531679S
	2005.11-2011.12		Centre	SUV Van 4WD D4EB		Center Bearing Support Kit	531679S
	2005.11-2011.12		Front;Rear	SUV 4WD D4EB		Flexible Coupling	533419
2005.11-2011.12		Front;Rear	SUV Van 4WD D4EB		Flexible Coupling	533419	
2.2 (114 kw)	2006.09-2011.12	AT/MT	Rear	SUV 4WD D4EB	Date To:2009.02	Propshaft	PS900269
	2006.09-2011.12		Centre	SUV 4WD D4EB		Center Bearing Support	531680
	2006.09-2011.12		Centre	SUV FWD D4EB		Center Bearing Support	531680
	2006.09-2011.12		Centre	SUV Van 4WD D4EB		Center Bearing Support	531680
	2006.09-2011.12		Centre	SUV Van FWD D4EB		Center Bearing Support	531680
	2006.09-2011.12		Centre	SUV 4WD D4EB		Center Bearing Support Kit	514811S
	2006.09-2011.12		Centre	SUV 4WD D4EB	Date to:2009.09	Center Bearing Support Kit	531679S
	2006.09-2011.12		Centre	SUV FWD D4EB		Center Bearing Support Kit	531679S
	2006.09-2011.12		Centre	SUV Van 4WD D4EB		Center Bearing Support Kit	531679S



	 YEAR	TRANSM.	FITTING POSITION	BODY STYLE & DRIVE TYPE & ENGINE	REMARKS	 PRODUCT	GSP Ref.
HYUNDAI							
Santa Fe							
2.2 (114 kw)	2006.09-2011.12		Centre	SUV Van FWD D4EB		Center Bearing Support Kit	531679S
	2006.09-2011.12		Front;Rear	SUV 4WD D4EB		Flexible Coupling	533419
	2006.09-2011.12		Front;Rear	SUV Van 4WD D4EB		Flexible Coupling	533419
2.2 (145 kw)	2009.01-2013.05		Centre	SUV 4WD D4HB		Center Bearing Support	531680
	2009.01-2013.05		Centre	SUV Van 4WD D4HB		Center Bearing Support	531680
	2009.01-2013.05		Centre	SUV 4WD D4HB		Center Bearing Support Kit	514811S
	2009.01-2013.05		Centre	SUV 4WD D4HB	Code:CM,Date to:2009.09	Center Bearing Support Kit	531679S
	2009.01-2013.05		Centre	SUV Van 4WD D4HB		Center Bearing Support Kit	531679S
	2009.01-2013.05		Front;Rear	SUV 4WD D4HB		Flexible Coupling	533419
	2009.01-2013.05		Front;Rear	SUV Van 4WD D4HB		Flexible Coupling	533419
	2012.08- 2015.05-		Front;Rear	SUV 4WD D4HB		Flexible Coupling	533419
2.2 (147 kw)	2009.01-2012.12		Centre	SUV 4WD D4HB		Center Bearing Support	531680
	2009.01-2012.12		Centre	SUV 4WD D4HB		Center Bearing Support Kit	531679S
	2009.01-2012.12		Front;Rear	SUV 4WD D4HB		Flexible Coupling	533419
	2012.08-		Front;Rear	SUV 4WD D4HB		Flexible Coupling	533419
2.2 (149 kw)	2015.06-		Front;Rear	SUV 4WD D4HB		Flexible Coupling	533419
2.4 (100 kw)	2000.08-2005.12	MT	Rear	SUV 4WD G4JS		Propshaft	PS900264
	2000.08-2005.12		Rear	SUV 4WD G4JS		Flexible Coupling	519580
2.4 (107 kw)	2000.08-2005.12	MT	Rear	SUV 4WD G4JS		Propshaft	PS900264
	2000.08-2005.12		Rear	SUV 4WD G4JS		Flexible Coupling	519580
2.4 (128 kw)	2009.01-2012.12	6AT/6MT	Rear	SUV 4WD G4KE		Propshaft	PS900268
	2009.01-2012.12		Centre	SUV 4WD G4KE		Center Bearing Support Kit	514811S
2.4 (130 kw)	2009.09-2012.12	6AT/6MT	Rear	SUV AWD G4KE		Propshaft	PS900268
2.7 (125 kw)	2006.03-2008.12		Centre	SUV FWD G6EA		Center Bearing Support	531680
	2006.03-2008.12		Centre	SUV FWD G6EA		Center Bearing Support Kit	531679S
	2006.03-2009.09	AT/MT	Rear	SUV 4WD G6EA	Date To:2009.02	Propshaft	PS900269
	2006.03-2009.09		Centre	SUV 4WD G6EA		Center Bearing Support	531680
	2006.03-2009.09		Centre	SUV 4WD G6EA		Center Bearing Support Kit	531679S
	2006.03-2009.09		Front;Rear	SUV 4WD G6EA		Flexible Coupling	533419
2.7 (127 kw)	2000.08-2006.03	AT	Rear	SUV 4WD G6BA		Propshaft	PS900264
	2000.08-2006.03		Centre	SUV 4WD G6BA		Center Bearing Support	531680
	2000.08-2006.03		Centre	SUV 4WD G6BA		Center Bearing Support Kit	531679S
	2000.08-2006.03		Rear	SUV 4WD G6BA		Flexible Coupling	519580
2.7 (129 kw)	2002.09-2004.12		Rear	SUV 4WD G6BA		Flexible Coupling	519580
	2004.08-2006.03		Centre	SUV FWD G6BA		Center Bearing Support	531680
	2004.08-2006.03		Centre	SUV FWD G6BA		Center Bearing Support Kit	531679S
2.7 (132 kw)	2001.03-2005.12		Centre	SUV 4WD G6EA		Center Bearing Support	531680
	2001.03-2005.12		Centre	SUV 4WD G6EA		Center Bearing Support Kit	531679S
	2001.03-2005.12		Rear	SUV 4WD G6EA		Flexible Coupling	519580
2.7 (136 kw)	2006.09-2009.12		Centre	SUV FWD G6EA		Center Bearing Support	531680
	2006.09-2009.12		Centre	SUV FWD G6EA		Center Bearing Support Kit	531679S
2.7 (139 kw)	2005.11-2011.09		Centre	SUV FWD G6EA		Center Bearing Support	531680
	2005.11-2011.09		Centre	SUV FWD G6EA		Center Bearing Support Kit	531679S
	2005.11-2012.10	AT/MT	Rear	SUV 4WD G6EA	Date To:2009.02	Propshaft	PS900269
	2005.11-2012.10		Centre	SUV 4WD G6EA		Center Bearing Support	531680
	2005.11-2012.10		Centre	SUV 4WD G6EA		Center Bearing Support Kit	531679S
	2005.11-2012.10		Front;Rear	SUV 4WD G6EA		Flexible Coupling	533419
2.7 (147 kw)	2007.01-2011.12		Centre	SUV 4WD G6EA		Center Bearing Support	531680
	2007.01-2011.12		Centre	SUV 4WD G6EA		Center Bearing Support Kit	531679S
	2007.01-2011.12		Front;Rear	SUV 4WD G6EA		Flexible Coupling	533419
3.3 (173 kw)	2006.03-2006.12		Centre	SUV 4WD G6DB		Center Bearing Support	531680
	2006.03-2006.12		Centre	SUV 4WD G6DB		Center Bearing Support Kit	531679S
Tucson							
1.6 (130 kw)	2015.06-2020.09		Front;Rear	SUV 4WD G4FJ		Flexible Coupling	533419
2.0 (83 kw)	2004.08-2010.03		Rear	SUV 4WD D4EA		Propshaft	PS900270
	2004.08-2010.03		Centre	SUV 4WD D4EA		Center Bearing Support	514793
2.0 (88 kw)	2007.01-2010.03	5MT	Rear	SUV 4WD D4EA		Propshaft	PS900270
	2007.01-2010.03		Centre	SUV 4WD D4EA		Center Bearing Support	514793
2.0 (100 kw)	2006.01-2010.03	5MT	Rear	SUV 4WD D4EA		Propshaft	PS900270
	2006.01-2010.03		Centre	SUV 4WD D4EA		Center Bearing Support	514793
	2015.06-2020.09		Front;Rear	SUV 4WD D4HA		Flexible Coupling	533419
2.0 (103 kw)	2006.01-2010.03	5MT	Rear	SUV 4WD D4EA		Propshaft	PS900270
	2006.01-2010.03		Centre	SUV 4WD D4EA		Center Bearing Support	514793



	 YEAR	TRANSM.	FITTING POSITION	BODY STYLE & DRIVE TYPE & ENGINE	REMARKS	 PRODUCT	GSP Ref.
HYUNDAI Tucson							
2.0 (104 kw)	2004.06-2010.03	5MT	Rear	SUV 4WD G4GC	Model year from:2006	Propshaft	PS900270
	2004.06-2010.03	5MT	Rear	SUV 4WD G4GC	Model year to:2005	Propshaft	PS900273
	2004.06-2010.03		Centre	SUV 4WD G4GC		Center Bearing Support	514793
	2004.06-2010.03		Centre	SUV 4WD G4GC		Center Bearing Support Kit	514793S
	2009.06-2010.03	5MT	Rear	SUV 4WD G4GC		Propshaft	PS900270
2.0 (105 kw)	2005.07-2010.11	5MT	Rear	SUV 4WD G4GC		Propshaft	PS900270
	2005.07-2010.11		Centre	SUV 4WD G4GC		Center Bearing Support	514793
2.0 (110 kw)	2008.01-2010.03		Rear	SUV 4WD D4EA		Propshaft	PS900270
	2008.01-2010.03		Centre	SUV 4WD D4EA		Center Bearing Support	514793
	2015.06-2020.09		Front;Rear	SUV 4WD G4NA		Flexible Coupling	533419
2.0 (114 kw)	2015.06-2020.09		Front;Rear	SUV 4WD G4NA		Flexible Coupling	533419
2.0 (115 kw)	2015.06-2020.09		Front;Rear	SUV 4WD G4NA		Flexible Coupling	533419
2.0 (121 kw)	2015.06-2020.09		Front;Rear	SUV 4WD G4NC		Flexible Coupling	533419
2.0 (122 kw)	2009.08-	AT/MT	Rear	SUV 4WD G4KD	Date From:2010.01 to 2010.12	Propshaft	PS900271
	2009.08-	AT/MT	Rear	SUV 4WD G4KD	Date From:2010.01	Propshaft	PS900272
	2009.08-		Front;Rear	SUV 4WD G4KD		Flexible Coupling	533419
	2016.01-2020.09		Front;Rear	SUV 4WD G4NC		Flexible Coupling	533419
2.0 (129 kw)	2015.06-		Front;Rear	SUV 4WD D4HA		Flexible Coupling	533419
2.0 (130 kw)	2011.01-	AT/MT	Rear	SUV 4WD D4HA	Date:from 06.2011,until 08.2013	Propshaft	PS900272
	2011.01-		Front;Rear	SUV 4WD D4HA		Flexible Coupling	533419
2.0 (131 kw)	2015.06-2020.09		Front;Rear	SUV 4WD D4HA		Flexible Coupling	533419
2.0 (132 kw)	2010.01-	AT/MT	Rear	SUV 4WD D4HA	Date To:2010.12	Propshaft	PS900271
	2010.01-	AT/MT	Rear	SUV 4WD D4HA	Date From:2010.12	Propshaft	PS900272
	2010.01-		Front;Rear	SUV 4WD D4HA		Flexible Coupling	533419
2.0 (136 kw)	2015.06-2020.09		Front;Rear	SUV 4WD D4HA		Flexible Coupling	533419
2.7 (129 kw)	2004.08-2010.11	4AT	Rear	SUV 4WD G6BA	Model year from:2006	Propshaft	PS900270
	2004.08-2010.11	4AT	Rear	SUV 4WD G6BA	Model year to:2005	Propshaft	PS900273
	2004.08-2010.11		Centre	SUV 4WD G6BA		Center Bearing Support	514793
	2004.08-2010.11		Centre	SUV 4WD G6BA		Center Bearing Support Kit	514793S
Tucson iX35							
2.4 (128 kw)	2010.07-2013.12	AT/MT	Rear	SUV 4WD G4KE	Date:from 01.2011,from 06.2011,until 08.2013	Propshaft	PS900272
	2010.07-2013.12		Centre	SUV 4WD G4KE		Center Bearing Support	514811
	2010.07-2013.12		Centre	SUV 4WD G4KE		Center Bearing Support Kit	514811S
	2010.07-2013.12		Front;Rear	SUV 4WD G4KE		Flexible Coupling	533419
Veracruz							
3.0 (176 kw)	2008.01-2012.11		Front;Rear	SUV 4WD D6EA		Flexible Coupling	533419
	2008.01-2012.11		Front;Rear	SUV FWD D6EA		Flexible Coupling	533419
3.8 (191 kw)	2007.01-2012.11		Front;Rear	SUV 4WD G6DA		Flexible Coupling	533419
HYUNDAI (BEIJING) Tucson							
2.0 (104 kw)	2005.05-2015.12	5MT	Rear	SUV 4WD G4GCVG		Propshaft	PS900270
	2005.05-2015.12		Centre	SUV 4WD G4GCVG		Center Bearing Support	514793
2.7 (127 kw)	2005.06-2015.12	4AT	Rear	SUV 4WD G6BAH		Propshaft	PS900270
	2005.06-2015.12		Centre	SUV 4WD G6BAH		Center Bearing Support	514793
HYUNDAI (HUATAI) Santa Fe							
2.0 (85 kw)	2006.10-2008.12		Centre	SUV FWD D4EA		Center Bearing Support	531680
	2006.10-2008.12		Centre	SUV FWD D4EA		Center Bearing Support Kit	531679S
2.0 (92 kw)	2006.10-2011.12		Centre	SUV 4WD D4EA		Center Bearing Support	531680
	2006.10-2011.12		Centre	SUV 4WD D4EA		Center Bearing Support Kit	531679S
2.7 (132 kw)	2006.10-2013.12		Centre	SUV 4WD G6BA		Center Bearing Support	531680
	2006.10-2013.12		Centre	SUV 4WD G6BA		Center Bearing Support Kit	531679S
INFINITI EX30d							
3.0 (175 kw)	2010.04-		Front	SUV 4WD V9X		Propshaft	PS900275
FX30d							
3.0 (175 kw)	2010.04-2013.07	7AT	Front	SUV 4WD V9X		Propshaft	PS900275
FX35							
3.5 (206 kw)	2003.01-2008.12		Centre	SUV 4WD VQ35DE		Center Bearing Support Kit	514791S
FX45							
4.5 (232 kw)	2003.01-2008.10		Centre	SUV 4WD VK45DE		Center Bearing Support Kit	514791S
G							
3.7 (245 kw)	2008.09-		Front	Saloon RWD VQ37VHR		Propshaft	PS900275



	 YEAR	TRANSM.	FITTING POSITION	BODY STYLE & DRIVE TYPE & ENGINE	REMARKS	 PRODUCT	GSP Ref.
INFINITI							
G37							
3.7 (235 kw)	2008.10-		Front	Saloon RWD VQ37VHR		Propshaft	PS900275
3.7 (243 kw)	2008.10-		Front	Saloon RWD VQ37VHR		Propshaft	PS900275
M37							
3.7 (235 kw)	2010.03-		Front	Saloon RWD VQ37VHR		Propshaft	PS900275
3.7 (246 kw)	2010.01-		Front	Saloon 4WD VQ37VHR		Propshaft	PS900275
	2010.01-		Front	Saloon RWD VQ37VHR		Propshaft	PS900275
Q45							
4.1 (205 kw)	1996.07-2001.01		Centre	Saloon RWD VH41DE		Center Bearing Support Kit	514791S
4.5 (205 kw)	1989.08-1993.12		Centre	Saloon RWD VH45DE		Center Bearing Support Kit	514791S
QX4							
3.5 (179 kw)	2000.01-2003.12		Rear	Terrain cab wagon closed 4WD VQ35DE		Joint,propshaft	801298
ISUZU							
Ascender							
4.2 (217 kw)	2003.03-2007.09		Front	SUV 4WD LL8(254CUL6)		Joint,propshaft	608073
Rodeo							
2.5 (74 kw)	2002.05-2006.09		Centre	Pick up 4WD 4JA1TC		Center Bearing Support	530764
3.0 (96 kw)	2002.05-2005.03		Centre	Pick up 4WD 4JH1TC		Center Bearing Support	530764
IVECO							
Daily 29L15							
2.3 (107 kw)	2011.09-2014.02		Centre	Chassis cabin RWD F1AE3481C		Center Bearing Support	531049
Daily 29L15P							
2.3 (107 kw)	2011.09-2014.02		Centre	Chassis cabin RWD F1AE3481C		Center Bearing Support	531049
Daily 35C11							
2.8 (78 kw)	1999.07-2006.12		Centre	Chassis cabin RWD 814043B/814043C		Center Bearing Support	531049
	1999.07-2006.12		Centre	Chassis cabin RWD 814043B/814043C		Center Bearing Support	531667S
	1999.07-2006.12		Centre	VAN RWD 814043B/814043C		Center Bearing Support	531667S
Daily 35C11P							
2.8 (78 kw)	1999.07-2006.12		Centre	Chassis cabin RWD 814043B/814043C		Center Bearing Support	531049
	1999.07-2006.12		Centre	Chassis cabin RWD 814043B/814043C		Center Bearing Support	531667S
	1999.07-2006.12		Centre	VAN RWD 814043B/814043C		Center Bearing Support	531667S
Daily 35C13							
2.8 (92 kw)	1999.07-2006.12		Centre	Chassis cabin RWD 814043S		Center Bearing Support	531667S
	1999.07-2006.12		Centre	VAN RWD 814043S		Center Bearing Support	531667S
Daily 35C13P							
2.8 (92 kw)	1999.07-2006.12		Centre	Chassis cabin RWD 814043S		Center Bearing Support	531667S
	1999.07-2006.12		Centre	VAN RWD 814043S		Center Bearing Support	531667S
Daily 35C15							
2.3 (107 kw)	2011.09-2014.02		Centre	Chassis cabin RWD F1AE3481C		Center Bearing Support	531049
2.8 (107 kw)	1999.07-2006.12		Centre	Chassis cabin RWD 814043N		Center Bearing Support	531667S
	1999.07-2006.12		Centre	VAN RWD 814043N		Center Bearing Support	531667S
3.0 (107 kw)	2006.06-2011.08		Centre	Chassis cabin RWD F1CE0481F		Center Bearing Support	531049
	2006.06-2011.08		Centre	VAN RWD F1CE0481F		Center Bearing Support	531049
	2011.09-2014.02		Centre	Chassis cabin RWD F1CE3481B/F1CE3481J		Center Bearing Support	531049
	2011.09-2014.02		Centre	VAN RWD F1CE3481B/F1CE3481J		Center Bearing Support	531049
Daily 35C15P							
2.3 (107 kw)	2011.09-2014.02		Centre	Chassis cabin RWD F1AE3481C		Center Bearing Support	531049
2.8 (107 kw)	1999.07-2006.12		Centre	Chassis cabin RWD 814043N		Center Bearing Support	531667S
	1999.07-2006.12		Centre	VAN RWD 814043N		Center Bearing Support	531667S
3.0 (107 kw)	2006.06-2011.08		Centre	Chassis cabin RWD F1CE0481F		Center Bearing Support	531049
	2006.06-2011.08		Centre	VAN RWD F1CE0481F		Center Bearing Support	531049
	2011.09-2014.02		Centre	Chassis cabin RWD F1CE3481B/F1CE3481J		Center Bearing Support	531049
	2011.09-2014.02		Centre	VAN RWD F1CE3481B/F1CE3481J		Center Bearing Support	531049
Daily 35C9							
2.8 (62 kw)	1999.07-2006.12		Centre	Chassis cabin RWD 814063		Center Bearing Support	531667S
2.8 (66 kw)	1999.07-2006.12		Centre	Chassis cabin RWD 814043R		Center Bearing Support	531667S
Daily 35C9P							
2.8 (62 kw)	1999.07-2006.12		Centre	Chassis cabin RWD 814063		Center Bearing Support	531667S
Daily 35S11							
2.8 (78 kw)	1999.07-2006.12		Centre	Chassis cabin RWD 814043B/814043C		Center Bearing Support	531049
	1999.07-2006.12		Centre	Chassis cabin RWD 814043B/814043C		Center Bearing Support	531667S
	1999.07-2006.12		Centre	VAN RWD 814043B/814043C		Center Bearing Support	531667S
Daily 35S11P							
2.8 (78 kw)	1999.07-2006.12		Centre	Chassis cabin RWD 814043B/814043C		Center Bearing Support	531049
	1999.07-2006.12		Centre	Chassis cabin RWD 814043B/814043C		Center Bearing Support	531667S



	 YEAR	TRANSM.	FITTING POSITION	BODY STYLE & DRIVE TYPE & ENGINE	REMARKS	 PRODUCT	GSP Ref.
IVECO							
Daily 35S11P							
2.8 (78 kw)	1999.07-2006.12		Centre	VAN RWD 814043B/814043C		Center Bearing Support	531667S
Daily 35S13							
2.8 (92 kw)	1999.07-2006.12		Centre	Chassis cabin RWD 814043S		Center Bearing Support	531667S
	1999.07-2006.12		Centre	VAN RWD 814043S		Center Bearing Support	531667S
Daily 35S13P							
2.8 (92 kw)	1999.07-2006.12		Centre	Chassis cabin RWD 814043S		Center Bearing Support	531667S
	1999.07-2006.12		Centre	VAN RWD 814043S		Center Bearing Support	531667S
Daily 35S15							
2.3 (107 kw)	2011.09-2014.02		Centre	Chassis cabin RWD F1AE3481C		Center Bearing Support	531049
2.8 (107 kw)	1999.07-2006.12		Centre	VAN RWD 814043N		Center Bearing Support	531667S
3.0 (107 kw)	2011.09-2014.02		Centre	Chassis cabin RWD F1CE3481B/F1CE3481J		Center Bearing Support	531049
	2011.09-2014.02		Centre	VAN RWD F1CE3481J		Center Bearing Support	531049
Daily 35S15P							
2.3 (107 kw)	2011.09-2014.02		Centre	Chassis cabin RWD F1AE3481C		Center Bearing Support	531049
2.8 (107 kw)	1999.07-2006.12		Centre	VAN RWD 814043N		Center Bearing Support	531667S
3.0 (107 kw)	2011.09-2014.02		Centre	Chassis cabin RWD F1CE3481B		Center Bearing Support	531049
Daily 35S9							
2.8 (62 kw)	1999.07-2006.12		Centre	Chassis cabin RWD 814063		Center Bearing Support	531667S
2.8 (66 kw)	1999.07-2006.12		Centre	Chassis cabin RWD 814043R		Center Bearing Support	531667S
	1999.07-2006.12		Centre	VAN RWD 814043R		Center Bearing Support	531667S
Daily 35S9P							
2.8 (62 kw)	1999.07-2006.12		Centre	Chassis cabin RWD 814063		Center Bearing Support	531667S
2.8 (66 kw)	1999.07-2006.12		Centre	VAN RWD 814043R		Center Bearing Support	531667S
Daily 40C15							
3.0 (107 kw)	2011.09-2014.02		Centre	Chassis cabin RWD F1CE3481B/F1CE3481J		Center Bearing Support	531049
	2011.09-2014.02		Centre	VAN RWD F1CE3481B/F1CE3481J		Center Bearing Support	531049
Daily 40C15P							
3.0 (107 kw)	2011.09-2014.02		Centre	Chassis cabin RWD F1CE3481J		Center Bearing Support	531049
	2011.09-2014.02		Centre	VAN RWD F1CE3481B/F1CE3481J		Center Bearing Support	531049
Daily 45C15							
3.0 (107 kw)	2011.09-2014.02		Centre	Chassis cabin RWD F1CE3481B/F1CE3481J		Center Bearing Support	531049
	2011.09-2014.02		Centre	VAN RWD F1CE3481B/F1CE3481J		Center Bearing Support	531049
Daily 45C15P							
3.0 (107 kw)	2011.09-2014.02		Centre	Chassis cabin RWD F1CE3481B/F1CE3481J		Center Bearing Support	531049
	2011.09-2014.02		Centre	VAN RWD F1CE3481B/F1CE3481J		Center Bearing Support	531049
Daily 50C11							
2.8 (78 kw)	1999.07-2006.12		Centre	VAN RWD 814043B/814043C		Center Bearing Support	531667S
	1999.07-2006.12		Centre	Chassis cabin RWD 814043B/814043C		Center Bearing Support	531667S
Daily 50C11P							
2.8 (78 kw)	1999.07-2006.12		Centre	Chassis cabin RWD 814043B/814043C		Center Bearing Support	531667S
	1999.07-2006.12		Centre	VAN RWD 814043B/814043C		Center Bearing Support	531667S
Daily 50C13							
2.8 (92 kw)	1999.07-2006.12		Centre	Chassis cabin RWD 814043S		Center Bearing Support	531667S
	1999.07-2006.12		Centre	VAN RWD 814043S		Center Bearing Support	531667S
Daily 50C13P							
2.8 (92 kw)	1999.07-2006.12		Centre	Chassis cabin RWD 814043S		Center Bearing Support	531667S
	1999.07-2006.12		Centre	VAN RWD 814043S		Center Bearing Support	531667S
Daily 50C15							
2.8 (107 kw)	1999.07-2006.12		Centre	Chassis cabin RWD 814043N		Center Bearing Support	531667S
	1999.07-2006.12		Centre	VAN RWD 814043N		Center Bearing Support	531667S
3.0 (107 kw)	2011.09-2014.02		Centre	Chassis cabin RWD F1CE3481B/F1CE3481J		Center Bearing Support	531049
	2011.09-2014.02		Centre	VAN RWD F1CE3481B/F1CE3481J		Center Bearing Support	531049
Daily 50C15P							
2.8 (107 kw)	1999.07-2006.12		Centre	Chassis cabin RWD 814043N		Center Bearing Support	531667S
	1999.07-2006.12		Centre	VAN RWD 814043N		Center Bearing Support	531667S
3.0 (107 kw)	2011.09-2014.02		Centre	Chassis cabin RWD F1CE3481B/F1CE3481J		Center Bearing Support	531049
	2011.09-2014.02		Centre	VAN RWD F1CE3481B/F1CE3481J		Center Bearing Support	531049
Daily 60C13							
2.8 (103 kw)	1999.07-2006.12		Centre	Chassis cabin RWD 814043K		Center Bearing Support	531049
Daily 60C15							
3.0 (107 kw)	2011.09-2014.02		Centre	Chassis cabin RWD F1CE3481B/F1CE3481J		Center Bearing Support	531049
	2011.09-2014.02		Centre	VAN RWD F1CE3481B		Center Bearing Support	531049



	 YEAR	TRANSM.	FITTING POSITION	BODY STYLE & DRIVE TYPE & ENGINE	REMARKS	 PRODUCT	GSP Ref.
IVECO							
Daily 60C15P							
3.0 (107 kw)	2011.09-2014.02		Centre	Chassis cabin RWD F1CE3481B/F1CE3481J		Center Bearing Support	531049
Daily 65C13							
2.8 (103 kw)	1999.07-2006.12		Centre	Chassis cabin RWD 814043K		Center Bearing Support	531049
Daily 65C15							
2.8 (107 kw)	1999.07-2006.12		Centre	Chassis cabin RWD 814043N		Center Bearing Support	531667S
	1999.07-2006.12		Centre	VAN RWD 814043N		Center Bearing Support	531667S
3.0 (107 kw)	2011.09-2014.02		Centre	Chassis cabin RWD F1CE3481B/F1CE3481J		Center Bearing Support	531049
	2011.09-2014.02		Centre	VAN RWD F1CE3481B/F1CE3481J		Center Bearing Support	531049
Daily 65C15P							
2.8 (107 kw)	1999.07-2006.12		Centre	Chassis cabin RWD 814043N		Center Bearing Support	531667S
	1999.07-2006.12		Centre	VAN RWD 814043N		Center Bearing Support	531667S
3.0 (107 kw)	2011.09-2014.02		Centre	Chassis cabin RWD F1CE3481B/F1CE3481J		Center Bearing Support	531049
Daily 65C17							
3.0 (125 kw)	2009.09-2011.08		Centre	Chassis cabin RWD F1CE3481C		Center Bearing Support	531049
	2009.09-2011.08		Centre	VAN RWD F1CE3481C		Center Bearing Support	531049
Daily 65C17P							
3.0 (125 kw)	2009.09-2011.08		Centre	Chassis cabin RWD F1CE3481C		Center Bearing Support	531049
	2009.09-2011.08		Centre	VAN RWD F1CE3481C		Center Bearing Support	531049
Daily 65C18							
3.0 (130 kw)	2006.06-2009.08		Centre	VAN RWD F1CE0481H		Center Bearing Support	531049
	2006.06-2011.08		Centre	Chassis cabin RWD F1CE0481H		Center Bearing Support	531049
Daily 65C18P							
3.0 (130 kw)	2006.06-2009.08		Centre	VAN RWD F1CE0481H		Center Bearing Support	531049
	2006.06-2011.08		Centre	Chassis cabin RWD F1CE0481H		Center Bearing Support	531049
Daily 70C15							
3.0 (107 kw)	2011.09-2014.02		Centre	Chassis cabin RWD F1CE3481B/F1CE3481J		Center Bearing Support	531049
	2011.09-2014.02		Centre	VAN RWD F1CE3481B/F1CE3481J		Center Bearing Support	531049
Daily 70C15P							
3.0 (107 kw)	2011.09-2014.02		Centre	Chassis cabin RWD F1CE3481B/F1CE3481J		Center Bearing Support	531049
Daily 70C17							
3.0 (125 kw)	2009.09-2011.08		Centre	Chassis cabin RWD F1CE3481C		Center Bearing Support	531049
	2009.09-2011.08		Centre	VAN RWD F1CE3481C		Center Bearing Support	531049
Daily 70C17P							
3.0 (125 kw)	2009.09-2011.08		Centre	Chassis cabin RWD F1CE3481C		Center Bearing Support	531049
	2009.09-2011.08		Centre	VAN RWD F1CE3481C		Center Bearing Support	531049
Eurocargo							
3.922 (103 kw)	2006.09-2015.09		Front	Dump Truck 4x2 F4AE3481C(09.06-)		Center Bearing Support	531050
	2006.09-2015.09		Front	Platform/Chassis 4x2 F4AE3481C(09.06-)		Center Bearing Support	531050
3.922 (130 kw)	2006.09-2015.09		Front	Dump Truck 4x2 F4AE3481B(09.06-)		Center Bearing Support	531050
	2006.09-2015.09		Front	Platform/Chassis 4x2 F4AE3481B(09.06-)		Center Bearing Support	531050
5.883 (134 kw)	2000.09-2015.09		Front	Dump Truck 4x2 F4AE0681E(09.00-)		Center Bearing Support	531050
5.883 (154-160 kw)	2000.09-2015.09		Front	Dump Truck 4x2 F4AE0681D(09.00-)/F4AE3681B(05.06-)		Center Bearing Support	531050
JEEP							
Cherokee							
2.4 (108 kw)	2001.09-2005.09	MT	Rear	Terrain cab wagon closed 4WD ED1		Joint,propshaft	899032
2.5 (89 kw)	1990.10-2001.09		Front	Terrain cab wagon closed 4WD EPE		Joint,propshaft	616011
2.5 (105 kw)	2001.09-2005.09	MT	Rear	Terrain cab wagon closed 4WD ENJ		Joint,propshaft	899032
2.8 (110 kw)	2002.09-2008.01	AT/MT	Rear	Terrain cab wagon closed 4WD ENR		Joint,propshaft	899032
2.8 (120 kw)	2004.11-2008.01	AT/MT	Rear	Terrain cab wagon closed 4WD ENR		Joint,propshaft	899032
3.7 (150 kw)	2001.10-2008.01	AT	Rear	Terrain cab wagon closed 4WD EKG		Joint,propshaft	899032
3.7 (155 kw)	2001.09-2004.09	AT	Rear	Terrain cab wagon closed 4WD EKG		Joint,propshaft	899032
4.0 (127 kw)	1993.09-2001.09	AT	Front	Terrain cab wagon closed 4WD MX400L		Propshaft	PS900276
	1993.09-2001.09	MT	Front	Terrain cab wagon closed 4WD MX400L		Propshaft	PS900292
4.0 (135 kw)	1991.12-1995.09	AT	Front	Terrain cab wagon closed 4WD ERH		Propshaft	PS900276
	1991.12-1995.09	MT	Front	Terrain cab wagon closed 4WD ERH		Propshaft	PS900292
4.0 (136 kw)	1988.01-2001.09	AT	Front	Terrain cab wagon closed 4WD ERH		Propshaft	PS900276
	1988.01-2001.09	MT	Front	Terrain cab wagon closed 4WD ERH		Propshaft	PS900292
4.0 (142 kw)	1985.01-2001.12		Front	Terrain cab wagon closed 4WD ERH		Joint,propshaft	616011
Cherokee Classic							
4.0 (131 kw)	1999.02-2001.09	AT	Front	Terrain cab wagon closed 4WD ERH		Propshaft	PS900276
	1999.02-2001.09	MT	Front	Terrain cab wagon closed 4WD ERH		Propshaft	PS900292
Commander							
3.7 (157 kw)	2005.06-2010.12	AT	Front	SUV 4WD EKG	Date From:2007.01,Trans. code:NV245	Propshaft	202101
	2005.06-2010.12	AT	Front	SUV 4WD EKG	Date From:2007.01,Trans. code:NV140	Propshaft	202102



	 YEAR	TRANSM.	FITTING POSITION	BODY STYLE & DRIVE TYPE & ENGINE	REMARKS	 PRODUCT	GSP Ref.
JEEP Commander							
3.7 (157 kw)	2005.06-2010.12	AT	Front	SUV 4WD EKG	Date To:2006.12,Transfer Case ID:NV140	Propshaft	202280
	2005.06-2010.12	AT	Front	SUV 4WD EKG	Date To:2006.12,Transfer Case ID:NV245	Propshaft	202281
4.7 (170 kw)	2005.09-2010.12	AT	Front	SUV 4WD EVA	Date From:2007.01	Propshaft	202101
	2005.09-2010.12	AT	Front	SUV 4WD EVA	Date To:2006.12	Propshaft	202281
5.7 (240 kw)	2005.09-2010.12	AT	Front	SUV 4WD EZB	Date From:2007.01	Propshaft	202101
	2005.09-2010.12	AT	Front	SUV 4WD EZB	Date To:2006.12	Propshaft	202281
Compass							
2.0 (103 kw)	2007.02-	MT	Rear	SUV 4WD ECD/ECE		Propshaft	PS900303
2.2 (100 kw)	2011.05-	MT	Rear	SUV 4WD ENE		Propshaft	PS900303
2.2 (120 kw)	2010.12-	MT	Rear	SUV 4WD ENE		Propshaft	PS900303
2.4 (125 kw)	2007.01-	MT	Rear	SUV 4WD ED3/EDG		Propshaft	PS900303
Grand Cherokee							
2.7 (120 kw)	2001.09-2004.09		Front	Terrain cab wagon closed 4WD ENF		Propshaft	PS900282
	2001.09-2004.09	AT/MT	Front	Terrain cab wagon closed 4WD ENF	Date To:2004.09	Joint,propshaft	616005
	2001.09-2004.09	AT/MT	Rear	Terrain cab wagon closed 4WD ENF		Joint,propshaft	899032
	2001.10-2005.09	AT/MT	Rear	Terrain cab wagon closed 4WD DDAB		Joint,propshaft	899032
3.0 (140 kw)	2011.02-	AT	Front	SUV 4WD EXF	Trans. code:2 Speed On Demand	Propshaft	202100
	2011.02-	AT	Front	SUV 4WD EXF	Trans. code:Single Speed	Propshaft	PS900219
	2011.02-	AT	Rear	SUV 4WD EXF		Propshaft	PS900281
3.0 (155 kw)	2006.05-2010.12	AT	Front	Terrain cab wagon closed 4WD EXL		Propshaft	PS900602
3.0 (160 kw)	2005.06-2010.12	AT	Front	Terrain cab wagon closed 4WD EXL		Propshaft	PS900602
	2005.06-2010.12	AT	Rear	Terrain cab wagon closed 4WD EXL	for vehicles with automatic transmission	Joint,propshaft	899297
3.0 (177 kw)	2011.02-	AT	Front	SUV 4WD EXF	Trans. code:2 Speed On Demand	Propshaft	202100
	2011.02-	AT	Front	SUV 4WD EXF	Trans. code:Single Speed	Propshaft	PS900219
	2011.02-	AT	Rear	SUV 4WD EXF		Propshaft	PS900281
3.0 (184 kw)	2013.07-	AT	Front	SUV 4WD EXF	Trans. code:2 Speed On Demand	Propshaft	202100
	2013.07-	AT	Front	SUV 4WD EXF	Trans. code:Single Speed	Propshaft	PS900219
	2013.07-	AT	Rear	SUV 4WD EXF		Propshaft	PS900281
3.1 (103 kw)	1998.10-2002.03		Front	Terrain cab wagon closed 4WD EXA		Propshaft	PS900282
	1998.10-2002.03	AT/MT	Rear	Terrain cab wagon closed 4WD EXA		Joint,propshaft	899032
3.6 (210 kw)	2010.11-	AT	Front	SUV 4WD ERB/ERC	Trans. code:2 Speed On Demand,Date To:2014.12	Propshaft	202100
	2010.11-	AT	Front	SUV 4WD ERB/ERC	Date To:2014.12,Trans. code:Single Speed	Propshaft	PS900219
	2010.11-2013.12	AT	Front	SUV 4WD ERB	Trans. code:2 Speed On Demand	Propshaft	202100
	2010.11-2013.12	AT	Front	SUV 4WD ERB	Trans. code:Single Speed	Propshaft	PS900219
3.6 (213 kw)	2013.05-	AT	Front	SUV 4WD ERB	Trans. code:2 Speed On Demand	Propshaft	202100
	2013.05-	AT	Front	SUV 4WD ERB	Trans. code:Single Speed	Propshaft	PS900219
3.7 (157 kw)	2004.10-2010.12	AT	Front	Terrain cab wagon closed 4WD EKG	Date From:2007.01,Trans. code:NV245	Propshaft	202101
	2004.10-2010.12	AT	Front	Terrain cab wagon closed 4WD EKG	Date From:2007.01,Trans. code:NV140	Propshaft	202102
	2004.10-2010.12	AT	Front	Terrain cab wagon closed 4WD EKG	Date From:2005.01,Date To:2006.12,Transfer Case ID:NV140	Propshaft	202280
	2004.10-2010.12	AT	Front	Terrain cab wagon closed 4WD EKG	Date From:2005.01,Date To:2006.12,Transfer Case ID:NV245	Propshaft	202281
	2004.10-2010.12	-	-	Terrain cab wagon closed 4WD EKG		Joint,propshaft	899297
4.0 (138 kw)	1994.09-1998.12		Front	Closed Off-Road Vehicle AWD ERH		Joint,propshaft	616011
4.0 (140 kw)	1998.10-2004.09	AT/MT	Rear	Terrain cab wagon closed RWD ERH	Date From:1999.01	Joint,propshaft	899032
	1998.10-2004.12	AT/MT	Front	Terrain cab wagon closed 4WD ERH	Date From:2000.12,Ch. No.:WJ	Propshaft	201782
	1998.10-2004.12	AT/MT	Front	Terrain cab wagon closed 4WD ERH	Date To:2004.12	Propshaft	202440
	1998.10-2004.12	AT/MT	Front	Terrain cab wagon closed 4WD ERH	Date To:2004.12	Joint,propshaft	616005
	1998.10-2004.12	AT/MT	Rear	Terrain cab wagon closed 4WD ERH		Joint,propshaft	899032
4.7 (162 kw)	1999.02-2001.08		Front	Terrain cab wagon closed 4WD EVA		Propshaft	202440
	1999.02-2001.08		Front	Terrain cab wagon closed 4WD EVA	Pipe diameter:52mm	Propshaft	202442
	1999.02-2001.08	AT/MT	Rear	Terrain cab wagon closed 4WD EVA		Joint,propshaft	899032
4.7 (164 kw)	1999.04-2004.09		Front	Terrain cab wagon closed 4WD EVA	Date To:2004.09	Propshaft	202440
	1999.04-2004.09	AT/MT	Front	Terrain cab wagon closed 4WD EVA	Date To:2004.09	Joint,propshaft	616005
	1999.04-2004.09	AT/MT	Rear	Terrain cab wagon closed 4WD EVA	Date From:2001.01	Joint,propshaft	899032
4.7 (167 kw)	2003.06-2004.09		Front	Terrain cab wagon closed 4WD EVA	Date To:2004.09	Propshaft	202440
	2003.06-2004.09	AT/MT	Front	Terrain cab wagon closed 4WD EVA	Date To:2004.09	Joint,propshaft	616005
4.7 (170 kw)	2005.06-2010.12	AT	Front	Terrain cab wagon closed 4WD EVE	Date From:2007.01	Propshaft	202101
	2005.06-2010.12	AT	Front	Terrain cab wagon closed 4WD EVE	Date To:2006.12	Propshaft	202281
	2005.06-2010.12	-	-	Terrain cab wagon closed 4WD EVE		Joint,propshaft	899297
4.7 (190 kw)	2001.09-2004.09		Front	Terrain cab wagon closed 4WD EVC	Date To:2004.09	Propshaft	202440
	2001.09-2004.09	AT/MT	Front	Terrain cab wagon closed 4WD EVC	Date To:2004.09	Joint,propshaft	616005
	2001.09-2004.09	AT/MT	Rear	Terrain cab wagon closed 4WD EVC		Joint,propshaft	899032
5.2 (156 kw)	1995.10-1998.09		Front	Terrain cab wagon closed 4WD ELF		Joint,propshaft	616011
5.7 (240 kw)	2004.10-2010.12	AT	Front	Terrain cab wagon closed 4WD EZB	Date From:2007.01	Propshaft	202101
	2004.10-2010.12	AT	Front	Terrain cab wagon closed 4WD EZB	Date To:2006.12	Propshaft	202281

	 YEAR	TRANSM.	FITTING POSITION	BODY STYLE & DRIVE TYPE & ENGINE	REMARKS	 PRODUCT	GSP Ref.
JEEP							
Grand Cherokee							
5.7 (240 kw)	2004.10-2010.12		-	Terrain cab wagon closed 4WD EZB		Joint,propshaft	899297
5.7 (259 kw)	2010.11-	AT	Front	SUV 4WD EZH	Trans. code:2 Speed On Demand	Propshaft	202100
	2010.11-	AT	Front	SUV 4WD EZH	Trans. code:Single Speed	Propshaft	PS900219
5.9 (183 kw)	1997.09-1998.12		Front	Closed Off-Road Vehicle AWD EML		Joint,propshaft	616011
6.1 (313 kw)	2006.01-2010.12	AT	Front	Terrain cab wagon closed 4WD ESF	Date From:2007.01	Propshaft	202102
	2006.01-2010.12	AT	Front	Terrain cab wagon closed 4WD ESF	Date To:2006.12	Propshaft	202280
	2006.01-2010.12		-	Terrain cab wagon closed 4WD ESF		Joint,propshaft	899297
6.4 (344 kw)	2011.03-	AT	Front	SUV 4WD ESG	Trans. code:2 Speed On Demand	Propshaft	202100
	2011.03-	AT	Front	SUV 4WD ESG	Trans. code:Single Speed	Propshaft	PS900219
Patriot							
2.0 (103 kw)	2007.02-2017.12	MT	Rear	Terrain cab wagon closed 4WD ECD/IECE		Propshaft	PS900303
2.2 (120 kw)	2011.01-2017.12	MT	Rear	Terrain cab wagon closed 4WD ENE		Propshaft	PS900303
2.4 (125 kw)	2007.01-2017.12	MT	Rear	Terrain cab wagon closed 4WD ED37/EDG		Propshaft	PS900303
	2008.07-2017.12	MT	Rear	Terrain cab wagon closed 4WD ED3		Propshaft	PS900303
Wrangler							
3.6 (209 kw)	2011.10-		Rear	Terrain cab open 4WD ERB		Joint,propshaft	816011
3.8 (146 kw)	2007.10-		Front;Rear	Terrain cab open 4WD EGT		Joint,propshaft	816011
3.8 (151 kw)	2006.06-		Rear	Terrain cab open 4WD EGT		Joint,propshaft	816011
KIA							
Sorento							
2.0 (110 kw)	2009.07-2015.12		Centre	SUV 4WD D4HA		Center Bearing Support Kit	514811S
	2009.07-2015.12		Front;Rear	SUV 4WD D4HA		Flexible Coupling	533419
2.0 (135 kw)	2009.11-2015.12		Front;Rear	SUV 4WD D4HA		Flexible Coupling	533419
2.2 (145 kw)	2009.11-2015.12		Centre	SUV 4WD D4HB		Center Bearing Support	514811
	2009.11-2015.12		Centre	SUV 4WD D4HB		Center Bearing Support Kit	514811S
	2009.11-2015.12		Front;Rear	SUV 4WD D4HB		Flexible Coupling	533419
	2009.11-2015.12		Front;Rear	SUV Van 4WD D4HB		Flexible Coupling	533419
2.2 (147 kw)	2009.11-2015.12	6AT/6MT	Rear	SUV 4WD D4HB		Propshaft	PS900308
	2009.11-2015.12		Front;Rear	SUV 4WD D4HB		Flexible Coupling	533419
2.4 (102 kw)	2002.07-2009.06	MT	Front	SUV 4WD G4JS		Propshaft	PS900605
	2002.07-2009.06		Centre	SUV 4WD G4JS		Center Bearing Support Kit	514811S
2.4 (126 kw)	2010.04-2015.12		Front;Rear	SUV 4WD G4KE		Flexible Coupling	533419
2.4 (128 kw)	2009.06-2015.12		Centre	SUV 4WD G4KE		Center Bearing Support	514811
	2009.06-2015.12		Centre	SUV 4WD G4KE		Center Bearing Support Kit	514811S
	2009.06-2015.12		Front;Rear	SUV 4WD G4KE		Flexible Coupling	533419
	2009.06-2015.12		Front;Rear	SUV Van 4WD G4KE		Flexible Coupling	533419
2.4 (130 kw)	2011.01-2015.12		Front;Rear	SUV 4WD G4KE		Flexible Coupling	533419
2.4 (141 kw)	2012.10-2015.12	6AT/6MT	Rear	SUV 4WD G4KJ		Propshaft	PS900308
	2012.10-2015.12		Centre	SUV 4WD G4KJ		Center Bearing Support	514811
	2012.10-2015.12		Centre	SUV 4WD G4KJ		Center Bearing Support Kit	514811S
	2012.10-2015.12		Front;Rear	SUV 4WD G4KJ		Flexible Coupling	533419
2.5 (103 kw)	2002.08-2011.03	AT/MT	Front	SUV 4WD D4CB	Date To:2006.09;With Auto Transfer(Electronic)	Propshaft	PS900310
	2002.08-2011.03	AT/MT	Front	SUV 4WD D4CB	Date To:2006.09	Propshaft	PS900561
	2002.08-2011.03	AT/MT	Rear	SUV 4WD D4CB		Propshaft	PS900598
2.5 (120 kw)	2006.09-2011.12	AT	Front	SUV 4WD D4CB		Propshaft	PS900309
	2006.09-2011.12	MT	Front	SUV 4WD D4CB		Propshaft	PS900599
	2006.09-2011.12	AT	Rear	SUV 4WD D4CB		Propshaft	PS900601
	2006.09-2011.12	MT	Rear	SUV 4WD D4CB		Propshaft	PS900600
2.5 (125 kw)	2006.09-2011.12	AT	Front	SUV 4WD D4CB		Propshaft	PS900309
	2006.09-2011.12	MT	Front	SUV 4WD D4CB		Propshaft	PS900599
	2006.09-2011.12	AT	Rear	SUV 4WD D4CB		Propshaft	PS900601
	2006.09-2011.12	MT	Rear	SUV 4WD D4CB		Propshaft	PS900600
3.3 (182 kw)	2006.09-2011.12	AT	Front	SUV 4WD G6DB		Propshaft	PS900604
	2006.09-2011.12	AT	Rear	SUV 4WD G6DB		Propshaft	PS900603
3.5 (143 kw)	2002.07-2011.12	AT	Front	SUV 4WD G6CU		Propshaft	PS900605
	2002.07-2011.12		Centre	SUV 4WD G6CU		Center Bearing Support	514811
	2002.07-2011.12		Centre	SUV 4WD G6CU		Center Bearing Support Kit	514811S
3.5 (203 kw)	2009.11-2015.12		Rear	SUV 4WD G6DC		Propshaft	PS900265
	2009.11-2015.12		Front;Rear	SUV 4WD G6DC		Flexible Coupling	533419
3.5 (206 kw)	2011.01-2015.12		Front;Rear	SUV 4WD G6DC		Flexible Coupling	533419
Sportage							
1.6 (130 kw)	2015.09-		Front;Rear	SUV 4WD G4FJ		Flexible Coupling	533419
2.0 (83 kw)	2004.07-2010.05		Centre	SUV 4WD D4EA		Center Bearing Support	514793
	2004.07-2010.05		Centre	SUV FWD D4EA		Center Bearing Support	514793



	 YEAR	TRANSM.	FITTING POSITION	BODY STYLE & DRIVE TYPE & ENGINE	REMARKS	 PRODUCT	GSP Ref.
KIA Sportage							
2.0 (83 kw)	2004.07-2010.05		Centre	SUV 4WD D4EA		Center Bearing Support	514811
	2004.07-2010.05		Centre	SUV 4WD D4EA		Center Bearing Support Kit	514811S
	2004.07-2010.05		Rear	SUV 4WD D4EA		Flexible Coupling	519580
2.0 (95 kw)	1998.11-2004.08		Centre	SUV 4WD FE		Center Bearing Support	514793
2.0 (100 kw)	2006.01-2010.05		Centre	SUV FWD D4EA		Center Bearing Support	514793
	2006.01-2010.05		Centre	SUV 4WD D4EA		Center Bearing Support	514793
	2006.01-2010.05		Centre	SUV 4WD D4EA		Center Bearing Support	514811
	2006.01-2010.05		Centre	SUV 4WD D4EA		Center Bearing Support Kit	514811S
	2006.01-2010.05		Rear	SUV 4WD D4EA		Flexible Coupling	519580
	2010.06-2015.12	AT/MT	Rear	SUV 4WD D4HA		Propshaft	PS900272
	2010.06-2015.12		Centre	SUV 4WD D4HA		Center Bearing Support	514811
	2010.06-2015.12		Centre	SUV 4WD D4HA		Center Bearing Support Kit	514811S
	2010.06-2015.12		Front;Rear	SUV 4WD D4HA		Flexible Coupling	533419
	2015.09-		Front;Rear	SUV 4WD D4HA		Flexible Coupling	533419
2.0 (103 kw)	2006.02-2010.05		Centre	SUV 4WD D4EA		Center Bearing Support	514793
	2006.02-2010.05		Centre	SUV FWD D4EA		Center Bearing Support	514793
	2006.02-2010.05		Centre	SUV 4WD D4EA		Center Bearing Support	514811
	2006.02-2010.05		Centre	SUV 4WD D4EA		Center Bearing Support Kit	514811S
	2006.02-2010.05		Rear	SUV 4WD D4EA		Flexible Coupling	519580
2.0 (104 kw)	2004.07-		Centre	SUV FWD G4GC		Center Bearing Support	514793
	2004.07-		Centre	SUV FWD G4GC		Center Bearing Support Kit	514793S
	2004.07-2010.05	AT/MT	Rear	SUV 4WD G4GC		Propshaft	PS900273
	2004.07-2010.05		Centre	SUV 4WD G4GC		Center Bearing Support	514793
	2004.07-2010.05		Centre	SUV 4WD G4GC		Center Bearing Support	514811
	2004.07-2010.05		Centre	SUV 4WD G4GC		Center Bearing Support Kit	514793S
	2004.07-2010.05		Centre	SUV 4WD G4GC		Center Bearing Support Kit	514811S
	2004.07-2010.05		Rear	SUV 4WD G4GC		Flexible Coupling	519580
2.0 (110 kw)	2008.09-2010.05		Centre	SUV 4WD D4EA		Center Bearing Support	514793
	2008.09-2010.05		Centre	SUV 4WD D4EA		Center Bearing Support Kit	514811S
	2008.09-2010.05		Rear	SUV 4WD D4EA		Flexible Coupling	519580
	2010.06-2013.12	AT/MT	Rear	SUV 4WD G4KD	Date From:2011.01	Propshaft	PS900272
	2010.06-2013.12		Front;Rear	SUV 4WD G4KD		Flexible Coupling	533419
	2014.01-2015.12		Front;Rear	SUV 4WD G4NA		Flexible Coupling	533419
	2015.12-		Front;Rear	SUV 4WD G4NA		Flexible Coupling	533419
2.0 (113 kw)	2014.11-2015.12		Front;Rear	SUV 4WD G4NA		Flexible Coupling	533419
2.0 (114 kw)	2015.12-		Front;Rear	SUV 4WD G4NA		Flexible Coupling	533419
2.0 (120 kw)	2010.06-2015.12	AT/MT	Rear	SUV 4WD G4KD	Date From:2011.01	Propshaft	PS900272
	2010.06-2015.12		Centre	SUV 4WD G4KD		Center Bearing Support	514811
	2010.06-2015.12		Centre	SUV 4WD G4KD		Center Bearing Support Kit	514811S
	2010.06-2015.12		Front;Rear	SUV 4WD G4KD		Flexible Coupling	533419
2.0 (122 kw)	2010.07-2015.12	AT/MT	Rear	SUV 4WD G4KD	Date From:2011.01	Propshaft	PS900272
	2010.07-2015.12		Centre	SUV 4WD G4KD		Center Bearing Support	514811
	2010.07-2015.12		Centre	SUV 4WD G4KD		Center Bearing Support Kit	514811S
	2010.07-2015.12		Front;Rear	SUV 4WD G4KD		Flexible Coupling	533419
	2014.02-2015.12		Front;Rear	SUV 4WD G4NC		Flexible Coupling	533419
2.0 (129 kw)	2016.01-		Front;Rear	SUV 4WD D4HA		Flexible Coupling	533419
2.0 (130 kw)	2012.08-2015.12		Front;Rear	SUV 4WD D4HA		Flexible Coupling	533419
2.0 (131 kw)	2012.01-2015.12		Front;Rear	SUV 4WD G4KD		Flexible Coupling	533419
	2015.09-		Front;Rear	SUV 4WD D4HA		Flexible Coupling	533419
2.0 (134 kw)	2016.01-		Front;Rear	SUV 4WD D4HA		Flexible Coupling	533419
2.0 (135 kw)	2010.08-2015.12	AT/MT	Rear	SUV 4WD D4HA	Date To:2016.12	Propshaft	PS900272
	2010.08-2015.12		Centre	SUV 4WD D4HA		Center Bearing Support	514811
	2010.08-2015.12		Centre	SUV 4WD D4HA		Center Bearing Support Kit	514811S
	2010.08-2015.12		Front;Rear	SUV 4WD D4HA		Flexible Coupling	533419
2.0 (136 kw)	2015.09-		Front;Rear	SUV 4WD D4HA		Flexible Coupling	533419
2.4 (130 kw)	2010.06-2015.12	AT/MT	Rear	SUV 4WD G4KE	Date From:2011.01	Propshaft	PS900272
	2010.06-2015.12		Front;Rear	SUV 4WD G4KE		Flexible Coupling	533419
2.4 (135 kw)	2015.10-		Front;Rear	SUV 4WD G4KJ		Flexible Coupling	533419
2.7 (129 kw)	2004.07-2010.05	AT/MT	Rear	SUV 4WD G6BA		Propshaft	PS900273
	2004.07-2010.05		Centre	SUV 4WD G6BA		Center Bearing Support	514793
	2004.07-2010.05		Centre	SUV 4WD G6BA		Center Bearing Support Kit	514793S
Sportage R							
2.0 (135 kw)	2010.08-2015.12	AT/MT	Rear	SUV 4WD D4HA	Date To:2016.12	Propshaft	PS900272
	2010.08-2015.12		Centre	SUV 4WD D4HA		Center Bearing Support	514811



	 YEAR	TRANSM.	FITTING POSITION	BODY STYLE & DRIVE TYPE & ENGINE	REMARKS	 PRODUCT	GSP Ref.
KIA Sportage R							
2.0 (135 kw)	2010.08-2015.12		Centre	SUV 4WD D4HA		Center Bearing Support Kit	514811S
	2010.08-2015.12		Front;Rear	SUV 4WD D4HA		Flexible Coupling	533419
KIA (DYK) Sportage							
2.0 (104 kw)	2007.11-2015.06		Centre	SUV 4WD G4GC		Center Bearing Support	514793
2.7 (127 kw)	2007.11-2010.09		Centre	SUV 4WD G6BA		Center Bearing Support	514793
LANCIA Y10 (Ypsilon)							
1.0 (33 kw)	1985.03-1992.02		Front;Rear	Hatchback FWD 156A2000/156A2246		Center Bearing Support	518107
1.1 (37 kw)	1989.07-1995.09		Front;Rear	Hatchback FWD 156C046		Center Bearing Support	518107
	1992.09-1995.12		Front;Rear	Hatchback 4WD 156C046		Center Bearing Support	518107
1.1 (40 kw)	1995.01-1995.12		Front;Rear	Hatchback 4WD 176B2000		Center Bearing Support	518107
	1995.01-1995.12		Front;Rear	Hatchback FWD 176B2000		Center Bearing Support	518107
1.1 (42 kw)	1989.07-1992.09		Front;Rear	Hatchback 4WD 156C000		Center Bearing Support	518107
	1989.07-1992.09		Front;Rear	Hatchback FWD 156C000		Center Bearing Support	518107
1.3 (53 kw)	1989.02-1995.12		Front;Rear	Hatchback FWD 146A5046/156B000		Center Bearing Support	518107
LAND ROVER Defender							
2.5 (85 kw)	1998.08-2005.12		Rear	Closed Off-Road Vehicle AWD 11 L/23 L	Chassis no. from:KA625787/Chassis no. to:1462294 for 110 inch wheelbase	Propshaft	PS900316
Defender 110							
2.0 (147 kw)	2019.09-	AT	Front	Terrain cab wagon closed 4WD 204DT	Date From:2020.01	Propshaft	PS900530
	2019.09-	AT	Front	Terrain cab wagon closed 4WD 204DT	Date From:2020.01	Joint,propshaft	601910
	2020.02-	AT	Front	Terrain cab wagon closed Van 4WD 204DT		Propshaft	PS900530
	2020.02-	AT	Front	Terrain cab wagon closed Van 4WD 204DT		Joint,propshaft	601910
2.0 (177 kw)	2019.09-	AT	Front	Terrain cab wagon closed 4WD 204DT	Date From:2020.01	Propshaft	PS900530
	2019.09-	AT	Front	Terrain cab wagon closed 4WD 204DT	Date From:2020.01	Joint,propshaft	601910
	2020.02-	AT	Front	Terrain cab wagon closed Van 4WD 204DT		Propshaft	PS900530
	2020.02-	AT	Front	Terrain cab wagon closed Van 4WD 204DT		Joint,propshaft	601910
2.0 (221 kw)	2019.09-	AT	Front	Terrain cab wagon closed 4WD PT204	Date From:2020.01	Propshaft	PS900530
	2019.09-	AT	Front	Terrain cab wagon closed 4WD PT204	Date From:2020.01	Joint,propshaft	601910
	2020.02-	AT	Front	Terrain cab wagon closed Van 4WD PT204		Propshaft	PS900530
	2020.02-	AT	Front	Terrain cab wagon closed Van 4WD PT204		Joint,propshaft	601910
2.5 (51 kw)	1990.09-1994.07		Rear	Terrain cab open 4WD 12J	Chassis no. from:KA625787/Chassis no. to:1462294 for 110 inch wheelbase	Propshaft	PS900316
	1990.09-1994.07		Rear	Terrain cab wagon closed 4WD 12J	Chassis no. from:KA625787/Chassis no. to:1462294 for 110 inch wheelbase	Propshaft	PS900316
2.5 (61 kw)	1990.09-1994.12		Rear	Terrain cab wagon closed 4WD 17J	Chassis no. from:KA625787/Chassis no. to:1462294 for 110 inch wheelbase	Propshaft	PS900316
2.5 (83 kw)	1990.09-1998.11	MT	Front	Terrain cab open 4WD 11L/16L	Chassis no. to:LA939975	Propshaft	PS900313
	1990.09-1998.11	MT	Front	Terrain cab open 4WD 11L/16L	Chassis no. from:MA939976	Propshaft	PS900326
	1990.09-1998.12	MT	Front	Terrain cab wagon closed 4WD 11L/16L/23L	Chassis no. to:LA939975	Propshaft	PS900313
	1990.09-1998.12	MT	Front	Terrain cab wagon closed 4WD 11L/16L/23L	For Engine Code:16L,Wheel base:2286 mm	Propshaft	PS900315
	1990.09-1998.12	MT	Front	Terrain cab wagon closed 4WD 11L/16L/23L	Wheel base:2794 mm,For Engine Code:11L	Propshaft	PS900318
	1990.09-1998.12	MT	Front	Terrain cab wagon closed 4WD 11L/16L/23L	Chassis no. from:MA939976	Propshaft	PS900326
2.5 (90 kw)	1998.06-2006.09	MT	Front	Terrain cab open 4WD 10P/14P	Chassis no. to:LA939975	Propshaft	PS900313
	1998.06-2006.09	MT	Front	Terrain cab open 4WD 10P/14P	Date To:2007.12,Wheel base:2286 mm	Propshaft	PS900315
	1998.06-2006.09	MT	Front	Terrain cab open 4WD 10P/14P	Date To:2007.12,Chassis no. from:MA939976	Propshaft	PS900326
	1998.06-2006.09		Rear	Terrain cab open 4WD 10P/14P	Chassis no. from:KA625787/Chassis no. to:1462294 for 110 inch wheelbase	Propshaft	PS900316
	1998.06-2012.12	MT	Front	Terrain cab wagon closed 4WD 10P/14P/15P	Chassis no. to:LA939975	Propshaft	PS900313
	1998.06-2012.12	MT	Front	Terrain cab wagon closed 4WD 10P/14P/15P	Date To:2007.12,Wheel base:2286 mm	Propshaft	PS900315
	1998.06-2012.12	MT	Front	Terrain cab wagon closed 4WD 10P/14P/15P	Date To:2007.12,Chassis no. from:MA939976	Propshaft	PS900326
	1998.06-2012.12		Rear	Terrain cab wagon closed 4WD 10P/14P/15P	Chassis no. from:KA625787/Chassis no. to:1462294 for 110 inch wheelbase	Propshaft	PS900316
3.5 (86 kw)	1990.09-1993.08	MT	Front	Terrain cab open 4WD 21G	Chassis no. from:CA254407	Propshaft	PS900326
	1990.09-1994.12	MT	Front	Terrain cab wagon closed 4WD 21G	Wheel base:2286 mm,Chassis no. to:CA254407	Propshaft	PS900315
	1990.09-1994.12	MT	Front	Terrain cab wagon closed 4WD 21G	Wheel base:2794 mm,Chassis no. to:LA937639	Propshaft	PS900318
	1990.09-1994.12	MT	Front	Terrain cab wagon closed 4WD 21G	Chassis no. from:CA254407	Propshaft	PS900326
Defender 130							
2.5 (83 kw)	1990.09-1998.11	MT	Front	Terrain cab open 4WD 11L/16L	Chassis no. to:LA939975	Propshaft	PS900313
	1990.09-1998.11	MT	Front	Terrain cab open 4WD 11L/16L	Chassis no. from:MA939976	Propshaft	PS900326
	1995.01-1998.03	MT	Front	Terrain cab wagon closed 4WD 16L	Chassis no. to:LA939975	Propshaft	PS900313
	1995.01-1998.03	MT	Front	Terrain cab wagon closed 4WD 16L	For Engine Code:16L,Wheel base:2286 mm	Propshaft	PS900315
	1995.01-1998.03	MT	Front	Terrain cab wagon closed 4WD 16L	Chassis no. from:MA939976	Propshaft	PS900326
2.5 (90 kw)	1998.04-2006.09	MT	Front	Terrain cab open 4WD 10P/14P	Chassis no. to:LA939975	Propshaft	PS900313
	1998.04-2006.09	MT	Front	Terrain cab open 4WD 10P/14P	Date To:2007.12,Wheel base:2286 mm	Propshaft	PS900315
	1998.04-2006.09	MT	Front	Terrain cab open 4WD 10P/14P	Date To:2007.12,Chassis no. from:MA939976	Propshaft	PS900326
	1998.04-2006.09		Rear	Terrain cab open 4WD 10P/14P	Chassis no. from:KA625787/Chassis no. to:1462294 for 110 inch wheelbase	Propshaft	PS900316
	1998.06-2007.07	MT	Front	Terrain cab wagon closed 4WD 10P/14P/15P	Chassis no. to:LA939975	Propshaft	PS900313



	 YEAR	TRANSM.	FITTING POSITION	BODY STYLE & DRIVE TYPE & ENGINE	REMARKS	 PRODUCT	GSP Ref.
LAND ROVER							
Defender 130							
2.5 (90 kw)	1998.06-2007.07	MT	Front	Terrain cab wagon closed 4WD 10P/14P/15P	Date To:2007.12,Wheel base:2286 mm	Propshaft	PS900315
	1998.06-2007.07	MT	Front	Terrain cab wagon closed 4WD 10P/14P/15P	Date To:2007.12,Chassis no. from:MA939976	Propshaft	PS900326
	1998.06-2007.07		Rear	Terrain cab wagon closed 4WD 10P/14P/15P	Chassis no. from:KA625787,Chassis no. to:1A62284,for 110 inch wheelbase	Propshaft	PS900316
3.5 (86 kw)	1990.09-1993.08	MT	Front	Terrain cab open 4WD 21G	Chassis no. from:CA254407	Propshaft	PS900326
Defender 90							
2.0 (147 kw)	2019.09-	AT	Front	Terrain cab wagon closed 4WD 204DT	Date From:2020.01	Propshaft	PS900530
	2019.09-	AT	Front	Terrain cab wagon closed 4WD 204DT	Date From:2020.01	Joint,propshaft	601910
	2020.02-	AT	Front	Terrain cab wagon closed Van 4WD 204DT		Propshaft	PS900530
	2020.02-	AT	Front	Terrain cab wagon closed Van 4WD 204DT		Joint,propshaft	601910
2.0 (177 kw)	2019.09-	AT	Front	Terrain cab wagon closed 4WD 204DT	Date From:2020.01	Propshaft	PS900530
	2019.09-	AT	Front	Terrain cab wagon closed 4WD 204DT	Date From:2020.01	Joint,propshaft	601910
	2020.02-	AT	Front	Terrain cab wagon closed Van 4WD 204DT		Propshaft	PS900530
	2020.02-	AT	Front	Terrain cab wagon closed Van 4WD 204DT		Joint,propshaft	601910
2.0 (221 kw)	2019.09-	AT	Front	Terrain cab wagon closed 4WD PT204	Date From:2020.01	Propshaft	PS900530
	2019.09-	AT	Front	Terrain cab wagon closed 4WD PT204	Date From:2020.01	Joint,propshaft	601910
	2020.02-	AT	Front	Terrain cab wagon closed Van 4WD PT204		Propshaft	PS900530
	2020.02-	AT	Front	Terrain cab wagon closed Van 4WD PT204		Joint,propshaft	601910
2.5 (51 kw)	1990.09-1994.07		Rear	Terrain cab wagon closed 4WD 12J	Chassis no. from:KA625787,Chassis no. to:1A62284,for 110 inch wheelbase	Propshaft	PS900316
2.5 (61 kw)	1990.09-1994.12		Rear	Terrain cab wagon closed 4WD 17J	Chassis no. from:KA625787,Chassis no. to:1A62284,for 110 inch wheelbase	Propshaft	PS900316
2.5 (83 kw)	1990.08-1998.11	MT	Front	Terrain cab open 4WD 16L/23L	Chassis no. to:LA939975	Propshaft	PS900313
	1990.08-1998.11	MT	Front	Terrain cab open 4WD 16L/23L	Chassis no. from:MA939976	Propshaft	PS900326
	1990.09-1998.12	MT	Front	Terrain cab wagon closed 4WD 11L/16L/23L	Chassis no. to:LA939975	Propshaft	PS900313
	1990.09-1998.12	MT	Front	Terrain cab wagon closed 4WD 11L/16L/23L	For Engine Code:16L,Wheel base:2286 mm	Propshaft	PS900315
	1990.09-1998.12	MT	Front	Terrain cab wagon closed 4WD 11L/16L/23L	Wheel base:2794 mm,For Engine Code:11L	Propshaft	PS900318
	1990.09-1998.12	MT	Front	Terrain cab wagon closed 4WD 11L/16L/23L	Chassis no. from:MA939976	Propshaft	PS900326
2.5 (90 kw)	1998.06-2007.07	MT	Front	Terrain cab open 4WD 10P/14P/15P	Chassis no. to:LA939975	Propshaft	PS900313
	1998.06-2007.07	MT	Front	Terrain cab wagon closed 4WD 10P/14P/15P	Chassis no. to:LA939975	Propshaft	PS900313
	1998.06-2007.07	MT	Front	Terrain cab open 4WD 10P/14P/15P	Date To:2007.12,Wheel base:2286 mm	Propshaft	PS900315
	1998.06-2007.07	MT	Front	Terrain cab wagon closed 4WD 10P/14P/15P	Date To:2007.12,Wheel base:2286 mm	Propshaft	PS900315
	1998.06-2007.07	MT	Front	Terrain cab open 4WD 10P/14P/15P	Date To:2007.12,Chassis no. from:MA939976	Propshaft	PS900326
	1998.06-2007.07	MT	Front	Terrain cab wagon closed 4WD 10P/14P/15P	Date To:2007.12,Chassis no. from:MA939976	Propshaft	PS900326
	1998.06-2007.07		Rear	Terrain cab open 4WD 10P/14P/15P	Chassis no. from:KA625787,Chassis no. to:1A62284,for 110 inch wheelbase	Propshaft	PS900316
	1998.06-2007.07		Rear	Terrain cab wagon closed 4WD 10P/14P/15P	Chassis no. from:KA625787,Chassis no. to:1A62284,for 110 inch wheelbase	Propshaft	PS900316
3.5 (86 kw)	1990.09-1993.08	MT	Front	Terrain cab wagon closed 4WD 21G	Wheel base:2286 mm,Chassis no. to:CA254407	Propshaft	PS900315
	1990.09-1993.08	MT	Front	Terrain cab wagon closed 4WD 21G	Wheel base:2794 mm,Chassis no. to:LA937839	Propshaft	PS900318
	1990.09-1993.08	MT	Front	Terrain cab wagon closed 4WD 21G	Chassis no. from:CA254407	Propshaft	PS900326
Discovery							
2.0 (99 kw)	1989.06-1998.10	MT	Front	Terrain cab wagon closed 4WD 20T4HG		Propshaft	PS900326
	1989.06-1998.10		Rear	Terrain cab wagon closed 4WD 20T4HG		Propshaft	PS900327
2.0 (132 kw)	2016.09-2018.12	AT	Front	SUV 4WD 204DTD	Date From:2017.01	Propshaft	PS900530
	2016.09-2018.12	AT	Front	SUV 4WD 204DTD	Date From:2017.01	Joint,propshaft	601910
2.0 (177 kw)	2016.09-	AT	Front	SUV 4WD 204DTA	Date From:2017.01	Propshaft	PS900530
	2016.09-	AT	Front	SUV 4WD 204DTA	Date From:2017.01	Joint,propshaft	601910
2.0 (221 kw)	2017.09-	AT	Front	SUV 4WD PT204	Date From:2018.01	Propshaft	PS900530
	2017.09-	AT	Front	SUV 4WD PT204	Date From:2018.01	Joint,propshaft	601910
2.5 (83 kw)	1989.10-1998.12	MT	Front	Terrain cab wagon closed 4WD 12L/17L/21L		Propshaft	PS900326
	1989.10-1998.12		Rear	Terrain cab wagon closed 4WD 12L/17L/21L		Propshaft	PS900327
2.5 (90 kw)	1994.07-1998.10	MT	Front	Terrain cab wagon closed 4WD 19L/21L/22L		Propshaft	PS900326
	1994.07-1998.10		Rear	Terrain cab wagon closed 4WD 19L/21L/22L		Propshaft	PS900327
2.5 (100 kw)	1998.11-2004.06	AT/MT	Front	Terrain cab wagon closed 4WD 15P	Date From:1999.01	Propshaft	PS900321
2.5 (102 kw)	1998.11-2004.06	AT/MT	Front	Terrain cab wagon closed 4WD 10P/15P		Propshaft	PS900321
2.7 (140 kw)	2004.07-2009.08	AT/MT	Front	Terrain cab wagon closed 4WD 276DT		Propshaft	PS900324
	2004.07-2009.08	AT/MT	Rear	Terrain cab wagon closed 4WD 276DT		Propshaft	PS900325
	2004.07-2009.08	AT/MT	Front	Terrain cab wagon closed 4WD 276DT		Joint,propshaft	601910
	2004.07-2009.08	AT/MT	Rear	Terrain cab wagon closed 4WD 276DT		Joint,propshaft	699217
	2004.07-2009.08		Centre	Terrain cab wagon closed 4WD 276DT		Center Bearing Support	514799
	2007.01-2009.07		Centre	VAN 4WD 276DT		Center Bearing Support	514799
	2009.09-2018.12	AT/MT	Front	Terrain cab wagon closed 4WD 276DT		Propshaft	PS900324
	2009.09-2018.12	AT/MT	Rear	Terrain cab wagon closed 4WD 276DT		Propshaft	PS900325
	2009.09-2018.12	AT/MT	Front	Terrain cab wagon closed 4WD 276DT		Joint,propshaft	601910
	2009.09-2018.12	AT/MT	Rear	Terrain cab wagon closed 4WD 276DT		Joint,propshaft	699217
	2009.09-2018.12		Centre	Terrain cab wagon closed 4WD 276DT		Center Bearing Support	514799
3.0 (155 kw)	2009.09-2018.12	AT/MT	Front	Terrain cab wagon closed 4WD 306DT		Propshaft	PS900324
	2009.09-2018.12	AT/MT	Front	Terrain cab wagon closed 4WD 306DT		Joint,propshaft	601910



	 YEAR	TRANSM.	FITTING POSITION	BODY STYLE & DRIVE TYPE & ENGINE	REMARKS	 PRODUCT	GSP Ref.
LAND ROVER Discovery							
3.0 (155 kw)	2009.09-2018.12		Centre	Terrain cab wagon closed 4WD 306DT		Center Bearing Support	514799
	2011.01-2017.12		Centre	VAN 4WD 306DT		Center Bearing Support	514799
	2016.09-	AT	Front	SUV 4WD 306DT	Date From:2017.01	Propshaft	PS900530
	2016.09-	AT	Front	SUV 4WD 306DT	Date From:2017.01	Joint,propshaft	601910
3.0 (180 kw)	2009.09-2018.12	AT/MT	Front	Terrain cab wagon closed 4WD 306DT		Propshaft	PS900324
	2009.09-2018.12	AT/MT	Rear	Terrain cab wagon closed 4WD 306DT		Propshaft	PS900325
	2009.09-2018.12	AT/MT	Front	Terrain cab wagon closed 4WD 306DT		Joint,propshaft	601910
	2009.09-2018.12	AT/MT	Rear	Terrain cab wagon closed 4WD 306DT		Joint,propshaft	699217
	2009.09-2018.12		Centre	Terrain cab wagon closed 4WD 306DT		Center Bearing Support	514799
	2011.01-2011.12		Centre	VAN 4WD 306DT		Center Bearing Support	514799
3.0 (183 kw)	2013.01-2018.12	AT/MT	Front	Terrain cab wagon closed 4WD 306DT		Propshaft	PS900324
	2013.01-2018.12	AT/MT	Rear	Terrain cab wagon closed 4WD 306DT		Propshaft	PS900325
	2013.01-2018.12	AT/MT	Front	Terrain cab wagon closed 4WD 306DT		Joint,propshaft	601910
	2013.01-2018.12	AT/MT	Rear	Terrain cab wagon closed 4WD 306DT		Joint,propshaft	699217
	2013.01-2018.12		Centre	Terrain cab wagon closed 4WD 306DT		Center Bearing Support	514799
	2016.09-	AT	Front	SUV 4WD 306DT	Date From:2017.01	Propshaft	PS900530
3.0 (188 kw)	2016.09-	AT	Front	SUV 4WD 306DT	Date From:2017.01	Joint,propshaft	601910
	2009.09-2018.12	AT/MT	Front	Terrain cab wagon closed 4WD 306DT		Propshaft	PS900324
	2009.09-2018.12	AT/MT	Rear	Terrain cab wagon closed 4WD 306DT		Propshaft	PS900325
	2009.09-2018.12	AT/MT	Front	Terrain cab wagon closed 4WD 306DT		Joint,propshaft	601910
	2009.09-2018.12	AT/MT	Rear	Terrain cab wagon closed 4WD 306DT		Joint,propshaft	699217
	2009.09-2018.12		Centre	Terrain cab wagon closed 4WD 306DT		Center Bearing Support	514799
3.0 (190 kw)	2011.07-2017.12		Centre	VAN 4WD 306DT		Center Bearing Support	514799
	2016.09-	AT	Front	SUV 4WD 306DT	Date From:2017.01	Propshaft	PS900530
3.0 (200 kw)	2016.09-	AT	Front	SUV 4WD 306DT	Date From:2017.01	Joint,propshaft	601910
	2009.09-2018.12	AT/MT	Front	Terrain cab wagon closed 4WD 306DT		Propshaft	PS900324
3.0 (225 kw)	2009.09-2018.12	AT/MT	Rear	Terrain cab wagon closed 4WD 306DT		Propshaft	PS900325
	2009.09-2018.12	AT/MT	Front	Terrain cab wagon closed 4WD 306DT		Joint,propshaft	601910
	2009.09-2018.12	AT/MT	Rear	Terrain cab wagon closed 4WD 306DT		Joint,propshaft	699217
	2009.09-2018.12	AT/MT	Centre	Terrain cab wagon closed 4WD 306DT		Center Bearing Support	514799
	2009.09-2018.12		Centre	Terrain cab wagon closed 4WD 306DT		Center Bearing Support	514799
3.0 (250 kw)	2018.09-	AT	Front	SUV 4WD 306DT	Date From:2019.01	Propshaft	PS900530
	2018.09-	AT	Front	SUV 4WD 306DT	Date From:2019.01	Joint,propshaft	601910
3.5 (113 kw)	2013.08-2018.12		Centre	Terrain cab wagon closed 4WD 306PS		Center Bearing Support	514799
	2016.09-	AT	Front	SUV 4WD 306PS	Date From:2017.01	Propshaft	PS900530
	2016.09-	AT	Front	SUV 4WD 306PS	Date From:2017.01	Joint,propshaft	601910
3.5 (122 kw)	1989.10-1994.06	MT	Front	Terrain cab wagon closed 4WD 22D	Date From:1990.01	Propshaft	PS900326
	1989.10-1994.06		Rear	Terrain cab wagon closed 4WD 22D		Propshaft	PS900327
4.0 (134 kw)	1989.10-1994.06		Rear	Terrain cab wagon closed 4WD 22D		Propshaft	PS900327
	1993.08-1998.10	MT	Front	Terrain cab wagon closed 4WD 35D/35L	for vehicles without catalytic convertor	Propshaft	PS900326
4.0 (136 kw)	1993.08-1998.10		Rear	Terrain cab wagon closed 4WD 35D/35L		Propshaft	PS900327
	1998.11-2004.06		Rear	Terrain cab wagon closed 4WD 56D	Chassis no. from:3A000000	Propshaft	PS900319
4.0 (160 kw)	1998.11-2004.06		Rear	Terrain cab wagon closed 4WD 56D	Chassis no. from:1A292873	Propshaft	PS900320
	2004.10-2009.09		Centre	Terrain cab wagon closed 4WD 406PN		Center Bearing Support	514799
4.0 (161 kw)	2010.01-2018.12	AT/MT	Front	Terrain cab wagon closed 4WD 406PN		Propshaft	PS900324
	2010.01-2018.12	AT/MT	Rear	Terrain cab wagon closed 4WD 406PN		Propshaft	PS900325
	2010.01-2018.12	AT/MT	Front	Terrain cab wagon closed 4WD 406PN		Joint,propshaft	601910
	2010.01-2018.12	AT/MT	Rear	Terrain cab wagon closed 4WD 406PN		Joint,propshaft	699217
	2010.01-2018.12		Centre	Terrain cab wagon closed 4WD 406PN		Center Bearing Support	514799
	2005.02-2009.09	AT/MT	Front	Terrain cab wagon closed 4WD 40VSER	Date From:2009.01	Propshaft	PS900324
4.4 (220 kw)	2005.02-2009.09	AT/MT	Rear	Terrain cab wagon closed 4WD 40VSER	Date From:2009.01	Propshaft	PS900325
	2005.02-2009.09	AT/MT	Front	Terrain cab wagon closed 4WD 40VSER	Date From:2009.01	Joint,propshaft	601910
	2005.02-2009.09	AT/MT	Rear	Terrain cab wagon closed 4WD 40VSER	Date From:2009.01	Joint,propshaft	699217
	2005.02-2009.09		Centre	Terrain cab wagon closed 4WD 40VSER		Center Bearing Support	514799
	2005.02-2009.09		Centre	Terrain cab wagon closed 4WD 40VSER		Center Bearing Support	514799
5.0 (276 kw)	2004.07-2009.08	AT/MT	Front	Terrain cab wagon closed 4WD 448PN		Propshaft	PS900324
	2004.07-2009.08	AT/MT	Rear	Terrain cab wagon closed 4WD 448PN		Propshaft	PS900325
	2004.07-2009.08	AT/MT	Front	Terrain cab wagon closed 4WD 448PN		Joint,propshaft	601910
	2004.07-2009.08	AT/MT	Rear	Terrain cab wagon closed 4WD 448PN		Joint,propshaft	699217
	2004.07-2009.08		Centre	Terrain cab wagon closed 4WD 448PN		Center Bearing Support	514799
5.0 (276 kw)	2009.09-2018.12	AT/MT	Front	Terrain cab wagon closed 4WD 508PN		Propshaft	PS900324
	2009.09-2018.12	AT/MT	Rear	Terrain cab wagon closed 4WD 508PN		Propshaft	PS900325
	2009.09-2018.12	AT/MT	Front	Terrain cab wagon closed 4WD 508PN		Joint,propshaft	601910
	2009.09-2018.12	AT/MT	Rear	Terrain cab wagon closed 4WD 508PN		Joint,propshaft	699217
	2009.09-2018.12		Centre	Terrain cab wagon closed 4WD 508PN		Center Bearing Support	514799



	 YEAR	TRANSM.	FITTING POSITION	BODY STYLE & DRIVE TYPE & ENGINE	REMARKS	 PRODUCT	GSP Ref.
LAND ROVER							
Discovery I							
2.5 (85 kw)	1993.10-1998.12		Rear	Closed Off-Road Vehicle AWD 19 L		Propshaft	PS900327
Discovery III							
4.0 (161 kw)	2005.02-2009.09		Centre	Closed Off-Road Vehicle AWD 406PN		Center Bearing Support	514799
Freelander							
1.8 (86 kw)	1998.04-2006.10	AT/MT	Front	Terrain cab wagon closed 4WD 18K4F		Propshaft	PS900330
	1998.04-2006.10	AT/MT	Rear	Terrain cab wagon closed 4WD 18K4F		Propshaft	PS900331
	1998.04-2006.10		Centre	Terrain cab wagon closed 4WD 18K4F		Center Bearing Support Kit	514798S
	2000.10-2006.10	AT/MT	Rear	Terrain cab open 4WD 18K4F		Propshaft	PS900331
1.8 (88 kw)	1998.02-2000.11	AT/MT	Front	Terrain cab wagon closed 4WD 18K4F		Propshaft	PS900330
	1998.02-2000.11	AT/MT	Rear	Terrain cab wagon closed 4WD 18K4F		Propshaft	PS900331
	1998.02-2000.11		Centre	Terrain cab wagon closed 4WD 18K4F		Center Bearing Support Kit	514798S
	1998.02-2006.10	AT/MT	Front	Terrain cab open 4WD 18K4F		Propshaft	PS900330
	1998.02-2006.10	AT/MT	Rear	Terrain cab open 4WD 18K4F		Propshaft	PS900331
	1998.02-2006.10		Centre	Terrain cab open 4WD 18K4F		Center Bearing Support Kit	514798S
2.0 (72 kw)	1998.02-2000.11	AT/MT	Front	Terrain cab open 4WD 20TCIE		Propshaft	PS900330
	1998.02-2000.11	AT/MT	Front	Terrain cab wagon closed 4WD 20TCIE		Propshaft	PS900330
	1998.02-2000.11	AT/MT	Rear	Terrain cab open 4WD 20TCIE		Propshaft	PS900331
	1998.02-2000.11	AT/MT	Rear	Terrain cab wagon closed 4WD 20TCIE		Propshaft	PS900331
	1998.02-2000.11		Centre	Terrain cab wagon closed 4WD 20TCIE		Center Bearing Support Kit	514798S
2.0 (80 kw)	2001.11-2006.10	AT/MT	Front	Terrain cab wagon closed 4WD M47		Propshaft	PS900330
	2001.11-2006.10	AT/MT	Rear	Terrain cab wagon closed 4WD M47		Propshaft	PS900331
2.0 (82 kw)	2000.04-2006.10	AT/MT	Front	Terrain cab wagon closed 4WD M47		Propshaft	PS900330
	2000.04-2006.10	AT/MT	Rear	Terrain cab wagon closed 4WD M47		Propshaft	PS900331
	2000.04-2006.10		Centre	Terrain cab wagon closed 4WD M47		Center Bearing Support Kit	514798S
	2000.10-2006.10	AT/MT	Rear	Terrain cab open 4WD M47		Propshaft	PS900331
2.2 (110 kw)	2006.10-2014.10	AT	Front	Terrain cab wagon closed 4WD 224DT		Propshaft	PS900332
	2006.10-2014.10	MT	-	Terrain cab wagon closed 4WD 224DT		Propshaft	PS900336
	2006.10-2014.10	AT	Front	Terrain cab wagon closed 4WD 224DT		Joint,propshaft	835068
	2010.08-2014.10	AT	Front	Terrain cab wagon closed FWD 224DT		Joint,propshaft	835068
2.2 (112 kw)	2007.01-2014.10	AT	Front	Terrain cab wagon closed 4WD 224DT		Propshaft	PS900332
	2007.01-2014.10	MT	-	Terrain cab wagon closed 4WD 224DT		Propshaft	PS900336
	2007.01-2014.10	AT	Front	Terrain cab wagon closed 4WD 224DT		Joint,propshaft	835068
2.2 (115 kw)	2006.10-2014.10	AT	Front	Terrain cab wagon closed 4WD 224DT		Propshaft	PS900332
	2006.10-2014.10	MT	-	Terrain cab wagon closed 4WD 224DT		Propshaft	PS900336
	2006.10-2014.10	AT	Front	Terrain cab wagon closed 4WD 224DT		Joint,propshaft	835068
2.2 (118 kw)	2006.10-2014.10	AT	Front	Terrain cab wagon closed 4WD 224DT		Propshaft	PS900332
	2006.10-2014.10	MT	-	Terrain cab wagon closed 4WD 224DT		Propshaft	PS900336
	2006.10-2014.10	AT	Front	Terrain cab wagon closed 4WD 224DT		Joint,propshaft	835068
2.2 (140 kw)	2010.08-2014.10	AT	Front	Terrain cab wagon closed 4WD 224DT		Propshaft	PS900332
	2010.08-2014.10	MT	-	Terrain cab wagon closed 4WD 224DT		Propshaft	PS900336
	2010.08-2014.10	AT	Front	Terrain cab wagon closed 4WD 224DT		Joint,propshaft	835068
2.5 (130 kw)	2000.11-2006.10	AT/MT	Front	Terrain cab wagon closed 4WD 25KV6		Propshaft	PS900330
	2000.11-2006.10	AT/MT	Rear	Terrain cab wagon closed 4WD 25KV6		Propshaft	PS900331
	2000.11-2006.10		Centre	Terrain cab wagon closed 4WD 25KV6		Center Bearing Support Kit	514798S
3.2 (171 kw)	2006.10-2014.10	AT	-	Terrain cab wagon closed 4WD 32PDP		Propshaft	PS900336
Range Rover							
2.0 (221 kw)	2017.10-	8AT	Rear	SUV 4WD PT204	Chassis no. from:EA188730,Chassis no. to:FA232766	Propshaft	PS900536
2.5 (83 kw)	1992.11-1996.04		Rear	Terrain cab wagon closed 4WD 14L/21L		Propshaft	PS900327
2.5 (100 kw)	1994.08-2002.03	AT/MT	Front	Terrain cab wagon closed 4WD M51256T		Propshaft	PS900328
	1994.08-2002.03	AT/MT	Rear	Terrain cab wagon closed 4WD M51256T	Chassis no. to:TA321921	Propshaft	PS900329
3.0 (130 kw)	2002.02-2009.08	AT	Front	Terrain cab wagon closed 4WD 30DCUX	Connector Type:Tube	Propshaft	PS900334
	2002.02-2009.08	AT	Front	Terrain cab wagon closed 4WD 30DCUX	Connector Type:Flange	Propshaft	PS900338
	2002.02-2009.08	AT	Rear	Terrain cab wagon closed 4WD 30DCUX	Chassis no. to:5A999999	Propshaft	PS900339
	2002.02-2009.08	AT	-	Terrain cab wagon closed 4WD 30DCUX	Chassis no. from:7A000001	Propshaft	PS900335
	2002.02-2009.08	AT	Front	Terrain cab wagon closed 4WD 30DCUX	Chassis no. to:5A999999	Joint,propshaft	602494
	2002.02-2009.08	AT	Rear	Terrain cab wagon closed 4WD 30DCUX	Chassis no. to:5A999999	Joint,propshaft	602495
3.0 (155 kw)	2013.10-	AT	Front	SUV 4WD 306DT		Propshaft	PS900530
	2013.10-		Rear	SUV 4WD 306DT	Chassis no. from:FA531967	Propshaft	PS900537
	2013.10-	8AT	Rear	SUV 4WD 306DT	Chassis no. from:EA188730,Chassis no. to:FA232766	Propshaft	PS900536
	2013.10-	AT	Front	SUV 4WD 306DT		Joint,propshaft	601910
3.0 (182 kw)	2014.12-		Rear	SUV 4WD 306DT	Chassis no. from:FA531967	Propshaft	PS900537
	2014.12-	8AT	Rear	SUV 4WD 306DT	Chassis no. from:EA188730,Chassis no. to:FA232766	Propshaft	PS900536



	 YEAR	TRANSM.	FITTING POSITION	BODY STYLE & DRIVE TYPE & ENGINE	REMARKS	 PRODUCT	GSP Ref.
LAND ROVER							
Range Rover							
3.0 (183 kw)	2012.08-	AT	Front	SUV 4WD 306DT		Propshaft	PS900530
	2012.08-		Rear	SUV 4WD 306DT	Chassis no. from:FA531967	Propshaft	PS900537
	2012.08-	8AT	Rear	SUV 4WD 306DT	Chassis no. from:EA188730,Chassis no. to:FA232766	Propshaft	PS900536
	2012.08-	AT	Front	SUV 4WD 306DT		Joint,propshaft	601910
3.0 (190 kw)	2012.10-	AT	Front	SUV 4WD 306DT		Propshaft	PS900530
	2012.10-		Rear	SUV 4WD 306DT	Chassis no. from:FA531967	Propshaft	PS900537
	2012.10-	8AT	Rear	SUV 4WD 306DT	Chassis no. from:EA188730,Chassis no. to:FA232766	Propshaft	PS900536
	2012.10-	AT	Front	SUV 4WD 306DT		Joint,propshaft	601910
3.0 (202 kw)	2018.10-	8AT	Rear	SUV 4WD 306DT	Chassis no. from:EA188730,Chassis no. to:FA232766	Propshaft	PS900536
3.0 (215 kw)	2012.10-		Rear	SUV 4WD 306DT	Chassis no. from:FA531967	Propshaft	PS900537
	2012.10-	8AT	Rear	SUV 4WD 306DT	Chassis no. from:EA188730,Chassis no. to:FA232766	Propshaft	PS900536
	2013.10-	AT	Front	SUV 4WD 306DT		Propshaft	PS900530
	2013.10-		Rear	SUV 4WD 306DT	Chassis no. from:FA531967	Propshaft	PS900537
	2013.10-	8AT	Rear	SUV 4WD 306DT	Chassis no. from:EA188730,Chassis no. to:FA232766	Propshaft	PS900536
	2013.10-	AT	Front	SUV 4WD 306DT		Joint,propshaft	601910
3.0 (225 kw)	2015.06-	AT	Front	SUV 4WD 306DT		Propshaft	PS900530
	2015.06-		Rear	SUV 4WD 306DT	Chassis no. from:FA531967	Propshaft	PS900537
	2015.06-	8AT	Rear	SUV 4WD 306DT	Chassis no. from:EA188730,Chassis no. to:FA232766	Propshaft	PS900536
	2015.06-	AT	Front	SUV 4WD 306DT		Joint,propshaft	601910
3.0 (250 kw)	2013.10-		Rear	SUV 4WD 306PS	Chassis no. from:FA531967	Propshaft	PS900537
	2013.10-	8AT	Rear	SUV 4WD 306PS	Chassis no. from:EA188730,Chassis no. to:FA232766	Propshaft	PS900536
3.0 (280 kw)	2015.06-		Rear	SUV 4WD 306PS	Chassis no. from:FA531967	Propshaft	PS900537
	2015.06-	8AT	Rear	SUV 4WD 306PS	Chassis no. from:EA188730,Chassis no. to:FA232766	Propshaft	PS900536
3.6 (200 kw)	2006.10-2012.08		Front	Terrain cab wagon closed 4WD 36DDEX		Propshaft	PS900333
	2006.10-2012.08	AT	Rear	Terrain cab wagon closed 4WD 36DDEX	Chassis no. to:5A999999	Propshaft	PS900339
	2006.10-2012.08	AT	-	Terrain cab wagon closed 4WD 36DDEX	Chassis no. from:7A000001	Propshaft	PS900335
	2006.10-2012.08		Front	Terrain cab wagon closed 4WD 36DDEX		Joint,propshaft	601910
	2006.10-2012.08	AT	Front	Terrain cab wagon closed 4WD 36DDEX	Chassis no. to:5A999999	Joint,propshaft	602494
	2006.10-2012.08	AT	Rear	Terrain cab wagon closed 4WD 36DDEX	Chassis no. to:5A999999	Joint,propshaft	602495
4.0 (127 kw)	1988.11-1994.04		Rear	Terrain cab wagon closed 4WD 37D/38D		Propshaft	PS900327
4.0 (134 kw)	1988.11-1994.07		Rear	Terrain cab wagon closed 4WD 35D/36D		Propshaft	PS900327
4.0 (136 kw)	1989.10-1992.12		Rear	Terrain cab wagon closed 4WD 35D		Propshaft	PS900327
	1995.01-2002.08	AT/MT	Front	Terrain cab wagon closed 4WD 58D	Date From:1998.01	Propshaft	PS900328
	1995.01-2002.08	AT/MT	Rear	Terrain cab wagon closed 4WD 58D	Date From:1998.01	Propshaft	PS900329
4.0 (140 kw)	1994.07-2002.03	AT/MT	Front	Terrain cab wagon closed 4WD 42D		Propshaft	PS900328
	1994.07-2002.03	AT/MT	Rear	Terrain cab wagon closed 4WD 42D		Propshaft	PS900329
4.2 (291 kw)	2005.05-2012.08		Front	Terrain cab wagon closed 4WD LMN5		Propshaft	PS900333
	2005.05-2012.08	AT	Rear	Terrain cab wagon closed 4WD LMN5	Chassis no. to:5A999999	Propshaft	PS900339
	2005.05-2012.08	AT	-	Terrain cab wagon closed 4WD LMN5	Chassis no. from:6A000001	Propshaft	PS900335
	2005.05-2012.08		Front	Terrain cab wagon closed 4WD LMN5		Joint,propshaft	601910
	2005.05-2012.08	AT	Front	Terrain cab wagon closed 4WD LMN5	Chassis no. to:5A999999	Joint,propshaft	602494
	2005.05-2012.08	AT	Rear	Terrain cab wagon closed 4WD LMN5	Chassis no. to:5A999999	Joint,propshaft	602495
4.4 (210 kw)	2002.03-2005.12	AT	Front	Terrain cab wagon closed 4WD 44SDEX	Connector Type:Tube	Propshaft	PS900334
	2002.03-2005.12	AT	Front	Terrain cab wagon closed 4WD 44SDEX	Connector Type:Flange	Propshaft	PS900338
	2002.03-2005.12	AT	Rear	Terrain cab wagon closed 4WD 44SDEX	Chassis no. to:5A999999	Propshaft	PS900339
	2002.03-2005.12	AT	-	Terrain cab wagon closed 4WD 44SDEX	Chassis no. from:6A000001	Propshaft	PS900335
	2002.03-2005.12	AT	Front	Terrain cab wagon closed 4WD 44SDEX	Chassis no. to:5A999999	Joint,propshaft	602494
	2002.03-2005.12	AT	Rear	Terrain cab wagon closed 4WD 44SDEX	Chassis no. to:5A999999	Joint,propshaft	602495
	2002.03-2005.12		Front;Rear	Terrain cab wagon closed 4WD 44SDEX		Flexible Coupling	537625
	2002.03-2005.12			Terrain cab wagon closed 4WD 44SDEX			
4.4 (220 kw)	2004.08-2012.08	AT	Front	Terrain cab wagon closed 4WD 448PN	Connector Type:Tube	Propshaft	PS900334
	2004.08-2012.08	AT	Front	Terrain cab wagon closed 4WD 448PN	Connector Type:Flange	Propshaft	PS900338
	2004.08-2012.08	AT	Rear	Terrain cab wagon closed 4WD 448PN	Chassis no. to:5A999999	Propshaft	PS900339
	2004.08-2012.08	AT	-	Terrain cab wagon closed 4WD 448PN	Chassis no. from:6A000001	Propshaft	PS900335
	2004.08-2012.08	AT	Front	Terrain cab wagon closed 4WD 448PN	Chassis no. to:5A999999	Joint,propshaft	602494
	2004.08-2012.08	AT	Rear	Terrain cab wagon closed 4WD 448PN	Chassis no. to:5A999999	Joint,propshaft	602495
	2004.08-2012.08		Front;Rear	Terrain cab wagon closed 4WD 448PN		Flexible Coupling	537625
4.4 (225 kw)	2004.08-2012.08		Front	Terrain cab wagon closed 4WD 448S2		Propshaft	PS900333
	2004.08-2012.08	AT	Front	Terrain cab wagon closed 4WD 448S2	Connector Type:Tube	Propshaft	PS900334
	2004.08-2012.08	AT	Front	Terrain cab wagon closed 4WD 448S2	Connector Type:Flange	Propshaft	PS900338
	2004.08-2012.08	AT	Rear	Terrain cab wagon closed 4WD 448S2	Chassis no. to:5A999999	Propshaft	PS900339
	2004.08-2012.08	AT	-	Terrain cab wagon closed 4WD 448S2	Chassis no. from:6A000001	Propshaft	PS900335
	2004.08-2012.08		Front	Terrain cab wagon closed 4WD 448S2		Joint,propshaft	601910
	2004.08-2012.08	AT	Front	Terrain cab wagon closed 4WD 448S2	Chassis no. to:5A999999	Joint,propshaft	602494
	2004.08-2012.08	AT	Rear	Terrain cab wagon closed 4WD 448S2	Chassis no. to:5A999999	Joint,propshaft	602495
	2004.08-2012.08	AT	Rear	Terrain cab wagon closed 4WD 448S2	Chassis no. to:5A999999	Joint,propshaft	602495



	 YEAR	TRANSM.	FITTING POSITION	BODY STYLE & DRIVE TYPE & ENGINE	REMARKS	 PRODUCT	GSP Ref.
LAND ROVER							
Range Rover							
4.4 (225 kw)	2004.08-2012.08		Front;Rear	Terrain cab wagon closed 4WD 448S2		Flexible Coupling	537625
4.4 (230 kw)	2010.09-2012.08		Front	Terrain cab wagon closed 4WD 44DD0R		Propshaft	PS900333
	2010.09-2012.08	AT	Front	Terrain cab wagon closed 4WD 44DD0R	Connector Type:Tube	Propshaft	PS900334
	2010.09-2012.08	AT	Front	Terrain cab wagon closed 4WD 44DD0R	Connector Type:Flange	Propshaft	PS900338
	2010.09-2012.08	AT	Rear	Terrain cab wagon closed 4WD 44DD0R	Chassis no. to:5A999999	Propshaft	PS900339
	2010.09-2012.08	AT	-	Terrain cab wagon closed 4WD 44DD0R	Chassis no. from:6A000001	Propshaft	PS900335
	2010.09-2012.08		Front	Terrain cab wagon closed 4WD 44DD0R		Joint,propshaft	601910
	2010.09-2012.08	AT	Front	Terrain cab wagon closed 4WD 44DD0R	Chassis no. to:5A999999	Joint,propshaft	602494
	2010.09-2012.08	AT	Rear	Terrain cab wagon closed 4WD 44DD0R	Chassis no. to:5A999999	Joint,propshaft	602495
	2010.09-2012.08		Front;Rear	Terrain cab wagon closed 4WD 44DD0R		Flexible Coupling	537625
4.4 (249 kw)	2013.08-	8AT	Rear	SUV 4WD 448DT	Chassis no. from:EA188730;Chassis no. to:FA232766	Propshaft	PS900536
4.4 (250 kw)	2012.08-	AT	Front	SUV 4WD 448DT		Propshaft	PS900530
	2012.08-	8AT	Rear	SUV 4WD 448DT	Chassis no. from:EA188730;Chassis no. to:FA232766	Propshaft	PS900536
	2012.08-	AT	Front	SUV 4WD 448DT		Joint,propshaft	601910
4.4 (253 kw)	2013.08-	8AT	Rear	SUV 4WD 448DT	Chassis no. from:EA188730;Chassis no. to:FA232766	Propshaft	PS900536
4.6 (160 kw)	1998.11-2002.01	AT/MT	Front	Terrain cab wagon closed 4WD 60D		Propshaft	PS900328
	1998.11-2002.01	AT/MT	Rear	Terrain cab wagon closed 4WD 60D		Propshaft	PS900329
4.6 (165 kw)	1994.07-2002.03	AT/MT	Front	Terrain cab wagon closed 4WD 48D/60D		Propshaft	PS900328
	1994.07-2002.03	AT/MT	Rear	Terrain cab wagon closed 4WD 48D/60D		Propshaft	PS900329
4.6 (168 kw)	1996.09-2002.03	AT/MT	Front	Terrain cab wagon closed 4WD 46D		Propshaft	PS900328
	1996.09-2002.03	AT/MT	Rear	Terrain cab wagon closed 4WD 46D		Propshaft	PS900329
5.0 (276 kw)	2009.09-2012.08		Front	Terrain cab wagon closed 4WD 508PN		Propshaft	PS900333
	2009.09-2012.08	AT	Rear	Terrain cab wagon closed 4WD 508PN	Chassis no. to:5A999999	Propshaft	PS900339
	2009.09-2012.08	AT	-	Terrain cab wagon closed 4WD 508PN	Chassis no. from:7A000001	Propshaft	PS900335
	2009.09-2012.08		Front	Terrain cab wagon closed 4WD 508PN		Joint,propshaft	601910
	2009.09-2012.08	AT	Front	Terrain cab wagon closed 4WD 508PN	Chassis no. to:5A999999	Joint,propshaft	602494
	2009.09-2012.08	AT	Rear	Terrain cab wagon closed 4WD 508PN	Chassis no. to:5A999999	Joint,propshaft	602495
	2013.12-	AT	Front	SUV 4WD 508PN		Propshaft	PS900530
	2013.12-	8AT	Rear	SUV 4WD 508PN	Chassis no. from:EA188730;Chassis no. to:FA232766	Propshaft	PS900536
	2013.12-	AT	Front	SUV 4WD 508PN		Joint,propshaft	601910
5.0 (375 kw)	2009.09-2012.08		Front	Terrain cab wagon closed 4WD 508PS		Propshaft	PS900333
	2009.09-2012.08	AT	Rear	Terrain cab wagon closed 4WD 508PS	Chassis no. to:5A999999	Propshaft	PS900339
	2009.09-2012.08	AT	-	Terrain cab wagon closed 4WD 508PS	Chassis no. from:7A000001	Propshaft	PS900335
	2009.09-2012.08		Front	Terrain cab wagon closed 4WD 508PS		Joint,propshaft	601910
	2009.09-2012.08	AT	Front	Terrain cab wagon closed 4WD 508PS	Chassis no. to:5A999999	Joint,propshaft	602494
	2009.09-2012.08	AT	Rear	Terrain cab wagon closed 4WD 508PS	Chassis no. to:5A999999	Joint,propshaft	602495
	2012.08-	AT	Front	SUV 4WD 508PS		Propshaft	PS900530
	2012.08-	8AT	Rear	SUV 4WD 508PS	Chassis no. from:EA188730;Chassis no. to:FA232766	Propshaft	PS900536
	2012.08-	AT	Front	SUV 4WD 508PS		Joint,propshaft	601910
5.0 (386 kw)	2017.11-	8AT	Rear	SUV 4WD 508PS	Chassis no. from:EA188730;Chassis no. to:FA232766	Propshaft	PS900536
5.0 (405 kw)	2015.06-	AT	Front	SUV 4WD 508PS		Propshaft	PS900530
	2015.06-	8AT	Rear	SUV 4WD 508PS	Chassis no. from:EA188730;Chassis no. to:FA232766	Propshaft	PS900536
	2015.06-	AT	Front	SUV 4WD 508PS		Joint,propshaft	601910
5.0 (416 kw)	2017.11-	8AT	Rear	SUV 4WD 508PS	Chassis no. from:EA188730;Chassis no. to:FA232766	Propshaft	PS900536
Range Rover Evoque							
2.0 (110 kw)	2015.06-2019.12	AT/MT	-	SUV 4WD 204DTD	Date From:2016.01;Chassis no. to:FH999999	Propshaft	PS900336
	2015.11-2019.12	AT/MT	-	Cabriolet 4WD 204DTD	Date From:2016.01;Chassis no. to:FH999999	Propshaft	PS900336
2.0 (132 kw)	2015.05-2019.12	AT/MT	-	SUV 4WD 204DTD	Chassis no. to:FH999999	Propshaft	PS900336
	2015.11-2019.12	AT/MT	-	Cabriolet 4WD 204DTD	Date From:2016.01;Chassis no. to:FH999999	Propshaft	PS900336
2.0 (176 kw)	2011.09-2019.12	AT	-	SUV 4WD 204PT		Propshaft	PS900336
2.0 (177 kw)	2011.06-2019.12	AT	-	SUV 4WD 204PT		Propshaft	PS900336
	2015.11-2019.12	AT	-	Cabriolet 4WD 204PT	Date From:2016.01	Propshaft	PS900336
	2017.08-2019.12	AT	-	Cabriolet 4WD PT204	Date From:2018.01	Propshaft	PS900336
	2017.08-2019.12	AT	-	SUV 4WD PT204	Date From:2018.01	Propshaft	PS900336
	2017.08-2019.12	AT/MT	-	SUV 4WD 204DTA	Date From:2018.01;Chassis no. to:FH999999	Propshaft	PS900336
	2017.08-2019.12	AT/MT	-	Cabriolet 4WD 204DTA	Date From:2018.01;Chassis no. to:FH999999	Propshaft	PS900336
2.0 (213 kw)	2017.08-2019.12	AT	-	SUV 4WD PT204	Date From:2018.01	Propshaft	PS900336
2.2 (110 kw)	2011.06-2019.12	AT/MT	-	SUV 4WD 224DT	Chassis no. to:FH999999	Propshaft	PS900336
2.2 (140 kw)	2011.06-2019.12	AT/MT	-	SUV 4WD 224DT	Chassis no. to:FH999999	Propshaft	PS900336
Range Rover Sport							
2.0 (177 kw)	2015.10-	8AT	Rear	SUV 4WD 204PT	Chassis no. from:EA188730;Chassis no. to:FA232766	Propshaft	PS900536
	2016.10-	8AT	Rear	SUV 4WD 204DTA	Chassis no. from:EA188730;Chassis no. to:FA232766	Propshaft	PS900536
2.0 (221 kw)	2017.10-	8AT	Rear	SUV 4WD PT204	Chassis no. from:EA188730;Chassis no. to:FA232766	Propshaft	PS900536



	 YEAR	TRANSM.	FITTING POSITION	BODY STYLE & DRIVE TYPE & ENGINE	REMARKS	 PRODUCT	GSP Ref.
LAND ROVER							
Range Rover Sport							
2.7 (140 kw)	2005.02-2009.09	AT/MT	Front	SUV 4WD 276DT		Propshaft	PS900324
	2005.02-2009.09	AT/MT	Rear	SUV 4WD 276DT		Propshaft	PS900337
	2005.02-2009.09	AT/MT	Front	SUV 4WD 276DT		Joint,propshaft	601910
3.0 (155 kw)	2010.05-2013.06	AT/MT	Front	SUV 4WD 306DT		Propshaft	PS900324
	2010.05-2013.06	AT/MT	Rear	SUV 4WD 306DT		Propshaft	PS900337
	2010.05-2013.06	AT/MT	Front	SUV 4WD 306DT		Joint,propshaft	601910
	2013.07-2018.12	AT	Front	SUV 4WD 306DT	Date To:2017.12	Propshaft	PS900530
	2013.07-2018.12		Rear	SUV 4WD 306DT	Chassis no. from:FA531967	Propshaft	PS900537
	2013.07-2018.12	8AT	Rear	SUV 4WD 306DT	Chassis no. from:EA188730,Chassis no. to:FA232766	Propshaft	PS900536
	2013.07-2018.12	AT	Front	SUV 4WD 306DT	Date To:2017.12	Joint,propshaft	601910
3.0 (180 kw)	2009.09-2013.06	AT/MT	Front	SUV 4WD 306DT		Propshaft	PS900324
	2009.09-2013.06	AT/MT	Rear	SUV 4WD 306DT		Propshaft	PS900337
	2009.09-2013.06	AT/MT	Front	SUV 4WD 306DT		Joint,propshaft	601910
3.0 (183 kw)	2010.09-2013.06	AT/MT	Front	SUV 4WD 306DT		Propshaft	PS900324
	2010.09-2013.06	AT/MT	Rear	SUV 4WD 306DT		Propshaft	PS900337
	2010.09-2013.06	AT/MT	Front	SUV 4WD 306DT		Joint,propshaft	601910
	2013.07-	AT	Front	SUV 4WD 306DT		Propshaft	PS900530
	2013.07-		Rear	SUV 4WD 306DT	Chassis no. from:FA531967	Propshaft	PS900537
	2013.07-	8AT	Rear	SUV 4WD 306DT	Chassis no. from:EA188730,Chassis no. to:FA232766	Propshaft	PS900536
	2013.07-	AT	Front	SUV 4WD 306DT		Joint,propshaft	601910
3.0 (188 kw)	2011.06-2013.06	AT/MT	Front	SUV 4WD 306DT		Propshaft	PS900324
	2011.06-2013.06	AT/MT	Rear	SUV 4WD 306DT		Propshaft	PS900337
	2011.06-2013.06	AT/MT	Front	SUV 4WD 306DT		Joint,propshaft	601910
3.0 (190 kw)	2013.07-2019.12	AT	Front	SUV 4WD 306DT	Date To:2015.12	Propshaft	PS900530
	2013.07-2019.12		Rear	SUV 4WD 306DT	Chassis no. from:FA531967	Propshaft	PS900537
	2013.07-2019.12	8AT	Rear	SUV 4WD 306DT	Chassis no. from:EA188730,Chassis no. to:FA232766	Propshaft	PS900536
	2013.07-2019.12	AT	Front	SUV 4WD 306DT	Date To:2015.12	Joint,propshaft	601910
3.0 (215 kw)	2013.07-2016.12	AT	Front	SUV 4WD 306DT		Propshaft	PS900530
	2013.07-2016.12		Rear	SUV 4WD 306DT	Chassis no. from:FA531967	Propshaft	PS900537
	2013.07-2016.12	8AT	Rear	SUV 4WD 306DT	Chassis no. from:EA188730,Chassis no. to:FA232766	Propshaft	PS900536
	2013.07-2016.12	AT	Front	SUV 4WD 306DT		Joint,propshaft	601910
	2013.10-2017.12	AT	Front	SUV 4WD 306DT		Propshaft	PS900530
	2013.10-2017.12		Rear	SUV 4WD 306DT	Chassis no. from:FA531967	Propshaft	PS900537
	2013.10-2017.12	8AT	Rear	SUV 4WD 306DT	Chassis no. from:EA188730,Chassis no. to:FA232766	Propshaft	PS900536
	2013.10-2017.12	AT	Front	SUV 4WD 306DT		Joint,propshaft	601910
3.0 (225 kw)	2014.09-	AT	Front	SUV 4WD 306DT		Propshaft	PS900530
	2014.09-		Rear	SUV 4WD 306DT	Chassis no. from:FA531967	Propshaft	PS900537
	2014.09-	8AT	Rear	SUV 4WD 306DT	Chassis no. from:EA188730,Chassis no. to:FA232766	Propshaft	PS900536
	2014.09-	AT	Front	SUV 4WD 306DT		Joint,propshaft	601910
	2015.06-2017.12	AT	Front	SUV 4WD 306DT		Propshaft	PS900530
	2015.06-2017.12		Rear	SUV 4WD 306DT	Chassis no. from:FA531967	Propshaft	PS900537
	2015.06-2017.12	8AT	Rear	SUV 4WD 306DT	Chassis no. from:EA188730,Chassis no. to:FA232766	Propshaft	PS900536
3.0 (250 kw)	2013.07-2019.12		Rear	SUV 4WD 306PS	Chassis no. from:FA531967	Propshaft	PS900537
	2013.07-2019.12	8AT	Rear	SUV 4WD 306PS	Chassis no. from:EA188730,Chassis no. to:FA232766	Propshaft	PS900536
3.0 (280 kw)	2015.06-2019.12		Rear	SUV 4WD 306PS	Chassis no. from:FA531967	Propshaft	PS900537
	2015.06-2019.12	8AT	Rear	SUV 4WD 306PS	Chassis no. from:EA188730,Chassis no. to:FA232766	Propshaft	PS900536
3.6 (200 kw)	2006.04-2012.12	AT/MT	Front	SUV 4WD 36DDEX	Date From:2007.01	Propshaft	PS900324
	2006.04-2012.12	AT/MT	Rear	SUV 4WD 36DDEX	Date From:2007.01	Propshaft	PS900337
	2006.04-2012.12	AT/MT	Front	SUV 4WD 36DDEX	Date From:2007.01	Joint,propshaft	601910
4.2 (287 kw)	2005.02-2013.06	AT/MT	Front	SUV 4WD 428PS		Propshaft	PS900324
	2005.02-2013.06	AT/MT	Rear	SUV 4WD 428PS		Propshaft	PS900337
	2005.02-2013.06	AT/MT	Front	SUV 4WD 428PS		Joint,propshaft	601910
4.4 (220 kw)	2005.02-2013.12	AT/MT	Front	SUV 4WD 448PN		Propshaft	PS900324
	2005.02-2013.12	AT/MT	Rear	SUV 4WD 448PN		Propshaft	PS900337
	2005.02-2013.12	AT/MT	Front	SUV 4WD 448PN		Joint,propshaft	601910
4.4 (250 kw)	2013.10-	AT	Front	SUV 4WD 44DD0R		Propshaft	PS900530
	2013.10-	8AT	Rear	SUV 4WD 44DD0R	Chassis no. from:EA188730,Chassis no. to:FA232766	Propshaft	PS900536
	2013.10-	AT	Front	SUV 4WD 44DD0R		Joint,propshaft	601910
5.0 (276 kw)	2009.07-2013.06	AT/MT	Front	SUV 4WD 508PN		Propshaft	PS900324
	2009.07-2013.06	AT/MT	Rear	SUV 4WD 508PN		Propshaft	PS900337
	2009.07-2013.06	AT/MT	Front	SUV 4WD 508PN		Joint,propshaft	601910
5.0 (372 kw)	2010.01-2013.06	AT/MT	Front	SUV 4WD 508PS		Propshaft	PS900324
	2010.01-2013.06	AT/MT	Rear	SUV 4WD 508PS		Propshaft	PS900337



	 YEAR	TRANSM.	FITTING POSITION	BODY STYLE & DRIVE TYPE & ENGINE	REMARKS	 PRODUCT	GSP Ref.
LAND ROVER							
Range Rover Sport							
5.0 (372 kw)	2010.01-2013.06	AT/MT	Front	SUV 4WD 508PS		Joint,propshaft	601910
5.0 (375 kw)	2009.09-2013.06	AT/MT	Front	SUV 4WD 508PS		Propshaft	PS900324
	2009.09-2013.06	AT/MT	Rear	SUV 4WD 508PS		Propshaft	PS900337
	2009.09-2013.06	AT/MT	Front	SUV 4WD 508PS		Joint,propshaft	601910
	2013.07-2018.12	AT	Front	SUV 4WD 508PS		Propshaft	PS900530
	2013.07-2018.12	8AT	Rear	SUV 4WD 508PS	Chassis no. from:EA188730,Chassis no. to:FA232766	Propshaft	PS900536
	2013.07-2018.12	AT	Front	SUV 4WD 508PS		Joint,propshaft	601910
5.0 (386 kw)	2017.11-	8AT	Rear	SUV 4WD 508PS	Chassis no. from:EA188730,Chassis no. to:FA232766	Propshaft	PS900536
5.0 (405 kw)	2014.01-2018.12	AT	Front	SUV 4WD 508PS		Propshaft	PS900530
	2014.01-2018.12	8AT	Rear	SUV 4WD 508PS	Chassis no. from:EA188730,Chassis no. to:FA232766	Propshaft	PS900536
	2014.01-2018.12	AT	Front	SUV 4WD 508PS		Joint,propshaft	601910
5.0 (423 kw)	2017.11-	8AT	Rear	SUV 4WD 508PS	Chassis no. from:EA188730,Chassis no. to:FA232766	Propshaft	PS900536
LEXUS							
GS 250							
2.5 (154 kw)	2012.01-		Centre	Saloon RWD 4GRFSE		Center Bearing Support Kit	514813S
GS 300							
3.0 (161 kw)	2000.08-2005.03		Centre	Saloon RWD 2JZGE		Center Bearing Support	517627
3.0 (163 kw)	1997.09-2000.07		Centre	Saloon RWD 2JZGE		Center Bearing Support	517627
3.0 (183 kw)	2005.04-2011.11		Centre	Saloon RWD 3GRFSE		Center Bearing Support Kit	514813S
GS 300h							
2.5 (133 kw)	2013.10-		Centre	Saloon RWD 2ARFSE		Center Bearing Support Kit	514813S
GS 400							
4.0 (216 kw)	1997.08-2000.12		Centre	Saloon RWD 1UZFE		Center Bearing Support	517627
GS 430							
4.3 (208 kw)	2000.07-2005.12		Centre	Saloon RWD 3UZFE		Center Bearing Support	517627
	2005.04-2011.11		Centre	Saloon RWD 3UZFE		Center Bearing Support Kit	514813S
GS 450h							
3.5 (215 kw)	2012.01-		Centre	Saloon RWD 2GRFXE		Center Bearing Support Kit	514813S
3.5 (218 kw)	2006.02-2011.11		Centre	Saloon RWD 2GRFSE		Center Bearing Support Kit	514813S
GS 460							
4.6 (255 kw)	2007.09-2011.11		Centre	Saloon RWD 1URFSE		Center Bearing Support Kit	514813S
GS F							
5.0 (348 kw)	2015.09-		Centre	Saloon RWD 2URGSE		Center Bearing Support Kit	514813S
5.0 (351 kw)	2015.09-		Centre	Saloon RWD 2URGSE		Center Bearing Support Kit	514813S
IS 200							
2.0 (114 kw)	1999.01-2005.07		Centre	Saloon RWD 1GFE		Center Bearing Support	513040
	2002.08-2005.07		Centre	Estate RWD 1GFE		Center Bearing Support	513040
IS 200d							
2.2 (110 kw)	2010.07-2012.07		Centre	Saloon RWD 2ADFTV		Center Bearing Support Kit	514813S
IS 220d							
2.2 (130 kw)	2005.08-2013.04		Centre	Saloon RWD 2ADFHV		Center Bearing Support Kit	514813S
IS 250							
2.5 (153 kw)	2005.08-2013.04		Centre	Saloon RWD 4GRFSE		Center Bearing Support Kit	514813S
	2013.04-		Centre	Saloon RWD 4GRFSE		Center Bearing Support Kit	514813S
IS 300							
3.0 (157 kw)	2001.07-2005.07		Centre	Saloon RWD 2JZGE		Center Bearing Support	513040
	2001.07-2005.07		Centre	Saloon RWD 2JZGE		Center Bearing Support Kit	513040S
	2001.07-2005.10		Centre	Estate RWD 2JZGE		Center Bearing Support	513040
IS 300h							
2.5 (133 kw)	2013.04-		Centre	Saloon RWD 2ARFSE		Center Bearing Support Kit	514813S
ISF							
5.0 (311 kw)	2007.12-2013.04		Centre	Saloon RWD 2URGSE		Center Bearing Support Kit	514813S
LS 400							
4.0 (180 kw)	1989.12-1995.12		Centre	Saloon RWD 1UZFE		Center Bearing Support	517626
LS 430							
4.3 (207 kw)	2000.08-2006.12		Centre	Saloon RWD 3UZFE		Center Bearing Support	517627
4.3 (208 kw)	2000.08-2006.08		Centre	Saloon RWD 3UZFE		Center Bearing Support	517627
LS 460							
4.6 (255 kw)	2006.08-		Centre	Saloon RWD 1URFSE		Center Bearing Support Kit	514813S
4.6 (270 kw)	2008.12-		Centre	Saloon 4WD 1URFSE		Center Bearing Support Kit	514813S
4.6 (272 kw)	2012.09-		Centre	Saloon 4WD 1URFSE		Center Bearing Support Kit	514813S
4.6 (280 kw)	2006.08-		Centre	Saloon RWD 1URFSE		Center Bearing Support Kit	514813S
4.6 (285 kw)	2012.09-		Centre	Saloon RWD 1URFSE		Center Bearing Support Kit	514813S



	 YEAR	TRANSM.	FITTING POSITION	BODY STYLE & DRIVE TYPE & ENGINE	REMARKS	 PRODUCT	GSP Ref.
LEXUS							
LS 600h							
5.0 (290 kw)	2007.04-		Centre	Saloon 4WD 2URFSE		Center Bearing Support Kit	514813S
NX 200t							
2.0 (175 kw)	2014.07-		Centre	SUV 4WD 8ARFTS		Center Bearing Support Kit	519035S
RC 300h							
2.5 (133 kw)	2014.09-		Centre	Coupe RWD 2ARFSE		Center Bearing Support Kit	514813S
RCF							
5.0 (351 kw)	2014.09-		Centre	Coupe RWD 2URGSE		Center Bearing Support Kit	514813S
RX 200t							
2.0 (175 kw)	2015.10-2017.12	AT	Rear	SUV 4WD 8ARFTS		Propshaft	PS900477
	2015.10-2017.12		Rear	SUV 4WD 8ARFTS		Center Bearing Support	532824
	2015.10-2017.12		Front;Rear	SUV 4WD 8ARFTS		Center Bearing Support Kit	514789S
RX 300							
2.0 (170 kw)	2020.07-	AT	Rear	SUV 4WD 8ARFTS		Propshaft	PS900477
2.0 (175 kw)	2017.12-	AT	Rear	SUV 4WD 8ARFTS		Propshaft	PS900477
	2017.12-		Rear	SUV 4WD 8ARFTS		Center Bearing Support	532824
3.0 (148 kw)	2000.07-2003.02		Rear	SUV 4WD 1MZFE		Center Bearing Support	532824
	2000.07-2003.02		Front;Rear	SUV 4WD 1MZFE		Center Bearing Support Kit	514789S
3.0 (150 kw)	2003.05-2008.12	5AT	Rear	SUV 4WD 1MZFE		Propshaft	PS900503
	2003.05-2008.12		Rear	SUV 4WD 1MZFE		Center Bearing Support	532824
	2003.05-2008.12		Front;Rear	SUV 4WD 1MZFE		Center Bearing Support Kit	514789S
3.0 (164 kw)	1998.01-2003.02		Rear	SUV 4WD 1MZFE		Center Bearing Support	532824
RX 330							
3.3 (171 kw)	2003.04-2008.12	5AT	Rear	SUV 4WD 3MZFE		Propshaft	PS900503
	2003.04-2008.12		Rear	SUV 4WD 3MZFE		Center Bearing Support	532824
RX 350							
3.5 (203 kw)	2006.02-2009.06	5AT	Rear	SUV 4WD 2GRFE		Propshaft	PS900503
	2006.02-2009.06		Rear	SUV 4WD 2GRFE		Center Bearing Support	532824
	2006.02-2009.06		Front;Rear	SUV 4WD 2GRFE		Center Bearing Support Kit	514789S
3.5 (204 kw)	2009.01-2015.09		Rear	SUV 4WD 2GRFE		Center Bearing Support	532824
	2009.01-2015.09		Front;Rear	SUV 4WD 2GRFE		Center Bearing Support Kit	514789S
3.5 (217 kw)	2015.10-		Rear	SUV 4WD 2GRFKS		Center Bearing Support	532824
3.5 (218 kw)	2015.10-		Rear	SUV 4WD 2GRFKS		Center Bearing Support	532824
3.5 (221 kw)	2015.10-		Rear	SUV 4WD 2GRFKS		Center Bearing Support	532824
RX 400h							
3.3 (155 kw)	2005.03-2008.12		Rear	SUV 4WD 3MZFE		Center Bearing Support	532824
	2005.03-2008.12		Front;Rear	SUV 4WD 3MZFE		Center Bearing Support Kit	514789S
RX 450h							
3.5 (193 kw)	2015.11-	AT	Rear	SUV 4WD 2GRFXS		Propshaft	PS900477
SC 430							
4.3 (210 kw)	2001.08-2010.07		Centre	Cabriolet RWD 3UZFE		Center Bearing Support	517627
4.3 (215 kw)	2001.01-2010.07		Centre	Cabriolet RWD 3UZFE		Center Bearing Support	517627
4.3 (244 kw)	2009.01-2010.07		Centre	Cabriolet RWD 3UZFE		Center Bearing Support	517627
LINCOLN							
Navigator							
5.4 (228 kw)	2010.01-2010.12		Front	SUV 4WD T54USEM		Joint,propshaft	818279
5.4 (231 kw)	2008.09-2014.12		Front	SUV AWD T54USEM		Propshaft	299302
	2008.09-2014.12		Front	SUV RWD T54USEM		Propshaft	299302
MAN							
F2000							
11.967 (228 kw)	1998.06-		-	Platform/Chassis 4x2 D 2866 LF34(06.98-)		Center Bearing Support Kit	531058S
	1998.06-		-	Dump Truck 4x2 D 2866 LF34(06.98-)		Center Bearing Support Kit	531058S
	1998.06-		-	Truck Tractor 4x2 D 2866 LF34(06.98-)		Center Bearing Support Kit	531058S
	2001.05-		-	Platform/Chassis 6x2 D 2866 LF23D 2866 LF34		Center Bearing Support Kit	531058S
	2001.05-		-	Platform/Chassis 6x2/4 D 2866 LF23		Center Bearing Support Kit	531058S
	2001.05-		-	Platform/Chassis 6x2 D 2866 LF23		Center Bearing Support Kit	531058S
	2001.05-		-	Truck Tractor 6x2 D 2866 LF23		Center Bearing Support Kit	531058S
	2001.05-		-	Truck Tractor 6x2/4 D 2866 LF23		Center Bearing Support Kit	531058S
11.967 (265 kw)	1998.06-		-	Platform/Chassis 4x2 D 2866 LF35(06.98-)		Center Bearing Support Kit	531058S
	1998.06-		-	Dump Truck 4x2 D 2866 LF35(06.98-)		Center Bearing Support Kit	531058S
	1998.06-		-	Truck Tractor 4x2 D 2866 LF35(06.98-)		Center Bearing Support Kit	531058S
	2001.05-		-	Platform/Chassis 6x2 D 2866 LF24		Center Bearing Support Kit	531058S
	2001.05-		-	Platform/Chassis 6x2/4 D 2866 LF24		Center Bearing Support Kit	531058S
	2001.05-		-	Truck Tractor 6x2 D 2866 LF24		Center Bearing Support Kit	531058S
	2001.05-		-	Truck Tractor 6x2/4 D 2866 LF24		Center Bearing Support Kit	531058S



	 YEAR	TRANSM.	FITTING POSITION	BODY STYLE & DRIVE TYPE & ENGINE	REMARKS	 PRODUCT	GSP Ref.
MAN F2000							
11.967 (272 kw)	1994.01-		-	Platform/Chassis 4x2 D 2866 LF21		Center Bearing Support Kit	531058S
	1994.01-		-	Dump Truck 4x2 D 2866 LF21		Center Bearing Support Kit	531058S
	1994.01-		-	Truck Tractor 4x2 D 2866 LF21		Center Bearing Support Kit	531058S
	1994.01-1995.12		-	Platform/Chassis 6x2 D 2866 LF21		Center Bearing Support Kit	531058S
	1994.01-1995.12		-	Platform/Chassis 6x2/4 D 2866 LF21		Center Bearing Support Kit	531058S
	1994.01-1995.12		-	Truck Tractor 6x2 D 2866 LF21		Center Bearing Support Kit	531058S
11.967 (294 kw)	1994.01-		-	Platform/Chassis 4x2 D 2866 LF20		Center Bearing Support Kit	531058S
	1994.01-		-	Dump Truck 4x2 D 2866 LF20		Center Bearing Support Kit	531058S
	1994.01-		-	Truck Tractor 4x2 D 2866 LF20		Center Bearing Support Kit	531058S
	1994.01-		-	Truck Tractor 6x2 D 2866 LF20		Center Bearing Support Kit	531058S
	1994.01-		-	Truck Tractor 6x2/4 D 2866 LF20		Center Bearing Support Kit	531058S
11.967 (301 kw)	1998.06-		-	Platform/Chassis 4x2 D 2866 LF31(06.98-)		Center Bearing Support Kit	531058S
	1998.06-		-	Dump Truck 4x2 D 2866 LF31(06.98-)		Center Bearing Support Kit	531058S
	1998.06-		-	Truck Tractor 4x2 D 2866 LF31(06.98-)		Center Bearing Support Kit	531058S
	2001.05-		-	Platform/Chassis 6x2/4 D 2866 LF25		Center Bearing Support Kit	531058S
	2001.05-		-	Platform/Chassis 6x2 D 2866 LF25		Center Bearing Support Kit	531058S
	2001.05-		-	Truck Tractor 6x2 D 2866 LF25		Center Bearing Support Kit	531058S
11.967 (309 kw)	1994.01-		-	Platform/Chassis 4x2 D 2866 LF22		Center Bearing Support Kit	531058S
	1994.01-		-	Dump Truck 4x2 D 2866 LF22		Center Bearing Support Kit	531058S
	1994.01-		-	Truck Tractor 4x2 D 2866 LF22		Center Bearing Support Kit	531058S
	1994.01-		-	Truck Tractor 6x2/4 D 2876 LF 02		Center Bearing Support Kit	531058S
12.816 (338 kw)	1994.01-		-	Platform/Chassis 4x2 D 2876 LF 02		Center Bearing Support Kit	531058S
	1994.01-		-	Dump Truck 4x2 D 2876 LF 02		Center Bearing Support Kit	531058S
	1994.01-		-	Platform/Chassis 6x2/4 D 2876 LF 02		Center Bearing Support Kit	531058S
	1994.01-		-	Platform/Chassis 6x2 D 2876 LF 02		Center Bearing Support Kit	531058S
	1994.01-		-	Truck Tractor 6x2/4 D 2876 LF 02		Center Bearing Support Kit	531058S
	1994.01-		-	Truck Tractor 6x2 D 2876 LF 02		Center Bearing Support Kit	531058S
	1998.06-		-	Platform/Chassis 4x2 D 2876 LF 06(06.98-)		Center Bearing Support Kit	531058S
	1998.06-		-	Dump Truck 4x2 D 2876 LF 06(06.98-)		Center Bearing Support Kit	531058S
	1998.06-		-	Truck Tractor 4x2 D 2876 LF 06(06.98-)		Center Bearing Support Kit	531058S
	2001.05-		-	Platform/Chassis 6x2 D 2876 LF 03		Center Bearing Support Kit	531058S
	2001.05-		-	Platform/Chassis 6x2/4 D 2876 LF 03		Center Bearing Support Kit	531058S
	2001.05-		-	Truck Tractor 6x2 D 2876 LF 03		Center Bearing Support Kit	531058S
9.973 (198 kw)	1994.01-		-	Platform/Chassis 4x2 D 2865 LF22		Center Bearing Support Kit	531058S
	1994.01-		-	Dump Truck 4x2 D 2865 LF22		Center Bearing Support Kit	531058S
	1994.01-1995.12		-	Truck Tractor 4x2 D 2865 LF22		Center Bearing Support Kit	531058S
	1994.01-1995.12		-	Platform/Chassis 6x4 D 2865 LF22		Center Bearing Support Kit	531058S
	1994.01-1995.12		-	Dump Truck 6x4 D 2865 LF22		Center Bearing Support Kit	531058S
	1994.06-		-	Platform/Chassis 4x2 D 2865 LF22		Center Bearing Support Kit	531058S
9.973 (213 kw)	1994.01-		-	Platform/Chassis 4x2 D 2865 LF20/D 2865 LF24		Center Bearing Support Kit	531058S
	1994.01-		-	Dump Truck 4x2 D 2865 LF20/D 2865 LF24		Center Bearing Support Kit	531058S
	1994.01-		-	Truck Tractor 4x2 D 2865 LF20/D 2865 LF24		Center Bearing Support Kit	531058S
	1994.01-		-	Truck Tractor 6x4 D 2865 LF20/D 2865 LF24		Center Bearing Support Kit	531058S
	1994.01-		-	Platform/Chassis 6x4 D 2865 LF20/D 2865 LF24		Center Bearing Support Kit	531058S
	1994.01-		-	Dump Truck 6x4 D 2865 LF20/D 2865 LF24		Center Bearing Support Kit	531058S
9.973 (235 kw)	1994.01-		-	Dump Truck 6x4 D 2865 LF23		Center Bearing Support Kit	531058S
	1994.01-1995.12		-	Platform/Chassis 4x2 D 2865 LF23		Center Bearing Support Kit	531058S
	1994.01-1995.12		-	Truck Tractor 4x2 D 2865 LF23		Center Bearing Support Kit	531058S
	1994.01-1995.12		-	Platform/Chassis 6x4 D 2865 LF23		Center Bearing Support Kit	531058S
	1994.01-1995.12		-	Dump Truck 6x4 D 2865 LF23		Center Bearing Support Kit	531058S
	1994.01-1995.12		-	Truck Tractor 6x4 D 2865 LF23		Center Bearing Support Kit	531058S
9.973 (250 kw)	1994.01-		-	Platform/Chassis 4x2 D 2865 LF21		Center Bearing Support Kit	531058S
	1994.01-		-	Dump Truck 4x2 D 2865 LF21		Center Bearing Support Kit	531058S
	1994.01-		-	Truck Tractor 4x2 D 2865 LF21		Center Bearing Support Kit	531058S
	1994.01-		-	Platform/Chassis 6x4 D 2865 LF21		Center Bearing Support Kit	531058S
	1994.01-		-	Dump Truck 6x4 D 2865 LF21		Center Bearing Support Kit	531058S
	1994.01-		-	Truck Tractor 6x4 D 2865 LF21		Center Bearing Support Kit	531058S
F90							
11.967 (177 kw)	1990.02-1997.06		-	Platform/Chassis 6x4 D 2866 F/240(02.90-)		Center Bearing Support Kit	531058S
	1990.02-1997.06		-	Dump Truck 6x4 D 2866 F/240(02.90-)		Center Bearing Support Kit	531058S
	1990.02-1997.06		-	Truck Tractor 6x4 D 2866 F/240(02.90-)		Center Bearing Support Kit	531058S



	 YEAR	TRANSM.	FITTING POSITION	BODY STYLE & DRIVE TYPE & ENGINE	REMARKS	 PRODUCT	GSP Ref.	
MAN F90								
11.967 (213 kw)	1988.10-1995.04	-	-	Platform/Chassis 8x4/4 D 2866 LFZ/290(10.88-08.88)		Center Bearing Support Kit	531058S	
	1988.10-1995.04	-	-	Dump Truck 8x4/4 D 2866 LFZ/290(10.88-08.88)		Center Bearing Support Kit	531058S	
11.967 (220 kw)	1990.05-1995.04	-	-	Truck Tractor 6x4 D 2866 LF04(05.90-09.91)		Center Bearing Support Kit	531058S	
11.967 (249 kw)	1990.02-1996.06	-	-	Platform/Chassis 8x4/4 D 2866 LXF(09.90-)		Center Bearing Support Kit	531058S	
	1990.05-1995.04	-	-	Platform/Chassis 4x2 D 2866 LXF(05.90-)		Center Bearing Support Kit	531058S	
	1990.05-1995.04	-	-	Truck Tractor 4x2 D 2866 LXF(05.90-)		Center Bearing Support Kit	531058S	
	1990.05-1995.04	-	-	Dump Truck 8x4/4 D 2866 LXF(09.90-)		Center Bearing Support Kit	531058S	
	1990.09-1992.12	-	-	Platform/Chassis 6x4 D 2866 LXF(09.90-)		Center Bearing Support Kit	531058S	
	1990.09-1992.12	-	-	Dump Truck 6x4 D 2866 LXF(09.90-)		Center Bearing Support Kit	531058S	
	1990.09-1992.12	-	-	Truck Tractor 6x4 D 2866 LXF(09.90-)		Center Bearing Support Kit	531058S	
	1990.09-1993.10	-	-	Truck Tractor 6x2/4 D 2866 LXF(09.90-)		Center Bearing Support Kit	531058S	
11.967 (272 kw)	1990.02-1995.04	-	-	Dump Truck 6x4 D 2866 LF03(02.90-05.94)		Center Bearing Support Kit	531058S	
	1990.02-1995.05	-	-	Platform/Chassis 6x2 D 2866 LF03(02.90-05.94)D 2866 LF15(05.94-05.95)		Center Bearing Support Kit	531058S	
	1990.02-1995.05	-	-	Truck Tractor 4x2 D 2866 LF03(02.90-05.94)D 2866 LF15(05.94-05.95)		Center Bearing Support Kit	531058S	
	1990.02-1995.05	-	-	Platform/Chassis 6x2 D 2866 LF03(02.90-05.94)D 2866 LF15(05.94-05.95)		Center Bearing Support Kit	531058S	
	1990.02-1995.05	-	-	Platform/Chassis 6x2/4 D 2866 LF03(02.90-05.94)D 2866 LF15(05.94-05.95)		Center Bearing Support Kit	531058S	
	1990.02-1995.05	-	-	Truck Tractor 6x2 D 2866 LF03(02.90-05.94)D 2866 LF15(05.94-05.95)		Center Bearing Support Kit	531058S	
	1990.02-1995.05	-	-	Truck Tractor 6x2/4 D 2866 LF03(02.90-05.94)D 2866 LF15(05.94-05.95)		Center Bearing Support Kit	531058S	
	1990.02-1996.06	-	-	Platform/Chassis 6x4 D 2866 LF03(02.90-05.94)D 2866 LF15(05.94-05.95)		Center Bearing Support Kit	531058S	
	1990.02-1996.06	-	-	Truck Tractor 6x4 D 2866 LF03(02.90-05.94)D 2866 LF15(05.94-05.95)		Center Bearing Support Kit	531058S	
	1990.02-1996.06	-	-	Platform/Chassis 8x4 D 2866 LF03(02.90-05.94)D 2866 LF15(05.94-05.95)		Center Bearing Support Kit	531058S	
	1990.02-1996.06	-	-	Dump Truck 6x4 D 2866 LF03(02.90-05.94)D 2866 LF15(05.94-05.95)		Center Bearing Support Kit	531058S	
	1990.09-1992.12	-	-	Platform/Chassis 6x4 D 2866 LF03(02.90-12.92)D 2866 LF05(10.92-12.92)		Center Bearing Support Kit	531058S	
	1990.09-1992.12	-	-	Dump Truck 6x4 D 2866 LF03(02.90-12.92)D 2866 LF05(10.92-12.92)		Center Bearing Support Kit	531058S	
	1990.09-1992.12	-	-	Truck Tractor 6x4 D 2866 LF03(02.90-12.92)D 2866 LF05(10.92-12.92)		Center Bearing Support Kit	531058S	
	1990.09-1992.12	-	-	Platform/Chassis 6x2 D 2866 LF03(02.90-12.92)D 2866 LF05(10.92-12.92)		Center Bearing Support Kit	531058S	
	1990.09-1993.10	-	-	Truck Tractor 6x2 D 2866 LF03(02.90-12.92)D 2866 LF05(10.92-12.92)		Center Bearing Support Kit	531058S	
	1990.09-1993.10	-	-	Truck Tractor 6x2/4 D 2866 LF03(02.90-12.92)D 2866 LF05(10.92-12.92)		Center Bearing Support Kit	531058S	
	1990.09-1995.12	-	-	Platform/Chassis 6x2 D 2866 LF03(02.90-05.94)D 2866 LF15(05.94-05.95)		Center Bearing Support Kit	531058S	
	1990.09-1995.12	-	-	Platform/Chassis 6x2/4 D 2866 LF03(02.90-05.94)D 2866 LF15(05.94-05.95)		Center Bearing Support Kit	531058S	
	1991.01-1996.06	-	-	Dump Truck 6x4 D 2866 LF03(01.01-05.94)D 2866 LF05(10.92-05.94)		Center Bearing Support Kit	531058S	
	1991.09-1996.06	-	-	Platform/Chassis 6x4 D 2866 LF03(01.01-05.94)D 2866 LF05(10.92-05.94)		Center Bearing Support Kit	531058S	
	1991.09-1996.06	-	-	Truck Tractor 6x4 D 2866 LF03(01.01-05.94)D 2866 LF05(10.92-05.94)		Center Bearing Support Kit	531058S	
	1992.01-1996.06	-	-	Dump Truck 6x4 D 2866 LF03(01.01-05.94)D 2866 LF05(10.92-05.94)		Center Bearing Support Kit	531058S	
	1992.01-1996.06	-	-	Truck Tractor 6x4 D 2866 LF03(01.01-05.94)D 2866 LF05(10.92-05.94)		Center Bearing Support Kit	531058S	
	1992.01-1996.06	-	-	Truck Tractor 6x2 D 2866 LF03(01.01-05.94)D 2866 LF05(10.92-05.94)		Center Bearing Support Kit	531058S	
	11.967 (294 kw)	1994.05-1995.05	-	-	Platform/Chassis 4x2 D 2866 LF16		Center Bearing Support Kit	531058S
		1994.05-1995.05	-	-	Dump Truck 4x2 D 2866 LF16		Center Bearing Support Kit	531058S
		1994.05-1995.05	-	-	Truck Tractor 4x2 D 2866 LF16		Center Bearing Support Kit	531058S
		1994.05-1995.12	-	-	Platform/Chassis 6x2 D 2866 LF16		Center Bearing Support Kit	531058S
		1994.05-1996.06	-	-	Truck Tractor 6x4 D 2866 LF16		Center Bearing Support Kit	531058S
		1994.05-1996.06	-	-	Platform/Chassis 6x4 D 2866 LF16		Center Bearing Support Kit	531058S
		1994.05-1996.06	-	-	Dump Truck 6x4 D 2866 LF16		Center Bearing Support Kit	531058S
1994.05-1996.06		-	-	Platform/Chassis 6x2/4 D 2866 LF16		Center Bearing Support Kit	531058S	
1994.05-1996.06		-	-	Platform/Chassis 6x2 D 2866 LF16		Center Bearing Support Kit	531058S	
1994.05-1996.06		-	-	Truck Tractor 6x2 D 2866 LF16		Center Bearing Support Kit	531058S	
1994.05-1996.06		-	-	Dump Truck 8x4/4 D 2866 LF16		Center Bearing Support Kit	531058S	
1994.05-1996.06		-	-	Truck Tractor 6x4 D 2866 LF16		Center Bearing Support Kit	531058S	
1994.05-1996.06		-	-	Platform/Chassis 8x4/4 D 2866 LF16		Center Bearing Support Kit	531058S	
1994.05-1997.12		-	-	Platform/Chassis 8x6/4 D 2866 LF16		Center Bearing Support Kit	531058S	
1994.05-1997.12	-	-	Dump Truck 8x6/4 D 2866 LF16		Center Bearing Support Kit	531058S		
11.967 (309 kw)	1990.02-1995.05	-	-	Platform/Chassis 4x4 D 2866 LF06(02.90-YD 2866 LF09(10.92)D 2866 LF10		Center Bearing Support Kit	531058S	
	1990.02-1995.05	-	-	Dump Truck 4x2 D 2866 LF06(02.90-YD 2866 LF09(10.92))		Center Bearing Support Kit	531058S	
	1990.02-1995.05	-	-	Truck Tractor 4x2 D 2866 LF06(02.90-YD 2866 LF09(10.92))D 2866 LF10		Center Bearing Support Kit	531058S	
	1990.02-1995.05	-	-	Platform/Chassis 6x2 D 2866 LF06(02.90-YD 2866 LF09(10.92))		Center Bearing Support Kit	531058S	
	1990.02-1995.05	-	-	Platform/Chassis 6x2/4 D 2866 LF06(02.90-YD 2866 LF09(10.92))		Center Bearing Support Kit	531058S	
	1990.02-1995.12	-	-	Dump Truck 6x4 D 2866 LF06(02.90-YD 2866 LF09(10.92))		Center Bearing Support Kit	531058S	
	1990.02-1995.12	-	-	Truck Tractor 6x4 D 2866 LF06(02.90-YD 2866 LF09(10.92))		Center Bearing Support Kit	531058S	
	1990.02-1996.06	-	-	Platform/Chassis 6x4 D 2866 LF06(02.90-YD 2866 LF09(10.92))		Center Bearing Support Kit	531058S	
	1990.02-1996.06	-	-	Platform/Chassis 8x4/4 D 2866 LF06(02.90-YD 2866 LF09(10.92))		Center Bearing Support Kit	531058S	
	1990.02-1996.06	-	-	Dump Truck 8x4/4 D 2866 LF06(02.90-YD 2866 LF09(10.92))		Center Bearing Support Kit	531058S	
	1990.09-1992.12	-	-	Platform/Chassis 6x4 D 2866 LF06(09.90-YD 2866 LF09(10.92))		Center Bearing Support Kit	531058S	
	1990.09-1992.12	-	-	Dump Truck 6x4 D 2866 LF06(09.90-YD 2866 LF09(10.92))		Center Bearing Support Kit	531058S	
	1990.09-1992.12	-	-	Truck Tractor 6x4 D 2866 LF06(09.90-YD 2866 LF09(10.92))		Center Bearing Support Kit	531058S	
	1990.09-1992.12	-	-	Truck Tractor 6x4 D 2866 LF06(09.90-YD 2866 LF09(10.92))		Center Bearing Support Kit	531058S	



	 YEAR	TRANSM.	FITTING POSITION	BODY STYLE & DRIVE TYPE & ENGINE	REMARKS	 PRODUCT	GSP Ref.
MAN L2000							
6.871 (162-169 kw)	1993.10-1996.06		-	Platform/Chassis 4x2 D 0826 LFL02(10.93-)D 0826 LFL06		Center Bearing Support Kit	531058S
	1993.10-1996.06		-	Dump Truck 4x2 D 0826 LFL02(10.93-)D 0826 LFL06		Center Bearing Support Kit	531058S
	1993.10-1996.06		-	Truck Tractor 4x2 D 0826 LFL02(10.93-)D 0826 LFL06		Center Bearing Support Kit	531058S
6.871 (162 kw)	1994.05-		-	Platform/Chassis 4x2 D 0826 LFL03/D 0826 LFL10		Center Bearing Support Kit	531058S
	1994.05-		-	Dump Truck 4x2 D 0826 LFL03		Center Bearing Support Kit	531058S
	1994.05-		-	Truck Tractor 4x2 D 0826 LFL03		Center Bearing Support Kit	531058S
	1994.05-		-	Platform/Chassis 4x2 D 0826 LFL03		Center Bearing Support Kit	531058S
	2000.09-		-	Platform/Chassis 4x2 D 0836 LFL 02		Center Bearing Support Kit	531058S
	2000.09-		-	Platform/Chassis 4x2 D 0836 LFL 02/D 0836 LFL 02/D 0836 LFL 02		Center Bearing Support Kit	531058S
	2000.09-		-	Dump Truck 4x2 D 0836 LFL 02		Center Bearing Support Kit	531058S
	2000.09-		-	Truck Tractor 4x2 D 0836 LFL 02		Center Bearing Support Kit	531058S
	2000.09-		-	Platform/Chassis 4x2 D 0836 LFL 01/D 0836 LFL 01/D 0836 LFL 01		Center Bearing Support Kit	531058S
M2000 L							
4.58 (132-136 kw)	2001.05-		-	Platform/Chassis 4x2 D 0834 LFL 03		Center Bearing Support Kit	531058S
6.871 (162 kw)	2001.05-		-	Platform/Chassis 4x2 D 0836 LFL 02		Center Bearing Support Kit	531058S
6.871 (180 kw)	2000.09-		-	Platform/Chassis 4x2 D 0836 LFL 05		Center Bearing Support Kit	531058S
6.871 (191 kw)	1995.08-		-	Platform/Chassis 4x2 D 0826 LFL09		Center Bearing Support Kit	531058S
6.871 (206 kw)	1998.10-		-	Platform/Chassis 4x2 D 0836 LF 01(10.98-)		Center Bearing Support Kit	531058S
	2002.08-		-	Platform/Chassis 4x2 D 0836 LFL 01		Center Bearing Support Kit	531058S
M2000 M							
6.871 (162 kw)	1995.08-2005.12		-	Truck Tractor 4x2 D 0826 LF15/D 0826 LF18		Center Bearing Support Kit	531058S
	1995.08-2005.12		-	Platform/Chassis 4x2 D 0826 LF15/D 0826 LF18		Center Bearing Support Kit	531058S
	1995.08-2005.12		-	Dump Truck 4x2 D 0826 LF15/D 0826 LF18		Center Bearing Support Kit	531058S
	2000.10-2005.12		-	Platform/Chassis 4x2 D 0836 LF 02/D 0836 LF 04		Center Bearing Support Kit	531058S
	2000.10-2005.12		-	Platform/Chassis 4x2 D 0836 LF 04		Center Bearing Support Kit	531058S
	2000.10-2005.12		-	Dump Truck 4x2 D 0826 LF15/D 0826 LF18/D 0836 LF 04		Center Bearing Support Kit	531058S
	2003.02-2005.12		-	Platform/Chassis 4x2 D 0826 LF15/D 0826 LF18/D 0836 LF 04		Center Bearing Support Kit	531058S
	2003.02-2005.12		-	Truck Tractor 4x2 D 0826 LF15/D 0826 LF18/D 0836 LF 04		Center Bearing Support Kit	531058S
	2003.02-2005.12		-	Platform/Chassis 4x2 D 0836 LF 04		Center Bearing Support Kit	531058S
	2003.02-2005.12		-	Truck Tractor 4x2 D 0836 LF 04		Center Bearing Support Kit	531058S
6.871 (180 kw)	2000.10-2005.12		-	Platform/Chassis 4x2 D 0836 LF 05		Center Bearing Support Kit	531058S
	2000.10-2005.12		-	Truck Tractor 4x2 D 0836 LF 05		Center Bearing Support Kit	531058S
	2002.11-2005.12		-	Dump Truck 4x2 D 0836 LF 05		Center Bearing Support Kit	531058S
	2003.02-2005.12		-	Platform/Chassis 4x2 D 0836 LF 05		Center Bearing Support Kit	531058S
6.871 (191 kw)	1995.08-2005.12		-	Platform/Chassis 4x2 D 0826 LF17		Center Bearing Support Kit	531058S
	1995.08-2005.12		-	Truck Tractor 4x2 D 0826 LF17		Center Bearing Support Kit	531058S
	1995.08-2005.12		-	Dump Truck 4x2 D 0826 LF17		Center Bearing Support Kit	531058S
	2003.02-2005.12		-	Platform/Chassis 4x2 D 0826 LF17		Center Bearing Support Kit	531058S
6.871 (206 kw)	1998.06-2005.12		-	Platform/Chassis 4x2 D 0836 LF 01(06.98-)		Center Bearing Support Kit	531058S
	1998.06-2005.12		-	Truck Tractor 4x2 D 0836 LF 01(06.98-)		Center Bearing Support Kit	531058S
	1998.06-2005.12		-	Dump Truck 4x2 D 0836 LF 01(06.98-)		Center Bearing Support Kit	531058S
	1998.06-2005.12		-	Platform/Chassis 4x2 D 0836 LF 03		Center Bearing Support Kit	531058S
	1999.09-2005.12		-	Platform/Chassis 4x2 D 0836 LFL 03		Center Bearing Support Kit	531058S
	2000.02-2005.12		-	Platform/Chassis 4x2 D 0836 LF 01/D 0836 LF 03		Center Bearing Support Kit	531058S
	2000.02-2005.12		-	Truck Tractor 4x2 D 0836 LF 01/D 0836 LF 03		Center Bearing Support Kit	531058S
	2003.02-2005.12		-	Platform/Chassis 4x2 D 0836 LF 03		Center Bearing Support Kit	531058S
	2003.02-2005.12		-	Truck Tractor 4x2 D 0836 LF 03		Center Bearing Support Kit	531058S
	2003.02-2005.12		-	Dump Truck 4x2 D 0836 LF 01/D 0836 LF 03		Center Bearing Support Kit	531058S
MAZDA B1600							
1.6 (60 kw)	1985.01-1996.03		Centre	Pick up RWD F650/F691		Center Bearing Support	517682
B2000							
2.0 (65 kw)	1985.01-1994.09		Centre	Pick up RWD FED1/FEHE		Center Bearing Support	517682
B2200							
2.2 (47 kw)	1985.01-1996.03		Centre	Pick up RWD R290		Center Bearing Support	517682
	1988.01-1996.03		Centre	Chassis cabin RWD R290		Center Bearing Support	517682
B2500							
2.5 (57 kw)	1998.09-2006.07		Centre	Pick up 4WD WL81		Center Bearing Support Kit	514806S
	1998.09-2006.07		Centre	Pick up 4WD WL81		Center Bearing Support Kit	517683S
	1999.06-2006.07		Centre	Pick up RWD R587/WL81		Center Bearing Support	532827
	1999.06-2006.07		Centre	Pick up RWD R587/WL81		Center Bearing Support Kit	514806S
	1999.06-2006.07		Centre	Pick up RWD R587/WL81		Center Bearing Support Kit	517683S
2.5 (61 kw)	1999.11-2001.12		Centre	Pick up RWD WL91		Center Bearing Support	532827



	 YEAR	TRANSM.	FITTING POSITION	BODY STYLE & DRIVE TYPE & ENGINE	REMARKS	 PRODUCT	GSP Ref.
MAZDA							
B2500							
2.5 (62 kw)	2002.12-2006.07		Centre	Pick up 4WD WLE7		Center Bearing Support Kit	514806S
	2002.12-2006.07		Centre	Pick up RWD WLE7		Center Bearing Support Kit	514806S
	2002.12-2006.07		Centre	Pick up RWD WLE7		Center Bearing Support Kit	517683S
2.5 (80 kw)	1999.06-2006.07		Centre	Pick up 4WD WL84/WLF1/WLF2		Center Bearing Support Kit	514806S
	1999.06-2006.07		Centre	Pick up 4WD WL84/WLF1/WLF2		Center Bearing Support Kit	517683S
B2600							
2.6 (90 kw)	1988.09-1999.06		Centre	Pick up 4WD G6T1/G6Y3		Center Bearing Support	517682
	1999.02-2002.07		Centre	Pick up 4WD G6T1/R585		Center Bearing Support Kit	517683S
BT-50							
2.6 (92 kw)	2006.10-2015.12	AT/MT	Rear	Pick up AWD G6Y1		Propshaft	PS900583
2.6 (94 kw)	2006.10-2011.11	AT/MT	Rear	Pick up AWD G6Y1		Propshaft	PS900583
4.0 (154 kw)	2006.09-2010.12	AT/MT	Rear	Pick up AWD		Propshaft	PS900583
BT50							
2.2 (88 kw)	2011.11-	6MT	Rear	Pick up RWD P4AT		Propshaft	PS901341
2.2 (110 kw)	2011.11-	6MT	Rear	Pick up RWD P4AT		Propshaft	PS901341
	2011.11-2020.06	6MT	Rear	Platform/Chassis RWD P4AT		Propshaft	PS901341
2.5 (81 kw)	2006.08-2013.06	AT/MT	Rear	Pick up 4WD WLT		Propshaft	PS900583
2.5 (105 kw)	2006.08-2013.06	AT/MT	Rear	Pick up 4WD WLAA		Propshaft	PS900583
	2006.08-2013.06		Centre	Pick up 4WD WLAA		Center Bearing Support Kit	514806S
	2006.08-2013.06		Centre	Pick up RWD WLAA		Center Bearing Support Kit	514806S
2.6 (90 kw)	2006.10-2011.11	AT/MT	Rear	Pick up 4WD G6Y1		Propshaft	PS900583
2.6 (115 kw)	2006.10-2013.06	AT/MT	Rear	Pick up 4WD G6Y1		Propshaft	PS900583
3.0 (115 kw)	2006.10-2013.06	AT/MT	Rear	Pick up 4WD WEA1		Propshaft	PS900583
3.2 (147 kw)	2011.11-	6MT	Rear	Pick up RWD P5AT		Propshaft	PS901341
	2011.11-	6MT	Rear	Chassis cabin RWD P5AT		Propshaft	PS901341
CX7							
2.3 (175 kw)	2006.06-2014.12		Front	SUV 4WD L3K7/L3Y7		Center Bearing Support	514812
	2006.06-2014.12		Front	SUV 4WD L3K7/L3Y7		Center Bearing Support	514814
	2008.10-2013.03		Front	SUV FWD L3Y7		Center Bearing Support	514812
	2008.10-2013.03		Front	SUV FWD L3Y7		Center Bearing Support	514814
2.3 (177 kw)	2006.06-2009.06		Front	SUV FWD L3K7		Center Bearing Support	514812
	2006.06-2009.06		Front	SUV FWD L3K7		Center Bearing Support	514814
2.3 (182 kw)	2007.01-2012.12		Front	SUV 4WD L3Y6		Center Bearing Support	514812
	2007.01-2012.12		Front	SUV 4WD L3Y6		Center Bearing Support	514814
	2007.01-2013.03		Front	SUV FWD L3Y7		Center Bearing Support	514812
	2007.01-2013.03		Front	SUV FWD L3Y7		Center Bearing Support	514814
2.3 (190 kw)	2007.10-2009.08		Front	SUV 4WD L3K4		Center Bearing Support	514812
	2007.10-2009.08		Front	SUV 4WD L3K4		Center Bearing Support	514814
2.3 (191 kw)	2007.01-2013.03		Front	SUV 4WD L3Y6/L3Y7/L3ZA		Center Bearing Support	514812
	2007.01-2013.03		Front	SUV 4WD L3Y6/L3Y7/L3ZA		Center Bearing Support	514814
2.5 (120 kw)	2009.07-2013.03		Front	SUV FWD L5Y7		Center Bearing Support	514812
	2009.07-2013.03		Front	SUV FWD L5Y7		Center Bearing Support	514814
CX9							
3.5 (193 kw)	2007.01-		Front	SUV 4WD CYC4		Center Bearing Support	514810
	2007.01-		Rear	SUV 4WD CYC4		Center Bearing Support	514815
	2007.01-2007.12		Front	SUV FWD CYC4		Center Bearing Support	514810
	2007.01-2007.12		Rear	SUV FWD CYC4		Center Bearing Support	514815
3.7 (204 kw)	2007.01-		Front	SUV 4WD CAY1/CAY5/CAY6		Center Bearing Support	514810
	2007.01-		Rear	SUV 4WD CAY1/CAY5/CAY6		Center Bearing Support	514815
	2008.01-		Front	SUV FWD CAY1/CAY5/CAY6		Center Bearing Support	514810
	2008.01-		Rear	SUV FWD CAY1/CAY5/CAY6		Center Bearing Support	514815
MX5							
1.6 (66 kw)	1990.12-1997.12	MT	Rear	Cabriolet RWD 8AN1		Propshaft	PS900612
1.6 (81 kw)	1998.01-2005.10	MT	Rear	Cabriolet RWD B6MC/B6MU		Propshaft	PS900612
1.8 (96 kw)	1993.01-1998.04	MT	Rear	Cabriolet RWD BPF1		Propshaft	PS900612
1.8 (102 kw)	1998.04-2005.10	MT	Rear	Cabriolet RWD BP6J		Propshaft	PS900612
1.8 (103 kw)	1998.01-2005.10	MT	Rear	Cabriolet RWD BP5A/BP6J		Propshaft	PS900612
	1998.01-2005.10	MT	Rear	Cabriolet RWD BP5A/BP6J	Date To:2002.12	Propshaft	PS900612
1.8 (107 kw)	2000.08-2005.10	MT	Rear	Cabriolet RWD BP6J		Propshaft	PS900612
MERCEDES-BENZ							
190							
1.8 (80 kw)	1990.04-1993.08		Centre	Saloon RWD 102910		Center Bearing Support	510453
	1990.04-1993.08		Front	Saloon RWD 102910		Flexible Coupling	510569
	1990.04-1993.08		Rear	Saloon RWD 102910		Flexible Coupling	510460



	 YEAR	TRANSM.	FITTING POSITION	BODY STYLE & DRIVE TYPE & ENGINE	REMARKS	 PRODUCT	GSP Ref.
MERCEDES-BENZ 190							
1.8 (80 kw)	1990.04-1993.08		Front	Saloon RWD 102910		Flexible Coupling Kit	510570S
	1990.04-1993.08		Rear	Saloon RWD 102910		Flexible Coupling Kit	510459S
2.0 (55 kw)	1988.10-1993.05		Centre	Saloon RWD 601911		Center Bearing Support	510453
	1988.10-1993.05		Front	Saloon RWD 601911		Flexible Coupling	510436
	1988.10-1993.05		Front	Saloon RWD 601911		Flexible Coupling	510569
	1988.10-1993.05		Rear	Saloon RWD 601911		Flexible Coupling	510458
	1988.10-1993.05		Rear	Saloon RWD 601911		Flexible Coupling	510460
	1988.10-1993.05		Front	Saloon RWD 601911		Flexible Coupling Kit	510434S
	1988.10-1993.05		Front	Saloon RWD 601911	for taxis:VIN to:A 495250,F 616914,AT,for taxis	Flexible Coupling Kit	537822S
	1988.10-1993.05		Rear	Saloon RWD 601911		Flexible Coupling Kit	510459S
2.0 (87 kw)	1985.01-1993.08		Centre	Saloon RWD 102962		Center Bearing Support	510453
	1985.01-1993.08		Front	Saloon RWD 102962		Flexible Coupling	510436
	1985.01-1993.08		Front	Saloon RWD 102962		Flexible Coupling	510569
	1985.01-1993.08		Rear	Saloon RWD 102962		Flexible Coupling	510458
	1985.01-1993.08		Rear	Saloon RWD 102962		Flexible Coupling	510460
	1985.01-1993.08		Front	Saloon RWD 102962		Flexible Coupling Kit	510434S
	1985.01-1993.08		Front	Saloon RWD 102962		Flexible Coupling Kit	510570S
	1985.01-1993.08		Rear	Saloon RWD 102962		Flexible Coupling Kit	510459S
2.0 (90 kw)	1982.10-1993.06		Centre	Saloon RWD 102961/102962		Center Bearing Support	510453
	1982.10-1993.06		Front	Saloon RWD 102961/102962		Flexible Coupling	510436
	1982.10-1993.06		Front	Saloon RWD 102961/102962		Flexible Coupling	510569
	1982.10-1993.06		Rear	Saloon RWD 102961/102962		Flexible Coupling	510458
	1982.10-1993.06		Rear	Saloon RWD 102961/102962		Flexible Coupling	510460
	1982.10-1993.06		Front	Saloon RWD 102961/102962		Flexible Coupling Kit	510434S
	1982.10-1993.06		Front	Saloon RWD 102961/102962		Flexible Coupling Kit	510570S
	1982.10-1993.06		Rear	Saloon RWD 102961/102962		Flexible Coupling Kit	510459S
2.3 (100 kw)	1982.10-1993.08		Centre	Saloon RWD 102985		Center Bearing Support	510453
	1982.10-1993.08		Front	Saloon RWD 102985		Flexible Coupling	510436
	1982.10-1993.08		Front	Saloon RWD 102985		Flexible Coupling	510569
	1982.10-1993.08		Front	Saloon RWD 102985		Flexible Coupling Kit	510434S
	1982.10-1993.08		Front	Saloon RWD 102985		Flexible Coupling Kit	510570S
2.5 (66 kw)	1985.04-1993.08		Centre	Saloon RWD 602911		Center Bearing Support	510453
	1985.04-1993.08		Front	Saloon RWD 602911		Flexible Coupling	510436
	1985.04-1993.08		Front	Saloon RWD 602911		Flexible Coupling	510569
	1985.04-1993.08		Rear	Saloon RWD 602911		Flexible Coupling	510458
	1985.04-1993.08		Rear	Saloon RWD 602911		Flexible Coupling	510460
	1985.04-1993.08		Front	Saloon RWD 602911		Flexible Coupling Kit	510434S
	1985.04-1993.08		Rear	Saloon RWD 602911		Flexible Coupling Kit	510459S
2.5 (69 kw)	1984.10-1993.05		Centre	Saloon RWD 602911		Center Bearing Support	510453
	1984.10-1993.05		Front	Saloon RWD 602911		Flexible Coupling	510436
	1984.10-1993.05		Front	Saloon RWD 602911		Flexible Coupling	510569
	1984.10-1993.05		Rear	Saloon RWD 602911		Flexible Coupling	510458
	1984.10-1993.05		Rear	Saloon RWD 602911		Flexible Coupling	510460
	1984.10-1993.05		Front	Saloon RWD 602911		Flexible Coupling Kit	510434S
	1984.10-1993.05		Rear	Saloon RWD 602911		Flexible Coupling Kit	510459S
2.5 (90 kw)	1988.02-1993.08		Front	Saloon RWD 602961		Flexible Coupling	510569
	1988.02-1993.08		Front	Saloon RWD 602961		Flexible Coupling Kit	510570S
2.5 (93 kw)	1987.10-1993.05		Centre	Saloon RWD 602961		Center Bearing Support	510453
	1987.10-1993.05		Front	Saloon RWD 602961		Flexible Coupling	510436
	1987.10-1993.05		Front	Saloon RWD 602961		Flexible Coupling	510569
	1987.10-1993.05		Front	Saloon RWD 602961		Flexible Coupling Kit	510434S
	1987.10-1993.05		Front	Saloon RWD 602961		Flexible Coupling Kit	510570S
2.5 (143 kw)	1987.01-1993.05		Centre	Saloon RWD 102991		Center Bearing Support	510453
	1987.01-1993.05		Front	Saloon RWD 102991		Flexible Coupling Kit	510570S
2.6 (118 kw)	1986.09-1993.08		Centre	Saloon RWD 103942		Center Bearing Support	510453
	1986.09-1993.08		Front	Saloon RWD 103942		Flexible Coupling	510436
	1986.09-1993.08		Front	Saloon RWD 103942		Flexible Coupling	510569
	1986.09-1993.08		Front	Saloon RWD 103942		Flexible Coupling Kit	510434S
	1986.09-1993.08		Front	Saloon RWD 103942		Flexible Coupling Kit	510570S
190E II							
2.5 (173 kw)	1990.05-1993.08		Centre	Saloon RWD M 102.992		Center Bearing Support	510453
	1990.05-1993.08		Front	Saloon RWD M 102.992		Flexible Coupling Kit	510570S



	 YEAR	TRANSM.	FITTING POSITION	BODY STYLE & DRIVE TYPE & ENGINE	REMARKS	 PRODUCT	GSP Ref.
MERCEDES-BENZ							
200							
2.0 (55 kw)	1985.01-1993.06		Front	Saloon RWD 601912		Flexible Coupling	510436
	1985.01-1993.06		Front	Saloon RWD 601912		Flexible Coupling	510569
	1985.01-1993.06		Rear	Saloon RWD 601912		Flexible Coupling	510458
	1985.01-1993.06		Rear	Saloon RWD 601912		Flexible Coupling	510460
	1985.01-1993.06		Front	Saloon RWD 601912		Flexible Coupling Kit	510434S
	1985.01-1993.06		Front	Saloon RWD 601912		Flexible Coupling Kit	510570S
	1985.01-1993.06		Front	Saloon RWD 601912	Date to:1989.09,VIN to:A 982463.AT,for taxis	Flexible Coupling Kit	537822S
2.0 (77 kw)	1986.01-1993.05		Centre	Estate RWD 102922		Center Bearing Support	510511
	1986.01-1993.05		Centre	Saloon RWD 102922		Center Bearing Support	510511
	1986.01-1993.05		Front	Estate RWD 102922		Flexible Coupling	510436
	1986.01-1993.05		Front	Estate RWD 102922		Flexible Coupling	510569
	1986.01-1993.05		Front	Saloon RWD 102922		Flexible Coupling	510569
	1986.01-1993.05		Rear	Estate RWD 102922		Flexible Coupling	510458
	1986.01-1993.05		Rear	Estate RWD 102922		Flexible Coupling	510460
	1986.01-1993.05		Front	Estate RWD 102922		Flexible Coupling Kit	510434S
	1986.01-1993.05		Front	Estate RWD 102922		Flexible Coupling Kit	510570S
	1986.01-1993.05		Front	Saloon RWD 102922		Flexible Coupling Kit	510570S
	1986.01-1993.05		Rear	Estate RWD 102922		Flexible Coupling Kit	510459S
	1986.01-1993.05		Rear	Saloon RWD 102922		Flexible Coupling Kit	510459S
2.0 (87 kw)	1988.09-1992.08		Front	Estate RWD 102963		Flexible Coupling	510436
	1988.09-1992.08		Front	Estate RWD 102963		Flexible Coupling	510569
	1988.09-1992.08		Rear	Estate RWD 102963		Flexible Coupling	510458
	1988.09-1992.08		Rear	Estate RWD 102963		Flexible Coupling	510460
	1988.09-1992.08		Front	Estate RWD 102963		Flexible Coupling Kit	510434S
	1988.09-1992.08		Front	Estate RWD 102963		Flexible Coupling Kit	510570S
	1988.09-1992.08		Rear	Estate RWD 102963		Flexible Coupling Kit	510459S
	1988.09-1993.08		Centre	Saloon RWD 102963		Center Bearing Support	510511
	1988.09-1993.08		Front	Saloon RWD 102963		Flexible Coupling	510436
	1988.09-1993.08		Front	Saloon RWD 102963		Flexible Coupling	510569
	1988.09-1993.08		Rear	Saloon RWD 102963		Flexible Coupling	510460
	1988.09-1993.08		Front	Saloon RWD 102963		Flexible Coupling Kit	510434S
	1988.09-1993.08		Front	Saloon RWD 102963		Flexible Coupling Kit	510570S
	1988.09-1993.08		Rear	Saloon RWD 102963		Flexible Coupling Kit	510459S
	1990.03-1992.12		Centre	Coupe RWD 102963		Center Bearing Support	510511
	1990.03-1992.12		Front	Coupe RWD 102963		Flexible Coupling	510436
	1990.03-1992.12		Front	Coupe RWD 102963		Flexible Coupling	510569
	1990.03-1992.12		Front	Coupe RWD 102963		Flexible Coupling Kit	510434S
	1990.03-1992.12		Front	Coupe RWD 102963		Flexible Coupling Kit	510570S
	2.0 (100 kw)	1992.06-1993.05		Centre	Saloon RWD 111940		Center Bearing Support
1992.06-1993.05			Front	Saloon RWD 111940		Flexible Coupling	510569
1992.06-1993.05			Front	Saloon RWD 111940		Flexible Coupling Kit	510570S
1992.06-1993.06			Centre	Estate RWD 111940		Center Bearing Support	510511
1992.06-1993.06			Front	Estate RWD 111940		Flexible Coupling	510436
1992.06-1993.06			Front	Estate RWD 111940		Flexible Coupling	510569
1992.06-1993.06			Front	Estate RWD 111940		Flexible Coupling Kit	510434S
1992.06-1993.06			Front	Estate RWD 111940		Flexible Coupling Kit	510570S
1992.07-1993.07			Centre	Coupe RWD 111490		Center Bearing Support	510511
1992.07-1993.07			Front	Coupe RWD 111490		Flexible Coupling	510436
1992.07-1993.07			Front	Coupe RWD 111490		Flexible Coupling	510569
1992.07-1993.07			Front	Coupe RWD 111490		Flexible Coupling Kit	510434S
1992.07-1993.07		Front	Coupe RWD 111490		Flexible Coupling Kit	510570S	
208D							
2.3 (58 kw)	1989.09-1995.04		Centre	Chassis cabin RWD 601940		Center Bearing Support	510489
	1989.09-1995.04		Centre	Chassis cabin RWD 601940		Center Bearing Support Kit	518419S
2.3 (60 kw)	1989.06-1996.02		Centre	Chassis cabin RWD 601940		Center Bearing Support Kit	518419S
210							
2.3 (70 kw)	1981.08-1989.08		Centre	VAN RWD 102942		Center Bearing Support Kit	518419S
210D							
2.9 (70 kw)	1989.09-1995.04		Centre	BUS RWD 602940		Center Bearing Support Kit	518419S
	1989.09-1995.04		Centre	Chassis cabin RWD 602940		Center Bearing Support Kit	518419S
	1989.09-1995.04		Centre	VAN RWD 602940		Center Bearing Support Kit	518419S



	 YEAR	TRANSM.	FITTING POSITION	BODY STYLE & DRIVE TYPE & ENGINE	REMARKS	 PRODUCT	GSP Ref.
MERCEDES-BENZ							
210D							
2.9 (72 kw)	1988.11-1996.02		Centre	BUS RWD 602940		Center Bearing Support Kit	518419S
	1988.11-1996.02		Centre	Chassis cabin RWD 602940		Center Bearing Support Kit	518419S
220							
2.2 (110 kw)	1992.06-1993.05		Centre	Estate RWD 111960		Center Bearing Support	510511
	1992.06-1993.05		Front	Estate RWD 111960		Flexible Coupling	510436
	1992.06-1993.05		Front	Estate RWD 111960		Flexible Coupling	510569
	1992.06-1993.05		Front	Estate RWD 111960		Flexible Coupling Kit	510434S
	1992.06-1993.05		Front	Estate RWD 111960		Flexible Coupling Kit	510570S
	1992.08-1993.06		Centre	Saloon RWD 111960		Center Bearing Support	510511
	1992.08-1993.06		Front	Saloon RWD 111960		Flexible Coupling	510436
	1992.08-1993.06		Front	Saloon RWD 111960		Flexible Coupling	510569
	1992.08-1993.06		Front	Saloon RWD 111960		Flexible Coupling Kit	510434S
	1992.08-1993.06		Front	Saloon RWD 111960		Flexible Coupling Kit	510570S
	1992.10-1993.08		Centre	Coupe RWD 111960		Center Bearing Support	510511
	1992.10-1993.08		Front	Coupe RWD 111960		Flexible Coupling	510436
	1992.10-1993.08		Front	Coupe RWD 111960		Flexible Coupling	510569
	1992.10-1993.08		Front	Coupe RWD 111960		Flexible Coupling Kit	510434S
	1992.10-1993.08		Front	Coupe RWD 111960		Flexible Coupling Kit	510570S
230							
2.3 (97 kw)	1984.12-1993.06		Front	Saloon RWD 102982		Flexible Coupling	510436
	1984.12-1993.06		Front	Saloon RWD 102982		Flexible Coupling	510569
	1984.12-1993.06		Front	Saloon RWD 102982		Flexible Coupling Kit	510434S
	1984.12-1993.06		Front	Saloon RWD 102982		Flexible Coupling Kit	510570S
	1985.09-1992.08		Front	Estate RWD 102982		Flexible Coupling	510436
	1985.09-1992.08		Front	Estate RWD 102982		Flexible Coupling	510569
	1985.09-1992.08		Front	Estate RWD 102982		Flexible Coupling Kit	510434S
	1985.09-1992.08		Front	Estate RWD 102982		Flexible Coupling Kit	510570S
	1986.09-1992.12		Front	Coupe RWD 102982		Flexible Coupling	510436
	1986.09-1992.12		Front	Coupe RWD 102982		Flexible Coupling	510569
	1986.09-1992.12		Front	Coupe RWD 102982		Flexible Coupling Kit	510434S
	1986.09-1992.12		Front	Coupe RWD 102982		Flexible Coupling Kit	510570S
2.3 (100 kw)	1985.01-1993.06		Centre	Saloon RWD 102982		Center Bearing Support	510511
	1985.01-1993.06		Front	Saloon RWD 102982		Flexible Coupling	510436
	1985.01-1993.06		Front	Saloon RWD 102982		Flexible Coupling	510569
	1985.01-1993.06		Front	Saloon RWD 102982		Flexible Coupling Kit	510434S
	1985.01-1993.06		Front	Saloon RWD 102982		Flexible Coupling Kit	510570S
	1985.09-1992.08		Centre	Estate RWD 102982		Center Bearing Support	510511
	1985.09-1992.08		Front	Estate RWD 102982		Flexible Coupling	510436
	1985.09-1992.08		Front	Estate RWD 102982		Flexible Coupling	510569
	1985.09-1992.08		Front	Estate RWD 102982		Flexible Coupling Kit	510434S
	1985.09-1992.08		Front	Estate RWD 102982		Flexible Coupling Kit	510570S
	1987.03-1992.12		Centre	Coupe RWD 102982		Center Bearing Support	510511
	1987.03-1992.12		Front	Coupe RWD 102982		Flexible Coupling	510436
	1987.03-1992.12		Front	Coupe RWD 102982		Flexible Coupling	510569
	1987.03-1992.12		Front	Coupe RWD 102982		Flexible Coupling Kit	510434S
	1987.03-1992.12		Front	Coupe RWD 102982		Flexible Coupling Kit	510570S
230GE							
2.3 (93 kw)	1990.06-1993.06		-	Terrain cab wagon closed 4WD 102989		Propshaft	PS900554
250							
2.5 (66 kw)	1985.03-1993.05		Front	Saloon RWD 602912		Flexible Coupling	510436
	1985.03-1993.05		Front	Saloon RWD 602912		Flexible Coupling	510569
	1985.03-1993.05		Rear	Saloon RWD 602912		Flexible Coupling	510458
	1985.03-1993.05		Rear	Saloon RWD 602912		Flexible Coupling	510460
	1985.03-1993.05		Front	Saloon RWD 602912		Flexible Coupling Kit	510434S
	1985.03-1993.05		Front	Saloon RWD 602912		Flexible Coupling Kit	510570S
	1985.03-1993.05		Rear	Saloon RWD 602912		Flexible Coupling Kit	510459S
	1985.09-1993.06		Centre	Estate RWD 602912		Center Bearing Support	510511
	1985.09-1993.06		Front	Estate RWD 602912		Flexible Coupling	510436
	1985.09-1993.06		Front	Estate RWD 602912		Flexible Coupling	510569
	1985.09-1993.06		Rear	Estate RWD 602912		Flexible Coupling	510458
	1985.09-1993.06		Rear	Estate RWD 602912		Flexible Coupling	510460
	1985.09-1993.06		Front	Estate RWD 602912		Flexible Coupling Kit	510434S
	1985.09-1993.06		Front	Estate RWD 602912		Flexible Coupling Kit	510570S
	1985.09-1993.06		Rear	Estate RWD 602912		Flexible Coupling Kit	510459S



	 YEAR	TRANSM.	FITTING POSITION	BODY STYLE & DRIVE TYPE & ENGINE	REMARKS	 PRODUCT	GSP Ref.	
MERCEDES-BENZ								
250								
2.5 (69 kw)	1985.03-1993.06		Centre	Saloon RWD 602912		Center Bearing Support	510511	
	1985.03-1993.06		Front	Saloon RWD 602912		Flexible Coupling	510436	
	1985.03-1993.06		Front	Saloon RWD 602912		Flexible Coupling	510569	
	1985.03-1993.06		Rear	Saloon RWD 602912		Flexible Coupling	510458	
	1985.03-1993.06		Rear	Saloon RWD 602912		Flexible Coupling	510460	
	1985.03-1993.06		Front	Saloon RWD 602912		Flexible Coupling Kit	510434S	
	1985.03-1993.06		Front	Saloon RWD 602912		Flexible Coupling Kit	510570S	
	1985.03-1993.06		Rear	Saloon RWD 602912		Flexible Coupling Kit	510459S	
	1986.01-1993.06		Centre	Estate RWD 602912		Center Bearing Support	510511	
	1986.01-1993.06		Front	Estate RWD 602912		Flexible Coupling	510436	
	1986.01-1993.06		Front	Estate RWD 602912		Flexible Coupling	510569	
	1986.01-1993.06		Rear	Estate RWD 602912		Flexible Coupling	510458	
	1986.01-1993.06		Rear	Estate RWD 602912		Flexible Coupling	510460	
	1986.01-1993.06		Front	Estate RWD 602912		Flexible Coupling Kit	510434S	
	1986.01-1993.06		Front	Estate RWD 602912		Flexible Coupling Kit	510570S	
	1986.01-1993.06		Rear	Estate RWD 602912		Flexible Coupling Kit	510459S	
	2.5 (93 kw)	1985.03-1993.05		Centre	Saloon RWD 602962		Center Bearing Support	511574
		1985.03-1993.05		Front	Saloon RWD 602962		Flexible Coupling	510436
1985.03-1993.05			Front	Saloon RWD 602962		Flexible Coupling	510569	
1985.03-1993.05			Front	Saloon RWD 602962		Flexible Coupling Kit	510434S	
1985.03-1993.05			Front	Saloon RWD 602962		Flexible Coupling Kit	510570S	
1989.09-1993.05			Centre	Estate RWD 602962		Center Bearing Support	511574	
1989.09-1993.05			Front	Estate RWD 602962		Flexible Coupling	510436	
1989.09-1993.05			Front	Estate RWD 602962		Flexible Coupling	510569	
1989.09-1993.05			Front	Estate RWD 602962		Flexible Coupling Kit	510434S	
1989.09-1993.05			Front	Estate RWD 602962		Flexible Coupling Kit	510570S	
250GD								
2.5 (69 kw)	1990.06-1996.07	-		Terrain cab wagon closed 4WD 602931		Propshaft	PS900554	
260								
2.6 (118 kw)	1985.03-1993.05		Centre	Saloon 4WD 103943		Center Bearing Support	511574	
	1985.03-1993.05		Front	Saloon 4WD 103943		Flexible Coupling	510436	
	1985.03-1993.05		Front	Saloon 4WD 103943		Flexible Coupling	510569	
	1985.03-1993.05		Front	Saloon 4WD 103943		Flexible Coupling Kit	510434S	
	1985.03-1993.05		Front	Saloon 4WD 103943		Flexible Coupling Kit	510570S	
	1985.03-1993.05		Rear	Saloon 4WD 103943		Flexible Coupling Kit	510459S	
	1985.09-1992.08		Centre	Saloon RWD 103940		Center Bearing Support	510511	
	1985.09-1992.08		Front	Saloon RWD 103940		Flexible Coupling	510436	
	1985.09-1992.08		Front	Saloon RWD 103940		Flexible Coupling	510569	
	1985.09-1992.08		Front	Saloon RWD 103940		Flexible Coupling Kit	510434S	
	1985.09-1992.08		Front	Saloon RWD 103940		Flexible Coupling Kit	510570S	
	280							
2.8 (145 kw)	1992.06-1993.06		Centre	Estate RWD 104942		Center Bearing Support	511574	
	1992.06-1993.06		Front	Estate RWD 104942		Flexible Coupling	510571	
	1992.06-1993.06		Front;Rear	Estate RWD 104942		Flexible Coupling	510579	
	1992.06-1993.06		Front	Estate RWD 104942	AT	Flexible Coupling Kit	510580S	
	1992.06-1993.06		Front	Estate RWD 104942	MT	Flexible Coupling Kit	537854S	
	1992.10-1993.06		Centre	Saloon RWD 104942		Center Bearing Support	511574	
	1992.10-1993.06		Front;Rear	Saloon RWD 104942		Flexible Coupling	510579	
300								
2.8 (145 kw)	1993.01-1998.10		Front	Saloon RWD 104944		Flexible Coupling	510571	
	1993.01-1998.10		Front;Rear	Saloon RWD 104944		Flexible Coupling	510579	
	1993.01-1998.10		Front	Saloon RWD 104944		Flexible Coupling Kit	510571S	
	1993.01-1998.10		Front	Saloon RWD 104944	VIN from:A 142735;MT	Flexible Coupling Kit	510580S	
3.0 (80 kw)	1993.01-1998.10		Front	Saloon RWD 104944	VIN to:A 142734,MT,for left-hand drive vehicles	Flexible Coupling Kit	537854S	
	1986.09-1992.08		Front	Saloon 4WD 603913		Flexible Coupling	510436	
	1986.09-1992.08		Front	Saloon 4WD 603913		Flexible Coupling	510569	
	1986.09-1992.08		Rear	Saloon 4WD 603913		Flexible Coupling	510460	
	1986.09-1992.08		Front	Saloon 4WD 603913		Flexible Coupling Kit	510434S	
	1986.09-1992.08		Front	Saloon 4WD 603913		Flexible Coupling Kit	510570S	
	1986.09-1992.08		Rear	Saloon 4WD 603913		Flexible Coupling Kit	510459S	
	1986.09-1993.05		Centre	Estate RWD 603912		Center Bearing Support	511574	
	1986.09-1993.05		Front	Estate RWD 603912		Flexible Coupling	510436	
	1986.09-1993.05		Front	Estate RWD 603912		Flexible Coupling Kit	510434S	
1986.09-1993.05		Front	Estate RWD 603912		Flexible Coupling Kit	510570S		



	 YEAR	TRANSM.	FITTING POSITION	BODY STYLE & DRIVE TYPE & ENGINE	REMARKS	 PRODUCT	GSP Ref.	
MERCEDES-BENZ 300								
3.0 (81 kw)	1990.06-1993.06		Front	Saloon RWD 603912		Flexible Coupling	510569	
	1990.06-1993.06		Front	Saloon RWD 603912		Flexible Coupling Kit	510570S	
3.0 (83 kw)	1989.01-1993.06		Centre	Estate RWD 603912		Center Bearing Support	511574	
	1989.01-1993.06		Front	Estate RWD 603912		Flexible Coupling	510436	
	1989.01-1993.06		Front	Estate RWD 603912		Flexible Coupling	510569	
	1989.01-1993.06		Front	Estate RWD 603912		Flexible Coupling Kit	510434S	
	1989.01-1993.06		Front	Estate RWD 603912		Flexible Coupling Kit	510570S	
	1989.08-1993.06		Centre	Saloon 4WD 603913		Center Bearing Support	511574	
	1989.08-1993.06		Centre	Saloon RWD 603912		Center Bearing Support	511574	
	1989.08-1993.06		Front	Saloon 4WD 603913		Flexible Coupling	510436	
	1989.08-1993.06		Front	Saloon RWD 603912		Flexible Coupling	510436	
	1989.08-1993.06		Front	Saloon 4WD 603913		Flexible Coupling	510569	
	1989.08-1993.06		Front	Saloon RWD 603912		Flexible Coupling	510569	
	1989.08-1993.06		Rear	Saloon 4WD 603913		Flexible Coupling	510460	
	1989.08-1993.06		Front	Saloon 4WD 603913		Flexible Coupling Kit	510434S	
	1989.08-1993.06		Front	Saloon RWD 603912		Flexible Coupling Kit	510434S	
3.0 (108 kw)	1988.01-1993.06		Centre	Saloon RWD 603960		Center Bearing Support	511574	
	1988.01-1993.06		Rear	Saloon RWD 603960		Flexible Coupling	510575	
	1988.01-1993.06		Rear	Saloon RWD 603960		Flexible Coupling Kit	510576S	
	1989.01-1993.06		Centre	Estate RWD 603960		Center Bearing Support	511574	
	1989.01-1993.06		Rear	Estate RWD 603960		Flexible Coupling	510575	
	1989.01-1993.06		Rear	Estate RWD 603960		Flexible Coupling Kit	510576S	
	1989.09-1993.05		Centre	Saloon 4WD 603963		Center Bearing Support	511574	
	1989.09-1993.05		Rear	Saloon 4WD 603963		Flexible Coupling	510460	
	1989.09-1993.05		Rear	Saloon 4WD 603963		Flexible Coupling	510575	
	1989.09-1993.05		Rear	Saloon 4WD 603963		Flexible Coupling Kit	510459S	
	1989.09-1993.05		Rear	Saloon 4WD 603963		Flexible Coupling Kit	510576S	
	3.0 (132 kw)	1985.08-1992.08		Centre	Saloon RWD 103983		Center Bearing Support	511574
		1985.08-1992.08		Front	Saloon RWD 103983	Date from:1989.09;VIN to:F 204957;AT	Flexible Coupling	510436
		1985.08-1992.08		Front	Saloon RWD 103983	Date from:1989.09,MT	Flexible Coupling	510569
1985.08-1992.08			Front	Saloon RWD 103983	Date from:1989.09;VIN from:B 233930;AT	Flexible Coupling	510571	
1985.08-1992.08			Front	Saloon RWD 103983		Flexible Coupling Kit	510434S	
1985.08-1992.08			Front	Saloon RWD 103983		Flexible Coupling Kit	510570S	
1986.01-1992.08			Centre	Estate RWD 103983		Center Bearing Support	511574	
1986.01-1992.08			Front	Estate RWD 103983	Date from:1989.09;VIN to:F 143372;AT	Flexible Coupling	510436	
1986.01-1992.08			Front	Estate RWD 103983	Date from:1989.09,MT	Flexible Coupling	510569	
1986.01-1992.08			Front	Estate RWD 103983	Date from:1989.09;VIN from:F 143373;AT	Flexible Coupling	510571	
1986.01-1992.08			Front	Estate RWD 103983		Flexible Coupling Kit	510434S	
1986.01-1992.08			Front	Estate RWD 103983		Flexible Coupling Kit	510570S	
1986.09-1993.05			Centre	Saloon 4WD 103985		Center Bearing Support	511574	
1986.09-1993.05			Front	Saloon 4WD 103985		Flexible Coupling	510569	
1986.09-1993.05			Front	Saloon 4WD 103985		Flexible Coupling Kit	510570S	
1986.09-1993.05			Rear	Saloon 4WD 103985		Flexible Coupling Kit	510459S	
1986.09-1993.06			Centre	Estate 4WD 103985		Center Bearing Support	511574	
1986.09-1993.06			Front	Estate 4WD 103985		Flexible Coupling	510436	
1986.09-1993.06			Front	Estate 4WD 103985		Flexible Coupling	510569	
1986.09-1993.06			Rear	Estate 4WD 103985		Flexible Coupling	510460	
1986.09-1993.06			Front	Estate 4WD 103985		Flexible Coupling Kit	510434S	
1986.09-1993.06			Front	Estate 4WD 103985		Flexible Coupling Kit	510570S	
1986.09-1993.06			Rear	Estate 4WD 103985		Flexible Coupling Kit	510459S	
1987.04-1993.05			Centre	Coupe RWD 103983		Center Bearing Support	511574	
1987.04-1993.05			Front	Coupe RWD 103983	Date from:1989.09;VIN to:B 233929;AT	Flexible Coupling	510436	
1987.04-1993.05			Front	Coupe RWD 103983	Date from:1989.09,MT	Flexible Coupling	510569	
1987.04-1993.05			Front	Coupe RWD 103983	Date from:1989.09;VIN from:B 233930;AT	Flexible Coupling	510571	
1987.04-1993.05			Front	Coupe RWD 103983		Flexible Coupling Kit	510434S	
1987.04-1993.05		Front	Coupe RWD 103983		Flexible Coupling Kit	510570S		
3.0 (138 kw)	1985.01-1992.08		Centre	Saloon RWD 103980/103983		Center Bearing Support	511574	
	1985.01-1992.08		Front	Saloon RWD 103980/103983		Flexible Coupling	510436	
	1985.01-1992.08		Front	Saloon RWD 103980/103983		Flexible Coupling	510569	
	1985.01-1992.08		Front	Saloon RWD 103980/103983		Flexible Coupling Kit	510434S	
	1985.01-1992.08		Front	Saloon RWD 103980/103983		Flexible Coupling Kit	510570S	



	 YEAR	TRANSM.	FITTING POSITION	BODY STYLE & DRIVE TYPE & ENGINE	REMARKS	 PRODUCT	GSP Ref.
MERCEDES-BENZ							
300							
3.0 (138 kw)	1987.03-1992.12		Front	Coupe RWD 103983		Flexible Coupling	510436
	1987.03-1992.12		Front	Coupe RWD 103983		Flexible Coupling	510569
	1987.03-1992.12		Front	Coupe RWD 103983		Flexible Coupling Kit	510434S
	1987.03-1992.12		Front	Coupe RWD 103983		Flexible Coupling Kit	510570S
3.0 (140 kw)	1989.09-1993.05		Front	Cabriolet RWD 103984		Flexible Coupling	510569
	1989.09-1993.05		Front;Rear	Cabriolet RWD 103984		Flexible Coupling	510579
	1989.09-1993.05		Front	Cabriolet RWD 103984		Flexible Coupling Kit	510570S
3.0 (162 kw)	1988.09-1992.08		Front;Rear	Saloon RWD 104980		Flexible Coupling	510579
	1989.08-1993.05		Centre	Coupe RWD 104980		Center Bearing Support	511574
	1989.08-1993.05		Front;Rear	Coupe RWD 104980		Flexible Coupling	510579
	1989.09-1993.05		Centre	Estate RWD 104980		Center Bearing Support	511574
	1989.09-1993.05		Front;Rear	Estate RWD 104980		Flexible Coupling	510579
	1989.09-1993.05		Front	Estate RWD 104980		Flexible Coupling Kit	510580S
	1992.04-1993.06		Centre	Cabriolet RWD 104980		Center Bearing Support	511574
	1992.04-1993.06		Front;Rear	Cabriolet RWD 104980		Flexible Coupling	510579
3.0 (170 kw)	1989.08-1992.12		Centre	Coupe RWD 104980		Center Bearing Support	511574
	1989.08-1992.12		Front;Rear	Coupe RWD 104980		Flexible Coupling	510579
	1989.09-1993.05		Front;Rear	Cabriolet RWD 104981		Flexible Coupling	510579
	1992.04-1993.06		Centre	Cabriolet RWD 104980		Center Bearing Support	511574
	1992.04-1993.06		Front;Rear	Cabriolet RWD 104980		Flexible Coupling	510579
3.2 (170 kw)	1991.06-1993.05		Front;Rear	Saloon RWD 104990	VIN from:A 328811	Flexible Coupling	510571
	1991.06-1993.05		Front;Rear	Saloon RWD 104990		Flexible Coupling	510579
	1991.06-1993.05		Front	Saloon RWD 104990		Flexible Coupling Kit	510571S
	1991.06-1993.05		Front	Saloon RWD 104990		Flexible Coupling Kit	510580S
300GD							
3.0 (83 kw)	1989.09-1993.08	AT	Front	Terrain cab wagon closed 4WD 603931		Propshaft	202067
	1989.09-1993.08	MT	Front	Terrain cab wagon closed 4WD 603931		Propshaft	202065
	1989.09-1993.08		Rear	Terrain cab wagon closed 4WD 603931		Propshaft	PS900554
300GE							
3.0 (125 kw)	1989.08-1993.08		-	Terrain cab wagon closed 4WD 103987		Propshaft	PS900554
3.0 (128 kw)	1990.06-1997.08		-	Terrain cab wagon closed 4WD 103987		Propshaft	PS900554
308D							
2.3 (58 kw)	1989.06-1996.02		Centre	Chassis cabin RWD 601940		Center Bearing Support Kit	518419S
2.3 (60 kw)	1981.08-1995.04		Centre	Chassis cabin RWD 601940		Center Bearing Support Kit	518419S
	1988.08-1995.04		Centre	BUS RWD 601940		Center Bearing Support Kit	518419S
310							
2.3 (70 kw)	1981.08-1989.08		Centre	Chassis cabin RWD 102942		Center Bearing Support Kit	518419S
310D							
2.9 (70 kw)	1989.09-1995.04		Centre	Chassis cabin RWD 602940		Center Bearing Support Kit	518419S
2.9 (72 kw)	1989.06-1996.02		Centre	Chassis cabin RWD 602940		Center Bearing Support Kit	518419S
320							
3.2 (162 kw)	1991.08-1993.06		Centre	Coupe RWD 104992		Center Bearing Support	511574
	1991.08-1993.06		Front;Rear	Coupe RWD 104992		Flexible Coupling	510579
	1992.08-1993.05		Centre	Saloon RWD 104992		Center Bearing Support	511574
	1992.08-1993.05		Centre	Estate RWD 104992		Center Bearing Support	511574
	1992.08-1993.05		Front;Rear	Saloon RWD 104992		Flexible Coupling	510579
	1992.08-1993.05		Front;Rear	Estate RWD 104992		Flexible Coupling	510579
350							
3.5 (225 kw)	2015.11-2018.10		Front;Rear	SUV AWD M 276.955		Flexible Coupling Kit	512673S
350GD							
3.4 (100 kw)	1991.09-1996.08		Front	Terrain cab wagon closed 4WD 603972		Propshaft	202067
	1991.09-1996.08		Rear	Terrain cab wagon closed 4WD 603972		Propshaft	PS900554
400							
4.2 (205 kw)	1992.10-1993.06		Centre	Saloon RWD 119975		Center Bearing Support	510511
	1992.10-1993.06		Front	Saloon RWD 119975		Flexible Coupling	512676
	1992.10-1993.06		Front	Saloon RWD 119975		Flexible Coupling Kit	512671S
4.2 (210 kw)	1991.05-1993.05		Front	Saloon RWD 119971		Flexible Coupling	512676
	1991.05-1993.05		Front;Rear	Saloon RWD 119971		Flexible Coupling	512677
	1991.05-1993.05		Front	Saloon RWD 119971		Flexible Coupling Kit	512671S
	1991.05-1993.05		Rear	Saloon RWD 119971		Flexible Coupling Kit	537889S
410							
2.3 (70 kw)	1982.04-1989.07		Centre	Chassis cabin RWD 102942		Center Bearing Support Kit	518419S
2.3 (77 kw)	1982.08-1995.06		Centre	VAN RWD 102945		Center Bearing Support Kit	518419S



	 YEAR	TRANSM.	FITTING POSITION	BODY STYLE & DRIVE TYPE & ENGINE	REMARKS	 PRODUCT	GSP Ref.
MERCEDES-BENZ							
410D							
2.9 (70 kw)	1988.11-1995.06		Centre	Chassis cabin RWD 602940		Center Bearing Support Kit	518419S
	1988.11-1995.06		Centre	VAN RWD 602940		Center Bearing Support Kit	518419S
420							
4.2 (170 kw)	1986.09-1993.05		Rear	Coupe RWD 116965		Flexible Coupling	510575
	1986.09-1993.05		Rear	Coupe RWD 116965		Flexible Coupling Kit	510576S
500							
4.7 (300 kw)	2015.04-2018.10		Front	SUV AWD M 278.928		Propshaft	PS900345
5.0 (164 kw)	1985.10-1993.05		Centre	Coupe RWD 117965		Center Bearing Support	511574
	1985.10-1993.05		Rear	Coupe RWD 117965		Flexible Coupling	510575
	1985.10-1993.05		Rear	Coupe RWD 117965		Flexible Coupling Kit	510576S
5.0 (235 kw)	1991.06-1993.05		Centre	Saloon RWD 119970		Center Bearing Support	530178
	1991.06-1993.05		Front	Saloon RWD 119970		Flexible Coupling	512676
	1991.06-1993.05		Front;Rear	Saloon RWD 119970		Flexible Coupling	512677
	1991.06-1993.05		Front	Saloon RWD 119970		Flexible Coupling Kit	512671S
	1991.06-1993.05		Rear	Saloon RWD 119970		Flexible Coupling Kit	512672S
5.0 (240 kw)	1989.09-1993.05		Front	Cabriolet RWD 119960		Flexible Coupling	512676
	1989.09-1993.05		Front	Cabriolet RWD 119960		Flexible Coupling Kit	512671S
	1991.01-1993.06		Front	Saloon RWD 119974		Flexible Coupling	512676
	1991.01-1993.06		Front	Saloon RWD 119974		Flexible Coupling Kit	512671S
500GE							
5.0 (177 kw)	1993.09-1994.12		-	Terrain cab wagon closed 4WD 117965		Propshaft	PS900554
600							
6.0 (290 kw)	1991.08-1993.05		Front	Cabriolet RWD 120983		Flexible Coupling	512676
	1991.08-1993.05		Front	Cabriolet RWD 120983		Flexible Coupling Kit	512671S
6.0 (300 kw)	1991.05-1993.12		Front	Saloon RWD 120980		Flexible Coupling	512676
	1991.05-1993.12		Front	Saloon RWD 120980		Flexible Coupling Kit	512671S
A160							
1.5 (66 kw)	2013.06-2018.05		Front	Hatchback FWD 607951		Flexible Coupling Kit	537796S
1.6 (75 kw)	2015.07-2018.05		Front	Hatchback FWD 270910		Flexible Coupling Kit	537796S
A180							
1.5 (80 kw)	2012.06-2018.05		Front	Hatchback FWD 607951		Flexible Coupling Kit	537796S
1.6 (90 kw)	2012.09-2018.05		Front	Hatchback FWD 270910		Flexible Coupling Kit	537796S
1.8 (80 kw)	2012.06-2014.10		Front	Hatchback FWD 651901		Flexible Coupling Kit	537796S
2.2 (80 kw)	2013.06-2014.10		Front	Hatchback FWD OM 651.930		Flexible Coupling Kit	537796S
A200							
1.6 (115 kw)	2012.06-2018.05		Front	Hatchback FWD 270910		Flexible Coupling Kit	537796S
	2015.06-2018.05		Front	Hatchback FWD M 270.910		Flexible Coupling Kit	537796S
1.8 (100 kw)	2012.06-2014.10		Front	Hatchback FWD 651901		Flexible Coupling Kit	537796S
2.2 (100 kw)	2014.02-2018.05	AT/MT	Rear	Hatchback 4WD 651930		Propshaft	PS900347
	2014.02-2018.05		Rear	Hatchback 4WD 651930		Flexible Coupling	537818
	2014.02-2018.05		Front	Hatchback 4WD 651930		Flexible Coupling Kit	537796S
	2014.02-2018.05		Front	Hatchback FWD 651930		Flexible Coupling Kit	537796S
A220							
2.0 (135 kw)	2014.05-2018.05	AT/MT	Rear	Hatchback 4WD 270920		Propshaft	PS900347
	2014.05-2018.05		Rear	Hatchback 4WD 270920		Flexible Coupling	537818
	2014.05-2018.05		Front	Hatchback 4WD 270920		Flexible Coupling Kit	537796S
2.2 (120 kw)	2014.01-2018.05		Front	Hatchback FWD 651930		Flexible Coupling Kit	537796S
2.2 (125 kw)	2012.06-2018.05		Front	Hatchback FWD 651930		Flexible Coupling Kit	537796S
	2014.02-2018.05	AT/MT	Rear	Hatchback 4WD 651930		Propshaft	PS900347
	2014.02-2018.05		Rear	Hatchback 4WD 651930		Flexible Coupling	537818
	2014.02-2018.05		Front	Hatchback 4WD 651930		Flexible Coupling Kit	537796S
2.2 (130 kw)	2015.07-2018.05	AT/MT	Rear	Hatchback 4WD 651930		Propshaft	PS900347
	2015.07-2018.05		Rear	Hatchback 4WD 651930		Flexible Coupling	537818
	2015.07-2018.05		Front	Hatchback 4WD 651930		Flexible Coupling Kit	537796S
	2015.07-2018.05		Front	Hatchback FWD 651930		Flexible Coupling Kit	537796S
A250							
2.0 (155 kw)	2012.06-2018.05		Front	Hatchback FWD 270920		Flexible Coupling Kit	537796S
	2013.06-2018.05	AT/MT	Rear	Hatchback 4WD 270920		Propshaft	PS900347
	2013.06-2018.05		Rear	Hatchback 4WD 270920		Flexible Coupling	537818
	2013.06-2018.05		Front	Hatchback 4WD 270920		Flexible Coupling Kit	537796S
2.0 (160 kw)	2015.07-2018.05	AT/MT	Rear	Hatchback 4WD 270920		Propshaft	PS900347
	2015.07-2018.05		Rear	Hatchback 4WD 270920		Flexible Coupling	537818
	2015.07-2018.05		Front	Hatchback FWD 270920		Flexible Coupling Kit	537796S
	2015.07-2018.05		Front	Hatchback 4WD 270920		Flexible Coupling Kit	537796S



	 YEAR	TRANSM.	FITTING POSITION	BODY STYLE & DRIVE TYPE & ENGINE	REMARKS	 PRODUCT	GSP Ref.
MERCEDES-BENZ							
A45 AMG							
2.0 (265 kw)	2013.04-2018.05		Front	Hatchback 4WD 133980		Flexible Coupling Kit	537796S
2.0 (280 kw)	2015.07-2018.05		Front	Hatchback 4WD 133980		Flexible Coupling Kit	537796S
AMG GT 43							
3.0 (270 kw)	2018.10-		Front;Rear	Coupe RWD 256930		Flexible Coupling	537851
Atego							
4.249 (90 kw)	1998.01-2004.10		Front;Rear	Platform/Chassis 4x2 OM 904.909		Center Bearing Support	531056
4.249 (100 kw)	1998.01-2004.10		Front;Rear	Platform/Chassis 4x2 OM 904.910/OM 904.916		Center Bearing Support	531056
	1998.01-2004.10		Front;Rear	Platform/Chassis 4x2 OM 904.910/OM 904.916/OM 904.930		Center Bearing Support	531056
4.249 (112 kw)	1998.01-2004.10		Front;Rear	Platform/Chassis 4x2 OM 904.922		Center Bearing Support	531056
4.249 (125 kw)	1998.01-2004.10		Front;Rear	Platform/Chassis 4x2 OM 904.911/OM 904.917		Center Bearing Support	531056
6.374 (170 kw)	1998.01-2004.10		Front;Rear	Platform/Chassis 4x2 OM 906.910/101.98-/OM 906.915/101.98-/		Center Bearing Support	531056
	1998.01-2004.10		Front;Rear	Platform/Chassis 4x2 OM 906.910/101.98-/		Center Bearing Support	531056
6.374 (205 kw)	1998.01-2004.10		Front;Rear	Platform/Chassis 4x2 OM 906.911/101.98-/OM 906.916/101.98-/		Center Bearing Support	531056
Atego 2							
4.249 (90-95 kw)	2004.10-		Front;Rear	Platform/Chassis 4x2 OM 900.911/OM 900.911/02.06-/OM 904.908/OM 904.915		Center Bearing Support	531056
	2004.10-		Front;Rear	Platform/Chassis 4x2 OM 900.911/02.06-/OM 900.917/02.06-/OM 904.909		Center Bearing Support	531056
4.249 (112 kw)	2004.10-		Front;Rear	Platform/Chassis 4x2 OM 904.922		Center Bearing Support	531056
4.249 (112-115 kw)	2004.10-		Front;Rear	Platform/Chassis 4x2 OM 900.912/OM 904.922		Center Bearing Support	531056
	2004.10-		Front;Rear	Platform/Chassis 4x2 OM 900.912/02.06-/OM 900.918/02.06-/OM 904.922		Center Bearing Support	531056
4.249 (115 kw)	2004.10-		Front;Rear	Platform/Chassis 4x2 OM 900.912/OM 900.918		Center Bearing Support	531056
	2004.10-		Front;Rear	Platform/Chassis 4x2 OM 900.912		Center Bearing Support	531056
4.249 (130 kw)	2004.10-		Front;Rear	Platform/Chassis 4x2 OM 900.913/OM 900.919		Center Bearing Support	531056
	2004.10-		Front;Rear	Platform/Chassis 4x2 OM 900.913		Center Bearing Support	531056
	2004.10-		Front;Rear	Platform/Chassis 4x2 OM 900.913/02.06-/OM 900.919/02.06-/		Center Bearing Support	531056
	2004.10-		Front;Rear	Platform/Chassis 4x2 OM 900.913/OM 900.919/02.06-/		Center Bearing Support	531056
4.801 (115 kw)	2004.10-		Front;Rear	Platform/Chassis 4x2 OM 924.935		Center Bearing Support	531056
4.801 (160 kw)	2004.10-		Front;Rear	Platform/Chassis 4x2 OM 924.920/10.04-/OM 924.922/OM 924.930		Center Bearing Support	531056
6.374 (170-175 kw)	2004.10-		Front;Rear	Platform/Chassis 4x2 OM 902.919/10.04-/OM 906.916/10.04-/		Center Bearing Support	531056
6.374 (188 kw)	2004.10-		Front;Rear	Platform/Chassis 4x2 OM 902.917/10.04-/		Center Bearing Support	531056
6.374 (205-210 kw)	2004.10-		Front;Rear	Platform/Chassis 4x2 OM 902.918/10.04-/OM 906.916/10.04-/		Center Bearing Support	531056
7.201 (175 kw)	2004.10-		Front;Rear	Platform/Chassis 4x2 OM 925.920		Center Bearing Support	531056
7.201 (188 kw)	2004.10-2014.12		Front;Rear	Platform/Chassis 4x2 OM 925.920		Center Bearing Support	531056
7.201 (210 kw)	2004.10-		Front;Rear	Platform/Chassis 4x2 OM 925.920		Center Bearing Support	531056
Atego 3							
5.132 (115 kw)	2013.04-		Front;Rear	Platform/Chassis 4x2 OM 934.911		Center Bearing Support	531056
5.132 (130 kw)	2013.04-		Front;Rear	Platform/Chassis 4x2 OM 934.911		Center Bearing Support	531056
5.132 (155 kw)	2013.04-		Front;Rear	Platform/Chassis 4x2 OM 934.913		Center Bearing Support	531056
5.132 (170 kw)	2013.04-		Front;Rear	Platform/Chassis 4x2 OM 934.913		Center Bearing Support	531056
7.698 (175 kw)	2013.04-		Front;Rear	Platform/Chassis 4x2 OM 936.910		Center Bearing Support	531056
B160							
1.5 (66 kw)	2013.05-2018.12		Front	Hatchback FWD 607951		Flexible Coupling Kit	537796S
1.6 (75 kw)	2015.07-2018.12		Front	Hatchback FWD 270910		Flexible Coupling Kit	537796S
B180							
1.5 (80 kw)	2013.02-2018.12		Front	Hatchback FWD 607951		Flexible Coupling Kit	537796S
1.6 (90 kw)	2011.11-2018.12		Front	Hatchback FWD 270910		Flexible Coupling Kit	537796S
1.8 (80 kw)	2011.11-2014.08		Front	Hatchback FWD 651901		Flexible Coupling Kit	537796S
B200							
1.6 (115 kw)	2011.11-2018.12		Front	Hatchback FWD 270910		Flexible Coupling Kit	537796S
	2011.11-2018.12		Front	Hatchback FWD M 270.910		Flexible Coupling Kit	537796S
1.8 (100 kw)	2011.11-2014.08		Front	Hatchback FWD 651901		Flexible Coupling Kit	537796S
2.2 (100 kw)	2014.08-2018.12	AT/MT	Rear	Hatchback 4WD 651930		Propshaft	PS900347
	2014.08-2018.12		Rear	Hatchback 4WD 651930		Flexible Coupling	537818
	2014.08-2018.12		Front	Hatchback 4WD 651930		Flexible Coupling Kit	537796S
	2014.08-2018.12		Front	Hatchback FWD 651930		Flexible Coupling Kit	537796S
B220							
2.0 (135 kw)	2013.05-2018.12	AT/MT	Rear	Hatchback 4WD 270920		Propshaft	PS900347
	2013.05-2018.12		Rear	Hatchback 4WD 270920		Flexible Coupling	537818
	2013.05-2018.12		Front	Hatchback 4WD 270920		Flexible Coupling Kit	537796S
	2014.08-2018.12		Front	Hatchback FWD 270920		Flexible Coupling Kit	537796S
2.2 (120 kw)	2013.06-2018.12		Front	Hatchback FWD 651930		Flexible Coupling Kit	537796S
2.2 (125 kw)	2011.11-2018.12		Front	Hatchback FWD 651930		Flexible Coupling Kit	537796S
	2018.06-2018.12	AT/MT	Rear	Hatchback 4WD 651930		Propshaft	PS900347
	2018.06-2018.12		Rear	Hatchback 4WD 651930		Flexible Coupling	537818
	2018.06-2018.12		Front	Hatchback 4WD 651930		Flexible Coupling Kit	537796S



	 YEAR	TRANSM.	FITTING POSITION	BODY STYLE & DRIVE TYPE & ENGINE	REMARKS	 PRODUCT	GSP Ref.
MERCEDES-BENZ B220							
2.2 (130 kw)	2014.08-2018.12	AT/MT	Rear	Hatchback 4WD 651930		Propshaft	PS900347
	2014.08-2018.12		Rear	Hatchback 4WD 651930		Flexible Coupling	537818
	2014.08-2018.12		Front	Hatchback 4WD 651930		Flexible Coupling Kit	537796S
	2014.08-2018.12		Front	Hatchback FWD 651930		Flexible Coupling Kit	537796S
B250							
2.0 (155 kw)	2012.05-2018.12		Front	Hatchback FWD 270920		Flexible Coupling Kit	537796S
	2014.08-2018.12	AT/MT	Rear	Hatchback 4WD 270920		Propshaft	PS900347
	2014.08-2018.12		Rear	Hatchback 4WD 270920		Flexible Coupling	537818
	2014.08-2018.12		Front	Hatchback 4WD 270920		Flexible Coupling Kit	537796S
C160							
1.6 (95 kw)	2015.04-		Front;Rear	Estate RWD 274910		Flexible Coupling	537627
	2015.04-		Front;Rear	Saloon RWD 274910		Flexible Coupling	537627
1.8 (90 kw)	2004.09-2006.07		Centre	Coupe RWD 271921		Center Bearing Support	518416
	2004.09-2006.07		Front;Rear	Coupe RWD 271921		Flexible Coupling Kit	512673S
C180							
1.6 (85 kw)	2014.05-2018.05		Front;Rear	Saloon RWD 626951		Flexible Coupling	537627
	2014.09-2018.05		Front;Rear	Estate RWD 626951		Flexible Coupling	537627
1.6 (90 kw)	2018.05-		Front;Rear	Estate RWD 654916		Flexible Coupling Kit	537630S
1.6 (115 kw)	2008.02-2014.01		Centre	Saloon RWD 271910		Center Bearing Support	531051
	2008.02-2014.01		Centre	Estate RWD 271910		Center Bearing Support	531051
	2008.02-2014.01		Front;Rear	Saloon RWD 271910		Flexible Coupling Kit	512673S
	2008.02-2014.01		Front;Rear	Estate RWD 271910		Flexible Coupling Kit	512673S
	2012.02-2014.01		Front;Rear	Estate RWD 274910		Flexible Coupling Kit	512673S
	2012.04-2014.01		Centre	Saloon RWD 274910		Center Bearing Support	531051
	2012.04-2014.01		Front;Rear	Saloon RWD 274910		Flexible Coupling Kit	512673S
	2012.07-2014.01		Centre	Coupe RWD 274910		Center Bearing Support	531051
	2012.07-2014.01		Front;Rear	Coupe RWD 274910		Flexible Coupling Kit	512673S
	2013.07-		Front;Rear	Saloon RWD 274910		Flexible Coupling	537627
	2014.09-		Front;Rear	Estate RWD 274910		Flexible Coupling	537627
	2015.10-		Front;Rear	Coupe RWD 274910		Flexible Coupling	537627
	2016.06-		Front;Rear	Cabriolet RWD 274910		Flexible Coupling	537627
1.8 (89 kw)	1994.11-2000.05		Front	Saloon RWD 111921		Flexible Coupling	510569
	1994.11-2000.05		Front	Saloon RWD 111921		Flexible Coupling	517747
	1994.11-2000.05		Front	Saloon RWD 111921		Flexible Coupling Kit	510570S
	1994.11-2000.05		Front	Saloon RWD 111921		Flexible Coupling Kit	510578S
	1994.11-2000.05		Front	Saloon RWD 111921		Flexible Coupling Kit	537791S
	1994.11-2000.05		Front	Saloon RWD 111921	VIN to A 348436.F 267959.AT for tax	Flexible Coupling Kit	537820S
	1994.11-2000.05		Front	Saloon RWD 111921	MT for vehicles with air conditioning/VIN to A 348436.F 267959.AT for tax	Flexible Coupling Kit	537821S
	1994.11-2000.05		Rear	Saloon RWD 111921		Flexible Coupling Kit	510459S
1.8 (90 kw)	1993.06-2000.10		Centre	Saloon RWD 111920/111921		Center Bearing Support	512316
	1993.06-2000.10		Front	Saloon RWD 111920/111921		Flexible Coupling	510569
	1993.06-2000.10		Front	Saloon RWD 111920/111921		Flexible Coupling	517747
	1993.06-2000.10		Rear	Saloon RWD 111920/111921		Flexible Coupling	510460
	1993.06-2000.10		Front	Saloon RWD 111920/111921		Flexible Coupling Kit	510570S
	1993.06-2000.10		Front	Saloon RWD 111920/111921		Flexible Coupling Kit	510578S
	1993.06-2000.10		Front	Saloon RWD 111920/111921		Flexible Coupling Kit	537791S
	1993.06-2000.10		Front	Saloon RWD 111920/111921	VIN to A 348436.F 267959.AT for tax	Flexible Coupling Kit	537820S
	1993.06-2000.10		Front	Saloon RWD 111920/111921	MT for vehicles with air conditioning/VIN to A 348436.F 267959.AT for tax	Flexible Coupling Kit	537821S
	1993.06-2000.10		Rear	Saloon RWD 111920/111921		Flexible Coupling Kit	510459S
	1996.02-2000.10		Centre	Estate RWD 111920/111921		Center Bearing Support	512316
	1996.02-2000.10		Front	Estate RWD 111920/111921		Flexible Coupling	510569
	1996.02-2000.10		Front	Estate RWD 111920/111921		Flexible Coupling	517747
	1996.02-2000.10		Rear	Estate RWD 111920/111921		Flexible Coupling	510460
	1996.02-2000.10		Front	Estate RWD 111920/111921		Flexible Coupling Kit	510570S
	1996.02-2000.10		Front	Estate RWD 111920/111921	VIN to F 711023.MT for vehicles without air conditioning	Flexible Coupling Kit	537820S
	1996.02-2000.10		Front	Estate RWD 111920/111921	MT, for vehicles with air conditioning	Flexible Coupling Kit	537821S
	1996.02-2000.10		Rear	Estate RWD 111920/111921		Flexible Coupling Kit	510459S
1.8 (105 kw)	2002.05-2007.02		Centre	Saloon RWD 271946		Center Bearing Support	518416
	2002.05-2007.02		Front;Rear	Saloon RWD 271946		Flexible Coupling	512678
	2002.05-2007.02		Front;Rear	Saloon RWD 271946		Flexible Coupling Kit	512673S
	2002.05-2007.11		Centre	Estate RWD 271946		Center Bearing Support	518416
	2002.05-2007.11		Front;Rear	Estate RWD 271946		Flexible Coupling	512678
	2002.05-2007.11		Front;Rear	Estate RWD 271946		Flexible Coupling Kit	512673S



	 YEAR	TRANSM.	FITTING POSITION	BODY STYLE & DRIVE TYPE & ENGINE	REMARKS	 PRODUCT	GSP Ref.
MERCEDES-BENZ C180							
1.8 (105 kw)	2002.06-2008.01		Centre	Coupe RWD 271946		Center Bearing Support	518416
	2002.06-2008.01		Front;Rear	Coupe RWD 271946		Flexible Coupling	512678
	2002.06-2008.01		Front	Coupe RWD 271946		Flexible Coupling Kit	537797S
	2002.06-2008.01		Front;Rear	Coupe RWD 271946		Flexible Coupling Kit	512673S
1.8 (115 kw)	2007.01-2014.01		Centre	Saloon RWD 271820/271952		Center Bearing Support	531051
	2007.01-2014.01		Front;Rear	Saloon RWD 271820/271952		Flexible Coupling Kit	512673S
	2007.08-2014.01		Centre	Estate RWD 271820/271952		Center Bearing Support	531051
	2007.08-2014.01		Front;Rear	Estate RWD 271820/271952		Flexible Coupling Kit	512673S
	2011.06-2014.01		Centre	Coupe RWD 271820		Center Bearing Support	531051
	2011.06-2014.01		Front;Rear	Coupe RWD 271820		Flexible Coupling Kit	512673S
	2011.06-2014.01		Front;Rear	Coupe RWD 271820		Flexible Coupling Kit	512677S
2.0 (95 kw)	2000.06-2002.05		Front	Saloon RWD 111951		Flexible Coupling	510569
	2000.06-2002.05		Front	Saloon RWD 111951		Flexible Coupling Kit	510570S
	2000.09-2001.03		Front	Estate RWD 111952		Flexible Coupling	510569
	2000.09-2001.03		Front	Estate RWD 111952	AT	Flexible Coupling Kit	510570S
	2000.09-2001.03		Front	Estate RWD 111952		Flexible Coupling Kit	510570S
	2000.09-2001.03		Front	Estate RWD 111952	MT	Flexible Coupling Kit	537821S
	2000.09-2001.03		Front;Rear	Estate RWD 111952		Flexible Coupling Kit	512673S
	2000.11-2002.08		Front	Estate RWD 111951		Flexible Coupling	510569
	2000.11-2002.08		Front	Estate RWD 111951		Flexible Coupling Kit	510570S
	2001.03-2002.07		Front	Coupe RWD 111951		Flexible Coupling	510569
	2001.03-2002.07		Front	Coupe RWD 111951		Flexible Coupling Kit	510570S
2.2 (88 kw)	2010.04-2014.01		Front;Rear	Estate RWD 651913		Flexible Coupling Kit	512677S
	2010.04-2014.03		Front;Rear	Saloon RWD 651913		Flexible Coupling Kit	512677S
C200							
1.6 (100 kw)	2014.05-2018.05		Front;Rear	Saloon RWD 626951		Flexible Coupling	537627
	2014.09-2018.05		Front;Rear	Estate RWD 626951		Flexible Coupling	537627
1.6 (118 kw)	2018.05-		Front;Rear	Estate RWD 654916		Flexible Coupling Kit	537630S
	2018.07-		Front;Rear	Cabriolet RWD 654916		Flexible Coupling Kit	537630S
	2018.07-		Front;Rear	Coupe RWD 654916		Flexible Coupling Kit	537630S
1.8 (120 kw)	2002.05-2007.11		Centre	Saloon RWD 271940		Center Bearing Support	518416
	2002.05-2007.11		Centre	Estate RWD 271940		Center Bearing Support	518416
	2002.05-2007.11		Front;Rear	Saloon RWD 271940		Flexible Coupling	512678
	2002.05-2007.11		Front;Rear	Estate RWD 271940		Flexible Coupling	512678
	2002.05-2007.11		Front;Rear	Saloon RWD 271940		Flexible Coupling Kit	512673S
	2002.05-2007.11		Front;Rear	Estate RWD 271940		Flexible Coupling Kit	512673S
	2002.05-2007.11		Front;Rear	Saloon RWD 271940		Flexible Coupling Kit	512678S
	2002.05-2007.11		Front;Rear	Estate RWD 271940		Flexible Coupling Kit	512678S
	2002.08-2005.04		Centre	Coupe RWD 271940		Center Bearing Support	518416
	2002.08-2005.04		Front;Rear	Coupe RWD 271940		Flexible Coupling Kit	512673S
1.8 (125 kw)	2002.08-2005.09		Centre	Coupe RWD 271942		Center Bearing Support	518416
	2002.08-2005.09		Front;Rear	Coupe RWD 271942		Flexible Coupling Kit	512673S
	2003.07-2004.07		Centre	Saloon RWD 271942		Center Bearing Support	518416
	2003.07-2004.07		Centre	Estate RWD 271942		Center Bearing Support	518416
	2003.07-2004.07		Front;Rear	Saloon RWD 271942		Flexible Coupling	512678
	2003.07-2004.07		Front;Rear	Estate RWD 271942		Flexible Coupling	512678
	2003.07-2004.07		Front	Estate RWD 271942		Flexible Coupling Kit	537797S
	2003.07-2004.07		Front;Rear	Saloon RWD 271942		Flexible Coupling Kit	512673S
1.8 (135 kw)	2007.01-2014.01		Centre	Saloon RWD 271820/271860/271950		Center Bearing Support	531051
	2007.01-2014.01		Front;Rear	Saloon RWD 271820/271860/271950		Flexible Coupling	512678
	2007.01-2014.01		Front;Rear	Saloon RWD 271820/271860/271950		Flexible Coupling Kit	512673S
	2007.08-2014.01		Centre	Estate RWD 271820/271860/271950		Center Bearing Support	531051
	2007.08-2014.01		Front;Rear	Estate RWD 271820/271860/271950		Flexible Coupling	512678
	2007.08-2014.01		Front;Rear	Estate RWD 271820/271860/271950		Flexible Coupling Kit	512673S
	2011.06-2014.01		Centre	Coupe RWD 271860		Center Bearing Support	531051
	2011.06-2014.01		Front	Coupe RWD 271860		Flexible Coupling	537630
	2011.06-2014.01		Front;Rear	Coupe RWD 271860		Flexible Coupling Kit	512673S
	2011.06-2014.01		Front;Rear	Coupe RWD 271860		Flexible Coupling Kit	512677S
1.8 (137 kw)	2009.09-2014.01		Centre	Saloon RWD 271820		Center Bearing Support	531051
	2009.09-2014.01		Front;Rear	Saloon RWD 271820		Flexible Coupling Kit	512673S
2.0 (55 kw)	1993.06-2000.05		Centre	Saloon RWD 601913		Center Bearing Support	512316
	1993.06-2000.05		Front	Saloon RWD 601913		Flexible Coupling	510569
	1993.06-2000.05		Front	Saloon RWD 601913		Flexible Coupling	517747



	 YEAR	TRANSM.	FITTING POSITION	BODY STYLE & DRIVE TYPE & ENGINE	REMARKS	 PRODUCT	GSP Ref.
MERCEDES-BENZ C200							
2.0 (55 kw)	1993.06-2000.05		Rear	Saloon RWD 601913		Flexible Coupling	510458
	1993.06-2000.05		Rear	Saloon RWD 601913		Flexible Coupling	510460
	1993.06-2000.05		Front	Saloon RWD 601913		Flexible Coupling Kit	510570S
	1993.06-2000.05		Front	Saloon RWD 601913		Flexible Coupling Kit	510578S
	1993.06-2000.05		Front	Saloon RWD 601913	VIN to:A 601664,A 702940,MT,not for taxis	Flexible Coupling Kit	537820S
	1993.06-2000.05		Front	Saloon RWD 601913	VIN to:A 496535,F 483847,for taxis,not for SA code: 807,AT,not for taxis	Flexible Coupling Kit	537821S
2.0 (65 kw)	1995.07-2000.05		Centre	Saloon RWD 604915		Center Bearing Support	512316
	1995.07-2000.05		Centre	Estate RWD 604915		Center Bearing Support	512316
	1995.07-2000.05		Front	Saloon RWD 604915		Flexible Coupling	510569
	1995.07-2000.05		Front	Estate RWD 604915		Flexible Coupling	510569
	1995.07-2000.05		Front	Saloon RWD 604915		Flexible Coupling	517747
	1995.07-2000.05		Front	Estate RWD 604915		Flexible Coupling	517747
	1995.07-2000.05		Rear	Saloon RWD 604915		Flexible Coupling	510460
	1995.07-2000.05		Rear	Estate RWD 604915		Flexible Coupling	510460
	1995.07-2000.05		Front	Saloon RWD 604915		Flexible Coupling Kit	510570S
	1995.07-2000.05		Front	Estate RWD 604915		Flexible Coupling Kit	510570S
	1995.07-2000.05		Front	Saloon RWD 604915		Flexible Coupling Kit	510578S
	1995.07-2000.05		Front	Saloon RWD 604915		Flexible Coupling Kit	537791S
	1995.07-2000.05		Front	Estate RWD 604915		Flexible Coupling Kit	537791S
	1995.07-2000.05		Front	Saloon RWD 604915	VIN to:A 601664,A 702940,MT,not for taxis	Flexible Coupling Kit	537820S
	1995.07-2000.05		Front	Saloon RWD 604915	VIN from:A 496535,F 483848,MT,for taxis,not for SA code: 806	Flexible Coupling Kit	537821S
	1995.07-2000.05		Rear	Saloon RWD 604915		Flexible Coupling Kit	510459S
1995.07-2000.05		Rear	Estate RWD 604915		Flexible Coupling Kit	510459S	
2.0 (100 kw)	1993.06-2000.05		Centre	Saloon RWD 111941/111945		Center Bearing Support	512316
	1993.06-2000.05		Front	Saloon RWD 111941/111945		Flexible Coupling	510569
	1993.06-2000.05		Front	Saloon RWD 111941/111945	Engine Code M 111.941,MT,not for taxis,for vehicles without air conditioning	Flexible Coupling	512326
	1993.06-2000.05		Front	Saloon RWD 111941/111945		Flexible Coupling Kit	510570S
	1993.06-2000.05		Front	Saloon RWD 111941/111945		Flexible Coupling Kit	510578S
	1993.06-2000.05		Front	Saloon RWD 111941/111945	MT,for vehicles with air conditioning,VIN to:A 348436,F 267959,AT	Flexible Coupling Kit	537821S
	1996.02-2000.10		Centre	Estate RWD 111941/111945		Center Bearing Support	512316
	1996.02-2000.10		Front	Estate RWD 111941/111945		Flexible Coupling	510569
	1996.02-2000.10		Front	Estate RWD 111941/111945	MT,not for taxis,for vehicles without air conditioning	Flexible Coupling	512326
	1996.02-2000.10		Front	Estate RWD 111941/111945		Flexible Coupling Kit	510570S
2.0 (110 kw)	2018.05-		Front;Rear	Estate RWD 654920		Flexible Coupling Kit	537630S
	2018.05-		Front;Rear	Saloon RWD 654920		Flexible Coupling Kit	537630S
2.0 (120 kw)	2000.06-2002.07		Front;Rear	Saloon RWD 111955		Flexible Coupling	512678
	2000.06-2002.07		Front	Saloon RWD 111955		Flexible Coupling Kit	537797S
	2000.06-2002.07		Front;Rear	Saloon RWD 111955		Flexible Coupling Kit	512673S
	2000.09-2001.03		Front	Estate RWD 111956		Flexible Coupling	510571
	2000.09-2001.03		Rear	Estate RWD 111956		Flexible Coupling	512678
	2000.09-2001.03		Front	Estate RWD 111956		Flexible Coupling Kit	510571S
	2000.09-2001.03		Front;Rear	Estate RWD 111956		Flexible Coupling Kit	512673S
	2000.11-2002.08		Front;Rear	Estate RWD 111955		Flexible Coupling	512678
	2000.11-2002.08		Front	Estate RWD 111955		Flexible Coupling Kit	537797S
	2000.11-2002.08		Front;Rear	Estate RWD 111955		Flexible Coupling Kit	512673S
	2001.03-2004.12		Front;Rear	Coupe RWD 111955		Flexible Coupling	512678
	2001.03-2004.12		Front	Coupe RWD 111955		Flexible Coupling Kit	537797S
2.0 (132 kw)	1995.10-2000.05		Centre	Saloon RWD 111944		Center Bearing Support	512315
	1995.10-2000.05		Front	Saloon RWD 111944	VIN to:F 381313,MT	Flexible Coupling	510569
	1995.10-2000.05		Front	Saloon RWD 111944	For OE No.124 411 05 15	Flexible Coupling	510571
	1995.10-2000.05		Front;Rear	Saloon RWD 111944		Flexible Coupling	510579
	1995.10-2000.05		Front	Saloon RWD 111944		Flexible Coupling Kit	510570S
	1995.10-2000.05		Front	Saloon RWD 111944		Flexible Coupling Kit	510571S
2.0 (135 kw)	2013.12-2018.08		Front;Rear	Saloon RWD 274920		Flexible Coupling	537627
	2014.09-2018.05		Front;Rear	Estate RWD 274920		Flexible Coupling	537627
	2015.04-2018.05		Front;Rear	Estate 4WD 274920		Flexible Coupling	537627
	2015.04-2018.08		Front;Rear	Saloon 4WD 274920		Flexible Coupling	537627
	2015.10-2018.05		Front;Rear	Coupe RWD 274920		Flexible Coupling	537627
	2016.04-2018.05		Front;Rear	Coupe 4WD 274920		Flexible Coupling	537627



	 YEAR	TRANSM.	FITTING POSITION	BODY STYLE & DRIVE TYPE & ENGINE	REMARKS	 PRODUCT	GSP Ref.
MERCEDES-BENZ C200							
2.0 (135 kw)	2016.06-2018.05		Front;Rear	Cabriolet 4WD 274920		Flexible Coupling	537627
	2016.06-2018.05		Front;Rear	Cabriolet RWD 274920		Flexible Coupling	537627
2.0 (141 kw)	1995.09-2000.10		Centre	Estate RWD 111944		Center Bearing Support	512315
	1995.09-2000.10		Front	Estate RWD 111944		Flexible Coupling	510571
	1995.09-2000.10		Front;Rear	Estate RWD 111944		Flexible Coupling	510579
	1995.09-2000.10		Front	Estate RWD 111944		Flexible Coupling Kit	510571S
	1995.10-2000.05		Front	Estate RWD 111944		Flexible Coupling Kit	510580S
	1995.10-2000.05		Centre	Saloon RWD 111944		Center Bearing Support	512315
	1995.10-2000.05		Front	Saloon RWD 111944	VIN to:F 381313,MT	Flexible Coupling	510569
	1995.10-2000.05		Front	Saloon RWD 111944	For OE No.124 411 05 15	Flexible Coupling	510571
	1995.10-2000.05		Front;Rear	Saloon RWD 111944		Flexible Coupling	510579
	1995.10-2000.05		Front	Saloon RWD 111944		Flexible Coupling Kit	510570S
	1995.10-2000.05		Front	Saloon RWD 111944		Flexible Coupling Kit	510571S
2.2 (75 kw)	1998.04-2000.05		Centre	Saloon RWD 611960		Center Bearing Support	512315
	1998.04-2000.05		Front;Rear	Saloon RWD 611960		Flexible Coupling	510579
	1998.04-2000.10		Centre	Estate RWD 611960		Center Bearing Support	512315
	1998.04-2000.10		Front;Rear	Estate RWD 611960		Flexible Coupling	510579
	1998.04-2000.10		Front	Estate RWD 611960		Flexible Coupling Kit	510580S
	1998.04-2000.10		Front;Rear	Estate RWD 611960		Flexible Coupling Kit	512673S
	2001.02-2003.06		Front;Rear	Saloon RWD 611962		Flexible Coupling Kit	512673S
2.2 (85 kw)	2000.09-2003.06		Front;Rear	Saloon RWD 611962		Flexible Coupling	512678
	2000.09-2003.06		Front;Rear	Saloon RWD 611962		Flexible Coupling Kit	512673S
	2000.09-2003.06		Front;Rear	Saloon RWD 611962		Flexible Coupling Kit	512678S
	2000.11-2003.07		Front;Rear	Estate RWD 611962		Flexible Coupling	512678
	2000.11-2003.07		Front;Rear	Estate RWD 611962		Flexible Coupling Kit	512673S
2.2 (90 kw)	2003.04-2007.02		Front;Rear	Saloon RWD 646962/646963		Flexible Coupling Kit	512673S
	2003.04-2008.03		Front;Rear	Estate RWD 646962/646963		Flexible Coupling Kit	512673S
	2003.07-2008.01		Front;Rear	Coupe RWD 646962/646963		Flexible Coupling Kit	512673S
2.2 (100 kw)	2007.01-2009.12		Centre	Saloon RWD 646811/646812		Center Bearing Support	531051
	2007.01-2009.12		Front;Rear	Saloon RWD 646811/646812		Flexible Coupling	512678
	2007.01-2009.12		Front;Rear	Saloon RWD 646811/646812		Flexible Coupling Kit	512673S
	2007.01-2009.12		Front;Rear	Saloon RWD 646811/646812		Flexible Coupling Kit	512677S
	2007.08-2009.12		Centre	Estate RWD 646811		Center Bearing Support	531051
	2007.08-2009.12		Front;Rear	Estate RWD 646811		Flexible Coupling	512678
	2007.08-2009.12		Front;Rear	Estate RWD 646811		Flexible Coupling Kit	512673S
	2007.08-2009.12		Front;Rear	Estate RWD 646811		Flexible Coupling Kit	512677S
	2009.11-2014.03		Front;Rear	Saloon RWD 651913		Flexible Coupling Kit	512677S
	2010.01-2014.01		Front;Rear	Estate RWD 651913		Flexible Coupling Kit	512677S
	2015.10-2018.05		Rear	Estate RWD 651921		Propshaft	PS900571
	2015.10-2018.05		Rear	Saloon RWD 651921		Propshaft	PS900571
	2015.10-2018.05		Centre	Estate RWD 651921		Center Bearing Support	537784
	2015.10-2018.05		Centre	Saloon RWD 651921		Center Bearing Support	537784
	2015.10-2018.05		Front	Estate RWD 651921		Flexible Coupling	537630
	2015.10-2018.05		Front	Saloon RWD 651921		Flexible Coupling	537630
	2015.10-2018.05		Front;Rear	Estate RWD 651921		Flexible Coupling	512677
2015.10-2018.05		Front;Rear	Saloon RWD 651921		Flexible Coupling	512677	
2015.10-2018.05		Front;Rear	Estate RWD 651921		Flexible Coupling Kit	537630S	
2015.10-2018.05		Front;Rear	Saloon RWD 651921		Flexible Coupling Kit	537630S	
C220							
2.0 (143 kw)	2018.04-		Front;Rear	Estate RWD 654920		Flexible Coupling	537630
	2018.04-		Front;Rear	Cabriolet RWD 654920		Flexible Coupling	537630
	2018.04-		Front;Rear	Coupe RWD 654920		Flexible Coupling	537630
	2018.04-		Front;Rear	Estate RWD 654920		Flexible Coupling Kit	537630S
	2018.04-		Front;Rear	Cabriolet RWD 654920		Flexible Coupling Kit	537630S
	2018.04-		Front;Rear	Coupe RWD 654920		Flexible Coupling Kit	537630S
	2018.05-		Front;Rear	Saloon RWD 654920		Flexible Coupling	537630
	2018.05-		Front;Rear	Saloon RWD 654920		Flexible Coupling Kit	537630S
	2018.05-		Front;Rear	Estate 4WD 654920		Flexible Coupling Kit	537630S
	2018.05-		Front;Rear	Saloon 4WD 654920		Flexible Coupling Kit	537630S
	2018.06-		Front;Rear	Cabriolet 4WD 654920		Flexible Coupling Kit	537630S
	2018.06-		Front;Rear	Coupe 4WD 654920		Flexible Coupling Kit	537630S



	 YEAR	TRANSM.	FITTING POSITION	BODY STYLE & DRIVE TYPE & ENGINE	REMARKS	 PRODUCT	GSP Ref.
MERCEDES-BENZ C220							
2.2 (55 kw)	1996.07-1999.07		Front	Estate RWD 604910		Flexible Coupling	510569
	1996.07-1999.07		Front	Estate RWD 604910	VIN from:F 702941,MT,not for taxis	Flexible Coupling	512326
	1996.07-1999.07		Front	Estate RWD 604910		Flexible Coupling	517747
	1996.07-1999.07		Rear	Estate RWD 604910		Flexible Coupling	510460
	1996.07-1999.07		Front	Estate RWD 604910		Flexible Coupling Kit	510570S
	1996.07-1999.07		Front	Estate RWD 604910		Flexible Coupling Kit	510578S
	1996.07-1999.07		Front	Estate RWD 604910		Flexible Coupling Kit	537791S
	1996.07-1999.07		Front	Estate RWD 604910	VIN to:F 702940,MT,not for taxis	Flexible Coupling Kit	537820S
	1996.07-1999.07		Front	Estate RWD 604910	MT,for taxis	Flexible Coupling Kit	537821S
	1996.07-1999.07		Rear	Estate RWD 604910		Flexible Coupling Kit	510459S
	1996.07-2000.05		Front	Saloon RWD 604910	Chassis no. from:A 436536 - F 483848,AT	Flexible Coupling	510569
	1996.07-2000.05		Front	Saloon RWD 604910		Flexible Coupling	510569
	1996.07-2000.05		Rear	Saloon RWD 604910		Flexible Coupling	510458
	1996.07-2000.05		Rear	Saloon RWD 604910		Flexible Coupling	510460
	1996.07-2000.05		Front	Saloon RWD 604910		Flexible Coupling Kit	510570S
	1996.07-2000.05		Front	Saloon RWD 604910		Flexible Coupling Kit	510578S
	1996.07-2000.05		Front	Saloon RWD 604910	VIN to:A 601664,A 702940,MT,not for taxis	Flexible Coupling Kit	537820S
	1996.07-2000.05		Front	Saloon RWD 604910		Flexible Coupling Kit	537821S
	1996.07-2000.05		Rear	Saloon RWD 604910		Flexible Coupling Kit	510459S
	2.2 (70 kw)	1993.06-1998.06		Centre	Saloon RWD 604910		Center Bearing Support
1993.06-1998.06			Front	Saloon RWD 604910		Flexible Coupling	510569
1993.06-1998.06			Front	Saloon RWD 604910		Flexible Coupling	517747
1993.06-1998.06			Rear	Saloon RWD 604910		Flexible Coupling	510458
1993.06-1998.06			Rear	Saloon RWD 604910		Flexible Coupling	510460
1993.06-1998.06			Front	Saloon RWD 604910		Flexible Coupling Kit	510570S
1993.06-1998.06			Front	Saloon RWD 604910		Flexible Coupling Kit	510578S
1993.06-1998.06			Front	Saloon RWD 604910	VIN to:A 601664,A 702940,MT,not for taxis	Flexible Coupling Kit	537820S
1993.06-1998.06			Front	Saloon RWD 604910		Flexible Coupling Kit	537821S
1993.06-1998.06			Rear	Saloon RWD 604910		Flexible Coupling Kit	510459S
1996.01-1998.05			Centre	Estate RWD 604910		Center Bearing Support	512316
1996.01-1998.05			Front	Estate RWD 604910		Flexible Coupling	510569
1996.01-1998.05			Front	Estate RWD 604910	VIN from:F 702941,MT,not for taxis	Flexible Coupling	512326
1996.01-1998.05			Front	Estate RWD 604910		Flexible Coupling	517747
1996.01-1998.05			Rear	Estate RWD 604910		Flexible Coupling	510460
1996.01-1998.05			Front	Estate RWD 604910		Flexible Coupling Kit	510570S
1996.01-1998.05			Front	Estate RWD 604910		Flexible Coupling Kit	510578S
1996.01-1998.05			Front	Estate RWD 604910		Flexible Coupling Kit	537791S
1996.01-1998.05			Front	Estate RWD 604910	VIN to:F 702940,MT,not for taxis	Flexible Coupling Kit	537820S
1996.01-1998.05			Front	Estate RWD 604910	MT,for taxis	Flexible Coupling Kit	537821S
1996.01-1998.05		Rear	Estate RWD 604910		Flexible Coupling Kit	510459S	
2.2 (92 kw)	1996.02-2000.05		Centre	Saloon RWD 611960		Center Bearing Support	512315
	1996.02-2000.05		Front;Rear	Saloon RWD 611960		Flexible Coupling	510579
	1997.04-2000.10		Centre	Estate RWD 611960		Center Bearing Support	512315
	1997.04-2000.10		Front;Rear	Estate RWD 611960		Flexible Coupling	510579
	1997.04-2000.10		Front	Estate RWD 611960		Flexible Coupling Kit	510580S
2.2 (100 kw)	2000.05-2007.02		Front;Rear	Saloon RWD 611962		Flexible Coupling	512678
	2000.05-2007.02		Front;Rear	Saloon RWD 611962		Flexible Coupling Kit	512673S
	2001.03-2007.08		Front;Rear	Estate RWD 646963		Flexible Coupling Kit	512677S
	2001.03-2008.05		Front;Rear	Coupe RWD 611962		Flexible Coupling	512678
	2001.03-2008.05		Front;Rear	Coupe RWD 611962		Flexible Coupling Kit	512673S
2.2 (105 kw)	2000.06-2004.12		Front;Rear	Saloon RWD 611962		Flexible Coupling	512678
	2000.06-2004.12		Front;Rear	Saloon RWD 611962		Flexible Coupling Kit	512673S
	2001.03-2004.03		Front;Rear	Coupe RWD 611962		Flexible Coupling	512678
	2001.03-2004.03		Front;Rear	Coupe RWD 611962		Flexible Coupling Kit	512673S
	2001.03-2007.08		Front;Rear	Estate RWD 611962		Flexible Coupling	512678
	2001.03-2007.08		Front;Rear	Estate RWD 611962		Flexible Coupling Kit	512673S
2.2 (110 kw)	2001.03-2007.08		Front;Rear	Estate RWD 611962		Flexible Coupling Kit	512678S
	1993.06-2000.05		Centre	Saloon RWD 111961		Center Bearing Support	512316
	1993.06-2000.05		Front	Saloon RWD 111961		Flexible Coupling	510569
	1993.06-2000.05		Front	Saloon RWD 111961	Automatic Transmission	Flexible Coupling	512326
	1993.06-2000.05		Front	Saloon RWD 111961		Flexible Coupling Kit	510570S
	1993.06-2000.05		Front	Saloon RWD 111961		Flexible Coupling Kit	510578S
	1993.06-2000.05		Front	Saloon RWD 111961	Manual Transmission	Flexible Coupling Kit	537821S
	2003.04-2007.02		Front;Rear	Saloon RWD 646963		Flexible Coupling Kit	512677S

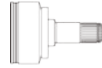

	 YEAR	TRANSM.	FITTING POSITION	BODY STYLE & DRIVE TYPE & ENGINE	REMARKS	 PRODUCT	GSP Ref.
MERCEDES-BENZ C220							
2.2 (110 kw)	2003.08-2007.10		Front;Rear	Estate RWD 646963		Flexible Coupling Kit	512677S
	2004.02-2008.01		Front;Rear	Coupe RWD 646963		Flexible Coupling Kit	512677S
2.2 (120 kw)	2007.04-2008.11		Front;Rear	Saloon RWD 646811		Flexible Coupling Kit	512677S
	2007.08-2008.11		Rear	Estate RWD 646811		Flexible Coupling Kit	537793S
	2007.08-2008.11		Front;Rear	Estate RWD 646811		Flexible Coupling Kit	512677S
	2008.12-2014.01		Rear	Saloon RWD 651911		Flexible Coupling	537843
	2008.12-2014.01		Rear	Saloon RWD 651911		Flexible Coupling Kit	537843S
	2008.12-2014.01		Front;Rear	Saloon RWD 651911		Flexible Coupling Kit	512677S
	2008.12-2014.01		Front;Rear	Estate RWD 651911		Flexible Coupling Kit	512677S
	2011.06-2014.01		Front;Rear	Coupe RWD 651911		Flexible Coupling Kit	512677S
	2013.12-2016.05		Rear	Saloon RWD 651921		Propshaft	PS900571
	2013.12-2016.05		Centre	Saloon RWD 651921		Center Bearing Support	537784
	2013.12-2016.05		Front	Saloon RWD 651921		Flexible Coupling	537630
	2013.12-2016.05		Front;Rear	Saloon RWD 651921		Flexible Coupling	512677
	2013.12-2016.05		Front;Rear	Saloon RWD 651921		Flexible Coupling Kit	537630S
	2014.09-2018.05		Rear	Estate RWD 651921		Propshaft	PS900571
	2014.09-2018.05		Centre	Estate RWD 651921		Center Bearing Support	537784
	2014.09-2018.05		Front	Estate RWD 651921		Flexible Coupling	537630
	2014.09-2018.05		Front;Rear	Estate RWD 651921		Flexible Coupling	512677
	2014.09-2018.05		Front;Rear	Estate RWD 651921		Flexible Coupling Kit	537630S
	2015.10-2018.05		Rear	Coupe RWD 651921		Propshaft	PS900571
	2015.10-2018.05		Centre	Coupe RWD 651921		Center Bearing Support	537784
2015.10-2018.05		Front;Rear	Coupe RWD 651921		Flexible Coupling Kit	537630S	
2016.06-2018.05		Rear	Cabriolet RWD 651921		Propshaft	PS900571	
2016.06-2018.05		Centre	Cabriolet RWD 651921		Center Bearing Support	537784	
2016.06-2018.05		Front	Cabriolet RWD 651921		Flexible Coupling	537630	
2016.06-2018.05		Front;Rear	Cabriolet RWD 651921		Flexible Coupling Kit	537630S	
2.2 (125 kw)	2007.01-2014.01		Rear	Saloon RWD 646811		Flexible Coupling Kit	537793S
	2007.01-2014.01		Front;Rear	Saloon RWD 646811		Flexible Coupling Kit	512677S
	2007.11-2008.11		Rear	Estate RWD 646811		Flexible Coupling Kit	537793S
	2007.11-2008.11		Front;Rear	Estate RWD 646811		Flexible Coupling Kit	512677S
	2008.12-2014.01		Rear	Saloon RWD 651911		Flexible Coupling	537843
	2008.12-2014.01		Rear	Saloon RWD 651911		Flexible Coupling Kit	537843S
	2008.12-2014.01		Front;Rear	Saloon RWD 651911		Flexible Coupling Kit	512677S
	2008.12-2014.01		Front;Rear	Estate RWD 651911		Flexible Coupling Kit	512677S
	2011.06-2014.01		Front;Rear	Coupe RWD 651911		Flexible Coupling Kit	512677S
	2013.02-2014.01		Front;Rear	Saloon 4WD 651912		Flexible Coupling Kit	512673S
	2013.05-2014.01		Front;Rear	Estate 4WD 651912		Flexible Coupling Kit	512673S
	2013.12-2018.05		Rear	Saloon RWD 651921		Propshaft	PS900571
	2013.12-2018.05		Centre	Saloon RWD 651921		Center Bearing Support	537784
	2013.12-2018.05		Front	Saloon RWD 651921		Flexible Coupling	537630
	2013.12-2018.05		Front;Rear	Saloon RWD 651921		Flexible Coupling	512677
	2013.12-2018.05		Front;Rear	Saloon RWD 651921		Flexible Coupling Kit	537630S
	2014.09-2018.05		Rear	Estate RWD 651921		Propshaft	PS900571
	2014.09-2018.05		Centre	Estate RWD 651921		Center Bearing Support	537784
	2014.09-2018.05		Front	Estate RWD 651921		Flexible Coupling	537630
	2014.09-2018.05		Front;Rear	Estate RWD 651921		Flexible Coupling	512677
	2014.09-2018.05		Front;Rear	Estate RWD 651921		Flexible Coupling Kit	537630S
	2015.04-2018.05		Front;Rear	Saloon 4WD 651921		Flexible Coupling	537627
	2015.04-2018.05		Front;Rear	Estate 4WD 651921		Flexible Coupling	537627
	2015.10-2018.05		Rear	Coupe RWD 651921		Propshaft	PS900571
	2015.10-2018.05		Centre	Coupe RWD 651921		Center Bearing Support	537784
	2015.10-2018.05		Front;Rear	Coupe RWD 651921		Flexible Coupling Kit	537630S
	2016.04-2018.05		Front;Rear	Coupe 4WD 651921		Flexible Coupling	537627
	2016.06-2018.05		Rear	Cabriolet RWD 651921		Propshaft	PS900571
	2016.06-2018.05		Centre	Cabriolet RWD 651921		Center Bearing Support	537784
	2016.06-2018.05		Front	Cabriolet RWD 651921		Flexible Coupling	537630
2016.06-2018.05		Front;Rear	Cabriolet 4WD 651921		Flexible Coupling	537627	
2016.06-2018.05		Front;Rear	Cabriolet RWD 651921		Flexible Coupling Kit	537630S	
C230							
1.8 (141 kw)	2002.05-2008.05		Centre	Coupe RWD 271948		Center Bearing Support	518416
	2002.05-2008.05		Front;Rear	Coupe RWD 271948		Flexible Coupling Kit	512673S
	2003.11-2005.07		Centre	Estate RWD 271948		Center Bearing Support	518416
	2003.11-2005.07		Front;Rear	Estate RWD 271948		Flexible Coupling Kit	512673S



	 YEAR	TRANSM.	FITTING POSITION	BODY STYLE & DRIVE TYPE & ENGINE	REMARKS	 PRODUCT	GSP Ref.
MERCEDES-BENZ C230							
1.8 (141 kw)	2004.02-2007.02		Centre	Saloon RWD 271948		Center Bearing Support	518416
	2004.02-2007.02		Front;Rear	Saloon RWD 271948		Flexible Coupling	512678
	2004.02-2007.02		Front;Rear	Saloon RWD 271948		Flexible Coupling Kit	512673S
2.3 (110 kw)	1995.09-1997.06		Centre	Saloon RWD 111974		Center Bearing Support	512316
	1995.09-1997.06		Front	Saloon RWD 111974		Flexible Coupling	510569
	1995.09-1997.06		Front	Saloon RWD 111974		Flexible Coupling Kit	510570S
	1995.09-1997.06		Front	Saloon RWD 111974	MT	Flexible Coupling Kit	537821S
	1996.01-1998.06		Centre	Estate RWD 111974		Center Bearing Support	512316
	1996.01-1998.06		Front	Estate RWD 111974		Flexible Coupling	510569
	1996.01-1998.06		Front	Estate RWD 111974		Flexible Coupling Kit	510570S
	1996.01-1998.06		Front	Estate RWD 111974	MT	Flexible Coupling Kit	537821S
2.3 (142 kw)	1995.09-2000.05		Centre	Saloon RWD 111975		Center Bearing Support	512315
	1995.09-2000.05		Front	Saloon RWD 111975		Flexible Coupling	510571
	1995.09-2000.05		Front;Rear	Saloon RWD 111975		Flexible Coupling	510579
	1995.09-2000.05		Front	Saloon RWD 111975		Flexible Coupling Kit	510571S
	1995.09-2000.05		Front	Saloon RWD 111975		Flexible Coupling Kit	510580S
	1997.04-1999.10		Front	Estate RWD 111975		Flexible Coupling	510571
	1997.04-1999.10		Front;Rear	Estate RWD 111975		Flexible Coupling	510579
	1997.04-1999.10		Front	Estate RWD 111975		Flexible Coupling Kit	510571S
2.3 (145 kw)	2001.03-2002.05		Front;Rear	Coupe RWD 111981		Flexible Coupling	512678
	2001.03-2002.05		Front	Coupe RWD 111981		Flexible Coupling Kit	537797S
	2001.03-2002.05		Front;Rear	Coupe RWD 111981		Flexible Coupling Kit	512673S
2.5 (150 kw)	2005.03-2007.11		Centre	Estate RWD 272920		Center Bearing Support	518416
	2005.03-2007.11		Front;Rear	Estate RWD 272920		Flexible Coupling Kit	512673S
	2005.03-2007.12		Centre	Saloon RWD 272920		Center Bearing Support	518416
	2005.03-2007.12		Front;Rear	Saloon RWD 272920		Flexible Coupling Kit	512673S
	2005.03-2008.01		Centre	Coupe RWD 272920		Center Bearing Support	518416
	2005.03-2008.01		Front;Rear	Coupe RWD 272920		Flexible Coupling Kit	512673S
	2007.02-2014.01		Centre	Saloon RWD 272921		Center Bearing Support	531051
	2007.02-2014.01		Front;Rear	Saloon RWD 272921		Flexible Coupling	512678
	2007.02-2014.01		Front;Rear	Saloon RWD 272921		Flexible Coupling Kit	512673S
	2007.05-2010.12	AT/MT	Front	Saloon 4WD 272911	Date To:2010.12	Propshaft	PS900359
	2007.05-2010.12		Front;Rear	Saloon 4WD 272911		Flexible Coupling	512678
	2007.05-2010.12		Front;Rear	Saloon 4WD 272911		Flexible Coupling Kit	512673S
	2007.11-2010.12		Centre	Estate RWD 272921		Center Bearing Support	531051
	2007.11-2010.12		Front;Rear	Estate RWD 272921		Flexible Coupling	512678
	2007.11-2010.12		Front;Rear	Estate RWD 272921		Flexible Coupling Kit	512673S
C240							
2.4 (125 kw)	1995.09-2000.05		Centre	Saloon RWD 112910		Center Bearing Support	512315
	1995.09-2000.05		Front	Saloon RWD 112910		Flexible Coupling	510569
	1995.09-2000.05		Front	Saloon RWD 112910		Flexible Coupling Kit	510570S
	1995.09-2000.05		Front	Saloon RWD 112910	MT	Flexible Coupling Kit	537821S
	1997.04-2000.10		Centre	Estate RWD 112910		Center Bearing Support	512315
	1997.04-2000.10		Front	Estate RWD 112910		Flexible Coupling	510569
	1997.04-2000.10		Front	Estate RWD 112910		Flexible Coupling Kit	510570S
	1997.04-2000.10		Front	Estate RWD 112910	MT	Flexible Coupling Kit	537821S
	1997.04-2000.10		Front;Rear	Estate RWD 112910		Flexible Coupling Kit	510579S
2.6 (125 kw)	2000.01-2005.07		Front;Rear	Saloon RWD 112912		Flexible Coupling	512678
	2000.01-2005.07		Front	Saloon RWD 112912		Flexible Coupling Kit	537797S
	2000.01-2005.07		Front;Rear	Saloon RWD 112912		Flexible Coupling Kit	512673S
	2000.01-2005.07		Front;Rear	Saloon RWD 112912		Flexible Coupling Kit	512678S
	2000.09-2001.03		Front;Rear	Estate RWD 112915		Flexible Coupling	512678
	2000.09-2001.03		Front;Rear	Estate RWD 112915		Flexible Coupling Kit	512673S
	2000.11-2005.12		Centre	Estate RWD 112912		Center Bearing Support	518416
	2000.11-2005.12		Front;Rear	Estate RWD 112912		Flexible Coupling	512678
	2000.11-2005.12		Front	Estate RWD 112912		Flexible Coupling Kit	537797S
	2000.11-2005.12		Front;Rear	Estate RWD 112912		Flexible Coupling Kit	512673S
	2000.11-2005.12		Front;Rear	Estate RWD 112912		Flexible Coupling Kit	512678S
	2002.08-2005.12	AT/MT	Front	Saloon 4WD 112916		Propshaft	PS900346
	2002.08-2005.12	AT/MT	Front	Estate 4WD 112916	Date To:2005.12	Propshaft	PS900346
	2002.08-2005.12		Centre	Saloon 4WD 112916		Center Bearing Support	518416
	2002.08-2005.12		Centre	Estate 4WD 112916		Center Bearing Support	518416
	2002.08-2005.12		Front;Rear	Saloon 4WD 112916		Flexible Coupling	512678



	 YEAR	TRANSM.	FITTING POSITION	BODY STYLE & DRIVE TYPE & ENGINE	REMARKS	 PRODUCT	GSP Ref.
MERCEDES-BENZ C240							
2.6 (125 kw)	2002.08-2005.12		Front;Rear	Saloon 4WD 112916		Flexible Coupling	533884
	2002.08-2005.12		Front;Rear	Estate 4WD 112916		Flexible Coupling	533884
	2002.08-2005.12		Front	Saloon 4WD 112916		Flexible Coupling Kit	537797S
	2002.08-2005.12		Front	Estate 4WD 112916		Flexible Coupling Kit	537797S
	2002.08-2005.12		Front;Rear	Saloon 4WD 112916		Flexible Coupling Kit	512673S
	2002.08-2005.12		Front;Rear	Estate 4WD 112916		Flexible Coupling Kit	512673S
C250							
1.8 (150 kw)	2009.05-2014.01		Centre	Saloon RWD 271860		Center Bearing Support	531051
	2009.05-2014.01		Centre	Estate RWD 271860		Center Bearing Support	531051
	2009.05-2014.01		Front;Rear	Saloon RWD 271860		Flexible Coupling Kit	512673S
	2009.05-2014.01		Front;Rear	Saloon RWD 271860		Flexible Coupling Kit	512677S
	2009.05-2014.01		Front;Rear	Estate RWD 271860		Flexible Coupling Kit	512677S
	2011.03-2014.01		Centre	Coupe RWD 271860		Center Bearing Support	531051
	2011.03-2014.01		Front;Rear	Coupe RWD 271860		Flexible Coupling Kit	512677S
2.0 (155 kw)	2014.03-2018.05		Front;Rear	Saloon RWD 274920		Flexible Coupling	512677
2.2 (150 kw)	2008.08-2014.01		Rear	Saloon RWD 651911		Flexible Coupling	537843
	2008.08-2014.01		Front;Rear	Saloon RWD 651911		Flexible Coupling	533884
	2008.08-2014.01		Rear	Saloon RWD 651911		Flexible Coupling Kit	533884S
	2008.08-2014.01		Rear	Saloon RWD 651911		Flexible Coupling Kit	537843S
	2008.08-2014.01		Front;Rear	Saloon RWD 651911		Flexible Coupling Kit	537832S
	2009.05-2014.01		Rear	Estate RWD 651911		Flexible Coupling	537843
	2009.05-2014.01		Front;Rear	Estate RWD 651911		Flexible Coupling	533884
	2009.05-2014.01		Rear	Estate RWD 651911		Flexible Coupling Kit	533884S
	2009.05-2014.01		Rear	Estate RWD 651911		Flexible Coupling Kit	537843S
	2009.05-2014.01		Front;Rear	Saloon 4WD 651912		Flexible Coupling Kit	512673S
	2009.05-2014.01		Front;Rear	Estate RWD 651911		Flexible Coupling Kit	537832S
	2010.04-2014.01		Front;Rear	Estate 4WD 651912		Flexible Coupling Kit	512673S
	2014.02-2018.05		Front;Rear	Saloon 4WD 651921		Flexible Coupling	537627
	2014.02-2018.05		Front;Rear	Saloon RWD 651921		Flexible Coupling	537851
	2014.09-2018.05		Front;Rear	Estate RWD 651921		Flexible Coupling	537851
	2014.10-2018.05		Front;Rear	Estate 4WD 651921		Flexible Coupling	537627
	2015.10-2018.05		Front;Rear	Coupe RWD 651921		Flexible Coupling	537851
	2016.04-2018.05		Front;Rear	Coupe 4WD 651921		Flexible Coupling	537627
	2016.06-2018.05		Front;Rear	Cabriolet RWD 651921		Flexible Coupling	537851
	2.5 (83 kw)	1993.06-2000.05		Centre	Saloon RWD 605910		Center Bearing Support
1993.06-2000.05			Front	Saloon RWD 605910		Flexible Coupling	510569
1993.06-2000.05			Front	Saloon RWD 605910		Flexible Coupling Kit	510570S
2.5 (110 kw)	1995.09-2000.05		Centre	Saloon RWD 605960		Center Bearing Support	512315
	1995.09-2000.05		Front	Saloon RWD 605960		Flexible Coupling	510571
	1995.09-2000.05		Front;Rear	Saloon RWD 605960		Flexible Coupling	510579
	1995.09-2000.05		Front	Saloon RWD 605960	VIN from:A 456789,F 519819,MT,AT	Flexible Coupling Kit	510580S
	1995.09-2000.05		Front	Saloon RWD 605960	VIN to:A 456788,F 519818,MT	Flexible Coupling Kit	537850S
	1996.02-2000.10		Centre	Estate RWD 605960		Center Bearing Support	512315
	1996.02-2000.10		Front	Estate RWD 605960		Flexible Coupling	510571
	1996.02-2000.10		Front;Rear	Estate RWD 605960		Flexible Coupling	510579
	1996.02-2000.10		Front	Estate RWD 605960	VIN from:F 519819,MT	Flexible Coupling Kit	510580S
	1996.02-2000.10		Front	Estate RWD 605960	VIN to:519818,MT	Flexible Coupling Kit	537850S
2.5 (150 kw)	2008.02-2012.12		Centre	Estate RWD 272921		Center Bearing Support	531051
	2008.02-2012.12		Front;Rear	Estate RWD 272921		Flexible Coupling	512678
	2008.02-2012.12		Front;Rear	Estate RWD 272921		Flexible Coupling Kit	512673S
	2008.02-2014.01		Centre	Saloon RWD 272921		Center Bearing Support	531051
	2008.02-2014.01		Front;Rear	Saloon RWD 272921		Flexible Coupling	512678
	2008.02-2014.01		Front;Rear	Saloon RWD 272921		Flexible Coupling Kit	512673S
C270							
2.7 (120 kw)	2000.12-2004.12		Front;Rear	Saloon RWD 612962		Flexible Coupling Kit	512677S
	2001.03-2005.09		Front;Rear	Estate RWD 612962		Flexible Coupling Kit	512677S
2.7 (125 kw)	2000.06-2004.12		Front;Rear	Saloon RWD 612962		Flexible Coupling Kit	512677S
	2000.11-2004.12		Front;Rear	Estate RWD 612962		Flexible Coupling Kit	512677S
C280							
2.8 (142 kw)	1993.06-2000.05		Centre	Saloon RWD 104941		Center Bearing Support	512315
	1993.06-2000.05		Front;Rear	Saloon RWD 104941		Flexible Coupling	510579
	1993.06-2000.05		Front;Rear	Saloon RWD 104941		Flexible Coupling	512678
	1993.06-2000.05		Front	Saloon RWD 104941		Flexible Coupling Kit	510580S



	 YEAR	TRANSM.	FITTING POSITION	BODY STYLE & DRIVE TYPE & ENGINE	REMARKS	 PRODUCT	GSP Ref.
MERCEDES-BENZ C280							
2.8 (145 kw)	1997.04-2000.10		Centre	Estate RWD 112920		Center Bearing Support	512315
	1997.04-2000.10		Front;Rear	Estate RWD 112920		Flexible Coupling	512678
	1997.04-2000.10		Front	Estate RWD 112920		Flexible Coupling Kit	537819S
	1997.04-2000.10		Front;Rear	Estate RWD 112920		Flexible Coupling Kit	512673S
	1997.06-2000.05		Centre	Saloon RWD 112920		Center Bearing Support	512315
	1997.06-2000.05		Front;Rear	Saloon RWD 112920		Flexible Coupling	512678
	1997.06-2000.05		Front	Saloon RWD 112920		Flexible Coupling Kit	537819S
3.0 (170 kw)	1997.06-2000.05		Front;Rear	Saloon RWD 112920		Flexible Coupling Kit	512673S
	2005.01-2007.11		Front;Rear	Estate RWD 272940		Flexible Coupling Kit	512673S
	2005.01-2007.12		Front;Rear	Saloon RWD 272940		Flexible Coupling Kit	512673S
	2005.03-2007.11	AT/MT	Front	Estate 4WD 272941		Propshaft	PS900346
	2005.03-2007.11		Centre	Estate 4WD 272941		Center Bearing Support	518416
	2005.03-2007.11		Front;Rear	Estate 4WD 272941		Flexible Coupling Kit	512673S
	2005.03-2007.12	AT/MT	Front	Saloon 4WD 272941		Propshaft	PS900346
	2005.03-2007.12		Centre	Saloon 4WD 272941		Center Bearing Support	518416
	2005.03-2007.12		Front;Rear	Saloon 4WD 272941		Flexible Coupling Kit	512673S
	2007.02-2014.01		Centre	Saloon RWD 272947		Center Bearing Support	531051
	2007.02-2014.01		Front;Rear	Saloon RWD 272947		Flexible Coupling	512678
	2007.02-2014.01		Front;Rear	Saloon RWD 272947		Flexible Coupling Kit	512673S
	2007.05-2014.01	AT/MT	Front	Saloon 4WD 272948	Date To:2009.12	Propshaft	PS900359
	2007.05-2014.01		Front;Rear	Saloon 4WD 272948		Flexible Coupling	512678
	2007.05-2014.01		Front;Rear	Saloon 4WD 272948		Flexible Coupling Kit	512673S
2007.11-2010.12		Centre	Estate RWD 272947		Center Bearing Support	531051	
2007.11-2010.12		Front;Rear	Estate RWD 272947		Flexible Coupling	512678	
2007.11-2010.12		Front;Rear	Estate RWD 272947		Flexible Coupling Kit	512673S	
C300							
2.0 (180 kw)	2015.01-2018.08		Front	Saloon RWD 274920		Flexible Coupling	537630
	2015.01-2018.08		Front;Rear	Saloon RWD 274920		Flexible Coupling	512677
	2015.01-2018.08		Front;Rear	Saloon RWD 274920		Flexible Coupling Kit	537630S
	2015.09-2018.05		Front	Estate RWD 274920		Flexible Coupling	537630
	2015.09-2018.05		Front;Rear	Estate RWD 274920		Flexible Coupling	512677
	2015.09-2018.05		Front;Rear	Estate RWD 274920		Flexible Coupling Kit	537630S
	2015.10-2018.05		Front;Rear	Coupe RWD 274920		Flexible Coupling	512677
	2015.10-2018.05		Front;Rear	Coupe RWD 274920		Flexible Coupling Kit	537630S
	2016.06-2018.05		Front	Cabriolet RWD 274920		Flexible Coupling	537630
	2016.06-2018.05		Front;Rear	Cabriolet RWD 274920		Flexible Coupling	512677
	2016.06-2018.05		Front;Rear	Cabriolet RWD 274920		Flexible Coupling Kit	537630S
	2018.06-		Front;Rear	Saloon RWD 654920		Flexible Coupling Kit	537630S
	2018.06-		Front;Rear	Saloon 4WD 654920		Flexible Coupling Kit	537630S
	2018.06-		Front;Rear	Estate 4WD 654920		Flexible Coupling Kit	537630S
	2018.06-		Front;Rear	Estate RWD 654920		Flexible Coupling Kit	537630S
	2018.07-		Front;Rear	Coupe 4WD 654920		Flexible Coupling Kit	537630S
	2018.07-		Front;Rear	Cabriolet RWD 654920		Flexible Coupling Kit	537630S
	2018.07-		Front;Rear	Coupe RWD 654920		Flexible Coupling Kit	537630S
2.0 (183 kw)	2018.05-		Front;Rear	Saloon RWD 264920		Flexible Coupling Kit	537630S
2.0 (190 kw)	2018.05-		Front;Rear	Saloon RWD 264920		Flexible Coupling Kit	537630S
	2018.05-		Front;Rear	Cabriolet RWD 264920		Flexible Coupling Kit	537630S
	2018.05-		Front;Rear	Coupe RWD 264920		Flexible Coupling Kit	537630S
	2018.05-		Front;Rear	Estate RWD 264920		Flexible Coupling Kit	537630S
	2018.05-		Front;Rear	Estate 4WD 264920		Flexible Coupling Kit	537630S
	2018.05-		Front;Rear	Saloon 4WD 264920		Flexible Coupling Kit	537630S
2019.05-		Front;Rear	Estate 4WD 264920		Flexible Coupling Kit	537630S	
2.2 (150 kw)	2014.05-2018.05		Front;Rear	Saloon RWD 651921		Flexible Coupling	537851
	2014.10-2018.05		Front;Rear	Estate RWD 651921		Flexible Coupling	537851
3.0 (170 kw)	2007.05-2014.01	AT/MT	Front	Saloon 4WD 272948	Date From:2009.01 to 2011.12	Propshaft	PS900359
	2007.05-2014.01		Front;Rear	Saloon 4WD 272948		Flexible Coupling	512678
	2007.05-2014.01		Front;Rear	Saloon 4WD 272948		Flexible Coupling Kit	512673S
	2008.01-2012.12		Front;Rear	Saloon RWD M 272.947		Flexible Coupling Kit	512673S
	2008.01-2014.01		Centre	Saloon RWD 272947		Center Bearing Support	531051
	2008.01-2014.01		Front;Rear	Saloon RWD 272947		Flexible Coupling Kit	512673S
	2008.02-2014.01		Centre	Estate RWD 272947		Center Bearing Support	531051
	2008.02-2014.01		Front;Rear	Estate RWD 272947		Flexible Coupling	512678
	2008.02-2014.01		Front;Rear	Estate RWD 272947		Flexible Coupling Kit	512673S
	2011.01-2014.01		Centre	Estate 4WD 642832		Center Bearing Support	531051



	 YEAR	TRANSM.	FITTING POSITION	BODY STYLE & DRIVE TYPE & ENGINE	REMARKS	 PRODUCT	GSP Ref.
MERCEDES-BENZ C300							
3.0 (170 kw)	2011.01-2014.01		Centre	Saloon 4WD 642832		Center Bearing Support	531051
	2011.01-2014.01		Front;Rear	Estate 4WD 642832		Flexible Coupling Kit	512673S
	2011.01-2014.01		Front;Rear	Saloon 4WD 642832		Flexible Coupling Kit	512673S
3.5 (185 kw)	2009.09-2014.01		Front	Saloon RWD 276957		Flexible Coupling Kit	537889S
	2009.09-2014.01		Front;Rear	Saloon RWD 276957		Flexible Coupling Kit	512677S
	2011.02-2014.01		Front;Rear	Saloon 4WD 276957		Flexible Coupling Kit	512673S
C32 AMG							
3.2 (260 kw)	2000.11-2004.12		Centre	Estate RWD 112961		Center Bearing Support	518416
	2000.11-2004.12		Front;Rear	Saloon RWD 112961		Flexible Coupling	512677
	2000.11-2004.12		Front;Rear	Estate RWD 112961		Flexible Coupling	512677
	2000.11-2004.12		Front;Rear	Saloon RWD 112961		Flexible Coupling Kit	512677S
	2000.11-2004.12		Front;Rear	Estate RWD 112961		Flexible Coupling Kit	512677S
	2000.11-2004.12		Front;Rear	Saloon RWD 112961		Flexible Coupling Kit	512678S
	2000.11-2004.12		Front;Rear	Estate RWD 112961		Flexible Coupling Kit	512678S
C320							
3.0 (165 kw)	2005.01-2007.02		Front;Rear	Saloon RWD 642910		Flexible Coupling	533884
	2005.01-2007.02		Front;Rear	Saloon RWD 642910		Flexible Coupling Kit	512677S
	2005.01-2007.02		Front;Rear	Saloon RWD 642910	AT	Flexible Coupling Kit	537832S
	2005.01-2007.11		Front;Rear	Estate RWD 642910		Flexible Coupling	533884
	2005.01-2007.11		Front;Rear	Estate RWD 642910		Flexible Coupling Kit	512677S
	2005.01-2007.11		Front;Rear	Estate RWD 642910	AT	Flexible Coupling Kit	537832S
	2007.02-2014.01		Front;Rear	Saloon RWD 642960		Flexible Coupling	533884
	2007.02-2014.01		Front;Rear	Saloon RWD 642960		Flexible Coupling Kit	537832S
	2007.05-2014.01		Centre	Saloon 4WD 642961		Center Bearing Support	531051
	2007.05-2014.01		Front;Rear	Saloon 4WD 642961		Flexible Coupling	512678
	2007.05-2014.01		Front;Rear	Saloon 4WD 642961		Flexible Coupling Kit	512673S
	2007.08-2011.12		Centre	Estate 4WD 642961		Center Bearing Support	531051
	2007.08-2011.12		Front;Rear	Estate 4WD 642961		Flexible Coupling	512678
	2007.08-2011.12		Front;Rear	Estate 4WD 642961		Flexible Coupling Kit	512673S
	2007.11-2010.12		Front;Rear	Estate RWD 642960		Flexible Coupling	533884
	2007.11-2010.12		Front;Rear	Estate RWD 642960		Flexible Coupling Kit	537832S
	3.2 (160 kw)	2000.05-2005.07		Front;Rear	Saloon RWD 112946		Flexible Coupling
2000.05-2005.07			Front;Rear	Saloon RWD 112946		Flexible Coupling Kit	512673S
2000.11-2005.07			Centre	Estate RWD 112946		Center Bearing Support	518416
2000.11-2005.07			Front;Rear	Estate RWD 112946		Flexible Coupling	512678
2000.11-2005.07			Front;Rear	Estate RWD 112946		Flexible Coupling Kit	512673S
2002.06-2005.12			Centre	Coupe RWD 112946		Center Bearing Support	518416
2002.06-2005.12			Front;Rear	Coupe RWD 112946		Flexible Coupling	512678
2002.06-2005.12			Front;Rear	Coupe RWD 112946		Flexible Coupling Kit	512673S
2002.08-2005.07		AT/MT	Front	Saloon 4WD 112953		Propshaft	PS900346
2002.08-2005.07		AT/MT	Front	Estate 4WD 112953	Date To:2005.12	Propshaft	PS900346
2002.08-2005.07			Centre	Saloon 4WD 112953		Center Bearing Support	518416
2002.08-2005.07			Centre	Estate 4WD 112953		Center Bearing Support	518416
2002.08-2005.07			Front;Rear	Saloon 4WD 112953		Flexible Coupling	533884
2002.08-2005.07			Front;Rear	Estate 4WD 112953		Flexible Coupling	533884
2002.08-2005.07			Front;Rear	Saloon 4WD 112953		Flexible Coupling Kit	512673S
2002.08-2005.07			Front;Rear	Estate 4WD 112953		Flexible Coupling Kit	512673S
2003.09-2005.12			Front;Rear	Saloon RWD 112.946		Flexible Coupling Kit	512673S
C350							
3.0 (165 kw)	2007.02-2014.01		Front;Rear	Saloon RWD 642830/642960		Flexible Coupling	533884
	2007.02-2014.01		Front;Rear	Saloon RWD 642830/642960		Flexible Coupling Kit	537832S
	2007.05-2011.12		Centre	Saloon 4WD 642832/642961		Center Bearing Support	531051
	2007.05-2011.12		Front;Rear	Saloon 4WD 642832/642961		Flexible Coupling	512678
	2007.05-2011.12		Front;Rear	Saloon 4WD 642832/642961		Flexible Coupling Kit	512673S
	2007.08-2011.12		Centre	Estate 4WD 642832/642961		Center Bearing Support	531051
	2007.08-2011.12		Front;Rear	Estate 4WD 642832/642961		Flexible Coupling	512678
	2007.08-2011.12		Front;Rear	Estate 4WD 642832/642961		Flexible Coupling Kit	512673S
	2007.11-2011.12		Front;Rear	Estate RWD 642830/642960		Flexible Coupling	533884
	2007.11-2011.12		Front;Rear	Estate RWD 642830/642960		Flexible Coupling Kit	537832S
3.0 (170 kw)	2009.07-2014.01		Centre	Estate 4WD 642832		Center Bearing Support	531051
	2009.07-2014.01		Centre	Saloon 4WD 642832		Center Bearing Support	531051
	2009.07-2014.01		Front;Rear	Estate RWD 642830		Flexible Coupling	533884
	2009.07-2014.01		Front;Rear	Saloon RWD 642830		Flexible Coupling	533884
	2009.07-2014.01		Front;Rear	Estate 4WD 642832		Flexible Coupling Kit	512673S



	 YEAR	TRANSM.	FITTING POSITION	BODY STYLE & DRIVE TYPE & ENGINE	REMARKS	 PRODUCT	GSP Ref.
MERCEDES-BENZ C350							
3.0 (170 kw)	2009.07-2014.01		Front;Rear	Saloon 4WD 642832		Flexible Coupling Kit	512673S
	2009.07-2014.01		Front;Rear	Estate RWD 642830		Flexible Coupling Kit	537832S
	2009.07-2014.01		Front;Rear	Saloon RWD 642830		Flexible Coupling Kit	537832S
3.0 (195 kw)	2011.06-2014.01		Front;Rear	Saloon RWD 642834		Flexible Coupling	533884
	2011.06-2014.01		Front;Rear	Estate RWD 642834		Flexible Coupling	533884
	2011.06-2014.01		Front;Rear	Saloon RWD 642834		Flexible Coupling Kit	537832S
	2011.06-2014.01		Front;Rear	Estate RWD 642834		Flexible Coupling Kit	537832S
3.5 (170 kw)	2005.01-2007.02		Front;Rear	Saloon RWD 272960		Flexible Coupling Kit	512677S
3.5 (200 kw)	2005.01-2007.02		Front;Rear	Saloon RWD 272960		Flexible Coupling Kit	512677S
	2005.01-2007.11		Front;Rear	Estate RWD 272960		Flexible Coupling Kit	512677S
	2005.01-2008.01		Front;Rear	Coupe RWD 272960		Flexible Coupling Kit	512677S
	2005.03-2007.02		Centre	Saloon 4WD 272970		Center Bearing Support	518416
	2005.03-2007.02		Front;Rear	Saloon 4WD 272970		Flexible Coupling Kit	512673S
	2005.04-2007.11		Centre	Estate 4WD 272970		Center Bearing Support	518416
	2005.04-2007.11		Front;Rear	Estate 4WD 272970		Flexible Coupling Kit	512673S
	2007.02-2014.01		Front;Rear	Saloon RWD 272961		Flexible Coupling Kit	512677S
	2007.05-2011.12	AT/MT	Front	Saloon 4WD 272971	Date To:2011.12	Propshaft	PS900359
	2007.05-2011.12		Front;Rear	Saloon 4WD 272971		Flexible Coupling	512678
	2007.05-2011.12		Front;Rear	Saloon 4WD 272971		Flexible Coupling Kit	512673S
	2007.11-2014.01		Front;Rear	Estate RWD 272961		Flexible Coupling Kit	512677S
	3.5 (215 kw)	2008.03-2014.01		Front;Rear	Saloon RWD 272982		Flexible Coupling Kit
3.5 (225 kw)	2011.01-2014.01	AT/MT	Front	Saloon 4WD 276957		Propshaft	PS900359
	2011.01-2014.01		Front	Saloon RWD 276957		Flexible Coupling Kit	537889S
	2011.01-2014.01		Front;Rear	Saloon 4WD 276957		Flexible Coupling Kit	512673S
	2011.01-2014.01		Front;Rear	Saloon RWD 276957		Flexible Coupling Kit	512677S
	2011.06-2014.01		Front	Estate RWD 276957		Flexible Coupling Kit	537889S
	2011.06-2014.01		Front	Coupe RWD 276957		Flexible Coupling Kit	537889S
	2011.06-2014.01		Front;Rear	Estate RWD 276957		Flexible Coupling Kit	512677S
	2011.06-2014.01		Front;Rear	Coupe RWD 276957		Flexible Coupling Kit	512677S
	2013.09-2014.01		Front;Rear	Coupe 4WD 276957		Flexible Coupling Kit	512673S
C36 AMG							
3.6 (206 kw)	1994.01-1998.01		Centre	Saloon RWD 104941AMG		Center Bearing Support	512315
	1994.01-1998.01		Front;Rear	Saloon RWD 104941AMG		Flexible Coupling	510579
	1994.01-1998.01		Front;Rear	Saloon RWD 104941AMG		Flexible Coupling	512678
	1994.01-1998.01		Front	Saloon RWD 104941AMG		Flexible Coupling Kit	510580S
C400							
3.0 (245 kw)	2014.10-	AT	Front	Saloon 4WD 276823	Date From:2015.01	Propshaft	PS900357
	2014.10-	AT	Front	Estate 4WD 276823	Date From:2015.01	Propshaft	PS900357
	2014.10-		Front;Rear	Saloon 4WD 276823		Flexible Coupling	537627
	2014.10-		Front;Rear	Estate 4WD 276823		Flexible Coupling	537627
	2016.04-	AT	Front	Coupe 4WD 276823		Propshaft	PS900357
	2016.04-		Front;Rear	Coupe 4WD 276823		Flexible Coupling	537627
	2016.06-		Front;Rear	Cabriolet 4WD 276823		Flexible Coupling	537627
C43 AMG							
3.0 (270 kw)	2016.04-2018.05	AT	Front	Estate 4WD 276823		Propshaft	PS900357
	2016.04-2018.05	AT	Front	Saloon 4WD 276823		Propshaft	PS900357
	2016.04-2018.05		Front;Rear	Coupe 4WD 276823		Flexible Coupling	537627
	2016.04-2018.05		Front;Rear	Estate 4WD 276823		Flexible Coupling	537627
	2016.04-2018.05		Front;Rear	Coupe 4WD 276823		Flexible Coupling Kit	537630S
	2016.04-2018.05		Front;Rear	Estate 4WD 276823		Flexible Coupling Kit	537630S
	2016.04-2018.05		Front;Rear	Saloon 4WD 276823		Flexible Coupling Kit	537630S
	2016.10-2018.05		Front;Rear	Cabriolet 4WD 276823		Flexible Coupling	537627
	2016.10-2018.05		Front;Rear	Cabriolet 4WD 276823		Flexible Coupling Kit	537630S
3.0 (287 kw)	2018.05-	AT	Front	Estate 4WD 276823		Propshaft	PS900357
	2018.05-	AT	Front	Saloon 4WD 276823		Propshaft	PS900357
	2018.05-		Front;Rear	Estate 4WD 276823		Flexible Coupling Kit	537630S
	2018.05-		Front;Rear	Coupe 4WD 276823		Flexible Coupling Kit	537630S
	2018.05-		Front;Rear	Saloon 4WD 276823		Flexible Coupling Kit	537630S
	2018.05-		Front;Rear	Cabriolet 4WD 276823		Flexible Coupling Kit	537630S
4.3 (225 kw)	1996.12-2000.12		Front;Rear	Saloon RWD 113944		Flexible Coupling	512677
	1997.04-2000.05		Front;Rear	Estate RWD 113944		Flexible Coupling	512677
C450 AMG							
3.0 (270 kw)	2015.04-2018.05	AT	Front	Estate 4WD 276823		Propshaft	PS900357
	2015.04-2018.05	AT	Front	Saloon 4WD 276823		Propshaft	PS900357



	 YEAR	TRANSM.	FITTING POSITION	BODY STYLE & DRIVE TYPE & ENGINE	REMARKS	 PRODUCT	GSP Ref.
MERCEDES-BENZ							
C450 AMG							
3.0 (270 kw)	2015.04-2018.05		Front	Estate 4WD 276823		Flexible Coupling	537630
	2015.04-2018.05		Front	Saloon 4WD 276823		Flexible Coupling	537630
	2015.04-2018.05		Front;Rear	Estate 4WD 276823		Flexible Coupling	537627
	2015.04-2018.05		Front;Rear	Saloon 4WD 276823		Flexible Coupling	537627
	2015.04-2018.05		Front;Rear	Estate 4WD 276823		Flexible Coupling Kit	537630S
	2015.04-2018.05		Front;Rear	Saloon 4WD 276823		Flexible Coupling Kit	537630S
C55 AMG							
5.4 (270 kw)	2003.08-2007.02		Front	Saloon RWD 113988		Flexible Coupling	512676
	2003.08-2007.02		Front	Saloon RWD 113988		Flexible Coupling Kit	512671S
C63 AMG							
6.2 (336 kw)	2007.08-2014.01		Centre	Saloon RWD 156985		Center Bearing Support	531051
	2007.08-2014.01		Rear	Saloon RWD 156985		Flexible Coupling	537843
	2007.08-2014.01		Front;Rear	Saloon RWD 156985		Flexible Coupling	533884
	2007.08-2014.01		Front;Rear	Saloon RWD 156985		Flexible Coupling Kit	537832S
	2008.02-2014.08		Centre	Estate RWD 156985		Center Bearing Support	531051
	2008.02-2014.08		Rear	Estate RWD 156985		Flexible Coupling	537843
	2008.02-2014.08		Front;Rear	Estate RWD 156985		Flexible Coupling	533884
	2008.02-2014.08		Rear	Estate RWD 156985		Flexible Coupling Kit	533884S
	2008.02-2014.08		Front;Rear	Estate RWD 156985		Flexible Coupling Kit	537832S
	2011.06-2014.01		Centre	Coupe RWD 156985		Center Bearing Support	531051
6.2 (358 kw)	2011.01-2014.01		Centre	Coupe RWD 156985		Center Bearing Support	531051
	2011.01-2014.01		Rear	Saloon RWD 156985		Flexible Coupling	537843
	2011.01-2014.01		Front;Rear	Saloon RWD 156985		Flexible Coupling	533884
	2011.01-2014.01		Front;Rear	Saloon RWD 156985		Flexible Coupling Kit	537832S
	2011.01-2014.08		Rear	Estate RWD 156985		Flexible Coupling	537843
	2011.01-2014.08		Front;Rear	Estate RWD 156985		Flexible Coupling	533884
	2011.01-2014.08		Rear	Estate RWD 156985		Flexible Coupling Kit	533884S
	2011.01-2014.08		Front;Rear	Estate RWD 156985		Flexible Coupling Kit	537832S
6.2 (373 kw)	2013.05-2014.01		Centre	Coupe RWD 156985		Center Bearing Support	531051
	2013.05-2014.01		Rear	Saloon RWD 156985		Flexible Coupling	537843
	2013.05-2014.01		Front;Rear	Saloon RWD 156985		Flexible Coupling	533884
	2013.05-2014.01		Front;Rear	Saloon RWD 156985		Flexible Coupling Kit	537832S
6.2 (380 kw)	2012.01-2014.01		Centre	Coupe RWD 156985		Center Bearing Support	531051
6.2 (383 kw)	2010.07-2011.08		Centre	Saloon RWD 156985		Center Bearing Support	531051
6.3 (336 kw)	2012.09-		Centre	Coupe RWD M 156.985		Center Bearing Support	531051
CL420							
4.2 (205 kw)	1996.07-1999.09		Front	Coupe RWD 119971/119981		Flexible Coupling	512676
	1996.07-1999.09		Front;Rear	Coupe RWD 119971/119981		Flexible Coupling	512677
	1996.07-1999.09		Front	Coupe RWD 119971/119981		Flexible Coupling Kit	512671S
	1996.07-1999.09		Rear	Coupe RWD 119971/119981		Flexible Coupling Kit	512672S
CL500							
4.7 (320 kw)	2010.10-2013.12	AT	Front	Coupe 4WD 278920		Propshaft	PS900357
	2010.10-2013.12		Front;Rear	Coupe 4WD 278920		Flexible Coupling Kit	512677S
5.0 (225 kw)	1999.09-2006.12		Front;Rear	Coupe RWD 113960		Flexible Coupling	512677
	1999.09-2006.12		Front;Rear	Coupe RWD 113960		Flexible Coupling Kit	512677S
5.0 (235 kw)	1996.07-1999.03		Front	Coupe RWD 119970		Flexible Coupling	512676
	1996.07-1999.03		Front;Rear	Coupe RWD 119970		Flexible Coupling	512677
	1996.07-1999.03		Front	Coupe RWD 119970		Flexible Coupling Kit	512671S
	1996.07-1999.03		Rear	Coupe RWD 119970		Flexible Coupling Kit	512672S
5.5 (285 kw)	2006.08-2013.12		Front;Rear	Coupe RWD 273961		Flexible Coupling	533884
	2006.08-2013.12		Front;Rear	Coupe RWD 273961		Flexible Coupling Kit	537832S
	2008.02-2013.12	AT	Front	Coupe 4WD 273968		Propshaft	PS900357
	2008.02-2013.12	AT/MT	Front	Coupe 4WD 273968		Propshaft	PS900359
	2008.02-2013.12		Front;Rear	Coupe 4WD 273968		Flexible Coupling Kit	512673S
CL55 AMG							
5.4 (265 kw)	2000.04-2002.07		Front	Coupe RWD 113986		Flexible Coupling	512676
	2000.04-2002.07		Front	Coupe RWD 113986		Flexible Coupling Kit	512671S
5.4 (368 kw)	2002.08-2006.12		Front;Rear	Coupe RWD 113991		Flexible Coupling	533884
	2002.08-2006.12		Front;Rear	Coupe RWD 113991		Flexible Coupling Kit	537832S
CL600							
5.5 (368 kw)	2002.08-2006.07		Front;Rear	Coupe RWD 275950		Flexible Coupling	533884
	2002.08-2006.07		Front;Rear	Coupe RWD 275950		Flexible Coupling Kit	537832S
5.5 (380 kw)	2006.08-2013.12		Front;Rear	Coupe RWD 275953		Flexible Coupling	533884
	2006.08-2013.12		Front;Rear	Coupe RWD 275953		Flexible Coupling Kit	537832S



	 YEAR	TRANSM.	FITTING POSITION	BODY STYLE & DRIVE TYPE & ENGINE	REMARKS	 PRODUCT	GSP Ref.
MERCEDES-BENZ CL600							
5.8 (270 kw)	1999.09-2002.12		Centre	Coupe RWD 137970		Center Bearing Support	512668
	1999.09-2002.12		Front	Coupe RWD 137970		Flexible Coupling	512676
	1999.09-2002.12		Front	Coupe RWD 137970		Flexible Coupling Kit	512671S
6.0 (290 kw)	1996.07-1999.08		Front	Coupe RWD 120982		Flexible Coupling	512676
	1996.07-1999.08		Front	Coupe RWD 120982		Flexible Coupling Kit	512671S
CL63 AMG							
6.2 (386 kw)	2006.10-2013.12		Front;Rear	Coupe RWD 156984		Flexible Coupling	533884
	2006.10-2013.12		Front;Rear	Coupe RWD 156984		Flexible Coupling Kit	537832S
6.3 (386 kw)	2007.09-2011.12		Front;Rear	Coupe RWD M 156.984		Flexible Coupling	533884
	2007.09-2011.12		Front;Rear	Coupe RWD M 156.984		Flexible Coupling Kit	537832S
CL65 AMG							
6.0 (450 kw)	2003.04-2006.12		Front;Rear	Coupe RWD 275980		Flexible Coupling	533884
	2003.04-2006.12		Front;Rear	Coupe RWD 275980		Flexible Coupling Kit	537832S
	2006.10-2010.12		Front;Rear	Coupe RWD 275982		Flexible Coupling	533884
	2006.10-2010.12		Front;Rear	Coupe RWD 275982		Flexible Coupling Kit	537832S
6.0 (463 kw)	2011.02-2013.12		Front;Rear	Coupe RWD 275982		Flexible Coupling	533884
	2011.02-2013.12		Front;Rear	Coupe RWD 275982		Flexible Coupling Kit	537832S
CLA180							
1.5 (80 kw)	2013.10-2018.05		Front	Coupe FWD 607951		Flexible Coupling Kit	537796S
	2015.07-2018.05		Front	Estate FWD 607951		Flexible Coupling Kit	537796S
1.6 (90 kw)	2013.01-2019.03		Front	Coupe FWD 270910		Flexible Coupling Kit	537796S
	2015.01-2019.03		Front	Estate FWD 270910		Flexible Coupling Kit	537796S
CLA200							
1.6 (110 kw)	2018.07-2019.03		Front	Coupe FWD 270910		Flexible Coupling Kit	537796S
1.6 (115 kw)	2013.01-2019.03		Front	Coupe FWD 270910		Flexible Coupling Kit	537796S
	2015.01-2019.03		Front	Estate FWD 270910		Flexible Coupling Kit	537796S
1.8 (100 kw)	2013.06-2014.08		Front	Coupe FWD 651901		Flexible Coupling Kit	537796S
2.0 (135 kw)	2015.08-2019.03		Front	Coupe FWD 270920		Flexible Coupling Kit	537796S
2.2 (100 kw)	2014.07-2019.03		Front	Coupe 4WD 651930		Flexible Coupling Kit	537796S
	2014.07-2019.03		Front	Coupe FWD 651930		Flexible Coupling Kit	537796S
	2015.01-2019.03		Front	Estate 4WD 651930		Flexible Coupling Kit	537796S
2015.01-2019.03		Front	Estate FWD 651930		Flexible Coupling Kit	537796S	
CLA220							
2.0 (135 kw)	2015.01-2019.03		Front	Coupe 4WD 270920		Flexible Coupling Kit	537796S
	2016.04-2019.03		Front	Estate 4WD 270920		Flexible Coupling Kit	537796S
	2016.04-2019.03		Front	Coupe FWD 270920		Flexible Coupling Kit	537796S
2.2 (120 kw)	2013.01-2019.03		Front	Coupe FWD 651930		Flexible Coupling Kit	537796S
	2014.08-2019.03		Front	Coupe 4WD 651930		Flexible Coupling Kit	537796S
	2015.01-2019.03		Front	Estate FWD 651930		Flexible Coupling Kit	537796S
	2015.09-2019.03		Front	Estate 4WD 651930		Flexible Coupling Kit	537796S
2.2 (125 kw)	2013.01-2019.03		Front	Coupe FWD 651930		Flexible Coupling Kit	537796S
	2014.07-2019.03		Front	Coupe 4WD 651930		Flexible Coupling Kit	537796S
	2018.07-2019.03		Front	Estate 4WD 651930		Flexible Coupling Kit	537796S
	2018.07-2019.03		Front	Estate FWD 651930		Flexible Coupling Kit	537796S
2.2 (130 kw)	2014.09-2019.03		Front	Coupe 4WD 651930		Flexible Coupling Kit	537796S
	2014.09-2019.03		Front	Coupe FWD 651930		Flexible Coupling Kit	537796S
	2015.01-2019.03		Front	Estate FWD 651930		Flexible Coupling Kit	537796S
	2015.01-2019.03		Front	Estate 4WD 651930		Flexible Coupling Kit	537796S
CLA250							
2.0 (155 kw)	2013.01-2019.03		Front	Coupe FWD 270920		Flexible Coupling Kit	537796S
	2013.07-2019.03		Front	Coupe 4WD 270920		Flexible Coupling Kit	537796S
	2015.01-2019.03		Front	Estate FWD 270920		Flexible Coupling Kit	537796S
	2015.01-2019.03		Front	Estate 4WD 270920		Flexible Coupling Kit	537796S
2.0 (160 kw)	2015.07-2019.03		Front	Coupe FWD 270920		Flexible Coupling Kit	537796S
	2015.07-2019.03		Front	Coupe 4WD 270920		Flexible Coupling Kit	537796S
	2015.07-2019.03		Front	Estate 4WD 270920		Flexible Coupling Kit	537796S
CLC160							
1.6 (95 kw)	2009.02-2011.06		Centre	Coupe RWD 271911		Center Bearing Support	518416
	2009.02-2011.06		Front;Rear	Coupe RWD 271911		Flexible Coupling Kit	512673S
CLC180							
1.8 (105 kw)	2008.05-2011.06		Centre	Coupe RWD 271946		Center Bearing Support	518416
	2008.05-2011.06		Front;Rear	Coupe RWD 271946		Flexible Coupling Kit	512673S



	 YEAR	TRANSM.	FITTING POSITION	BODY STYLE & DRIVE TYPE & ENGINE	REMARKS	 PRODUCT	GSP Ref.
MERCEDES-BENZ							
CLC200							
1.8 (135 kw)	2008.05-2011.06		Centre	Coupe RWD 271957		Center Bearing Support	518416
	2008.05-2011.06		Front;Rear	Coupe RWD 271957		Flexible Coupling Kit	512673S
2.2 (90 kw)	2008.05-2011.06		Front;Rear	Coupe RWD 646962/646963		Flexible Coupling Kit	512673S
CLC220							
2.2 (100 kw)	2008.05-2011.06		Front;Rear	Coupe RWD 646963		Flexible Coupling Kit	512677S
2.2 (110 kw)	2008.05-2011.06		Front;Rear	Coupe RWD 646963		Flexible Coupling Kit	512677S
CLC230							
2.5 (150 kw)	2008.05-2011.06		Centre	Coupe RWD 272920		Center Bearing Support	518416
	2008.05-2011.06		Front;Rear	Coupe RWD 272920		Flexible Coupling Kit	512673S
CLC250							
2.5 (150 kw)	2009.06-2011.06		Front;Rear	Coupe RWD 272920		Flexible Coupling Kit	512673S
CLC350							
3.5 (200 kw)	2008.05-2011.06		Front;Rear	Coupe RWD 272960		Flexible Coupling Kit	512677S
CLK200							
1.8 (120 kw)	2002.08-2006.05		Centre	Coupe RWD 271940		Center Bearing Support	518416
	2002.08-2006.05		Front;Rear	Coupe RWD 271940		Flexible Coupling	512678
	2002.08-2006.05		Front;Rear	Coupe RWD 271940		Flexible Coupling Kit	512673S
	2003.02-2010.03		Centre	Cabriolet RWD 271940		Center Bearing Support	518416
	2003.02-2010.03		Front;Rear	Cabriolet RWD 271940		Flexible Coupling	512678
	2003.02-2010.03		Front;Rear	Cabriolet RWD 271940		Flexible Coupling Kit	512673S
1.8 (125 kw)	2002.08-2005.07		Centre	Coupe RWD 271942		Center Bearing Support	518416
	2002.08-2005.07		Front;Rear	Coupe RWD 271942		Flexible Coupling	512678
	2002.08-2005.07		Front;Rear	Coupe RWD 271942		Flexible Coupling Kit	512673S
	2003.07-2010.03		Front;Rear	Cabriolet RWD 271942		Flexible Coupling Kit	512673S
1.8 (135 kw)	2007.05-2010.03		Centre	Cabriolet RWD 271955		Center Bearing Support	518416
	2007.05-2010.03		Front;Rear	Cabriolet RWD 271955		Flexible Coupling	512678
	2007.05-2010.03		Front;Rear	Cabriolet RWD 271955		Flexible Coupling Kit	512673S
	2007.05-2010.12		Centre	Coupe RWD 271955		Center Bearing Support	518416
	2007.05-2010.12		Front;Rear	Coupe RWD 271955		Flexible Coupling	512678
	2007.05-2010.12		Front;Rear	Coupe RWD 271955		Flexible Coupling Kit	512673S
2.0 (100 kw)	1997.04-2000.05		Centre	Coupe RWD 111945		Center Bearing Support	512316
	1997.04-2000.05		Front	Coupe RWD 111945		Flexible Coupling	510569
	1997.04-2000.05		Front	Coupe RWD 111945	MT,for vehicles without air conditioning	Flexible Coupling	512326
	1997.04-2000.05		Front	Coupe RWD 111945		Flexible Coupling Kit	510570S
	1997.04-2000.05		Front	Coupe RWD 111945		Flexible Coupling Kit	510578S
	1997.04-2000.05		Front	Coupe RWD 111945	AT,MT,for vehicles with air conditioning	Flexible Coupling Kit	537821S
	1998.06-2002.03		Front	Cabriolet RWD 111945		Flexible Coupling	510569
	1998.06-2002.03		Front	Cabriolet RWD 111945	MT,for vehicles without air conditioning	Flexible Coupling	512326
	1998.06-2002.03		Front	Cabriolet RWD 111945		Flexible Coupling Kit	510570S
	1998.06-2002.03		Front	Cabriolet RWD 111945		Flexible Coupling Kit	510578S
1998.06-2002.03		Front	Cabriolet RWD 111945	AT,MT,for vehicles with air conditioning	Flexible Coupling Kit	537821S	
2.0 (120 kw)	2000.06-2002.07		Centre	Cabriolet RWD 111956		Center Bearing Support	512315
	2000.06-2002.07		Centre	Coupe RWD 111956		Center Bearing Support	512315
	2000.06-2002.07		Front	Cabriolet RWD 111956		Flexible Coupling	510571
	2000.06-2002.07		Front	Coupe RWD 111956		Flexible Coupling	510571
	2000.06-2002.07		Front;Rear	Cabriolet RWD 111956		Flexible Coupling	512678
	2000.06-2002.07		Front;Rear	Coupe RWD 111956		Flexible Coupling	512678
	2000.06-2002.07		Front	Cabriolet RWD 111956		Flexible Coupling Kit	510571S
	2000.06-2002.07		Front	Coupe RWD 111956		Flexible Coupling Kit	510571S
	2000.06-2002.07		Front;Rear	Cabriolet RWD 111956		Flexible Coupling Kit	512673S
	2000.06-2002.07		Front;Rear	Coupe RWD 111956		Flexible Coupling Kit	512673S
2.0 (141 kw)	1997.06-2000.06		Centre	Coupe RWD 111944		Center Bearing Support	512315
	1997.06-2000.06		Front	Coupe RWD 111944		Flexible Coupling	510571
	1997.06-2000.06		Front;Rear	Coupe RWD 111944		Flexible Coupling	510579
	1997.06-2000.06		Front	Coupe RWD 111944		Flexible Coupling Kit	510571S
	1997.06-2000.06		Front	Coupe RWD 111944		Flexible Coupling Kit	510580S
	1997.06-2000.06		Front	Coupe RWD 111944		Flexible Coupling Kit	537796S
	1998.06-2000.06		Centre	Cabriolet RWD 111944		Center Bearing Support	512315
	1998.06-2000.06		Front	Cabriolet RWD 111944		Flexible Coupling	510571
	1998.06-2000.06		Front;Rear	Cabriolet RWD 111944		Flexible Coupling	510579
	1998.06-2000.06		Front	Cabriolet RWD 111944		Flexible Coupling Kit	510571S
	1998.06-2000.06		Front	Cabriolet RWD 111944		Flexible Coupling Kit	510580S
	1998.06-2000.06		Front	Cabriolet RWD 111944		Flexible Coupling Kit	537796S



	 YEAR	TRANSM.	FITTING POSITION	BODY STYLE & DRIVE TYPE & ENGINE	REMARKS	 PRODUCT	GSP Ref.
MERCEDES-BENZ CLK220							
2.2 (100 kw)	2005.01-2009.05		Front;Rear	Coupe RWD 646966		Flexible Coupling Kit	512677S
2.2 (110 kw)	2005.05-2010.12		Front;Rear	Coupe RWD 646966		Flexible Coupling Kit	512677S
CLK230							
2.3 (142 kw)	1997.04-2000.05		Centre	Coupe RWD 111975		Center Bearing Support	512315
	1997.04-2000.05		Front	Coupe RWD 111975		Flexible Coupling	510571
	1997.04-2000.05		Front;Rear	Coupe RWD 111975		Flexible Coupling	510579
	1997.04-2000.05		Front	Coupe RWD 111975		Flexible Coupling Kit	510571S
	1997.04-2000.05		Front	Coupe RWD 111975		Flexible Coupling Kit	510580S
	1997.04-2000.05		Front	Coupe RWD 111975		Flexible Coupling Kit	537796S
	1998.06-2000.05		Centre	Cabriolet RWD 111975		Center Bearing Support	512315
	1998.06-2000.05		Front	Cabriolet RWD 111975	For OE No.124 411 05 15	Flexible Coupling	510571
	1998.06-2000.05		Front	Cabriolet RWD 111975	For OE No.1294110015	Flexible Coupling	512676
	1998.06-2000.05		Front;Rear	Cabriolet RWD 111975		Flexible Coupling	510579
	1998.06-2000.05		Front	Cabriolet RWD 111975		Flexible Coupling Kit	510571S
	1998.06-2000.05		Front	Cabriolet RWD 111975		Flexible Coupling Kit	510580S
	1998.06-2000.05		Front	Cabriolet RWD 111975		Flexible Coupling Kit	512671S
	1998.06-2000.05		Front	Cabriolet RWD 111975		Flexible Coupling Kit	537796S
2.3 (145 kw)	1999.09-2002.07		Centre	Cabriolet RWD 111982		Center Bearing Support	512315
	1999.09-2002.07		Front	Cabriolet RWD 111982		Flexible Coupling	510571
	1999.09-2002.07		Front;Rear	Cabriolet RWD 111982		Flexible Coupling	512678
	1999.09-2002.07		Front	Cabriolet RWD 111982		Flexible Coupling Kit	510571S
	1999.09-2002.07		Front;Rear	Cabriolet RWD 111982		Flexible Coupling Kit	512673S
	1999.09-2003.01		Centre	Coupe RWD 111982		Center Bearing Support	512315
	1999.09-2003.01		Front	Coupe RWD 111982		Flexible Coupling	510571
	1999.09-2003.01		Front;Rear	Coupe RWD 111982		Flexible Coupling	512678
	1999.09-2003.01		Front	Coupe RWD 111982		Flexible Coupling Kit	510571S
	1999.09-2003.01		Front;Rear	Coupe RWD 111982		Flexible Coupling Kit	512673S
CLK240							
2.6 (120 kw)	2002.06-2005.07		Front;Rear	Coupe RWD 112912		Flexible Coupling Kit	512673S
2.6 (125 kw)	2002.08-2005.07		Centre	Coupe RWD 112912		Center Bearing Support	518416
	2002.08-2005.07		Front;Rear	Coupe RWD 112912		Flexible Coupling	512678
	2002.08-2005.07		Front;Rear	Coupe RWD 112912		Flexible Coupling Kit	512673S
	2003.02-2005.07		Centre	Cabriolet RWD 112912		Center Bearing Support	518416
	2003.02-2005.07		Front;Rear	Cabriolet RWD 112912		Flexible Coupling	512678
	2003.02-2005.07		Front;Rear	Cabriolet RWD 112912		Flexible Coupling Kit	512673S
	CLK270						
2.7 (120 kw)	2003.02-2005.06		Front;Rear	Coupe RWD 612962/612967		Flexible Coupling Kit	512677S
2.7 (125 kw)	2002.08-2005.07		Front;Rear	Coupe RWD 612962/612967		Flexible Coupling Kit	512677S
CLK280							
3.0 (170 kw)	2005.03-2010.03		Front;Rear	Cabriolet RWD 272940		Flexible Coupling Kit	512673S
	2005.03-2010.12		Front;Rear	Coupe RWD 272940		Flexible Coupling	512678
	2005.03-2010.12		Front;Rear	Coupe RWD 272940		Flexible Coupling Kit	512673S
CLK320							
3.0 (165 kw)	2005.03-2010.03		Front;Rear	Cabriolet RWD 642910		Flexible Coupling	533884
	2005.03-2010.03		Front;Rear	Cabriolet RWD 642910		Flexible Coupling Kit	512677S
	2005.03-2010.03		Front;Rear	Cabriolet RWD 642910	AT	Flexible Coupling Kit	537832S
	2005.03-2010.12		Front;Rear	Coupe RWD 642910		Flexible Coupling	533884
	2005.03-2010.12		Front;Rear	Coupe RWD 642910		Flexible Coupling Kit	512677S
	2005.03-2010.12		Front;Rear	Coupe RWD 642910	AT	Flexible Coupling Kit	537832S
3.2 (160 kw)	1997.04-2002.07		Centre	Coupe RWD 112940		Center Bearing Support	512315
	1997.04-2002.07		Front;Rear	Coupe RWD 112940		Flexible Coupling	510579
	1999.01-2003.12		Centre	Cabriolet RWD 112940		Center Bearing Support	512315
	1999.01-2003.12		Front;Rear	Cabriolet RWD 112940		Flexible Coupling	510579
	1999.01-2003.12		Front	Cabriolet RWD 112940		Flexible Coupling Kit	510580S
	2002.08-2005.07		Centre	Coupe RWD 112955		Center Bearing Support	518416
	2002.08-2005.07		Front;Rear	Coupe RWD 112955		Flexible Coupling	512678
	2002.08-2005.07		Front;Rear	Coupe RWD 112955		Flexible Coupling Kit	512673S
	2003.01-2005.12		Centre	Cabriolet RWD 112955		Center Bearing Support	518416
	2003.01-2005.12		Front;Rear	Cabriolet RWD 112955		Flexible Coupling	512678
2003.01-2005.12		Front;Rear	Cabriolet RWD 112955		Flexible Coupling Kit	512673S	
CLK350							
3.5 (200 kw)	2005.03-2010.03		Front;Rear	Cabriolet RWD 272960		Flexible Coupling Kit	512677S
	2005.03-2010.12		Front;Rear	Coupe RWD 272960		Flexible Coupling Kit	512677S



	 YEAR	TRANSM.	FITTING POSITION	BODY STYLE & DRIVE TYPE & ENGINE	REMARKS	 PRODUCT	GSP Ref.
MERCEDES-BENZ CLK430							
4.3 (205 kw)	1997.04-2003.07		Centre	Coupe RWD 113943		Center Bearing Support	512315
	1997.04-2003.07		Front;Rear	Coupe RWD 113943		Flexible Coupling	512677
	1999.08-2003.01		Centre	Cabriolet RWD 113943		Center Bearing Support	512315
	1999.08-2003.01		Front;Rear	Cabriolet RWD 113943		Flexible Coupling	512677
CLK500							
5.0 (225 kw)	2002.06-2009.05		Front;Rear	Coupe RWD 113968		Flexible Coupling Kit	512677S
	2003.02-2006.12		Front;Rear	Cabriolet RWD 113968		Flexible Coupling Kit	512677S
5.5 (285 kw)	2006.06-2010.03		Front;Rear	Cabriolet RWD 273967		Flexible Coupling	533884
	2006.06-2010.03		Front;Rear	Cabriolet RWD 273967		Flexible Coupling Kit	537832S
	2006.06-2010.12		Front;Rear	Coupe RWD 273967		Flexible Coupling	533884
	2006.06-2010.12		Front;Rear	Coupe RWD 273967		Flexible Coupling Kit	537832S
CLK55 AMG							
5.4 (255 kw)	1998.10-2003.12		Centre	Coupe RWD 113984		Center Bearing Support	512315
	1998.10-2003.12		Front	Coupe RWD 113984		Flexible Coupling	512676
	1998.10-2003.12		Front	Coupe RWD 113984		Flexible Coupling Kit	512671S
5.4 (270 kw)	2002.06-2006.05		Front	Cabriolet RWD 113987		Flexible Coupling	512676
	2002.06-2006.05		Front	Coupe RWD 113987		Flexible Coupling	512676
	2002.06-2006.05		Front	Cabriolet RWD 113987		Flexible Coupling Kit	512671S
	2002.06-2006.05		Front	Coupe RWD 113987		Flexible Coupling Kit	512671S
CLK63 AMG							
6.2 (354 kw)	2006.06-2009.05		Front;Rear	Coupe RWD 156982		Flexible Coupling	533884
	2006.06-2009.05		Front;Rear	Coupe RWD 156982		Flexible Coupling Kit	537832S
	2006.06-2010.03		Front;Rear	Cabriolet RWD 156982		Flexible Coupling	533884
	2006.06-2010.03		Front;Rear	Cabriolet RWD 156982		Flexible Coupling Kit	537832S
6.3 (354 kw)	2006.09-2009.12		Front;Rear	Convertible RWD M 156.982		Flexible Coupling	533884
	2006.09-2009.12		Front;Rear	Convertible RWD M 156.982		Flexible Coupling Kit	537832S
CLS220							
2.0 (143 kw)	2018.06-		Front;Rear	Coupe RWD 654920		Flexible Coupling Kit	537630S
2.2 (120 kw)	2014.05-2017.12		Front	Coupe RWD 651924		Flexible Coupling	537630
	2014.05-2017.12		Front;Rear	Coupe RWD 651924		Flexible Coupling Kit	512677S
	2014.05-2017.12		Front;Rear	Estate RWD 651924		Flexible Coupling Kit	512677S
	2014.05-2017.12		Front;Rear	Coupe RWD 651924		Flexible Coupling Kit	537630S
	2014.05-2017.12		Front;Rear	Estate RWD 651924		Flexible Coupling Kit	537630S
	2014.05-2017.12		Front;Rear	Estate RWD 651924		Flexible Coupling Kit	537630S
2.2 (125 kw)	2014.05-2017.12		Front	Coupe RWD 651924		Flexible Coupling	537630
	2014.05-2017.12		Front;Rear	Coupe RWD 651924		Flexible Coupling Kit	512677S
	2014.05-2017.12		Front;Rear	Estate RWD 651924		Flexible Coupling Kit	512677S
	2014.05-2017.12		Front;Rear	Coupe RWD 651924		Flexible Coupling Kit	537630S
	2014.05-2017.12		Front;Rear	Estate RWD 651924		Flexible Coupling Kit	537630S
2.2 (130 kw)	2014.05-2017.12		Front	Coupe RWD 651924		Flexible Coupling	537630
	2014.05-2017.12		Front;Rear	Coupe RWD 651924		Flexible Coupling Kit	512677S
	2014.05-2017.12		Front;Rear	Estate RWD 651924		Flexible Coupling Kit	512677S
	2014.05-2017.12		Front;Rear	Coupe RWD 651924		Flexible Coupling Kit	537630S
	2014.05-2017.12		Front;Rear	Estate RWD 651924		Flexible Coupling Kit	537630S
CLS250							
2.2 (150 kw)	2011.04-2017.12		Front	Coupe RWD 651924		Flexible Coupling	537851
	2011.04-2017.12		Front;Rear	Coupe RWD 651924		Flexible Coupling	533884
	2011.04-2017.12		Front;Rear	Coupe RWD 651924		Flexible Coupling Kit	537832S
	2012.10-2017.12		Front	Estate RWD 651924		Flexible Coupling	537851
	2012.10-2017.12		Front;Rear	Estate RWD 651924		Flexible Coupling	533884
	2012.10-2017.12		Front;Rear	Estate RWD 651924		Flexible Coupling Kit	537832S
	2014.05-2017.12		Front	Coupe 4WD 651924		Flexible Coupling	537851
	2014.05-2017.12		Front	Estate 4WD 651924		Flexible Coupling	537851
	2014.05-2017.12		Front;Rear	Coupe 4WD 651924		Flexible Coupling Kit	512673S
	2014.05-2017.12		Front;Rear	Estate 4WD 651924		Flexible Coupling Kit	512673S
CLS260							
2.0 (155 kw)	2015.01-2017.12		Front	Coupe RWD 274920		Flexible Coupling	537851
CLS280							
3.0 (170 kw)	2008.07-2010.12		Front;Rear	Coupe RWD 272943		Flexible Coupling Kit	512673S
CLS300							
2.0 (180 kw)	2018.04-		Front;Rear	Coupe RWD 654920		Flexible Coupling	537851
2.0 (190 kw)	2018.07-		Front;Rear	Coupe RWD 264920		Flexible Coupling Kit	537630S
3.0 (170 kw)	2009.04-2010.12		Front;Rear	Coupe RWD 272943		Flexible Coupling Kit	512673S
3.5 (185 kw)	2011.10-2014.05		Front	Coupe RWD 276952		Flexible Coupling Kit	537889S
	2011.10-2014.05		Front;Rear	Coupe RWD 276952		Flexible Coupling Kit	512677S



	 YEAR	TRANSM.	FITTING POSITION	BODY STYLE & DRIVE TYPE & ENGINE	REMARKS	 PRODUCT	GSP Ref.
MERCEDES-BENZ CLS320							
3.0 (155 kw)	2005.01-2010.12		Front;Rear	Coupe RWD 642920		Flexible Coupling	533884
	2005.01-2010.12		Front;Rear	Coupe RWD 642920		Flexible Coupling Kit	537832S
3.0 (165 kw)	2005.03-2010.12		Front;Rear	Coupe RWD 642920		Flexible Coupling	533884
	2005.03-2010.12		Front;Rear	Coupe RWD 642920		Flexible Coupling Kit	537832S
3.0 (200 kw)	2015.01-2017.12		Front	Coupe RWD 276820		Flexible Coupling	537851
CLS350							
2.0 (220 kw)	2018.08-		Front;Rear	Coupe 4WD 264920		Flexible Coupling	537627
	2018.08-		Front;Rear	Coupe 4WD 264920		Flexible Coupling Kit	537627S
	2018.08-		Front;Rear	Coupe RWD 264920		Flexible Coupling Kit	537630S
2.9 (183 kw)	2017.12-		Front	Coupe 4WD 656929		Flexible Coupling	537630
	2017.12-		Front;Rear	Coupe 4WD 656929		Flexible Coupling Kit	537630S
2.9 (210 kw)	2017.12-		Front;Rear	Coupe 4WD 656929		Flexible Coupling Kit	537630S
3.0 (165 kw)	2009.04-2010.12		Front;Rear	Coupe RWD 642920		Flexible Coupling	533884
	2009.04-2010.12		Front;Rear	Coupe RWD 642920		Flexible Coupling Kit	537832S
3.0 (185 kw)	2013.02-2017.12		Centre	Coupe 4WD 642854/642858		Center Bearing Support	531051
	2013.02-2017.12		Front	Coupe RWD 642852/642853		Flexible Coupling	537851
	2013.02-2017.12		Front;Rear	Coupe RWD 642852/642853		Flexible Coupling	533884
	2013.02-2017.12		Front;Rear	Coupe 4WD 642854/642858		Flexible Coupling Kit	512677S
	2013.02-2017.12		Front;Rear	Coupe RWD 642852/642853		Flexible Coupling Kit	537832S
	2014.05-2017.12		Centre	Estate 4WD 642854/642858		Center Bearing Support	531051
	2014.05-2017.12		Front	Estate RWD 642852/642853		Flexible Coupling	537851
	2014.05-2017.12		Front;Rear	Estate 4WD 642854/642858		Flexible Coupling Kit	512677S
3.0 (190 kw)	2014.05-2017.12		Front	Estate RWD 642852/642853		Flexible Coupling	537851
	2014.06-2017.12		Front	Coupe RWD 642852/642853		Flexible Coupling	537851
	2015.04-2017.12		Front;Rear	Coupe 4WD 642854/642858		Flexible Coupling Kit	512677S
	2015.04-2017.12		Front;Rear	Estate 4WD 642854/642858		Flexible Coupling Kit	512677S
3.0 (195 kw)	2011.01-2014.08		Front	Coupe RWD 642853		Flexible Coupling	537851
	2011.01-2014.08		Front;Rear	Coupe RWD 642853		Flexible Coupling	533884
	2011.01-2014.08		Front;Rear	Coupe RWD 642853		Flexible Coupling Kit	537832S
	2011.09-2014.08		Centre	Coupe 4WD 642854		Center Bearing Support	531051
	2011.09-2014.08		Front;Rear	Coupe 4WD 642854		Flexible Coupling Kit	512677S
	2012.10-2014.08		Centre	Estate 4WD 642854		Center Bearing Support	531051
	2012.10-2014.08		Front	Estate RWD 642853		Flexible Coupling	537851
	2012.10-2014.08		Front;Rear	Estate RWD 642853		Flexible Coupling	533884
	2012.10-2014.08		Front;Rear	Estate 4WD 642854		Flexible Coupling Kit	512677S
2012.10-2014.08		Front;Rear	Estate RWD 642853		Flexible Coupling Kit	537832S	
3.5 (200 kw)	2004.07-2010.12		Front	Coupe RWD 272964		Flexible Coupling Kit	537794S
3.5 (215 kw)	2006.04-2010.12		Front	Coupe RWD 272985		Flexible Coupling Kit	537794S
3.5 (225 kw)	2011.01-2014.08		Centre	Coupe RWD 276952		Center Bearing Support	531051
	2011.01-2014.08		Front	Coupe RWD 276952		Flexible Coupling Kit	537889S
	2011.01-2014.08		Front;Rear	Coupe RWD 276952		Flexible Coupling Kit	512677S
	2012.10-2014.08		Centre	Estate RWD 276952		Center Bearing Support	531051
	2012.10-2014.08		Front	Estate RWD 276952		Flexible Coupling Kit	537889S
	2012.10-2014.08		Front;Rear	Estate RWD 276952		Flexible Coupling Kit	512677S
CLS400							
2.9 (250 kw)	2017.12-		Front	Coupe 4WD 656929		Flexible Coupling	537630
	2017.12-		Front;Rear	Coupe 4WD 656929		Flexible Coupling Kit	537630S
3.0 (245 kw)	2014.05-2017.12	AT	Front	Estate 4WD 276820		Propshaft	PS900357
	2014.05-2017.12	AT	Front	Coupe 4WD 276820		Propshaft	PS900357
	2014.05-2017.12		Centre	Coupe RWD 276820		Center Bearing Support	531051
	2014.05-2017.12		Front	Coupe RWD 276820		Flexible Coupling	537851
	2014.05-2017.12		Front	Estate RWD 276820		Flexible Coupling	537851
	2014.05-2017.12		Front;Rear	Estate 4WD 276820		Flexible Coupling Kit	512673S
	2014.05-2017.12		Front;Rear	Coupe 4WD 276820		Flexible Coupling Kit	512673S
3.5 (245 kw)	2014.06-2017.12	AT	Front	Estate 4WD 276850	Date From:2015.01	Propshaft	PS900357
	2014.06-2017.12		Front;Rear	Estate 4WD 276850		Flexible Coupling Kit	512673S
	2014.07-2017.12	AT	Front	Coupe 4WD 276850	Date From:2015.01	Propshaft	PS900357
	2014.07-2017.12		Centre	Coupe RWD 276850		Center Bearing Support	531051
	2014.07-2017.12		Centre	Estate RWD 276850		Center Bearing Support	531051
	2014.07-2017.12		Front	Coupe RWD 276850		Flexible Coupling	537851
	2014.07-2017.12		Front	Estate RWD 276850		Flexible Coupling	537851
	2014.07-2017.12		Front;Rear	Coupe 4WD 276850		Flexible Coupling Kit	512673S



	 YEAR	TRANSM.	FITTING POSITION	BODY STYLE & DRIVE TYPE & ENGINE	REMARKS	 PRODUCT	GSP Ref.	
MERCEDES-BENZ								
CLS450								
3.0 (270 kw)	2017.12-		Front	Coupe 4WD 256930		Flexible Coupling	537630	
	2017.12-		Front;Rear	Coupe 4WD 256930		Flexible Coupling	537627	
	2017.12-		Front;Rear	Coupe 4WD 256930		Flexible Coupling Kit	537627S	
	2017.12-		Front;Rear	Coupe 4WD 256930		Flexible Coupling Kit	537630S	
CLS500								
4.7 (300 kw)	2011.02-2017.12		Front	Coupe RWD 278922		Flexible Coupling	537851	
	2011.02-2017.12		Front;Rear	Coupe RWD 278922		Flexible Coupling	533884	
	2011.02-2017.12		Front;Rear	Coupe RWD 278922		Flexible Coupling Kit	537832S	
	2011.09-2017.12	AT	Front	Coupe 4WD 278922		Propshaft	PS900357	
	2011.09-2017.12		Centre	Coupe 4WD 278922		Center Bearing Support	531051	
	2011.09-2017.12		Front	Coupe 4WD 278922		Flexible Coupling	537630	
	2011.09-2017.12		Front;Rear	Coupe 4WD 278922		Flexible Coupling Kit	512677S	
	2011.09-2017.12		Front;Rear	Coupe 4WD 278922		Flexible Coupling Kit	537630S	
	2012.10-2017.12	AT	Front	Estate 4WD 278922		Propshaft	PS900357	
	2012.10-2017.12		Centre	Estate 4WD 278922		Center Bearing Support	531051	
	2012.10-2017.12		Front	Estate RWD 278922		Flexible Coupling	537851	
	2012.10-2017.12		Front;Rear	Estate RWD 278922		Flexible Coupling	533884	
	2012.10-2017.12		Front;Rear	Estate 4WD 278922		Flexible Coupling Kit	512677S	
	2012.10-2017.12		Front;Rear	Estate 4WD 278922		Flexible Coupling Kit	537630S	
5.0 (225 kw)	2004.10-2010.12		Front	Coupe RWD 113967		Flexible Coupling Kit	537794S	
5.5 (285 kw)	2006.04-2011.12		Front;Rear	Coupe RWD 273960		Flexible Coupling	533884	
	2006.04-2011.12		Front;Rear	Coupe RWD 273960		Flexible Coupling Kit	537832S	
CLS53 AMG								
3.0 (320 kw)	2018.05-		Rear	Coupe 4WD 256930		Flexible Coupling	537851	
CLS55 AMG								
5.4 (350 kw)	2005.01-2010.12		Front;Rear	Coupe RWD 113990		Flexible Coupling	533884	
	2005.01-2010.12		Front;Rear	Coupe RWD 113990		Flexible Coupling Kit	537832S	
CLS550								
5.5 (285 kw)	2006.04-2011.12		Front;Rear	Coupe RWD 273960		Flexible Coupling	533884	
	2006.04-2011.12		Front;Rear	Coupe RWD 273960		Flexible Coupling Kit	537832S	
CLS63 AMG								
5.5 (386 kw)	2011.02-2017.12		Front;Rear	Coupe RWD 157980/157981		Flexible Coupling	533884	
	2011.02-2017.12		Front;Rear	Coupe RWD 157980/157981	Engine Code:M 157.981	Flexible Coupling	537843	
	2011.02-2017.12		Rear	Coupe RWD 157980/157981		Flexible Coupling Kit	533884S	
	2011.02-2017.12		Front;Rear	Coupe RWD 157980/157981		Flexible Coupling Kit	537832S	
	2012.10-2017.12		Front;Rear	Estate RWD 157981		Flexible Coupling	533884	
	2012.10-2017.12		Front;Rear	Estate RWD 157981		Flexible Coupling	537843	
	2012.10-2017.12		Rear	Estate RWD 157981		Flexible Coupling Kit	533884S	
	2012.10-2017.12		Front;Rear	Estate RWD 157981		Flexible Coupling Kit	537832S	
	5.5 (410 kw)	2011.01-2017.12		Front;Rear	Coupe RWD 157981		Flexible Coupling	533884
		2011.01-2017.12		Front;Rear	Coupe RWD 157981		Flexible Coupling	537843
2011.01-2017.12			Rear	Coupe RWD 157981		Flexible Coupling Kit	533884S	
2011.01-2017.12			Front;Rear	Coupe RWD 157981		Flexible Coupling Kit	537832S	
2013.05-2017.12		AT/MT	Front	Coupe 4WD 157981		Propshaft	PS900359	
2013.05-2017.12		AT/MT	Front	Estate 4WD 157981		Propshaft	PS900359	
2013.05-2017.12			Front;Rear	Estate RWD 157981		Flexible Coupling	533884	
2013.05-2017.12			Front;Rear	Coupe 4WD 157981		Flexible Coupling	533884	
2013.05-2017.12			Front;Rear	Estate 4WD 157981		Flexible Coupling	533884	
2013.05-2017.12			Front;Rear	Estate RWD 157981		Flexible Coupling	537843	
2013.05-2017.12			Front;Rear	Coupe 4WD 157981		Flexible Coupling	537843	
2013.05-2017.12			Front;Rear	Estate 4WD 157981		Flexible Coupling	537843	
2013.05-2017.12			Front	Coupe 4WD 157981		Flexible Coupling Kit	537832S	
2013.05-2017.12			Front	Estate 4WD 157981		Flexible Coupling Kit	537832S	
5.5 (430 kw)	2013.05-2017.12		Rear	Estate RWD 157981		Flexible Coupling Kit	533884S	
	2013.05-2017.12		Rear	Coupe 4WD 157981		Flexible Coupling Kit	533884S	
	2013.05-2017.12		Rear	Estate 4WD 157981		Flexible Coupling Kit	533884S	
	2013.05-2017.12		Front;Rear	Estate RWD 157981		Flexible Coupling Kit	537832S	
	2013.02-2017.12	AT/MT	Front	Coupe 4WD 157981		Propshaft	PS900359	
	2013.02-2017.12	AT/MT	Front	Estate 4WD 157981		Propshaft	PS900359	
	2013.02-2017.12		Front;Rear	Coupe 4WD 157981		Flexible Coupling	537843	
	2013.02-2017.12		Front;Rear	Estate 4WD 157981		Flexible Coupling	537843	
	2013.02-2017.12		Rear	Coupe 4WD 157981		Flexible Coupling Kit	533884S	
	2013.02-2017.12		Rear	Estate 4WD 157981		Flexible Coupling Kit	533884S	



	 YEAR	TRANSM.	FITTING POSITION	BODY STYLE & DRIVE TYPE & ENGINE	REMARKS	 PRODUCT	GSP Ref.
MERCEDES-BENZ CLS63 AMG							
6.2 (378 kw)	2006.04-2010.12		Front;Rear	Coupe RWD 156983		Flexible Coupling	533884
	2006.04-2010.12		Front;Rear	Coupe RWD 156983		Flexible Coupling Kit	537832S
6.3 (378 kw)	2006.09-2010.12		Front;Rear	Coupe RWD M 156.983		Flexible Coupling	533884
	2006.09-2010.12		Front;Rear	Coupe RWD M 156.983		Flexible Coupling Kit	537832S
E180							
1.6 (115 kw)	2013.08-2015.12		Centre	Saloon RWD 274910		Center Bearing Support	531051
E200							
1.6 (118 kw)	2018.11-		Front;Rear	Saloon RWD 654916		Flexible Coupling Kit	537630S
	2018.11-		Front;Rear	Estate RWD 654916		Flexible Coupling Kit	537630S
1.8 (120 kw)	2002.08-2006.07		Front;Rear	Saloon RWD 271941		Flexible Coupling	512678
	2002.08-2006.07		Front;Rear	Saloon RWD 271941		Flexible Coupling Kit	512673S
	2003.04-2006.07		Front;Rear	Estate RWD 271941		Flexible Coupling Kit	512673S
	2004.03-2008.12		Front;Rear	Saloon RWD 271941NGT		Flexible Coupling	512678
	2004.03-2008.12		Front;Rear	Saloon RWD 271941NGT		Flexible Coupling Kit	512673S
	2011.03-2015.12		Centre	Saloon RWD 271958NGT		Center Bearing Support	531051
	2011.03-2015.12		Front;Rear	Saloon RWD 271958NGT		Flexible Coupling Kit	512673S
1.8 (135 kw)	2011.03-2015.12		Front;Rear	Saloon RWD 271958NGT		Flexible Coupling Kit	512677S
	2006.04-2008.12		Front;Rear	Saloon RWD 271956		Flexible Coupling	512678
	2006.04-2008.12		Front;Rear	Saloon RWD 271956		Flexible Coupling Kit	512673S
	2006.04-2009.07		Front;Rear	Estate RWD 271956		Flexible Coupling Kit	512673S
	2009.01-2015.12		Centre	Saloon RWD 271820/271860		Center Bearing Support	531051
	2009.01-2015.12		Front;Rear	Saloon RWD 271820/271860		Flexible Coupling Kit	512673S
	2009.01-2016.12		Centre	Coupe RWD 271820/271860		Center Bearing Support	531051
	2009.01-2016.12		Centre	Estate RWD 271860		Center Bearing Support	531051
	2009.01-2016.12		Front;Rear	Coupe RWD 271820/271860		Flexible Coupling Kit	512673S
	2009.01-2016.12		Front;Rear	Estate RWD 271860		Flexible Coupling Kit	512673S
2.0 (55 kw)	2010.01-2016.12		Centre	Cabriolet RWD 271820/271860		Center Bearing Support	531051
	2010.01-2016.12		Front;Rear	Cabriolet RWD 271820/271860		Flexible Coupling Kit	512673S
	1993.06-1995.06		Centre	Saloon RWD 601912		Center Bearing Support	510511
	1993.06-1995.06		Front	Saloon RWD 601912		Flexible Coupling	510436
	1993.06-1995.06		Rear	Saloon RWD 601912		Flexible Coupling	510458
	1993.06-1995.06		Rear	Saloon RWD 601912		Flexible Coupling	510460
	1993.06-1995.06		Front	Saloon RWD 601912		Flexible Coupling Kit	510434S
	1993.06-1995.06		Front	Saloon RWD 601912		Flexible Coupling Kit	510570S
	1993.06-1995.06		Front	Saloon RWD 601912	VIN to:A 982463,AT,for taxis	Flexible Coupling Kit	537822S
2.0 (65 kw)	1993.06-1995.06		Rear	Saloon RWD 601912		Flexible Coupling Kit	510459S
	1995.07-2000.06		Centre	Saloon RWD 604917		Center Bearing Support	510568
	1995.07-2000.06		Front	Saloon RWD 604917	VIN from:A 612071,MT	Flexible Coupling	512326
	1995.07-2000.06		Front	Saloon RWD 604917		Flexible Coupling	517747
	1995.07-2000.06		Rear	Saloon RWD 604917		Flexible Coupling	510460
	1995.07-2000.06		Front	Saloon RWD 604917		Flexible Coupling Kit	510578S
	1995.07-2000.06		Front	Saloon RWD 604917		Flexible Coupling Kit	537791S
	1995.07-2000.06		Front	Saloon RWD 604917	VIN to:A 612070,MT,not for taxis	Flexible Coupling Kit	537820S
2.0 (100 kw)	1995.07-2000.06		Rear	Saloon RWD 604917		Flexible Coupling Kit	510459S
	1993.06-1995.06		Centre	Saloon RWD 111940		Center Bearing Support	510511
	1993.06-1995.06		Front	Saloon RWD 111940		Flexible Coupling	510436
	1993.06-1995.06		Front	Saloon RWD 111940		Flexible Coupling	510569
	1993.06-1995.06		Front	Saloon RWD 111940		Flexible Coupling Kit	510434S
	1993.06-1995.06		Front	Saloon RWD 111940		Flexible Coupling Kit	510570S
	1993.06-1996.01		Centre	Estate RWD 111940		Center Bearing Support	510511
	1993.06-1996.01		Front	Estate RWD 111940		Flexible Coupling	510436
	1993.06-1996.01		Front	Estate RWD 111940		Flexible Coupling	510569
	1993.06-1996.01		Front	Estate RWD 111940		Flexible Coupling Kit	510434S
	1993.06-1996.01		Front	Estate RWD 111940		Flexible Coupling Kit	510570S
	1993.06-1996.07		Centre	Coupe RWD 111940		Center Bearing Support	510511
	1993.06-1996.07		Front	Coupe RWD 111940		Flexible Coupling	510436
	1993.06-1996.07		Front	Coupe RWD 111940		Flexible Coupling	510569
	1993.06-1996.07		Front	Coupe RWD 111940		Flexible Coupling Kit	510434S
	1993.06-1996.07		Front	Coupe RWD 111940		Flexible Coupling Kit	510570S
	1993.06-1998.03		Centre	Cabriolet RWD 111940		Center Bearing Support	510511
	1993.06-1998.03		Front	Cabriolet RWD 111940		Flexible Coupling	510436
	1993.06-1998.03		Front	Cabriolet RWD 111940		Flexible Coupling	510569
	1993.06-1998.03		Front	Cabriolet RWD 111940		Flexible Coupling Kit	510434S
	1993.06-1998.03		Front	Cabriolet RWD 111940		Flexible Coupling Kit	510570S



	 YEAR	TRANSM.	FITTING POSITION	BODY STYLE & DRIVE TYPE & ENGINE	REMARKS	 PRODUCT	GSP Ref.
MERCEDES-BENZ E200							
2.0 (100 kw)	1995.07-2000.06		Front	Saloon RWD 111942		Flexible Coupling	510569
	1995.07-2000.06		Front	Saloon RWD 111942	MT	Flexible Coupling	512326
	1995.07-2000.06		Front	Saloon RWD 111942		Flexible Coupling Kit	510570S
	1995.07-2000.06		Front	Saloon RWD 111942		Flexible Coupling Kit	510578S
	1995.07-2000.06		Front	Saloon RWD 111942	<small>1995 to A 111925, A 111926, A 111927 for EA codes 903 901 for vehicles with air conditioning</small>	Flexible Coupling Kit	537821S
	1996.06-2000.07		Front	Estate RWD 111942		Flexible Coupling	510569
	1996.06-2000.07		Front	Estate RWD 111942	MT	Flexible Coupling	512326
	1996.06-2000.07		Front	Estate RWD 111942		Flexible Coupling Kit	510570S
2.0 (110 kw)	2016.07-		Rear	Saloon RWD 654920		Flexible Coupling	537630
	2016.07-		Front;Rear	Saloon RWD 654920		Flexible Coupling Kit	537630S
	2016.10-		Front	Estate RWD 654920		Flexible Coupling	537630
	2016.10-		Front;Rear	Estate RWD 654920		Flexible Coupling Kit	537630S
2.0 (115 kw)	2013.07-2015.12		Centre	Saloon RWD 274920NGT		Center Bearing Support	531051
2.0 (120 kw)	2000.07-2002.03		Centre	Saloon RWD 111957		Center Bearing Support	512668
	2000.07-2002.03		Front;Rear	Saloon RWD 111957		Flexible Coupling	512678
	2000.07-2002.03		Front;Rear	Saloon RWD 111957		Flexible Coupling Kit	512673S
	2000.08-2003.05		Centre	Estate RWD 111957		Center Bearing Support	512668
	2000.08-2003.05		Front;Rear	Estate RWD 111957		Flexible Coupling	512678
	2000.08-2003.05		Front;Rear	Estate RWD 111957		Flexible Coupling Kit	512673S
2.0 (135 kw)	2013.01-2016.12		Centre	Estate RWD 274920		Center Bearing Support	531051
	2013.01-2016.12		Centre	Saloon RWD 274920		Center Bearing Support	531051
	2013.03-2016.12		Centre	Cabriolet RWD 274920		Center Bearing Support	531051
	2013.03-2016.12		Centre	Coupe RWD 274920		Center Bearing Support	531051
	2013.03-2016.12		Front;Rear	Cabriolet RWD 274920		Flexible Coupling Kit	512673S
	2013.03-2016.12		Front;Rear	Coupe RWD 274920		Flexible Coupling Kit	512673S
	2016.01-		Front;Rear	Saloon RWD 274920		Flexible Coupling	537627
	2016.07-		Front;Rear	Saloon 4WD 274920		Flexible Coupling	537627
	2016.07-		Front;Rear	Estate RWD 274920		Flexible Coupling	537627
	2016.12-		Rear	Coupe RWD 274920		Flexible Coupling	537847
	2016.12-		Front;Rear	Coupe RWD 274920		Flexible Coupling	537627
	2017.01-		Front;Rear	Estate 4WD 274920		Flexible Coupling	537627
2017.06-		Rear	Cabriolet RWD 274920		Flexible Coupling	537847	
2.0 (137 kw)	1997.04-2000.06		Centre	Saloon RWD 111947		Center Bearing Support	512668
	1997.04-2000.06		Front	Saloon RWD 111947		Flexible Coupling	510571
	1997.04-2000.06		Front;Rear	Saloon RWD 111947		Flexible Coupling	512678
	1997.04-2000.06		Front	Saloon RWD 111947	MT	Flexible Coupling Kit	537819S
	1997.04-2000.06		Front	Saloon RWD 111947	AT	Flexible Coupling Kit	537854S
	1997.04-2000.06		Front;Rear	Saloon RWD 111947		Flexible Coupling Kit	512673S
	1997.11-2000.07		Centre	Estate RWD 111947		Center Bearing Support	512668
	1997.11-2000.07		Front	Estate RWD 111947	AT	Flexible Coupling	510571
	1997.11-2000.07		Front	Estate RWD 111947	5AT	Flexible Coupling	512678
	1997.11-2000.07		Front	Estate RWD 111947	MT	Flexible Coupling Kit	537819S
1997.11-2000.07		Front	Estate RWD 111947	AT	Flexible Coupling Kit	537854S	
1997.11-2000.07		Front;Rear	Estate RWD 111947		Flexible Coupling Kit	512673S	
2.0 (145 kw)	2018.10-		Front;Rear	Saloon RWD 264920		Flexible Coupling Kit	537630S
	2019.06-		Front;Rear	Coupe RWD 264920		Flexible Coupling Kit	537630S
	2019.06-		Front;Rear	Saloon RWD 264920		Flexible Coupling Kit	537630S
	2019.06-		Front;Rear	Cabriolet RWD 264920		Flexible Coupling Kit	537630S
	2019.06-		Front;Rear	Estate RWD 264920		Flexible Coupling Kit	537630S
2.2 (75 kw)	1998.06-2002.03		Centre	Saloon RWD 611961		Center Bearing Support	512668
	1998.06-2002.03		Front;Rear	Saloon RWD 611961		Flexible Coupling	512678
	1998.06-2002.03		Front;Rear	Saloon RWD 611961		Flexible Coupling Kit	512673S
	2002.11-2005.07		Centre	Saloon RWD 646951		Center Bearing Support	512668
	2002.11-2005.07		Front;Rear	Saloon RWD 646951		Flexible Coupling	512678
2002.11-2005.07		Front;Rear	Saloon RWD 646951		Flexible Coupling Kit	512673S	
2.2 (85 kw)	1999.08-2002.03		Centre	Saloon RWD 611961		Center Bearing Support	512668
	1999.08-2002.03		Front;Rear	Saloon RWD 611961		Flexible Coupling	512678
	1999.08-2002.03		Front;Rear	Saloon RWD 611961		Flexible Coupling Kit	512673S
2.2 (90 kw)	2002.07-2006.07		Centre	Saloon RWD 646951		Center Bearing Support	512668
	2002.07-2006.07		Front;Rear	Saloon RWD 646951		Flexible Coupling	512678
	2002.07-2006.07		Front;Rear	Saloon RWD 646951		Flexible Coupling Kit	512673S
2.2 (100 kw)	2006.04-2009.07		Front	Estate RWD 646820/646821		Flexible Coupling Kit	537794S
	2006.04-2011.12		Centre	Saloon RWD 646820/646821		Center Bearing Support	512668



	 YEAR	TRANSM.	FITTING POSITION	BODY STYLE & DRIVE TYPE & ENGINE	REMARKS	 PRODUCT	GSP Ref.
MERCEDES-BENZ E200							
2.2 (100 kw)	2006.04-2011.12		Front	Saloon RWD 646820/646821		Flexible Coupling Kit	537794S
	2009.01-2015.12		Front	Saloon RWD 651925		Flexible Coupling	537630
	2009.01-2015.12		Rear	Saloon RWD 651925		Flexible Coupling Kit	537793S
	2009.01-2015.12		Front;Rear	Saloon RWD 651925	For OE No.0004110200	Flexible Coupling Kit	512677S
	2009.01-2015.12		Front;Rear	Saloon RWD 651925		Flexible Coupling Kit	537630S
	2009.01-2016.12		Front	Estate RWD 651925		Flexible Coupling	537630
	2009.01-2016.12		Rear	Estate RWD 651925		Flexible Coupling Kit	537793S
	2009.01-2016.12		Front;Rear	Estate RWD 651925		Flexible Coupling Kit	512677S
2009.01-2016.12		Front;Rear	Estate RWD 651925		Flexible Coupling Kit	537630S	
E220							
2.0 (120 kw)	2016.01-		Rear	Saloon RWD 654920		Flexible Coupling	537630
	2016.01-		Front;Rear	Saloon RWD 654920		Flexible Coupling Kit	537630S
	2016.07-		Front	Estate RWD 654920		Flexible Coupling	537630
	2016.07-		Front;Rear	Estate RWD 654920		Flexible Coupling Kit	537630S
	2016.10-		Front	Saloon 4WD 654920		Flexible Coupling	537630
	2016.10-		Front;Rear	Saloon 4WD 654920		Flexible Coupling Kit	537630S
	2016.12-		Front	Coupe RWD 654920		Flexible Coupling	537630
	2016.12-		Front;Rear	Coupe RWD 654920		Flexible Coupling Kit	537630S
	2017.06-		Front	Cabriolet RWD 654920		Flexible Coupling	537630
	2017.06-		Front;Rear	Cabriolet RWD 654920		Flexible Coupling Kit	537630S
2.0 (143 kw)	2016.01-		Rear	Saloon RWD 654920		Flexible Coupling	537630
	2016.01-		Front;Rear	Saloon RWD 654920		Flexible Coupling Kit	537630S
	2016.07-		Front	Estate RWD 654920		Flexible Coupling	537630
	2016.07-		Front;Rear	Estate RWD 654920		Flexible Coupling Kit	537630S
	2016.10-		Front	Saloon 4WD 654920		Flexible Coupling	537630
	2016.10-		Front;Rear	Saloon 4WD 654920		Flexible Coupling	537627
	2016.10-		Front;Rear	Saloon 4WD 654920		Flexible Coupling Kit	537630S
	2016.12-		Front	Coupe RWD 654920		Flexible Coupling	537630
	2016.12-		Front;Rear	Coupe RWD 654920		Flexible Coupling Kit	537630S
	2017.01-		Front	Coupe 4WD 654920		Flexible Coupling	537630
	2017.01-		Rear	Coupe 4WD 654920		Flexible Coupling	537847
	2017.01-		Front;Rear	Coupe 4WD 654920		Flexible Coupling	537627
	2017.01-		Front;Rear	Estate 4WD 654920		Flexible Coupling	537627
	2017.01-		Front;Rear	Coupe 4WD 654920		Flexible Coupling Kit	537630S
	2017.06-		Front	Cabriolet RWD 654920		Flexible Coupling	537630
	2017.06-		Front;Rear	Cabriolet RWD 654920		Flexible Coupling Kit	537630S
	2017.10-		Front	Cabriolet 4WD 654920		Flexible Coupling	537630
	2017.10-		Front;Rear	Cabriolet 4WD 654920		Flexible Coupling Kit	537630S
2.2 (55 kw)	1995.07-1998.05		Front	Saloon RWD 604912		Flexible Coupling	510569
	1995.07-1998.05		Front	Saloon RWD 604912	VIN from:A 612071,MT,not for taxis	Flexible Coupling	512326
	1995.07-1998.05		Front	Saloon RWD 604912		Flexible Coupling	517747
	1995.07-1998.05		Rear	Saloon RWD 604912		Flexible Coupling	510460
	1995.07-1998.05		Front	Saloon RWD 604912		Flexible Coupling Kit	510570S
	1995.07-1998.05		Front	Saloon RWD 604912		Flexible Coupling Kit	510578S
	1995.07-1998.05		Front	Saloon RWD 604912		Flexible Coupling Kit	537791S
	1995.07-1998.05		Front	Saloon RWD 604912	VIN to:A 612070,MT,not for taxis	Flexible Coupling Kit	537820S
	1995.07-1998.05		Front	Saloon RWD 604912	MT,for taxis	Flexible Coupling Kit	537821S
1995.07-1998.05		Rear	Saloon RWD 604912		Flexible Coupling Kit	510459S	
2.2 (70 kw)	1995.07-1998.05		Centre	Saloon RWD 604912		Center Bearing Support	510568
	1995.07-1998.05		Front	Saloon RWD 604912		Flexible Coupling	510569
	1995.07-1998.05		Front	Saloon RWD 604912	VIN from:A 612071,MT,not for taxis	Flexible Coupling	512326
	1995.07-1998.05		Front	Saloon RWD 604912		Flexible Coupling	517747
	1995.07-1998.05		Rear	Saloon RWD 604912		Flexible Coupling	510460
	1995.07-1998.05		Front	Saloon RWD 604912		Flexible Coupling Kit	510570S
	1995.07-1998.05		Front	Saloon RWD 604912		Flexible Coupling Kit	510578S
	1995.07-1998.05		Front	Saloon RWD 604912		Flexible Coupling Kit	537791S
	1995.07-1998.05		Front	Saloon RWD 604912	VIN to:A 612070,MT,not for taxis	Flexible Coupling Kit	537820S
	1995.07-1998.05		Front	Saloon RWD 604912	MT,for taxis	Flexible Coupling Kit	537821S
1995.07-1998.05		Rear	Saloon RWD 604912		Flexible Coupling Kit	510459S	
2.2 (92 kw)	1998.06-1999.07		Centre	Saloon RWD 611961		Center Bearing Support	512668
	1998.06-1999.07		Centre	Estate RWD 611961		Center Bearing Support	512668
	1998.06-1999.07		Rear	Estate RWD 611961		Flexible Coupling	510458
	1998.06-1999.07		Front;Rear	Saloon RWD 611961		Flexible Coupling	512677
	1998.06-1999.07		Front;Rear	Saloon RWD 611961		Flexible Coupling	512678



	 YEAR	TRANSM.	FITTING POSITION	BODY STYLE & DRIVE TYPE & ENGINE	REMARKS	 PRODUCT	GSP Ref.	
MERCEDES-BENZ E220								
2.2 (92 kw)	1998.06-1999.07		Front;Rear	Estate RWD 611961		Flexible Coupling	512678	
	1998.06-1999.07		Front;Rear	Saloon RWD 611961		Flexible Coupling Kit	512673S	
	1998.06-1999.07		Front;Rear	Estate RWD 611961		Flexible Coupling Kit	512673S	
2.2 (100 kw)	1999.05-2003.03		Front;Rear	Estate RWD 611961		Flexible Coupling Kit	512673S	
	1999.07-2002.03		Front;Rear	Saloon RWD 611961		Flexible Coupling	512677	
	1999.07-2002.03		Front;Rear	Saloon RWD 611961		Flexible Coupling Kit	512673S	
	2002.03-2008.12		Centre	Saloon RWD 646961		Center Bearing Support	512668	
	2002.03-2008.12		Front	Saloon RWD 646961		Flexible Coupling Kit	537794S	
	2002.03-2008.12		Rear	Saloon RWD 646961		Flexible Coupling Kit	537793S	
	2003.03-2009.07		Centre	Estate RWD 646961		Center Bearing Support	512668	
	2003.03-2009.07		Front	Estate RWD 646961		Flexible Coupling Kit	537794S	
	2003.03-2009.07		Rear	Estate RWD 646961		Flexible Coupling Kit	537793S	
2.2 (105 kw)	1999.07-2002.12		Front;Rear	Chassis cabin RWD 611961		Flexible Coupling Kit	512673S	
	1999.07-2003.03		Centre	Estate RWD 611961		Center Bearing Support	512668	
	1999.07-2003.03		Rear	Estate RWD 611961		Flexible Coupling	510458	
	1999.07-2003.03		Front;Rear	Estate RWD 611961		Flexible Coupling	512678	
	1999.07-2003.03		Front;Rear	Estate RWD 611961		Flexible Coupling Kit	512673S	
	1999.08-2002.03		Centre	Saloon RWD 611961		Center Bearing Support	512668	
	1999.08-2002.03		Front;Rear	Saloon RWD 611961		Flexible Coupling	512677	
	1999.08-2002.03		Front;Rear	Saloon RWD 611961		Flexible Coupling	512678	
	1999.08-2002.03		Front;Rear	Saloon RWD 611961		Flexible Coupling Kit	512673S	
2.2 (110 kw)	1993.06-1995.06		Centre	Saloon RWD 111960		Center Bearing Support	510511	
	1993.06-1995.06		Front	Saloon RWD 111960		Flexible Coupling	510436	
	1993.06-1995.06		Front	Saloon RWD 111960		Flexible Coupling	510569	
	1993.06-1995.06		Front	Saloon RWD 111960		Flexible Coupling Kit	510434S	
	1993.06-1995.06		Front	Saloon RWD 111960		Flexible Coupling Kit	510570S	
	1993.06-1996.01		Centre	Estate RWD 111960		Center Bearing Support	510511	
	1993.06-1996.01		Front	Estate RWD 111960		Flexible Coupling	510436	
	1993.06-1996.01		Front	Estate RWD 111960		Flexible Coupling	510569	
	1993.06-1996.01		Front	Estate RWD 111960		Flexible Coupling Kit	510434S	
	1993.06-1996.01		Front	Estate RWD 111960		Flexible Coupling Kit	510570S	
	1993.06-1996.07		Centre	Cabriolet RWD 111960		Center Bearing Support	510511	
	1993.06-1996.07		Centre	Coupe RWD 111960		Center Bearing Support	510511	
	1993.06-1996.07		Front	Cabriolet RWD 111960		Flexible Coupling	510436	
	1993.06-1996.07		Front	Coupe RWD 111960		Flexible Coupling	510436	
	1993.06-1996.07		Front	Cabriolet RWD 111960		Flexible Coupling	510569	
	1993.06-1996.07		Front	Coupe RWD 111960		Flexible Coupling	510569	
	1993.06-1996.07		Front	Cabriolet RWD 111960		Flexible Coupling Kit	510434S	
	1993.06-1996.07		Front	Coupe RWD 111960		Flexible Coupling Kit	510434S	
	1993.06-1996.07		Front	Cabriolet RWD 111960		Flexible Coupling Kit	510570S	
	1993.06-1996.07		Front	Coupe RWD 111960		Flexible Coupling Kit	510570S	
	2002.04-2006.07		Centre	Saloon RWD 646961		Center Bearing Support	512668	
	2002.04-2006.07		Front	Saloon RWD 646961		Flexible Coupling Kit	537794S	
	2002.04-2006.07		Rear	Saloon RWD 646961		Flexible Coupling Kit	537793S	
	2003.04-2006.07		Centre	Estate RWD 646961		Center Bearing Support	512668	
	2003.04-2006.07		Front	Estate RWD 646961		Flexible Coupling Kit	537794S	
	2003.04-2006.07		Rear	Estate RWD 646961		Flexible Coupling Kit	537793S	
	2.2 (120 kw)	2003.03-2008.12		Centre	Saloon RWD 646821		Center Bearing Support	512668
		2003.03-2008.12		Front	Saloon RWD 646821		Flexible Coupling Kit	537794S
		2003.03-2008.12		Rear	Saloon RWD 646821		Flexible Coupling Kit	537793S
		2003.03-2009.07		Centre	Estate RWD 646821		Center Bearing Support	512668
2003.03-2009.07			Front	Estate RWD 646821		Flexible Coupling Kit	537794S	
2003.03-2009.07			Rear	Estate RWD 646821		Flexible Coupling Kit	537793S	
2009.01-2014.08			Front	Estate RWD 651924		Flexible Coupling	537630	
2009.01-2014.08			Rear	Estate RWD 651924		Flexible Coupling Kit	537793S	
2009.01-2014.08			Front;Rear	Estate RWD 651924	For OE No.0004110200	Flexible Coupling Kit	512677S	
2009.01-2014.08			Front;Rear	Estate RWD 651924		Flexible Coupling Kit	537630S	
2009.01-2015.12			Front	Saloon RWD 651924		Flexible Coupling	537630	
2009.01-2015.12			Rear	Saloon RWD 651924		Flexible Coupling Kit	537793S	
2009.01-2015.12			Front;Rear	Saloon RWD 651924		Flexible Coupling Kit	512677S	
2009.01-2015.12			Front;Rear	Saloon RWD 651924		Flexible Coupling Kit	537630S	
2010.02-2014.12			Front;Rear	Coupe RWD 651911		Flexible Coupling Kit	512677S	
2010.02-2014.12			Front;Rear	Coupe RWD 651911		Flexible Coupling Kit	537630S	
2010.02-2016.12			Front	Cabriolet RWD 651911		Flexible Coupling	537630	



	 YEAR	TRANSM.	FITTING POSITION	BODY STYLE & DRIVE TYPE & ENGINE	REMARKS	 PRODUCT	GSP Ref.
MERCEDES-BENZ E220							
2.2 (120 kw)	2010.02-2016.12		Front;Rear	Cabriolet RWD 651911		Flexible Coupling Kit	512677S
	2010.02-2016.12		Front;Rear	Cabriolet RWD 651911		Flexible Coupling Kit	537630S
2.2 (125 kw)	2006.04-2009.07		Centre	Saloon RWD 646821		Center Bearing Support	512668
	2006.04-2009.07		Centre	Estate RWD 646821		Center Bearing Support	512668
	2006.04-2009.07		Centre	Chassis cabin RWD 646821		Center Bearing Support	512668
	2006.04-2009.07		Front	Saloon RWD 646821		Flexible Coupling Kit	537794S
	2006.04-2009.07		Front	Estate RWD 646821		Flexible Coupling Kit	537794S
	2006.04-2009.07		Front	Chassis cabin RWD 646821		Flexible Coupling Kit	537794S
	2006.04-2009.07		Rear	Saloon RWD 646821		Flexible Coupling Kit	537793S
	2006.04-2009.07		Rear	Estate RWD 646821		Flexible Coupling Kit	537793S
	2009.01-2016.12		Front	Saloon RWD 651924		Flexible Coupling	537630
	2009.01-2016.12		Front	Estate RWD 651924		Flexible Coupling	537630
	2009.01-2016.12		Rear	Saloon RWD 651924		Flexible Coupling Kit	537793S
	2009.01-2016.12		Rear	Estate RWD 651924		Flexible Coupling Kit	537793S
	2009.01-2016.12		Front;Rear	Saloon RWD 651924	For OE No.0004110200	Flexible Coupling Kit	512677S
	2009.01-2016.12		Front;Rear	Estate RWD 651924		Flexible Coupling Kit	512677S
	2009.01-2016.12		Front;Rear	Saloon RWD 651924		Flexible Coupling Kit	537630S
	2009.01-2016.12		Front;Rear	Estate RWD 651924		Flexible Coupling Kit	537630S
	2010.01-2016.12		Front	Cabriolet RWD 651911		Flexible Coupling	537630
	2010.01-2016.12		Front	Coupe RWD 651911		Flexible Coupling	537630
	2010.01-2016.12		Rear	Cabriolet RWD 651911		Flexible Coupling	537843
	2010.01-2016.12		Rear	Cabriolet RWD 651911		Flexible Coupling Kit	537843S
	2010.01-2016.12		Front;Rear	Cabriolet RWD 651911		Flexible Coupling Kit	512677S
	2010.01-2016.12		Front;Rear	Coupe RWD 651911		Flexible Coupling Kit	512677S
	2010.01-2016.12		Front;Rear	Cabriolet RWD 651911		Flexible Coupling Kit	537630S
	2010.01-2016.12		Front;Rear	Coupe RWD 651911		Flexible Coupling Kit	537630S
	2014.12-2016.12		Front	Estate 4WD 651924		Flexible Coupling	537630
	2014.12-2016.12		Front;Rear	Estate 4WD 651924		Flexible Coupling Kit	512677S
	2014.12-2016.12		Front;Rear	Estate 4WD 651924		Flexible Coupling Kit	537630S
2015.01-2015.12		Front	Saloon 4WD 651924		Flexible Coupling	537630	
2015.01-2015.12		Front;Rear	Saloon 4WD 651924		Flexible Coupling Kit	512677S	
2015.01-2015.12		Front;Rear	Saloon 4WD 651924		Flexible Coupling Kit	537630S	
2.2 (130 kw)	2014.05-2015.12		Front	Saloon RWD 651924		Flexible Coupling	537630
	2014.05-2015.12		Front;Rear	Saloon RWD 651924		Flexible Coupling Kit	512677S
	2014.05-2015.12		Front;Rear	Saloon RWD 651924		Flexible Coupling Kit	537630S
	2014.05-2016.12		Front	Coupe RWD 651911		Flexible Coupling	537630
	2014.05-2016.12		Front;Rear	Cabriolet RWD 651911		Flexible Coupling Kit	512677S
	2014.05-2016.12		Front;Rear	Coupe RWD 651911		Flexible Coupling Kit	512677S
	2014.05-2016.12		Front;Rear	Cabriolet RWD 651911		Flexible Coupling Kit	537630S
	2014.05-2016.12		Front;Rear	Coupe RWD 651911		Flexible Coupling Kit	537630S
	2015.05-2016.12		Front	Estate RWD 651924		Flexible Coupling	537630
	2015.05-2016.12		Front;Rear	Estate RWD 651924		Flexible Coupling Kit	512677S
2015.05-2016.12		Front;Rear	Estate RWD 651924		Flexible Coupling Kit	537630S	
E230							
2.3 (110 kw)	1995.07-1997.10		Front	Saloon RWD 111970		Flexible Coupling	510569
	1995.07-1997.10		Front	Saloon RWD 111970		Flexible Coupling Kit	510570S
	1995.07-1997.10		Front	Saloon RWD 111970	MT	Flexible Coupling Kit	537821S
	1996.06-1997.10		Front	Estate RWD 111970		Flexible Coupling	510569
	1996.06-1997.10		Front	Estate RWD 111970	MT	Flexible Coupling	512326
	1996.06-1997.10		Front	Estate RWD 111970		Flexible Coupling Kit	510570S
	1996.06-1997.10		Front	Estate RWD 111970		Flexible Coupling Kit	510578S
	2007.05-2009.07		Front;Rear	Estate RWD 272922		Flexible Coupling Kit	512673S
2007.09-2008.12		Front;Rear	Saloon RWD 272922		Flexible Coupling Kit	512673S	
E240							
2.4 (125 kw)	1997.04-2000.06		Front	Saloon RWD 112911		Flexible Coupling	510569
	1997.04-2000.06		Front	Saloon RWD 112911		Flexible Coupling Kit	510570S
	1997.04-2000.06		Front	Saloon RWD 112911		Flexible Coupling Kit	510578S
	1997.10-2003.03		Front	Estate RWD 112911		Flexible Coupling	510569
	1997.10-2003.03		Front	Estate RWD 112911	MT	Flexible Coupling	512326
	1997.10-2003.03		Front	Estate RWD 112911		Flexible Coupling Kit	510570S
	1997.10-2003.03		Front	Estate RWD 112911		Flexible Coupling Kit	510578S
2.6 (125 kw)	2000.07-2002.03		Front;Rear	Saloon RWD 112914		Flexible Coupling	512678
	2000.07-2002.03		Front;Rear	Saloon RWD 112914		Flexible Coupling Kit	512673S
	2000.08-2003.05		Front;Rear	Estate RWD 112914		Flexible Coupling	512678



	 YEAR	TRANSM.	FITTING POSITION	BODY STYLE & DRIVE TYPE & ENGINE	REMARKS	 PRODUCT	GSP Ref.
MERCEDES-BENZ E240							
2.6 (125 kw)	2000.08-2003.05		Front;Rear	Estate RWD 112914		Flexible Coupling Kit	512673S
2.6 (130 kw)	2002.04-2006.07		Front;Rear	Saloon RWD 112913		Flexible Coupling Kit	512673S
	2003.06-2006.07		Front;Rear	Estate RWD 112913		Flexible Coupling Kit	512673S
	2003.08-2005.07	AT/MT	Front	Saloon 4WD 112917		Propshaft	PS900351
	2003.08-2005.07		Front;Rear	Saloon 4WD 112917		Flexible Coupling Kit	512673S
	2003.08-2006.07	AT/MT	Front	Estate 4WD 112917	Date To:2006.12	Propshaft	PS900351
	2003.08-2006.07		Front;Rear	Estate 4WD 112917		Flexible Coupling Kit	512673S
E250							
1.8 (150 kw)	2009.01-2013.12		Centre	Estate RWD 271860		Center Bearing Support	531051
	2009.01-2013.12		Front;Rear	Estate RWD 271860		Flexible Coupling Kit	512673S
	2009.01-2013.12		Front;Rear	Estate RWD 271860		Flexible Coupling Kit	512677S
	2009.01-2015.12		Centre	Saloon RWD 271860		Center Bearing Support	531051
	2009.01-2015.12		Front;Rear	Saloon RWD 271860		Flexible Coupling Kit	512677S
	2009.01-2016.12		Centre	Coupe RWD 271860		Center Bearing Support	531051
	2009.01-2016.12		Front;Rear	Coupe RWD 271860		Flexible Coupling Kit	512677S
	2010.01-2016.12		Centre	Cabriolet RWD 271860		Center Bearing Support	531051
2.0 (155 kw)	2010.01-2016.12		Front;Rear	Cabriolet RWD 271860		Flexible Coupling Kit	512677S
	2013.01-2016.12		Centre	Estate RWD 274920		Center Bearing Support	531051
	2013.01-2016.12		Centre	Saloon RWD 274920		Center Bearing Support	531051
	2013.03-2016.12		Centre	Cabriolet RWD 274920		Center Bearing Support	531051
2.2 (150 kw)	2009.01-2016.12		Front	Saloon RWD 651924		Flexible Coupling	537851
	2009.01-2016.12		Front	Coupe RWD 651911		Flexible Coupling	537851
	2009.01-2016.12		Front	Estate RWD 651924		Flexible Coupling	537851
	2009.01-2016.12		Rear	Saloon RWD 651924		Flexible Coupling	537843
	2009.01-2016.12		Rear	Coupe RWD 651911		Flexible Coupling	537843
	2009.01-2016.12		Rear	Estate RWD 651924		Flexible Coupling	537843
	2009.01-2016.12		Front;Rear	Saloon RWD 651924		Flexible Coupling	533884
	2009.01-2016.12		Front;Rear	Coupe RWD 651911		Flexible Coupling	533884
	2009.01-2016.12		Front;Rear	Estate RWD 651924		Flexible Coupling	533884
	2009.01-2016.12		Rear	Saloon RWD 651924		Flexible Coupling Kit	533884S
	2009.01-2016.12		Rear	Coupe RWD 651911		Flexible Coupling Kit	533884S
	2009.01-2016.12		Rear	Estate RWD 651924		Flexible Coupling Kit	533884S
	2009.01-2016.12		Rear	Saloon RWD 651924		Flexible Coupling Kit	537843S
	2009.01-2016.12		Rear	Coupe RWD 651911		Flexible Coupling Kit	537843S
	2009.01-2016.12		Rear	Estate RWD 651924		Flexible Coupling Kit	537843S
	2009.01-2016.12		Front;Rear	Saloon RWD 651924		Flexible Coupling Kit	537832S
	2009.01-2016.12		Front;Rear	Coupe RWD 651911		Flexible Coupling Kit	537832S
	2009.01-2016.12		Front;Rear	Estate RWD 651924		Flexible Coupling Kit	537832S
	2010.01-2016.12		Front	Cabriolet RWD 651911		Flexible Coupling	537851
	2010.01-2016.12		Rear	Cabriolet RWD 651911		Flexible Coupling	537843
	2010.01-2016.12		Front;Rear	Cabriolet RWD 651911		Flexible Coupling	533884
	2010.01-2016.12		Rear	Cabriolet RWD 651911		Flexible Coupling Kit	533884S
	2010.01-2016.12		Rear	Cabriolet RWD 651911		Flexible Coupling Kit	537843S
	2010.01-2016.12		Front;Rear	Cabriolet RWD 651911		Flexible Coupling Kit	537832S
	2010.07-2016.12		Front	Estate 4WD 651924		Flexible Coupling	537851
	2010.07-2016.12		Front;Rear	Estate 4WD 651924		Flexible Coupling Kit	512673S
	2011.01-2015.12		Front	Saloon 4WD 651924		Flexible Coupling	537851
2011.01-2015.12		Front;Rear	Saloon 4WD 651924		Flexible Coupling Kit	512673S	
2.5 (83 kw)	1993.06-1995.06		Centre	Saloon RWD 605911		Center Bearing Support	510511
	1993.06-1995.06		Centre	Estate RWD 605911		Center Bearing Support	510511
	1993.06-1995.06		Front	Saloon RWD 605911		Flexible Coupling	510436
	1993.06-1995.06		Front	Estate RWD 605911		Flexible Coupling	510436
	1993.06-1995.06		Front	Saloon RWD 605911		Flexible Coupling	510569
	1993.06-1995.06		Front	Estate RWD 605911		Flexible Coupling	510569
	1993.06-1995.06		Front	Saloon RWD 605911		Flexible Coupling Kit	510434S
	1993.06-1995.06		Front	Estate RWD 605911		Flexible Coupling Kit	510434S
	1993.06-1995.06		Front	Saloon RWD 605911		Flexible Coupling Kit	510570S
	1993.06-1995.06		Front	Estate RWD 605911		Flexible Coupling Kit	510570S
	1995.07-2000.06		Centre	Saloon RWD 605912		Center Bearing Support	510568
	1995.07-2000.06		Front	Saloon RWD 605912		Flexible Coupling	510569
	1995.07-2000.06		Front	Saloon RWD 605912		Flexible Coupling Kit	510570S
	1995.07-2000.06		Front	Saloon RWD 605912	MT	Flexible Coupling Kit	537821S
	1996.06-1998.07		Front	Estate RWD 605912		Flexible Coupling	510569



	 YEAR	TRANSM.	FITTING POSITION	BODY STYLE & DRIVE TYPE & ENGINE	REMARKS	 PRODUCT	GSP Ref.
MERCEDES-BENZ E250							
2.5 (83 kw)	1996.06-1998.07		Front	Estate RWD 605912		Flexible Coupling Kit	510570S
	1996.06-1998.07		Front	Estate RWD 605912	MT	Flexible Coupling Kit	537821S
2.5 (93 kw)	1993.06-1995.06		Centre	Saloon RWD 602962		Center Bearing Support	511574
	1993.06-1995.06		Front	Saloon RWD 602962		Flexible Coupling	510436
	1993.06-1995.06		Front	Saloon RWD 602962		Flexible Coupling	510569
	1993.06-1995.06		Front	Saloon RWD 602962		Flexible Coupling Kit	510434S
	1993.06-1995.06		Front	Saloon RWD 602962		Flexible Coupling Kit	510570S
	1993.06-1996.01		Front	Estate RWD 602962		Flexible Coupling	510436
	1993.06-1996.01		Front	Estate RWD 602962		Flexible Coupling Kit	510434S
	1993.06-1996.01		Front	Estate RWD 602962		Flexible Coupling Kit	510570S
2.5 (110 kw)	1995.07-2000.06		Centre	Saloon RWD 605962		Center Bearing Support	512668
	1995.07-2000.06		Front;Rear	Saloon RWD 605962		Flexible Coupling	512678
	1995.07-2000.06		Front	Saloon RWD 605962		Flexible Coupling Kit	537819S
	1995.07-2000.06		Front;Rear	Saloon RWD 605962		Flexible Coupling Kit	512673S
	1997.11-1999.09		Centre	Estate RWD 605962		Center Bearing Support	512668
	1997.11-1999.09		Front;Rear	Estate RWD 605962		Flexible Coupling	512678
	1997.11-1999.09		Front	Estate RWD 605962		Flexible Coupling Kit	537819S
2.5 (150 kw)	1997.11-1999.09		Front;Rear	Estate RWD 605962		Flexible Coupling Kit	512673S
	2007.05-2008.12		Front;Rear	Saloon RWD 272922		Flexible Coupling Kit	512673S
E270							
2.7 (120 kw)	1999.07-2002.03		Front;Rear	Saloon RWD 612961		Flexible Coupling	512677
	1999.07-2002.03		Rear	Saloon RWD 612961		Flexible Coupling Kit	512672S
	2000.02-2003.03		Front;Rear	Estate RWD 612961		Flexible Coupling	512677
	2000.02-2003.03		Rear	Estate RWD 612961		Flexible Coupling Kit	512672S
	2002.03-2008.12		Front	Saloon RWD 647961		Flexible Coupling Kit	537794S
	2003.03-2009.07		Front	Estate RWD 647961		Flexible Coupling Kit	537794S
	2003.03-2009.07		Front	Chassis cabin RWD 647961		Flexible Coupling Kit	537794S
2.7 (125 kw)	1999.07-2002.03		Front;Rear	Saloon RWD 612961		Flexible Coupling	512677
	1999.07-2002.03		Rear	Saloon RWD 612961		Flexible Coupling Kit	512672S
	1999.07-2002.12		Front;Rear	Chassis cabin RWD 612961		Flexible Coupling	512677
	1999.07-2003.03		Front;Rear	Estate RWD 612961		Flexible Coupling	512677
	1999.07-2003.03		Rear	Estate RWD 612961		Flexible Coupling Kit	512672S
2.7 (130 kw)	2002.04-2005.07		Front	Saloon RWD 647961		Flexible Coupling Kit	537794S
	2003.04-2005.07		Front	Estate RWD 647961		Flexible Coupling Kit	537794S
	2003.10-2005.07		Front	Chassis cabin RWD 647961		Flexible Coupling Kit	537794S
E280							
2.8 (142 kw)	1993.06-1995.06		Front;Rear	Saloon RWD 104942		Flexible Coupling	510579
	1993.06-1995.06		Front	Saloon RWD 104942		Flexible Coupling Kit	510580S
	1993.06-1996.01		Centre	Estate RWD 104942		Center Bearing Support	511574
	1993.06-1996.01		Front;Rear	Estate RWD 104942		Flexible Coupling	510579
	1993.06-1996.01		Front	Estate RWD 104942		Flexible Coupling Kit	510580S
	1995.07-1997.10		Centre	Saloon RWD 104945		Center Bearing Support	512668
	1995.07-1997.10		Front	Saloon RWD 104945		Flexible Coupling	510571
	1995.07-1997.10		Front;Rear	Saloon RWD 104945		Flexible Coupling	510579
	1995.07-1997.10		Front	Saloon RWD 104945		Flexible Coupling Kit	510571S
	1995.07-1997.10		Front	Saloon RWD 104945		Flexible Coupling Kit	510580S
2.8 (145 kw)	1993.06-1995.06		Centre	Saloon RWD 104942		Center Bearing Support	511574
	1993.06-1995.06		Front	Saloon RWD 104942		Flexible Coupling	510571
	1993.06-1995.06		Front;Rear	Saloon RWD 104942		Flexible Coupling	510579
	1993.06-1995.06		Front	Saloon RWD 104942		Flexible Coupling Kit	537854S
	1993.06-1996.06		Centre	Estate RWD 104942		Center Bearing Support	511574
	1993.06-1996.06		Front;Rear	Estate RWD 104942		Flexible Coupling	510579
	1993.06-1996.06		Front	Estate RWD 104942		Flexible Coupling Kit	510580S
2.8 (150 kw)	1997.04-2002.03		Front	Saloon RWD 112921	MT;For OE No.124 411 05 15	Flexible Coupling	510571
	1997.04-2002.03		Front	Saloon RWD 112921	AT	Flexible Coupling	512678
	1997.04-2002.03		Front;Rear	Saloon RWD 112921		Flexible Coupling	510579
	1997.04-2002.03		Front	Saloon RWD 112921	VIN to:A 408865,AT	Flexible Coupling Kit	510580S
	1997.04-2002.03		Front	Saloon RWD 112921	MT	Flexible Coupling Kit	537850S
	1997.04-2002.03		Front;Rear	Saloon RWD 112921		Flexible Coupling Kit	512673S
	1997.11-2002.03	AT	Front	Saloon 4WD 112921		Propshaft	PS900348
	1997.11-2002.03	AT	Rear	Saloon 4WD 112921		Propshaft	PS900349
	1997.11-2002.03		Centre	Saloon 4WD 112921		Center Bearing Support	510568
	1997.11-2002.03		Front	Saloon 4WD 112921		Flexible Coupling	510569
1997.11-2002.03		Front;Rear	Saloon 4WD 112921		Flexible Coupling	510579	



	 YEAR	TRANSM.	FITTING POSITION	BODY STYLE & DRIVE TYPE & ENGINE	REMARKS	 PRODUCT	GSP Ref.
MERCEDES-BENZ							
E280							
2.8 (150 kw)	1997.11-2002.03		Front;Rear	Saloon 4WD 112921		Flexible Coupling	512678
	1997.11-2002.03		Front	Saloon 4WD 112921		Flexible Coupling Kit	510570S
	1997.11-2002.03		Front	Saloon 4WD 112921		Flexible Coupling Kit	510580S
	1997.11-2002.03		Front;Rear	Saloon 4WD 112921		Flexible Coupling Kit	512673S
	1997.11-2003.05	AT	Front	Estate 4WD 112921		Propshaft	PS900348
	1997.11-2003.05	AT	Rear	Estate 4WD 112921		Propshaft	PS900349
	1997.11-2003.05		Centre	Estate 4WD 112921		Center Bearing Support	510568
	1997.11-2003.05		Front;Rear	Estate 4WD 112921		Flexible Coupling	510579
	1997.11-2003.05		Front;Rear	Estate 4WD 112921		Flexible Coupling	512678
	1997.11-2003.05		Front;Rear	Estate RWD 112921		Flexible Coupling	512678
	1997.11-2003.05		Front	Estate 4WD 112921		Flexible Coupling Kit	510580S
	1997.11-2003.05		Front;Rear	Estate 4WD 112921		Flexible Coupling Kit	512673S
	1997.11-2003.05		Front;Rear	Estate RWD 112921		Flexible Coupling Kit	512673S
	1999.07-2002.11		Centre	Chassis cabin RWD 112921		Center Bearing Support	512668
	1999.07-2002.11		Front;Rear	Chassis cabin RWD 112921		Flexible Coupling	510579
1999.07-2002.11		Front;Rear	Chassis cabin RWD 112921		Flexible Coupling	512677	
1999.07-2002.11		Front	Chassis cabin RWD 112921		Flexible Coupling Kit	510580S	
1999.07-2002.11		Front;Rear	Chassis cabin RWD 112921		Flexible Coupling Kit	512673S	
3.0 (140 kw)	2005.03-2008.12	AT/MT	Front	Saloon 4WD 642921		Propshaft	PS900350
	2005.03-2008.12		Front;Rear	Saloon 4WD 642921		Flexible Coupling	533884
	2005.03-2008.12		Front	Saloon 4WD 642921		Flexible Coupling Kit	537794S
	2005.03-2008.12		Front;Rear	Saloon 4WD 642921		Flexible Coupling Kit	512673S
	2005.03-2008.12		Front;Rear	Saloon 4WD 642921	AT	Flexible Coupling Kit	537832S
	2005.03-2009.07	AT/MT	Front	Estate 4WD 642921	Date To:2006.12	Propshaft	PS900350
	2005.03-2009.07		Front;Rear	Estate 4WD 642921		Flexible Coupling	533884
	2005.03-2009.07		Front;Rear	Estate RWD 642920		Flexible Coupling	533884
	2005.03-2009.07		Front	Estate RWD 642920		Flexible Coupling Kit	537794S
	2005.03-2009.07		Front;Rear	Estate 4WD 642921		Flexible Coupling Kit	512673S
	2005.03-2009.07		Front;Rear	Estate 4WD 642921	AT	Flexible Coupling Kit	537832S
	2005.03-2009.07		Front;Rear	Estate RWD 642920		Flexible Coupling Kit	537832S
	2005.03-2011.12		Front;Rear	Saloon RWD 642920		Flexible Coupling	533884
	2005.03-2011.12		Front	Saloon RWD 642920		Flexible Coupling Kit	537794S
	2005.03-2011.12		Front;Rear	Saloon RWD 642920		Flexible Coupling Kit	537832S
	2005.08-2009.07		Front;Rear	Chassis cabin RWD 642920		Flexible Coupling	533884
	2005.08-2009.07		Front;Rear	Chassis cabin RWD 642920		Flexible Coupling Kit	537832S
	3.0 (170 kw)	2005.03-2008.12		Front;Rear	Saloon RWD 272943		Flexible Coupling Kit
2005.03-2009.07		AT/MT	Front	Estate 4WD 272944		Propshaft	PS900350
2005.03-2009.07			Front;Rear	Estate 4WD 272944		Flexible Coupling Kit	512673S
2005.03-2009.07			Front;Rear	Estate RWD 272943		Flexible Coupling Kit	512673S
2005.06-2008.12		AT/MT	Front	Saloon 4WD 272944	Date To:2006.12	Propshaft	PS900350
2005.06-2008.12		Front;Rear	Saloon 4WD 272944		Flexible Coupling Kit	512673S	
3.2 (130 kw)	2003.08-2005.07		Front;Rear	Saloon RWD 648961		Flexible Coupling	533884
	2003.08-2005.07		Front	Saloon RWD 648961		Flexible Coupling Kit	537794S
	2003.08-2005.07		Front;Rear	Saloon RWD 648961		Flexible Coupling Kit	537832S
	2003.10-2005.07		Front;Rear	Estate RWD 648961		Flexible Coupling	533884
	2003.10-2005.07		Front	Estate RWD 648961		Flexible Coupling Kit	537794S
	2003.10-2005.07		Front;Rear	Estate RWD 648961		Flexible Coupling Kit	537832S
E290							
2.9 (95 kw)	1995.07-1999.08		Front;Rear	Saloon RWD 602982		Flexible Coupling	510579
	1995.07-1999.08		Front	Saloon RWD 602982		Flexible Coupling Kit	510580S
	1995.07-1999.08		Front	Saloon RWD 602982		Flexible Coupling Kit	537796S
	1996.06-1999.08		Centre	Estate RWD 602982		Center Bearing Support	512668
	1996.06-1999.08		Front;Rear	Estate RWD 602982		Flexible Coupling	510579
	1996.06-1999.08		Front	Estate RWD 602982		Flexible Coupling Kit	510580S
	1996.06-1999.08		Front	Estate RWD 602982		Flexible Coupling Kit	537796S
	1996.07-1999.07		Front;Rear	Chassis cabin RWD 602982		Flexible Coupling	510579
1996.07-1999.07		Front	Chassis cabin RWD 602982		Flexible Coupling Kit	510580S	
E300							
2.0 (180 kw)	2016.07-		Front;Rear	Saloon RWD 274920		Flexible Coupling	537630
	2016.07-		Front;Rear	Saloon RWD 274920		Flexible Coupling Kit	537630S
	2016.12-		Front	Coupe RWD 274920		Flexible Coupling	537630
	2016.12-		Front;Rear	Coupe RWD 274920		Flexible Coupling Kit	537630S
	2017.06-		Front	Cabriolet RWD 274920		Flexible Coupling	537630
	2017.06-		Front;Rear	Cabriolet RWD 274920		Flexible Coupling Kit	537630S



	 YEAR	TRANSM.	FITTING POSITION	BODY STYLE & DRIVE TYPE & ENGINE	REMARKS	 PRODUCT	GSP Ref.
MERCEDES-BENZ E300							
2.0 (180 kw)	2017.12-		Front	Saloon RWD 654920		Flexible Coupling	537630
	2017.12-		Front;Rear	Saloon RWD 654920		Flexible Coupling Kit	537630S
	2018.05-		Front;Rear	Cabriolet RWD 654920		Flexible Coupling Kit	537630S
	2018.05-		Front;Rear	Coupe RWD 654920		Flexible Coupling Kit	537630S
2.0 (190 kw)	2018.08-		Front;Rear	Coupe RWD 264920		Flexible Coupling Kit	537630S
	2019.02-		Front;Rear	Saloon RWD 264920/274920		Flexible Coupling Kit	537630S
	2019.03-		Front;Rear	Cabriolet RWD 264920		Flexible Coupling Kit	537630S
	2019.06-		Front;Rear	Estate RWD 264920		Flexible Coupling Kit	537630S
	2019.06-		Front;Rear	Coupe RWD 264920		Flexible Coupling Kit	537630S
	2019.06-		Front;Rear	Saloon RWD 264920		Flexible Coupling Kit	537630S
	2019.06-		Front;Rear	Cabriolet RWD 264920		Flexible Coupling Kit	537630S
2.2 (150 kw)	2012.04-2016.12		Centre	Estate RWD 651924		Center Bearing Support	531051
	2012.04-2016.12		Centre	Saloon RWD 651924		Center Bearing Support	531051
3.0 (100 kw)	1993.06-1995.06		Centre	Saloon RWD 606910		Center Bearing Support	511574
	1993.06-1995.06		Front	Saloon RWD 606910		Flexible Coupling	510436
	1993.06-1995.06		Front	Saloon RWD 606910		Flexible Coupling	510569
	1993.06-1995.06		Front	Saloon RWD 606910		Flexible Coupling Kit	510434S
	1993.06-1995.06		Front	Saloon RWD 606910		Flexible Coupling Kit	510570S
	1993.06-1996.06		Centre	Estate RWD 606910		Center Bearing Support	511574
	1993.06-1996.06		Front	Estate RWD 606910		Flexible Coupling	510436
	1993.06-1996.06		Front	Estate RWD 606910		Flexible Coupling	510569
	1993.06-1996.06		Front	Estate RWD 606910		Flexible Coupling Kit	510434S
	1993.06-1996.06		Front	Estate RWD 606910		Flexible Coupling Kit	510570S
	1995.07-1997.10		Centre	Saloon RWD 606912		Center Bearing Support	512668
	1995.07-1997.10		Front	Saloon RWD 606912		Flexible Coupling	510569
	1995.07-1997.10		Front	Saloon RWD 606912		Flexible Coupling Kit	510570S
	3.0 (108 kw)	1993.06-1995.06		Centre	Saloon 4WD 603960		Center Bearing Support
1993.06-1995.06			Centre	Saloon RWD 603960		Center Bearing Support	511574
1993.06-1995.06			Rear	Saloon 4WD 603960		Flexible Coupling	510460
1993.06-1995.06			Rear	Saloon 4WD 603960		Flexible Coupling	510575
1993.06-1995.06			Rear	Saloon RWD 603960		Flexible Coupling	510575
1993.06-1995.06			Rear	Saloon 4WD 603960		Flexible Coupling Kit	510459S
1993.06-1995.06			Rear	Saloon 4WD 603960		Flexible Coupling Kit	510576S
1993.06-1995.06			Rear	Saloon RWD 603960		Flexible Coupling Kit	510576S
1993.06-1996.01			Centre	Estate 4WD 603963		Center Bearing Support	511574
1993.06-1996.01			Centre	Estate RWD 603960		Center Bearing Support	511574
1993.06-1996.01			Rear	Estate 4WD 603963		Flexible Coupling	510460
1993.06-1996.01			Rear	Estate 4WD 603963		Flexible Coupling	510575
1993.06-1996.01			Rear	Estate RWD 603960		Flexible Coupling	510575
1993.06-1996.01			Rear	Estate 4WD 603963		Flexible Coupling Kit	510459S
1993.06-1996.01			Rear	Estate 4WD 603963		Flexible Coupling Kit	510576S
1993.06-1996.01			Rear	Estate RWD 603960		Flexible Coupling Kit	510576S
3.0 (130 kw)	1996.10-1999.08		Centre	Saloon RWD 606962		Center Bearing Support	512668
	1996.10-1999.08		Front;Rear	Saloon RWD 606962		Flexible Coupling	512677
	1997.11-1999.09		Centre	Estate RWD 606962		Center Bearing Support	512668
	1997.11-1999.09		Front;Rear	Estate RWD 606962		Flexible Coupling	512677
3.0 (132 kw)	1993.06-1993.07		Centre	Saloon 4WD 103985		Center Bearing Support	511574
	1993.06-1993.07		Front	Saloon 4WD 103985		Flexible Coupling	510569
	1993.06-1993.07		Front	Saloon 4WD 103985		Flexible Coupling Kit	510570S
	1993.06-1993.07		Rear	Saloon 4WD 103985		Flexible Coupling Kit	510459S
	1993.06-1996.01		Front	Estate 4WD 103985		Flexible Coupling	510436
	1993.06-1996.01		Rear	Estate 4WD 103985		Flexible Coupling	510460
	1993.06-1996.01		Front	Estate 4WD 103985		Flexible Coupling Kit	510570S
1993.06-1996.01		Rear	Estate 4WD 103985		Flexible Coupling Kit	510459S	
3.0 (150 kw)	2009.12-2010.12		Centre	Saloon RWD 642850		Center Bearing Support	531051
	2009.12-2010.12		Rear	Saloon RWD 642850		Flexible Coupling	537843
	2009.12-2010.12		Front;Rear	Saloon RWD 642850		Flexible Coupling	533884
	2009.12-2010.12		Rear	Saloon RWD 642850		Flexible Coupling Kit	533884S
	2009.12-2010.12		Front;Rear	Saloon RWD 642850		Flexible Coupling Kit	537832S
3.0 (155 kw)	2007.09-2008.12		Front;Rear	Saloon RWD 642920		Flexible Coupling	533884
	2007.09-2008.12		Front;Rear	Saloon RWD 642920		Flexible Coupling Kit	537832S
3.0 (161 kw)	2011.01-2015.12		Front;Rear	Saloon RWD M 272.952		Flexible Coupling Kit	512673S
3.0 (170 kw)	2009.01-2013.12		Centre	Saloon RWD 272952		Center Bearing Support	531051
	2009.01-2013.12		Front;Rear	Saloon RWD 272952		Flexible Coupling Kit	512673S



	 YEAR	TRANSM.	FITTING POSITION	BODY STYLE & DRIVE TYPE & ENGINE	REMARKS	 PRODUCT	GSP Ref.
MERCEDES-BENZ E300							
3.0 (170 kw)	2009.11-2011.12		Centre	Estate RWD 272952		Center Bearing Support	531051
	2009.11-2011.12		Front;Rear	Estate RWD 272952		Flexible Coupling Kit	512673S
	2010.03-2015.12		Centre	Saloon RWD 642850/642852		Center Bearing Support	531051
	2010.03-2015.12		Front	Saloon RWD 642850/642852		Flexible Coupling	537851
	2010.03-2015.12		Rear	Saloon RWD 642850/642852		Flexible Coupling	537843
	2010.03-2015.12		Front;Rear	Saloon RWD 642850/642852		Flexible Coupling	533884
	2010.03-2015.12		Rear	Saloon RWD 642850/642852		Flexible Coupling Kit	533884S
	2010.03-2015.12		Front;Rear	Saloon RWD 642850/642852		Flexible Coupling Kit	537832S
	2010.03-2016.12		Centre	Estate RWD 642850/642852		Center Bearing Support	531051
	2010.03-2016.12		Front	Estate RWD 642850/642852		Flexible Coupling	537851
	2010.03-2016.12		Rear	Estate RWD 642850/642852		Flexible Coupling	537843
	2010.03-2016.12		Front;Rear	Estate RWD 642850/642852		Flexible Coupling	533884
	2010.03-2016.12		Rear	Estate RWD 642850/642852		Flexible Coupling Kit	533884S
3.5 (185 kw)	2011.04-2016.06		Front	Coupe RWD 276957		Flexible Coupling Kit	537889S
	2011.04-2016.06		Rear	Coupe RWD 276957		Flexible Coupling Kit	537793S
	2011.04-2016.06		Front;Rear	Coupe RWD 276957		Flexible Coupling Kit	512677S
	2011.04-2016.12		Front	Cabriolet RWD 276957		Flexible Coupling Kit	537889S
	2011.04-2016.12		Rear	Cabriolet RWD 276957		Flexible Coupling Kit	537793S
	2011.04-2016.12		Front;Rear	Cabriolet RWD 276957		Flexible Coupling Kit	512677S
	2011.07-2015.12	AT/MT	Front	Saloon 4WD 276952		Propshaft	PS900359
	2011.07-2015.12		Centre	Saloon RWD 276952		Center Bearing Support	531051
	2011.07-2015.12		Front	Saloon RWD 276952		Flexible Coupling Kit	537889S
	2011.07-2015.12		Front;Rear	Saloon RWD 276952		Flexible Coupling Kit	512677S
	2011.07-2016.12	AT/MT	Front	Estate 4WD 276952		Propshaft	PS900359
	2011.07-2016.12		Centre	Estate RWD 276952		Center Bearing Support	531051
	2011.07-2016.12		Front;Rear	Estate 4WD 276952		Flexible Coupling Kit	512673S
	2011.07-2016.12		Front;Rear	Estate RWD 276952		Flexible Coupling Kit	512677S
E320							
3.0 (165 kw)	2005.03-2008.12	AT/MT	Front	Saloon 4WD 642921		Propshaft	PS900350
	2005.03-2008.12		Front;Rear	Saloon 4WD 642921		Flexible Coupling	533884
	2005.03-2008.12		Front;Rear	Saloon RWD 642920		Flexible Coupling	533884
	2005.03-2008.12		Front	Saloon 4WD 642921		Flexible Coupling Kit	537794S
	2005.03-2008.12		Front	Saloon RWD 642920		Flexible Coupling Kit	537794S
	2005.03-2008.12		Front;Rear	Saloon 4WD 642921		Flexible Coupling Kit	512673S
	2005.03-2008.12		Front;Rear	Saloon 4WD 642921	AT	Flexible Coupling Kit	537832S
	2005.03-2008.12		Front;Rear	Saloon RWD 642920		Flexible Coupling Kit	537832S
	2005.03-2009.07	AT/MT	Front	Estate 4WD 642921		Propshaft	PS900350
	2005.03-2009.07		Front;Rear	Estate 4WD 642921		Flexible Coupling	533884
	2005.03-2009.07		Front;Rear	Estate RWD 642920		Flexible Coupling	533884
	2005.03-2009.07		Front	Estate 4WD 642921		Flexible Coupling Kit	537794S
	2005.03-2009.07		Front;Rear	Estate 4WD 642921		Flexible Coupling Kit	512673S
	2005.03-2009.07		Front;Rear	Estate 4WD 642921	AT	Flexible Coupling Kit	537832S
	2005.03-2009.07		Front;Rear	Estate RWD 642920		Flexible Coupling Kit	537832S
3.0 (200 kw)	2014.07-2016.12		Front	Cabriolet RWD 276820		Flexible Coupling Kit	537889S
	2014.07-2016.12		Front	Coupe RWD 276820		Flexible Coupling Kit	537889S
3.2 (145 kw)	1999.07-2002.03		Front;Rear	Saloon RWD 613961		Flexible Coupling	512677
	1999.07-2002.03		Rear	Saloon RWD 613961		Flexible Coupling Kit	512672S
	1999.07-2003.05		Front;Rear	Estate RWD 613961		Flexible Coupling	512677
	1999.07-2003.05		Rear	Estate RWD 613961		Flexible Coupling Kit	512672S
3.2 (150 kw)	2002.11-2006.07		Front;Rear	Saloon RWD 648961		Flexible Coupling	533884
	2002.11-2006.07		Front;Rear	Saloon RWD 648961		Flexible Coupling Kit	537832S
	2003.04-2006.07		Front;Rear	Estate RWD 648961		Flexible Coupling	533884
	2003.04-2006.07		Front;Rear	Estate RWD 648961		Flexible Coupling Kit	537832S
3.2 (162 kw)	1993.06-1995.06		Centre	Saloon RWD 104992		Center Bearing Support	511574
	1993.06-1995.06		Front;Rear	Saloon RWD 104992		Flexible Coupling	510579
	1993.06-1996.01		Centre	Estate RWD 104992		Center Bearing Support	511574
	1993.06-1996.01		Front;Rear	Estate RWD 104992		Flexible Coupling	510579
	1993.06-1996.07		Centre	Coupe RWD 104992		Center Bearing Support	511574
	1993.06-1996.07		Centre	Cabriolet RWD 104992		Center Bearing Support	511574
	1993.06-1996.07		Front;Rear	Coupe RWD 104992		Flexible Coupling	510579
	1993.06-1996.07		Front;Rear	Cabriolet RWD 104992		Flexible Coupling	510579
	1995.07-1997.06		Centre	Saloon RWD 104995		Center Bearing Support	512668
1995.07-1997.06		Front;Rear	Saloon RWD 104995		Flexible Coupling	510579	



	 YEAR	TRANSM.	FITTING POSITION	BODY STYLE & DRIVE TYPE & ENGINE	REMARKS	 PRODUCT	GSP Ref.
MERCEDES-BENZ E320							
3.2 (162 kw)	1995.07-1997.06		Front	Saloon RWD 104995		Flexible Coupling Kit	510580S
3.2 (165 kw)	1997.04-2002.03		Front;Rear	Saloon RWD 112941		Flexible Coupling	510579
	1997.04-2002.03		Front;Rear	Saloon RWD 112941		Flexible Coupling	512678
	1997.04-2002.03		Front	Saloon RWD 112941		Flexible Coupling Kit	510580S
	1997.04-2002.03		Front;Rear	Saloon RWD 112941		Flexible Coupling Kit	512673S
	1997.04-2003.05		Front;Rear	Estate RWD 112941		Flexible Coupling	510579
	1997.04-2003.05		Front;Rear	Estate RWD 112941		Flexible Coupling	512678
	1997.04-2003.05		Front	Estate RWD 112941		Flexible Coupling Kit	510580S
	1997.04-2003.05		Front;Rear	Estate RWD 112941		Flexible Coupling Kit	512673S
	1997.05-2002.03	AT	Front	Saloon 4WD 112941		Propshaft	PS900348
	1997.05-2002.03	AT	Rear	Saloon 4WD 112941		Propshaft	PS900349
	1997.05-2002.03		Centre	Saloon 4WD 112941		Center Bearing Support	510568
	1997.05-2002.03		Front	Saloon 4WD 112941		Flexible Coupling	510569
	1997.05-2002.03		Front;Rear	Saloon 4WD 112941		Flexible Coupling	510579
	1997.05-2002.03		Front;Rear	Saloon 4WD 112941		Flexible Coupling	512678
	1997.05-2002.03		Front	Saloon 4WD 112941		Flexible Coupling Kit	510570S
	1997.05-2002.03		Front	Saloon 4WD 112941		Flexible Coupling Kit	510580S
	1997.05-2003.05	AT	Front	Estate 4WD 112941		Propshaft	PS900348
	1997.05-2003.05	AT	Rear	Estate 4WD 112941		Propshaft	PS900349
	1997.05-2003.05		Centre	Estate 4WD 112941		Center Bearing Support	510568
	1997.05-2003.05		Front	Estate 4WD 112941		Flexible Coupling	510569
	1997.05-2003.05		Front;Rear	Estate 4WD 112941		Flexible Coupling	510579
	1997.05-2003.05		Front;Rear	Estate 4WD 112941		Flexible Coupling	512678
	1997.05-2003.05		Front	Estate 4WD 112941		Flexible Coupling Kit	510570S
	1997.05-2003.05		Front	Estate 4WD 112941		Flexible Coupling Kit	510580S
	1997.05-2003.05		Front;Rear	Estate 4WD 112941		Flexible Coupling Kit	512673S
	2002.04-2004.07		Front;Rear	Saloon RWD 112949		Flexible Coupling Kit	512673S
	2003.04-2004.07		Front;Rear	Estate RWD 112949		Flexible Coupling Kit	512673S
	2003.06-2005.12	AT/MT	Front	Estate 4WD 112954	Date To:2005.12	Propshaft	PS900351
	2003.06-2005.12		Front;Rear	Estate 4WD 112954		Flexible Coupling Kit	512673S
	2003.08-2004.07	AT/MT	Front	Saloon 4WD 112954		Propshaft	PS900351
2003.08-2004.07		Front;Rear	Saloon 4WD 112954		Flexible Coupling Kit	512673S	
E350							
2.0 (220 kw)	2017.10-		Front	Coupe RWD 264920		Flexible Coupling	537630
	2017.10-		Front	Cabriolet RWD 264920		Flexible Coupling	537630
	2017.10-		Front;Rear	Coupe RWD 264920		Flexible Coupling Kit	537630S
	2017.10-		Front;Rear	Cabriolet RWD 264920		Flexible Coupling Kit	537630S
	2018.08-		Front;Rear	Saloon RWD 264920		Flexible Coupling Kit	537630S
3.0 (155 kw)	2009.01-2015.12		Centre	Saloon RWD 642850		Center Bearing Support	531051
	2009.01-2015.12		Rear	Saloon RWD 642850		Flexible Coupling	537843
	2009.01-2015.12		Front;Rear	Saloon RWD 642850		Flexible Coupling	533884
	2009.01-2015.12		Rear	Saloon RWD 642850		Flexible Coupling Kit	533884S
	2009.01-2015.12		Rear	Saloon RWD 642850		Flexible Coupling Kit	537843S
	2009.01-2015.12		Front;Rear	Saloon RWD 642850		Flexible Coupling Kit	537832S
	2009.11-2013.12		Centre	Estate RWD 642850		Center Bearing Support	531051
	2009.11-2013.12		Rear	Estate RWD 642850		Flexible Coupling	537843
	2009.11-2013.12		Front;Rear	Estate RWD 642850		Flexible Coupling	533884
	2009.11-2013.12		Rear	Estate RWD 642850		Flexible Coupling Kit	533884S
2009.11-2013.12		Front;Rear	Estate RWD 642850		Flexible Coupling Kit	537832S	
3.0 (170 kw)	2009.01-2011.06		Front;Rear	Coupe RWD 642836		Flexible Coupling	533884
	2009.01-2011.06		Front;Rear	Coupe RWD 642836		Flexible Coupling Kit	537832S
	2009.01-2011.08		Centre	Saloon 4WD 642856		Center Bearing Support	531051
	2009.01-2011.08		Rear	Saloon 4WD 642856		Flexible Coupling	537843
	2009.01-2011.08		Rear	Saloon 4WD 642856		Flexible Coupling Kit	533884S
	2009.01-2011.08		Front;Rear	Saloon 4WD 642856		Flexible Coupling Kit	512673S
	2009.01-2011.12		Centre	Estate 4WD 642856		Center Bearing Support	531051
	2009.01-2011.12		Centre	Estate RWD 642850		Center Bearing Support	531051
	2009.01-2011.12		Rear	Estate 4WD 642856		Flexible Coupling	537843
	2009.01-2011.12		Rear	Estate RWD 642850		Flexible Coupling	537843
	2009.01-2011.12		Front;Rear	Estate 4WD 642856		Flexible Coupling	533884
	2009.01-2011.12		Front;Rear	Estate RWD 642850		Flexible Coupling	533884
	2009.01-2011.12		Rear	Estate 4WD 642856		Flexible Coupling Kit	533884S
	2009.01-2011.12		Rear	Estate RWD 642850		Flexible Coupling Kit	533884S
	2009.01-2011.12		Front;Rear	Estate 4WD 642856		Flexible Coupling Kit	512673S



	 YEAR	TRANSM.	FITTING POSITION	BODY STYLE & DRIVE TYPE & ENGINE	REMARKS	 PRODUCT	GSP Ref.	
MERCEDES-BENZ E350								
3.0 (170 kw)	2009.01-2011.12		Front;Rear	Estate 4WD 642856	not for 5AT	Flexible Coupling Kit	537832S	
	2009.01-2011.12		Front;Rear	Estate RWD 642850		Flexible Coupling Kit	537832S	
	2009.01-2015.12		Centre	Saloon RWD 642850		Center Bearing Support	531051	
	2009.01-2015.12		Rear	Saloon RWD 642850		Flexible Coupling	537843	
	2009.01-2015.12		Front;Rear	Saloon RWD 642850		Flexible Coupling	533884	
	2009.01-2015.12		Rear	Saloon RWD 642850		Flexible Coupling Kit	533884S	
	2009.01-2015.12		Rear	Saloon RWD 642850		Flexible Coupling Kit	537843S	
	2009.01-2015.12		Front;Rear	Saloon RWD 642850		Flexible Coupling Kit	537832S	
	2010.01-2011.12		Front;Rear	Cabriolet RWD 642836		Flexible Coupling	533884	
	2010.01-2011.12		Front;Rear	Cabriolet RWD 642836		Flexible Coupling Kit	537832S	
3.0 (185 kw)	2013.01-2015.12		Centre	Saloon 4WD 642858		Center Bearing Support	531051	
	2013.01-2015.12		Front	Saloon 4WD 642858		Flexible Coupling	537851	
	2013.01-2015.12		Front	Saloon RWD 642852		Flexible Coupling	537851	
	2013.01-2015.12		Rear	Saloon 4WD 642858		Flexible Coupling	537843	
	2013.01-2015.12		Rear	Saloon RWD 642852		Flexible Coupling	537843	
	2013.01-2015.12		Front;Rear	Saloon 4WD 642858		Flexible Coupling	533884	
	2013.01-2015.12		Front;Rear	Saloon RWD 642852		Flexible Coupling	533884	
	2013.01-2015.12		Rear	Saloon 4WD 642858		Flexible Coupling Kit	533884S	
	2013.01-2015.12		Rear	Saloon RWD 642852		Flexible Coupling Kit	533884S	
	2013.01-2015.12		Front;Rear	Saloon 4WD 642858		Flexible Coupling Kit	537832S	
	2013.01-2015.12		Front;Rear	Saloon RWD 642852		Flexible Coupling Kit	537832S	
	2013.01-2016.12		Centre	Estate 4WD 642858		Center Bearing Support	531051	
	2013.01-2016.12		Front	Estate 4WD 642858		Flexible Coupling	537851	
	2013.01-2016.12		Front	Estate RWD 642852		Flexible Coupling	537851	
	2013.01-2016.12		Rear	Estate 4WD 642858		Flexible Coupling	537843	
	2013.01-2016.12		Rear	Estate RWD 642852		Flexible Coupling	537843	
	2013.01-2016.12		Front;Rear	Estate 4WD 642858		Flexible Coupling	533884	
	2013.01-2016.12		Front;Rear	Estate RWD 642852		Flexible Coupling	533884	
	2013.01-2016.12		Rear	Estate 4WD 642858		Flexible Coupling Kit	533884S	
	2013.01-2016.12		Rear	Estate RWD 642852		Flexible Coupling Kit	533884S	
	2013.01-2016.12		Front;Rear	Estate 4WD 642858		Flexible Coupling Kit	537832S	
	2013.01-2016.12		Front;Rear	Estate RWD 642852		Flexible Coupling Kit	537832S	
	2013.03-2016.12		Front	Cabriolet RWD 642838		Flexible Coupling	537851	
	2013.03-2016.12		Front;Rear	Cabriolet RWD 642838		Flexible Coupling	533884	
	2013.03-2016.12		Front;Rear	Cabriolet RWD 642838		Flexible Coupling Kit	537832S	
	2013.06-2016.12		Front	Coupe RWD 642838		Flexible Coupling	537851	
	2013.06-2016.12		Front;Rear	Coupe RWD 642838		Flexible Coupling	533884	
	2013.06-2016.12		Front;Rear	Coupe RWD 642838		Flexible Coupling Kit	537832S	
	3.0 (190 kw)	2014.05-2015.12		Centre	Saloon 4WD 642858		Center Bearing Support	531051
		2014.05-2015.12		Front	Saloon 4WD 642858		Flexible Coupling	537851
		2014.05-2015.12		Front	Saloon RWD 642852		Flexible Coupling	537851
2014.05-2016.12			Centre	Estate 4WD 642858		Center Bearing Support	531051	
2014.05-2016.12			Front	Cabriolet RWD 642838		Flexible Coupling	537851	
2014.05-2016.12			Front	Coupe RWD 642838		Flexible Coupling	537851	
2014.05-2016.12			Front	Estate 4WD 642858		Flexible Coupling	537851	
2014.05-2016.12			Front	Estate RWD 642852		Flexible Coupling	537851	
2016.01-2018.05			Front;Rear	Saloon RWD 642855		Flexible Coupling	537851	
2016.10-			Front;Rear	Estate RWD 642855		Flexible Coupling	537851	
2017.06-			Front	Estate 4WD 642873		Flexible Coupling	537630	
2017.06-			Front	Coupe 4WD 642873		Flexible Coupling	537630	
2017.06-			Front	Cabriolet 4WD 642873		Flexible Coupling	537630	
2017.06-			Front;Rear	Estate 4WD 642873		Flexible Coupling Kit	537630S	
2017.06-			Front;Rear	Coupe 4WD 642873		Flexible Coupling Kit	537630S	
2017.06-			Front;Rear	Cabriolet 4WD 642873		Flexible Coupling Kit	537630S	
2017.06-2018.05			Rear	Saloon 4WD 642873		Flexible Coupling	537630	
2017.06-2018.05			Front;Rear	Saloon 4WD 642873		Flexible Coupling Kit	537630S	
3.0 (195 kw)		2011.03-2015.12		Centre	Saloon 4WD 642858		Center Bearing Support	531051
		2011.03-2015.12		Front	Saloon RWD 642852		Flexible Coupling	537851
		2011.03-2015.12		Front	Saloon 4WD 642858		Flexible Coupling	537851
	2011.03-2015.12		Rear	Saloon RWD 642852		Flexible Coupling	537843	
	2011.03-2015.12		Rear	Saloon 4WD 642858		Flexible Coupling	537843	
	2011.03-2015.12		Front;Rear	Saloon RWD 642852		Flexible Coupling	533884	
	2011.03-2015.12		Front;Rear	Saloon 4WD 642858		Flexible Coupling	533884	
	2011.03-2015.12		Rear	Saloon RWD 642852		Flexible Coupling Kit	533884S	



	 YEAR	TRANSM.	FITTING POSITION	BODY STYLE & DRIVE TYPE & ENGINE	REMARKS	 PRODUCT	GSP Ref.	
MERCEDES-BENZ E350								
3.0 (195 kw)	2011.03-2015.12		Rear	Saloon 4WD 642858		Flexible Coupling Kit	533884S	
	2011.03-2015.12		Front;Rear	Saloon 4WD 642858		Flexible Coupling Kit	512677S	
	2011.03-2015.12		Front;Rear	Saloon RWD 642852		Flexible Coupling Kit	537832S	
	2011.03-2015.12		Front;Rear	Saloon 4WD 642858	9AT	Flexible Coupling Kit	537832S	
	2011.04-2013.12		Front	Cabriolet RWD 642838		Flexible Coupling	537851	
	2011.04-2013.12		Front;Rear	Cabriolet RWD 642838		Flexible Coupling	533884	
	2011.04-2013.12		Front;Rear	Cabriolet RWD 642838		Flexible Coupling Kit	537832S	
	2011.06-2013.06		Front	Coupe RWD 642838		Flexible Coupling	537851	
	2011.06-2013.06		Front;Rear	Coupe RWD 642838		Flexible Coupling	533884	
	2011.06-2013.06		Front;Rear	Coupe RWD 642838		Flexible Coupling Kit	537832S	
	2011.07-2013.12		Centre	Estate 4WD 642858		Center Bearing Support	531051	
	2011.07-2013.12		Front	Estate RWD 642852		Flexible Coupling	537851	
	2011.07-2013.12		Front	Estate 4WD 642858		Flexible Coupling	537851	
	2011.07-2013.12		Rear	Estate RWD 642852		Flexible Coupling	537843	
	2011.07-2013.12		Rear	Estate 4WD 642858		Flexible Coupling	537843	
	2011.07-2013.12		Front;Rear	Estate RWD 642852		Flexible Coupling	533884	
	2011.07-2013.12		Front;Rear	Estate 4WD 642858		Flexible Coupling	533884	
	2011.07-2013.12		Rear	Estate RWD 642852		Flexible Coupling Kit	533884S	
	2011.07-2013.12		Rear	Estate 4WD 642858		Flexible Coupling Kit	533884S	
	2011.07-2013.12		Front;Rear	Estate 4WD 642858		Flexible Coupling Kit	512677S	
2011.07-2013.12		Front;Rear	Estate RWD 642852		Flexible Coupling Kit	537832S		
2011.07-2013.12		Front;Rear	Estate 4WD 642858	9AT	Flexible Coupling Kit	537832S		
3.5 (200 kw)	2004.08-2006.07	AT/MT	Front	Estate 4WD 272972	Chassis no. from: B196719 or X257500	Propshaft	PS900350	
	2004.08-2006.07	AT/MT	Front	Estate 4WD 272972	Chassis no. to: B196718 or X257499	Propshaft	PS900351	
	2004.08-2006.07		Front	Estate 4WD 272972		Flexible Coupling Kit	537794S	
	2004.08-2006.07		Rear	Estate 4WD 272972		Flexible Coupling Kit	537793S	
	2004.08-2006.07		Front;Rear	Estate 4WD 272972		Flexible Coupling Kit	512673S	
	2004.08-2006.07		Front;Rear	Estate 4WD 272972	For OE No.0004110200	Flexible Coupling Kit	512677S	
	2004.08-2008.12	AT/MT	Front	Saloon 4WD 272972	Chassis no. from: B196719 or X257500	Propshaft	PS900350	
	2004.08-2008.12	AT/MT	Front	Saloon 4WD 272972	Chassis no. to: B196718 or X257499	Propshaft	PS900351	
	2004.08-2008.12		Front	Saloon 4WD 272972		Flexible Coupling Kit	537794S	
	2004.08-2008.12		Front	Saloon RWD 272964		Flexible Coupling Kit	537794S	
	2004.08-2008.12		Rear	Saloon 4WD 272972		Flexible Coupling Kit	537793S	
	2004.08-2008.12		Rear	Saloon RWD 272964		Flexible Coupling Kit	537793S	
	2004.08-2008.12		Front;Rear	Saloon 4WD 272972		Flexible Coupling Kit	512673S	
	2004.08-2008.12		Front;Rear	Saloon 4WD 272972	For OE No.0004110200	Flexible Coupling Kit	512677S	
	2004.08-2008.12		Front;Rear	Saloon RWD 272964		Flexible Coupling Kit	512677S	
	2004.08-2009.07		Front	Estate RWD 272964		Flexible Coupling Kit	537794S	
	2004.08-2009.07		Rear	Estate RWD 272964		Flexible Coupling Kit	537793S	
	2004.08-2009.07		Front;Rear	Estate RWD 272964		Flexible Coupling Kit	512677S	
	2009.01-2011.08	AT/MT	Front	Saloon 4WD 272977		Propshaft	PS900359	
	2009.01-2011.08		Front;Rear	Saloon 4WD 272977		Flexible Coupling Kit	512673S	
	2009.01-2011.12	AT/MT	Front	Estate 4WD 272977		Propshaft	PS900359	
	2009.01-2011.12		Front;Rear	Estate 4WD 272977		Flexible Coupling Kit	512673S	
	2009.01-2013.12		Centre	Saloon RWD 272980		Center Bearing Support	531051	
	2009.01-2013.12		Front	Saloon RWD 272980		Flexible Coupling Kit	537889S	
	2009.01-2013.12		Rear	Saloon RWD 272980		Flexible Coupling Kit	537793S	
	2009.01-2013.12		Front;Rear	Saloon RWD 272980		Flexible Coupling Kit	512677S	
	2009.06-2011.12		Front;Rear	Coupe RWD 272961/272988		Flexible Coupling Kit	512677S	
	2009.08-2011.12		Centre	Estate RWD 272980		Center Bearing Support	531051	
	2009.08-2011.12		Rear	Estate RWD 272980		Flexible Coupling Kit	537793S	
	2009.08-2011.12		Front;Rear	Estate RWD 272980		Flexible Coupling Kit	512677S	
	2010.03-2011.12		Front;Rear	Cabriolet RWD 272961/272988		Flexible Coupling Kit	512677S	
	3.5 (205 kw)	2004.08-2006.08		Rear	Saloon AWD M 272.972		Flexible Coupling Kit	537793S
		2004.08-2006.08		Front;Rear	Saloon AWD M 272.972		Flexible Coupling Kit	512673S
2004.08-2006.08			Front;Rear	Saloon AWD M 272.972		Flexible Coupling Kit	512677S	
3.5 (215 kw)	2006.05-2008.12		Rear	Saloon RWD 272985		Flexible Coupling Kit	537793S	
	2006.05-2008.12		Front;Rear	Saloon RWD 272985		Flexible Coupling Kit	512677S	
	2006.05-2009.07		Rear	Estate RWD 272985		Flexible Coupling Kit	537793S	
	2006.05-2009.07		Front;Rear	Estate RWD 272985		Flexible Coupling Kit	512677S	
	2009.01-2011.08		Centre	Saloon RWD 272983		Center Bearing Support	531051	
	2009.01-2011.08		Front	Saloon RWD 272983		Flexible Coupling Kit	537889S	
	2009.01-2011.08		Rear	Saloon RWD 272983		Flexible Coupling Kit	537793S	
	2009.01-2011.08		Front;Rear	Saloon RWD 272983		Flexible Coupling Kit	512677S	



	 YEAR	TRANSM.	FITTING POSITION	BODY STYLE & DRIVE TYPE & ENGINE	REMARKS	 PRODUCT	GSP Ref.
MERCEDES-BENZ E350							
3.5 (215 kw)	2009.01-2011.12		Centre	Estate RWD 272983		Center Bearing Support	531051
	2009.01-2011.12		Rear	Estate RWD 272983		Flexible Coupling Kit	537793S
	2009.01-2011.12		Front;Rear	Coupe RWD 272982/272984		Flexible Coupling Kit	512677S
	2009.01-2011.12		Front;Rear	Estate RWD 272983		Flexible Coupling Kit	512677S
	2010.01-2014.12		Front;Rear	Cabriolet RWD 272984		Flexible Coupling Kit	512677S
3.5 (225 kw)	2009.01-2015.12	AT/MT	Front	Saloon 4WD 276952		Propshaft	PS900359
	2011.04-2014.12		Front	Coupe RWD 276957		Flexible Coupling Kit	537889S
	2011.04-2014.12		Front	Cabriolet RWD 276957		Flexible Coupling Kit	537889S
	2011.04-2014.12		Rear	Coupe RWD 276957		Flexible Coupling Kit	537793S
	2011.04-2014.12		Rear	Cabriolet RWD 276957		Flexible Coupling Kit	537793S
	2011.04-2014.12		Front;Rear	Coupe AWD M 276.957		Flexible Coupling Kit	512673S
	2011.04-2014.12		Front;Rear	Coupe RWD 276957		Flexible Coupling Kit	512677S
	2011.04-2014.12		Front;Rear	Cabriolet RWD 276957		Flexible Coupling Kit	512677S
	2011.04-2014.12		Front;Rear	Coupe RWD M 276.957		Flexible Coupling Kit	512677S
	2011.09-2014.12		Centre	Estate RWD 276952		Center Bearing Support	531051
	2011.09-2014.12		Front;Rear	Estate RWD 276952		Flexible Coupling Kit	512677S
	2011.09-2015.12		Centre	Saloon RWD 276952		Center Bearing Support	531051
	2011.09-2015.12		Front	Saloon RWD 276952		Flexible Coupling Kit	537889S
	2011.09-2015.12		Front;Rear	Saloon RWD 276952		Flexible Coupling Kit	512677S
	2011.09-2016.12	AT/MT	Front	Estate 4WD 276952		Propshaft	PS900359
	2011.09-2016.12		Front;Rear	Estate 4WD 276952		Flexible Coupling Kit	512673S
	2012.01-2014.12		Front;Rear	Convertible RWD M 276.957		Flexible Coupling Kit	512677S
	2013.01-2016.12		Front;Rear	Coupe 4WD 276957		Flexible Coupling Kit	512673S
	E36 AMG						
3.6 (200 kw)	1993.06-1995.06		Front;Rear	Saloon RWD 104992AMG		Flexible Coupling	510579
	1993.06-1997.06		Centre	Coupe RWD 104992AMG		Center Bearing Support	511574
	1993.06-1997.06		Front;Rear	Coupe RWD 104992AMG		Flexible Coupling	510579
	1993.06-1997.07		Centre	Cabriolet RWD 104992AMG		Center Bearing Support	511574
	1993.06-1997.07		Front;Rear	Cabriolet RWD 104992AMG		Flexible Coupling	510579
	1994.03-1996.01		Centre	Estate RWD 104992AMG		Center Bearing Support	511574
	1994.03-1996.01		Front;Rear	Estate RWD 104992AMG		Flexible Coupling	510579
	1996.04-1998.01		Front;Rear	Saloon RWD 104995AMG		Flexible Coupling	510579
E400							
2.9 (250 kw)	2018.04-		Front;Rear	Estate 4WD 656929		Flexible Coupling Kit	537630S
	2018.04-		Front;Rear	Saloon 4WD 656929		Flexible Coupling Kit	537630S
	2018.08-		Front;Rear	Cabriolet 4WD 656929		Flexible Coupling Kit	537630S
	2018.08-		Front;Rear	Coupe 4WD 656929		Flexible Coupling Kit	537630S
3.0 (245 kw)	2013.01-2016.12	AT	Front	Estate 4WD 276820		Propshaft	PS900357
	2013.01-2016.12	AT	Front	Saloon 4WD 276820		Propshaft	PS900357
	2013.01-2016.12		Centre	Estate RWD 276820		Center Bearing Support	531051
	2013.01-2016.12		Centre	Saloon RWD 276820		Center Bearing Support	531051
	2013.03-2016.12		Front	Cabriolet RWD 276820	7AT	Flexible Coupling Kit	537889S
	2013.03-2016.12		Front	Cabriolet RWD 276820		Flexible Coupling Kit	537889S
	2013.03-2016.12		Front	Coupe RWD 276820	7AT	Flexible Coupling Kit	537889S
	2013.03-2016.12		Front	Coupe RWD 276820		Flexible Coupling Kit	537889S
	2016.06-		Front	Saloon 4WD 276823		Flexible Coupling	537630
	2016.06-		Front;Rear	Saloon 4WD 276823		Flexible Coupling Kit	537630S
	2016.12-		Front	Coupe 4WD 276823		Flexible Coupling	537630
	2016.12-		Front;Rear	Coupe 4WD 276823		Flexible Coupling	537627
	2016.12-		Front;Rear	Coupe 4WD 276823		Flexible Coupling Kit	537630S
	2017.06-		Front	Cabriolet 4WD 276823		Flexible Coupling	537630
	2017.06-		Front;Rear	Cabriolet 4WD 276823		Flexible Coupling Kit	537630S
3.5 (245 kw)	2014.07-2015.12	AT	Front	Saloon 4WD 276850	Date From:2015.01	Propshaft	PS900357
	2014.07-2015.12		Centre	Saloon RWD 276850		Center Bearing Support	531051
	2014.07-2016.12	AT	Front	Estate 4WD 276850	Date From:2015.01	Propshaft	PS900357
	2014.07-2016.12		Centre	Estate RWD 276850		Center Bearing Support	531051
	2014.07-2016.12		Front	Cabriolet RWD 276850		Flexible Coupling Kit	537889S
	2014.07-2016.12		Front	Coupe RWD 276850		Flexible Coupling Kit	537889S
	2016.07-		Front	Saloon 4WD 276853		Flexible Coupling	537630
	2016.07-		Front;Rear	Saloon 4WD 276853		Flexible Coupling	537627
	2016.07-		Front;Rear	Saloon 4WD 276853		Flexible Coupling Kit	537630S
	2016.10-		Rear	Estate 4WD 276853		Flexible Coupling	537630
	2016.10-		Front;Rear	Estate 4WD 276853		Flexible Coupling	537627
2016.10-		Front;Rear	Estate 4WD 276853		Flexible Coupling Kit	537630S	



	 YEAR	TRANSM.	FITTING POSITION	BODY STYLE & DRIVE TYPE & ENGINE	REMARKS	 PRODUCT	GSP Ref.
MERCEDES-BENZ E400							
4.0 (191 kw)	2003.02-2005.07		Front;Rear	Saloon RWD 628961		Flexible Coupling	533884
	2003.02-2005.07		Front;Rear	Saloon RWD 628961		Flexible Coupling Kit	537832S
E420							
4.0 (231 kw)	2005.08-2008.12		Front;Rear	Saloon RWD 629910		Flexible Coupling	533884
	2005.08-2008.12		Front;Rear	Saloon RWD 629910		Flexible Coupling Kit	537832S
4.2 (205 kw)	1993.06-1995.06		Front	Saloon RWD 119975		Flexible Coupling	512676
	1993.06-1995.06		Front	Saloon RWD 119975		Flexible Coupling Kit	512671S
	1995.07-1997.10		Front;Rear	Saloon RWD 119985		Flexible Coupling	512677
	1996.06-1997.10		Front;Rear	Estate RWD 119985		Flexible Coupling	512677
E43 AMG							
3.0 (295 kw)	2016.07-		Front;Rear	Saloon 4WD 276823		Flexible Coupling	537630
	2016.07-		Front;Rear	Saloon 4WD 276823		Flexible Coupling Kit	537630S
	2016.10-		Front;Rear	Estate 4WD 276823		Flexible Coupling	537630
	2016.10-		Front;Rear	Estate 4WD 276823		Flexible Coupling Kit	537630S
E430							
4.3 (205 kw)	1997.04-2002.03		Front;Rear	Saloon RWD 113940		Flexible Coupling	512677
	1997.11-2003.05		Front;Rear	Estate RWD 113940		Flexible Coupling	512677
	1999.09-2002.03	AT	Front	Saloon 4WD 113940		Propshaft	PS900348
	1999.09-2002.03	AT	Rear	Saloon 4WD 113940		Propshaft	PS900349
	1999.09-2002.03		Front;Rear	Saloon 4WD 113940		Flexible Coupling	512678
	1999.09-2002.03		Front;Rear	Saloon 4WD 113940		Flexible Coupling Kit	512673S
	1999.09-2003.05	AT	Front	Estate 4WD 113940		Propshaft	PS900348
	1999.09-2003.05	AT	Rear	Estate 4WD 113940		Propshaft	PS900349
	1999.09-2003.05		Front;Rear	Estate 4WD 113940		Flexible Coupling	512678
	1999.09-2003.05		Front;Rear	Estate 4WD 113940		Flexible Coupling Kit	512673S
E450							
3.0 (270 kw)	2018.08-		Front;Rear	Cabriolet 4WD 276823		Flexible Coupling Kit	537630S
	2018.08-		Front;Rear	Coupe 4WD 276823		Flexible Coupling Kit	537630S
	2018.08-		Front;Rear	Saloon 4WD 276823		Flexible Coupling Kit	537630S
	2018.08-		Front;Rear	Estate 4WD 276823		Flexible Coupling Kit	537630S
E50 AMG							
5.0 (255 kw)	1996.09-1997.10		Front;Rear	Saloon RWD 119980		Flexible Coupling	512677
E500							
4.7 (300 kw)	2011.09-2015.12	AT	Front	Saloon 4WD 278922		Propshaft	PS900357
	2011.09-2015.12		Centre	Saloon 4WD 278922		Center Bearing Support	531051
	2011.09-2015.12		Front;Rear	Saloon RWD 278922		Flexible Coupling	533884
	2011.09-2015.12		Front;Rear	Saloon 4WD 278922		Flexible Coupling Kit	512677S
	2011.09-2015.12		Front;Rear	Saloon RWD 278922		Flexible Coupling Kit	537832S
	2011.09-2016.12		Centre	Estate 4WD 278922		Center Bearing Support	531051
	2011.09-2016.12		Front;Rear	Coupe RWD 278922		Flexible Coupling	533884
	2011.09-2016.12		Front;Rear	Cabriolet RWD 278922		Flexible Coupling	533884
	2011.09-2016.12		Front;Rear	Estate RWD 278922		Flexible Coupling	533884
	2011.09-2016.12		Front;Rear	Estate 4WD 278922		Flexible Coupling Kit	512677S
	2011.09-2016.12		Front;Rear	Coupe RWD 278922		Flexible Coupling Kit	537832S
	2011.09-2016.12		Front;Rear	Cabriolet RWD 278922		Flexible Coupling Kit	537832S
	2011.09-2016.12		Front;Rear	Estate RWD 278922		Flexible Coupling Kit	537832S
5.0 (225 kw)	2002.04-2005.06		Front	Saloon RWD 113967		Flexible Coupling Kit	537794S
	2002.04-2005.06		Rear	Saloon RWD 113967		Flexible Coupling Kit	537793S
	2003.05-2009.07		Front	Estate RWD 113967		Flexible Coupling Kit	537794S
	2003.05-2009.07		Rear	Estate RWD 113967		Flexible Coupling Kit	537793S
	2003.08-2006.12		Front	Saloon 4WD 113969		Flexible Coupling Kit	537794S
	2003.08-2006.12		Rear	Saloon 4WD 113969		Flexible Coupling Kit	537889S
	2003.08-2006.12		Front;Rear	Saloon 4WD 113969		Flexible Coupling Kit	512673S
	2003.08-2009.07		Front	Estate 4WD 113969		Flexible Coupling Kit	537794S
	2003.08-2009.07		Rear	Estate 4WD 113969		Flexible Coupling Kit	537889S
5.0 (235 kw)	1993.06-1995.06		Front	Saloon RWD 119974		Flexible Coupling	512676
	1993.06-1995.06		Front	Saloon RWD 119974		Flexible Coupling Kit	512671S
5.5 (285 kw)	2006.05-2008.12		Front;Rear	Saloon 4WD 273962		Flexible Coupling	533884
	2006.05-2008.12		Front;Rear	Saloon 4WD 273962		Flexible Coupling Kit	512673S
	2006.05-2008.12		Front;Rear	Saloon 4WD 273962	AT	Flexible Coupling Kit	537832S
	2006.05-2009.03		Front;Rear	Saloon RWD 273960		Flexible Coupling	533884
	2006.05-2009.03		Front;Rear	Saloon RWD 273960		Flexible Coupling Kit	537832S
	2006.05-2009.07		Front;Rear	Estate 4WD 273962		Flexible Coupling	533884
	2006.05-2009.07		Front;Rear	Estate RWD 273960		Flexible Coupling	533884



	 YEAR	TRANSM.	FITTING POSITION	BODY STYLE & DRIVE TYPE & ENGINE	REMARKS	 PRODUCT	GSP Ref.
MERCEDES-BENZ E500							
5.5 (285 kw)	2006.05-2009.07		Front;Rear	Estate 4WD 273962		Flexible Coupling Kit	512673S
	2006.05-2009.07		Front;Rear	Estate 4WD 273962	AT	Flexible Coupling Kit	537832S
	2006.05-2009.07		Front;Rear	Estate RWD 273960		Flexible Coupling Kit	537832S
	2009.01-2011.12	AT/MT	Front	Saloon 4WD 273970		Propshaft	PS900359
	2009.01-2011.12		Front;Rear	Saloon RWD 273971		Flexible Coupling	533884
	2009.01-2011.12		Front;Rear	Estate RWD 273971		Flexible Coupling	533884
	2009.01-2011.12		Front;Rear	Saloon 4WD 273970		Flexible Coupling Kit	512673S
	2009.01-2011.12		Front;Rear	Saloon RWD 273971		Flexible Coupling Kit	537832S
	2009.01-2016.12		Front;Rear	Coupe RWD 273966		Flexible Coupling	533884
	2009.01-2016.12		Front;Rear	Coupe RWD 273966		Flexible Coupling Kit	537832S
	2010.01-2011.12		Front;Rear	Cabriolet RWD 273966		Flexible Coupling	533884
2010.01-2011.12		Front;Rear	Cabriolet RWD 273966		Flexible Coupling Kit	537832S	
E55							
5.5 (260 kw)	1997.09-1998.12	AT	Rear	Saloon RWD M 113.980		Propshaft	PS900349
E55 AMG							
5.4 (260 kw)	1997.01-2002.11	AT	Rear	Saloon RWD 113980		Propshaft	PS900349
	1997.01-2002.11		Front	Saloon RWD 113980		Flexible Coupling	512676
	1997.01-2002.11		Front;Rear	Saloon RWD 113980		Flexible Coupling	512677
	1997.01-2002.11		Front	Saloon RWD 113980		Flexible Coupling Kit	512671S
	1997.11-2003.05	AT	Rear	Estate RWD 113980		Propshaft	PS900349
1997.11-2003.05		Front;Rear	Estate RWD 113980		Flexible Coupling	512677	
5.4 (350 kw)	2002.11-2006.07		Front;Rear	Saloon RWD 113990		Flexible Coupling	533884
	2002.11-2006.07		Front;Rear	Saloon RWD 113990		Flexible Coupling Kit	537832S
	2003.08-2006.12		Front;Rear	Estate RWD 113990		Flexible Coupling	533884
	2003.08-2006.12		Front;Rear	Estate RWD 113990		Flexible Coupling Kit	537832S
E550							
4.6 (300 kw)	2011.09-2015.12		Front;Rear	Saloon AWD M 278.922		Flexible Coupling Kit	512677S
E60 AMG							
6.0 (280 kw)	1994.05-1995.06		Front	Saloon RWD 119974AMG		Flexible Coupling	512676
	1994.05-1995.06		Front	Saloon RWD 119974AMG		Flexible Coupling Kit	512671S
E63 AMG							
4.0 (420 kw)	2017.01-		Front;Rear	Saloon 4WD 177980		Flexible Coupling	537851
	2017.05-		Front;Rear	Estate 4WD 177980		Flexible Coupling	537851
4.0 (450 kw)	2017.01-		Front;Rear	Saloon 4WD 177980		Flexible Coupling	537851
	2017.05-		Front;Rear	Estate 4WD 177980		Flexible Coupling	537851
5.5 (386 kw)	2011.02-2016.12		Rear	Estate RWD 157981		Flexible Coupling	537843
	2011.02-2016.12		Rear	Saloon RWD 157981		Flexible Coupling	537843
	2011.02-2016.12		Front;Rear	Estate RWD 157981		Flexible Coupling	533884
	2011.02-2016.12		Front;Rear	Saloon RWD 157981		Flexible Coupling	533884
	2011.02-2016.12		Rear	Estate RWD 157981		Flexible Coupling Kit	533884S
	2011.02-2016.12		Rear	Saloon RWD 157981		Flexible Coupling Kit	533884S
	2011.02-2016.12		Front;Rear	Estate RWD 157981		Flexible Coupling Kit	537832S
	2011.02-2016.12		Front;Rear	Saloon RWD 157981		Flexible Coupling Kit	537832S
5.5 (410 kw)	2010.10-2016.12		Rear	Estate RWD 157981		Flexible Coupling	537843
	2010.10-2016.12		Front;Rear	Estate RWD 157981		Flexible Coupling	533884
	2010.10-2016.12		Rear	Estate RWD 157981		Flexible Coupling Kit	533884S
	2010.10-2016.12		Front;Rear	Estate RWD 157981		Flexible Coupling Kit	537832S
	2011.05-2016.12		Rear	Saloon RWD 157981		Flexible Coupling	537843
	2011.05-2016.12		Front;Rear	Saloon RWD 157981		Flexible Coupling	533884
	2011.05-2016.12		Rear	Saloon RWD 157981		Flexible Coupling Kit	533884S
	2011.05-2016.12		Front;Rear	Saloon RWD 157981		Flexible Coupling Kit	537832S
	2013.01-2016.12		Rear	Estate 4WD 157981		Flexible Coupling	537843
	2013.01-2016.12		Rear	Saloon 4WD 157981		Flexible Coupling	537843
	2013.01-2016.12		Front;Rear	Estate 4WD 157981		Flexible Coupling	533884
	2013.01-2016.12		Front;Rear	Saloon 4WD 157981		Flexible Coupling	533884
	2013.01-2016.12		Front	Estate 4WD 157981		Flexible Coupling Kit	537832S
	2013.01-2016.12		Front	Saloon 4WD 157981		Flexible Coupling Kit	537832S
	2013.01-2016.12		Rear	Estate 4WD 157981		Flexible Coupling Kit	533884S
	2013.01-2016.12		Rear	Saloon 4WD 157981		Flexible Coupling Kit	533884S
5.5 (430 kw)	2013.01-2016.12		Rear	Estate 4WD 157981		Flexible Coupling	537843
	2013.01-2016.12		Rear	Saloon 4WD 157981		Flexible Coupling	537843
	2013.01-2016.12		Rear	Estate 4WD 157981		Flexible Coupling Kit	533884S
	2013.01-2016.12		Rear	Saloon 4WD 157981		Flexible Coupling Kit	533884S
	2013.06-2016.12		Rear	Estate RWD 157981		Flexible Coupling	537843



	 YEAR	TRANSM.	FITTING POSITION	BODY STYLE & DRIVE TYPE & ENGINE	REMARKS	 PRODUCT	GSP Ref.
MERCEDES-BENZ							
E63 AMG							
5.5 (430 kw)	2013.06-2016.12		Rear	Saloon RWD 157981		Flexible Coupling	537843
	2013.06-2016.12		Rear	Estate RWD 157981		Flexible Coupling Kit	533884S
	2013.06-2016.12		Rear	Saloon RWD 157981		Flexible Coupling Kit	533884S
6.2 (378 kw)	2006.08-2009.11		Front;Rear	Saloon RWD 156983		Flexible Coupling	533884
	2006.08-2009.11		Front;Rear	Estate RWD 156983		Flexible Coupling	533884
	2006.08-2009.11		Front;Rear	Saloon RWD 156983		Flexible Coupling Kit	537832S
	2006.08-2009.11		Front;Rear	Estate RWD 156983		Flexible Coupling Kit	537832S
6.2 (386 kw)	2009.12-2011.12		Front;Rear	Estate RWD 156985		Flexible Coupling	533884
	2009.12-2011.12		Front;Rear	Estate RWD 156985		Flexible Coupling Kit	537832S
	2009.12-2015.12		Front;Rear	Saloon RWD 156985		Flexible Coupling	533884
	2009.12-2015.12		Front;Rear	Saloon RWD 156985		Flexible Coupling Kit	537832S
G270							
2.7 (115 kw)	2001.10-2003.07		Front	Terrain cab wagon closed 4WD 612965		Propshaft	202072
	2001.10-2003.07		Rear	Terrain cab wagon closed 4WD 612965		Propshaft	PS900554
G300							
3.0 (125 kw)	1993.06-1997.08		-	Terrain cab wagon closed 4WD 103987		Propshaft	PS900554
3.0 (130 kw)	1996.08-2000.07		Front	Terrain cab wagon closed 4WD 606964		Propshaft	202068
	1996.08-2000.07		Rear	Terrain cab wagon closed 4WD 606964		Propshaft	PS900554
G320							
3.0 (165 kw)	2006.09-2012.12		-	Terrain cab wagon closed 4WD 642970		Propshaft	202398
	2006.09-2012.12		-	Terrain cab wagon closed 4WD 642970		Propshaft	PS900554
3.2 (155 kw)	1994.09-1997.12		Front	Terrain cab wagon closed 4WD 104996		Propshaft	202067
	1994.09-1997.12		Rear	Terrain cab wagon closed 4WD 104996		Propshaft	PS900554
3.2 (158 kw)	1997.07-2004.08		-	Terrain cab wagon closed 4WD 112945		Propshaft	PS900554
G350							
3.0 (155 kw)	2011.07-		-	Terrain cab wagon closed 4WD 642886		Propshaft	202398
	2011.07-		-	Terrain cab wagon closed 4WD 642886		Propshaft	PS900554
3.0 (165 kw)	2009.06-2015.12		-	Terrain cab wagon closed 4WD 642886		Propshaft	PS900554
3.0 (180 kw)	2015.06-		-	Terrain cab wagon closed 4WD 642887		Propshaft	PS900554
G36 AMG							
3.6 (200 kw)	1995.01-1998.07		Front	Terrain cab wagon closed 4WD 104996AMG		Propshaft	202067
	1995.01-1998.07		Rear	Terrain cab wagon closed 4WD 104996AMG		Propshaft	PS900554
G400							
4.0 (184 kw)	2000.12-2006.07		-	Terrain cab wagon closed 4WD 628962		Propshaft	PS900554
G500							
4.0 (310 kw)	2015.06-		-	Terrain cab wagon closed 4WD 176980		Propshaft	PS900554
5.0 (218 kw)	1997.04-2015.12		-	Terrain cab wagon closed 4WD 113962		Propshaft	PS900554
5.5 (285 kw)	2008.05-		-	Terrain cab wagon closed 4WD 273963		Propshaft	PS900554
G55 AMG							
5.4 (260 kw)	1999.04-2008.07		-	Terrain cab wagon closed 4WD 113982		Propshaft	PS900554
5.4 (350 kw)	2004.06-2006.07		-	Terrain cab wagon closed 4WD 113993		Propshaft	PS900554
5.4 (368 kw)	2006.08-2015.12		-	Terrain cab wagon closed 4WD 113993		Propshaft	PS900554
5.4 (373 kw)	2008.08-		-	Terrain cab wagon closed 4WD 113993		Propshaft	PS900554
G63 AMG							
5.5 (400 kw)	2012.04-		-	Terrain cab wagon closed 4WD 157984		Propshaft	PS900554
5.5 (420 kw)	2015.06-		-	Terrain cab wagon closed 4WD 157984		Propshaft	PS900554
G65 AMG							
6.0 (450 kw)	2012.04-		-	Terrain cab wagon closed 4WD 279982		Propshaft	PS900554
6.0 (463 kw)	2015.06-		-	Terrain cab wagon closed 4WD 279982		Propshaft	PS900554
GL320							
3.0 (155 kw)	2009.12-2012.08		Front	SUV 4WD 642820		Propshaft	PS900607
	2009.12-2012.08	AT	Front	SUV 4WD 642820		Propshaft	201958
	2009.12-2012.08		Rear	SUV 4WD 642820		Flexible Coupling Kit	537792S
3.0 (165 kw)	2006.09-2009.05		Front	SUV 4WD 642940		Propshaft	PS900607
	2006.09-2009.05	AT	Front	SUV 4WD 642940		Propshaft	201958
	2006.09-2009.05		Rear	SUV 4WD 642940		Flexible Coupling Kit	537792S
GL350							
3.0 (155 kw)	2009.06-2012.08		Front	SUV 4WD 642820		Propshaft	PS900607
	2009.06-2012.08	AT	Front	SUV 4WD 642820		Propshaft	201958
	2009.06-2012.08		Rear	SUV 4WD 642820		Flexible Coupling Kit	537792S
3.0 (165 kw)	2009.06-2012.08	AT	Front	SUV 4WD 642940		Propshaft	201958
	2009.06-2012.08		Rear	SUV 4WD 642940		Flexible Coupling Kit	537792S
3.0 (179 kw)	2013.01-2015.10		Front;Rear	SUV 4WD 642826		Flexible Coupling Kit	537630S



	 YEAR	TRANSM.	FITTING POSITION	BODY STYLE & DRIVE TYPE & ENGINE	REMARKS	 PRODUCT	GSP Ref.
MERCEDES-BENZ GL350							
3.0 (183 kw)	2012.07-2015.10		Front;Rear	SUV 4WD 642826		Flexible Coupling	512677
	2012.07-2015.10		Front;Rear	SUV 4WD 642826		Flexible Coupling Kit	537630S
3.0 (190 kw)	2012.07-2015.10	AT	Front	SUV 4WD 642826		Propshaft	PS900586
	2012.07-2015.10		Front;Rear	SUV 4WD 642826		Flexible Coupling	512677
	2012.07-2015.10		Front;Rear	SUV 4WD 642826		Flexible Coupling Kit	537630S
3.0 (195 kw)	2010.10-2012.08	AT	Front	SUV 4WD 642822		Propshaft	201958
	2010.10-2012.08		Rear	SUV 4WD 642822		Flexible Coupling Kit	537792S
GL400							
3.0 (245 kw)	2013.08-2015.10		Rear	SUV 4WD 276821		Flexible Coupling	537630
	2013.08-2015.10		Front;Rear	SUV 4WD 276821		Flexible Coupling	512677
GL420							
4.0 (225 kw)	2006.01-2010.12	AT	Front	SUV 4WD 629912		Propshaft	201958
	2006.01-2010.12		Rear	SUV 4WD 629912		Flexible Coupling Kit	537792S
GL450							
3.0 (270 kw)	2015.01-2015.10		Front;Rear	SUV 4WD 276821		Flexible Coupling Kit	537630S
4.0 (225 kw)	2009.06-2012.08	AT	Front	SUV 4WD 629912		Propshaft	201958
	2009.06-2012.08		Rear	SUV 4WD 629912		Flexible Coupling Kit	537792S
4.7 (250 kw)	2006.01-2012.08		Front	SUV 4WD 273923		Propshaft	PS900607
	2006.01-2012.08	AT	Front	SUV 4WD 273923		Propshaft	201958
	2006.01-2012.08		Rear	SUV 4WD 273923		Flexible Coupling Kit	537792S
4.7 (270 kw)	2012.07-2015.10		Rear	SUV 4WD 278928		Flexible Coupling	537630
	2012.07-2015.10		Front;Rear	SUV 4WD 278928		Flexible Coupling Kit	537630S
GL500							
4.0 (310 kw)	2015.04-2015.12		Rear	SUV 4WD 278912		Flexible Coupling	537630
4.7 (300 kw)	2014.07-2015.10		Front;Rear	SUV 4WD 278928		Flexible Coupling	512677
	2014.07-2015.10		Front;Rear	SUV 4WD 278928		Flexible Coupling Kit	537630S
4.7 (320 kw)	2012.07-2015.10		Rear	SUV 4WD 278928		Flexible Coupling	537630
	2012.07-2015.10		Front;Rear	SUV 4WD 278928		Flexible Coupling	512677
	2012.07-2015.10		Front;Rear	SUV 4WD 278928		Flexible Coupling Kit	537630S
5.5 (285 kw)	2006.01-2012.08		Front	SUV 4WD 273963		Propshaft	PS900607
	2006.01-2012.08	AT	Front	SUV 4WD 273963		Propshaft	201958
	2006.01-2012.08		Rear	SUV 4WD 273963		Flexible Coupling Kit	537792S
GL550							
5.5 (285 kw)	2006.07-2011.12		Front	SUV 4WD 273963		Propshaft	PS900607
	2006.07-2011.12	AT	Front	SUV 4WD 273963		Propshaft	201958
	2006.07-2011.12		Rear	SUV 4WD 273963		Flexible Coupling Kit	537792S
GLC200							
2.0 (120 kw)	2019.04-		Rear	SUV 4WD 654920		Flexible Coupling	537847
	2019.04-		Front;Rear	SUV RWD 654920		Flexible Coupling Kit	537630S
	2019.04-		Front;Rear	SUV 4WD 654920		Flexible Coupling Kit	537630S
2.0 (135 kw)	2016.06-2019.04		Rear	SUV 4WD 274920		Flexible Coupling	537847
	2016.06-2019.04		Front;Rear	SUV RWD 274920		Flexible Coupling Kit	537627S
	2016.11-2019.04		Rear	SUV 4WD 274920		Flexible Coupling	537847
2.0 (145 kw)	2019.04-		Rear	SUV 4WD 264920		Flexible Coupling	537847
	2019.04-		Front;Rear	SUV 4WD 264920		Flexible Coupling	537627
	2019.04-		Front;Rear	SUV RWD 264920		Flexible Coupling	537627
	2019.04-		Front;Rear	SUV 4WD 264920		Flexible Coupling Kit	537627S
	2019.04-		Front;Rear	SUV RWD 264920		Flexible Coupling Kit	537627S
GLC220							
2.0 (143 kw)	2019.04-		Rear	SUV 4WD 654920		Flexible Coupling	537847
	2019.04-		Front;Rear	SUV RWD 654920		Flexible Coupling Kit	537630S
2.2 (120 kw)	2015.06-2019.04		Rear	SUV 4WD 651921		Flexible Coupling	537847
	2015.06-2019.04		Front;Rear	SUV 4WD 651921		Flexible Coupling	537627
	2015.06-2019.04		Front;Rear	SUV 4WD 651921		Flexible Coupling Kit	537627S
	2016.06-2019.04		Rear	SUV 4WD 651921		Flexible Coupling	537847
	2016.06-2019.04		Front;Rear	SUV 4WD 651921		Flexible Coupling	537627
	2016.06-2019.04		Front;Rear	SUV 4WD 651921		Flexible Coupling Kit	537627S
2.2 (125 kw)	2015.06-2019.04		Rear	SUV 4WD 651921		Flexible Coupling	537847
	2015.06-2019.04		Front;Rear	SUV 4WD 651921		Flexible Coupling	537627
	2015.06-2019.04		Front;Rear	SUV 4WD 651921		Flexible Coupling Kit	537627S
	2016.06-2019.04		Rear	SUV 4WD 651921		Flexible Coupling	537847
	2016.06-2019.04		Front;Rear	SUV 4WD 651921		Flexible Coupling	537627
	2016.06-2019.04		Front;Rear	SUV 4WD 651921		Flexible Coupling Kit	537627S



	 YEAR	TRANSM.	FITTING POSITION	BODY STYLE & DRIVE TYPE & ENGINE	REMARKS	 PRODUCT	GSP Ref.
MERCEDES-BENZ							
GLC250							
2.0 (155 kw)	2015.06-2019.04	AT	Rear	SUV 4WD 274920		Propshaft	PS900593
	2015.06-2019.04		Rear	SUV 4WD 274920		Flexible Coupling	537847
	2015.06-2019.04		Rear	SUV 4WD 274920CNG		Flexible Coupling	537847
	2016.06-2019.04	AT	Rear	SUV 4WD 274920		Propshaft	PS900593
	2016.06-2019.04		Rear	SUV 4WD 274920		Flexible Coupling	537847
2.2 (150 kw)	2015.06-2019.04		Rear	SUV 4WD 651921	for right-hand drive vehicles,9AT	Flexible Coupling	537630
	2015.06-2019.04		Rear	SUV 4WD 651921	for left-hand drive vehicles	Flexible Coupling	537847
	2015.06-2019.04		Front;Rear	SUV 4WD 651921		Flexible Coupling	537627
	2015.06-2019.04		Front;Rear	SUV 4WD 651921		Flexible Coupling Kit	537627S
	2016.06-2019.04		Rear	SUV 4WD 651921	for right-hand drive vehicles,9AT	Flexible Coupling	537630
	2016.06-2019.04		Rear	SUV 4WD 651921	for left-hand drive vehicles	Flexible Coupling	537847
	2016.06-2019.04		Front;Rear	SUV 4WD 651921		Flexible Coupling Kit	537630S
	2016.06-2019.04		Front;Rear	SUV 4WD 651921		Flexible Coupling Kit	537630S
GLC260							
2.0 (145 kw)	2019.11-		Rear	SUV 4WD 264920		Flexible Coupling	537847
	2019.11-		Front;Rear	SUV 4WD 264920		Flexible Coupling Kit	537627S
GLC300							
2.0 (143 kw)	2020.05-		Rear	SUV 4WD 654920		Flexible Coupling	537847
2.0 (155 kw)	2019.11-		Rear	SUV 4WD 274920		Flexible Coupling	537847
2.0 (177 kw)	2015.07-2019.04		Rear	SUV 4WD 274920		Flexible Coupling	537847
2.0 (180 kw)	2015.07-2019.04		Rear	SUV 4WD 274920		Flexible Coupling	537847
	2016.01-2019.04		Rear	SUV RWD 274920		Flexible Coupling	537630
	2016.01-2019.04		Front;Rear	SUV RWD 274920		Flexible Coupling Kit	537630S
	2016.06-2019.04		Rear	SUV 4WD 274920		Flexible Coupling	537847
	2019.04-		Rear	SUV 4WD 654920		Flexible Coupling	537847
	2019.04-		Front;Rear	SUV 4WD 654920		Flexible Coupling Kit	537630S
	2019.04-		Front;Rear	SUV 4WD 654920		Flexible Coupling Kit	537630S
2.0 (190 kw)	2019.04-		Rear	SUV 4WD 264920		Flexible Coupling	537847
	2019.04-		Front;Rear	SUV 4WD 264920		Flexible Coupling	537627
	2019.04-		Front;Rear	SUV 4WD 264920		Flexible Coupling Kit	537627S
	2019.11-		Rear	SUV 4WD 264920		Flexible Coupling	537847
	2019.11-		Front;Rear	SUV 4WD 264920		Flexible Coupling	537627
	2019.11-		Front;Rear	SUV 4WD 264920		Flexible Coupling Kit	537627S
GLC350							
2.0 (155 kw)	2016.01-2019.04		Rear	SUV 4WD 274920		Flexible Coupling	537847
	2016.10-2019.04		Rear	SUV 4WD 274920		Flexible Coupling	537847
GLC400							
2.9 (243 kw)	2019.08-		Front;Rear	SUV 4WD 656929		Flexible Coupling Kit	537630S
GLC43 AMG							
3.0 (270 kw)	2015.07-2019.08		Front;Rear	SUV 4WD 276823		Flexible Coupling	537627
	2015.07-2019.08		Front;Rear	SUV 4WD 276823		Flexible Coupling Kit	537627S
	2016.10-2019.08		Front;Rear	SUV 4WD 276823		Flexible Coupling	537627
	2016.10-2019.08		Front;Rear	SUV 4WD 276823		Flexible Coupling Kit	537627S
3.0 (287 kw)	2019.08-		Front;Rear	SUV 4WD 276823		Flexible Coupling	537627
	2019.08-		Front;Rear	SUV 4WD 276823		Flexible Coupling Kit	537627S
GLC63 AMG							
4.0 (350 kw)	2017.06-		Rear	SUV 4WD 177980		Flexible Coupling	537851
4.0 (375 kw)	2017.06-		Rear	SUV 4WD 177980		Flexible Coupling	537851
GLE250							
2.2 (150 kw)	2015.04-2018.10		Front;Rear	SUV 4WD 651960		Flexible Coupling	512677
	2015.04-2018.10		Front;Rear	SUV RWD 651960		Flexible Coupling	512677
	2015.04-2018.10		Front;Rear	SUV 4WD 651960		Flexible Coupling Kit	512673S
	2015.04-2018.10		Front;Rear	SUV RWD 651960		Flexible Coupling Kit	512673S
GLE320							
3.0 (200 kw)	2015.09-2019.10		Front	SUV 4WD 276821		Flexible Coupling	537630
	2015.09-2019.10		Front;Rear	SUV 4WD 276821		Flexible Coupling Kit	537630S
	2015.10-2018.10		Front;Rear	SUV 4WD 276821		Flexible Coupling	512677
	2015.10-2018.10		Front;Rear	SUV 4WD 276821		Flexible Coupling Kit	512673S
GLE350							
2.0 (143 kw)	2019.11-		Front	SUV 4WD 654920		Flexible Coupling	537851
	2020.03-		Front	SUV 4WD 654920		Flexible Coupling	537851
2.0 (155 kw)	2020.06-		Front	SUV 4WD 274920		Flexible Coupling	537851
2.9 (200 kw)	2018.12-2021.06		Front	SUV 4WD 656929		Flexible Coupling	537851
	2019.11-		Front	SUV 4WD 656929		Flexible Coupling	537851
3.0 (190 kw)	2015.04-2018.10	AT	Front	SUV 4WD 642826		Propshaft	PS900586
	2015.04-2018.10		Front;Rear	SUV 4WD 642826		Flexible Coupling	512677



	 YEAR	TRANSM.	FITTING POSITION	BODY STYLE & DRIVE TYPE & ENGINE	REMARKS	 PRODUCT	GSP Ref.
MERCEDES-BENZ							
GLE350							
3.5 (225 kw)	2016.01-2018.10		Front;Rear	SUV 4WD 276955		Flexible Coupling Kit	512673S
GLE400							
2.9 (243 kw)	2018.12-		Front	SUV 4WD 656929		Flexible Coupling	537851
	2019.11-		Front	SUV 4WD 656929		Flexible Coupling	537851
3.0 (245 kw)	2015.03-2019.10		Front	SUV 4WD 276821/276825		Flexible Coupling	537630
	2015.03-2019.10		Front;Rear	SUV 4WD 276821/276825		Flexible Coupling	537627
	2015.03-2019.10		Front;Rear	SUV 4WD 276821/276825		Flexible Coupling Kit	537630S
	2015.04-2018.10		Front;Rear	SUV 4WD 276821/276825		Flexible Coupling	512677
GLE43 AMG							
3.0 (270 kw)	2016.05-2018.10		Front	SUV 4WD 276821		Flexible Coupling	537630
	2016.05-2018.10		Front;Rear	SUV 4WD 276821		Flexible Coupling	512677
	2016.05-2018.10		Front;Rear	SUV 4WD 276821		Flexible Coupling Kit	537630S
	2016.05-2019.10		Front;Rear	SUV 4WD 276821		Flexible Coupling Kit	537630S
3.0 (287 kw)	2017.06-2018.10		Front	SUV 4WD 276821		Flexible Coupling	537630
	2017.06-2018.10		Front;Rear	SUV 4WD 276821		Flexible Coupling Kit	537630S
	2017.06-2019.10		Front;Rear	SUV 4WD 276821		Flexible Coupling Kit	537630S
GLE450 AMG							
3.0 (270 kw)	2015.03-2019.10		Front	SUV 4WD 276821		Propshaft	PS900606
	2015.03-2019.10		Front	SUV 4WD 276821		Flexible Coupling	537630
	2015.03-2019.10		Front;Rear	SUV 4WD 276821		Flexible Coupling Kit	537630S
	2015.10-2018.10		Front;Rear	SUV 4WD 276821		Flexible Coupling	512677
	2015.10-2018.10		Front;Rear	SUV 4WD 276821		Flexible Coupling Kit	537630S
GLE500							
3.0 (245 kw)	2015.04-2018.10		Front;Rear	SUV 4WD 276821		Flexible Coupling	512677
4.0 (310 kw)	2016.12-2019.10		Front	SUV 4WD 278912		Flexible Coupling	537630
	2016.12-2019.10		Front;Rear	SUV 4WD 278912		Flexible Coupling Kit	537630S
4.7 (320 kw)	2015.04-2018.10	AT	Front	SUV 4WD 278928		Propshaft	PS900345
	2015.04-2018.10		Rear	SUV 4WD 278928		Flexible Coupling	537630
	2015.04-2018.10		Front;Rear	SUV 4WD 278928		Flexible Coupling	512677
4.7 (335 kw)	2015.10-2018.10	AT	Front	SUV 4WD 278928		Propshaft	PS900345
	2015.10-2018.10		Rear	SUV 4WD 278928		Flexible Coupling	537630
	2015.10-2018.10		Front;Rear	SUV 4WD 278928		Flexible Coupling	512677
	2015.10-2019.10		Front	SUV 4WD 278928		Flexible Coupling	537630
	2015.10-2019.10		Front;Rear	SUV 4WD 278928		Flexible Coupling Kit	537630S
GLE53 AMG							
3.0 (320 kw)	2019.04-		Front	SUV 4WD 256930		Flexible Coupling	537851
GLE580							
4.0 (360 kw)	2019.11-		Front	SUV 4WD 176980		Flexible Coupling	537851
GLK200							
2.0 (135 kw)	2013.08-2015.12		Front;Rear	SUV RWD 274920		Flexible Coupling Kit	512673S
2.2 (100 kw)	2013.12-2015.06		Front;Rear	SUV RWD 651916		Flexible Coupling Kit	512677S
2.2 (105 kw)	2010.07-2015.06		Front;Rear	SUV RWD 651913/651916		Flexible Coupling Kit	512677S
GLK220							
2.2 (120 kw)	2008.06-2015.06		Front;Rear	SUV 4WD 651912		Flexible Coupling Kit	512673S
	2008.06-2015.06		Front;Rear	SUV RWD 651916		Flexible Coupling Kit	512677S
2.2 (125 kw)	2008.06-2015.06		Front;Rear	SUV 4WD 651912		Flexible Coupling Kit	512673S
	2008.06-2015.06		Front;Rear	SUV RWD 651916		Flexible Coupling Kit	512677S
GLK250							
2.0 (155 kw)	2013.04-2015.06		Front;Rear	SUV 4WD 274920		Flexible Coupling Kit	512673S
	2013.08-2015.06		Front;Rear	SUV RWD 274920		Flexible Coupling Kit	512673S
2.2 (149 kw)	2012.09-2015.06		Front;Rear	SUV AWD OM 651.912		Flexible Coupling Kit	512673S
2.2 (150 kw)	2009.09-2015.06		Front;Rear	SUV 4WD 651912		Flexible Coupling	512678
	2009.09-2015.06		Front;Rear	SUV 4WD 651912		Flexible Coupling Kit	512673S
GLK280							
3.0 (170 kw)	2008.06-2013.12	AT/MT	Front	SUV 4WD 272948		Propshaft	PS900359
	2008.06-2013.12		Front;Rear	SUV 4WD 272948		Flexible Coupling	512678
	2008.06-2013.12		Front;Rear	SUV 4WD 272948		Flexible Coupling Kit	512673S
GLK300							
3.0 (170 kw)	2008.11-2015.12	AT/MT	Front	SUV 4WD 272948		Propshaft	PS900359
	2008.11-2015.12		Front;Rear	SUV 4WD 272948		Flexible Coupling Kit	512673S
3.5 (182 kw)	2009.09-2015.12		Front;Rear	SUV 4WD 276957		Flexible Coupling Kit	512673S
3.5 (185 kw)	2009.09-2015.06		Front;Rear	SUV 4WD 276957		Flexible Coupling Kit	512673S



	 YEAR	TRANSM.	FITTING POSITION	BODY STYLE & DRIVE TYPE & ENGINE	REMARKS	 PRODUCT	GSP Ref.
MERCEDES-BENZ GLK320							
3.0 (165 kw)	2008.06-2015.06		Front;Rear	SUV 4WD 642961		Flexible Coupling	512678
	2008.06-2015.06		Front;Rear	SUV 4WD 642961		Flexible Coupling Kit	512673S
GLK350							
3.0 (165 kw)	2009.07-2010.01		Front;Rear	SUV 4WD 642832		Flexible Coupling Kit	512673S
3.0 (170 kw)	2010.02-2015.06		Front;Rear	SUV 4WD 642832		Flexible Coupling Kit	512673S
3.0 (195 kw)	2012.07-2015.06		Front;Rear	SUV 4WD 642835		Flexible Coupling Kit	512677S
3.5 (200 kw)	2008.06-2011.04		Front;Rear	SUV 4WD 272971		Flexible Coupling	512678
	2008.06-2011.04		Front;Rear	SUV 4WD 272971		Flexible Coupling Kit	512673S
	2009.04-2015.06		Front;Rear	SUV RWD 272991		Flexible Coupling Kit	512677S
3.5 (225 kw)	2008.06-2015.06	AT/MT	Front	SUV 4WD 276957		Propshaft	PS900359
	2008.06-2015.06		Front;Rear	SUV 4WD 276957		Flexible Coupling Kit	512673S
	2013.01-2015.06		Front;Rear	SUV RWD 276957		Flexible Coupling Kit	512673S
	2013.01-2015.06		Front;Rear	SUV RWD 276957		Flexible Coupling Kit	512677S
GLS350							
2.9 (210 kw)	2019.04-		Rear	SUV 4WD 656929		Flexible Coupling	537851
3.0 (183 kw)	2017.01-2019.04		Front;Rear	SUV 4WD 642826		Flexible Coupling Kit	537630S
3.0 (190 kw)	2015.11-2019.04	AT	Front	SUV 4WD 642826		Propshaft	PS900586
	2015.11-2019.04		Front;Rear	SUV 4WD 642826		Flexible Coupling	512677
	2015.11-2019.04		Front;Rear	SUV 4WD 642826		Flexible Coupling Kit	537630S
GLS400							
2.9 (243 kw)	2019.04-		Rear	SUV 4WD 656929		Flexible Coupling	537851
3.0 (245 kw)	2015.11-2019.04		Front;Rear	SUV 4WD 276821		Flexible Coupling	512677
GLS450							
3.0 (270 kw)	2016.06-2019.04		Front;Rear	SUV 4WD 276821		Flexible Coupling Kit	537630S
GLS500							
4.0 (310 kw)	2016.03-2019.04		Front	SUV 4WD 278912		Propshaft	PS900606
	2016.03-2019.04		Front;Rear	SUV 4WD 278912		Flexible Coupling Kit	537630S
4.7 (335 kw)	2015.11-2019.04		Front	SUV 4WD 278928		Propshaft	PS900345
	2015.11-2019.04		Front;Rear	SUV 4WD 278928		Flexible Coupling	512677
	2015.11-2019.04		Front;Rear	SUV 4WD 278928		Flexible Coupling Kit	537630S
GLS580							
4.0 (360 kw)	2019.11-		Rear	SUV 4WD 176980		Flexible Coupling	537851
ML230							
2.3 (110 kw)	1998.04-2000.08	MT	Front	SUV 4WD 111977	Date To:2000.09	Propshaft	PS900353
	1998.04-2000.08		Centre	SUV 4WD 111977		Center Bearing Support	511573
	1998.04-2000.08		Centre	SUV 4WD 111977		Center Bearing Support Kit	530473
ML250							
2.2 (150 kw)	2011.06-2015.02		Front;Rear	SUV 4WD 651960		Flexible Coupling	512677
	2011.06-2015.02		Rear	SUV 4WD 651960		Flexible Coupling Kit	537792S
	2011.06-2015.02		Front;Rear	SUV 4WD 651960		Flexible Coupling Kit	512673S
ML270							
2.7 (120 kw)	1999.06-2005.07	AT	Front	SUV 4WD 612963		Propshaft	PS900354
	1999.06-2005.07	MT	Front	SUV 4WD 612963		Propshaft	PS900355
	1999.06-2005.07		Centre	SUV 4WD 612963		Center Bearing Support	511573
	1999.06-2005.07		Centre	SUV 4WD 612963		Center Bearing Support Kit	530473
ML280							
3.0 (140 kw)	2005.07-2009.07	AT	Front	SUV 4WD 642940		Propshaft	201958
	2005.07-2009.07		Rear	SUV 4WD 642940		Flexible Coupling Kit	537792S
ML300							
3.0 (140 kw)	2009.06-2011.12	AT	Front	SUV 4WD 642940		Propshaft	201958
	2009.06-2011.12		Rear	SUV 4WD 642940		Flexible Coupling Kit	537792S
3.0 (150 kw)	2009.06-2011.12	AT	Front	SUV 4WD 642820		Propshaft	201958
	2009.06-2011.12		Front	SUV 4WD 642820		Flexible Coupling Kit	510578S
	2009.06-2011.12		Rear	SUV 4WD 642820		Flexible Coupling Kit	537792S
3.0 (170 kw)	2008.08-2011.12		Rear	SUV 4WD 272945		Flexible Coupling Kit	537792S
3.5 (183 kw)	2012.08-2015.02		Front;Rear	SUV 4WD 276955		Flexible Coupling Kit	512673S
3.5 (185 kw)	2012.08-2015.02		Front;Rear	SUV 4WD 276955		Flexible Coupling Kit	512673S
ML320							
3.0 (155 kw)	2005.07-2011.07		Front	SUV 4WD 642820/642940		Propshaft	PS900607
3.0 (165 kw)	2005.07-2011.07		Front	SUV 4WD 642940		Propshaft	PS900607
	2005.07-2011.07	AT	Front	SUV 4WD 642940		Propshaft	201958
	2005.07-2011.07	AT	Rear	SUV 4WD 642940		Propshaft	PS900363
	2005.07-2011.07		Rear	SUV 4WD 642940		Flexible Coupling Kit	537792S

	 YEAR	TRANSM.	FITTING POSITION	BODY STYLE & DRIVE TYPE & ENGINE	REMARKS	 PRODUCT	GSP Ref.
MERCEDES-BENZ ML320							
3.0 (200 kw)	2013.11-2015.02		Front;Rear	SUV 4WD 276821		Flexible Coupling Kit	512673S
3.2 (160 kw)	1998.02-2003.04	AT	Front	SUV 4WD 112942		Propshaft	PS900352
	1998.02-2003.04		Centre	SUV 4WD 112942		Center Bearing Support	511573
	1998.02-2003.04		Centre	SUV 4WD 112942		Center Bearing Support Kit	530473
ML350							
3.0 (155 kw)	2009.09-2012.06	AT	Front	SUV 4WD 642820		Propshaft	201958
	2009.09-2012.06		Rear	SUV 4WD 642820		Flexible Coupling Kit	537792S
3.0 (165 kw)	2009.06-2012.11	AT	Front	SUV 4WD 642940		Propshaft	201958
	2009.06-2012.11		Rear	SUV 4WD 642940		Flexible Coupling Kit	537792S
3.0 (170 kw)	2009.06-2011.12	AT	Front	SUV 4WD 642820		Propshaft	201958
	2009.06-2011.12		Rear	SUV 4WD 642820		Flexible Coupling Kit	537792S
3.0 (190 kw)	2011.06-2015.02	AT	Front	SUV 4WD 642826		Propshaft	PS900586
	2011.06-2015.02		Front;Rear	SUV 4WD 642826		Flexible Coupling	512677
	2011.06-2015.02		Rear	SUV 4WD 642826		Flexible Coupling Kit	537792S
3.5 (200 kw)	2005.02-2011.12		Front	SUV 4WD 272967		Propshaft	PS900607
	2005.02-2011.12	AT	Front	SUV 4WD 272967		Propshaft	201958
	2005.02-2011.12		Rear	SUV 4WD 272967		Flexible Coupling Kit	537792S
	2009.01-2009.12		Rear	SUV RWD 272967		Flexible Coupling Kit	537792S
3.5 (225 kw)	2011.06-2015.02		Rear	SUV 4WD 276955		Flexible Coupling Kit	537792S
	2011.06-2015.02		Front;Rear	SUV 4WD 276955		Flexible Coupling Kit	512673S
3.7 (173 kw)	2003.01-2005.12	AT	Front	SUV 4WD 112970		Propshaft	PS900352
	2003.01-2005.12		Centre	SUV 4WD 112970		Center Bearing Support	511573
	2003.01-2005.12		Centre	SUV 4WD 112970		Center Bearing Support Kit	530473
3.7 (180 kw)	2002.08-2003.07	AT	Front	SUV 4WD 112970		Propshaft	PS900352
	2002.08-2003.07		Centre	SUV 4WD 112970		Center Bearing Support	511573
	2002.08-2003.07		Centre	SUV 4WD 112970		Center Bearing Support Kit	530473
ML400							
3.0 (245 kw)	2013.08-2015.02		Front;Rear	SUV 4WD 276821/276825		Flexible Coupling	512677
4.0 (184 kw)	2001.09-2005.07	AT	Front	SUV 4WD 628963		Propshaft	PS900354
	2001.09-2005.07		Centre	SUV 4WD 628963		Center Bearing Support	511573
	2001.09-2005.07		Centre	SUV 4WD 628963		Center Bearing Support Kit	530473
ML420							
4.0 (225 kw)	2006.02-2009.09	AT	Front	SUV 4WD 629912		Propshaft	201958
	2006.02-2009.09		Rear	SUV 4WD 629912		Flexible Coupling Kit	537792S
ML430							
4.3 (200 kw)	1998.11-2002.08	AT	Front	SUV 4WD 113942		Propshaft	PS900354
	1998.11-2002.08		Centre	SUV 4WD 113942		Center Bearing Support	511573
	1998.11-2002.08		Centre	SUV 4WD 113942		Center Bearing Support Kit	530473
ML450							
4.0 (225 kw)	2009.06-2011.12	AT	Front	SUV 4WD 629912		Propshaft	201958
	2009.06-2011.12		Rear	SUV 4WD 629912		Flexible Coupling Kit	537792S
ML500							
4.7 (300 kw)	2012.02-2015.02		Rear	SUV 4WD 278928		Flexible Coupling	537630
	2012.02-2015.02		Front;Rear	SUV 4WD 278928		Flexible Coupling	512677
	2012.02-2015.02		Rear	SUV 4WD 278928		Flexible Coupling Kit	537792S
5.0 (215 kw)	2001.09-2005.06	AT	Front	SUV 4WD 113965		Propshaft	PS900354
	2001.09-2005.06		Centre	SUV 4WD 113965		Center Bearing Support	511573
	2001.09-2005.06		Centre	SUV 4WD 113965		Center Bearing Support Kit	530473
5.0 (225 kw)	2005.08-2007.12		Front	SUV 4WD 113964		Propshaft	PS900607
	2005.08-2007.12	AT	Front	SUV 4WD 113964		Propshaft	201958
	2005.08-2007.12		Rear	SUV 4WD 113964		Flexible Coupling Kit	537792S
5.5 (285 kw)	2007.04-2012.06	AT	Front	SUV 4WD 273963		Propshaft	201958
	2007.04-2012.06		Rear	SUV 4WD 273963		Flexible Coupling Kit	537792S
ML55 AMG							
5.4 (255 kw)	1999.06-2005.07	AT	Front	SUV 4WD 113981		Propshaft	PS900354
	1999.06-2005.07		Centre	SUV 4WD 113981		Center Bearing Support	511573
	1999.06-2005.07		Centre	SUV 4WD 113981		Center Bearing Support Kit	530473
ML550							
4.7 (300 kw)	2012.01-2015.02		Rear	SUV 4WD 278928		Flexible Coupling	537630
	2012.01-2015.02		Front;Rear	SUV 4WD 278928		Flexible Coupling	512677
	2012.01-2015.02		Rear	SUV 4WD 278928		Flexible Coupling Kit	537792S
ML63 AMG							
5.5 (386 kw)	2011.11-2015.02		Rear	SUV 4WD 157982		Flexible Coupling Kit	537792S

	 YEAR	TRANSM.	FITTING POSITION	BODY STYLE & DRIVE TYPE & ENGINE	REMARKS	 PRODUCT	GSP Ref.
MERCEDES-BENZ ML63 AMG							
5.5 (410 kw)	2011.11-2015.02		Rear	SUV 4WD 157982		Flexible Coupling Kit	537792S
6.2 (375 kw)	2005.12-2011.12		Front	SUV 4WD 156980		Propshaft	PS900607
	2005.12-2011.12	AT	Front	SUV 4WD 156980		Propshaft	201958
	2005.12-2011.12		Rear	SUV 4WD 156980		Flexible Coupling Kit	537792S
R280							
3.0 (140 kw)	2006.05-2012.12		Front	MPV RWD 642870/642950		Flexible Coupling Kit	510578S
	2006.05-2012.12		Rear	MPV 4WD 642950		Flexible Coupling Kit	537792S
	2006.05-2012.12		Rear	MPV RWD 642870/642950		Flexible Coupling Kit	537792S
3.0 (170 kw)	2006.06-2014.12		Rear	MPV RWD 272945		Flexible Coupling Kit	537792S
	2007.05-2011.12		Rear	MPV 4WD 272945		Flexible Coupling Kit	537792S
R300							
3.0 (140 kw)	2009.07-2012.12		Front	MPV RWD 642870/642872/642950		Flexible Coupling Kit	510578S
	2009.07-2012.12		Rear	MPV 4WD 642950		Flexible Coupling Kit	537792S
	2009.07-2012.12		Rear	MPV RWD 642870/642872/642950		Flexible Coupling Kit	537792S
3.0 (170 kw)	2009.07-2011.12		Rear	MPV 4WD 272945		Flexible Coupling Kit	537792S
	2009.07-2014.12		Rear	MPV RWD 272945		Flexible Coupling Kit	537792S
R320							
3.0 (165 kw)	2006.01-2010.07		Rear	MPV 4WD 642870/642950		Flexible Coupling Kit	537792S
R350							
3.0 (155 kw)	2006.01-2014.12		Rear	MPV 4WD 642870		Flexible Coupling Kit	537792S
3.0 (165 kw)	2009.07-2012.12		Rear	MPV 4WD 642950		Flexible Coupling Kit	537792S
3.0 (195 kw)	2010.01-2014.12		Rear	MPV 4WD 642872		Flexible Coupling Kit	537792S
3.5 (200 kw)	2005.08-2012.12		Rear	MPV 4WD 272967		Flexible Coupling Kit	537792S
	2007.01-2012.12		Rear	MPV RWD 272967		Flexible Coupling Kit	537792S
3.5 (225 kw)	2011.10-2014.12		Rear	MPV 4WD 276958		Flexible Coupling Kit	537792S
R500							
5.0 (225 kw)	2005.08-2014.12		Rear	MPV 4WD 113971		Flexible Coupling Kit	537792S
5.5 (285 kw)	2007.05-2014.12		Rear	MPV 4WD 273963		Flexible Coupling Kit	537792S
R63 AMG							
6.2 (375 kw)	2006.02-2010.12		Rear	MPV 4WD 156980		Flexible Coupling Kit	537792S
S280							
2.8 (142 kw)	1993.06-1999.01		Front	Saloon RWD 104944		Flexible Coupling	510571
	1993.06-1999.01		Front;Rear	Saloon RWD 104944		Flexible Coupling	510579
	1993.06-1999.01		Front	Saloon RWD 104944		Flexible Coupling Kit	510571S
	1993.06-1999.01		Front	Saloon RWD 104944		Flexible Coupling Kit	510580S
2.8 (150 kw)	1999.02-2005.08		Front	Saloon RWD 112922		Flexible Coupling	510571
	1999.02-2005.08		Front;Rear	Saloon RWD 112922		Flexible Coupling	512678
	1999.02-2005.08		Front	Saloon RWD 112922		Flexible Coupling Kit	510571S
	1999.02-2005.08		Front;Rear	Saloon RWD 112922		Flexible Coupling Kit	512673S
3.0 (170 kw)	2006.08-2013.07		Front;Rear	Saloon RWD 272946		Flexible Coupling Kit	512673S
S300							
3.0 (130 kw)	1996.09-1998.08		Front;Rear	Saloon RWD 606961		Flexible Coupling	512677
	1996.09-1998.08		Rear	Saloon RWD 606961		Flexible Coupling Kit	512672S
3.0 (170 kw)	2006.01-2013.07		Front;Rear	Saloon RWD 272946		Flexible Coupling Kit	512673S
3.0 (180 kw)	2012.06-2013.07		Front;Rear	Saloon RWD 272946		Flexible Coupling Kit	512673S
S320							
2.0 (220 kw)	2018.08-		Front;Rear	Saloon RWD 264920		Flexible Coupling Kit	537630S
3.0 (155 kw)	2005.10-2012.12		Front;Rear	Saloon RWD 642930		Flexible Coupling	533884
	2005.10-2012.12		Front;Rear	Saloon RWD 642930		Flexible Coupling Kit	537832S
	2006.06-2010.12		Front;Rear	Saloon 4WD 642932		Flexible Coupling Kit	512673S
3.0 (173 kw)	2005.12-2009.06		Centre	Saloon RWD 642930		Center Bearing Support	533842
	2005.12-2009.06		Front;Rear	Saloon RWD 642930		Flexible Coupling	533884
	2005.12-2009.06		Front;Rear	Saloon RWD 642930		Flexible Coupling Kit	537832S
	2006.06-2012.12		Front;Rear	Saloon 4WD 642932		Flexible Coupling Kit	512673S
3.0 (200 kw)	2014.05-		Centre	Saloon RWD 276824		Center Bearing Support	537766
	2014.05-		Front	Saloon RWD 276824		Flexible Coupling	512672
	2014.05-		Rear	Saloon RWD 276824		Flexible Coupling	537630
	2014.05-		Front;Rear	Saloon RWD 276824		Flexible Coupling	512677
	2014.05-		Front	Saloon RWD 276824		Flexible Coupling Kit	537848S
3.2 (145 kw)	1999.09-2002.08		Front;Rear	Saloon RWD 613960		Flexible Coupling	512677
3.2 (150 kw)	2002.09-2005.08		Front	Saloon RWD 648960		Flexible Coupling	512676
	2002.09-2005.08		Front	Saloon RWD 648960		Flexible Coupling Kit	512671S

	 YEAR	TRANSM.	FITTING POSITION	BODY STYLE & DRIVE TYPE & ENGINE	REMARKS	 PRODUCT	GSP Ref.
MERCEDES-BENZ S320							
3.2 (162 kw)	1995.10-1998.08		Front;Rear	Saloon RWD M 104.990		Flexible Coupling	510571
	1995.10-1998.08		Front	Saloon RWD M 104.990		Flexible Coupling Kit	510571S
3.2 (165 kw)	1999.02-2002.08		Front	Saloon RWD 112944		Flexible Coupling	510571
	1999.02-2002.08		Front;Rear	Saloon RWD 112944		Flexible Coupling	512678
	1999.02-2002.08		Front	Saloon RWD 112944		Flexible Coupling Kit	510571S
	1999.02-2002.08		Front;Rear	Saloon RWD 112944		Flexible Coupling Kit	512673S
3.2 (170 kw)	1993.06-1998.10		Front;Rear	Saloon RWD 104990/104994	VIN from:A 328811	Flexible Coupling	510571
	1993.06-1998.10		Front;Rear	Saloon RWD 104990/104994		Flexible Coupling	510579
	1993.06-1998.10		Front	Saloon RWD 104990/104994		Flexible Coupling Kit	510571S
	1993.06-1998.10		Front	Saloon RWD 104990/104994		Flexible Coupling Kit	510580S
S350							
2.9 (183 kw)	2018.07-		Front;Rear	Saloon 4WD 656929		Flexible Coupling Kit	537630S
2.9 (210 kw)	2017.05-		Front	Saloon 4WD 656929		Flexible Coupling	537851
	2017.05-		Front;Rear	Saloon 4WD 656929		Flexible Coupling Kit	537630S
	2017.07-		Front	Saloon RWD 656929		Flexible Coupling	537851
3.0 (155 kw)	2009.01-2010.12		Front;Rear	Saloon 4WD 642932		Flexible Coupling Kit	512673S
	2009.06-2013.07		Front;Rear	Saloon RWD 642930		Flexible Coupling	533884
	2009.06-2013.07		Front;Rear	Saloon RWD 642930		Flexible Coupling Kit	537832S
3.0 (173 kw)	2009.06-2013.07		Front;Rear	Saloon RWD 642930		Flexible Coupling	533884
	2009.06-2013.07		Front;Rear	Saloon 4WD 642932		Flexible Coupling Kit	512673S
	2009.06-2013.07		Front;Rear	Saloon RWD 642930		Flexible Coupling Kit	537832S
3.0 (185 kw)	2014.02-2017.05		Front	Saloon 4WD 642867		Flexible Coupling	537630
	2014.02-2017.05		Front;Rear	Saloon 4WD 642867		Flexible Coupling	512677
	2014.02-2017.05		Front;Rear	Saloon 4WD 642867		Flexible Coupling Kit	537630S
3.0 (190 kw)	2010.06-2013.07		Centre	Saloon RWD 642862		Center Bearing Support	533842
	2010.06-2013.07		Front;Rear	Saloon RWD 642862		Flexible Coupling	533884
	2010.06-2013.07		Front;Rear	Saloon 4WD 642868		Flexible Coupling Kit	512677S
	2010.06-2013.07		Front;Rear	Saloon RWD 642862		Flexible Coupling Kit	537832S
	2013.05-2017.05		Front	Saloon RWD 642861		Flexible Coupling	537851
	2014.02-2017.05		Front	Saloon 4WD 642867		Flexible Coupling	537630
	2014.02-2017.05		Front;Rear	Saloon 4WD 642867		Flexible Coupling	512677
	2014.02-2017.05		Front;Rear	Saloon 4WD 642867		Flexible Coupling Kit	537630S
3.0 (230 kw)	2017.09-		Centre	Saloon RWD 276824		Center Bearing Support	537766
	2017.09-		Rear	Saloon RWD 276824		Flexible Coupling	537630
	2017.09-		Front	Saloon RWD 276824		Flexible Coupling Kit	537889S
	2017.09-		Front;Rear	Saloon RWD 276824		Flexible Coupling Kit	537630S
3.4 (110 kw)	1993.06-1996.08		Front	Saloon RWD 603971		Flexible Coupling	512676
	1993.06-1996.08		Front	Saloon RWD 603971		Flexible Coupling Kit	512671S
3.5 (200 kw)	2005.09-2013.07		Front;Rear	Saloon RWD 272965		Flexible Coupling Kit	512677S
	2006.09-2013.07	AT/MT	Front	Saloon 4WD 272975		Propshaft	PS900359
	2006.09-2013.07		Front;Rear	Saloon 4WD 272975		Flexible Coupling Kit	512673S
	2006.09-2013.07		Front;Rear	Saloon 4WD 272975		Flexible Coupling Kit	512677S
3.5 (225 kw)	2011.01-2013.07	AT	Front	Saloon 4WD 276950		Propshaft	PS900359
	2011.01-2013.07		Front;Rear	Saloon 4WD 276950		Flexible Coupling Kit	512673S
	2011.01-2013.07		Front;Rear	Saloon RWD 276950		Flexible Coupling Kit	512677S
3.7 (180 kw)	2002.09-2005.12		Front;Rear	Saloon RWD 112972		Flexible Coupling	512677
	2003.02-2005.08		Front;Rear	Saloon 4WD 112975		Flexible Coupling Kit	512673S
S400							
2.9 (250 kw)	2017.05-		Front	Saloon 4WD 656929		Flexible Coupling	537851
	2017.05-		Front;Rear	Saloon 4WD 656929		Flexible Coupling Kit	537630S
	2017.07-		Front	Saloon RWD 656929		Flexible Coupling	537851
3.0 (245 kw)	2013.09-2017.05		Centre	Saloon RWD 276824		Center Bearing Support	537766
	2013.09-2017.05		Front	Saloon RWD 276824		Flexible Coupling	512672
	2013.09-2017.05		Rear	Saloon RWD 276824		Flexible Coupling	537851
	2013.09-2017.05		Front	Saloon RWD 276824		Flexible Coupling Kit	537848S
	2014.11-2017.05	AT	Front	Saloon 4WD 276824	Date From:2015.01	Propshaft	PS900357
	2014.11-2017.05		Rear	Saloon 4WD 276824		Flexible Coupling	537851
3.0 (270 kw)	2014.11-2017.05		Front;Rear	Saloon 4WD 276824		Flexible Coupling	537627
	2015.10-	AT	Front	Coupe 4WD 276824	Date From:2016.01	Propshaft	PS900357
	2015.10-		Front;Rear	Coupe 4WD 276824		Flexible Coupling	537627
3.5 (205 kw)	2008.11-2013.12		Centre	Saloon RWD 272974		Center Bearing Support	533842
	2008.11-2013.12		Front	Saloon RWD 272974		Flexible Coupling Kit	537889S
	2008.11-2013.12		Rear	Saloon RWD 272974		Flexible Coupling Kit	537793S
	2008.11-2013.12		Front;Rear	Saloon RWD 272974		Flexible Coupling Kit	512677S



	 YEAR	TRANSM.	FITTING POSITION	BODY STYLE & DRIVE TYPE & ENGINE	REMARKS	 PRODUCT	GSP Ref.
MERCEDES-BENZ S400							
3.5 (220 kw)	2009.09-2013.12		Front	Saloon RWD		Flexible Coupling Kit	537889S
3.5 (225 kw)	2013.05-2017.05		Centre	Saloon RWD 276960		Center Bearing Support	537766
4.0 (184 kw)	2000.07-2005.08		Front	Saloon RWD 628960		Flexible Coupling	512676
	2000.07-2005.08		Front	Saloon RWD 628960		Flexible Coupling Kit	512671S
4.0 (191 kw)	2003.08-2005.08		Front	Saloon RWD 628960		Flexible Coupling	512676
	2003.08-2005.08		Front	Saloon RWD 628960		Flexible Coupling Kit	512671S
S400 Maybach							
3.0 (245 kw)	2015.01-2017.05		Rear	Saloon 4WD 276824		Flexible Coupling	537847
S420							
4.0 (235 kw)	2006.06-2012.12		Rear	Saloon RWD 629911		Flexible Coupling	537843
	2006.06-2012.12		Front;Rear	Saloon RWD 629911		Flexible Coupling	533884
	2006.06-2012.12		Rear	Saloon RWD 629911		Flexible Coupling Kit	533884S
	2006.06-2012.12		Front;Rear	Saloon RWD 629911		Flexible Coupling Kit	537832S
4.2 (205 kw)	1993.01-1998.10		Front	Saloon RWD 119971/119981		Flexible Coupling	512676
	1993.01-1998.10		Front;Rear	Saloon RWD 119971/119981		Flexible Coupling	512677
	1993.01-1998.10		Front	Saloon RWD 119971/119981		Flexible Coupling Kit	512671S
	1993.01-1998.10		Rear	Saloon RWD 119971/119981		Flexible Coupling Kit	512672S
	1993.06-1998.08		Front	Coupe RWD 119971/119981		Flexible Coupling	512676
	1993.06-1998.08		Front;Rear	Coupe RWD 119971/119981		Flexible Coupling	512677
	1993.06-1998.08		Front	Coupe RWD 119971/119981		Flexible Coupling Kit	512671S
	1993.06-1998.08		Rear	Coupe RWD 119971/119981		Flexible Coupling Kit	512672S
4.2 (210 kw)	1991.02-1998.10		Front	Saloon RWD 119971		Flexible Coupling	512676
	1991.02-1998.10		Front;Rear	Saloon RWD 119971		Flexible Coupling	512677
	1991.02-1998.10		Front	Saloon RWD 119971		Flexible Coupling Kit	512671S
	1991.02-1998.10		Rear	Saloon RWD 119971		Flexible Coupling Kit	537889S
S430							
4.3 (205 kw)	1998.09-2005.08		Front;Rear	Saloon RWD 113941		Flexible Coupling	512677
	1998.09-2005.08		Front;Rear	Saloon RWD 113941		Flexible Coupling Kit	512677S
	2002.09-2005.08		Front;Rear	Saloon 4WD 113948		Flexible Coupling	512678
	2002.09-2005.08		Front;Rear	Saloon 4WD 113948		Flexible Coupling Kit	512673S
S450							
3.0 (270 kw)	2017.02-		Centre	Saloon RWD 276824		Center Bearing Support	537766
	2017.02-		Front	Saloon 4WD 276824		Flexible Coupling	537851
	2017.02-		Rear	Saloon RWD 276824		Flexible Coupling	537851
	2017.02-		Front	Saloon RWD 276824		Flexible Coupling Kit	537848S
	2017.07-		Front;Rear	Saloon RWD 256930		Flexible Coupling	537851
	2017.10-	AT	Front	Coupe 4WD 276824	Date From:2018.01	Propshaft	PS900357
4.0 (235 kw)	2009.06-2013.07		Rear	Saloon RWD 629911		Flexible Coupling	537843
	2009.06-2013.07		Front;Rear	Saloon RWD 629911		Flexible Coupling	533884
	2009.06-2013.07		Rear	Saloon RWD 629911		Flexible Coupling Kit	533884S
	2009.06-2013.07		Front;Rear	Saloon RWD 629911		Flexible Coupling Kit	537832S
4.7 (250 kw)	2005.12-2013.07	AT/MT	Front	Saloon 4WD 273924		Propshaft	PS900359
	2005.12-2013.07		Centre	Saloon RWD 273922		Center Bearing Support	533842
	2005.12-2013.07		Front;Rear	Saloon 4WD 273924		Flexible Coupling Kit	512673S
	2005.12-2013.07		Front;Rear	Saloon RWD 273922		Flexible Coupling Kit	512677S
S500							
3.0 (320 kw)	2017.07-		Front;Rear	Saloon RWD 256930		Flexible Coupling	537851
4.0 (310 kw)	2014.06-2017.10		Front	Coupe 4WD 278910		Flexible Coupling	537851
	2014.06-2017.10		Front;Rear	Coupe 4WD 278910		Flexible Coupling Kit	537630S
4.7 (320 kw)	2011.01-2013.07		Front;Rear	Saloon RWD 278932		Flexible Coupling	533884
	2011.01-2013.07		Front	Saloon RWD 278932		Flexible Coupling Kit	537832S
	2011.01-2013.07		Front;Rear	Saloon 4WD 278932		Flexible Coupling Kit	512677S
	2013.09-2017.05		Front;Rear	Saloon 4WD 278929		Flexible Coupling	512677
	2013.09-2017.05		Front;Rear	Saloon 4WD 278929		Flexible Coupling Kit	537630S
4.7 (335 kw)	2013.05-2017.05		Front	Saloon RWD 278929		Flexible Coupling	537851
	2013.07-2017.05	AT	Front	Saloon 4WD 278929		Propshaft	PS900357
	2013.07-2017.05		Front	Saloon 4WD 278929		Flexible Coupling	537630
	2013.07-2017.05		Front;Rear	Saloon 4WD 278929		Flexible Coupling	512677
	2013.07-2017.05		Front;Rear	Saloon 4WD 278929		Flexible Coupling Kit	537630S
	2014.04-2017.10		Front	Coupe 4WD 278929		Flexible Coupling	537630
	2014.04-2017.10		Front;Rear	Coupe 4WD 278929		Flexible Coupling	512677
	2014.04-2017.10		Front;Rear	Coupe 4WD 278929		Flexible Coupling Kit	537630S
	2014.11-2017.10		Front	Coupe RWD 278929		Flexible Coupling	537851
	2015.12-2017.10		Front	Cabriolet RWD 278929		Flexible Coupling	537851



	 YEAR	TRANSM.	FITTING POSITION	BODY STYLE & DRIVE TYPE & ENGINE	REMARKS	 PRODUCT	GSP Ref.
MERCEDES-BENZ S500							
4.7 (338 kw)	2014.06-2017.05		Front	Saloon RWD 278929		Flexible Coupling	537851
5.0 (220 kw)	1998.10-2003.12		Front	Saloon RWD 113960		Flexible Coupling	512676
	1998.10-2003.12		Front;Rear	Saloon RWD 113960		Flexible Coupling	512677
	1998.10-2003.12		Front	Saloon RWD 113960		Flexible Coupling Kit	512671S
	1998.10-2003.12		Front;Rear	Saloon RWD 113960		Flexible Coupling Kit	512677S
	1998.10-2003.12		Front	Saloon RWD 113960		Flexible Coupling Kit	512677S
5.0 (225 kw)	1998.10-2005.08		Front	Saloon RWD 113960		Flexible Coupling	512676
	1998.10-2005.08		Front;Rear	Saloon RWD 113960		Flexible Coupling	512677
	1998.10-2005.08		Front	Saloon RWD 113960		Flexible Coupling Kit	512671S
	1998.10-2005.08		Front;Rear	Saloon RWD 113960		Flexible Coupling Kit	512677S
	2002.09-2005.08		Front;Rear	Saloon 4WD 113966		Flexible Coupling	512678
	2002.09-2005.08		Front;Rear	Saloon 4WD 113966		Flexible Coupling Kit	512673S
	2002.09-2005.08		Front;Rear	Saloon 4WD 113966		Flexible Coupling Kit	512673S
5.0 (235 kw)	1992.10-1999.12		Front	Coupe RWD 119970		Flexible Coupling	512676
	1992.10-1999.12		Front;Rear	Coupe RWD 119970		Flexible Coupling	512677
	1992.10-1999.12		Front	Coupe RWD 119970		Flexible Coupling Kit	512671S
	1992.10-1999.12		Rear	Coupe RWD 119970		Flexible Coupling Kit	512672S
	1993.01-1997.12		Centre	Saloon RWD 119980		Center Bearing Support	530178
	1993.01-1997.12		Front	Saloon RWD 119980		Flexible Coupling	512676
	1993.01-1997.12		Front;Rear	Saloon RWD 119980		Flexible Coupling	512677
	1993.01-1997.12		Front	Saloon RWD 119980		Flexible Coupling Kit	512671S
	1993.01-1997.12		Rear	Saloon RWD 119980		Flexible Coupling Kit	512672S
	1993.01-1997.12		Rear	Saloon RWD 119980		Flexible Coupling Kit	512672S
5.0 (240 kw)	1991.06-1998.10		Centre	Saloon RWD 119970		Center Bearing Support	530178
	1991.06-1998.10		Front	Saloon RWD 119970		Flexible Coupling	512676
	1991.06-1998.10		Front;Rear	Saloon RWD 119970		Flexible Coupling	512677
	1991.06-1998.10		Front	Saloon RWD 119970		Flexible Coupling Kit	512671S
	1991.06-1998.10		Rear	Saloon RWD 119970		Flexible Coupling Kit	512672S
5.5 (271 kw)	2011.05-2013.07		Front	Saloon RWD 273961		Flexible Coupling Kit	537832S
5.5 (285 kw)	2005.09-2013.07		Centre	Saloon RWD 273961		Center Bearing Support	533842
	2005.09-2013.07		Front;Rear	Saloon RWD 273961		Flexible Coupling	533884
	2005.09-2013.07		Front;Rear	Saloon RWD 273961		Flexible Coupling Kit	537832S
	2006.06-2013.07	AT/MT	Front	Saloon 4WD 273968		Propshaft	PS900359
	2006.06-2013.07		Front;Rear	Saloon 4WD 273968		Flexible Coupling Kit	512673S
S500 Maybach							
4.0 (310 kw)	2015.09-2017.05		Front	Saloon 4WD 278910		Flexible Coupling	537630
	2015.09-2017.05		Front;Rear	Saloon 4WD 278910		Flexible Coupling Kit	537630S
4.7 (335 kw)	2014.12-		Centre	Saloon RWD 278929		Center Bearing Support	537766
	2014.12-		Front	Saloon RWD 278929		Flexible Coupling	537851
	2015.04-2017.05	AT	Front	Saloon 4WD 278929		Propshaft	PS900357
	2015.04-2017.05		Front	Saloon 4WD 278929		Flexible Coupling	537630
	2015.04-2017.05		Front;Rear	Saloon 4WD 278929		Flexible Coupling	512677
	2015.04-2017.05		Front;Rear	Saloon 4WD 278929		Flexible Coupling Kit	537630S
	2015.04-2017.05		Front;Rear	Saloon 4WD 278929		Flexible Coupling Kit	537630S
S55 AMG							
5.4 (265 kw)	1999.09-2002.08		Front	Saloon RWD 113986		Flexible Coupling	512676
	1999.09-2002.08		Front	Saloon RWD 113986		Flexible Coupling Kit	512671S
5.4 (368 kw)	2002.09-2005.08		Front;Rear	Saloon RWD 113991		Flexible Coupling	533884
	2002.09-2005.08		Front;Rear	Saloon RWD 113991		Flexible Coupling Kit	537832S
S550							
4.6 (320 kw)	2011.09-2013.12		Front;Rear	Saloon AWD M 278.932		Flexible Coupling Kit	512677S
4.7 (320 kw)	2011.01-2013.07		Front;Rear	Saloon RWD 278932		Flexible Coupling	533884
	2011.01-2013.07		Front	Saloon RWD 278932		Flexible Coupling Kit	537832S
4.7 (335 kw)	2013.05-2017.05	AT	Front	Saloon 4WD 278929		Propshaft	PS900357
	2013.05-2017.05		Front	Saloon 4WD 278929		Flexible Coupling	537630
	2013.05-2017.05		Front;Rear	Saloon 4WD 278929		Flexible Coupling	512677
	2013.05-2017.05		Front;Rear	Saloon 4WD 278929		Flexible Coupling Kit	537630S
S560							
4.0 (345 kw)	2017.05-		Front	Saloon 4WD 176980		Flexible Coupling	537630
	2017.05-		Front;Rear	Saloon 4WD 176980		Flexible Coupling Kit	537630S
	2017.07-		Front;Rear	Saloon RWD 176980		Flexible Coupling	537851
	2017.10-	AT	Front	Coupe 4WD 176980	Date From:2018.01	Propshaft	PS900357
	2017.10-		Front	Cabriolet RWD 176980		Flexible Coupling	537851
	2017.10-		Front	Coupe RWD 176980		Flexible Coupling	537851
	2017.10-		Front;Rear	Coupe 4WD 176980		Flexible Coupling	537630
	2017.10-		Front;Rear	Coupe 4WD 176980		Flexible Coupling Kit	537630S



	 YEAR	TRANSM.	FITTING POSITION	BODY STYLE & DRIVE TYPE & ENGINE	REMARKS	 PRODUCT	GSP Ref.
MERCEDES-BENZ							
S560 Maybach							
4.0 (345 kw)	2017.07-		Front;Rear	Saloon RWD 176980		Flexible Coupling	537851
	2017.09-		Front	Saloon 4WD 176980		Flexible Coupling	537630
	2017.09-		Front;Rear	Saloon 4WD 176980		Flexible Coupling Kit	537630S
S600							
5.5 (368 kw)	2002.09-2005.08		Front;Rear	Saloon RWD 275950		Flexible Coupling	533884
	2002.09-2005.08		Front;Rear	Saloon RWD 275950		Flexible Coupling Kit	537832S
5.5 (380 kw)	2005.09-2013.12		Front;Rear	Saloon RWD 275953		Flexible Coupling	533884
	2005.09-2013.12		Front;Rear	Saloon RWD 275953		Flexible Coupling Kit	537832S
5.8 (270 kw)	1999.09-2002.08		Front	Saloon RWD 137970		Flexible Coupling	512676
	1999.09-2002.08		Front	Saloon RWD 137970		Flexible Coupling Kit	512671S
6.0 (290 kw)	1991.09-1998.10		Front	Saloon RWD 120980/120982		Flexible Coupling	512676
	1991.09-1998.10		Front	Saloon RWD 120980/120982		Flexible Coupling Kit	512671S
	1992.09-1999.02		Front	Coupe RWD 120980/120982		Flexible Coupling	512676
	1992.09-1999.02		Front	Coupe RWD 120980/120982		Flexible Coupling Kit	512671S
S63 AMG							
4.0 (450 kw)	2017.05-		Front;Rear	Saloon 4WD 177980		Flexible Coupling	537851
	2017.10-		Front;Rear	Cabriolet 4WD 177980		Flexible Coupling	537851
	2017.10-		Front;Rear	Coupe 4WD 177980		Flexible Coupling	537851
5.5 (430 kw)	2013.07-2017.05	AT/MT	Front	Saloon 4WD 157985	Date To:2014.01	Propshaft	PS900359
	2015.11-2017.10	AT/MT	Front	Cabriolet 4WD 157985	Date From:2016.01	Propshaft	PS900359
6.2 (386 kw)	2006.12-2013.07		Front;Rear	Saloon RWD 156984		Flexible Coupling	533884
	2006.12-2013.07		Front;Rear	Saloon RWD 156984		Flexible Coupling Kit	537832S
S65 AMG							
6.0 (450 kw)	2004.03-2005.08		Front;Rear	Saloon RWD 275980		Flexible Coupling	533884
	2004.03-2005.08		Front;Rear	Saloon RWD 275980		Flexible Coupling Kit	537832S
	2005.12-2013.07		Front;Rear	Saloon RWD 275982		Flexible Coupling	533884
	2005.12-2013.07		Front;Rear	Saloon RWD 275982		Flexible Coupling Kit	537832S
6.0 (463 kw)	2010.10-2013.12		Front;Rear	Saloon RWD 275982		Flexible Coupling	533884
	2010.10-2013.12		Front;Rear	Saloon RWD 275982		Flexible Coupling Kit	537832S
SL280							
2.8 (142 kw)	1993.06-1998.05		Front	Cabriolet RWD 104943		Flexible Coupling	510571
	1993.06-1998.05		Front;Rear	Cabriolet RWD 104943		Flexible Coupling	510579
	1993.06-1998.05		Front	Cabriolet RWD 104943		Flexible Coupling Kit	510580S
2.8 (150 kw)	1998.06-2001.07		Front;Rear	Cabriolet RWD 112923		Flexible Coupling	512678
	1998.06-2001.07		Front;Rear	Cabriolet RWD 112923		Flexible Coupling Kit	512673S
3.0 (170 kw)	2007.08-2012.01		Front;Rear	Cabriolet RWD 272949		Flexible Coupling Kit	512673S
SL300							
3.0 (170 kw)	2009.06-2012.01		Front;Rear	Cabriolet RWD 272949		Flexible Coupling Kit	512673S
SL320							
3.2 (165 kw)	1998.06-2001.07		Front;Rear	Cabriolet RWD 112943		Flexible Coupling Kit	512673S
3.2 (170 kw)	1994.01-1998.05		Front;Rear	Cabriolet RWD 104991		Flexible Coupling	510579
	1994.01-1998.05		Front	Cabriolet RWD 104991		Flexible Coupling Kit	510580S
SL350							
3.5 (200 kw)	2006.03-2008.11		Front;Rear	Cabriolet RWD 272966		Flexible Coupling Kit	512677S
3.5 (225 kw)	2011.12-		Front;Rear	Cabriolet RWD 276954		Flexible Coupling Kit	512677S
3.5 (232 kw)	2008.04-2012.01		Front;Rear	Cabriolet RWD 272968		Flexible Coupling Kit	512677S
3.7 (180 kw)	2002.08-2005.07		Centre	Cabriolet RWD 112973		Center Bearing Support	518416
	2002.08-2005.07		Front;Rear	Cabriolet RWD 112973		Flexible Coupling	512677
SL500							
4.7 (320 kw)	2011.12-		Front;Rear	Cabriolet RWD 278927		Flexible Coupling	533884
	2011.12-		Front;Rear	Cabriolet RWD 278927	9AT	Flexible Coupling	537851
	2011.12-		Front;Rear	Cabriolet RWD 278927		Flexible Coupling Kit	537832S
4.7 (335 kw)	2015.04-		Front;Rear	Cabriolet RWD 278927		Flexible Coupling	537851
5.0 (225 kw)	1998.06-2002.12		Front;Rear	Cabriolet RWD 113961		Flexible Coupling	512677
	2001.08-2012.01		Front;Rear	Cabriolet RWD 113963		Flexible Coupling	512677
	2001.08-2012.01		Front;Rear	Cabriolet RWD 113963		Flexible Coupling Kit	512677S
5.0 (235 kw)	1992.09-2003.12		Centre	Cabriolet RWD 119972/119982		Center Bearing Support	530178
	1992.09-2003.12		Front	Cabriolet RWD 119972/119982		Flexible Coupling	512676
	1992.09-2003.12		Front;Rear	Cabriolet RWD 119972/119982		Flexible Coupling	512677
	1992.09-2003.12		Front	Cabriolet RWD 119972/119982		Flexible Coupling Kit	512671S
5.5 (285 kw)	2006.03-2012.01		Front;Rear	Cabriolet RWD 273965		Flexible Coupling	533884
	2006.03-2012.01		Front;Rear	Cabriolet RWD 273965		Flexible Coupling Kit	537832S



	 YEAR	TRANSM.	FITTING POSITION	BODY STYLE & DRIVE TYPE & ENGINE	REMARKS	 PRODUCT	GSP Ref.
MERCEDES-BENZ							
SL55 AMG							
5.4 (368 kw)	2002.08-2005.07		Front;Rear	Cabriolet RWD 113992		Flexible Coupling	533884
	2002.08-2005.07		Front;Rear	Cabriolet RWD 113992		Flexible Coupling Kit	537832S
5.4 (380 kw)	2006.03-2012.01		Front;Rear	Cabriolet RWD 113995		Flexible Coupling	533884
	2006.03-2012.01		Front;Rear	Cabriolet RWD 113995		Flexible Coupling Kit	537832S
5.5 (350 kw)	2001.08-2005.12		Front;Rear	Cabriolet RWD 113992		Flexible Coupling	533884
	2001.08-2005.12		Front;Rear	Cabriolet RWD 113992		Flexible Coupling Kit	537832S
SL60 AMG							
6.0 (280 kw)	1996.06-2001.07		Front	Cabriolet RWD 119972AMG/119982AMG		Flexible Coupling	512676
	1996.06-2001.07		Front;Rear	Cabriolet RWD 119972AMG/119982AMG		Flexible Coupling	512677
	1996.06-2001.07		Front	Cabriolet RWD 119972AMG/119982AMG		Flexible Coupling Kit	512671S
SL600							
5.5 (368 kw)	2003.02-2012.01		Front;Rear	Cabriolet RWD 275951		Flexible Coupling	533884
	2003.02-2012.01		Front;Rear	Cabriolet RWD 275951		Flexible Coupling Kit	537832S
5.5 (380 kw)	2006.01-2012.01		Front;Rear	Cabriolet RWD 275954		Flexible Coupling	533884
	2006.01-2012.01		Front;Rear	Cabriolet RWD 275954		Flexible Coupling Kit	537832S
6.0 (290 kw)	1992.07-2001.10		Front	Cabriolet RWD 120981/120983		Flexible Coupling	512676
	1992.07-2001.10		Front	Cabriolet RWD 120981/120983		Flexible Coupling Kit	512671S
SL63 AMG							
5.5 (395 kw)	2012.01-		Front;Rear	Cabriolet RWD 157983		Flexible Coupling	533884
	2012.01-		Front;Rear	Cabriolet RWD 157983		Flexible Coupling Kit	537832S
5.5 (415 kw)	2012.01-		Front;Rear	Cabriolet RWD 157983		Flexible Coupling	533884
	2012.01-		Front;Rear	Cabriolet RWD 157983		Flexible Coupling Kit	537832S
SL65 AMG							
6.0 (450 kw)	2004.09-2011.12		Front;Rear	Cabriolet RWD 275981		Flexible Coupling	533884
	2004.09-2011.12		Front;Rear	Cabriolet RWD 275981		Flexible Coupling Kit	537832S
6.0 (463 kw)	2012.01-		Front;Rear	Cabriolet RWD 279981		Flexible Coupling	533884
	2012.01-		Front;Rear	Cabriolet RWD 279981		Flexible Coupling Kit	537832S
SL73 AMG							
7.3 (386 kw)	1999.01-2001.12		Front	Cabriolet RWD 120983AMG		Flexible Coupling	512676
	1999.01-2001.12		Front	Cabriolet RWD 120983AMG		Flexible Coupling Kit	512671S
SLC180							
1.6 (115 kw)	2016.01-		Front;Rear	Cabriolet RWD 274910		Flexible Coupling	537627
SLC200							
2.0 (135 kw)	2016.01-		Front;Rear	Cabriolet RWD 274920		Flexible Coupling	537627
SLC250							
2.2 (150 kw)	2016.01-2017.10		Front	Cabriolet RWD 651980		Flexible Coupling	537630
	2016.01-2017.10		Front;Rear	Cabriolet RWD 651980		Flexible Coupling	512677
	2016.01-2017.10		Front;Rear	Cabriolet RWD 651980		Flexible Coupling Kit	512677S
	2016.01-2017.10		Front;Rear	Cabriolet RWD 651980		Flexible Coupling Kit	537630S
SLC260							
2.0 (155 kw)	2018.05-		Front;Rear	Cabriolet RWD 274920		Flexible Coupling Kit	537630S
SLC300							
2.0 (180 kw)	2016.01-		Front	Cabriolet RWD 274920		Flexible Coupling	537630
	2016.01-		Front;Rear	Cabriolet RWD 274920		Flexible Coupling Kit	537630S
SLC43 AMG							
3.0 (270 kw)	2016.01-		Front	Cabriolet RWD 276822		Flexible Coupling	537630
	2016.01-		Front;Rear	Cabriolet RWD 276822		Flexible Coupling Kit	537630S
3.0 (287 kw)	2018.06-		Rear	Cabriolet RWD 276822		Flexible Coupling	537630
	2018.06-		Front;Rear	Cabriolet RWD 276822		Flexible Coupling Kit	537630S
SLK200							
1.8 (120 kw)	2004.03-2011.02		Front;Rear	Cabriolet RWD 271944		Flexible Coupling	512678
	2004.03-2011.02		Front;Rear	Cabriolet RWD 271944		Flexible Coupling Kit	512673S
1.8 (135 kw)	2008.01-2011.02		Front;Rear	Cabriolet RWD 271954		Flexible Coupling	512678
	2008.01-2011.02		Front;Rear	Cabriolet RWD 271954		Flexible Coupling Kit	512673S
	2011.01-		Front;Rear	Cabriolet RWD 271861		Flexible Coupling	512678
2.0 (100 kw)	2011.01-		Front;Rear	Cabriolet RWD 271861		Flexible Coupling Kit	512673S
	1996.09-1999.09		Centre	Cabriolet RWD 111946		Center Bearing Support	512316
	1996.09-1999.09		Front	Cabriolet RWD 111946		Flexible Coupling	510569
	1996.09-1999.09		Front	Cabriolet RWD 111946	MT,for left-hand drive vehicles	Flexible Coupling	512326
	1996.09-1999.09		Front	Cabriolet RWD 111946		Flexible Coupling Kit	510570S
	1996.09-1999.09		Front	Cabriolet RWD 111946		Flexible Coupling Kit	510578S
2.0 (120 kw)	1999.10-2003.09		Front;Rear	Cabriolet RWD 111958		Flexible Coupling	512678
	1999.10-2003.09		Front;Rear	Cabriolet RWD 111958	MT,for vehicles with air conditioning	Flexible Coupling Kit	537821S
						Flexible Coupling Kit	512673S



	 YEAR	TRANSM.	FITTING POSITION	BODY STYLE & DRIVE TYPE & ENGINE	REMARKS	 PRODUCT	GSP Ref.
MERCEDES-BENZ SLK200							
2.0 (135 kw)	2015.04-		Front;Rear	Cabriolet RWD 274920		Flexible Coupling	537627
2.0 (141 kw)	1996.10-2000.03		Centre	Cabriolet RWD 111943		Center Bearing Support	512315
	1996.10-2000.03		Front;Rear	Cabriolet RWD 111943		Flexible Coupling	510579
	1996.10-2000.03		Front;Rear	Cabriolet RWD 111943		Flexible Coupling	512678
	1996.10-2000.03		Front	Cabriolet RWD 111943		Flexible Coupling Kit	537796S
	1996.10-2000.03		Front	Cabriolet RWD 111943	VIN from:F 094036	Flexible Coupling Kit	537819S
	1996.10-2000.03		Front;Rear	Cabriolet RWD 111943		Flexible Coupling Kit	512673S
SLK230							
2.3 (142 kw)	1996.09-2000.12		Centre	Cabriolet RWD 111973		Center Bearing Support	512315
	1996.09-2000.12		Front;Rear	Cabriolet RWD 111973		Flexible Coupling	512678
	1996.09-2000.12		Front	Cabriolet RWD 111973		Flexible Coupling Kit	537819S
	1996.09-2000.12		Front;Rear	Cabriolet RWD 111973		Flexible Coupling Kit	512673S
2.3 (143 kw)	1997.03-2004.04		Front;Rear	Cabriolet RWD 111983		Flexible Coupling Kit	512673S
2.3 (145 kw)	1999.10-2004.01		Front;Rear	Cabriolet RWD 111983		Flexible Coupling	512678
	1999.10-2004.01		Front;Rear	Cabriolet RWD 111983		Flexible Coupling Kit	512673S
SLK250							
1.8 (150 kw)	2011.02-		Front;Rear	Cabriolet RWD 271861		Flexible Coupling	512678
	2011.02-		Front;Rear	Cabriolet RWD 271861		Flexible Coupling Kit	512673S
2.2 (150 kw)	2012.01-		Rear	Cabriolet RWD 651980		Flexible Coupling	537630
	2012.01-		Front;Rear	Cabriolet RWD 651980		Flexible Coupling	512677
	2012.01-		Front;Rear	Cabriolet RWD 651980		Flexible Coupling Kit	512677S
	2012.01-		Front;Rear	Cabriolet RWD 651980		Flexible Coupling Kit	537630S
SLK280							
3.0 (170 kw)	2005.01-2010.12		Centre	Cabriolet RWD 272942		Center Bearing Support	518416
	2005.01-2010.12		Front;Rear	Cabriolet RWD 272942		Flexible Coupling	512678
	2005.01-2010.12		Front;Rear	Cabriolet RWD 272942		Flexible Coupling Kit	512673S
SLK300							
2.0 (180 kw)	2015.07-		Rear	Cabriolet RWD 274920		Flexible Coupling	537630
	2015.07-		Front;Rear	Cabriolet RWD 274920		Flexible Coupling Kit	537630S
3.0 (170 kw)	2009.04-2011.02		Centre	Cabriolet RWD 272942		Center Bearing Support	518416
	2009.04-2011.02		Front;Rear	Cabriolet RWD 272942		Flexible Coupling	512678
	2009.04-2011.02		Front;Rear	Cabriolet RWD 272942		Flexible Coupling Kit	512673S
SLK32 AMG							
3.2 (260 kw)	2000.04-2004.01		Centre	Cabriolet RWD 112960		Center Bearing Support	518416
	2000.04-2004.01		Front;Rear	Cabriolet RWD 112960		Flexible Coupling	512677
	2000.04-2004.01		Front;Rear	Cabriolet RWD 112960		Flexible Coupling Kit	512677S
SLK320							
3.2 (160 kw)	1999.10-2004.01		Centre	Cabriolet RWD 112947		Center Bearing Support	518416
	1999.10-2004.01		Front;Rear	Cabriolet RWD 112947		Flexible Coupling Kit	512673S
SLK350							
3.5 (200 kw)	2004.06-2011.02		Front;Rear	Cabriolet RWD 272963		Flexible Coupling	512677
	2004.06-2011.02		Front	Cabriolet RWD 272963		Flexible Coupling Kit	537794S
3.5 (225 kw)	2011.01-		Front;Rear	Cabriolet RWD 276956		Flexible Coupling	512677
	2011.01-		Front;Rear	Cabriolet RWD 276956		Flexible Coupling Kit	512677S
Sprinter 208D							
2.2 (60 kw)	2000.04-2006.05	MT	-	BUS RWD 611987		Propshaft	PS900373
	2000.04-2006.05	MT	-	Chassis cabin RWD 611987		Propshaft	PS900373
	2000.04-2006.05	MT	-	VAN RWD 611987		Propshaft	PS900373
	2000.04-2006.05		Centre	BUS RWD 611987		Center Bearing Support	510503
	2000.04-2006.05		Centre	Chassis cabin RWD 611987		Center Bearing Support	510503
	2000.04-2006.05		Centre	VAN RWD 611987		Center Bearing Support	510503
	2000.04-2006.05		Centre	BUS RWD 611987		Center Bearing Support Kit	531028S
	2000.04-2006.05		Centre	Chassis cabin RWD 611987		Center Bearing Support Kit	531028S
	2000.04-2006.05		Centre	VAN RWD 611987		Center Bearing Support Kit	531028S
2.3 (58 kw)	1995.02-2000.04		Centre	BUS RWD 601943		Center Bearing Support	510503
	1995.02-2000.04		Centre	VAN RWD 601943		Center Bearing Support	510503
	1995.02-2000.04		Centre	BUS RWD 601943		Center Bearing Support Kit	531028S
	1995.02-2000.04		Centre	VAN RWD 601943		Center Bearing Support Kit	531028S
	1995.04-2000.04		Centre	Chassis cabin RWD 601943		Center Bearing Support	510503
	1995.04-2000.04		Centre	Chassis cabin RWD 601943		Center Bearing Support Kit	531028S
2.3 (60 kw)	1996.09-2000.04		Centre	Chassis cabin RWD 601943		Center Bearing Support	510503
	1996.09-2000.04		Centre	Chassis cabin RWD 601943		Center Bearing Support Kit	531028S
	1996.10-2000.04		Centre	VAN RWD 601943		Center Bearing Support	510503
	1996.10-2000.04		Centre	VAN RWD 601943		Center Bearing Support Kit	531028S



	 YEAR	TRANSM.	FITTING POSITION	BODY STYLE & DRIVE TYPE & ENGINE	REMARKS	 PRODUCT	GSP Ref.
MERCEDES-BENZ							
Sprinter 209D							
2.2 (65 kw)	2006.06-	MT	Front	Chassis cabin RWD 646984	Chassis no. to:N478535/E057183	Propshaft	PS900365
	2006.06-	6MT	Rear	Chassis cabin RWD 646984	Trans. code:TSG 360	Propshaft	PS900550
	2006.06-	6MT	Rear	VAN RWD 646984	Trans. code:TSG 360	Propshaft	PS900550
	2006.06-	AT	Rear	VAN RWD 646984		Propshaft	PS900367
	2006.06-		Front;Rear	Chassis cabin RWD 646984		Center Bearing Support	514807
	2006.06-		Front;Rear	VAN RWD 646984		Center Bearing Support	514807
	2006.06-		Centre	Chassis cabin RWD 646984		Center Bearing Support Kit	514795S
	2006.06-		Centre	VAN RWD 646984		Center Bearing Support Kit	514795S
	2006.06-		Front;Rear	Chassis cabin RWD 646984		Flexible Coupling	533884
	2006.06-		Front;Rear	VAN RWD 646984		Flexible Coupling	533884
	2006.06-		Front;Rear	Chassis cabin RWD 646984		Flexible Coupling Kit	537832S
	2006.06-		Front;Rear	VAN RWD 646984		Flexible Coupling Kit	537832S
Sprinter 210D							
2.2 (70 kw)	2009.03-	6MT	Rear	VAN RWD 651955/651956	Trans. code:TSG 360	Propshaft	PS900550
	2009.03-	6MT	Rear	Chassis cabin RWD 651955/651956	Trans. code:TSG 360	Propshaft	PS900550
	2009.03-	AT	Rear	VAN RWD 651955/651956		Propshaft	PS900367
	2009.03-	AT	Rear	Chassis cabin RWD 651955/651956		Propshaft	PS900367
	2009.03-	AT	Rear	VAN RWD 651955/651956	Date From:2011.04,Chassis no. from:56829,from 573459	Propshaft	PS900559
	2009.03-	AT	Rear	Chassis cabin RWD 651955/651956	Date From:2011.04,Chassis no. from:56829,from 573459	Propshaft	PS900559
	2009.03-		Front;Rear	VAN RWD 651955/651956		Center Bearing Support	514807
	2009.03-		Front;Rear	Chassis cabin RWD 651955/651956		Center Bearing Support	514807
	2009.03-		Centre	VAN RWD 651955/651956		Center Bearing Support Kit	514795S
	2009.03-		Centre	Chassis cabin RWD 651955/651956		Center Bearing Support Kit	514795S
	2009.03-		Front;Rear	VAN RWD 651955/651956		Flexible Coupling	533884
	2009.03-		Front;Rear	Chassis cabin RWD 651955/651956		Flexible Coupling	533884
	2009.03-		Front;Rear	VAN RWD 651955/651956		Flexible Coupling Kit	537832S
	2009.03-		Front;Rear	Chassis cabin RWD 651955/651956		Flexible Coupling Kit	537832S
2.9 (75 kw)	1997.01-2000.04		Centre	BUS RWD 602980		Center Bearing Support	510503
	1997.01-2000.04		Centre	Chassis cabin RWD 602980		Center Bearing Support	510503
	1997.01-2000.04		Centre	VAN RWD 602980		Center Bearing Support	510503
	1997.01-2000.04		Centre	BUS RWD 602980		Center Bearing Support Kit	531028S
	1997.01-2000.04		Centre	Chassis cabin RWD 602980		Center Bearing Support Kit	531028S
	1997.01-2000.04		Centre	VAN RWD 602980		Center Bearing Support Kit	531028S
Sprinter 211D							
2.2 (80 kw)	2000.04-2006.05	MT	-	BUS RWD 611981		Propshaft	PS900373
	2000.04-2006.05	MT	-	Chassis cabin RWD 611981		Propshaft	PS900373
	2000.04-2006.05	MT	-	VAN RWD 611981		Propshaft	PS900373
	2000.04-2006.05		Centre	BUS RWD 611981		Center Bearing Support	510503
	2000.04-2006.05		Centre	Chassis cabin RWD 611981		Center Bearing Support	510503
	2000.04-2006.05		Centre	VAN RWD 611981		Center Bearing Support	510503
	2000.04-2006.05		Centre	BUS RWD 611981		Center Bearing Support Kit	531028S
	2000.04-2006.05		Centre	Chassis cabin RWD 611981		Center Bearing Support Kit	531028S
	2000.04-2006.05		Centre	VAN RWD 611981		Center Bearing Support Kit	531028S
	2006.06-	MT	Front	Chassis cabin RWD 646985	Chassis no. to:N478535/E057183	Propshaft	PS900365
	2006.06-	6MT	Rear	BUS RWD 646985	Trans. code:TSG 360	Propshaft	PS900550
	2006.06-	6MT	Rear	Chassis cabin RWD 646985	Trans. code:TSG 360	Propshaft	PS900550
	2006.06-	6MT	Rear	VAN RWD 646985	Trans. code:TSG 360	Propshaft	PS900550
	2006.06-	AT	Rear	BUS RWD 646985		Propshaft	PS900367
	2006.06-	AT	Rear	Chassis cabin RWD 646985		Propshaft	PS900367
	2006.06-	AT	Rear	VAN RWD 646985		Propshaft	PS900367
	2006.06-		Front;Rear	BUS RWD 646985		Center Bearing Support	514807
	2006.06-		Front;Rear	Chassis cabin RWD 646985		Center Bearing Support	514807
	2006.06-		Front;Rear	VAN RWD 646985		Center Bearing Support	514807
	2006.06-		Centre	BUS RWD 646985		Center Bearing Support Kit	514795S
	2006.06-		Centre	Chassis cabin RWD 646985		Center Bearing Support Kit	514795S
	2006.06-		Centre	VAN RWD 646985		Center Bearing Support Kit	514795S
	2006.06-		Front;Rear	BUS RWD 646985		Flexible Coupling	533884
	2006.06-		Front;Rear	Chassis cabin RWD 646985		Flexible Coupling	533884
	2006.06-		Front;Rear	VAN RWD 646985		Flexible Coupling	533884
	2006.06-		Front;Rear	BUS RWD 646985		Flexible Coupling Kit	537832S
	2006.06-		Front;Rear	Chassis cabin RWD 646985		Flexible Coupling Kit	537832S
	2006.06-		Front;Rear	VAN RWD 646985		Flexible Coupling Kit	537832S
2.2 (84 kw)	2016.04-	AT	Rear	BUS RWD 651955/651956		Propshaft	PS900367
	2016.04-	AT	Rear	Chassis cabin RWD 651955/651956		Propshaft	PS900367



	 YEAR	TRANSM.	FITTING POSITION	BODY STYLE & DRIVE TYPE & ENGINE	REMARKS	 PRODUCT	GSP Ref.
MERCEDES-BENZ							
Sprinter 211D							
2.2 (84 kw)	2016.04-	AT	Rear	VAN RWD 651955/651956		Propshaft	PS900367
	2016.04-		Front;Rear	BUS RWD 651955/651956		Center Bearing Support	514807
	2016.04-		Front;Rear	Chassis cabin RWD 651955/651956		Center Bearing Support	514807
	2016.04-		Front;Rear	VAN RWD 651955/651956		Center Bearing Support	514807
	2016.04-		Centre	BUS RWD 651955/651956		Center Bearing Support Kit	514795S
	2016.04-		Centre	Chassis cabin RWD 651955/651956		Center Bearing Support Kit	514795S
	2016.04-		Centre	VAN RWD 651955/651956		Center Bearing Support Kit	514795S
Sprinter 212D							
2.9 (90 kw)	1995.02-2000.04		Centre	BUS RWD 602980		Center Bearing Support	510503
	1995.02-2000.04		Centre	Chassis cabin RWD 602980		Center Bearing Support	510503
	1995.02-2000.04		Centre	VAN RWD 602980		Center Bearing Support	510503
	1995.02-2000.04		Centre	BUS RWD 602980		Center Bearing Support Kit	531028S
	1995.02-2000.04		Centre	Chassis cabin RWD 602980		Center Bearing Support Kit	531028S
	1995.02-2000.04		Centre	VAN RWD 602980		Center Bearing Support Kit	531028S
Sprinter 213D							
2.2 (95 kw)	2000.04-2006.05	MT	-	BUS RWD 611981		Propshaft	PS900373
	2000.04-2006.05	MT	-	Chassis cabin RWD 611981		Propshaft	PS900373
	2000.04-2006.05	MT	-	VAN RWD 611981		Propshaft	PS900373
	2000.04-2006.05		Centre	BUS RWD 611981		Center Bearing Support	510503
	2000.04-2006.05		Centre	Chassis cabin RWD 611981		Center Bearing Support	510503
	2000.04-2006.05		Centre	VAN RWD 611981		Center Bearing Support	510503
	2000.04-2006.05		Centre	BUS RWD 611981		Center Bearing Support Kit	531028S
	2000.04-2006.05		Centre	Chassis cabin RWD 611981		Center Bearing Support Kit	531028S
	2000.04-2006.05		Centre	VAN RWD 611981		Center Bearing Support Kit	531028S
	2006.06-	MT	Front	Chassis cabin RWD 646986	Chassis no. to:N478535/E057183	Propshaft	PS900365
	2006.06-	6MT	Rear	Chassis cabin RWD 646986	Trans. code:TSG 360	Propshaft	PS900550
	2006.06-	6MT	Rear	VAN RWD 646986	Trans. code:TSG 360	Propshaft	PS900550
	2006.06-	AT	Rear	Chassis cabin RWD 646986		Propshaft	PS900367
	2006.06-	AT	Rear	VAN RWD 646986		Propshaft	PS900367
	2006.06-	6MT	-	BUS RWD 651955/651956/651957	Trans. code:TSG 360	Propshaft	PS900550
	2006.06-		Front;Rear	Chassis cabin RWD 646986		Center Bearing Support	514807
	2006.06-		Front;Rear	VAN RWD 646986		Center Bearing Support	514807
	2006.06-		Front;Rear	BUS RWD 651955/651956/651957		Center Bearing Support	514807
	2006.06-		Centre	Chassis cabin RWD 646986		Center Bearing Support Kit	514795S
	2006.06-		Centre	VAN RWD 646986		Center Bearing Support Kit	514795S
	2006.06-		Centre	BUS RWD 651955/651956/651957		Center Bearing Support Kit	514795S
	2006.06-		Front;Rear	Chassis cabin RWD 646986		Flexible Coupling	533884
	2006.06-		Front;Rear	VAN RWD 646986		Flexible Coupling	533884
	2006.06-		Front;Rear	Chassis cabin RWD 646986		Flexible Coupling Kit	537832S
	2006.06-		Front;Rear	VAN RWD 646986		Flexible Coupling Kit	537832S
	2009.03-	6MT	Rear	VAN RWD 651955/651956/651957	Date From:2009.03,Trans. code:TSG 360	Propshaft	PS900550
	2009.03-	AT	Rear	VAN RWD 651955/651956/651957	Date From:2009.03	Propshaft	PS900367
	2009.03-	AT	Rear	VAN RWD 651955/651956/651957	Date From:2011.04,Chassis no. from:56829,from 573459	Propshaft	PS900559
	2009.03-		Front;Rear	VAN RWD 651955/651956/651957		Center Bearing Support	514807
	2009.03-		Centre	VAN RWD 651955/651956/651957		Center Bearing Support Kit	514795S
Sprinter 214							
2.3 (105 kw)	1995.02-2006.05		Centre	BUS RWD 111979/111984		Center Bearing Support	510503
	1995.02-2006.05		Centre	Chassis cabin RWD 111979/111984		Center Bearing Support	510503
	1995.02-2006.05		Centre	VAN RWD 111979/111984		Center Bearing Support	510503
	1995.02-2006.05		Centre	BUS RWD 111979/111984		Center Bearing Support Kit	531028S
	1995.02-2006.05		Centre	Chassis cabin RWD 111979/111984		Center Bearing Support Kit	531028S
	1995.02-2006.05		Centre	VAN RWD 111979/111984		Center Bearing Support Kit	531028S
Sprinter 214 NGT							
2.3 (95 kw)	1995.02-2006.05		Centre	BUS RWD 111979NGT/111984NGT		Center Bearing Support	510503
	1995.02-2006.05		Centre	Chassis cabin RWD 111979NGT/111984NGT		Center Bearing Support	510503
	1995.02-2006.05		Centre	VAN RWD 111979NGT/111984NGT		Center Bearing Support	510503
	1995.02-2006.05		Centre	Chassis cabin RWD 111979NGT/111984NGT		Center Bearing Support Kit	531028S
	1995.02-2006.05		Centre	VAN RWD 111979NGT/111984NGT		Center Bearing Support Kit	531028S
Sprinter 214D							
2.2 (105 kw)	2016.04-	AT	Rear	BUS RWD 651955/651956		Propshaft	PS900367
	2016.04-	AT	Rear	Chassis cabin RWD 651955/651956		Propshaft	PS900367
	2016.04-		Front;Rear	BUS RWD 651955/651956		Center Bearing Support	514807
	2016.04-		Front;Rear	Chassis cabin RWD 651955/651956		Center Bearing Support	514807
	2016.04-		Centre	BUS RWD 651955/651956		Center Bearing Support Kit	514795S



	 YEAR	TRANSM.	FITTING POSITION	BODY STYLE & DRIVE TYPE & ENGINE	REMARKS	 PRODUCT	GSP Ref.
MERCEDES-BENZ							
Sprinter 214D							
2.2 (105 kw)	2016.04-		Centre	Chassis cabin RWD 651955/651956		Center Bearing Support Kit	514795S
	2016.05-	6MT	Front	VAN RWD 651955	Date From:2016.09,Trans. code:TSG 360,Chassis no. from:P333970	Propshaft	PS900609
	2016.05-	6MT	Rear	VAN RWD 651955	Trans. code:NSG 370	Propshaft	PS900368
	2016.05-	6MT	Rear	VAN RWD 651955	Trans. code:ZF 6S-450	Propshaft	PS900558
	2016.05-	AT	Rear	VAN RWD 651955		Propshaft	PS900367
	2016.05-		Front;Rear	VAN RWD 651955		Center Bearing Support	514807
2016.05-		Centre	VAN RWD 651955		Center Bearing Support Kit	514795S	
Sprinter 215D							
2.2 (110 kw)	2006.06-	MT	Front	Chassis cabin RWD 646986/646989/646990	Chassis no. to:N478535/E057183	Propshaft	PS900365
	2006.06-	6MT	Rear	BUS RWD 646986/646989/646990	Trans. code:TSG 360	Propshaft	PS900550
	2006.06-	6MT	Rear	Chassis cabin RWD 646986/646989/646990	Trans. code:TSG 360	Propshaft	PS900550
	2006.06-	6MT	Rear	VAN RWD 646986/646989/646990	Trans. code:TSG 360	Propshaft	PS900550
	2006.06-	AT	Rear	BUS RWD 646986/646989/646990		Propshaft	PS900367
	2006.06-	AT	Rear	Chassis cabin RWD 646986/646989/646990		Propshaft	PS900367
	2006.06-	AT	Rear	VAN RWD 646986/646989/646990		Propshaft	PS900367
	2006.06-		Front;Rear	BUS RWD 646986/646989/646990		Center Bearing Support	514807
	2006.06-		Front;Rear	Chassis cabin RWD 646986/646989/646990		Center Bearing Support	514807
	2006.06-		Front;Rear	VAN RWD 646986/646989/646990		Center Bearing Support	514807
	2006.06-		Centre	BUS RWD 646986/646989/646990		Center Bearing Support Kit	514795S
	2006.06-		Centre	Chassis cabin RWD 646986/646989/646990		Center Bearing Support Kit	514795S
	2006.06-		Centre	VAN RWD 646986/646989/646990		Center Bearing Support Kit	514795S
	2006.06-		Front;Rear	BUS RWD 646986/646989/646990		Flexible Coupling	533884
	2006.06-		Front;Rear	Chassis cabin RWD 646986/646989/646990		Flexible Coupling	533884
	2006.06-		Front;Rear	VAN RWD 646986/646989/646990		Flexible Coupling	533884
	2006.06-		Front;Rear	BUS RWD 646986/646989/646990		Flexible Coupling Kit	537832S
	2006.06-		Front;Rear	Chassis cabin RWD 646986/646989/646990		Flexible Coupling Kit	537832S
2006.06-		Front;Rear	VAN RWD 646986/646989/646990		Flexible Coupling Kit	537832S	
Sprinter 216							
1.8 (115 kw)	2008.09-		Front;Rear	Chassis cabin RWD 271951		Center Bearing Support	514807
	2008.09-		Front;Rear	VAN RWD 271951		Center Bearing Support	514807
	2008.09-		Centre	Chassis cabin RWD 271951		Center Bearing Support Kit	514795S
	2008.09-		Centre	VAN RWD 271951		Center Bearing Support Kit	514795S
	2009.03-		Front;Rear	BUS RWD 271951		Center Bearing Support	514807
	2009.03-		Centre	BUS RWD 271951		Center Bearing Support Kit	514795S
Sprinter 216D							
2.2 (120 kw)	2009.03-	6MT	-	VAN RWD 651955/651956/651957	Trans. code:TSG 360	Propshaft	PS900380
	2009.03-	6MT	-	Chassis cabin RWD 651955/651956/651957	Trans. code:TSG 360	Propshaft	PS900380
	2009.03-	AT	-	VAN RWD 651955/651956/651957	Chassis no. from:56829,from 573459	Propshaft	PS900378
	2009.03-	AT	-	Chassis cabin RWD 651955/651956/651957	Chassis no. from:56829,from 573459	Propshaft	PS900378
	2009.03-		Front;Rear	VAN RWD 651955/651956/651957		Center Bearing Support	514807
	2009.03-		Front;Rear	Chassis cabin RWD 651955/651956/651957		Center Bearing Support	514807
	2009.03-		Rear	VAN RWD 651955/651956/651957		Center Bearing Support Kit	531020S
	2009.03-		Rear	Chassis cabin RWD 651955/651956/651957		Center Bearing Support Kit	531020S
	2009.03-		Centre	VAN RWD 651955/651956/651957		Center Bearing Support Kit	514795S
	2009.03-		Centre	Chassis cabin RWD 651955/651956/651957		Center Bearing Support Kit	514795S
	2009.03-		Front;Rear	VAN RWD 651955/651956/651957		Flexible Coupling	533884
	2009.03-		Front;Rear	Chassis cabin RWD 651955/651956/651957		Flexible Coupling	533884
	2009.03-		Front;Rear	VAN RWD 651955/651956/651957		Flexible Coupling Kit	537832S
	2009.03-		Front;Rear	Chassis cabin RWD 651955/651956/651957		Flexible Coupling Kit	537832S
	2009.06-	6MT	-	BUS RWD 651955/651956/651957	Trans. code:TSG 360,Date From:2009.06	Propshaft	PS900380
	2009.06-	AT	-	BUS RWD 651955/651956/651957	Date From:2009.06,Chassis no. from:56829,from 573459	Propshaft	PS900378
	2009.06-		Front;Rear	BUS RWD 651955/651956/651957		Center Bearing Support	514807
	2009.06-		Rear	BUS RWD 651955/651956/651957		Center Bearing Support Kit	531020S
	2009.06-		Centre	BUS RWD 651955/651956/651957		Center Bearing Support Kit	514795S
	2009.06-		Front;Rear	BUS RWD 651955/651956/651957		Flexible Coupling	533884
2009.06-		Front;Rear	BUS RWD 651955/651956/651957		Flexible Coupling Kit	537832S	
2.7 (115 kw)	2000.04-2006.05		Centre	BUS RWD 612981		Center Bearing Support	510503
	2000.04-2006.05		Centre	Chassis cabin RWD 612981		Center Bearing Support	510503
	2000.04-2006.05		Centre	VAN RWD 612981		Center Bearing Support	510503
	2000.04-2006.05		Centre	BUS RWD 612981		Center Bearing Support Kit	531028S
	2000.04-2006.05		Centre	Chassis cabin RWD 612981		Center Bearing Support Kit	531028S
	2000.04-2006.05		Centre	VAN RWD 612981		Center Bearing Support Kit	531028S







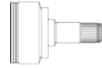

	 YEAR	TRANSM.	FITTING POSITION	BODY STYLE & DRIVE TYPE & ENGINE	REMARKS	 PRODUCT	GSP Ref.
MERCEDES-BENZ							
Sprinter 218D							
3.0 (135 kw)	2006.06-	AT	Rear	Chassis cabin RWD 642896/642992/642993		Propshaft	PS900369
	2006.06-	AT	Rear	VAN RWD 642896/642992		Propshaft	PS900369
	2006.06-		Front;Rear	Chassis cabin RWD 642896/642992/642993		Center Bearing Support	514807
	2006.06-		Front;Rear	VAN RWD 642896/642992		Center Bearing Support	514807
	2006.06-		Centre	Chassis cabin RWD 642896/642992/642993		Center Bearing Support Kit	514795S
	2006.06-		Centre	VAN RWD 642896/642992		Center Bearing Support Kit	514795S
	2006.06-		Front;Rear	Chassis cabin RWD 642896/642992/642993		Flexible Coupling	533884
	2006.06-		Front;Rear	VAN RWD 642896/642992		Flexible Coupling	533884
	2006.06-		Front;Rear	Chassis cabin RWD 642896/642992/642993		Flexible Coupling Kit	537832S
2006.06-		Front;Rear	VAN RWD 642896/642992		Flexible Coupling Kit	537832S	
Sprinter 219D							
3.0 (140 kw)	2009.03-	AT	Rear	VAN RWD 642896/642992		Propshaft	PS900369
	2009.03-		Front;Rear	VAN RWD 642896/642992		Center Bearing Support	514807
	2009.03-		Front;Rear	Chassis cabin RWD 642896/642992		Center Bearing Support	514807
	2009.03-		Centre	VAN RWD 642896/642992		Center Bearing Support Kit	514795S
	2009.03-		Centre	Chassis cabin RWD 642896/642992		Center Bearing Support Kit	514795S
	2009.03-		Front;Rear	VAN RWD 642896/642992		Flexible Coupling	533884
	2009.03-		Front;Rear	Chassis cabin RWD 642896/642992		Flexible Coupling	533884
	2009.03-		Front;Rear	VAN RWD 642896/642992		Flexible Coupling Kit	537832S
	2009.03-		Front;Rear	Chassis cabin RWD 642896/642992		Flexible Coupling Kit	537832S
Sprinter 224							
3.5 (190 kw)	2006.06-		Front;Rear	BUS RWD 272979		Center Bearing Support	514807
	2006.06-		Front;Rear	Chassis cabin RWD 272979		Center Bearing Support	514807
	2006.06-		Front;Rear	VAN RWD 272979		Center Bearing Support	514807
	2006.06-		Centre	BUS RWD 272979		Center Bearing Support Kit	514795S
	2006.06-		Centre	Chassis cabin RWD 272979		Center Bearing Support Kit	514795S
	2006.06-		Centre	VAN RWD 272979		Center Bearing Support Kit	514795S
	2006.06-		Front;Rear	BUS RWD 272979		Flexible Coupling	533884
	2006.06-		Front;Rear	Chassis cabin RWD 272979		Flexible Coupling	533884
	2006.06-		Front;Rear	VAN RWD 272979		Flexible Coupling	533884
	2006.06-		Front;Rear	BUS RWD 272979		Flexible Coupling Kit	537832S
	2006.06-		Front;Rear	Chassis cabin RWD 272979		Flexible Coupling Kit	537832S
	2006.06-		Front;Rear	VAN RWD 272979		Flexible Coupling Kit	537832S
Sprinter 308D							
2.2 (60 kw)	1999.09-2006.05	MT	-	Chassis cabin RWD 611987		Propshaft	PS900373
	1999.09-2006.05		Centre	Chassis cabin RWD 611987		Center Bearing Support	510503
	1999.09-2006.05		Centre	Chassis cabin RWD 611987		Center Bearing Support Kit	531028S
	2000.04-2006.05	MT	-	BUS RWD 611987		Propshaft	PS900373
	2000.04-2006.05	MT	-	VAN RWD 611987		Propshaft	PS900373
	2000.04-2006.05		Centre	BUS RWD 611987		Center Bearing Support	510503
	2000.04-2006.05		Centre	VAN RWD 611987		Center Bearing Support	510503
	2000.04-2006.05		Centre	BUS RWD 611987		Center Bearing Support Kit	531028S
	2000.04-2006.05		Centre	VAN RWD 611987		Center Bearing Support Kit	531028S
2.3 (58 kw)	1995.02-2000.04		Centre	BUS RWD 601943		Center Bearing Support	510503
	1995.02-2000.04		Centre	VAN RWD 601943		Center Bearing Support	510503
	1995.02-2000.04		Centre	BUS RWD 601943		Center Bearing Support Kit	531028S
	1995.02-2000.04		Centre	VAN RWD 601943		Center Bearing Support Kit	531028S
	1995.04-2000.04		Centre	Chassis cabin RWD 601943		Center Bearing Support	510503
	1995.04-2000.04		Centre	Chassis cabin RWD 601943		Center Bearing Support Kit	531028S
2.3 (60 kw)	1995.02-2000.04		Centre	VAN RWD 601943		Center Bearing Support	510503
	1995.02-2000.04		Centre	VAN RWD 601943		Center Bearing Support Kit	531028S
	1996.11-2000.04		Centre	Chassis cabin RWD 601943		Center Bearing Support	510503
	1996.11-2000.04		Centre	Chassis cabin RWD 601943		Center Bearing Support Kit	531028S
	1997.03-2000.04		Centre	BUS RWD 601943		Center Bearing Support Kit	531028S
Sprinter 309D							
2.2 (65 kw)	2006.06-	MT	Front	Chassis cabin RWD 646984	Chassis no. to:N478535/E057183	Propshaft	PS900365
	2006.06-	MT	Front	VAN RWD 646984	Chassis no. to:N478535/E057183	Propshaft	PS900365
	2006.06-	6MT	Rear	Chassis cabin RWD 646984	Trans. code:NSG 370	Propshaft	PS900368
	2006.06-	6MT	Rear	VAN RWD 646984	Trans. code:NSG 370	Propshaft	PS900368
	2006.06-	6MT	Rear	Chassis cabin RWD 646984	Trans. code:TSG 360	Propshaft	PS900550
	2006.06-	6MT	Rear	VAN RWD 646984	Trans. code:TSG 360	Propshaft	PS900550
	2006.06-	6MT	Rear	Chassis cabin RWD 646984	Trans. code:ZF 6S-450	Propshaft	PS900558
	2006.06-	6MT	Rear	VAN RWD 646984	Trans. code:ZF 6S-450	Propshaft	PS900558
	2006.06-	AT	Rear	VAN RWD 646984		Propshaft	PS900367



	 YEAR	TRANSM.	FITTING POSITION	BODY STYLE & DRIVE TYPE & ENGINE	REMARKS	 PRODUCT	GSP Ref.
MERCEDES-BENZ							
Sprinter 309D							
2.2 (65 kw)							
	2006.06-		Front	Chassis cabin RWD 646984		Center Bearing Support	531053
	2006.06-		Front;Rear	Chassis cabin RWD 646984		Center Bearing Support	514807
	2006.06-		Front;Rear	VAN RWD 646984		Center Bearing Support	514807
	2006.06-		Front	Chassis cabin RWD 646984		Center Bearing Support Kit	531021S
	2006.06-		Centre	Chassis cabin RWD 646984		Center Bearing Support Kit	514795S
	2006.06-		Centre	VAN RWD 646984		Center Bearing Support Kit	514795S
	2006.06-		Front;Rear	Chassis cabin RWD 646984		Flexible Coupling	533884
	2006.06-		Front;Rear	VAN RWD 646984		Flexible Coupling	533884
	2006.06-		Front;Rear	Chassis cabin RWD 646984		Flexible Coupling Kit	537832S
	2006.06-		Front;Rear	VAN RWD 646984		Flexible Coupling Kit	537832S
Sprinter 310D							
2.2 (70 kw)							
	2009.03-	6MT	Rear	BUS RWD 651955/651956	Trans. code:NSG 370	Propshaft	PS900368
	2009.03-	6MT	Rear	BUS RWD 651955/651956	Trans.code:NSG 370	Propshaft	PS900368
	2009.03-	6MT	Rear	VAN RWD 651955/651956	Trans. code:NSG 370	Propshaft	PS900368
	2009.03-	6MT	Rear	Chassis cabin RWD 651955/651956	Trans. code:NSG 370	Propshaft	PS900368
	2009.03-	6MT	Rear	BUS RWD 651955/651956	Trans. code:TSG 360	Propshaft	PS900550
	2009.03-	6MT	Rear	BUS RWD 651955/651956	Trans.code:TSG 360	Propshaft	PS900550
	2009.03-	6MT	Rear	VAN RWD 651955/651956	Trans. code:TSG 360	Propshaft	PS900550
	2009.03-	6MT	Rear	Chassis cabin RWD 651955/651956	Trans. code:TSG 360	Propshaft	PS900550
	2009.03-	6MT	Rear	BUS RWD 651955/651956	Trans. code:ZF 6S-450	Propshaft	PS900558
	2009.03-	6MT	Rear	BUS RWD 651955/651956	Trans.code:ZF 6S-450	Propshaft	PS900558
	2009.03-	6MT	Rear	VAN RWD 651955/651956	Trans. code:ZF 6S-450	Propshaft	PS900558
	2009.03-	6MT	Rear	Chassis cabin RWD 651955/651956	Trans. code:ZF 6S-450	Propshaft	PS900558
	2009.03-	AT	Rear	BUS RWD 651955/651956		Propshaft	PS900367
	2009.03-	AT	Rear	VAN RWD 651955/651956		Propshaft	PS900367
	2009.03-	AT	Rear	Chassis cabin RWD 651955/651956		Propshaft	PS900367
	2009.03-	AT	Rear	BUS RWD 651955/651956	Date From:2011.04,Chassis no. from:56829	Propshaft	PS900559
	2009.03-	AT	Rear	VAN RWD 651955/651956	Date From:2011.04,Chassis no. from:56829	Propshaft	PS900559
	2009.03-	AT	Rear	Chassis cabin RWD 651955/651956	Date From:2011.04,Chassis no. from:56829	Propshaft	PS900559
	2009.03-		Front	Chassis cabin RWD 651955/651956		Center Bearing Support	531053
	2009.03-		Front;Rear	BUS RWD 651955/651956		Center Bearing Support	514807
	2009.03-		Front;Rear	VAN RWD 651955/651956		Center Bearing Support	514807
	2009.03-		Front;Rear	Chassis cabin RWD 651955/651956		Center Bearing Support	514807
	2009.03-		Front	Chassis cabin RWD 651955/651956		Center Bearing Support Kit	531021S
	2009.03-		Centre	BUS RWD 651955/651956		Center Bearing Support Kit	514795S
	2009.03-		Centre	VAN RWD 651955/651956		Center Bearing Support Kit	514795S
	2009.03-		Centre	Chassis cabin RWD 651955/651956		Center Bearing Support Kit	514795S
	2009.03-		Front;Rear	BUS RWD 651955/651956		Flexible Coupling	533884
	2009.03-		Front;Rear	VAN RWD 651955/651956		Flexible Coupling	533884
	2009.03-		Front;Rear	Chassis cabin RWD 651955/651956		Flexible Coupling	533884
	2009.03-		Front;Rear	BUS RWD 651955/651956		Flexible Coupling Kit	537832S
	2009.03-		Front;Rear	VAN RWD 651955/651956		Flexible Coupling Kit	537832S
	2009.03-		Front;Rear	Chassis cabin RWD 651955/651956		Flexible Coupling Kit	537832S
2.9 (75 kw)							
	1995.02-2000.08		Centre	VAN RWD 602980		Center Bearing Support	510503
	1995.02-2000.08		Centre	VAN RWD 602980		Center Bearing Support Kit	531028S
	1997.01-1999.12		Centre	BUS RWD 602980		Center Bearing Support	510503
	1997.01-1999.12		Centre	BUS RWD 602980		Center Bearing Support Kit	531028S
	1997.01-2000.08		Centre	Chassis cabin RWD 602980		Center Bearing Support	510503
	1997.01-2000.08		Centre	Chassis cabin RWD 602980		Center Bearing Support Kit	531028S
	1997.06-2000.04		Centre	VAN 4WD 602980		Center Bearing Support	510503
	1997.06-2000.04		Centre	VAN 4WD 602980		Center Bearing Support Kit	531028S
	1997.06-2002.08		Centre	BUS 4WD 602980		Center Bearing Support Kit	531028S
Sprinter 311D							
2.2 (80 kw)							
	2000.04-2006.05	MT	-	BUS RWD 611981		Propshaft	PS900373
	2000.04-2006.05	MT	-	VAN RWD 611981		Propshaft	PS900373
	2000.04-2006.05		Centre	BUS RWD 611981		Center Bearing Support	510503
	2000.04-2006.05		Centre	Chassis cabin 4WD 611981		Center Bearing Support	510503
	2000.04-2006.05		Centre	VAN RWD 611981		Center Bearing Support	510503
	2000.04-2006.05		Centre	BUS RWD 611981		Center Bearing Support Kit	531028S
	2000.04-2006.05		Centre	Chassis cabin 4WD 611981		Center Bearing Support Kit	531028S
	2000.04-2006.05		Centre	VAN RWD 611981		Center Bearing Support Kit	531028S
	2000.04-2006.12	MT	-	Chassis cabin RWD 611981		Propshaft	PS900373
	2000.04-2006.12		Centre	Chassis cabin RWD 611981		Center Bearing Support	510503
	2000.04-2006.12		Centre	Chassis cabin RWD 611981		Center Bearing Support Kit	531028S



	 YEAR	TRANSM.	FITTING POSITION	BODY STYLE & DRIVE TYPE & ENGINE	REMARKS	 PRODUCT	GSP Ref.
MERCEDES-BENZ Sprinter 311D							
2.2 (80 kw)	2002.08-2006.05		Centre	BUS 4WD 611981		Center Bearing Support	510503
	2002.08-2006.05		Centre	VAN 4WD 611981		Center Bearing Support	510503
	2002.08-2006.05		Centre	BUS 4WD 611981		Center Bearing Support Kit	531028S
	2002.08-2006.05		Centre	VAN 4WD 611981		Center Bearing Support Kit	531028S
	2006.06-	MT	Front	BUS RWD 646985	Chassis no. to:N478535/E057183	Propshaft	PS900365
	2006.06-	MT	Front	Chassis cabin RWD 646985	Chassis no. to:N478535/E057183	Propshaft	PS900365
	2006.06-	MT	Front	VAN RWD 646985	Chassis no. to:N478535/E057183	Propshaft	PS900365
	2006.06-	6MT	Rear	BUS RWD 646985	Trans. code:NSG 370	Propshaft	PS900368
	2006.06-	6MT	Rear	Chassis cabin RWD 646985	Trans. code:NSG 370	Propshaft	PS900368
	2006.06-	6MT	Rear	VAN RWD 646985	Trans. code:NSG 370	Propshaft	PS900368
	2006.06-	6MT	Rear	BUS RWD 646985	Trans. code:TSG 360	Propshaft	PS900550
	2006.06-	6MT	Rear	Chassis cabin RWD 646985	Trans. code:TSG 360	Propshaft	PS900550
	2006.06-	6MT	Rear	VAN RWD 646985	Trans. code:TSG 360	Propshaft	PS900550
	2006.06-	6MT	Rear	BUS RWD 646985	Trans. code:ZF 6S-450	Propshaft	PS900558
	2006.06-	6MT	Rear	Chassis cabin RWD 646985	Trans. code:ZF 6S-450	Propshaft	PS900558
	2006.06-	6MT	Rear	VAN RWD 646985	Trans. code:ZF 6S-450	Propshaft	PS900558
	2006.06-	AT	Rear	BUS RWD 646985		Propshaft	PS900367
	2006.06-	AT	Rear	Chassis cabin RWD 646985		Propshaft	PS900367
	2006.06-	AT	Rear	VAN RWD 646985		Propshaft	PS900367
	2006.06-		Front	Chassis cabin RWD 646985		Center Bearing Support	531053
	2006.06-		Front	VAN RWD 646985		Center Bearing Support	531053
	2006.06-		Front;Rear	BUS RWD 646985		Center Bearing Support	514807
	2006.06-		Front;Rear	Chassis cabin RWD 646985		Center Bearing Support	514807
	2006.06-		Front;Rear	VAN RWD 646985		Center Bearing Support	514807
	2006.06-		Front	Chassis cabin RWD 646985		Center Bearing Support Kit	531021S
	2006.06-		Centre	BUS RWD 646985		Center Bearing Support Kit	514795S
	2006.06-		Centre	Chassis cabin RWD 646985		Center Bearing Support Kit	514795S
	2006.06-		Centre	VAN RWD 646985		Center Bearing Support Kit	514795S
	2006.06-		Front;Rear	BUS RWD 646985		Flexible Coupling	533884
	2006.06-		Front;Rear	Chassis cabin RWD 646985		Flexible Coupling	533884
	2006.06-		Front;Rear	VAN RWD 646985		Flexible Coupling	533884
	2006.06-		Front;Rear	BUS RWD 646985		Flexible Coupling Kit	537832S
	2006.06-		Front;Rear	Chassis cabin RWD 646985		Flexible Coupling Kit	537832S
	2006.06-		Front;Rear	VAN RWD 646985		Flexible Coupling Kit	537832S
	2008.02-		Front;Rear	BUS 4WD 646985		Center Bearing Support	514807
	2008.02-		Front;Rear	Chassis cabin 4WD 646985		Center Bearing Support	514807
	2008.02-		Front;Rear	VAN 4WD 646985		Center Bearing Support	514807
	2008.02-		Centre	BUS 4WD 646985		Center Bearing Support Kit	514795S
	2008.02-		Centre	Chassis cabin 4WD 646985		Center Bearing Support Kit	514795S
	2008.02-		Centre	VAN 4WD 646985		Center Bearing Support Kit	514795S
	2008.02-		Front;Rear	BUS 4WD 646985		Flexible Coupling	533884
	2008.02-		Front;Rear	Chassis cabin 4WD 646985		Flexible Coupling	533884
	2008.02-		Front;Rear	VAN 4WD 646985		Flexible Coupling	533884
	2008.02-		Front;Rear	BUS 4WD 646985		Flexible Coupling Kit	537832S
	2008.02-		Front;Rear	Chassis cabin 4WD 646985		Flexible Coupling Kit	537832S
	2008.02-		Front;Rear	VAN 4WD 646985		Flexible Coupling Kit	537832S
2.2 (84 kw)	2016.04-	6MT	Front	VAN RWD 651955/651956	Date:From:2016.09;Trans. code:TSG 360;Chassis no. from:P333970	Propshaft	PS900609
	2016.04-	AT	Front	BUS RWD 651955/651956	Date:From:2016.09;Trans. code:TSG 360;Chassis no. from:P333970	Propshaft	PS900609
	2016.04-	6MT	Rear	BUS RWD 651955/651956	Trans. code:NSG 370	Propshaft	PS900368
	2016.04-	6MT	Rear	Chassis cabin RWD 651955/651956	Trans. code:NSG 370	Propshaft	PS900368
	2016.04-	6MT	Rear	VAN RWD 651955/651956	Trans. code:NSG 370	Propshaft	PS900368
	2016.04-	6MT	Rear	BUS RWD 651955/651956	Trans. code:ZF 6S-450	Propshaft	PS900558
	2016.04-	6MT	Rear	Chassis cabin RWD 651955/651956	Trans. code:ZF 6S-450	Propshaft	PS900558
	2016.04-	6MT	Rear	VAN RWD 651955/651956	Trans. code:ZF 6S-450	Propshaft	PS900558
	2016.04-	AT	Rear	BUS RWD 651955/651956		Propshaft	PS900367
	2016.04-	AT	Rear	Chassis cabin RWD 651955/651956		Propshaft	PS900367
	2016.04-	AT	Rear	VAN RWD 651955/651956		Propshaft	PS900367
	2016.04-		Front;Rear	BUS RWD 651955/651956		Center Bearing Support	514807
	2016.04-		Front;Rear	Chassis cabin RWD 651955/651956		Center Bearing Support	514807
	2016.04-		Front;Rear	VAN RWD 651955/651956		Center Bearing Support	514807
	2016.04-		Centre	BUS RWD 651955/651956		Center Bearing Support Kit	514795S
	2016.04-		Centre	Chassis cabin RWD 651955/651956		Center Bearing Support Kit	514795S
	2016.04-		Centre	VAN RWD 651955/651956		Center Bearing Support Kit	514795S



	 YEAR	TRANSM.	FITTING POSITION	BODY STYLE & DRIVE TYPE & ENGINE	REMARKS	 PRODUCT	GSP Ref.	
MERCEDES-BENZ								
Sprinter 312D								
2.9 (85 kw)	1998.12-2001.09		Centre	Chassis cabin RWD 602980		Center Bearing Support	510503	
	1998.12-2001.09		Centre	Chassis cabin RWD 602980		Center Bearing Support Kit	531028S	
2.9 (90 kw)	1995.02-2000.04		Centre	VAN RWD 602980		Center Bearing Support	510503	
	1995.02-2000.04		Centre	VAN RWD 602980		Center Bearing Support Kit	531028S	
	1995.02-2000.08		Centre	Chassis cabin RWD 602980		Center Bearing Support	510503	
	1995.02-2000.08		Centre	BUS RWD 602980		Center Bearing Support Kit	531028S	
	1995.02-2000.08		Centre	Chassis cabin RWD 602980		Center Bearing Support Kit	531028S	
	1997.05-2000.04		Centre	VAN 4WD 602980		Center Bearing Support Kit	531028S	
	1997.05-2002.08		Centre	BUS 4WD 602980		Center Bearing Support Kit	531028S	
Sprinter 313D								
2.2 (95 kw)	2000.04-2006.05	MT	-	BUS RWD 611981		Propshaft	PS900373	
	2000.04-2006.05	MT	-	VAN RWD 611981		Propshaft	PS900373	
	2000.04-2006.05	MT	-	Chassis cabin RWD 611981		Propshaft	PS900373	
	2000.04-2006.05		Centre	BUS RWD 611981		Center Bearing Support	510503	
	2000.04-2006.05		Centre	Chassis cabin 4WD 611981		Center Bearing Support	510503	
	2000.04-2006.05		Centre	VAN RWD 611981		Center Bearing Support	510503	
	2000.04-2006.05		Centre	Chassis cabin RWD 611981		Center Bearing Support	510503	
	2000.04-2006.05		Centre	BUS RWD 611981		Center Bearing Support Kit	531028S	
	2000.04-2006.05		Centre	Chassis cabin 4WD 611981		Center Bearing Support Kit	531028S	
	2000.04-2006.05		Centre	VAN RWD 611981		Center Bearing Support Kit	531028S	
	2000.04-2006.05		Centre	Chassis cabin RWD 611981		Center Bearing Support Kit	531028S	
	2002.08-2006.05		Centre	BUS 4WD 611981		Center Bearing Support	510503	
	2002.08-2006.05		Centre	VAN 4WD 611981		Center Bearing Support	510503	
	2002.08-2006.05		Centre	BUS 4WD 611981		Center Bearing Support Kit	531028S	
	2002.08-2006.05		Centre	VAN 4WD 611981		Center Bearing Support Kit	531028S	
	2006.06-	MT	Front		Chassis cabin RWD 646986	Chassis no. to:N478535/E057183	Propshaft	PS900365
	2006.06-	MT	Front		VAN RWD 646986	Chassis no. to:N478535/E057183	Propshaft	PS900365
	2006.06-	6MT	Rear		Chassis cabin RWD 646986	Trans. code:NSG 370	Propshaft	PS900368
	2006.06-	6MT	Rear		VAN RWD 646986	Trans. code:NSG 370	Propshaft	PS900368
	2006.06-	6MT	Rear		Chassis cabin RWD 651955/651956	Trans. code:NSG 370	Propshaft	PS900368
	2006.06-	6MT	Rear		Chassis cabin RWD 646986	Trans. code:TSG 360	Propshaft	PS900550
	2006.06-	6MT	Rear		VAN RWD 646986	Trans. code:TSG 360	Propshaft	PS900550
	2006.06-	6MT	Rear		Chassis cabin RWD 651955/651956	Trans. code:TSG 360	Propshaft	PS900550
	2006.06-	6MT	Rear		Chassis cabin RWD 646986	Trans. code:ZF 6S-450	Propshaft	PS900558
	2006.06-	6MT	Rear		VAN RWD 646986	Trans. code:ZF 6S-450	Propshaft	PS900558
	2006.06-	6MT	Rear		Chassis cabin RWD 651955/651956	Trans. code:ZF 6S-450	Propshaft	PS900558
	2006.06-	AT	Rear		Chassis cabin RWD 646986		Propshaft	PS900367
	2006.06-	AT	Rear		VAN RWD 646986		Propshaft	PS900367
	2006.06-	AT	Rear		Chassis cabin RWD 651955/651956		Propshaft	PS900367
	2006.06-	AT	Rear		Chassis cabin RWD 646986	Date From:2011.04,Chassis no. from:56829	Propshaft	PS900559
	2006.06-	AT	Rear		VAN RWD 646986	Date From:2011.04,Chassis no. from:56829	Propshaft	PS900559
	2006.06-		Rear		Chassis cabin RWD 651955/651956	Date From:2011.04,Chassis no. from:56829	Propshaft	PS900559
	2006.06-		Front;Rear		Chassis cabin RWD 646986		Center Bearing Support	514807
	2006.06-		Front;Rear		VAN RWD 646986		Center Bearing Support	514807
	2006.06-		Front;Rear		Chassis cabin RWD 651955/651956		Center Bearing Support	514807
	2006.06-		Front;Rear		Chassis cabin 4WD 651955/651956/651957		Center Bearing Support	514807
	2006.06-		Centre		Chassis cabin RWD 646986		Center Bearing Support Kit	514795S
	2006.06-		Centre		VAN RWD 646986		Center Bearing Support Kit	514795S
	2006.06-		Centre		Chassis cabin RWD 651955/651956		Center Bearing Support Kit	514795S
	2006.06-		Centre		Chassis cabin 4WD 651955/651956/651957		Center Bearing Support Kit	514795S
	2006.06-		Front;Rear		Chassis cabin RWD 646986		Flexible Coupling	533884
	2006.06-		Front;Rear		VAN RWD 646986		Flexible Coupling	533884
	2006.06-		Front;Rear		Chassis cabin RWD 651955/651956		Flexible Coupling	533884
	2006.06-		Rear		Chassis cabin 4WD 651955/651956/651957		Flexible Coupling Kit	537832S
	2006.06-		Front;Rear		Chassis cabin RWD 646986		Flexible Coupling Kit	537832S
	2006.06-		Front;Rear		VAN RWD 646986		Flexible Coupling Kit	537832S
	2006.06-		Front;Rear		Chassis cabin RWD 651955/651956		Flexible Coupling Kit	537832S
	2009.03-	6MT	Rear		VAN RWD 651955/651956	Trans. code:NSG 370	Propshaft	PS900368
	2009.03-	6MT	Rear		VAN RWD 651955/651956	Trans. code:TSG 360	Propshaft	PS900550
	2009.03-	6MT	Rear		VAN RWD 651955/651956	Trans. code:ZF 6S-450	Propshaft	PS900558
	2009.03-	AT	Rear		VAN RWD 651955/651956		Propshaft	PS900367
	2009.03-	AT	Rear		VAN RWD 651955/651956	Date From:2011.04,Chassis no. from:56829	Propshaft	PS900559
	2009.03-		Front;Rear		VAN RWD 651955/651956		Center Bearing Support	514807
2009.03-		Front;Rear		VAN 4WD 651955/651957		Center Bearing Support	514807	



	 YEAR	TRANSM.	FITTING POSITION	BODY STYLE & DRIVE TYPE & ENGINE	REMARKS	 PRODUCT	GSP Ref.
MERCEDES-BENZ							
Sprinter 313D							
2.2 (95 kw)							
	2009.03-		Centre	VAN RWD 651955/651956		Center Bearing Support Kit	514795S
	2009.03-		Centre	VAN 4WD 651955/651957		Center Bearing Support Kit	514795S
	2009.03-		Rear	VAN RWD 651955/651956		Flexible Coupling Kit	537832S
	2009.03-		Rear	VAN 4WD 651955/651957		Flexible Coupling Kit	537832S
	2011.08-	6MT	Rear	BUS RWD 651955/651956/651957	Trans. code:NSG 370	Propshaft	PS900368
	2011.08-	6MT	Rear	BUS RWD 651955/651956/651957	Trans. code:TSG 360	Propshaft	PS900550
	2011.08-	6MT	Rear	BUS RWD 651955/651956/651957	Trans. code:ZF 6S-450	Propshaft	PS900558
	2011.08-	AT	Rear	BUS RWD 651955/651956/651957	for OE No.:A9064107516	Propshaft	PS900367
	2011.08-	AT	Rear	BUS RWD 651955/651956/651957		Propshaft	PS900559
	2011.08-		Front;Rear	BUS 4WD 651955/651956/651957		Center Bearing Support	514807
	2011.08-		Front;Rear	BUS RWD 651955/651956/651957		Center Bearing Support	514807
	2011.08-		Centre	BUS 4WD 651955/651956/651957		Center Bearing Support Kit	514795S
	2011.08-		Centre	BUS RWD 651955/651956/651957		Center Bearing Support Kit	514795S
	2011.08-		Front;Rear	BUS 4WD 651955/651956/651957		Flexible Coupling	533884
	2011.08-		Front;Rear	BUS RWD 651955/651956/651957		Flexible Coupling	533884
	2011.08-		Front;Rear	BUS 4WD 651955/651956/651957		Flexible Coupling Kit	537832S
	2011.08-		Front;Rear	BUS RWD 651955/651956/651957		Flexible Coupling Kit	537832S
Sprinter 314							
2.3 (105 kw)							
	1995.02-2006.05		Front	Chassis cabin RWD 111979/111984		Propshaft	PS900568
	1995.02-2006.05		Centre	BUS RWD 111979/111984		Center Bearing Support	510503
	1995.02-2006.05		Centre	Chassis cabin RWD 111979/111984		Center Bearing Support	510503
	1995.02-2006.05		Centre	VAN RWD 111979/111984		Center Bearing Support	510503
	1995.02-2006.05		Centre	BUS RWD 111979/111984		Center Bearing Support Kit	531028S
	1995.02-2006.05		Centre	Chassis cabin RWD 111979/111984		Center Bearing Support Kit	531028S
	1995.02-2006.05		Centre	VAN RWD 111979/111984		Center Bearing Support Kit	531028S
	2000.04-2006.05		Centre	BUS 4WD 111984		Center Bearing Support	510503
	2000.04-2006.05		Centre	VAN 4WD 111984		Center Bearing Support	510503
	2000.04-2006.05		Centre	Chassis cabin 4WD 111984		Center Bearing Support	510503
	2000.04-2006.05		Centre	BUS 4WD 111984		Center Bearing Support Kit	531028S
	2000.04-2006.05		Centre	VAN 4WD 111984		Center Bearing Support Kit	531028S
	2000.04-2006.05		Centre	Chassis cabin 4WD 111984		Center Bearing Support Kit	531028S
Sprinter 314 NGT							
2.3 (95 kw)							
	1995.02-2006.05		Front	Chassis cabin RWD 111979NGT/111984NGT		Propshaft	PS900568
	1995.02-2006.05		Centre	BUS RWD 111979NGT/111984NGT		Center Bearing Support	510503
	1995.02-2006.05		Centre	Chassis cabin RWD 111979NGT/111984NGT		Center Bearing Support	510503
	1995.02-2006.05		Centre	VAN RWD 111979NGT/111984NGT		Center Bearing Support	510503
	1995.02-2006.05		Centre	BUS RWD 111979NGT/111984NGT		Center Bearing Support Kit	531028S
	1995.02-2006.05		Centre	Chassis cabin RWD 111979NGT/111984NGT		Center Bearing Support Kit	531028S
	1995.02-2006.05		Centre	VAN RWD 111979NGT/111984NGT		Center Bearing Support Kit	531028S
Sprinter 314D							
2.2 (105 kw)							
	2016.04-	6MT	Front	BUS RWD 651955/651956	Date:From:2016.09,Trans. code:1SG 360,Chassis no. from:P333970	Propshaft	PS900609
	2016.04-	6MT	Rear	BUS RWD 651955/651956	Trans. code:NSG 370	Propshaft	PS900368
	2016.04-	6MT	Rear	Chassis cabin RWD 651955/651956	Trans. code:NSG 370	Propshaft	PS900368
	2016.04-	6MT	Rear	BUS RWD 651955/651956	Trans. code:ZF 6S-450	Propshaft	PS900558
	2016.04-	6MT	Rear	Chassis cabin RWD 651955/651956	Trans. code:ZF 6S-450	Propshaft	PS900558
	2016.04-	AT	Rear	BUS RWD 651955/651956		Propshaft	PS900367
	2016.04-	AT	Rear	Chassis cabin RWD 651955/651956		Propshaft	PS900367
	2016.04-		Front;Rear	BUS RWD 651955/651956		Center Bearing Support	514807
	2016.04-		Front;Rear	Chassis cabin RWD 651955/651956		Center Bearing Support	514807
	2016.04-		Front;Rear	VAN 4WD 651955		Center Bearing Support	514807
	2016.04-		Centre	BUS RWD 651955/651956		Center Bearing Support Kit	514795S
	2016.04-		Centre	Chassis cabin RWD 651955/651956		Center Bearing Support Kit	514795S
	2016.04-		Centre	VAN 4WD 651955		Center Bearing Support Kit	514795S
	2016.05-	6MT	Front	VAN RWD 651955	Date:From:2016.09,Trans. code:1SG 360,Chassis no. from:P333970	Propshaft	PS900609
	2016.05-	6MT	Rear	VAN RWD 651955	Trans. code:NSG 370	Propshaft	PS900368
	2016.05-	6MT	Rear	VAN RWD 651955	Trans. code:ZF 6S-450	Propshaft	PS900558
	2016.05-	AT	Rear	VAN RWD 651955		Propshaft	PS900367
	2016.05-		Front;Rear	VAN RWD 651955		Center Bearing Support	514807
	2016.05-		Front;Rear	BUS 4WD 651955/651956		Center Bearing Support	514807
	2016.05-		Front;Rear	Chassis cabin 4WD 651955/651956		Center Bearing Support	514807
	2016.05-		Centre	VAN RWD 651955		Center Bearing Support Kit	514795S
	2016.05-		Centre	BUS 4WD 651955/651956		Center Bearing Support Kit	514795S
	2016.05-		Centre	Chassis cabin 4WD 651955/651956		Center Bearing Support Kit	514795S



	 YEAR	 TRANSM.	 FITTING POSITION	 BODY STYLE & DRIVE TYPE & ENGINE	 REMARKS	 PRODUCT	 GSP Ref.
MERCEDES-BENZ							
Sprinter 315D							
2.2 (110 kw)							
	2006.06-	MT	Front	BUS RWD 646986/646989/646990	Chassis no. to:N478535/E057183	Propshaft	PS900365
	2006.06-	MT	Front	Chassis cabin RWD 646986/646989/646990	Chassis no. to:N478535/E057183	Propshaft	PS900365
	2006.06-	MT	Front	VAN RWD 646986/646989/646990	Chassis no. to:N478535/E057183	Propshaft	PS900365
	2006.06-	6MT	Rear	BUS RWD 646986/646989/646990	Trans. code:NSG 370	Propshaft	PS900368
	2006.06-	6MT	Rear	Chassis cabin RWD 646986/646989/646990	Trans. code:NSG 370	Propshaft	PS900368
	2006.06-	6MT	Rear	VAN RWD 646986/646989/646990	Trans. code:NSG 370	Propshaft	PS900368
	2006.06-	6MT	Rear	BUS RWD 646986/646989/646990	Trans. code:TSG 360	Propshaft	PS900550
	2006.06-	6MT	Rear	Chassis cabin RWD 646986/646989/646990	Trans. code:TSG 360	Propshaft	PS900550
	2006.06-	6MT	Rear	VAN RWD 646986/646989/646990	Trans. code:TSG 360	Propshaft	PS900550
	2006.06-	6MT	Rear	BUS RWD 646986/646989/646990	Trans. code:ZF 6S-450	Propshaft	PS900558
	2006.06-	6MT	Rear	Chassis cabin RWD 646986/646989/646990	Trans. code:ZF 6S-450	Propshaft	PS900558
	2006.06-	6MT	Rear	VAN RWD 646986/646989/646990	Trans. code:ZF 6S-450	Propshaft	PS900558
	2006.06-	AT	Rear	BUS RWD 646986/646989/646990		Propshaft	PS900367
	2006.06-	AT	Rear	Chassis cabin RWD 646986/646989/646990		Propshaft	PS900367
	2006.06-	AT	Rear	VAN RWD 646986/646989/646990		Propshaft	PS900367
	2006.06-		Front	Chassis cabin RWD 646986/646989/646990		Center Bearing Support	531053
	2006.06-		Front;Rear	BUS RWD 646986/646989/646990		Center Bearing Support	514807
	2006.06-		Front;Rear	Chassis cabin RWD 646986/646989/646990		Center Bearing Support	514807
	2006.06-		Front;Rear	VAN RWD 646986/646989/646990		Center Bearing Support	514807
	2006.06-		Front	Chassis cabin RWD 646986/646989/646990		Center Bearing Support Kit	531021S
	2006.06-		Front	VAN RWD 646986/646989/646990		Center Bearing Support Kit	531021S
	2006.06-		Centre	BUS RWD 646986/646989/646990		Center Bearing Support Kit	514795S
	2006.06-		Centre	Chassis cabin RWD 646986/646989/646990		Center Bearing Support Kit	514795S
	2006.06-		Centre	VAN RWD 646986/646989/646990		Center Bearing Support Kit	514795S
	2006.06-		Front;Rear	BUS RWD 646986/646989/646990		Flexible Coupling	533884
	2006.06-		Front;Rear	Chassis cabin RWD 646986/646989/646990		Flexible Coupling	533884
	2006.06-		Front;Rear	VAN RWD 646986/646989/646990		Flexible Coupling	533884
	2006.06-		Front;Rear	BUS RWD 646986/646989/646990		Flexible Coupling Kit	537832S
	2006.06-		Front;Rear	Chassis cabin RWD 646986/646989/646990		Flexible Coupling Kit	537832S
	2006.06-		Front;Rear	VAN RWD 646986/646989/646990		Flexible Coupling Kit	537832S
	2008.02-		Front;Rear	BUS 4WD 646986/646989/646990		Center Bearing Support	514807
	2008.02-		Front;Rear	Chassis cabin 4WD 646986/646989/646990		Center Bearing Support	514807
	2008.02-		Front;Rear	VAN 4WD 646986/646989/646990		Center Bearing Support	514807
	2008.02-		Centre	BUS 4WD 646986/646989/646990		Center Bearing Support Kit	514795S
	2008.02-		Centre	Chassis cabin 4WD 646986/646989/646990		Center Bearing Support Kit	514795S
	2008.02-		Centre	VAN 4WD 646986/646989/646990		Center Bearing Support Kit	514795S
	2008.02-		Front;Rear	BUS 4WD 646986/646989/646990		Flexible Coupling	533884
	2008.02-		Front;Rear	Chassis cabin 4WD 646986/646989/646990		Flexible Coupling	533884
	2008.02-		Front;Rear	VAN 4WD 646986/646989/646990		Flexible Coupling	533884
	2008.02-		Front;Rear	BUS 4WD 646986/646989/646990		Flexible Coupling Kit	537832S
	2008.02-		Front;Rear	Chassis cabin 4WD 646986/646989/646990		Flexible Coupling Kit	537832S
	2008.02-		Front;Rear	VAN 4WD 646986/646989/646990		Flexible Coupling Kit	537832S
Sprinter 316							
1.8 (115 kw)							
	2008.09-	6MT	Rear	VAN RWD 271951	Trans. code:ZF 6S-450	Propshaft	PS900558
	2008.09-	6MT	Rear	Chassis cabin RWD 271951	Trans. code:ZF 6S-450	Propshaft	PS900558
	2008.09-		Front;Rear	VAN RWD 271951		Center Bearing Support	514807
	2008.09-		Front;Rear	Chassis cabin RWD 271951		Center Bearing Support	514807
	2008.09-		Centre	VAN RWD 271951		Center Bearing Support Kit	514795S
	2008.09-		Centre	Chassis cabin RWD 271951		Center Bearing Support Kit	514795S
	2008.09-		Front;Rear	Chassis cabin RWD 271951		Flexible Coupling	533884
	2008.09-		Front;Rear	Chassis cabin RWD 271951		Flexible Coupling Kit	537832S
	2009.03-	6MT	Rear	BUS RWD 271951	Date From:2009.03,Trans. code:ZF 6S-450	Propshaft	PS900558
	2009.03-		Front;Rear	BUS RWD 271951		Center Bearing Support	514807
	2009.03-		Centre	BUS RWD 271951		Center Bearing Support Kit	514795S
	2009.03-		Front;Rear	BUS RWD 271951		Flexible Coupling	533884
	2009.03-		Front;Rear	BUS RWD 271951		Flexible Coupling Kit	537832S
Sprinter 316 NGT							
1.8 (115 kw)							
	2009.03-		Front;Rear	VAN RWD 271951NGT		Center Bearing Support	514807
	2009.03-		Front;Rear	Chassis cabin RWD 271951NGT		Center Bearing Support	514807
	2009.03-		Front;Rear	BUS RWD 271951NGT		Center Bearing Support	514807
	2009.03-		Centre	VAN RWD 271951NGT		Center Bearing Support Kit	514795S
	2009.03-		Centre	Chassis cabin RWD 271951NGT		Center Bearing Support Kit	514795S
	2009.03-		Centre	BUS RWD 271951NGT		Center Bearing Support Kit	514795S
	2009.03-		Front;Rear	VAN RWD 271951NGT		Flexible Coupling	533884



	 YEAR	TRANSM.	FITTING POSITION	BODY STYLE & DRIVE TYPE & ENGINE	REMARKS	 PRODUCT	GSP Ref.
MERCEDES-BENZ							
Sprinter 316 NGT							
1.8 (115 kw)	2009.03-		Front;Rear	Chassis cabin RWD 271951NGT		Flexible Coupling	533884
	2009.03-		Front;Rear	VAN RWD 271951NGT		Flexible Coupling Kit	537832S
	2009.03-		Front;Rear	Chassis cabin RWD 271951NGT		Flexible Coupling Kit	537832S
Sprinter 316D							
2.2 (120 kw)	2008.02-		Front;Rear	Chassis cabin 4WD 651955/651956/651957		Center Bearing Support	514807
	2008.02-		Front;Rear	VAN 4WD 651955/651957		Center Bearing Support	514807
	2008.02-		Centre	Chassis cabin 4WD 651955/651956/651957		Center Bearing Support Kit	514795S
	2008.02-		Centre	VAN 4WD 651955/651957		Center Bearing Support Kit	514795S
	2008.02-		Front;Rear	Chassis cabin 4WD 651955/651956/651957		Flexible Coupling	533884
	2008.02-		Front;Rear	VAN 4WD 651955/651957		Flexible Coupling	533884
	2008.02-		Front;Rear	Chassis cabin 4WD 651955/651956/651957		Flexible Coupling Kit	537832S
	2008.02-		Front;Rear	VAN 4WD 651955/651957		Flexible Coupling Kit	537832S
	2009.03-	6MT	Rear	VAN RWD 651955/651957	Trans. code:NSG 370	Propshaft	PS900368
	2009.03-	6MT	Rear	Chassis cabin RWD 651955/651956/651957	Trans. code:NSG 370	Propshaft	PS900368
	2009.03-	6MT	Rear	VAN RWD 651955/651957	Trans. code:TSG 360	Propshaft	PS900550
	2009.03-	6MT	Rear	Chassis cabin RWD 651955/651956/651957	Trans. code:TSG 360	Propshaft	PS900550
	2009.03-	6MT	Rear	VAN RWD 651955/651957	Trans. code:ZF 6S-450	Propshaft	PS900558
	2009.03-	6MT	Rear	Chassis cabin RWD 651955/651956/651957	Trans. code:ZF 6S-450	Propshaft	PS900558
	2009.03-	AT	Rear	VAN RWD 651955/651957	Date From:2011.04,Chassis no. from:56829,from 573459	Propshaft	PS900559
	2009.03-	AT	Rear	Chassis cabin RWD 651955/651956/651957	Date From:2011.04,Chassis no. from:56829,from 573459	Propshaft	PS900559
	2009.03-		Front;Rear	VAN RWD 651955/651957		Center Bearing Support	514807
	2009.03-		Front;Rear	Chassis cabin RWD 651955/651956/651957		Center Bearing Support	514807
	2009.03-		Centre	VAN RWD 651955/651957		Center Bearing Support Kit	514795S
	2009.03-		Centre	Chassis cabin RWD 651955/651956/651957		Center Bearing Support Kit	514795S
	2009.03-		Front;Rear	VAN RWD 651955/651957		Flexible Coupling	533884
	2009.03-		Front;Rear	Chassis cabin RWD 651955/651956/651957		Flexible Coupling	533884
	2009.03-		Front;Rear	VAN RWD 651955/651957		Flexible Coupling Kit	537832S
	2009.03-		Front;Rear	Chassis cabin RWD 651955/651956/651957		Flexible Coupling Kit	537832S
	2011.08-	6MT	Rear	BUS RWD 651955/651956/651957	Trans. code:NSG 370	Propshaft	PS900368
	2011.08-	6MT	Rear	BUS RWD 651955/651956/651957	Trans. code:TSG 360	Propshaft	PS900550
	2011.08-	6MT	Rear	BUS RWD 651955/651956/651957	Trans. code:ZF 6S-450	Propshaft	PS900558
	2011.08-	AT	Rear	BUS RWD 651955/651956/651957	Chassis no. from:56829,from 573459	Propshaft	PS900559
	2011.08-		Front;Rear	BUS 4WD 651955/651956/651957		Center Bearing Support	514807
	2011.08-		Front;Rear	BUS RWD 651955/651956/651957		Center Bearing Support	514807
	2011.08-		Centre	BUS 4WD 651955/651956/651957		Center Bearing Support Kit	514795S
	2011.08-		Centre	BUS RWD 651955/651956/651957		Center Bearing Support Kit	514795S
	2011.08-		Front;Rear	BUS 4WD 651955/651956/651957		Flexible Coupling	533884
	2011.08-		Front;Rear	BUS RWD 651955/651956/651957		Flexible Coupling	533884
	2011.08-		Front;Rear	BUS 4WD 651955/651956/651957		Flexible Coupling Kit	537832S
	2011.08-		Front;Rear	BUS RWD 651955/651956/651957		Flexible Coupling Kit	537832S
2.7 (115 kw)	2000.04-2006.05		Centre	BUS RWD 612981/647981		Center Bearing Support	510503
	2000.04-2006.05		Centre	VAN RWD 612981/647981		Center Bearing Support	510503
	2000.04-2006.05		Centre	Chassis cabin RWD 612981/647981		Center Bearing Support	510503
	2000.04-2006.05		Centre	BUS RWD 612981/647981		Center Bearing Support Kit	531028S
	2000.04-2006.05		Centre	VAN RWD 612981/647981		Center Bearing Support Kit	531028S
	2000.04-2006.05		Centre	Chassis cabin RWD 612981/647981		Center Bearing Support Kit	531028S
	2002.08-2006.05		Centre	BUS 4WD 612981/647981		Center Bearing Support	510503
	2002.08-2006.05		Centre	Chassis cabin 4WD 612981/647981		Center Bearing Support	510503
	2002.08-2006.05		Centre	VAN 4WD 612981/647981		Center Bearing Support	510503
	2002.08-2006.05		Centre	BUS 4WD 612981/647981		Center Bearing Support Kit	531028S
	2002.08-2006.05		Centre	Chassis cabin 4WD 612981/647981		Center Bearing Support Kit	531028S
	2002.08-2006.05		Centre	VAN 4WD 612981/647981		Center Bearing Support Kit	531028S
Sprinter 318D							
3.0 (135 kw)	2006.06-	6MT	Rear	Chassis cabin RWD 642896/642992/642993	Trans. code:NSG 370	Propshaft	PS900368
	2006.06-	6MT	Rear	VAN RWD 642896/642992/642993	Trans. code:NSG 370	Propshaft	PS900368
	2006.06-	6MT	Rear	Chassis cabin RWD 642896/642992/642993	Trans. code:ZF 6S-450	Propshaft	PS900558
	2006.06-	6MT	Rear	VAN RWD 642896/642992/642993	Trans. code:ZF 6S-450	Propshaft	PS900558
	2006.06-	AT	Rear	Chassis cabin RWD 642896/642992/642993		Propshaft	PS900369
	2006.06-	AT	Rear	VAN RWD 642896/642992/642993		Propshaft	PS900369
	2006.06-		Front;Rear	Chassis cabin RWD 642896/642992/642993		Center Bearing Support	514807
	2006.06-		Front;Rear	VAN RWD 642896/642992/642993		Center Bearing Support	514807
	2006.06-		Front;Rear	Chassis cabin 4WD 642896/642992/642993		Center Bearing Support	514807
	2006.06-		Front;Rear	VAN 4WD 642896/642992/642993		Center Bearing Support	514807
	2006.06-		Centre	Chassis cabin RWD 642896/642992/642993		Center Bearing Support Kit	514795S



	 YEAR	TRANSM.	FITTING POSITION	BODY STYLE & DRIVE TYPE & ENGINE	REMARKS	 PRODUCT	GSP Ref.
MERCEDES-BENZ Sprinter 318D							
3.0 (135 kw)							
	2006.06-		Centre	VAN RWD 642896/642986/642992/642993		Center Bearing Support Kit	514795S
	2006.06-		Centre	Chassis cabin 4WD 642896/642986/642992/642993		Center Bearing Support Kit	514795S
	2006.06-		Centre	VAN 4WD 642896/642986/642992/642993		Center Bearing Support Kit	514795S
	2006.06-		Front;Rear	Chassis cabin RWD 642896/642986/642992/642993		Flexible Coupling	533884
	2006.06-		Front;Rear	VAN RWD 642896/642986/642992/642993		Flexible Coupling	533884
	2006.06-		Front;Rear	Chassis cabin 4WD 642896/642986/642992/642993		Flexible Coupling	533884
	2006.06-		Front;Rear	VAN 4WD 642896/642986/642992/642993		Flexible Coupling	533884
	2006.06-		Front;Rear	Chassis cabin RWD 642896/642986/642992/642993		Flexible Coupling Kit	537832S
	2006.06-		Front;Rear	VAN RWD 642896/642986/642992/642993		Flexible Coupling Kit	537832S
	2006.06-		Front;Rear	Chassis cabin 4WD 642896/642986/642992/642993		Flexible Coupling Kit	537832S
	2006.06-		Front;Rear	VAN 4WD 642896/642986/642992/642993		Flexible Coupling Kit	537832S
	2008.02-	6MT	Rear	BUS RWD 642896/642986/642992/642993	Trans. code:NSG 370	Propshaft	PS900368
	2008.02-	6MT	Rear	BUS RWD 642896/642986/642992/642993	Trans. code:ZF 6S-450	Propshaft	PS900558
	2008.02-	AT	Rear	BUS RWD 642896/642986/642992/642993		Propshaft	PS900369
	2008.02-		Front;Rear	BUS 4WD 642896/642986/642992/642993		Center Bearing Support	514807
	2008.02-		Front;Rear	BUS RWD 642896/642986/642992/642993		Center Bearing Support	514807
	2008.02-		Centre	BUS 4WD 642896/642986/642992/642993		Center Bearing Support Kit	514795S
	2008.02-		Centre	BUS RWD 642896/642986/642992/642993		Center Bearing Support Kit	514795S
	2008.02-		Front;Rear	BUS 4WD 642896/642986/642992/642993		Flexible Coupling	533884
	2008.02-		Front;Rear	BUS RWD 642896/642986/642992/642993		Flexible Coupling	533884
	2008.02-		Front;Rear	BUS 4WD 642896/642986/642992/642993		Flexible Coupling Kit	537832S
	2008.02-		Front;Rear	BUS RWD 642896/642986/642992/642993		Flexible Coupling Kit	537832S
Sprinter 319D							
3.0 (140 kw)							
	2009.03-	6MT	Rear	VAN RWD 642896/642898/642986/642992	Trans. code:NSG 370	Propshaft	PS900368
	2009.03-	6MT	Rear	Chassis cabin RWD 642896/642898/642986/642992	Trans. code:NSG 370	Propshaft	PS900368
	2009.03-	6MT	Rear	BUS RWD 642896/642898/642986/642992	Trans. code:NSG 370	Propshaft	PS900368
	2009.03-	6MT	Rear	VAN RWD 642896/642898/642986/642992	Trans. code:ZF 6S-450	Propshaft	PS900558
	2009.03-	6MT	Rear	Chassis cabin RWD 642896/642898/642986/642992	Trans. code:ZF 6S-450	Propshaft	PS900558
	2009.03-	6MT	Rear	BUS RWD 642896/642898/642986/642992	Trans. code:ZF 6S-450	Propshaft	PS900558
	2009.03-	AT	Rear	VAN RWD 642896/642898/642986/642992		Propshaft	PS900369
	2009.03-	AT	Rear	Chassis cabin RWD 642896/642898/642986/642992		Propshaft	PS900369
	2009.03-	AT	Rear	VAN 4WD 642896/642898/642986/642992		Propshaft	PS900369
	2009.03-	AT	Rear	BUS RWD 642896/642898/642986/642992		Propshaft	PS900369
	2009.03-		Front;Rear	VAN RWD 642896/642898/642986/642992		Center Bearing Support	514807
	2009.03-		Front;Rear	Chassis cabin RWD 642896/642898/642986/642992		Center Bearing Support	514807
	2009.03-		Front;Rear	VAN 4WD 642896/642898/642986/642992		Center Bearing Support	514807
	2009.03-		Front;Rear	Chassis cabin 4WD 642896/642898/642986/642992		Center Bearing Support	514807
	2009.03-		Front;Rear	BUS 4WD 642896/642898/642986/642992		Center Bearing Support	514807
	2009.03-		Front;Rear	BUS RWD 642896/642898/642986/642992		Center Bearing Support	514807
	2009.03-		Centre	VAN RWD 642896/642898/642986/642992		Center Bearing Support Kit	514795S
	2009.03-		Centre	Chassis cabin RWD 642896/642898/642986/642992		Center Bearing Support Kit	514795S
	2009.03-		Centre	VAN 4WD 642896/642898/642986/642992		Center Bearing Support Kit	514795S
	2009.03-		Centre	Chassis cabin 4WD 642896/642898/642986/642992		Center Bearing Support Kit	514795S
	2009.03-		Centre	BUS 4WD 642896/642898/642986/642992		Center Bearing Support Kit	514795S
	2009.03-		Centre	BUS RWD 642896/642898/642986/642992		Center Bearing Support Kit	514795S
	2009.03-		Front;Rear	VAN RWD 642896/642898/642986/642992		Flexible Coupling	533884
	2009.03-		Front;Rear	Chassis cabin RWD 642896/642898/642986/642992		Flexible Coupling	533884
	2009.03-		Front;Rear	VAN 4WD 642896/642898/642986/642992		Flexible Coupling	533884
	2009.03-		Front;Rear	Chassis cabin 4WD 642896/642898/642986/642992		Flexible Coupling	533884
	2009.03-		Front;Rear	BUS 4WD 642896/642898/642986/642992		Flexible Coupling	533884
	2009.03-		Front;Rear	BUS RWD 642896/642898/642986/642992		Flexible Coupling	533884
	2009.03-		Front;Rear	VAN RWD 642896/642898/642986/642992		Flexible Coupling Kit	537832S
	2009.03-		Front;Rear	Chassis cabin RWD 642896/642898/642986/642992		Flexible Coupling Kit	537832S
	2009.03-		Front;Rear	VAN 4WD 642896/642898/642986/642992		Flexible Coupling Kit	537832S
	2009.03-		Front;Rear	Chassis cabin 4WD 642896/642898/642986/642992		Flexible Coupling Kit	537832S
	2009.03-		Front;Rear	BUS 4WD 642896/642898/642986/642992		Flexible Coupling Kit	537832S
	2009.03-		Front;Rear	BUS RWD 642896/642898/642986/642992		Flexible Coupling Kit	537832S
Sprinter 324							
3.5 (190 kw)							
	2006.06-	6MT	Rear	BUS RWD 272979	Trans. code:NSG 370	Propshaft	PS900368
	2006.06-	6MT	Rear	VAN RWD 272979	Trans. code:NSG 370	Propshaft	PS900368
	2006.06-	6MT	Rear	BUS RWD 272979	Trans. code:ZF 6S-450	Propshaft	PS900558
	2006.06-	6MT	Rear	VAN RWD 272979	Trans. code:ZF 6S-450	Propshaft	PS900558
	2006.06-		Front;Rear	BUS RWD 272979		Center Bearing Support	514807
	2006.06-		Front;Rear	Chassis cabin RWD 272979		Center Bearing Support	514807



	 YEAR	TRANSM.	FITTING POSITION	BODY STYLE & DRIVE TYPE & ENGINE	REMARKS	 PRODUCT	GSP Ref.
MERCEDES-BENZ							
Sprinter 324							
3.5 (190 kw)	2006.06-		Front;Rear	VAN RWD 272979		Center Bearing Support	514807
	2006.06-		Centre	BUS RWD 272979		Center Bearing Support Kit	514795S
	2006.06-		Centre	Chassis cabin RWD 272979		Center Bearing Support Kit	514795S
	2006.06-		Centre	VAN RWD 272979		Center Bearing Support Kit	514795S
	2006.06-		Front;Rear	BUS RWD 272979		Flexible Coupling	533884
	2006.06-		Front;Rear	Chassis cabin RWD 272979		Flexible Coupling	533884
	2006.06-		Front;Rear	VAN RWD 272979		Flexible Coupling	533884
	2006.06-		Front;Rear	BUS RWD 272979		Flexible Coupling Kit	537832S
	2006.06-		Front;Rear	Chassis cabin RWD 272979		Flexible Coupling Kit	537832S
2006.06-		Front;Rear	VAN RWD 272979		Flexible Coupling Kit	537832S	
Sprinter 408D							
2.2 (60 kw)	2000.04-2006.05		Centre	Chassis cabin RWD 611987		Center Bearing Support	510503
	2000.04-2006.05		Centre	VAN RWD 611987		Center Bearing Support	510503
	2000.04-2006.05		Centre	Chassis cabin RWD 611987		Center Bearing Support Kit	531028S
	2000.04-2006.05		Centre	VAN RWD 611987		Center Bearing Support Kit	531028S
	2000.04-2006.05		Centre	BUS RWD 611987		Center Bearing Support Kit	531028S
2.3 (58 kw)	1995.02-2000.04		Centre	VAN RWD 601943		Center Bearing Support	510503
	1995.02-2000.04		Centre	VAN RWD 601943		Center Bearing Support Kit	531028S
	1995.04-2006.05		Centre	Chassis cabin RWD 601943		Center Bearing Support	510503
	1995.04-2006.05		Centre	Chassis cabin RWD 601943		Center Bearing Support Kit	531028S
Sprinter 410D							
2.9 (75 kw)	1997.01-2001.07		Centre	VAN RWD 602980		Center Bearing Support	510503
	1997.01-2001.07		Centre	VAN RWD 602980		Center Bearing Support Kit	531028S
	1997.01-2006.05		Centre	Chassis cabin RWD 602980		Center Bearing Support	510503
	1997.01-2006.05		Centre	Chassis cabin RWD 602980		Center Bearing Support Kit	531028S
	1997.06-2006.05		Centre	Chassis cabin 4WD 602980		Center Bearing Support	510503
	1997.06-2006.05		Centre	VAN 4WD 602980		Center Bearing Support	510503
	1997.06-2006.05		Centre	Chassis cabin 4WD 602980		Center Bearing Support Kit	531028S
	1997.06-2006.05		Centre	VAN 4WD 602980		Center Bearing Support Kit	531028S
Sprinter 411D							
2.2 (80 kw)	2000.04-2006.05		Centre	VAN 4WD 611981		Center Bearing Support	510503
	2000.04-2006.05		Centre	VAN RWD 611981		Center Bearing Support	510503
	2000.04-2006.05		Centre	Chassis cabin 4WD 611981		Center Bearing Support	510503
	2000.04-2006.05		Centre	Chassis cabin RWD 611981		Center Bearing Support	510503
	2000.04-2006.05		Centre	VAN 4WD 611981		Center Bearing Support Kit	531028S
	2000.04-2006.05		Centre	VAN RWD 611981		Center Bearing Support Kit	531028S
	2000.04-2006.05		Centre	Chassis cabin 4WD 611981		Center Bearing Support Kit	531028S
	2000.04-2006.05		Centre	Chassis cabin RWD 611981		Center Bearing Support Kit	531028S
	2000.04-2006.05		Centre	BUS RWD 611981		Center Bearing Support Kit	531028S
	2010.01-	MT	Front	Chassis cabin RWD 646985	Chassis no. to:N478535/E057183	Propshaft	PS900365
	2010.01-	MT	Front	VAN RWD 646985	Chassis no. to:N478535/E057183	Propshaft	PS900365
	2010.01-	6MT	Rear	Chassis cabin RWD 646985	Date From:2010.01,Trans. code:TSG 360	Propshaft	PS900550
	2010.01-	6MT	Rear	VAN RWD 646985	Date From:2010.01,Trans. code:TSG 360	Propshaft	PS900550
	2010.01-		Front;Rear	Chassis cabin RWD 646985		Center Bearing Support	514807
	2010.01-		Front;Rear	VAN RWD 646985		Center Bearing Support	514807
	2010.01-		Centre	Chassis cabin RWD 646985		Center Bearing Support Kit	514795S
	2010.01-		Centre	VAN RWD 646985		Center Bearing Support Kit	514795S
2.2 (84 kw)	2016.04-		Front;Rear	Chassis cabin RWD 651955		Center Bearing Support	514807
	2016.04-		Centre	Chassis cabin RWD 651955		Center Bearing Support Kit	514795S
Sprinter 412D							
2.9 (85 kw)	1995.04-2006.05		Centre	VAN RWD 602980		Center Bearing Support	510503
	1995.04-2006.05		Centre	VAN RWD 602980		Center Bearing Support Kit	531028S
	1996.02-2006.05		Centre	Chassis cabin RWD 602980		Center Bearing Support	510503
	1996.02-2006.05		Centre	Chassis cabin RWD 602980		Center Bearing Support Kit	531028S
	1997.06-2006.05		Centre	Chassis cabin 4WD 602980		Center Bearing Support	510503
	1997.06-2006.05		Centre	VAN 4WD 602980		Center Bearing Support	510503
	1997.06-2006.05		Centre	Chassis cabin 4WD 602980		Center Bearing Support Kit	531028S
	1997.06-2006.05		Centre	VAN 4WD 602980		Center Bearing Support Kit	531028S
	1997.06-2006.05		Centre	Chassis cabin 4WD 602980		Center Bearing Support	510503
2.9 (90 kw)	1995.02-2001.07		Centre	Chassis cabin RWD 602980		Center Bearing Support	510503
	1995.02-2001.07		Centre	Chassis cabin RWD 602980		Center Bearing Support Kit	531028S
	1995.02-2006.05		Centre	VAN RWD 602980		Center Bearing Support	510503
	1995.02-2006.05		Centre	VAN RWD 602980		Center Bearing Support Kit	531028S
	1997.06-2006.05		Centre	Chassis cabin 4WD 602980		Center Bearing Support	510503
	1997.06-2006.05		Centre	VAN 4WD 602980		Center Bearing Support	510503



	 YEAR	TRANSM.	FITTING POSITION	BODY STYLE & DRIVE TYPE & ENGINE	REMARKS	 PRODUCT	GSP Ref.
MERCEDES-BENZ							
Sprinter 412D							
2.9 (90 kw)	1997.06-2006.05		Centre	Chassis cabin 4WD 602980		Center Bearing Support Kit	531028S
	1997.06-2006.05		Centre	VAN 4WD 602980		Center Bearing Support Kit	531028S
Sprinter 413D							
2.2 (95 kw)	2000.04-2006.05		Centre	VAN 4WD 611981		Center Bearing Support	510503
	2000.04-2006.05		Centre	VAN RWD 611981		Center Bearing Support	510503
	2000.04-2006.05		Centre	Chassis cabin 4WD 611981		Center Bearing Support	510503
	2000.04-2006.05		Centre	Chassis cabin RWD 611981		Center Bearing Support	510503
	2000.04-2006.05		Centre	VAN 4WD 611981		Center Bearing Support Kit	531028S
	2000.04-2006.05		Centre	VAN RWD 611981		Center Bearing Support Kit	531028S
	2000.04-2006.05		Centre	Chassis cabin 4WD 611981		Center Bearing Support Kit	531028S
	2000.04-2006.05		Centre	Chassis cabin RWD 611981		Center Bearing Support Kit	531028S
	2000.04-2006.05		Centre	BUS RWD 611981		Center Bearing Support Kit	531028S
	2006.06-	6MT	Rear	Chassis cabin RWD 651955/651956	Trans. code:NSG 370	Propshaft	PS900368
	2006.06-	6MT	Rear	VAN RWD 651955/651956	Trans. code:NSG 370	Propshaft	PS900368
	2006.06-	6MT	Rear	Chassis cabin RWD 651955/651956	Trans. code:TSG 360	Propshaft	PS900550
	2006.06-	6MT	Rear	VAN RWD 651955/651956	Trans. code:TSG 360	Propshaft	PS900550
	2006.06-	6MT	Rear	VAN RWD 651955/651956	Date From:2009.03,Trans. code:TSG 360	Propshaft	PS900550
	2006.06-	6MT	Rear	Chassis cabin RWD 651955/651956	Trans. code:ZF 6S-450	Propshaft	PS900558
	2006.06-	6MT	Rear	VAN RWD 651955/651956	Trans. code:ZF 6S-450	Propshaft	PS900558
	2006.06-	6MT	Rear	VAN RWD 651955/651956	Date From:2009.03,Trans. code:ZF 6S-450	Propshaft	PS900558
	2006.06-	AT	Rear	Chassis cabin RWD 651955/651956		Propshaft	PS900367
	2006.06-	AT	Rear	VAN RWD 651955/651956		Propshaft	PS900367
	2006.06-	AT	Rear	VAN RWD 651955/651956	Date From:2009.03	Propshaft	PS900367
	2006.06-	AT	Rear	Chassis cabin RWD 651955/651956	Date From:2011.04,Chassis no. from:56829	Propshaft	PS900559
	2006.06-	AT	Rear	VAN RWD 651955/651956	Date From:2011.04,Chassis no. from:56829	Propshaft	PS900559
	2006.06-	AT	Rear	VAN RWD 651955/651956	Date From:2011.04,Chassis no. from:56829	Propshaft	PS900559
	2006.06-		Front;Rear	Chassis cabin RWD 651955/651956		Center Bearing Support	514807
	2006.06-		Front;Rear	VAN RWD 651955/651956		Center Bearing Support	514807
	2006.06-		Centre	Chassis cabin RWD 651955/651956		Center Bearing Support Kit	514795S
	2006.06-		Centre	VAN RWD 651955/651956		Center Bearing Support Kit	514795S
	2006.06-		Front;Rear	VAN RWD 651955/651956		Flexible Coupling	533884
	2006.06-		Rear	Chassis cabin RWD 651955/651956		Flexible Coupling Kit	537832S
	2006.06-		Front;Rear	VAN RWD 651955/651956		Flexible Coupling Kit	537832S
Sprinter 414							
2.3 (105 kw)	1995.02-2006.05		Centre	Chassis cabin RWD 111979/111984		Center Bearing Support	510503
	1995.02-2006.05		Centre	VAN RWD 111979/111984		Center Bearing Support	510503
	1995.02-2006.05		Centre	Chassis cabin RWD 111979/111984		Center Bearing Support Kit	531028S
	1995.02-2006.05		Centre	VAN RWD 111979/111984		Center Bearing Support Kit	531028S
	1996.02-2006.05		Centre	BUS RWD 111979/111984		Center Bearing Support Kit	531028S
	1997.05-2006.05		Centre	Chassis cabin 4WD 111984		Center Bearing Support	510503
	1997.05-2006.05		Centre	VAN 4WD 111984		Center Bearing Support	510503
	1997.05-2006.05		Centre	Chassis cabin 4WD 111984		Center Bearing Support Kit	531028S
	1997.05-2006.05		Centre	VAN 4WD 111984		Center Bearing Support Kit	531028S
2.9 (90 kw)	1997.05-2000.07		Centre	Chassis cabin 4WD 602980		Center Bearing Support	510503
	1997.05-2000.07		Centre	Chassis cabin 4WD 602980		Center Bearing Support Kit	531028S
	1997.05-2006.05		Centre	VAN 4WD 602980		Center Bearing Support	510503
	1997.05-2006.05		Centre	VAN 4WD 602980		Center Bearing Support Kit	531028S
Sprinter 414D							
2.2 (105 kw)	2016.04-	6MT	Rear	Chassis cabin RWD 651955	Trans. code:NSG 370	Propshaft	PS900368
	2016.04-	6MT	Rear	Chassis cabin RWD 651955	Trans. code:ZF 6S-450	Propshaft	PS900558
	2016.04-	AT	Rear	Chassis cabin RWD 651955		Propshaft	PS900367
	2016.04-		Front;Rear	Chassis cabin RWD 651955		Center Bearing Support	514807
	2016.04-		Front;Rear	VAN 4WD 651955		Center Bearing Support	514807
	2016.04-		Centre	Chassis cabin RWD 651955		Center Bearing Support Kit	514795S
	2016.04-		Centre	VAN 4WD 651955		Center Bearing Support Kit	514795S
	2016.05-	6MT	Front	VAN RWD 651955	Date From:2016.09,Trans. code:TSG 360,Chassis no. from:P33397C	Propshaft	PS900609
	2016.05-	6MT	Rear	VAN RWD 651955	Trans. code:NSG 370	Propshaft	PS900368
	2016.05-	6MT	Rear	VAN RWD 651955	Trans. code:ZF 6S-450	Propshaft	PS900558
	2016.05-	AT	Rear	VAN RWD 651955		Propshaft	PS900367
	2016.05-		Front;Rear	VAN RWD 651955		Center Bearing Support	514807
	2016.05-		Centre	VAN RWD 651955		Center Bearing Support Kit	514795S
Sprinter 415D							
2.2 (110 kw)	2006.06-2010.12	MT	Front	Chassis cabin RWD 646986/646989/646990	Chassis no. to:N478535/E057183	Propshaft	PS900365
	2006.06-2010.12	MT	Front	VAN RWD 646986/646989/646990	Chassis no. to:N478535/E057183	Propshaft	PS900365



	 YEAR	TRANSM.	FITTING POSITION	BODY STYLE & DRIVE TYPE & ENGINE	REMARKS	 PRODUCT	GSP Ref.
MERCEDES-BENZ							
Sprinter 415D							
2.2 (110 kw)	2006.06-2010.12	6MT	Rear	Chassis cabin RWD 646986/646989/646990	Trans. code:NSG 370	Propshaft	PS900368
	2006.06-2010.12	6MT	Rear	VAN RWD 646986/646989/646990	Trans. code:NSG 370	Propshaft	PS900368
	2006.06-2010.12	6MT	Rear	Chassis cabin RWD 646986/646989/646990	Trans. code:TSG 360	Propshaft	PS900550
	2006.06-2010.12	6MT	Rear	VAN RWD 646986/646989/646990	Trans. code:TSG 360	Propshaft	PS900550
	2006.06-2010.12	6MT	Rear	Chassis cabin RWD 646986/646989/646990	Trans. code:ZF 6S-450	Propshaft	PS900558
	2006.06-2010.12	6MT	Rear	VAN RWD 646986/646989/646990	Trans. code:ZF 6S-450	Propshaft	PS900558
	2006.06-2010.12	AT	Rear	Chassis cabin RWD 646986/646989/646990		Propshaft	PS900367
	2006.06-2010.12	AT	Rear	VAN RWD 646986/646989/646990		Propshaft	PS900367
	2006.06-2010.12		Front;Rear	Chassis cabin RWD 646986/646989/646990		Center Bearing Support	514807
	2006.06-2010.12		Front;Rear	VAN RWD 646986/646989/646990		Center Bearing Support	514807
	2006.06-2010.12		Centre	Chassis cabin RWD 646986/646989/646990		Center Bearing Support Kit	514795S
	2006.06-2010.12		Centre	VAN RWD 646986/646989/646990		Center Bearing Support Kit	514795S
	2006.06-2010.12		Front;Rear	Chassis cabin RWD 646986/646989/646990		Flexible Coupling	533884
	2006.06-2010.12		Front;Rear	VAN RWD 646986/646989/646990		Flexible Coupling	533884
	2006.06-2010.12		Front;Rear	Chassis cabin RWD 646986/646989/646990		Flexible Coupling Kit	537832S
	2006.06-2010.12		Front;Rear	VAN RWD 646986/646989/646990		Flexible Coupling Kit	537832S
Sprinter 416D							
2.2 (120 kw)	2009.03-	6MT	Rear	VAN RWD 651955/651957	Trans. code:NSG 370	Propshaft	PS900368
	2009.03-	6MT	Rear	Chassis cabin RWD 651955/651957	Trans. code:NSG 370	Propshaft	PS900368
	2009.03-	6MT	Rear	VAN RWD 651955/651957	Trans. code:TSG 360	Propshaft	PS900550
	2009.03-	6MT	Rear	Chassis cabin RWD 651955/651957	Trans. code:TSG 360	Propshaft	PS900550
	2009.03-	6MT	Rear	VAN RWD 651955/651957	Trans. code:ZF 6S-450	Propshaft	PS900558
	2009.03-	6MT	Rear	Chassis cabin RWD 651955/651957	Trans. code:ZF 6S-450	Propshaft	PS900558
	2009.03-	AT	Rear	VAN RWD 651955/651957	Date From:2011.04,Chassis no. from:56829,from 573459	Propshaft	PS900559
	2009.03-	AT	Rear	Chassis cabin RWD 651955/651957	Date From:2011.04,Chassis no. from:56829,from 573459	Propshaft	PS900559
	2009.03-		Front;Rear	VAN RWD 651955/651957		Center Bearing Support	514807
	2009.03-		Front;Rear	Chassis cabin RWD 651955/651957		Center Bearing Support	514807
	2009.03-		Centre	VAN RWD 651955/651957		Center Bearing Support Kit	514795S
	2009.03-		Centre	Chassis cabin RWD 651955/651957		Center Bearing Support Kit	514795S
	2009.03-		Front;Rear	VAN RWD 651955/651957		Flexible Coupling	533884
	2009.03-		Front;Rear	Chassis cabin RWD 651955/651957		Flexible Coupling	533884
	2009.03-		Front;Rear	VAN RWD 651955/651957		Flexible Coupling Kit	537832S
	2009.03-		Front;Rear	Chassis cabin RWD 651955/651957		Flexible Coupling Kit	537832S
	2013.11-		Front;Rear	VAN 4WD 651955/651957		Center Bearing Support	514807
	2013.11-		Centre	VAN 4WD 651955/651957		Center Bearing Support Kit	514795S
2.7 (115 kw)	2000.04-2006.05		Centre	VAN 4WD 612981/647981		Center Bearing Support	510503
	2000.04-2006.05		Centre	VAN RWD 612981/647981		Center Bearing Support	510503
	2000.04-2006.05		Centre	Chassis cabin 4WD 612981/647981		Center Bearing Support	510503
	2000.04-2006.05		Centre	Chassis cabin RWD 612981/647981		Center Bearing Support	510503
	2000.04-2006.05		Centre	VAN 4WD 612981/647981		Center Bearing Support Kit	531028S
	2000.04-2006.05		Centre	VAN RWD 612981/647981		Center Bearing Support Kit	531028S
	2000.04-2006.05		Centre	Chassis cabin 4WD 612981/647981		Center Bearing Support Kit	531028S
	2000.04-2006.05		Centre	Chassis cabin RWD 612981/647981		Center Bearing Support Kit	531028S
	2000.04-2006.05		Centre	BUS RWD 612981		Center Bearing Support Kit	531028S
Sprinter 418D							
3.0 (135 kw)	2006.06-2010.12	6MT	Rear	Chassis cabin RWD 642896/642986/642992/642993	Trans. code:NSG 370	Propshaft	PS900368
	2006.06-2010.12	6MT	Rear	VAN RWD 642896/642986/642993	Trans. code:NSG 370	Propshaft	PS900368
	2006.06-2010.12	6MT	Rear	Chassis cabin RWD 642896/642986/642992/642993	Trans. code:ZF 6S-450	Propshaft	PS900558
	2006.06-2010.12	6MT	Rear	VAN RWD 642896/642986/642993	Trans. code:ZF 6S-450	Propshaft	PS900558
	2006.06-2010.12	AT	Rear	Chassis cabin RWD 642896/642986/642992/642993		Propshaft	PS900369
	2006.06-2010.12	AT	Rear	VAN RWD 642896/642986/642993		Propshaft	PS900369
	2006.06-2010.12		Front;Rear	Chassis cabin RWD 642896/642986/642992/642993		Center Bearing Support	514807
	2006.06-2010.12		Front;Rear	VAN RWD 642896/642986/642993		Center Bearing Support	514807
	2006.06-2010.12		Centre	Chassis cabin RWD 642896/642986/642992/642993		Center Bearing Support Kit	514795S
	2006.06-2010.12		Centre	VAN RWD 642896/642986/642993		Center Bearing Support Kit	514795S
	2006.06-2010.12		Front;Rear	Chassis cabin RWD 642896/642986/642992/642993		Flexible Coupling	533884
	2006.06-2010.12		Front;Rear	VAN RWD 642896/642986/642993		Flexible Coupling	533884
	2006.06-2010.12		Front;Rear	Chassis cabin RWD 642896/642986/642992/642993		Flexible Coupling Kit	537832S
	2006.06-2010.12		Front;Rear	VAN RWD 642896/642986/642993		Flexible Coupling Kit	537832S
Sprinter 419D							
3.0 (140 kw)	2009.03-	6MT	Rear	VAN RWD 642896/642992	Trans. code:NSG 370	Propshaft	PS900368
	2009.03-	6MT	Rear	Chassis cabin RWD 642896/642898/642986/642992	Trans. code:NSG 370	Propshaft	PS900368
	2009.03-	6MT	Rear	VAN RWD 642896/642992	Trans. code:ZF 6S-450	Propshaft	PS900558
	2009.03-	6MT	Rear	Chassis cabin RWD 642896/642898/642986/642992	Trans. code:ZF 6S-450	Propshaft	PS900558



	 YEAR	TRANSM.	FITTING POSITION	BODY STYLE & DRIVE TYPE & ENGINE	REMARKS	 PRODUCT	GSP Ref.
MERCEDES-BENZ Sprinter 419D							
3.0 (140 kw)	2009.03-	AT	Rear	VAN RWD 642896/642992		Propshaft	PS900369
	2009.03-	AT	Rear	Chassis cabin RWD 642896/642898/642986/642992		Propshaft	PS900369
	2009.03-		Front;Rear	VAN RWD 642896/642992		Center Bearing Support	514807
	2009.03-		Front;Rear	Chassis cabin RWD 642896/642898/642986/642992		Center Bearing Support	514807
	2009.03-		Centre	VAN RWD 642896/642992		Center Bearing Support Kit	514795S
	2009.03-		Centre	Chassis cabin RWD 642896/642898/642986/642992		Center Bearing Support Kit	514795S
	2009.03-		Front;Rear	VAN RWD 642896/642992		Flexible Coupling	533884
	2009.03-		Front;Rear	Chassis cabin RWD 642896/642898/642986/642992		Flexible Coupling	533884
	2009.03-		Front;Rear	VAN RWD 642896/642992		Flexible Coupling Kit	537832S
	2009.03-		Front;Rear	Chassis cabin RWD 642896/642898/642986/642992		Flexible Coupling Kit	537832S
Sprinter 424							
3.5 (190 kw)	2006.06-	6MT	Rear	Chassis cabin RWD 272979	Trans. code:NSG 370	Propshaft	PS900368
	2006.06-	6MT	Rear	VAN RWD 272979	Trans. code:NSG 370	Propshaft	PS900368
	2006.06-	6MT	Rear	Chassis cabin RWD 272979	Trans. code:ZF 6S-450	Propshaft	PS900558
	2006.06-	6MT	Rear	VAN RWD 272979	Trans. code:ZF 6S-450	Propshaft	PS900558
	2006.06-		Front;Rear	Chassis cabin RWD 272979		Center Bearing Support	514807
	2006.06-		Front;Rear	VAN RWD 272979		Center Bearing Support	514807
	2006.06-		Centre	Chassis cabin RWD 272979		Center Bearing Support Kit	514795S
	2006.06-		Centre	VAN RWD 272979		Center Bearing Support Kit	514795S
	2006.06-		Front;Rear	Chassis cabin RWD 272979		Flexible Coupling	533884
	2006.06-		Front;Rear	VAN RWD 272979		Flexible Coupling	533884
	2006.06-		Front;Rear	Chassis cabin RWD 272979		Flexible Coupling Kit	537832S
	2006.06-		Front;Rear	VAN RWD 272979		Flexible Coupling Kit	537832S
Sprinter 509D							
2.2 (65 kw)	2006.06-	MT	Front	Chassis cabin RWD 646984	Chassis no. to:N478535/E057183	Propshaft	PS900365
	2006.06-	MT	Front	VAN RWD 646984	Chassis no. to:N478535/E057183	Propshaft	PS900365
	2006.06-	6MT	Rear	Chassis cabin RWD 646984	Trans. code:NSG 370	Propshaft	PS900368
	2006.06-	6MT	Rear	VAN RWD 646984	Trans. code:NSG 370	Propshaft	PS900368
	2006.06-	6MT	Rear	Chassis cabin RWD 646984	Trans. code:TSG 360	Propshaft	PS900550
	2006.06-	6MT	Rear	VAN RWD 646984	Trans. code:TSG 360	Propshaft	PS900550
	2006.06-	6MT	Rear	Chassis cabin RWD 646984	Trans. code:ZF 6S-450	Propshaft	PS900558
	2006.06-	6MT	Rear	VAN RWD 646984	Trans. code:ZF 6S-450	Propshaft	PS900558
	2006.06-	AT	Rear	Chassis cabin RWD 646984		Propshaft	PS900367
	2006.06-	AT	Rear	VAN RWD 646984		Propshaft	PS900367
	2006.06-		Front;Rear	Chassis cabin RWD 646984		Center Bearing Support	514807
	2006.06-		Front;Rear	VAN RWD 646984		Center Bearing Support	514807
	2006.06-		Centre	Chassis cabin RWD 646984		Center Bearing Support Kit	514795S
	2006.06-		Centre	VAN RWD 646984		Center Bearing Support Kit	514795S
	2006.06-		Front;Rear	Chassis cabin RWD 646984		Flexible Coupling	533884
	2006.06-		Front;Rear	VAN RWD 646984		Flexible Coupling	533884
	2006.06-		Front;Rear	Chassis cabin RWD 646984		Flexible Coupling Kit	537832S
	2006.06-		Front;Rear	VAN RWD 646984		Flexible Coupling Kit	537832S
Sprinter 510D							
2.2 (70 kw)	2009.03-	6MT	Rear	VAN RWD 651955/651956	Trans. code:NSG 370	Propshaft	PS900368
	2009.03-	6MT	Rear	Chassis cabin RWD 651955/651956	Trans. code:NSG 370	Propshaft	PS900368
	2009.03-	6MT	Rear	VAN RWD 651955/651956	Trans. code:TSG 360	Propshaft	PS900550
	2009.03-	6MT	Rear	Chassis cabin RWD 651955/651956	Trans. code:TSG 360	Propshaft	PS900550
	2009.03-	6MT	Rear	VAN RWD 651955/651956	Trans. code:ZF 6S-450	Propshaft	PS900558
	2009.03-	6MT	Rear	Chassis cabin RWD 651955/651956	Trans. code:ZF 6S-450	Propshaft	PS900558
	2009.03-	AT	Rear	VAN RWD 651955/651956		Propshaft	PS900367
	2009.03-	AT	Rear	Chassis cabin RWD 651955/651956		Propshaft	PS900367
	2009.03-	AT	Rear	VAN RWD 651955/651956	Date From:2011.04,Chassis no. from:56829	Propshaft	PS900559
	2009.03-	AT	Rear	Chassis cabin RWD 651955/651956	Date From:2011.04,Chassis no. from:56829	Propshaft	PS900559
	2009.03-		Front;Rear	VAN RWD 651955/651956		Center Bearing Support	514807
	2009.03-		Front;Rear	Chassis cabin RWD 651955/651956		Center Bearing Support	514807
	2009.03-		Centre	VAN RWD 651955/651956		Center Bearing Support Kit	514795S
	2009.03-		Centre	Chassis cabin RWD 651955/651956		Center Bearing Support Kit	514795S
	2009.03-		Front;Rear	VAN RWD 651955/651956		Flexible Coupling	533884
	2009.03-		Front;Rear	Chassis cabin RWD 651955/651956		Flexible Coupling	533884
	2009.03-		Front;Rear	VAN RWD 651955/651956		Flexible Coupling Kit	537832S
	2009.03-		Front;Rear	Chassis cabin RWD 651955/651956		Flexible Coupling Kit	537832S
Sprinter 511D							
2.2 (80 kw)	2006.06-	MT	Front	Chassis cabin RWD 646985	Chassis no. to:N478535/E057183	Propshaft	PS900365
	2006.06-	MT	Front	VAN RWD 646985	Chassis no. to:N478535/E057183	Propshaft	PS900365



	 YEAR	TRANSM.	FITTING POSITION	BODY STYLE & DRIVE TYPE & ENGINE	REMARKS	 PRODUCT	GSP Ref.
MERCEDES-BENZ Sprinter 511D 2.2 (80 kw)	2006.06-	6MT	Rear	Chassis cabin RWD 646985	Trans. code:NSG 370	Propshaft	PS900368
	2006.06-	6MT	Rear	VAN RWD 646985	Trans. code:NSG 370	Propshaft	PS900368
	2006.06-	6MT	Rear	Chassis cabin RWD 646985	Trans. code:TSG 360	Propshaft	PS900550
	2006.06-	6MT	Rear	Chassis cabin RWD 646985	Date From:2010.01,Trans. code:TSG 360	Propshaft	PS900550
	2006.06-	6MT	Rear	VAN RWD 646985	Trans. code:TSG 360	Propshaft	PS900550
	2006.06-	6MT	Rear	VAN RWD 646985	Date From:2010.01,Trans. code:TSG 360	Propshaft	PS900550
	2006.06-	6MT	Rear	Chassis cabin RWD 646985	Trans. code:ZF 6S-450	Propshaft	PS900558
	2006.06-	6MT	Rear	VAN RWD 646985	Trans. code:ZF 6S-450	Propshaft	PS900558
	2006.06-	AT	Rear	Chassis cabin RWD 646985		Propshaft	PS900367
	2006.06-	AT	Rear	VAN RWD 646985		Propshaft	PS900367
	2006.06-	AT	Rear	Chassis cabin RWD 646985	Date From:2011.04,Chassis no. from:56829/573450	Propshaft	PS900559
	2006.06-	AT	Rear	VAN RWD 646985	Date From:2011.04,Chassis no. from:56829/573450	Propshaft	PS900559
	2006.06-		Front;Rear	Chassis cabin RWD 646985		Center Bearing Support	514807
	2006.06-		Front;Rear	VAN RWD 646985		Center Bearing Support	514807
	2006.06-		Front;Rear	Chassis cabin 4WD 646985		Center Bearing Support	514807
	2006.06-		Front;Rear	VAN 4WD 646985		Center Bearing Support	514807
	2006.06-		Centre	Chassis cabin RWD 646985		Center Bearing Support Kit	514795S
	2006.06-		Centre	VAN RWD 646985		Center Bearing Support Kit	514795S
	2006.06-		Centre	Chassis cabin 4WD 646985		Center Bearing Support Kit	514795S
	2006.06-		Centre	VAN 4WD 646985		Center Bearing Support Kit	514795S
	2006.06-		Front;Rear	Chassis cabin RWD 646985		Flexible Coupling	533884
	2006.06-		Front;Rear	VAN RWD 646985		Flexible Coupling	533884
	2006.06-		Front;Rear	Chassis cabin 4WD 646985		Flexible Coupling	533884
	2006.06-		Front;Rear	VAN 4WD 646985		Flexible Coupling	533884
	2006.06-		Front;Rear	Chassis cabin RWD 646985		Flexible Coupling Kit	537832S
	2006.06-		Front;Rear	VAN RWD 646985		Flexible Coupling Kit	537832S
	2006.06-		Front;Rear	Chassis cabin 4WD 646985		Flexible Coupling Kit	537832S
	2006.06-		Front;Rear	VAN 4WD 646985		Flexible Coupling Kit	537832S
2.2 (84 kw)	2016.04-	6MT	Front	VAN RWD 651955	Date From:2016.09,Trans. code:TSG 360,Chassis no. from:P333970	Propshaft	PS900609
	2016.04-	6MT	Rear	VAN RWD 651955	Trans. code:NSG 370	Propshaft	PS900368
	2016.04-	6MT	Rear	VAN RWD 651955	Trans. code:ZF 6S-450	Propshaft	PS900558
	2016.04-	AT	Rear	VAN RWD 651955		Propshaft	PS900367
	2016.04-		Front;Rear	VAN RWD 651955		Center Bearing Support	514807
	2016.04-		Centre	VAN RWD 651955		Center Bearing Support Kit	514795S
	2016.05-	6MT	Rear	Chassis cabin RWD 651955	Trans. code:NSG 370	Propshaft	PS900368
	2016.05-	6MT	Rear	Chassis cabin RWD 651955	Trans. code:ZF 6S-450	Propshaft	PS900558
	2016.05-	AT	Rear	Chassis cabin RWD 651955		Propshaft	PS900367
	2016.05-		Front;Rear	Chassis cabin RWD 651955		Center Bearing Support	514807
	2016.05-		Centre	Chassis cabin RWD 651955		Center Bearing Support Kit	514795S
Sprinter 513D 2.2 (95 kw)	2009.03-	MT	Front	VAN RWD 646986	Chassis no. to:N478535/E057183	Propshaft	PS900365
	2009.03-	MT	Front	Chassis cabin RWD 646986	Chassis no. to:N478535/E057183	Propshaft	PS900365
	2009.03-	6MT	Rear	VAN RWD 646986	Trans. code:NSG 370	Propshaft	PS900368
	2009.03-	6MT	Rear	Chassis cabin RWD 646986	Trans. code:NSG 370	Propshaft	PS900368
	2009.03-	6MT	Rear	Chassis cabin RWD 651955/651957	Trans. code:NSG 370	Propshaft	PS900368
	2009.03-	6MT	Rear	VAN RWD 646986	Date From:2009.03,Trans. code:TSG 360	Propshaft	PS900550
	2009.03-	6MT	Rear	Chassis cabin RWD 646986	Date From:2009.03,Trans. code:TSG 360	Propshaft	PS900550
	2009.03-	6MT	Rear	Chassis cabin RWD 651955/651957	Trans. code:TSG 360	Propshaft	PS900550
	2009.03-	6MT	Rear	Chassis cabin RWD 651955/651957	Date From:2009.03,Trans. code:TSG 360	Propshaft	PS900550
	2009.03-	6MT	Rear	VAN RWD 646986	Date From:2009.03,Trans. code:ZF 6S-450	Propshaft	PS900558
	2009.03-	6MT	Rear	Chassis cabin RWD 646986	Date From:2009.03,Trans. code:ZF 6S-450	Propshaft	PS900558
	2009.03-	6MT	Rear	Chassis cabin RWD 651955/651957	Date From:2009.03,Trans. code:ZF 6S-450	Propshaft	PS900558
	2009.03-	AT	Rear	VAN RWD 646986	Date From:2009.03	Propshaft	PS900367
	2009.03-	AT	Rear	Chassis cabin RWD 646986		Propshaft	PS900367
	2009.03-	AT	Rear	Chassis cabin RWD 651955/651957		Propshaft	PS900367
	2009.03-	AT	Rear	VAN RWD 646986	Date From:2011.04,Chassis no. from:56829	Propshaft	PS900559
	2009.03-	AT	Rear	Chassis cabin RWD 646986	Date From:2011.04,Chassis no. from:56829	Propshaft	PS900559
	2009.03-	AT	Rear	Chassis cabin RWD 651955/651957	Date From:2011.04,Chassis no. from:56829/573450	Propshaft	PS900559
	2009.03-	AT	Rear	Chassis cabin RWD 651955/651957	Date From:2011.04,Chassis no. from:56829	Propshaft	PS900559
	2009.03-		Front;Rear	VAN RWD 646986		Center Bearing Support	514807
	2009.03-		Front;Rear	Chassis cabin RWD 646986		Center Bearing Support	514807
	2009.03-		Front;Rear	Chassis cabin RWD 651955/651957		Center Bearing Support	514807
	2009.03-		Front;Rear	Chassis cabin 4WD 651955/651956/651957		Center Bearing Support	514807
	2009.03-		Centre	VAN RWD 646986		Center Bearing Support Kit	514795S



	 YEAR	TRANSM.	FITTING POSITION	BODY STYLE & DRIVE TYPE & ENGINE	REMARKS	 PRODUCT	GSP Ref.
MERCEDES-BENZ Sprinter 513D							
2.2 (95 kw)	2009.03-		Centre	Chassis cabin RWD 646986		Center Bearing Support Kit	514795S
	2009.03-		Centre	Chassis cabin RWD 651955/651957		Center Bearing Support Kit	514795S
	2009.03-		Centre	Chassis cabin 4WD 651955/651956/651957		Center Bearing Support Kit	514795S
	2009.03-		Front;Rear	VAN RWD 646986		Flexible Coupling	533884
	2009.03-		Front;Rear	Chassis cabin RWD 646986		Flexible Coupling	533884
	2009.03-		Rear	Chassis cabin RWD 651955/651957		Flexible Coupling Kit	537832S
	2009.03-		Rear	Chassis cabin 4WD 651955/651956/651957		Flexible Coupling Kit	537832S
	2009.03-		Front;Rear	VAN RWD 646986		Flexible Coupling Kit	537832S
	2009.03-		Front;Rear	Chassis cabin RWD 646986		Flexible Coupling Kit	537832S
Sprinter 514D							
2.2 (105 kw)	2016.04-		Front;Rear	VAN 4WD 651955		Center Bearing Support	514807
	2016.04-		Centre	VAN 4WD 651955		Center Bearing Support Kit	514795S
	2016.05-	6MT	Front	VAN RWD 651955	<small>Date From:2016.09,Trans. code:TSG 360,Chassis no. from:P333970</small>	Propshaft	PS900609
	2016.05-	6MT	Rear	VAN RWD 651955	Trans. code:NSG 370	Propshaft	PS900368
	2016.05-	6MT	Rear	Chassis cabin RWD 651955	Trans. code:NSG 370	Propshaft	PS900368
	2016.05-	6MT	Rear	VAN RWD 651955	Trans. code:ZF 6S-450	Propshaft	PS900558
	2016.05-	6MT	Rear	Chassis cabin RWD 651955	Trans. code:ZF 6S-450	Propshaft	PS900558
	2016.05-	AT	Rear	VAN RWD 651955		Propshaft	PS900367
	2016.05-	AT	Rear	Chassis cabin RWD 651955		Propshaft	PS900367
	2016.05-		Front;Rear	VAN RWD 651955		Center Bearing Support	514807
	2016.05-		Front;Rear	Chassis cabin 4WD 651955/651956		Center Bearing Support	514807
	2016.05-		Front;Rear	Chassis cabin RWD 651955		Center Bearing Support	514807
	2016.05-		Centre	VAN RWD 651955		Center Bearing Support Kit	514795S
	2016.05-		Centre	Chassis cabin 4WD 651955/651956		Center Bearing Support Kit	514795S
	2016.05-		Centre	Chassis cabin RWD 651955		Center Bearing Support Kit	514795S
Sprinter 515D							
2.2 (110 kw)	2006.06-	MT	Front	Chassis cabin RWD 646986/646989/646990	Chassis no. to:N478535/E057183	Propshaft	PS900365
	2006.06-	MT	Front	VAN RWD 646986/646989/646990	Chassis no. to:N478535/E057183	Propshaft	PS900365
	2006.06-	6MT	Rear	Chassis cabin RWD 646986/646989/646990	Trans. code:NSG 370	Propshaft	PS900368
	2006.06-	6MT	Rear	VAN RWD 646986/646989/646990	Trans. code:NSG 370	Propshaft	PS900368
	2006.06-	6MT	Rear	Chassis cabin RWD 646986/646989/646990	Trans. code:TSG 360	Propshaft	PS900550
	2006.06-	6MT	Rear	VAN RWD 646986/646989/646990	Trans. code:TSG 360	Propshaft	PS900550
	2006.06-	6MT	Rear	Chassis cabin RWD 646986/646989/646990	Trans. code:ZF 6S-450	Propshaft	PS900558
	2006.06-	6MT	Rear	VAN RWD 646986/646989/646990	Trans. code:ZF 6S-450	Propshaft	PS900558
	2006.06-	AT	Rear	Chassis cabin RWD 646986/646989/646990		Propshaft	PS900367
	2006.06-	AT	Rear	VAN RWD 646986/646989/646990		Propshaft	PS900367
	2006.06-		Front;Rear	Chassis cabin RWD 646986/646989/646990		Center Bearing Support	514807
	2006.06-		Front;Rear	VAN RWD 646986/646989/646990		Center Bearing Support	514807
	2006.06-		Front;Rear	VAN 4WD 646986/646989/646990		Center Bearing Support	514807
	2006.06-		Front;Rear	Chassis cabin 4WD 646986/646989/646990		Center Bearing Support	514807
	2006.06-		Centre	Chassis cabin RWD 646986/646989/646990		Center Bearing Support Kit	514795S
	2006.06-		Centre	VAN RWD 646986/646989/646990		Center Bearing Support Kit	514795S
	2006.06-		Centre	VAN 4WD 646986/646989/646990		Center Bearing Support Kit	514795S
	2006.06-		Centre	Chassis cabin 4WD 646986/646989/646990		Center Bearing Support Kit	514795S
	2006.06-		Front;Rear	Chassis cabin RWD 646986/646989/646990		Flexible Coupling	533884
	2006.06-		Front;Rear	VAN 4WD 646986/646989/646990		Flexible Coupling	533884
	2006.06-		Front;Rear	Chassis cabin 4WD 646986/646989/646990		Flexible Coupling	533884
	2006.06-		Front;Rear	Chassis cabin RWD 646986/646989/646990		Flexible Coupling Kit	537832S
	2006.06-		Front;Rear	VAN 4WD 646986/646989/646990		Flexible Coupling Kit	537832S
	2006.06-		Front;Rear	Chassis cabin 4WD 646986/646989/646990		Flexible Coupling Kit	537832S
Sprinter 516							
1.8 (115 kw)	2009.03-	6MT	Rear	Chassis cabin RWD 271951	<small>Date From:2009.03,Trans. code:ZF 6S-450</small>	Propshaft	PS900558
	2009.03-		Front;Rear	Chassis cabin RWD 271951		Center Bearing Support	514807
	2009.03-		Centre	Chassis cabin RWD 271951		Center Bearing Support Kit	514795S
	2009.03-		Front;Rear	Chassis cabin RWD 271951		Flexible Coupling	533884
	2009.03-		Front;Rear	Chassis cabin RWD 271951		Flexible Coupling Kit	537832S
Sprinter 516 NGT							
1.8 (115 kw)	2009.03-		Front;Rear	Chassis cabin RWD 271951NGT		Center Bearing Support	514807
	2009.03-		Centre	Chassis cabin RWD 271951NGT		Center Bearing Support Kit	514795S
	2009.03-		Front;Rear	Chassis cabin RWD 271951NGT		Flexible Coupling	533884
	2009.03-		Front;Rear	Chassis cabin RWD 271951NGT		Flexible Coupling Kit	537832S
Sprinter 516D							
2.2 (120 kw)	2009.03-	6MT	Rear	VAN RWD 651955/651957	Trans. code:NSG 370	Propshaft	PS900368
	2009.03-	6MT	Rear	Chassis cabin RWD 651955/651957	Trans. code:NSG 370	Propshaft	PS900368



	 YEAR	TRANSM.	FITTING POSITION	BODY STYLE & DRIVE TYPE & ENGINE	REMARKS	 PRODUCT	GSP Ref.
MERCEDES-BENZ Sprinter 516D 2.2 (120 kw)	2009.03-	6MT	Rear	VAN RWD 651955/651957	Trans. code:TSG 360	Propshaft	PS900550
	2009.03-	6MT	Rear	Chassis cabin RWD 651955/651957	Trans. code:TSG 360	Propshaft	PS900550
	2009.03-	6MT	Rear	BUS RWD 651955/651956	Trans. code:TSG 360	Propshaft	PS900550
	2009.03-	6MT	Rear	VAN RWD 651955/651957	Trans. code:ZF 6S-450	Propshaft	PS900558
	2009.03-	6MT	Rear	Chassis cabin RWD 651955/651957	Trans. code:ZF 6S-450	Propshaft	PS900558
	2009.03-	6MT	Rear	BUS RWD 651955/651956	Trans. code:ZF 6S-450	Propshaft	PS900558
	2009.03-	AT	Rear	VAN RWD 651955/651957	Date From:2011.04,Chassis no. from:56829,from 573459	Propshaft	PS900559
	2009.03-	AT	Rear	Chassis cabin RWD 651955/651957	Date From:2011.04,Chassis no. from:56829,from 573459	Propshaft	PS900559
	2009.03-	AT	Rear	BUS RWD 651955/651956	Chassis no. from:56829/573459	Propshaft	PS900559
	2009.03-	6MT	-	BUS RWD 651955/651956	Trans. code:NSG 370	Propshaft	PS900368
	2009.03-		Front;Rear	VAN RWD 651955/651957		Center Bearing Support	514807
	2009.03-		Front;Rear	Chassis cabin RWD 651955/651957		Center Bearing Support	514807
	2009.03-		Front;Rear	Chassis cabin 4WD 651955/651956/651957		Center Bearing Support	514807
	2009.03-		Front;Rear	VAN 4WD 651955/651956/651957		Center Bearing Support	514807
	2009.03-		Centre	VAN RWD 651955/651957		Center Bearing Support Kit	514795S
	2009.03-		Centre	Chassis cabin RWD 651955/651957		Center Bearing Support Kit	514795S
	2009.03-		Centre	Chassis cabin 4WD 651955/651956/651957		Center Bearing Support Kit	514795S
	2009.03-		Centre	VAN 4WD 651955/651956/651957		Center Bearing Support Kit	514795S
	2009.03-		Front;Rear	VAN RWD 651955/651957		Flexible Coupling	533884
	2009.03-		Front;Rear	Chassis cabin RWD 651955/651957		Flexible Coupling	533884
	2009.03-		Front;Rear	Chassis cabin 4WD 651955/651956/651957		Flexible Coupling	533884
	2009.03-		Front;Rear	VAN 4WD 651955/651956/651957		Flexible Coupling	533884
	2009.03-		Front;Rear	VAN RWD 651955/651957		Flexible Coupling Kit	537832S
	2009.03-		Front;Rear	VAN RWD 651955/651957	Engine Code:OM 651.957	Flexible Coupling Kit	537832S
	2009.03-		Front;Rear	Chassis cabin RWD 651955/651957		Flexible Coupling Kit	537832S
	2009.03-		Front;Rear	Chassis cabin 4WD 651955/651956/651957		Flexible Coupling Kit	537832S
	2009.03-		Front;Rear	VAN 4WD 651955/651956/651957		Flexible Coupling Kit	537832S
Sprinter 518D 3.0 (135 kw)	2006.06-	6MT	Rear	Chassis cabin RWD 642896/642986/642992/642993	Trans. code:NSG 370	Propshaft	PS900368
	2006.06-	6MT	Rear	VAN RWD 642896/642986/642992/642993	Trans. code:NSG 370	Propshaft	PS900368
	2006.06-	6MT	Rear	Chassis cabin RWD 642896/642986/642992/642993	Trans. code:ZF 6S-450	Propshaft	PS900558
	2006.06-	6MT	Rear	VAN RWD 642896/642986/642992/642993	Date To:2010.12,Trans. code:ZF 6S-450	Propshaft	PS900558
	2006.06-	AT	Rear	Chassis cabin RWD 642896/642986/642992/642993		Propshaft	PS900369
	2006.06-	AT	Rear	VAN RWD 642896/642986/642992/642993		Propshaft	PS900369
	2006.06-		Front;Rear	Chassis cabin RWD 642896/642986/642992/642993		Center Bearing Support	514807
	2006.06-		Front;Rear	VAN RWD 642896/642986/642992/642993		Center Bearing Support	514807
	2006.06-		Front;Rear	VAN 4WD 642896/642992/642993		Center Bearing Support	514807
	2006.06-		Front;Rear	Chassis cabin 4WD 642896/642986/642992/642993		Center Bearing Support	514807
	2006.06-		Centre	Chassis cabin RWD 642896/642986/642992/642993		Center Bearing Support Kit	514795S
	2006.06-		Centre	VAN RWD 642896/642986/642992/642993		Center Bearing Support Kit	514795S
	2006.06-		Centre	VAN 4WD 642896/642992/642993		Center Bearing Support Kit	514795S
	2006.06-		Centre	Chassis cabin 4WD 642896/642986/642992/642993		Center Bearing Support Kit	514795S
	2006.06-		Front;Rear	Chassis cabin RWD 642896/642986/642992/642993		Flexible Coupling	533884
	2006.06-		Front;Rear	VAN 4WD 642896/642992/642993		Flexible Coupling	533884
	2006.06-		Front;Rear	Chassis cabin 4WD 642896/642986/642992/642993		Flexible Coupling	533884
	2006.06-		Front;Rear	Chassis cabin RWD 642896/642986/642992/642993		Flexible Coupling Kit	537832S
	2006.06-		Front;Rear	VAN 4WD 642896/642992/642993		Flexible Coupling Kit	537832S
	2006.06-		Front;Rear	Chassis cabin 4WD 642896/642986/642992/642993		Flexible Coupling Kit	537832S
Sprinter 519D 3.0 (140 kw)	2009.03-	6MT	Rear	VAN RWD 642896/642898/642986/642992	Trans. code:NSG 370	Propshaft	PS900368
	2009.03-	6MT	Rear	Chassis cabin RWD 642896/642898/642986/642992	Trans. code:NSG 370	Propshaft	PS900368
	2009.03-	6MT	Rear	VAN RWD 642896/642898/642986/642992	Trans. code:ZF 6S-450	Propshaft	PS900558
	2009.03-	6MT	Rear	Chassis cabin RWD 642896/642898/642986/642992	Trans. code:ZF 6S-450	Propshaft	PS900558
	2009.03-	6MT	Rear	BUS RWD 642896	Trans. code:ZF 6S-450	Propshaft	PS900558
	2009.03-	AT	Rear	VAN RWD 642896/642898/642986/642992		Propshaft	PS900369
	2009.03-	AT	Rear	Chassis cabin RWD 642896/642898/642986/642992		Propshaft	PS900369
	2009.03-	AT	Rear	BUS RWD 642896		Propshaft	PS900369
	2009.03-		Front;Rear	VAN RWD 642896/642898/642986/642992		Center Bearing Support	514807
	2009.03-		Front;Rear	Chassis cabin RWD 642896/642898/642986/642992		Center Bearing Support	514807
	2009.03-		Front;Rear	VAN 4WD 642896/642898/642986/642992		Center Bearing Support	514807
	2009.03-		Front;Rear	Chassis cabin 4WD 642896/642898/642986/642992		Center Bearing Support	514807
	2009.03-		Centre	VAN RWD 642896/642898/642986/642992		Center Bearing Support Kit	514795S
	2009.03-		Centre	Chassis cabin RWD 642896/642898/642986/642992		Center Bearing Support Kit	514795S
	2009.03-		Centre	VAN 4WD 642896/642898/642986/642992		Center Bearing Support Kit	514795S



	 YEAR	TRANSM.	FITTING POSITION	BODY STYLE & DRIVE TYPE & ENGINE	REMARKS	 PRODUCT	GSP Ref.
MERCEDES-BENZ							
Sprinter 519D							
3.0 (140 kw)	2009.03-		Centre	Chassis cabin 4WD 642896/642898/642986/642992		Center Bearing Support Kit	514795S
	2009.03-		Front;Rear	VAN RWD 642896/642898/642986/642992		Flexible Coupling	533884
	2009.03-		Front;Rear	Chassis cabin RWD 642896/642898/642986/642992		Flexible Coupling	533884
	2009.03-		Front;Rear	VAN 4WD 642896/642898/642986/642992		Flexible Coupling	533884
	2009.03-		Front;Rear	Chassis cabin 4WD 642896/642898/642986/642992		Flexible Coupling	533884
	2009.03-		Front;Rear	VAN RWD 642896/642898/642986/642992		Flexible Coupling Kit	537832S
	2009.03-		Front;Rear	Chassis cabin RWD 642896/642898/642986/642992		Flexible Coupling Kit	537832S
	2009.03-		Front;Rear	VAN 4WD 642896/642898/642986/642992		Flexible Coupling Kit	537832S
	2009.03-		Front;Rear	Chassis cabin 4WD 642896/642898/642986/642992		Flexible Coupling Kit	537832S
Sprinter 524							
3.5 (190 kw)	2006.06-	6MT	Rear	Chassis cabin RWD 272979	Trans. code:NSG 370	Propshaft	PS900368
	2006.06-	6MT	Rear	VAN RWD 272979	Trans. code:NSG 370	Propshaft	PS900368
	2006.06-	6MT	Rear	Chassis cabin RWD 272979	Trans. code:ZF 6S-450	Propshaft	PS900558
	2006.06-	6MT	Rear	VAN RWD 272979	Trans. code:ZF 6S-450	Propshaft	PS900558
	2006.06-		Front;Rear	Chassis cabin RWD 272979		Center Bearing Support	514807
	2006.06-		Front;Rear	VAN RWD 272979		Center Bearing Support	514807
	2006.06-		Centre	Chassis cabin RWD 272979		Center Bearing Support Kit	514795S
	2006.06-		Centre	VAN RWD 272979		Center Bearing Support Kit	514795S
	2006.06-		Front;Rear	Chassis cabin RWD 272979		Flexible Coupling	533884
	2006.06-		Front;Rear	VAN RWD 272979		Flexible Coupling	533884
	2006.06-		Front;Rear	Chassis cabin RWD 272979		Flexible Coupling Kit	537832S
	2006.06-		Front;Rear	VAN RWD 272979		Flexible Coupling Kit	537832S
Sprinter 616D							
2.7 (115 kw)	2001.04-2006.05		Centre	Chassis cabin RWD 612981		Center Bearing Support Kit	531028S
T-Model							
3.5 (205 kw)	2004.08-2006.08		Rear	Estate AWD M 272.972		Flexible Coupling Kit	537793S
	2004.08-2006.08		Front;Rear	Estate AWD M 272.972		Flexible Coupling Kit	512673S
	2004.08-2006.08		Front;Rear	Estate AWD M 272.972		Flexible Coupling Kit	512677S
T-Model E350							
3.5 (200 kw)	2009.11-2011.12		Front;Rear	Estate AWD M 276.952		Flexible Coupling Kit	512673S
T-Model E400							
3.0 (245 kw)	2017.01-2018.12		Front;Rear	Estate AWD M 276.823		Flexible Coupling Kit	537630S
Viano							
2.2 (80 kw)	2003.08-2011.12		Rear	MPV RWD 646982		Propshaft	PS900393
	2003.08-2011.12	AT	Rear	MPV RWD 646982	<small>Date From:2007.03.01 To:2011.12 Chassis no. Non-381528 For Engine Code:0M 611 DE 21 LAJOM 68 DE 22 LA</small>	Propshaft	PS900381
	2003.08-2011.12	6MT	-	MPV RWD 646982	<small>Date To:2011.12 For Engine Code:0M 646 DE 22 LAJOM 611 DE 21 LA Trans. code:NSG 370</small>	Propshaft	PS900379
	2003.08-2011.12	AT	-	MPV RWD 646982		Propshaft	PS900390
	2003.08-2011.12		Front	MPV RWD 646982		Center Bearing Support	531053
	2003.08-2011.12		Rear	MPV RWD 646982		Center Bearing Support	531052
	2003.08-2011.12		Front	MPV RWD 646982		Center Bearing Support Kit	531021S
	2003.08-2011.12		Rear	MPV RWD 646982		Center Bearing Support Kit	531020S
	2003.08-2011.12		Front;Rear	MPV RWD 646982		Flexible Coupling	533884
	2003.08-2011.12		Front;Rear	MPV RWD 646982		Flexible Coupling Kit	537832S
	2003.08-2012.12		Rear	MPV 4WD 646982		Propshaft	PS900393
	2003.08-2012.12		-	MPV 4WD 646982		Propshaft	PS900390
	2003.08-2012.12	6MT	-	MPV 4WD 646982	<small>Date From:2007.04 Chassis no. Non-381528 For Engine Code:0M 646 DE 22 LAJOM 611 DE 21 LA Trans. code:NSG 370</small>	Propshaft	PS900379
	2003.08-2012.12		Front	MPV 4WD 646982		Center Bearing Support	531053
	2003.08-2012.12		Rear	MPV 4WD 646982		Center Bearing Support	531052
	2003.08-2012.12		Front	MPV 4WD 646982		Center Bearing Support Kit	531021S
	2003.08-2012.12		Rear	MPV 4WD 646982		Center Bearing Support Kit	531020S
	2003.08-2012.12		Front;Rear	MPV 4WD 646982		Flexible Coupling	533884
	2003.08-2012.12		Front;Rear	MPV 4WD 646982		Flexible Coupling Kit	537832S
2.2 (85 kw)	2005.08-		Rear	MPV 4WD 646982		Propshaft	PS900393
	2005.08-		Rear	MPV RWD 646982		Propshaft	PS900393
	2005.08-	AT	Rear	MPV RWD 646982	<small>Date From:2007.04 Chassis no. Non-381528 For Engine Code:0M 611 DE 22 LAJOM 68 DE 22 LA</small>	Propshaft	PS900381
	2005.08-	-	-	MPV 4WD 646982		Propshaft	PS900390
	2005.08-	AT	-	MPV RWD 646982		Propshaft	PS900390
	2005.08-		Front	MPV RWD 646982		Center Bearing Support	531053
	2005.08-		Rear	MPV RWD 646982		Center Bearing Support	531052
	2005.08-		Front	MPV 4WD 646982		Center Bearing Support Kit	531021S
	2005.08-		Front	MPV RWD 646982		Center Bearing Support Kit	531021S
	2005.08-		Rear	MPV RWD 646982		Center Bearing Support Kit	531020S
	2005.08-		Front;Rear	MPV RWD 646982		Flexible Coupling	533884
	2005.08-		Front;Rear	MPV 4WD 646982		Flexible Coupling Kit	537832S



	 YEAR	TRANSM.	FITTING POSITION	BODY STYLE & DRIVE TYPE & ENGINE	REMARKS	 PRODUCT	GSP Ref.	
MERCEDES-BENZ Viano								
2.2 (85 kw) 2.2 (100 kw)	2005-08-		Front;Rear	MPV RWD 646982		Flexible Coupling Kit	537832S	
	2010-07-		Rear	MPV 4WD 651940		Propshaft	PS900393	
	2010-07-		Rear	MPV RWD 651940		Propshaft	PS900393	
	2010-07-	AT	Rear	MPV RWD 651940	For Engine Code:OM 611 DE 22 LA/OM 646 DE 22 LA	Propshaft	PS900381	
	2010-07-	-	-	MPV 4WD 651940		Propshaft	PS900390	
	2010-07-	-	-	MPV RWD 651940		Propshaft	PS900390	
	2010-07-	6MT	-	MPV 4WD 651940	For Engine Code:OM 646 DE 22 LA/OM 611 DE 22 LA,Trans. code:NSG 370	Propshaft	PS900379	
	2010-07-	6MT	-	MPV RWD 651940	For Engine Code:OM 646 DE 22 LA/OM 611 DE 22 LA,Trans. code:NSG 370	Propshaft	PS900379	
	2010-07-		Front	MPV 4WD 651940		Center Bearing Support	531053	
	2010-07-		Front	MPV RWD 651940		Center Bearing Support	531053	
	2010-07-		Rear	MPV 4WD 651940		Center Bearing Support	531052	
	2010-07-		Rear	MPV RWD 651940		Center Bearing Support	531052	
	2010-07-		Front	MPV 4WD 651940		Center Bearing Support Kit	531021S	
	2010-07-		Front	MPV RWD 651940		Center Bearing Support Kit	531021S	
	2010-07-		Rear	MPV 4WD 651940		Center Bearing Support Kit	531020S	
	2010-07-		Rear	MPV RWD 651940		Center Bearing Support Kit	531020S	
	2.2 (110 kw)	2010-07-		Front;Rear	MPV 4WD 651940		Flexible Coupling	533884
		2010-07-		Front;Rear	MPV RWD 651940		Flexible Coupling	533884
2010-07-			Front;Rear	MPV 4WD 651940		Flexible Coupling Kit	537832S	
2010-07-			Front;Rear	MPV RWD 651940		Flexible Coupling Kit	537832S	
2003-09-			Rear	MPV RWD 646980/646982		Propshaft	PS900393	
2003-09-		AT	Rear	MPV RWD 646980/646982	Date From:2007-09,Obsolete to: 2007-09/2008-03 For Engine Code:OM 611 DE 22 LA/OM 646 DE 22 LA	Propshaft	PS900381	
2003-09-		6MT	-	MPV RWD 646980/646982	For Engine Code:OM 646 DE 22 LA/OM 611 DE 22 LA,Trans. code:NSG 370	Propshaft	PS900379	
2003-09-		AT	-	MPV RWD 646980/646982		Propshaft	PS900390	
2003-09-			Front	MPV RWD 646980/646982		Center Bearing Support	531053	
2003-09-			Rear	MPV RWD 646980/646982		Center Bearing Support	531052	
2003-09-			Front	MPV RWD 646980/646982		Center Bearing Support Kit	531021S	
2003-09-			Rear	MPV RWD 646980/646982		Center Bearing Support Kit	531020S	
2003-09-			Front;Rear	MPV RWD 646980/646982		Flexible Coupling	533884	
2003-09-			Front;Rear	MPV RWD 646980/646982		Flexible Coupling Kit	537832S	
2006-03-			Rear	MPV 4WD 646982		Propshaft	PS900393	
2006-03-			-	MPV 4WD 646982		Propshaft	PS900390	
2006-03-		6MT	-	MPV 4WD 646982	Date From:2006-03,For Engine Code:OM 646 DE 22 LA/OM 611 DE 22 LA,Trans. code:NSG 370	Propshaft	PS900379	
2006-03-			Front	MPV 4WD 646982		Center Bearing Support	531053	
2006-03-			Rear	MPV 4WD 646982		Center Bearing Support	531052	
2006-03-			Front	MPV 4WD 646982		Center Bearing Support Kit	531021S	
2006-03-			Rear	MPV 4WD 646982		Center Bearing Support Kit	531020S	
2006-03-			Front;Rear	MPV 4WD 646982		Flexible Coupling	533884	
2006-03-		Front;Rear	MPV 4WD 646982		Flexible Coupling Kit	537832S		
2.2 (120 kw)	2010-07-		Rear	MPV 4WD 651940		Propshaft	PS900393	
	2010-07-		Rear	MPV RWD 651940		Propshaft	PS900393	
	2010-07-		-	MPV 4WD 651940		Propshaft	PS900390	
	2010-07-		-	MPV RWD 651940		Propshaft	PS900390	
	2010-07-		Front	MPV 4WD 651940		Center Bearing Support	531053	
	2010-07-		Front	MPV RWD 651940		Center Bearing Support	531053	
	2010-07-		Rear	MPV 4WD 651940		Center Bearing Support	531052	
	2010-07-		Rear	MPV RWD 651940		Center Bearing Support	531052	
	2010-07-		Front	MPV 4WD 651940		Center Bearing Support Kit	531021S	
	2010-07-		Front	MPV RWD 651940		Center Bearing Support Kit	531021S	
	2010-07-		Rear	MPV 4WD 651940		Center Bearing Support Kit	531020S	
	2010-07-		Rear	MPV RWD 651940		Center Bearing Support Kit	531020S	
	2010-07-		Front;Rear	MPV 4WD 651940		Flexible Coupling	533884	
	2010-07-		Front;Rear	MPV RWD 651940		Flexible Coupling	533884	
	2010-07-		Front;Rear	MPV 4WD 651940		Flexible Coupling Kit	537832S	
	2010-07-		Front;Rear	MPV RWD 651940		Flexible Coupling Kit	537832S	
	3.0 (150 kw)	2005-08-		Rear	MPV RWD 642990		Propshaft	PS900393
		2005-08-		-	MPV RWD 642990		Propshaft	PS900390
2005-08-			Front	MPV RWD 642990		Center Bearing Support	531053	
2005-08-			Rear	MPV RWD 642990		Center Bearing Support	531052	
2005-08-			Front	MPV RWD 642990		Center Bearing Support Kit	531021S	
2005-08-			Rear	MPV RWD 642990		Center Bearing Support Kit	531020S	
2005-08-			Front;Rear	MPV RWD 642990		Flexible Coupling	533884	
2005-08-			Front;Rear	MPV RWD 642990		Flexible Coupling Kit	537832S	



	 YEAR	TRANSM.	FITTING POSITION	BODY STYLE & DRIVE TYPE & ENGINE	REMARKS	 PRODUCT	GSP Ref.	
MERCEDES-BENZ								
Viano								
3.0 (165 kw)	2010.07-		Rear	MPV RWD 642890		Propshaft	PS900393	
	2010.07-		-	MPV RWD 642890		Propshaft	PS900390	
	2010.07-		Front	MPV RWD 642890		Center Bearing Support	531053	
	2010.07-		Rear	MPV RWD 642890		Center Bearing Support Kit	531020S	
3.2 (140 kw)	2003.08-2012.12		Rear	MPV RWD 112951		Propshaft	PS900393	
	2003.08-2012.12		-	MPV RWD 112951		Propshaft	PS900390	
	2003.08-2012.12		Front	MPV RWD 112951		Center Bearing Support	531053	
	2003.08-2012.12		Rear	MPV RWD 112951		Center Bearing Support	531052	
	2003.08-2012.12		Front	MPV RWD 112951		Center Bearing Support Kit	531021S	
	2003.08-2012.12		Rear	MPV RWD 112951		Center Bearing Support Kit	531020S	
	2003.08-2012.12		Front;Rear	MPV RWD 112951		Flexible Coupling	533884	
	2003.08-2012.12		Front;Rear	MPV RWD 112951		Flexible Coupling Kit	537832S	
3.2 (160 kw)	2003.08-2011.12		Rear	MPV RWD 112951		Propshaft	PS900393	
	2003.08-2011.12		-	MPV RWD 112951		Propshaft	PS900390	
	2003.08-2011.12		Front	MPV RWD 112951		Center Bearing Support	531053	
	2003.08-2011.12		Rear	MPV RWD 112951		Center Bearing Support	531052	
	2003.08-2011.12		Front	MPV RWD 112951		Center Bearing Support Kit	531021S	
	2003.08-2011.12		Rear	MPV RWD 112951		Center Bearing Support Kit	531020S	
	2003.08-2011.12		Front;Rear	MPV RWD 112951		Flexible Coupling	533884	
	2003.08-2011.12		Front;Rear	MPV RWD 112951		Flexible Coupling Kit	537832S	
3.5 (190 kw)	2007.08-		Rear	MPV RWD 272978		Propshaft	PS900393	
	2007.08-		-	MPV RWD 272978		Propshaft	PS900390	
3.7 (165 kw)	2004.06-2007.07		Rear	MPV RWD 112976		Propshaft	PS900393	
	2004.06-2007.07		-	MPV RWD 112976		Propshaft	PS900390	
	2004.06-2007.07		Front	MPV RWD 112976		Center Bearing Support Kit	531021S	
	2004.06-2007.07		Front;Rear	MPV RWD 112976		Flexible Coupling Kit	537832S	
3.7 (170 kw)	2004.06-2009.07		Rear	MPV RWD 112976		Propshaft	PS900393	
	2004.06-2009.07		-	MPV RWD 112976		Propshaft	PS900390	
	2004.06-2009.07		Front	MPV RWD 112976		Center Bearing Support	531053	
	2004.06-2009.07		Rear	MPV RWD 112976		Center Bearing Support	531052	
	2004.06-2009.07		Front	MPV RWD 112976		Center Bearing Support Kit	531021S	
	2004.06-2009.07		Rear	MPV RWD 112976		Center Bearing Support Kit	531020S	
	2004.06-2009.07		Front;Rear	MPV RWD 112976		Flexible Coupling	533884	
	2004.06-2009.07		Front;Rear	MPV RWD 112976		Flexible Coupling Kit	537832S	
Vito 109								
2.2 (65 kw)	2003.08-2006.07		Rear	BUS RWD 646983		Propshaft	PS900393	
	2003.08-2006.07		Rear	VAN RWD 646983		Propshaft	PS900393	
	2003.08-2006.07	6MT	Rear	BUS RWD 646983	Wheelbase:3430 mm	Propshaft	PS900377	
	2003.08-2006.07	6MT	Rear	VAN RWD 646983	Wheelbase:3430 mm	Propshaft	PS900377	
	2003.08-2006.07		-	BUS RWD 646983		Propshaft	PS900390	
	2003.08-2006.07		-	VAN RWD 646983		Propshaft	PS900390	
	2003.08-2006.07	6MT	-	BUS RWD 646983	<small>Date To:2008.07.For Engine Code:OM 646 DE 22 LA,Trans. code:NSG 250</small>	Propshaft	PS900376	
	2003.08-2006.07	6MT	-	VAN RWD 646983	<small>Date To:2008.07.For Engine Code:OM 646 DE 22 LA,Trans. code:NSG 250</small>	Propshaft	PS900376	
	2003.08-2006.07		Front	BUS RWD 646983		Center Bearing Support	531053	
	2003.08-2006.07		Front	VAN RWD 646983		Center Bearing Support	531053	
	2003.08-2006.07		Rear	BUS RWD 646983		Center Bearing Support	531052	
	2003.08-2006.07		Rear	VAN RWD 646983		Center Bearing Support	531052	
	2003.08-2006.07		Front	BUS RWD 646983		Center Bearing Support Kit	531021S	
	2003.08-2006.07		Front	VAN RWD 646983		Center Bearing Support Kit	531021S	
	2003.08-2006.07		Rear	BUS RWD 646983		Center Bearing Support Kit	531020S	
	2003.08-2006.07		Rear	VAN RWD 646983		Center Bearing Support Kit	531020S	
	2003.08-2006.07		Front;Rear	BUS RWD 646983		Flexible Coupling	533884	
	2003.08-2006.07		Front;Rear	VAN RWD 646983		Flexible Coupling	533884	
	2003.08-2006.07		Front;Rear	BUS RWD 646983		Flexible Coupling Kit	537832S	
	2003.08-2006.07		Front;Rear	VAN RWD 646983		Flexible Coupling Kit	537832S	
	2.2 (70 kw)	2006.08-2014.08		Rear	BUS RWD 646980/646981		Propshaft	PS900393
		2006.08-2014.08		Rear	VAN RWD 646981		Propshaft	PS900393
2006.08-2014.08			-	BUS RWD 646980/646981		Propshaft	PS900390	
2006.08-2014.08			-	VAN RWD 646981		Propshaft	PS900390	
2006.08-2014.08		6MT	-	BUS RWD 646980/646981	<small>Date To:2014.08.For Engine Code:OM 646 DE 22 LA,Trans. code:NSG 250</small>	Propshaft	PS900376	
2006.08-2014.08		6MT	-	VAN RWD 646981	<small>Date To:2014.08.For Engine Code:OM 646 DE 22 LA,Trans. code:NSG 250</small>	Propshaft	PS900376	
2006.08-2014.08			Front	VAN RWD 646981		Center Bearing Support	531053	
2006.08-2014.08			Rear	VAN RWD 646981		Center Bearing Support	531052	
2006.08-2014.08			Front	VAN RWD 646981		Center Bearing Support Kit	531021S	



	 YEAR	TRANSM.	FITTING POSITION	BODY STYLE & DRIVE TYPE & ENGINE	REMARKS	 PRODUCT	GSP Ref.
MERCEDES-BENZ							
Vito 109							
2.2 (70 kw)	2006.08-2014.08		Rear	VAN RWD 646981		Center Bearing Support Kit	531020S
	2006.08-2014.08		Front;Rear	VAN RWD 646981		Flexible Coupling	533884
	2006.08-2014.08		Front;Rear	VAN RWD 646981		Flexible Coupling Kit	537832S
	2007.09-2014.08		Rear	BUS 4WD 646981		Propshaft	PS900393
	2007.09-2014.08		-	BUS 4WD 646981		Propshaft	PS900390
	2007.09-2014.08		Front	BUS 4WD 646981		Center Bearing Support	531053
	2007.09-2014.08		Rear	BUS 4WD 646981		Center Bearing Support	531052
	2007.09-2014.08		Front	BUS 4WD 646981		Center Bearing Support Kit	531021S
	2007.09-2014.08		Rear	BUS 4WD 646981		Center Bearing Support Kit	531020S
	2007.09-2014.08		Front;Rear	BUS 4WD 646981		Flexible Coupling	533884
	2007.09-2014.08		Front;Rear	BUS 4WD 646981		Flexible Coupling Kit	537832S
Vito 110							
2.2 (70 kw)	2010.09-2014.08		Rear	BUS RWD 651940		Propshaft	PS900393
	2010.09-2014.08		Rear	VAN RWD 651940		Propshaft	PS900393
	2010.09-2014.08	6MT	Rear	BUS RWD 651940	Wheelbase:3430 mm	Propshaft	PS900377
	2010.09-2014.08	6MT	Rear	VAN RWD 651940	Wheelbase:3430 mm	Propshaft	PS900377
	2010.09-2014.08	AT	Rear	BUS RWD 651940	wheel base:3200 mm	Propshaft	PS900567
	2010.09-2014.08	AT	Rear	VAN RWD 651940	wheel base:3200 mm	Propshaft	PS900567
	2010.09-2014.08		-	BUS RWD 651940		Propshaft	PS900390
	2010.09-2014.08		-	VAN RWD 651940		Propshaft	PS900390
	2010.09-2014.08	6MT	-	BUS RWD 651940	Date To:2014.08.For Engine Code OM 646 DE 22 LA,Trans. code:NSG 270	Propshaft	PS900376
	2010.09-2014.08	6MT	-	VAN RWD 651940	Date To:2014.08.For Engine Code OM 646 DE 22 LA,Trans. code:NSG 270	Propshaft	PS900376
	2010.09-2014.08		Front	BUS RWD 651940		Center Bearing Support	531053
	2010.09-2014.08		Front	VAN RWD 651940		Center Bearing Support	531053
	2010.09-2014.08		Rear	BUS RWD 651940		Center Bearing Support	531052
	2010.09-2014.08		Rear	VAN RWD 651940		Center Bearing Support	531052
	2010.09-2014.08		Front	BUS RWD 651940		Center Bearing Support Kit	531021S
	2010.09-2014.08		Front	VAN RWD 651940		Center Bearing Support Kit	531021S
	2010.09-2014.08		Rear	BUS RWD 651940		Center Bearing Support Kit	531020S
	2010.09-2014.08		Rear	VAN RWD 651940		Center Bearing Support Kit	531020S
	2010.09-2014.08		Front;Rear	BUS RWD 651940		Flexible Coupling	533884
	2010.09-2014.08		Front;Rear	VAN RWD 651940		Flexible Coupling	533884
	2010.09-2014.08		Front;Rear	BUS RWD 651940		Flexible Coupling Kit	537832S
	2010.09-2014.08		Front;Rear	VAN RWD 651940		Flexible Coupling Kit	537832S
Vito 111							
2.2 (80 kw)	2003.08-2007.08		Rear	BUS RWD 646982		Propshaft	PS900393
	2003.08-2007.08		Rear	VAN RWD 646982		Propshaft	PS900393
	2003.08-2007.08	AT	Rear	BUS RWD 646982	Date From:2007.09.2007.09,Chassis no. from:38718A.For Engine Code OM 611 DE 22 LA,OM 646 DE 22 LA	Propshaft	PS900381
	2003.08-2007.08	AT	Rear	VAN RWD 646982	Date From:2007.09.2007.09,Chassis no. from:38718A.For Engine Code OM 611 DE 22 LA,OM 646 DE 22 LA	Propshaft	PS900381
	2003.08-2007.08	6MT	-	BUS RWD 646982	Date To:2007.08.For Engine Code OM 646 DE 22 LA,OM 611 DE 22 LA,Trans. code:NSG 270	Propshaft	PS900379
	2003.08-2007.08	6MT	-	VAN RWD 646982	Date To:2007.08.For Engine Code OM 646 DE 22 LA,OM 611 DE 22 LA,Trans. code:NSG 270	Propshaft	PS900379
	2003.08-2007.08	AT	-	BUS RWD 646982		Propshaft	PS900390
	2003.08-2007.08	AT	-	VAN RWD 646982		Propshaft	PS900390
	2003.08-2007.08		Front	BUS RWD 646982		Center Bearing Support	531053
	2003.08-2007.08		Front	VAN RWD 646982		Center Bearing Support	531053
	2003.08-2007.08		Rear	BUS RWD 646982		Center Bearing Support	531052
	2003.08-2007.08		Rear	VAN RWD 646982		Center Bearing Support	531052
	2003.08-2007.08		Front	BUS RWD 646982		Center Bearing Support Kit	531021S
	2003.08-2007.08		Front	VAN RWD 646982		Center Bearing Support Kit	531021S
	2003.08-2007.08		Rear	BUS RWD 646982		Center Bearing Support Kit	531020S
	2003.08-2007.08		Rear	VAN RWD 646982		Center Bearing Support Kit	531020S
	2003.08-2007.08		Front;Rear	BUS RWD 646982		Flexible Coupling	533884
	2003.08-2007.08		Front;Rear	VAN RWD 646982		Flexible Coupling	533884
	2003.08-2007.08		Front;Rear	BUS RWD 646982		Flexible Coupling Kit	537832S
	2003.08-2007.08		Front;Rear	VAN RWD 646982		Flexible Coupling Kit	537832S
	2007.09-2014.08		Rear	BUS 4WD 646982		Propshaft	PS900393
	2007.09-2014.08		Rear	VAN 4WD 646982		Propshaft	PS900393
	2007.09-2014.08		-	BUS 4WD 646982		Propshaft	PS900390
	2007.09-2014.08		-	VAN 4WD 646982		Propshaft	PS900390
	2007.09-2014.08	6MT	-	BUS 4WD 646982	Date To:2014.08.For Engine Code OM 646 DE 22 LA,OM 611 DE 22 LA,Trans. code:NSG 270	Propshaft	PS900379
	2007.09-2014.08	6MT	-	VAN 4WD 646982	Date To:2014.08.For Engine Code OM 646 DE 22 LA,OM 611 DE 22 LA,Trans. code:NSG 270	Propshaft	PS900379
	2007.09-2014.08		Front	BUS 4WD 646982		Center Bearing Support	531053
	2007.09-2014.08		Front	VAN 4WD 646982		Center Bearing Support	531053
	2007.09-2014.08		Rear	BUS 4WD 646982		Center Bearing Support	531052



	 YEAR	TRANSM.	FITTING POSITION	BODY STYLE & DRIVE TYPE & ENGINE	REMARKS	 PRODUCT	GSP Ref.
MERCEDES-BENZ							
Vito 111							
2.2 (80 kw)	2007.09-2014.08		Rear	VAN 4WD 646982		Center Bearing Support	531052
	2007.09-2014.08		Front	BUS 4WD 646982		Center Bearing Support Kit	531021S
	2007.09-2014.08		Front	VAN 4WD 646982		Center Bearing Support Kit	531021S
	2007.09-2014.08		Rear	BUS 4WD 646982		Center Bearing Support Kit	531020S
	2007.09-2014.08		Rear	VAN 4WD 646982		Center Bearing Support Kit	531020S
	2007.09-2014.08		Front;Rear	BUS 4WD 646982		Flexible Coupling	533884
	2007.09-2014.08		Front;Rear	VAN 4WD 646982		Flexible Coupling	533884
	2007.09-2014.08		Front;Rear	BUS 4WD 646982		Flexible Coupling Kit	537832S
2.2 (85 kw)	2006.08-2014.08		Rear	BUS RWD 646980/646982		Propshaft	PS900393
	2006.08-2014.08		-	BUS RWD 646980/646982		Propshaft	PS900390
	2006.08-2014.08		Front	BUS RWD 646980/646982		Center Bearing Support	531053
	2006.08-2014.08		Rear	BUS RWD 646980/646982		Center Bearing Support	531052
	2006.08-2014.08		Front	BUS RWD 646980/646982		Center Bearing Support Kit	531021S
	2006.08-2014.08		Rear	BUS RWD 646980/646982		Center Bearing Support Kit	531020S
	2006.08-2014.08		Front;Rear	BUS RWD 646980/646982		Flexible Coupling	533884
	2006.08-2014.08		Front;Rear	BUS RWD 646980/646982		Flexible Coupling Kit	537832S
	2007.09-2014.08		Rear	VAN RWD 646982		Propshaft	PS900393
	2007.09-2014.08	AT	Rear	VAN RWD 646982	<small>Date To: 2014.08, Chassis No. from: 961209 For Engine Code: 206111 10 211A/206111 10 211A</small>	Propshaft	PS900381
	2007.09-2014.08		-	VAN RWD 646982		Propshaft	PS900390
	2007.09-2014.08		Front	VAN RWD 646982		Center Bearing Support	531053
	2007.09-2014.08		Rear	VAN RWD 646982		Center Bearing Support	531052
	2007.09-2014.08		Front	VAN RWD 646982		Center Bearing Support Kit	531021S
	2007.09-2014.08		Rear	VAN RWD 646982		Center Bearing Support Kit	531020S
	2007.09-2014.08		Front;Rear	VAN RWD 646982		Flexible Coupling	533884
	2007.09-2014.08		Front;Rear	VAN RWD 646982		Flexible Coupling Kit	537832S
Vito 113							
2.2 (100 kw)	2010.09-2014.08		Rear	BUS RWD 651940		Propshaft	PS900393
	2010.09-2014.08		Rear	VAN RWD 651940		Propshaft	PS900393
	2010.09-2014.08		Rear	BUS 4WD 651940		Propshaft	PS900393
	2010.09-2014.08		Rear	VAN 4WD 651940		Propshaft	PS900393
	2010.09-2014.08	AT	Rear	BUS RWD 651940	wheel base:3200 mm	Propshaft	PS900567
	2010.09-2014.08	AT	Rear	VAN RWD 651940	wheel base:3200 mm	Propshaft	PS900567
	2010.09-2014.08		-	BUS RWD 651940		Propshaft	PS900390
	2010.09-2014.08		-	VAN RWD 651940		Propshaft	PS900390
	2010.09-2014.08		-	BUS 4WD 651940		Propshaft	PS900390
	2010.09-2014.08		-	VAN 4WD 651940		Propshaft	PS900390
	2010.09-2014.08		Front	BUS RWD 651940		Center Bearing Support	531053
	2010.09-2014.08		Front	VAN RWD 651940		Center Bearing Support	531053
	2010.09-2014.08		Front	BUS 4WD 651940		Center Bearing Support	531053
	2010.09-2014.08		Rear	BUS RWD 651940		Center Bearing Support	531052
	2010.09-2014.08		Rear	VAN RWD 651940		Center Bearing Support	531052
	2010.09-2014.08		Rear	BUS 4WD 651940		Center Bearing Support	531052
	2010.09-2014.08		Rear	VAN 4WD 651940		Center Bearing Support	531052
	2010.09-2014.08		Front	BUS RWD 651940		Center Bearing Support Kit	531021S
	2010.09-2014.08		Front	VAN RWD 651940		Center Bearing Support Kit	531021S
	2010.09-2014.08		Front	BUS 4WD 651940		Center Bearing Support Kit	531021S
	2010.09-2014.08		Front	VAN 4WD 651940		Center Bearing Support Kit	531021S
	2010.09-2014.08		Rear	BUS RWD 651940		Center Bearing Support Kit	531020S
	2010.09-2014.08		Rear	VAN RWD 651940		Center Bearing Support Kit	531020S
	2010.09-2014.08		Rear	BUS 4WD 651940		Center Bearing Support Kit	531020S
	2010.09-2014.08		Rear	VAN 4WD 651940		Center Bearing Support Kit	531020S
	2010.09-2014.08		Front;Rear	BUS RWD 651940		Flexible Coupling	533884
	2010.09-2014.08		Front;Rear	VAN RWD 651940		Flexible Coupling	533884
	2010.09-2014.08		Front;Rear	BUS 4WD 651940		Flexible Coupling	533884
	2010.09-2014.08		Front;Rear	VAN 4WD 651940		Flexible Coupling	533884
	2010.09-2014.08		Front;Rear	BUS RWD 651940		Flexible Coupling Kit	537832S
	2010.09-2014.08		Front;Rear	VAN RWD 651940		Flexible Coupling Kit	537832S
	2010.09-2014.08		Front;Rear	BUS 4WD 651940		Flexible Coupling Kit	537832S
	2010.09-2014.08		Front;Rear	VAN 4WD 651940		Flexible Coupling Kit	537832S
Vito 115							
2.2 (110 kw)	2003.08-2014.08		Rear	VAN RWD 646980/646982		Propshaft	PS900393
	2003.08-2014.08		Rear	BUS RWD 646980/646982		Propshaft	PS900393
	2003.08-2014.08	AT	Rear	BUS RWD 646980/646982	<small>Date From: 2007.03.20, Chassis No. from: 961209 For Engine Code: 206111 10 211A/206111 10 211A</small>	Propshaft	PS900381

	 YEAR	TRANSM.	FITTING POSITION	BODY STYLE & DRIVE TYPE & ENGINE	REMARKS	 PRODUCT	GSP Ref.
MERCEDES-BENZ							
Vito 115							
2.2 (110 kw)							
	2003.08-2014.08	6MT	-	BUS RWD 646980/646982	<small>Date To:2014.08,For Engine Codes:OM 646 DE 22 LA,OM 611 DE 22 LA,Trans. code:NG5 291</small>	Propshaft	PS900379
	2003.08-2014.08	AT	-	VAN RWD 646980/646982		Propshaft	PS900390
	2003.08-2014.08	AT	-	BUS RWD 646980/646982		Propshaft	PS900390
	2003.08-2014.08		Front	VAN RWD 646980/646982		Center Bearing Support	531053
	2003.08-2014.08		Front	BUS RWD 646980/646982		Center Bearing Support	531053
	2003.08-2014.08		Rear	VAN RWD 646980/646982		Center Bearing Support	531052
	2003.08-2014.08		Rear	BUS RWD 646980/646982		Center Bearing Support	531052
	2003.08-2014.08		Front	VAN RWD 646980/646982		Center Bearing Support Kit	531021S
	2003.08-2014.08		Front	BUS RWD 646980/646982		Center Bearing Support Kit	531021S
	2003.08-2014.08		Rear	VAN RWD 646980/646982		Center Bearing Support Kit	531020S
	2003.08-2014.08		Rear	BUS RWD 646980/646982		Center Bearing Support Kit	531020S
	2003.08-2014.08		Front;Rear	VAN RWD 646980/646982		Flexible Coupling	533884
	2003.08-2014.08		Front;Rear	BUS RWD 646980/646982		Flexible Coupling	533884
	2003.08-2014.08		Front;Rear	VAN RWD 646980/646982		Flexible Coupling Kit	537832S
	2003.08-2014.08		Front;Rear	BUS RWD 646980/646982		Flexible Coupling Kit	537832S
	2006.07-2014.08		Rear	VAN 4WD 646982		Propshaft	PS900393
	2006.07-2014.08		-	VAN 4WD 646982		Propshaft	PS900390
	2006.07-2014.08	6MT	-	VAN 4WD 646982	<small>Date To:2014.08,For Engine Codes:OM 646 DE 22 LA,OM 611 DE 22 LA,Trans. code:NG5 291</small>	Propshaft	PS900379
	2006.07-2014.08		Front	VAN 4WD 646982		Center Bearing Support	531053
	2006.07-2014.08		Rear	VAN 4WD 646982		Center Bearing Support	531052
	2006.07-2014.08		Front	VAN 4WD 646982		Center Bearing Support Kit	531021S
	2006.07-2014.08		Rear	VAN 4WD 646982		Center Bearing Support Kit	531020S
	2006.07-2014.08		Front;Rear	VAN 4WD 646982		Flexible Coupling	533884
	2006.07-2014.08		Front;Rear	VAN 4WD 646982		Flexible Coupling Kit	537832S
	2007.09-2014.08		Rear	BUS 4WD 646982		Propshaft	PS900393
	2007.09-2014.08		-	BUS 4WD 646982		Propshaft	PS900390
	2007.09-2014.08	6MT	-	BUS 4WD 646982	<small>Date To:2014.08,For Engine Codes:OM 646 DE 22 LA,OM 611 DE 22 LA,Trans. code:NG5 291</small>	Propshaft	PS900379
	2007.09-2014.08		Front	BUS 4WD 646982		Center Bearing Support	531053
	2007.09-2014.08		Rear	BUS 4WD 646982		Center Bearing Support	531052
	2007.09-2014.08		Front	BUS 4WD 646982		Center Bearing Support Kit	531021S
	2007.09-2014.08		Rear	BUS 4WD 646982		Center Bearing Support Kit	531020S
	2007.09-2014.08		Front;Rear	BUS 4WD 646982		Flexible Coupling	533884
	2007.09-2014.08		Front;Rear	BUS 4WD 646982		Flexible Coupling Kit	537832S
Vito 116							
2.2 (120 kw)							
	2010.09-2014.08		Rear	BUS RWD 651940		Propshaft	PS900393
	2010.09-2014.08		Rear	VAN RWD 651940		Propshaft	PS900393
	2010.09-2014.08		Rear	VAN 4WD 651940		Propshaft	PS900393
	2010.09-2014.08		Rear	BUS 4WD 651940		Propshaft	PS900393
	2010.09-2014.08	AT	Rear	BUS RWD 651940	wheel base:3200 mm	Propshaft	PS900567
	2010.09-2014.08	AT	Rear	VAN RWD 651940	wheel base:3200 mm	Propshaft	PS900567
	2010.09-2014.08		-	BUS RWD 651940		Propshaft	PS900390
	2010.09-2014.08		-	VAN RWD 651940		Propshaft	PS900390
	2010.09-2014.08		-	VAN 4WD 651940		Propshaft	PS900390
	2010.09-2014.08		-	BUS 4WD 651940		Propshaft	PS900390
	2010.09-2014.08		Front	BUS RWD 651940		Center Bearing Support	531053
	2010.09-2014.08		Front	VAN RWD 651940		Center Bearing Support	531053
	2010.09-2014.08		Front	BUS 4WD 651940		Center Bearing Support	531053
	2010.09-2014.08		Rear	BUS RWD 651940		Center Bearing Support	531052
	2010.09-2014.08		Rear	VAN RWD 651940		Center Bearing Support	531052
	2010.09-2014.08		Rear	VAN 4WD 651940		Center Bearing Support	531052
	2010.09-2014.08		Rear	BUS 4WD 651940		Center Bearing Support	531052
	2010.09-2014.08		Front	BUS RWD 651940		Center Bearing Support Kit	531021S
	2010.09-2014.08		Front	VAN RWD 651940		Center Bearing Support Kit	531021S
	2010.09-2014.08		Front	VAN 4WD 651940		Center Bearing Support Kit	531021S
	2010.09-2014.08		Front	BUS 4WD 651940		Center Bearing Support Kit	531021S
	2010.09-2014.08		Rear	BUS RWD 651940		Center Bearing Support Kit	531020S
	2010.09-2014.08		Rear	VAN RWD 651940		Center Bearing Support Kit	531020S
	2010.09-2014.08		Rear	VAN 4WD 651940		Center Bearing Support Kit	531020S
	2010.09-2014.08		Rear	BUS 4WD 651940		Center Bearing Support Kit	531020S
	2010.09-2014.08		Front;Rear	BUS RWD 651940		Flexible Coupling	533884
	2010.09-2014.08		Front;Rear	VAN RWD 651940		Flexible Coupling	533884
	2010.09-2014.08		Front;Rear	VAN 4WD 651940		Flexible Coupling	533884
	2010.09-2014.08		Front;Rear	BUS 4WD 651940		Flexible Coupling	533884
	2010.09-2014.08		Front;Rear	BUS RWD 651940		Flexible Coupling Kit	537832S

	 YEAR	TRANSM.	FITTING POSITION	BODY STYLE & DRIVE TYPE & ENGINE	REMARKS	 PRODUCT	GSP Ref.
MERCEDES-BENZ							
Vito 116							
2.2 (120 kw)	2010.09-2014.08		Front;Rear	VAN RWD 651940		Flexible Coupling Kit	537832S
	2010.09-2014.08		Front;Rear	VAN 4WD 651940		Flexible Coupling Kit	537832S
	2010.09-2014.08		Front;Rear	BUS 4WD 651940		Flexible Coupling Kit	537832S
Vito 119							
3.2 (140 kw)	2003.08-2008.07		Rear	BUS RWD 112951		Propshaft	PS900393
	2003.08-2008.07		Rear	VAN RWD 112951		Propshaft	PS900393
	2003.08-2008.07		-	BUS RWD 112951		Propshaft	PS900390
	2003.08-2008.07		-	VAN RWD 112951		Propshaft	PS900390
	2003.08-2008.07		Front	BUS RWD 112951		Center Bearing Support	531053
	2003.08-2008.07		Front	VAN RWD 112951		Center Bearing Support	531053
	2003.08-2008.07		Rear	BUS RWD 112951		Center Bearing Support	531052
	2003.08-2008.07		Rear	VAN RWD 112951		Center Bearing Support	531052
	2003.08-2008.07		Front	BUS RWD 112951		Center Bearing Support Kit	531021S
	2003.08-2008.07		Front	VAN RWD 112951		Center Bearing Support Kit	531021S
	2003.08-2008.07		Rear	BUS RWD 112951		Center Bearing Support Kit	531020S
	2003.08-2008.07		Rear	VAN RWD 112951		Center Bearing Support Kit	531020S
	2003.08-2008.07		Front;Rear	BUS RWD 112951		Flexible Coupling	533884
	2003.08-2008.07		Front;Rear	VAN RWD 112951		Flexible Coupling	533884
	2003.08-2008.07		Front;Rear	BUS RWD 112951		Flexible Coupling Kit	537832S
	2003.08-2008.07		Front;Rear	VAN RWD 112951		Flexible Coupling Kit	537832S
	Vito 120						
3.0 (150 kw)	2006.03-2014.08		Rear	BUS RWD 642990		Propshaft	PS900393
	2006.03-2014.08		Rear	VAN RWD 642990		Propshaft	PS900393
	2006.03-2014.08		-	BUS RWD 642990		Propshaft	PS900390
	2006.03-2014.08		-	VAN RWD 642990		Propshaft	PS900390
	2006.03-2014.08		Front	BUS RWD 642990		Center Bearing Support	531053
	2006.03-2014.08		Front	VAN RWD 642990		Center Bearing Support	531053
	2006.03-2014.08		Rear	BUS RWD 642990		Center Bearing Support	531052
	2006.03-2014.08		Rear	VAN RWD 642990		Center Bearing Support	531052
	2006.03-2014.08		Front	BUS RWD 642990		Center Bearing Support Kit	531021S
	2006.03-2014.08		Front	VAN RWD 642990		Center Bearing Support Kit	531021S
	2006.03-2014.08		Rear	BUS RWD 642990		Center Bearing Support Kit	531020S
	2006.03-2014.08		Rear	VAN RWD 642990		Center Bearing Support Kit	531020S
	2006.03-2014.08		Front;Rear	BUS RWD 642990		Flexible Coupling	533884
	2006.03-2014.08		Front;Rear	VAN RWD 642990		Flexible Coupling	533884
	2006.03-2014.08		Front;Rear	BUS RWD 642990		Flexible Coupling Kit	537832S
	2006.03-2014.08		Front;Rear	VAN RWD 642990		Flexible Coupling Kit	537832S
	Vito 122						
3.0 (165 kw)	2010.09-2014.08		Rear	BUS RWD 642890		Propshaft	PS900393
	2010.09-2014.08		Rear	VAN RWD 642890		Propshaft	PS900393
	2010.09-2014.08		-	BUS RWD 642890		Propshaft	PS900390
	2010.09-2014.08		-	VAN RWD 642890		Propshaft	PS900390
	2010.09-2014.08		Front	BUS RWD 642890		Center Bearing Support	531053
	2010.09-2014.08		Front	VAN RWD 642890		Center Bearing Support	531053
	2010.09-2014.08		Front;Rear	VAN RWD 642890		Flexible Coupling	533884
	2010.09-2014.08		Front;Rear	VAN RWD 642890		Flexible Coupling Kit	537832S
3.2 (160 kw)	2003.08-2004.09		Rear	BUS RWD 112951		Propshaft	PS900393
	2003.08-2004.09		Rear	VAN RWD 112951		Propshaft	PS900393
	2003.08-2004.09		-	BUS RWD 112951		Propshaft	PS900390
	2003.08-2004.09		-	VAN RWD 112951		Propshaft	PS900390
	2003.08-2004.09		Front	BUS RWD 112951		Center Bearing Support	531053
	2003.08-2004.09		Front	VAN RWD 112951		Center Bearing Support	531053
	2003.08-2004.09		Rear	BUS RWD 112951		Center Bearing Support	531052
	2003.08-2004.09		Rear	VAN RWD 112951		Center Bearing Support	531052
	2003.08-2004.09		Front	BUS RWD 112951		Center Bearing Support Kit	531021S
	2003.08-2004.09		Front	VAN RWD 112951		Center Bearing Support Kit	531021S
	2003.08-2004.09		Rear	BUS RWD 112951		Center Bearing Support Kit	531020S
	2003.08-2004.09		Rear	VAN RWD 112951		Center Bearing Support Kit	531020S
	2003.08-2004.09		Front;Rear	BUS RWD 112951		Flexible Coupling	533884
	2003.08-2004.09		Front;Rear	VAN RWD 112951		Flexible Coupling	533884
2003.08-2004.09		Front;Rear	BUS RWD 112951		Flexible Coupling Kit	537832S	
2003.08-2004.09		Front;Rear	VAN RWD 112951		Flexible Coupling Kit	537832S	



	 YEAR	TRANSM.	FITTING POSITION	BODY STYLE & DRIVE TYPE & ENGINE	REMARKS	 PRODUCT	GSP Ref.
MERCEDES-BENZ							
Vito 123							
3.7 (165 kw)	2004.06-2008.07		Rear	BUS RWD 112976		Propshaft	PS900393
	2004.06-2008.07		Rear	VAN RWD 112976		Propshaft	PS900393
	2004.06-2008.07		-	BUS RWD 112976		Propshaft	PS900390
	2004.06-2008.07		-	VAN RWD 112976		Propshaft	PS900390
	2004.06-2008.07		Rear	VAN RWD 112976		Center Bearing Support	531052
	2004.06-2008.07		Front	BUS RWD 112976		Center Bearing Support Kit	531021S
	2004.06-2008.07		Front	VAN RWD 112976		Center Bearing Support Kit	531021S
	2004.06-2008.07		Front;Rear	VAN RWD 112976		Flexible Coupling	533884
	2004.06-2008.07		Front;Rear	BUS RWD 112976		Flexible Coupling Kit	537832S
3.7 (170 kw)	2004.06-2008.07		Rear	BUS RWD 112976		Propshaft	PS900393
	2004.06-2008.07		Rear	VAN RWD 112976		Propshaft	PS900393
	2004.06-2008.07		-	BUS RWD 112976		Propshaft	PS900390
	2004.06-2008.07		-	VAN RWD 112976		Propshaft	PS900390
	2004.06-2008.07		Front	BUS RWD 112976		Center Bearing Support	531053
	2004.06-2008.07		Front	VAN RWD 112976		Center Bearing Support	531053
	2004.06-2008.07		Rear	BUS RWD 112976		Center Bearing Support	531052
	2004.06-2008.07		Rear	VAN RWD 112976		Center Bearing Support	531052
	2004.06-2008.07		Front	BUS RWD 112976		Center Bearing Support Kit	531021S
	2004.06-2008.07		Front	VAN RWD 112976		Center Bearing Support Kit	531021S
	2004.06-2008.07		Rear	BUS RWD 112976		Center Bearing Support Kit	531020S
	2004.06-2008.07		Rear	VAN RWD 112976		Center Bearing Support Kit	531020S
	2004.06-2008.07		Front;Rear	BUS RWD 112976		Flexible Coupling	533884
	2004.06-2008.07		Front;Rear	VAN RWD 112976		Flexible Coupling	533884
	2004.06-2008.07		Front;Rear	BUS RWD 112976		Flexible Coupling Kit	537832S
	2004.06-2008.07		Front;Rear	VAN RWD 112976		Flexible Coupling Kit	537832S
Vito 126							
3.5 (190 kw)	2007.09-2014.08		Rear	BUS RWD 272978		Propshaft	PS900393
	2007.09-2014.08		Rear	VAN RWD 272978		Propshaft	PS900393
	2007.09-2014.08		-	BUS RWD 272978		Propshaft	PS900390
	2007.09-2014.08		-	VAN RWD 272978		Propshaft	PS900390
	2007.09-2014.08		Front	BUS RWD 272978		Center Bearing Support	531053
	2007.09-2014.08		Front	VAN RWD 272978		Center Bearing Support	531053
	2007.09-2014.08		Rear	BUS RWD 272978		Center Bearing Support	531052
	2007.09-2014.08		Rear	VAN RWD 272978		Center Bearing Support	531052
	2007.09-2014.08		Front	BUS RWD 272978		Center Bearing Support Kit	531021S
	2007.09-2014.08		Front	VAN RWD 272978		Center Bearing Support Kit	531021S
	2007.09-2014.08		Rear	BUS RWD 272978		Center Bearing Support Kit	531020S
	2007.09-2014.08		Rear	VAN RWD 272978		Center Bearing Support Kit	531020S
	2007.09-2014.08		Front;Rear	BUS RWD 272978		Flexible Coupling	533884
	2007.09-2014.08		Front;Rear	VAN RWD 272978		Flexible Coupling	533884
	2007.09-2014.08		Front;Rear	BUS RWD 272978		Flexible Coupling Kit	537832S
	2007.09-2014.08		Front;Rear	VAN RWD 272978		Flexible Coupling Kit	537832S
MERCURY							
Mountaineer							
4.0 (157 kw)	2005.09-2010.12		Front	SUV 4WD V99E		Joint,propshaft	661100
MINI							
Mini Countryman							
1.6 (82 kw)	2010.08-2016.10		Front	Estate 4WD N47C16A		Flexible Coupling	510641
1.6 (90 kw)	2014.11-2016.10		Front	Estate 4WD N16B16A/N18B16A		Flexible Coupling	510641
1.6 (120 kw)	2010.06-2016.10		Front	Estate 4WD N18B16A		Flexible Coupling	510641
1.6 (135 kw)	2010.08-2016.10		Front	Estate 4WD N18B16A		Flexible Coupling	510641
1.6 (140 kw)	2014.07-2016.10		Front	Estate 4WD N18B16A		Flexible Coupling	510641
1.6 (160 kw)	2012.11-2016.10		Front	Estate 4WD N18B16C		Flexible Coupling	510641
2.0 (82 kw)	2011.03-2016.09		Front	Estate 4WD N47C20A		Flexible Coupling	510641
2.0 (100 kw)	2011.03-2016.10		Front	Estate 4WD N47C20A		Flexible Coupling	510641
2.0 (105 kw)	2011.03-2016.09		Front	Estate 4WD N47C20A		Flexible Coupling	510641
Mini Paceman							
1.6 (82 kw)	2013.01-2016.09		Front	Coupe 4WD N47C16A		Flexible Coupling	510641
1.6 (85 kw)	2013.07-2016.09		Front	Coupe 4WD N16B16A		Flexible Coupling	510641
1.6 (90 kw)	2013.05-2016.09		Front	Coupe 4WD N16B16A/N18B16A		Flexible Coupling	510641
1.6 (120 kw)	2013.07-2016.09		Front	Coupe 4WD N18B16A		Flexible Coupling	510641
1.6 (135 kw)	2013.01-2016.09		Front	Coupe 4WD N18B16A		Flexible Coupling	510641



	 YEAR	TRANSM.	FITTING POSITION	BODY STYLE & DRIVE TYPE & ENGINE	REMARKS	 PRODUCT	GSP Ref.
MINI							
Mini Paceman							
1.6 (140 kw)	2014.07-2016.09		Front	Coupe 4WD N18B16A		Flexible Coupling	510641
1.6 (160 kw)	2013.01-2016.10		Front	Coupe 4WD N18B16C		Flexible Coupling	510641
2.0 (82 kw)	2013.01-2016.09		Front	Coupe 4WD N47C20A		Flexible Coupling	510641
2.0 (100 kw)	2012.10-2016.09		Front	Coupe 4WD N47C20A		Flexible Coupling	510641
2.0 (105 kw)	2013.01-2016.09		Front	Coupe 4WD N47C20A		Flexible Coupling	510641
MITSUBISHI							
3000 GT							
3.0 (165 kw)	1989.06-1999.08		Centre	Coupe 4WD 6G72DOHC		Center Bearing Support	514786
3.0 (210 kw)	1992.06-1999.06		Centre	Coupe 4WD 6G72DOHCT		Center Bearing Support	514786
Airtrek							
2.0 (100 kw)	2003.05-2006.10		Front	SUV FWD 4G63DOHC		Center Bearing Support	530440
2.0 (177 kw)	2002.03-2006.10		Front	SUV 4WD 4G63DOHC		Center Bearing Support	530440
	2002.03-2006.10		Rear	SUV 4WD 4G63DOHC		Center Bearing Support	514821
ASX							
2.0 (110 kw)	2010.04-	AT/MT	Rear	SUV 4WD 4B11/4J11	Date To:2012.03	Propshaft	PS900401
Challenger							
2.0 (95 kw)	2001.10-2005.02		Centre	Terrain cab wagon closed 4WD 4G94DOHC		Center Bearing Support	514819
Challenger/Pajero Sport/Montero Sport							
2.5 (131 kw)	2008.07-2015.12		Centre	Closed Off-Road Vehicle RWD 4D56-HP		Center Bearing Support	514797
Chariot							
1.8 (90 kw)	1991.10-1998.10		Centre	MPV 4WD 4G93		Center Bearing Support	514786
2.4 (86 kw)	1991.10-1997.10		Centre	MPV 4WD 4G64S		Center Bearing Support	514786
Chariot Grandis							
2.4 (108 kw)	2000.09-2003.05		Centre	MPV 4WD 4G64DOHCB		Center Bearing Support	514820
2.4 (110 kw)	1998.10-2000.07		Centre	MPV 4WD 4G64DOHCB		Center Bearing Support	514820
3.0 (158 kw)	2000.05-2003.05		Centre	MPV 4WD 6G72DOHCB		Center Bearing Support	514820
Eclipse							
2.0 (110 kw)	1991.04-1994.08		Centre	Coupe 4WD 4G63DOHC		Center Bearing Support	514786
2.0 (157 kw)	1989.12-1994.03		Centre	Coupe 4WD 4G63DOHC		Center Bearing Support	514786
Expo LRV/RVR							
1.8 (84 kw)	1992.09-1993.12		Centre	Station Wagon AWD 4G93(SOHC 16V)		Center Bearing Support	514786
G-Wagon							
2.8 (92 kw)	1997.11-2001.09		Centre	Terrain cab wagon closed 4WD 4M40T		Center Bearing Support	514819
Galant							
2.0 (80 kw)	1988.01-1992.10		Centre	Hatchback 4WD 4G63		Center Bearing Support	514786
	1988.01-1992.10		Centre	Saloon 4WD 4G63		Center Bearing Support	514786
2.0 (106 kw)	1988.06-1992.10		Centre	Saloon 4WD 4G63DOHC		Center Bearing Support	514786
	1989.07-1992.10		Centre	Hatchback 4WD 4G63DOHC		Center Bearing Support	514786
2.0 (107 kw)	1988.11-1992.10		Centre	Hatchback AWD 4G63(DOHC 16V)		Center Bearing Support	514786
2.0 (110 kw)	1991.09-1992.10		Centre	Saloon 4WD 4G63DOHC		Center Bearing Support	514786
GTO							
3.0 (163 kw)	1996.05-2000.08		Centre	Coupe 4WD 6G72DOHC		Center Bearing Support	514786
3.0 (165 kw)	1989.06-1996.04		Centre	Coupe 4WD 6G72DOHC		Center Bearing Support	514786
3.0 (206 kw)	1996.05-2000.09		Centre	Coupe 4WD 6G72DOHCT		Center Bearing Support	514786
3.0 (210 kw)	1990.01-2000.12		Centre	Coupe 4WD 6G72DOHCT		Center Bearing Support	514786
I.O							
1.8 (88 kw)	1999.06-2005.02	AT	Front	Terrain cab wagon closed 4WD 4G93DOHCB		Propshaft	PS900397
	1999.06-2005.02	MT	Front	Terrain cab wagon closed 4WD 4G93DOHCB		Propshaft	PS900431
	1999.06-2005.02	MT	Rear	Terrain cab wagon closed 4WD 4G93DOHCB		Propshaft	PS900432
2.0 (95 kw)	2001.10-2005.02	AT	Front	Terrain cab wagon closed 4WD 4G94DOHC		Propshaft	PS900397
	2001.10-2005.02	MT	Front	Terrain cab wagon closed 4WD 4G94DOHC		Propshaft	PS900431
L200							
2.0 (63 kw)	1987.02-1994.05		Centre	Pick up 4WD 4G63		Center Bearing Support	514819
2.0 (75 kw)	1986.11-1994.05		Centre	Pick up 4WD 4G63		Center Bearing Support	514819
2.0 (90 kw)	1996.09-2001.07		Centre	Pick up RWD 4G63S		Center Bearing Support	513582
2.4 (97 kw)	1996.09-2004.08		Centre	Pick up 4WD 4G64S		Center Bearing Support	514819
	2011.08-2015.12		Centre	Pick up RWD 4G64S		Center Bearing Support	514797
	2014.11-		Centre	Pick up 4WD 4G64		Center Bearing Support	514797
	2014.11-		Centre	Pick up RWD 4G64		Center Bearing Support	514797
2.4 (113 kw)	2015.09-		Front	Pick up 4WD 4N15		Propshaft	PS900582
	2015.09-		Rear	Pick up 4WD 4N15		Propshaft	PS900633
2.4 (133 kw)	2015.09-		Centre	Pick up 4WD 4N15		Center Bearing Support	514797
2.5 (51 kw)	1986.11-1996.08		Centre	Pick up RWD 4D56		Center Bearing Support	513582



	 YEAR	TRANSM.	FITTING POSITION	BODY STYLE & DRIVE TYPE & ENGINE	REMARKS	 PRODUCT	GSP Ref.
MITSUBISHI L200							
2.5 (55 kw)	1996.09-2005.03		Centre	Pick up RWD 4D56		Center Bearing Support	513582
	2011.08-2015.12		Centre	Pick up 4WD 4D56		Center Bearing Support	514797
	2011.08-2015.12		Centre	Pick up RWD 4D56		Center Bearing Support	514797
2.5 (64 kw)	1987.12-1996.08		Centre	Pick up 4WD 4D56		Center Bearing Support	514819
2.5 (66 kw)	2011.08-2015.12		Centre	Pick up RWD 4D56TD		Center Bearing Support	514797
2.5 (73 kw)	1996.09-2007.12		Centre	Pick up 4WD 4D56		Center Bearing Support	514819
2.5 (74 kw)	2001.08-2005.09		Centre	Pick up 4WD 4D56		Center Bearing Support	514819
2.5 (81 kw)	2014.11-		Centre	Pick up 4WD 4D56DOHC		Center Bearing Support	514797
	2016.01-		Centre	Pick up RWD 4D56DOHC		Center Bearing Support	514797
2.5 (85 kw)	2001.08-2005.11		Centre	Pick up 4WD 4D56T		Center Bearing Support	514819
2.5 (94 kw)	2007.08-2015.12		Centre	Chassis cabin RWD 4D56DOHC		Center Bearing Support	514797
	2010.04-2015.12		-	Pick up RWD 4D56DOHC		Propshaft	PS900399
	2010.04-2015.12		Centre	Pick up RWD 4D56DOHC		Center Bearing Support	514797
	2014.11-		Centre	Pick up RWD 4D56DOHC		Center Bearing Support	514797
2.5 (98 kw)	2001.08-2005.11		Centre	Pick up 4WD 4D56		Center Bearing Support	514819
	2005.11-2015.12		Centre	Pick up 4WD 4D56DOHC		Center Bearing Support	514797
2.5 (100 kw)	2005.11-2015.12	4AT/5MT	-	Pick up 4WD 4D56DOHC		Propshaft	PS900399
	2005.11-2015.12		Centre	Pick up 4WD 4D56DOHC		Center Bearing Support	514797
	2005.11-2015.12		Centre	Pick up RWD 4D56DOHC		Center Bearing Support	514797
	2014.11-		Centre	Pick up RWD 4D56DOHC		Center Bearing Support	514797
2.5 (103 kw)	2010.04-2015.12		Centre	Pick up 4WD 4D56DOHC		Center Bearing Support	514797
2.5 (123 kw)	2007.08-2015.12		-	Pick up RWD 4D56DOHC		Propshaft	PS900399
	2007.08-2015.12		Centre	Pick up RWD 4D56DOHC		Center Bearing Support	514797
	2007.10-2015.12	4AT/5MT	-	Pick up 4WD 4D56DOHC		Propshaft	PS900399
	2007.10-2015.12		Centre	Pick up 4WD 4D56DOHC		Center Bearing Support	514797
2.5 (131 kw)	2009.06-2015.12	4AT/5AT/5MT	-	Pick up 4WD 4D56DOHC		Propshaft	PS900399
	2009.06-2015.12		Centre	Pick up 4WD 4D56DOHC		Center Bearing Support	514797
	2009.09-2015.12		Centre	Chassis cabin 4WD 4D56DOHC		Center Bearing Support	514797
	2013.03-2015.12		Centre	Pick up RWD 4D56DOHC		Center Bearing Support	514797
	2014.11-		Centre	Pick up RWD 4D56DOHC		Center Bearing Support	514797
2.6 (76 kw)	1989.11-1995.05		Centre	Pick up 4WD G54B		Center Bearing Support	514819
3.0 (108 kw)	1996.06-2006.08		Centre	Pick up 4WD 6G72SOHC		Center Bearing Support	514819
3.5 (137 kw)	2011.08-2015.12		Centre	Pick up 4WD 6G74SOHC		Center Bearing Support	514797
3.5 (147 kw)	2009.09-2015.12		Centre	Pick up 4WD 6G74DOHC		Center Bearing Support	514797
L200/Triton/Hunter							
2.4 (94 kw)	2005.11-2015.12		Centre	Pick up RWD 4G64(16V)		Center Bearing Support	514797
2.5 (103 kw)	2010.04-2015.12		Centre	Pick up RWD 4D56-HP		Center Bearing Support	514797
2.8 (71 kw)	2005.05-2015.12		Centre	Pick up AWD 4M40-A		Center Bearing Support	514797
3.5 (147 kw)	2007.05-2015.12		Centre	Pick up AWD 6G74(SOHC 24V)		Center Bearing Support	514797
3.5 (151 kw)	2009.08-2016.12		Centre	Pick up AWD 6G74(SOHC 24V)		Center Bearing Support	514797
L400							
2.0 (83 kw)	1994.12-2002.10		Centre	VAN RWD 4G63S		Center Bearing Support	514818
	1995.05-2002.10		Centre	BUS RWD 4G63S		Center Bearing Support	514818
2.0 (85 kw)	1994.12-2001.03		Centre	VAN RWD 4G63S		Center Bearing Support	514818
	1995.05-2000.05		Centre	BUS RWD 4G63S		Center Bearing Support	514818
2.4 (94 kw)	1996.06-2005.06		Centre	BUS RWD 4G64S		Center Bearing Support	514818
2.4 (97 kw)	1994.12-2001.03		Centre	BUS RWD 4G64S		Center Bearing Support	514818
	1994.12-2002.09		Centre	VAN RWD 4G64S		Center Bearing Support	514818
2.5 (64 kw)	1994.12-2001.03		Centre	BUS RWD 4D56		Center Bearing Support	514818
	1994.12-2003.03		Centre	VAN RWD 4D56/4D56T		Center Bearing Support	514818
2.5 (73 kw)	1995.05-2000.05		Centre	BUS RWD 4D56		Center Bearing Support	514818
Lancer							
2.0 (200 kw)	2001.01-2003.01		Front	Saloon AWD 4G63 Turbo		Center Bearing Support	530440
	2005.09-2007.03		Front	Station Wagon AWD 4G63 Turbo		Center Bearing Support	530440
2.0 (206 kw)	2005.09-2007.03		Front	Station Wagon AWD 4G63 Turbo		Center Bearing Support	530440
Lancer Evolution							
2.0 (195 kw)	2003.08-2007.11		Front	Saloon 4WD 4G63DOHC		Center Bearing Support	530440
2.0 (206 kw)	2000.12-2005.03		Front	Saloon 4WD 4G63DOHC		Center Bearing Support	530440
2.0 (208 kw)	2005.08-2007.09		Front	Saloon 4WD 4G63DOHC		Center Bearing Support	530440
2.0 (213 kw)	2005.08-2007.09		Front	Saloon 4WD 4G63DOHC		Center Bearing Support	530440
2.0 (225 kw)	2003.06-2004.04		Front	Saloon 4WD 4G63DOHC		Center Bearing Support	530440
2.0 (227 kw)	2003.08-2004.04		Front	Saloon 4WD 4G63DOHC		Center Bearing Support	530440
	2005.06-2008.10		Front	Saloon 4WD 4G63DOHC		Center Bearing Support	530440



	 YEAR	TRANSM.	FITTING POSITION	BODY STYLE & DRIVE TYPE & ENGINE	REMARKS	 PRODUCT	GSP Ref.
MITSUBISHI							
Lancer Evolution							
2.0 (243 kw)	2004.04-2006.08		Front	Saloon 4WD 4G63DOHC		Center Bearing Support	530440
2.0 (246 kw)	2003.12-2006.08		Front	Saloon 4WD 4G63DOHC		Center Bearing Support	530440
2.0 (255 kw)	2004.06-2005.03		Front	Saloon 4WD 4G63DOHC		Center Bearing Support	530440
2.0 (257 kw)	2005.06-2008.10		Front	Saloon 4WD 4G63DOHC		Center Bearing Support	530440
2.0 (269 kw)	2006.07-2008.10		Front	Saloon 4WD 4G63DOHC		Center Bearing Support	530440
2.0 (273 kw)	2006.07-2007.12		Front	Saloon 4WD 4G63DOHC		Center Bearing Support	530440
2.0 (302 kw)	2004.10-2006.08		Front	Saloon 4WD 4G63DOHC		Center Bearing Support	530440
Montero							
3.2 (118 kw)	2001.11-2007.01		Rear	Terrain cab open 4WD 4M41		Propshaft	PS900418
3.2 (121 kw)	2000.07-2001.10	MT	Front	Terrain cab open 4WD 4M41	Date To:2002.12	Propshaft	PS900421
3.2 (125 kw)	2007.02-2011.05	MT	Front	Terrain cab wagon closed 4WD 4M41R		Propshaft	PS900421
3.5 (149 kw)	2000.07-2007.01	AT	Front	Terrain cab open 4WD 6G74DOHC		Propshaft	PS900420
	2000.07-2007.01	MT	Front	Terrain cab open 4WD 6G74DOHC		Propshaft	PS900421
Montero I.O							
1.8 (84 kw)	2001.03-2005.02	AT	Front	Terrain cab wagon closed 4WD 4G93		Propshaft	PS900397
	2001.03-2005.02	MT	Front	Terrain cab wagon closed 4WD 4G93		Propshaft	PS900431
	2001.03-2005.02	MT	Rear	Terrain cab wagon closed 4WD 4G93		Propshaft	PS900432
1.8 (88 kw)	1999.08-2005.02	AT	Front	Terrain cab wagon closed 4WD 4G93DOHCB		Propshaft	PS900397
	1999.08-2005.02	MT	Front	Terrain cab wagon closed 4WD 4G93DOHCB		Propshaft	PS900431
	1999.08-2005.02	MT	Rear	Terrain cab wagon closed 4WD 4G93DOHCB		Propshaft	PS900432
2.0 (95 kw)	2001.10-2005.02	AT	Front	Terrain cab wagon closed 4WD 4G94DOHC		Propshaft	PS900397
	2001.10-2005.02	MT	Front	Terrain cab wagon closed 4WD 4G94DOHC		Propshaft	PS900431
Montero Sport							
2.5 (85 kw)	2002.10-2009.02		Centre	Terrain cab wagon closed 4WD 4D56		Center Bearing Support	514819
3.0 (129 kw)	1996.09-2003.12		Centre	Terrain cab wagon closed 4WD 6G72DOHC		Center Bearing Support	514819
Outlander							
2.0 (89 kw)	2012.12-		Centre	SUV 4WD 4B11		Center Bearing Support Kit	514800S
2.0 (100 kw)	2003.05-2008.07		Front	SUV 4WD 4G63DOHC		Center Bearing Support	530440
	2003.05-2008.07		Front	SUV FWD 4G63DOHC		Center Bearing Support	530440
	2003.05-2008.07		Rear	SUV 4WD 4G63DOHC		Center Bearing Support	514821
	2003.05-2008.07		Front;Rear	SUV 4WD 4G63DOHC		Center Bearing Support	514796
2.0 (103 kw)	2006.11-2010.06	AT/MT	Rear	SUV 4WD BSY		Propshaft	PS900401
	2006.11-2010.06		Centre	SUV 4WD BSY		Center Bearing Support Kit	514800S
2.0 (108 kw)	2006.11-2012.12	AT/MT	Rear	SUV 4WD 4B11		Propshaft	PS900401
2.0 (110 kw)	2012.08-		Centre	SUV 4WD 4J11		Center Bearing Support Kit	514800S
2.0 (148 kw)	2004.04-2006.10		Front	SUV 4WD 4G63DOHC		Center Bearing Support	530440
	2004.04-2006.10		Rear	SUV 4WD 4G63DOHC		Center Bearing Support	514821
	2004.04-2006.10		Front;Rear	SUV 4WD 4G63DOHC		Center Bearing Support	514796
2.2 (110 kw)	2012.08-		Centre	SUV 4WD 4N14		Center Bearing Support Kit	514800S
2.2 (115 kw)	2007.08-2012.11	AT/MT	Rear	SUV 4WD 4HK/4HN		Propshaft	PS900401
	2007.08-2012.11		Centre	SUV 4WD 4HK/4HN		Center Bearing Support Kit	514800S
2.4 (102 kw)	2003.02-2006.10		Front	SUV 4WD 4G64		Center Bearing Support	530440
	2003.02-2006.10		Rear	SUV 4WD 4G64		Center Bearing Support	514821
	2003.02-2006.10		Front;Rear	SUV 4WD 4G64		Center Bearing Support	514796
2.4 (118 kw)	2003.09-2007.09		Rear	SUV 4WD 4G69		Center Bearing Support	514821
	2003.09-2007.09		Front;Rear	SUV 4WD 4G69		Center Bearing Support	514796
2.4 (119 kw)	2003.05-2006.10		Rear	SUV 4WD 4G69		Center Bearing Support	514821
	2003.05-2006.10		Front;Rear	SUV 4WD 4G69		Center Bearing Support	514796
2.4 (125 kw)	2006.11-2013.12	AT/MT	Rear	SUV 4WD 4B12		Propshaft	PS900401
	2006.11-2013.12		Centre	SUV 4WD 4B12		Center Bearing Support Kit	514800S
	2007.09-2010.06	AT/MT	Rear	SUV 4WD 4B12		Propshaft	PS900401
Pajero							
3.0 (125 kw)	2001.10-2007.01	MT	Front	Terrain cab open 4WD 6G72DOHC		Propshaft	PS900421
	2001.10-2007.01	AT	Rear	Terrain cab open 4WD 6G72DOHC		Propshaft	PS900419
	2001.10-2007.01	MT	Rear	Terrain cab open 4WD 6G72DOHC		Propshaft	PS900418
3.2 (118 kw)	2001.10-2007.01		Rear	Terrain cab open 4WD 4M41		Propshaft	PS900418
	2006.10-2008.12	MT	Front	Terrain cab wagon closed 4WD 4M41R		Propshaft	PS900421
3.2 (121 kw)	2000.02-2007.09	MT	Front	Terrain cab open 4WD 4M41	Date To:2002.12	Propshaft	PS900421
3.2 (125 kw)	2007.02-	MT	Front	Terrain cab wagon closed 4WD 4M41R		Propshaft	PS900421
3.5 (149 kw)	2000.04-2007.01	AT	Front	Terrain cab open 4WD 6G74DOHC		Propshaft	PS900420
	2000.04-2007.01	MT	Front	Terrain cab open 4WD 6G74DOHC		Propshaft	PS900421
Pajero I.O							
2.0 (95 kw)	2001.10-2005.02	AT	Front	Terrain cab wagon closed 4WD 4G94DOHC		Propshaft	PS900397
	2001.10-2005.02	MT	Front	Terrain cab wagon closed 4WD 4G94DOHC		Propshaft	PS900431



	 YEAR	TRANSM.	FITTING POSITION	BODY STYLE & DRIVE TYPE & ENGINE	REMARKS	 PRODUCT	GSP Ref.
MITSUBISHI							
Pajero Mini							
0.7 (37 kw)	1994.01-1998.10		Centre	Terrain cab wagon closed RWD 4A30		Center Bearing Support	514786
0.7 (38 kw)	1994.10-2012.08		Centre	Terrain cab wagon closed RWD 4A30		Center Bearing Support	514786
Pajero Pinin							
1.8 (84 kw)	2001.03-2005.02	AT	Front	Terrain cab wagon closed 4WD 4G93		Propshaft	PS900397
	2001.03-2005.02	MT	Front	Terrain cab wagon closed 4WD 4G93		Propshaft	PS900431
	2001.03-2005.02	MT	Rear	Terrain cab wagon closed 4WD 4G93		Propshaft	PS900432
1.8 (88 kw)	1999.06-2001.02	AT	Front	Terrain cab wagon closed 4WD 4G93DOHCB		Propshaft	PS900397
	1999.06-2001.02	MT	Front	Terrain cab wagon closed 4WD 4G93DOHCB		Propshaft	PS900431
	1999.06-2001.02	MT	Rear	Terrain cab wagon closed 4WD 4G93DOHCB		Propshaft	PS900432
2.0 (95 kw)	2001.10-2005.02	AT	Front	Terrain cab wagon closed 4WD 4G94DOHC		Propshaft	PS900397
	2001.10-2005.02	MT	Front	Terrain cab wagon closed 4WD 4G94DOHC		Propshaft	PS900431
Pajero Pinin/Pajero TR4							
2.0 (96 kw)	2002.10-2007.06	MT	Front	Closed Off-Road Vehicle AWD 4G94		Propshaft	PS900431
Pajero Sport							
2.5 (85 kw)	2000.02-2009.02		Centre	Terrain cab wagon closed 4WD 4D56		Center Bearing Support	514819
3.0 (161 kw)	2012.01-2015.12		Centre	Terrain cab wagon closed RWD 6B31		Center Bearing Support	514797
Shogun							
3.2 (118 kw)	2001.11-2007.01		Rear	Terrain cab open 4WD 4M41		Propshaft	PS900418
3.2 (121 kw)	2000.07-2001.10	MT	Front	Terrain cab open 4WD 4M41	Date To:2002.12	Propshaft	PS900421
3.2 (125 kw)	2007.02-	MT	Front	Terrain cab wagon closed 4WD 4M41R		Propshaft	PS900421
Shogun Pinin							
1.8 (84 kw)	2001.03-2005.02	AT	Front	Terrain cab wagon closed 4WD 4G93		Propshaft	PS900397
	2001.03-2005.02	MT	Front	Terrain cab wagon closed 4WD 4G93		Propshaft	PS900431
	2001.03-2005.02	MT	Rear	Terrain cab wagon closed 4WD 4G93		Propshaft	PS900432
1.8 (88 kw)	1999.06-2007.06	AT	Front	Terrain cab wagon closed 4WD 4G93DOHCB		Propshaft	PS900397
	1999.06-2007.06	MT	Front	Terrain cab wagon closed 4WD 4G93DOHCB		Propshaft	PS900431
	1999.06-2007.06	MT	Rear	Terrain cab wagon closed 4WD 4G93DOHCB		Propshaft	PS900432
2.0 (95 kw)	2001.10-2005.02	AT	Front	Terrain cab wagon closed 4WD 4G94DOHC		Propshaft	PS900397
	2001.10-2005.02	MT	Front	Terrain cab wagon closed 4WD 4G94DOHC		Propshaft	PS900431
Shogun Sport							
2.5 (85 kw)	2001.09-2006.12		Centre	Terrain cab wagon closed 4WD 4D56		Center Bearing Support	514819
Space Runner							
1.8 (85 kw)	1996.06-1999.09		Centre	MPV 4WD 4G93		Center Bearing Support	514786
1.8 (90 kw)	1991.06-1999.09		Centre	MPV 4WD 4G93		Center Bearing Support	514786
Space Wagon							
1.8 (90 kw)	1991.10-1998.10		Centre	MPV 4WD 4G93		Center Bearing Support	514786
2.0 (98 kw)	1992.10-1998.11		Centre	MPV 4WD 4G63S		Center Bearing Support	514786
2.4 (108 kw)	1998.07-2004.01		Centre	MPV 4WD 4G64DOHCB		Center Bearing Support	514820
2.4 (110 kw)	1998.07-2004.01		Centre	MPV 4WD 4G64DOHCB		Center Bearing Support	514820
3.0 (158 kw)	2000.05-2003.05		Centre	MPV 4WD 6G72DOHCB		Center Bearing Support	514820
Strada							
2.4 (133 kw)	2014.11-		Centre	Pick up RWD 4N15		Center Bearing Support	514797
2.8 (92 kw)	1996.09-2005.11		Centre	Pick up 4WD 4M40T		Center Bearing Support	514819
Strakar							
2.5 (55 kw)	1996.09-2001.07		Centre	Pick up RWD 4D56		Center Bearing Support	513582
2.5 (85 kw)	2001.08-2005.11		Centre	Pick up 4WD 4D56		Center Bearing Support	514819
Triton							
2.4 (133 kw)	2015.01-		Centre	Pick up RWD 4N15		Center Bearing Support	514797
2.5 (100 kw)	2014.11-		Centre	Pick up 4WD 4D56DOHC		Center Bearing Support	514797
3.5 (135 kw)	2006.07-2010.12		Centre	Pick up 4WD 6G74SOHC		Center Bearing Support	514797
NISSAN							
Camiones							
2.5 (59 kw)	1996.10-2008.03		Centre	Pick up 4WD TD25		Center Bearing Support Kit	511891S
Datsun							
3.2 (76 kw)	1997.01-2007.12		Centre	Pick up 4WD QD32		Center Bearing Support Kit	511891S
Dualis							
2.0 (102 kw)	2007.08-2013.11		Rear	SUV 4WD MR20DE		Propshaft	PS900448
Largo							
2.4 (107 kw)	1993.06-1999.06		Centre	MPV 4WD KA24DE		Center Bearing Support Kit	514790S
Murano							
3.5 (170 kw)	2006.01-2008.09		Rear	SUV 4WD VQ35DE		Propshaft	PS900433
3.5 (172 kw)	2004.09-2009.12		Centre	SUV 4WD VQ35DE		Center Bearing Support Kit	514791S
3.5 (176 kw)	2002.07-2009.04		Rear	SUV AWD VQ35DE		Propshaft	PS900433

	 YEAR	TRANSM.	FITTING POSITION	BODY STYLE & DRIVE TYPE & ENGINE	REMARKS	 PRODUCT	GSP Ref.
NISSAN							
Murano							
3.5 (180 kw)	2004.11-2008.06		Rear	SUV 4WD VQ35DE		Propshaft	PS900433
3.5 (183 kw)	2003.08-2007.12		Rear	SUV AWD VQ35DE		Propshaft	PS900433
3.5 (188 kw)	2008.10-2014.09		Centre	SUV 4WD VQ35DE		Center Bearing Support Kit	514791S
Navara							
2.5 (98 kw)	2001.11-2012.12	AT/MT	Front	Pick up 4WD YD25DDTI	examine OE number	Propshaft	PS900434
	2001.11-2012.12		Centre	Pick up 4WD YD25DDTI		Center Bearing Support Kit	511891S
	2001.11-2012.12		Centre	Pick up 4WD YD25DDTI		Center Bearing Support Kit	514791S
	2002.02-	AT/MT	Front	Chassis cabin 4WD YD25DDTI	examine OE number	Propshaft	PS900434
	2002.02-		Centre	Chassis cabin 4WD YD25DDTI		Center Bearing Support Kit	511891S
	2002.02-		Centre	Chassis cabin RWD YD25DDTI		Center Bearing Support Kit	511891S
2.5 (106 kw)	2005.07-	MT	Rear	Pick up RWD YD25DDTI		Propshaft	PS900594
	2006.12-	AT/MT	Front	Pick up 4WD YD25DDTI		Propshaft	PS900434
	2006.12-	AT	Rear	Pick up 4WD YD25DDTI		Propshaft	PS900563
	2008.08-	AT/MT	Front	Chassis cabin 4WD YD25DDTI		Propshaft	PS900434
	2008.08-	AT	Rear	Chassis cabin 4WD YD25DDTI		Propshaft	PS900563
2.5 (120 kw)	2007.08-	MT	Rear	Pick up RWD YD25DDTI		Propshaft	PS900594
2.5 (126 kw)	2005.05-	AT	Rear	Chassis cabin 4WD YD25DDTI		Propshaft	PS900563
	2006.10-	AT/MT	Front	Pick up 4WD YD25DDTI		Propshaft	PS900434
	2006.10-	AT	Rear	Pick up 4WD YD25DDTI		Propshaft	PS900563
2.5 (128 kw)	2005.05-	AT/MT	Front	Pick up 4WD YD25DDTI		Propshaft	PS900434
	2005.05-	AT	Rear	Pick up 4WD YD25DDTI		Propshaft	PS900563
	2005.12-	MT	Rear	Pick up RWD YD25DDTI		Propshaft	PS900594
2.5 (140 kw)	2009.12-	AT/MT	Front	Pick up 4WD YD25DDTI		Propshaft	PS900434
	2009.12-	AT	Rear	Pick up 4WD YD25DDTI		Propshaft	PS900563
	2010.03-	AT/MT	Front	Chassis cabin 4WD YD25DDTI		Propshaft	PS900434
	2010.03-	AT	Rear	Chassis cabin 4WD YD25DDTI		Propshaft	PS900563
3.0 (170 kw)	2010.02-	AT/MT	Front	Pick up 4WD V9X		Propshaft	PS900434
	2010.03-	AT/MT	Front	Chassis cabin 4WD V9X		Propshaft	PS900434
NP300							
2.3 (116 kw)	2015.01-	AT	Rear	Pick up 4WD YS23DDT		Propshaft	PS900564
2.5 (98 kw)	2008.04-		Centre	Pick up 4WD YD25DDTI		Center Bearing Support Kit	511891S
	2008.04-		Centre	Pick up RWD YD25DDTI		Center Bearing Support Kit	511891S
	2008.04-		Centre	Pick up 4WD YD25DDTI		Center Bearing Support Kit	514791S
	2008.04-		Centre	Pick up RWD YD25DDTI		Center Bearing Support Kit	514791S
NP300 Navara							
2.3 (118 kw)	2019.01-	AT	Rear	Pick up AWD YS23DDT		Propshaft	PS900564
2.3 (120 kw)	2015.11-	AT	Rear	Pick up 4WD YS23DDT		Propshaft	PS900564
2.3 (140 kw)	2015.11-	AT	Rear	Pick up 4WD YS23DDTT		Propshaft	PS900564
Pathfinder							
2.5 (120 kw)	2005.01-2010.06	AT/MT	Front	SUV 4WD YD25DDTI	Date To:2010.06	Propshaft	PS900434
2.5 (126 kw)	2006.09-2014.08	AT/MT	Front	SUV 4WD YD25DDTI	Date To:2014.08	Propshaft	PS900434
2.5 (128 kw)	2005.01-2010.06	AT/MT	Front	SUV 4WD YD25DDTI	Date To:2010.06	Propshaft	PS900434
	2005.01-2010.06	AT/MT	Front	SUV RWD YD25DDTI	Date To:2010.06	Propshaft	PS900434
2.5 (140 kw)	2010.07-2014.08	AT/MT	Front	SUV 4WD YD25DDTI	Date To:2014.08	Propshaft	PS900434
3.5 (162 kw)	2000.02-2004.12		Rear	Terrain cab wagon closed 4WD VQ35DE		Joint,propshaft	801298
4.0 (198 kw)	2005.01-2014.08	AT/MT	Front	SUV 4WD VQ40DE		Propshaft	PS900434
Pick Up (D22)							
2.5 (98 kw)	2002.03-		Centre	Pick up RWD YD25DDTI		Center Bearing Support	513565
	2002.03-		Centre	Pick up RWD YD25DDTI		Center Bearing Support Kit	511891S
	2002.03-		Centre	Pick up RWD YD25DDTI		Center Bearing Support Kit	514791S
Pick Up (King Cab)							
2.0 (66 kw)	1985.09-1994.05		Centre	Pick up RWD Z20		Center Bearing Support	513565
2.4 (74 kw)	1986.03-1992.04		Centre	Pick up 4WD Z24I		Center Bearing Support	511891
2.4 (76 kw)	1985.09-1994.05		Centre	Pick up 4WD Z24/Z24I		Center Bearing Support	511891
	1985.09-1994.05		Centre	Pick up 4WD Z24/Z24I		Center Bearing Support Kit	511891S
2.4 (88 kw)	1998.02-2001.10		Centre	Pick up 4WD KA24E		Center Bearing Support Kit	511891S
2.4 (91 kw)	1992.04-1998.02		Centre	Pick up RWD KA24E		Center Bearing Support Kit	514791S
2.4 (93 kw)	1992.05-1998.01		Centre	Pick up 4WD KA24E		Center Bearing Support Kit	511891S
2.4 (98 kw)	2001.11-2005.04		Centre	Pick up 4WD KA24DE		Center Bearing Support Kit	511891S
2.5 (55 kw)	1985.09-1998.02		Centre	Pick up RWD SD25/TD25		Center Bearing Support	511891
	1985.09-1998.02		Centre	Pick up RWD SD25/TD25		Center Bearing Support	513565
2.5 (59 kw)	1987.08-1998.02		Centre	Pick up 4WD TD25		Center Bearing Support	511891
	1987.08-1998.02		Centre	Pick up 4WD TD25		Center Bearing Support Kit	511891S

	 YEAR	TRANSM.	FITTING POSITION	BODY STYLE & DRIVE TYPE & ENGINE	REMARKS	 PRODUCT	GSP Ref.
NISSAN							
Pick Up (King Cab)							
2.5 (61 kw)	1992.08-1998.02		Centre	Pick up RWD TD25		Center Bearing Support	511891
	1992.08-1998.02		Centre	Pick up RWD TD25		Center Bearing Support	513565
	1996.03-1998.02		Centre	Pick up 4WD TD25		Center Bearing Support	511891
	1998.02-2001.10		Centre	Pick up RWD TD25		Center Bearing Support	513565
2.5 (76 kw)	1998.05-2001.10		Centre	Pick up 4WD TD25TI		Center Bearing Support Kit	511891S
2.5 (98 kw)	2002.03-2012.12		Centre	Pick up RWD YD25DDTI		Center Bearing Support	513565
	2002.03-2012.12		Centre	Pick up RWD YD25DDTI		Center Bearing Support Kit	511891S
	2002.03-2012.12		Centre	Pick up RWD YD25DDTI		Center Bearing Support Kit	514791S
Pick Up/Datsun							
2.7 (73 kw)	1987.08-1998.02		Centre	Pick up AWD TD27(08.87-)		Center Bearing Support Kit	511891S
Primera							
2.0 (110 kw)	1991.03-1993.04		Centre	Saloon 4WD SR20DE		Center Bearing Support Kit	514791S
Qashqai							
1.6 (96 kw)	2011.07-2014.04		Rear	SUV 4WD R9M		Propshaft	PS900448
	2011.07-2014.04	AT/MT	Rear	SUV 4WD R9M		Propshaft	PS900562
	2011.07-2014.04		Centre	SUV 4WD R9M		Center Bearing Support Kit	514791S
2.0 (104 kw)	2007.02-2014.04		Rear	SUV 4WD MR20DE	Date From:2011.03.Total Length:1961mm	Propshaft	PS900445
	2007.02-2014.04		Rear	SUV 4WD MR20DE	Total Length:2218mm	Propshaft	PS900448
	2007.02-2014.04		Centre	SUV 4WD MR20DE		Center Bearing Support Kit	514791S
2.0 (110 kw)	2006.10-2014.04		Rear	SUV 4WD M9R		Propshaft	PS900448
	2006.10-2014.04	AT/MT	Rear	SUV 4WD M9R		Propshaft	PS900562
	2006.10-2014.04		Centre	SUV 4WD M9R		Center Bearing Support Kit	514791S
Qashqai+2							
1.6 (96 kw)	2011.07-2013.11		Rear	SUV 4WD R9M		Propshaft	PS900448
	2011.07-2013.11	AT/MT	Rear	SUV 4WD R9M		Propshaft	PS900562
	2011.07-2013.11		Centre	SUV 4WD R9M		Center Bearing Support Kit	514791S
2.0 (103 kw)	2010.01-2014.04		Rear	SUV 4WD MR20DE		Propshaft	PS900448
2.0 (104 kw)	2008.08-2014.04		Rear	SUV 4WD MR20DE	Total Length:2218mm	Propshaft	PS900448
	2008.08-2014.04		Centre	SUV 4WD MR20DE		Center Bearing Support Kit	514791S
2.0 (110 kw)	2008.08-2013.11		Rear	SUV 4WD M9R		Propshaft	PS900448
	2008.08-2013.11	AT/MT	Rear	SUV 4WD M9R		Propshaft	PS900562
	2008.08-2013.11		Centre	SUV 4WD M9R		Center Bearing Support Kit	514791S
Serena							
1.6 (71 kw)	1993.02-2001.09	MT	-	MPV RWD GA16DE		Propshaft	PS900441
	1993.02-2001.09	MT	-	MPV RWD GA16DE		Propshaft	PS900442
2.0 (49 kw)	1992.07-1994.09	MT	Front	MPV RWD LD20	Date:from 07.1992,until 09.1994	Propshaft	PS900439
2.3 (55 kw)	1994.10-2001.09	MT	Front	MPV RWD LD23		Propshaft	PS900439
	1994.10-2001.09	MT	-	MPV RWD LD23		Propshaft	PS900442
Silvia							
2.0 (118 kw)	1999.06-2002.08		Centre	Coupe RWD SR20DE		Center Bearing Support Kit	514791S
2.0 (121 kw)	1999.06-2002.08		Centre	Coupe RWD SR20DE		Center Bearing Support Kit	514791S
2.0 (165 kw)	2000.11-2003.12		Centre	Coupe RWD SR20DET		Center Bearing Support Kit	514791S
2.0 (184 kw)	2000.11-2003.12		Centre	Coupe RWD SR20DET		Center Bearing Support Kit	514791S
Sunny							
1.6 (66 kw)	1990.10-1995.05		Centre	Saloon 4WD GA16DS		Center Bearing Support Kit	514791S
2.0 (162 kw)	1990.10-1995.06		Centre	Hatchback 4WD SR20DET		Center Bearing Support Kit	514791S
Sunny Estate/Wagon							
1.6 (66 kw)	1990.11-1995.05		Centre	Estate 4WD GA16DE/GA16DS		Center Bearing Support Kit	514791S
1.6 (75 kw)	1992.10-2000.03		Centre	Estate 4WD GA16DE		Center Bearing Support Kit	514791S
Terrano							
3.0 (109 kw)	1989.09-1995.12		Centre	Terran cab wagon closed 4WD VG30E		Center Bearing Support Kit	511891S
Terrano (Pick Up)							
2.5 (76 kw)	1998.05-2001.10		Centre	Pick up 4WD TD25TI		Center Bearing Support Kit	511891S
Vanette Cargo							
1.6 (71 kw)	1994.09-2001.05	MT	Front	VAN RWD GA16DE		Propshaft	PS900439
	1994.09-2001.05	MT	-	VAN RWD GA16DE		Propshaft	PS900441
1.6 (72 kw)	1996.01-2001.05	MT	Front	BUS RWD GA16DE		Propshaft	PS900439
	1996.01-2001.05	MT	-	BUS RWD GA16DE		Propshaft	PS900441
2.3 (55 kw)	1994.09-2001.05	MT	Front	BUS RWD LD23	Construction Type:Vanette Cargo	Propshaft	PS900439
	1994.09-2001.05	5MT	-	BUS RWD LD23		Propshaft	PS900441
	1994.09-2001.05	MT	-	BUS RWD LD23		Propshaft	PS900442
	1994.09-2002.05	MT	Front	VAN RWD LD23	Construction Type:Vanette Cargo	Propshaft	PS900439
	1994.09-2002.05	5MT	-	VAN RWD LD23		Propshaft	PS900441
	1994.09-2002.05	MT	-	VAN RWD LD23		Propshaft	PS900442



	 YEAR	TRANSM.	FITTING POSITION	BODY STYLE & DRIVE TYPE & ENGINE	REMARKS	 PRODUCT	GSP Ref.
NISSAN							
X-Trail							
2.0 (103 kw)	2001.07-2008.12	AT/MT	-	SUV 4WD QR20DE		Propshaft	PS900447
	2008.06-2013.12		Centre	SUV 4WD MR20DE		Center Bearing Support Kit	514791S
2.0 (104 kw)	2007.06-2014.02		Centre	SUV 4WD MR20DE		Center Bearing Support Kit	514791S
2.0 (110 kw)	2007.09-2014.02		Rear	SUV 4WD M9R/M9R832/M9R833		Propshaft	PS900448
	2007.09-2014.02	AT/MT	Rear	SUV 4WD M9R/M9R832/M9R833	Date From:2008.01	Propshaft	PS900562
2.0 (127 kw)	2007.06-2014.02	AT/MT	Rear	SUV 4WD M9R760	Date From:2008.01	Propshaft	PS900562
2.0 (130 kw)	2009.10-2014.02		Rear	SUV 4WD M9R760		Propshaft	PS900448
	2009.10-2014.02	AT/MT	Rear	SUV 4WD M9R760		Propshaft	PS900562
2.5 (121 kw)	2001.09-2007.05	AT/MT	-	SUV 4WD QR25DE		Propshaft	PS900447
2.5 (124 kw)	2007.06-2014.02		Rear	SUV 4WD QR25DE		Propshaft	PS900448
	2007.06-2014.02		Centre	SUV 4WD QR25DE		Center Bearing Support Kit	514791S
2.5 (125 kw)	2007.09-2014.07	6MT	Front	SUV FWD QR25DE		Propshaft	PS900446
2.5 (132 kw)	2007.09-2014.02	6MT	Front	SUV 4WD QR25DE		Propshaft	PS900446
Xterra							
4.0 (198 kw)	2005.01-		Rear	SUV 4WD VQ40DE		Joint,propshaft	801298
OLDSMOBILE							
Bravada							
4.2 (201 kw)	2001.09-2003.12		Front	SUV AWD LL8(254CUL6)		Joint,propshaft	608073
4.3 (142 kw)	1995.09-1998.12		Front	SUV AWD L35(262CUL6)		Joint,propshaft	608072
	1995.09-1998.12		Front	SUV AWD L35(262CUL6)		Joint,propshaft	608073
OPEL							
Antara							
2.0 (93 kw)	2007.03-2011.12		Centre	SUV 4WD Z20DM		Center Bearing Support	514802
	2008.09-2011.12		Centre	SUV FWD Z20DM		Center Bearing Support	514802
2.0 (110 kw)	2006.08-2011.12		Rear	SUV 4WD Z20DMH		Propshaft	PS900182
	2006.08-2011.12		Centre	SUV 4WD Z20DMH		Center Bearing Support	514802
	2006.08-2011.12		Centre	SUV FWD Z20DMH		Center Bearing Support	514802
2.0 (125 kw)	2016.01-		Rear	SUV 4WD B20DTH		Propshaft	PS900182
	2016.01-		Centre	SUV 4WD B20DTH		Center Bearing Support	514802
	2016.01-		Centre	SUV FWD B20DTH		Center Bearing Support	514802
2.2 (120 kw)	2010.12-		Centre	SUV FWD A22DM		Center Bearing Support	514802
	2010.12-2015.12		Rear	SUV 4WD A22DM		Propshaft	PS900182
	2010.12-2015.12		Centre	SUV 4WD A22DM		Center Bearing Support	514802
2.2 (122 kw)	2014.07-		Centre	SUV FWD A22DM		Center Bearing Support	514802
2.2 (135 kw)	2010.12-2015.12		Rear	SUV 4WD A22DMH		Propshaft	PS900182
	2010.12-2015.12		Centre	SUV 4WD A22DMH		Center Bearing Support	514802
2.4 (103 kw)	2006.08-2010.12		Rear	SUV 4WD Z24XE		Propshaft	PS900182
	2006.08-2010.12		Centre	SUV 4WD Z24XE		Center Bearing Support	514802
	2006.08-2011.12		Rear	SUV 4WD Z24XE		Propshaft	PS900182
	2006.08-2011.12		Centre	SUV 4WD Z24XE		Center Bearing Support	514802
	2008.09-		Centre	SUV FWD Z24XE		Center Bearing Support	514802
	2008.09-2011.12		Centre	SUV FWD Z24XE		Center Bearing Support	514802
2.4 (104 kw)	2006.08-2011.12		Centre	SUV 4WD Z24XE		Center Bearing Support	514802
2.4 (123 kw)	2010.12-		Rear	SUV 4WD A24XE/A24XF		Propshaft	PS900182
	2010.12-		Centre	SUV 4WD A24XE/A24XF		Center Bearing Support	514802
	2010.12-		Centre	SUV FWD A24XE/A24XF		Center Bearing Support	514802
3.0 (183 kw)	2013.07-		Centre	SUV 4WD A30XF/A30XH		Center Bearing Support	514802
3.0 (190 kw)	2010.11-2012.12		Centre	SUV 4WD A30XF/A30XH		Center Bearing Support	514802
3.2 (167 kw)	2007.03-2011.12		Centre	SUV 4WD Z32SEE		Center Bearing Support	514802
Omega							
2.0 (74 kw)	1997.08-2000.07		Centre	Estate RWD X20DTH		Center Bearing Support	512464
	1997.08-2000.07		Centre	Saloon RWD X20DTH		Center Bearing Support	512464
2.0 (85 kw)	1994.03-2000.12		Centre	Saloon RWD 20SE/X20SE		Center Bearing Support	512464
	1994.09-1999.05		Centre	Estate RWD X20SE		Center Bearing Support	512464
2.0 (100 kw)	1994.05-1999.05		Centre	Estate RWD X20XEV		Center Bearing Support	512464
	1994.05-1999.05		Centre	Saloon RWD X20XEV		Center Bearing Support	512464
2.2 (88 kw)	2000.08-2003.08		Centre	Estate RWD Y22DTH		Center Bearing Support	512464
	2000.08-2003.08		Centre	Saloon RWD Y22DTH		Center Bearing Support	512464
2.2 (106 kw)	1999.06-2003.08		Centre	Estate RWD Y22XE/Z22XE		Center Bearing Support	512464
	1999.06-2003.08		Centre	Saloon RWD Y22XE/Z22XE		Center Bearing Support	512464
2.5 (96 kw)	1994.04-2001.02		Centre	Estate RWD U25DT/U25TD/X25DT/X25TD		Center Bearing Support	512464
	1994.04-2001.07		Centre	Saloon RWD U25DT/U25TD/X25DT/X25TD		Center Bearing Support	512464
2.5 (110 kw)	2001.02-2003.08		Centre	Estate RWD Y25DT/Y25TD		Center Bearing Support	512464
	2001.02-2003.08		Centre	Saloon RWD Y25DT/Y25TD		Center Bearing Support	512464



	 YEAR	TRANSM.	FITTING POSITION	BODY STYLE & DRIVE TYPE & ENGINE	REMARKS	 PRODUCT	GSP Ref.
OPEL Omega							
2.5 (125 kw)	1994.03-2000.09		Centre	Estate RWD X25XE		Center Bearing Support	512464
	1994.05-2000.07		Centre	Saloon RWD X25XE		Center Bearing Support	512464
2.6 (132 kw)	2000.08-2003.08		Centre	Estate RWD Y26SE		Center Bearing Support	512464
	2000.08-2003.08		Centre	Saloon RWD Y26SE		Center Bearing Support	512464
3.0 (155 kw)	1994.04-2001.02		Centre	Estate RWD X30XE		Center Bearing Support	512464
	1994.05-2000.07		Centre	Saloon RWD X30XE		Center Bearing Support	512464
3.2 (160 kw)	2001.02-2003.08		Centre	Estate RWD Y32SE		Center Bearing Support	512464
PIAGGIO Porter							
1.0 (33 kw)	1993.02-1994.06		Front	Chassis cabin RWD CB41	Total Length:515.5 mm	Propshaft	PS900195
	1993.02-1994.06		Front	Chassis cabin RWD CB41	Total Length:497.5 mm	Propshaft	PS900196
	1993.02-1994.06		Front	Chassis cabin RWD CB41	Total Length:625.5 mm	Propshaft	PS900197
	1993.02-1994.06		Front	Chassis cabin RWD CB41		Propshaft	PS900198
	1993.02-1994.06		Front	Chassis cabin RWD CB41	Total Length:445.5 mm	Propshaft	PS900199
	1993.02-1998.05		Front	VAN RWD CB41	Total Length:515.5 mm	Propshaft	PS900195
	1993.02-1998.05		Front	VAN RWD CB41	Total Length:497.5 mm	Propshaft	PS900196
	1993.02-1998.05		Front	VAN RWD CB41	Total Length:625.5 mm	Propshaft	PS900197
	1993.02-1998.05		Front	VAN RWD CB41		Propshaft	PS900198
1.0 (35 kw)	1994.07-2002.07		Front	Chassis cabin RWD CB42	Total Length:515.5 mm	Propshaft	PS900195
	1994.07-2002.07		Front	Chassis cabin RWD CB42	Total Length:497.5 mm	Propshaft	PS900196
	1994.07-2002.07		Front	Chassis cabin RWD CB42	Total Length:625.5 mm	Propshaft	PS900197
	1994.07-2002.07		Front	Chassis cabin RWD CB42		Propshaft	PS900198
	1994.07-2002.07		Front	Chassis cabin RWD CB42	Total Length:445.5 mm	Propshaft	PS900199
PONTIAC Solstice							
2.0 (194 kw)	2007.01-2009.12		Rear	Cabriolet RWD LNF		Joint,propshaft	635045
Torrent							
3.4 (138 kw)	2004.08-2009.06		-	MPV 4WD LNJ		Joint,propshaft	635046
	2004.08-2009.12		-	MPV FWD LNJ		Joint,propshaft	635046
PORSCHE Cayenne							
3.0 (155 kw)	2010.10-		Centre	SUV 4WD MCRCB/MCVVC		Center Bearing Support	514781
	2010.10-		Front	SUV 4WD MCRCB/MCVVC		Flexible Coupling Kit	517957S
3.0 (176 kw)	2009.02-2010.05		Front	SUV 4WD M059D	Date To:2010.05	Propshaft	PS900525
	2009.02-2010.05		Rear	SUV 4WD M059D	Date To:2010.05	Propshaft	PS900527
	2009.02-2010.05		Front	SUV 4WD M059D	Date To:2010.05	Joint,propshaft	661094
	2009.02-2010.05		Centre	SUV 4WD M059D		Center Bearing Support	514781
	2009.02-2010.05		Front	SUV 4WD M059D		Flexible Coupling Kit	517957S
	2010.06-2011.09		Front	SUV 4WD M059E		Propshaft	PS900522
	2010.06-2011.09		Centre	SUV 4WD M059E		Center Bearing Support	514781
3.0 (180 kw)	2010.06-		Front	SUV 4WD MCRCA		Propshaft	PS900522
	2010.06-		Centre	SUV 4WD MCRCA		Center Bearing Support	514781
	2010.06-		Front	SUV 4WD MCRCA		Flexible Coupling Kit	517957S
3.0 (193 kw)	2014.10-		Front	SUV 4WD MCVVA		Propshaft	PS900522
3.0 (245 kw)	2010.06-		Front	SUV AWD M 06.EC/MCG.E/MCG.EA/MCG.FA		Propshaft	PS900522
	2010.06-		Centre	SUV AWD M 06.EC/MCG.E/MCG.EA/MCG.FA		Center Bearing Support	514781
	2010.06-		Front	SUV AWD M 06.EC/MCG.E/MCG.EA/MCG.FA		Flexible Coupling Kit	517957S
	2011.04-		Front	SUV 4WD M06EC/MCJT B		Propshaft	PS900522
	2011.04-		Front	SUV 4WD M06EC/MCJT B		Flexible Coupling Kit	517957S
2014.09-		Front	SUV 4WD MCNRB		Propshaft	PS900522	
3.0 (306 kw)	2014.10-		Front	SUV 4WD MCGEA/MCGFA		Propshaft	PS900522
3.2 (177 kw)	2003.08-2006.12		Rear	SUV 4WD M022Y		Joint,propshaft	601297
	2003.08-2006.12		Centre	SUV 4WD M022Y		Center Bearing Support	514781
	2003.08-2006.12		Rear	SUV 4WD M022Y		Flexible Coupling	517957
	2003.08-2006.12		Front	SUV 4WD M022Y		Flexible Coupling Kit	517957S
3.2 (184 kw)	2003.10-2006.12		Centre	SUV 4WD M022Y		Center Bearing Support	514781
	2003.10-2006.12		Rear	SUV 4WD M022Y		Flexible Coupling	517957
	2003.10-2006.12		Front	SUV 4WD M022Y		Flexible Coupling Kit	517957S
3.6 (213 kw)	2007.02-2010.05		Rear	SUV 4WD M5501		Joint,propshaft	601297
	2007.02-2010.05		Centre	SUV 4WD M5501		Center Bearing Support	514781
	2007.02-2010.05		Rear	SUV 4WD M5501		Flexible Coupling	517957
	2007.02-2010.05		Front	SUV 4WD M5501		Flexible Coupling Kit	517957S



	 YEAR	TRANSM.	FITTING POSITION	BODY STYLE & DRIVE TYPE & ENGINE	REMARKS	 PRODUCT	GSP Ref.
PORSCHE							
Cayenne							
3.6 (220 kw)	2010.06-		Centre	SUV 4WD M5502/MCEYA		Center Bearing Support	514781
	2010.06-		Front	SUV 4WD M5502/MCEYA		Flexible Coupling Kit	517957S
4.2 (281 kw)	2012.10-2014.09		Centre	SUV 4WD MCUDB		Center Bearing Support	514781
	2012.10-2014.09		Front	SUV 4WD MCUDB		Flexible Coupling Kit	517957S
4.5 (184 kw)	2002.09-2006.12		Rear	SUV AWD 9PA		Joint,propshaft	601297
4.5 (250 kw)	2002.08-2006.12		Front	SUV 4WD M4800	Date To:2006.12	Propshaft	PS900525
	2002.08-2006.12		Rear	SUV 4WD M4800	Date To:2006.12	Propshaft	PS900527
	2002.08-2006.12		Front	SUV 4WD M4800	Date To:2006.12	Joint,propshaft	661094
	2002.08-2006.12		Centre	SUV 4WD M4800		Center Bearing Support	514781
	2002.08-2006.12		Rear	SUV 4WD M4800		Flexible Coupling	517957
	2002.08-2006.12		Front	SUV 4WD M4800		Flexible Coupling Kit	517957S
4.5 (331 kw)	2002.08-2006.12		Front	SUV 4WD M4850	Date To:2006.12	Propshaft	PS900525
	2002.08-2006.12		Rear	SUV 4WD M4850	Date To:2006.12	Propshaft	PS900527
	2002.08-2006.12		Front	SUV 4WD M4850	Date To:2006.12	Joint,propshaft	661094
	2002.08-2006.12		Rear	SUV 4WD M4850		Joint,propshaft	601297
	2002.08-2006.12		Centre	SUV 4WD M4850		Center Bearing Support	514781
	2002.08-2006.12		Rear	SUV 4WD M4850		Flexible Coupling	517957
	2002.08-2006.12		Front	SUV 4WD M4850		Flexible Coupling Kit	517957S
4.5 (368 kw)	2004.01-2005.10		Centre	SUV 4WD M4850S		Center Bearing Support	514781
	2004.01-2005.10		Front	SUV 4WD M4850S		Flexible Coupling Kit	517957S
4.5 (383 kw)	2006.03-2010.05		Rear	SUV 4WD M4850T		Joint,propshaft	601297
	2006.03-2010.05		Centre	SUV 4WD M4850T		Center Bearing Support	514781
	2006.03-2010.05		Front	SUV 4WD M4850T		Flexible Coupling Kit	517957S
4.8 (283 kw)	2007.02-2010.12		Rear	SUV 4WD M4801		Joint,propshaft	601297
	2007.02-2010.12		Centre	SUV 4WD M4801		Center Bearing Support	514781
	2007.02-2010.12		Rear	SUV 4WD M4801		Flexible Coupling	517957
	2007.02-2010.12		Front	SUV 4WD M4801		Flexible Coupling Kit	517957S
4.8 (294 kw)	2010.06-2014.09		Centre	SUV 4WD M4802		Center Bearing Support	514781
	2010.06-2014.09		Front	SUV 4WD M4802		Flexible Coupling Kit	517957S
4.8 (298 kw)	2007.10-2010.12		Rear	SUV 4WD M4801		Joint,propshaft	601297
	2007.10-2010.12		Centre	SUV 4WD M4801		Center Bearing Support	514781
	2007.10-2010.12		Rear	SUV 4WD M4801		Flexible Coupling	517957
	2007.10-2010.12		Front	SUV 4WD M4801		Flexible Coupling Kit	517957S
4.8 (309 kw)	2012.06-2014.09		Centre	SUV 4WD M4802		Center Bearing Support	514781
	2012.06-2014.09		Front	SUV 4WD M4802		Flexible Coupling Kit	517957S
4.8 (368 kw)	2006.12-2010.05		Front	SUV 4WD M4851	Date To:2010.05	Propshaft	PS900525
	2006.12-2010.05		Rear	SUV 4WD M4851	Date To:2010.05,For PR code:EOA	Propshaft	PS900527
	2006.12-2010.05		Front	SUV 4WD M4851	Date To:2010.05	Joint,propshaft	661094
	2006.12-2010.05		Centre	SUV 4WD M4851		Center Bearing Support	514781
	2006.12-2010.05		Rear	SUV 4WD M4851		Flexible Coupling	517957
	2006.12-2010.05		Front	SUV 4WD M4851		Flexible Coupling Kit	517957S
	2010.06-2014.09		Centre	SUV 4WD M4852		Center Bearing Support	514781
	2010.06-2014.09		Front	SUV 4WD M4852		Flexible Coupling Kit	517957S
4.8 (373 kw)	2007.09-2009.12		Rear	SUV AWD M 48.51		Joint,propshaft	601297
4.8 (397 kw)	2008.08-2010.05		Centre	SUV 4WD M4851		Center Bearing Support	514781
	2008.08-2010.05		Rear	SUV 4WD M4851		Flexible Coupling	517957
	2008.08-2010.05		Front	SUV 4WD M4851		Flexible Coupling Kit	517957S
	2010.06-2014.09		Centre	SUV 4WD M4852		Center Bearing Support	514781
	2010.06-2014.09		Front	SUV 4WD M4852		Flexible Coupling Kit	517957S
4.8 (404 kw)	2008.08-2010.05		Rear	SUV 4WD M4851		Joint,propshaft	601297
	2008.08-2010.05		Centre	SUV 4WD M4851		Center Bearing Support	514781
	2008.08-2010.05		Rear	SUV 4WD M4851		Flexible Coupling	517957
	2008.08-2010.05		Front	SUV 4WD M4851		Flexible Coupling Kit	517957S
4.8 (405 kw)	2012.10-2014.09		Centre	SUV 4WD M4852		Center Bearing Support	514781
	2012.10-2014.09		Front	SUV 4WD M4852		Flexible Coupling Kit	517957S
Macan							
3.0 (155 kw)	2014.02-2018.09		Front	SUV 4WD MCTBB	Date To:2016.06	Propshaft	PS900591
3.0 (180 kw)	2014.02-2018.09		Front	SUV 4WD MCDUD	Date To:2016.06	Propshaft	PS900591
3.0 (184 kw)	2014.02-2018.09		Front	SUV 4WD MCTBC	Date To:2016.06	Propshaft	PS900591
3.0 (190 kw)	2014.02-2018.09		Front	SUV 4WD MCTBA	Date To:2016.06	Propshaft	PS900591
3.0 (250 kw)	2014.02-2018.09		Front	SUV 4WD MCTMA	Date To:2016.06	Propshaft	PS900591
3.0 (265 kw)	2015.11-2018.09		Front	SUV 4WD MDCNA	Date To:2016.06	Propshaft	PS900591
3.6 (294 kw)	2014.02-2018.09		Front	SUV 4WD MCTLA	Date To:2016.06	Propshaft	PS900591



	 YEAR	TRANSM.	FITTING POSITION	BODY STYLE & DRIVE TYPE & ENGINE	REMARKS	 PRODUCT	GSP Ref.
PORSCHE							
Panamera							
3.0 (155 kw)	2011.08-2016.10	AT	Rear	Hatchback RWD MCRCB	Date From:2012.01	Propshaft	PS900566
3.0 (184 kw)	2011.08-2016.10	AT	Rear	Hatchback RWD MCRC/MC RCC	Date From:2012.01	Propshaft	PS900566
3.0 (245 kw)	2011.03-2016.10	AT	Rear	Hatchback RWD MCGEA/MCGFA		Propshaft	PS900566
3.0 (309 kw)	2013.08-2016.10		Rear	Hatchback 4WD MCWDA	for PR code:339	Propshaft	PS900560
	2013.08-2016.10		Rear	Hatchback RWD MCWDA	for PR code:339	Propshaft	PS900560
	2013.08-2016.10	AT	Rear	Hatchback RWD MCWDA	Short Wheelbase	Propshaft	PS900566
	2013.08-2016.10	7AT	-	Hatchback 4WD MCWDA	For PR code:338	Propshaft	PS900566
3.6 (220 kw)	2010.04-2013.07		Rear	Hatchback 4WD M4640		Propshaft	PS900560
	2010.05-2013.07	AT/7DCT	Rear	Hatchback RWD M4620		Propshaft	PS900566
3.6 (228 kw)	2013.08-2016.10		Rear	Hatchback 4WD MCWAA/MCXNA	for PR code:339	Propshaft	PS900560
	2013.08-2016.10		Rear	Hatchback RWD MCWAA/MCXNA	for PR code:339	Propshaft	PS900560
	2013.08-2016.10	AT	Rear	Hatchback RWD MCWAA/MCXNA		Propshaft	PS900566
	2013.08-2016.10	7AT	-	Hatchback 4WD MCWAA/MCXNA	For PR code:338	Propshaft	PS900566
4.8 (294 kw)	2009.09-2013.07		Rear	Hatchback 4WD M4840		Propshaft	PS900560
	2009.09-2013.07	AT/7DCT	Rear	Hatchback RWD M4820	Date From:2010.01	Propshaft	PS900566
4.8 (316 kw)	2012.01-2016.10		Rear	Hatchback 4WD M4840/MCXRA		Propshaft	PS900560
4.8 (324 kw)	2013.08-2016.10		Rear	Hatchback 4WD MCXPA/MCXRA		Propshaft	PS900560
4.8 (368 kw)	2009.09-2013.12	AT	-	Hatchback 4WD M4870	Date From:2010.01	Propshaft	PS900450
4.8 (382 kw)	2013.04-2016.10	AT	-	Hatchback 4WD MCWBA	Short Wheelbase	Propshaft	PS900450
4.8 (397 kw)	2010.08-2013.07	AT	-	Hatchback 4WD M4870	Date From:2011.01	Propshaft	PS900450
4.8 (404 kw)	2011.05-2013.12	AT	-	Hatchback 4WD M4870		Propshaft	PS900450
4.8 (419 kw)	2014.01-2016.10	AT	-	Hatchback 4WD MCWCA	Short Wheelbase	Propshaft	PS900450
RAM							
1500							
3.0 (179 kw)	2014.01-		Front	Pick up 4WD EXF		Propshaft	PS900210
3.7 (160 kw)	2009.09-2014.12		Front	Pick up AWD EKG		Propshaft	PS900210
	2010.09-2013.12		Front	Pick up AWD EKG		Propshaft	PS900210
	2010.09-2015.12		Front	Pick up AWD EKG		Propshaft	PS900210
5.7 (291 kw)	2012.01-		Front	Pick up 4WD EZH		Propshaft	PS900209
5.7 (295 kw)	2012.09-		Front	Pick up AWD EZH		Propshaft	PS900209
	2013.01-		Front	Pick up 4WD EZH		Propshaft	PS900209
1500 Crew Cab							
3.6 (227 kw)	2012.09-		Front	Pick up AWD ERB		Propshaft	PS900209
4.7 (231 kw)	2010.09-		Front	Pick up AWD EVE		Propshaft	PS900209
1500 Extended Cab							
3.6 (227 kw)	2012.09-		Front	Pick up AWD ERB		Propshaft	PS900209
4.7 (231 kw)	2010.09-		Front	Pick up AWD EVE		Propshaft	PS900209
1500 Standard Cab							
3.6 (227 kw)	2012.09-		Front	Pick up AWD ERB		Propshaft	PS900209
4.7 (231 kw)	2010.09-		Front	Pick up AWD EVE		Propshaft	PS900209
RENAULT							
Duster							
1.5 (66 kw)	2011.06-2018.01		Rear	SUV 4WD K9K884	Date To:2018.01	Propshaft	PS900557
1.5 (80 kw)	2013.09-		Rear	SUV 4WD K9K898		Propshaft	PS900557
	2019.07-		Rear	SUV 4WD K9K658/K9K858		Propshaft	PS900557
1.6 (75 kw)	2011.06-2015.05		Rear	SUV 4WD K4M490/K4M606/K4M646/K4M690		Propshaft	PS900557
1.6 (84 kw)	2015.06-		Rear	SUV 4WD H4M430		Propshaft	PS900557
2.0 (99 kw)	2012.02-2018.01		Rear	SUV 4WD F4R400/F4R401/F4R402	Date To:2018.01	Propshaft	PS900557
2.0 (105 kw)	2013.09-		Rear	SUV 4WD F4R410/F4R412	Date From:2013.09	Propshaft	PS900557
Kangoo							
1.6 (70 kw)	2001.11-2008.06		-	MPV 4WD K4M750	Trans. code:OH1/JC7/JB3,Date To:2008.06	Propshaft	PS900451
1.9 (59 kw)	2001.11-2003.06		-	MPV 4WD F9Q790	Trans. code:OH1/JC7/JC5,Date To:2003.06	Propshaft	PS900451
1.9 (62 kw)	2003.10-2007.09		-	MPV 4WD F9Q790	Trans. code:OH1/JC7,Date To:2007.09	Propshaft	PS900451
Kangoo Express							
1.6 (70 kw)	2001.11-2008.06		-	MPV Van 4WD K4M750	Trans. code:OH1/JC7,Date To:2008.06	Propshaft	PS900451
1.9 (59 kw)	2001.10-2003.06		-	MPV Van 4WD F9Q790	Trans. code:OH1/JC7/JC5,Date To:2003.06	Propshaft	PS900451
1.9 (62 kw)	2003.07-2008.06		-	MPV Van 4WD F9Q790	Trans. code:OH1/JC7,Date To:2008.06	Propshaft	PS900451
Kangoo Rapid							
1.6 (70 kw)	2001.11-2008.06		-	MPV Van 4WD K4M750/K4M752/K4M753/K4M754	Trans. code:OH1/JC7/JB3/DP0,Date To:2008.06	Propshaft	PS900451
1.9 (59 kw)	2001.10-2008.06		-	MPV Van 4WD F9Q782/F9Q790	Trans. code:OH1/JC7/JC5,Date To:2008.06	Propshaft	PS900451
1.9 (62 kw)	2003.07-2008.06		-	MPV Van 4WD F9Q782/F9Q790	Trans. code:OH1/JC7,Date To:2008.06	Propshaft	PS900451
Koleos							
2.0 (110 kw)	2008.09-		Rear			Propshaft	PS900448
	2008.09-	MT	Rear			Propshaft	PS900452

	 YEAR	TRANSM.	FITTING POSITION	BODY STYLE & DRIVE TYPE & ENGINE	REMARKS	 PRODUCT	GSP Ref.
RENAULT							
Koleos							
2.0 (127 kw)	2008.06-		Rear	SUV 4WD M9R830/M9R864/M9R865		Propshaft	PS900448
	2008.06-	MT	Rear	SUV 4WD M9R830/M9R864/M9R865		Propshaft	PS900452
2.0 (130 kw)	2008.09-2013.03		Rear	SUV 4WD M9R830		Propshaft	PS900448
2.5 (126 kw)	2008.09-		Rear	SUV 4WD 2TR700/2TR702/2TR703/2TR705		Propshaft	PS900448
	2008.09-		Centre	SUV 4WD 2TR700/2TR702/2TR703/2TR705		Center Bearing Support Kit	514791S
	2008.09-		Centre	SUV FWD 2TR700/2TR702/2TR703/2TR705		Center Bearing Support Kit	514791S
Megane Scenic							
2.0 (84 kw)	1997.05-1999.10		Front	MPV 4WD F3R750		Flexible Coupling Kit	537791S
Scenic RX4							
1.8 (85 kw)	2000.07-2001.04		Front	MPV 4WD F4P722		Flexible Coupling Kit	537791S
1.9 (74 kw)	2002.12-2003.08	MT	Rear	MPV 4WD F9Q732/F9Q748/F9Q796	Trans. code:M5	Propshaft	PS900453
	2002.12-2003.08		Front	MPV 4WD F9Q732/F9Q748/F9Q796		Flexible Coupling Kit	537791S
1.9 (75 kw)	2000.11-2003.08	MT	Rear	MPV 4WD F9Q740	Trans. code:M5	Propshaft	PS900453
	2000.11-2003.08		Front	MPV 4WD F9Q740		Flexible Coupling Kit	537791S
2.0 (102 kw)	2000.06-2003.08	MT	Rear	MPV 4WD F4R744	Trans. code:M5	Propshaft	PS900453
	2000.06-2003.08		Front	MPV 4WD F4R744		Flexible Coupling Kit	537791S
SATURN							
Sky							
2.4 (132 kw)	2007.01-2010.12		Rear	Cabriolet RWD LE5		Joint,propshaft	635045
Vue							
2.2 (107 kw)	2002.01-2007.12		Rear	SUV 4WD L61		Joint,propshaft	699239
3.0 (135 kw)	2002.01-2003.12		Rear	SUV 4WD L81(181CUV6)		Joint,propshaft	699239
3.5 (187 kw)	2003.09-2007.12		Rear	SUV AWD L66		Joint,propshaft	699239
SEAT							
Alhambra							
2.0 (103 kw)	2011.05-		Front	MPV 4WD CFFB		Flexible Coupling	537626
	2011.05-		Rear	MPV 4WD CFFB		Flexible Coupling	533882
	2011.05-		Front	MPV 4WD CFFB		Flexible Coupling Kit	537626S
2.0 (110 kw)	2015.05-		Front	MPV 4WD CUVC/DFLA		Flexible Coupling	537626
	2015.05-		Front	MPV Van 4WD CUVC		Flexible Coupling	537626
	2015.05-		Rear	MPV 4WD CUVC/DFLA		Flexible Coupling	533882
	2015.05-		Rear	MPV Van 4WD CUVC		Flexible Coupling	533882
	2015.05-		Front	MPV 4WD CUVC/DFLA		Flexible Coupling Kit	537626S
	2015.05-		Front	MPV Van 4WD CUVC		Flexible Coupling Kit	537626S
2.0 (135 kw)	2015.05-		Front	MPV 4WD DFMA		Flexible Coupling	537626
	2015.05-		Rear	MPV 4WD DFMA		Flexible Coupling	533882
Altea Freetrack							
2.0 (103 kw)	2007.05-2010.11		Front	MPV 4WD BMM		Flexible Coupling	537626
	2007.05-2010.11		Rear	MPV 4WD BMM		Flexible Coupling	533882
	2010.10-		Rear	MPV 4WD CFHC		Flexible Coupling	533882
2.0 (125 kw)	2007.06-2013.06		Front	MPV 4WD BMN/CEGA/CFJA		Flexible Coupling	537626
	2007.06-2013.06		Rear	MPV 4WD BMN/CEGA/CFJA		Flexible Coupling	533882
2.0 (147 kw)	2007.06-2009.05		Front	MPV 4WD BWA		Flexible Coupling	537626
	2007.06-2009.05		Rear	MPV 4WD BWA		Flexible Coupling	533882
2.0 (155 kw)	2009.05-		Front	MPV 4WD CCZB		Flexible Coupling	537626
	2009.05-		Rear	MPV 4WD CCZB		Flexible Coupling	533882
Altea XL							
1.9 (77 kw)	2009.05-2010.09		Rear	MPV 4WD BLS		Flexible Coupling	533882
2.0 (103 kw)	2007.06-2010.11		Front	MPV 4WD BMM		Flexible Coupling	537626
	2007.06-2010.11		Rear	MPV 4WD BMM		Flexible Coupling	533882
	2010.09-		Rear	MPV 4WD CFHC		Flexible Coupling	533882
2.0 (125 kw)	2007.06-2009.05		Front	MPV 4WD BMN		Flexible Coupling	537626
	2007.06-2009.05		Rear	MPV 4WD BMN		Flexible Coupling	533882
2.0 (147 kw)	2007.06-2009.05		Front	MPV 4WD BWA		Flexible Coupling	537626
	2007.06-2009.05		Rear	MPV 4WD BWA		Flexible Coupling	533882
Ateca							
1.4 (110 kw)	2016.06-		Front	SUV 4WD CZEA		Flexible Coupling	537626
	2016.06-		Rear	SUV 4WD CZEA		Flexible Coupling	533882
	2016.06-		Front	SUV 4WD CZEA		Flexible Coupling Kit	537626S
	2016.06-		Rear	SUV 4WD CZEA		Flexible Coupling Kit	533882S
2.0 (110 kw)	2016.06-		Rear	SUV 4WD DFFA/DTTA/DTTC		Propshaft	PS900585
	2016.06-		Front	SUV 4WD DFFA/DTTA/DTTC		Flexible Coupling	537626
	2016.06-		Rear	SUV 4WD DFFA/DTTA/DTTC		Flexible Coupling	533882
	2016.06-		Front	SUV 4WD DFFA/DTTA/DTTC		Flexible Coupling Kit	537626S

	 YEAR	TRANSM.	FITTING POSITION	BODY STYLE & DRIVE TYPE & ENGINE	REMARKS	 PRODUCT	GSP Ref.
SEAT							
Ateca							
2.0 (110 kw)	2016.06-		Rear	SUV 4WD DFFA/DTTA/DTTC		Flexible Coupling Kit	533882S
2.0 (140 kw)	2016.06-		Rear	SUV 4WD DFHA		Propshaft	PS900585
	2016.06-		Front	SUV 4WD DFHA		Flexible Coupling	537626
	2016.06-		Rear	SUV 4WD DFHA		Flexible Coupling	533882
	2016.06-		Front	SUV 4WD DFHA		Flexible Coupling Kit	537626S
	2016.06-		Rear	SUV 4WD DFHA		Flexible Coupling Kit	533882S
	2017.05-		Front	SUV 4WD CZPB/DKZA/DNNA		Flexible Coupling	537626
	2017.05-		Rear	SUV 4WD CZPB/DKZA/DNNA		Flexible Coupling	533882
	2017.05-		Front	SUV 4WD CZPB/DKZA/DNNA		Flexible Coupling Kit	537626S
	2017.05-		Rear	SUV 4WD CZPB/DKZA/DNNA		Flexible Coupling Kit	533882S
Leon							
1.8 (132 kw)	2000.03-2004.04		Front	Hatchback 4WD AJQ/ARY		Flexible Coupling	537626
	2000.03-2004.04		Front	Hatchback 4WD AJQ/ARY		Flexible Coupling Kit	537626S
1.9 (110 kw)	2000.08-2006.06		Front	Hatchback 4WD ARL		Flexible Coupling	537626
	2000.08-2006.06		Front	Hatchback 4WD ARL		Flexible Coupling Kit	537626S
2.8 (150 kw)	2000.10-2006.06		Front	Hatchback 4WD AUE/BDE		Flexible Coupling	537626
	2000.10-2006.06		Front	Hatchback 4WD AUE/BDE		Flexible Coupling Kit	537626S
Leon ST							
1.6 (77 kw)	2014.03-2020.08		Front	Estate 4WD CLHA		Flexible Coupling	537626
	2014.03-2020.08		Rear	Estate 4WD CLHA		Flexible Coupling	533882
	2014.03-2020.08		Front	Estate 4WD CLHA		Flexible Coupling Kit	537626S
	2014.03-2020.08		Rear	Estate 4WD CLHA		Flexible Coupling Kit	533882S
1.6 (81 kw)	2014.11-2020.08		Front	Estate 4WD CXXB		Flexible Coupling	537626
	2014.11-2020.08		Front	Estate 4WD CXXB		Flexible Coupling Kit	537626S
1.8 (132 kw)	2014.11-2018.08		Front	Estate 4WD CJSA/CJSB		Flexible Coupling	537626
	2014.11-2018.08		Rear	Estate 4WD CJSA/CJSB		Flexible Coupling	533882
	2014.11-2018.08		Front	Estate 4WD CJSA/CJSB		Flexible Coupling Kit	537626S
	2014.11-2018.08		Rear	Estate 4WD CJSA/CJSB		Flexible Coupling Kit	533882S
2.0 (110 kw)	2014.02-2020.08		Front	Estate 4WD CRBC/CRLB/CRMB/DCYA/DFGA		Flexible Coupling	537626
	2014.02-2020.08		Rear	Estate 4WD CRBC/CRLB/CRMB/DCYA/DFGA		Flexible Coupling	533882
	2014.02-2020.08		Front	Estate 4WD CRBC/CRLB/CRMB/DCYA/DFGA		Flexible Coupling Kit	537626S
	2014.02-2020.08		Rear	Estate 4WD CRBC/CRLB/CRMB/DCYA/DFGA		Flexible Coupling Kit	533882S
	2014.09-2018.08		Front	Combi van 4WD CRBC/CRLB		Flexible Coupling	537626
	2014.09-2018.08		Rear	Combi van 4WD CRBC/CRLB		Flexible Coupling	533882
	2014.09-2018.08		Front	Combi van 4WD CRBC/CRLB		Flexible Coupling Kit	537626S
	2014.09-2018.08		Rear	Combi van 4WD CRBC/CRLB		Flexible Coupling Kit	533882S
2.0 (135 kw)	2014.10-2018.08		Front	Estate 4WD CUNA/DJGA		Flexible Coupling	537626
	2014.10-2018.08		Front	Combi van 4WD CUNA		Flexible Coupling	537626
	2014.10-2018.08		Rear	Estate 4WD CUNA/DJGA		Flexible Coupling	533882
	2014.10-2018.08		Rear	Combi van 4WD CUNA		Flexible Coupling	533882
	2014.10-2018.08		Front	Estate 4WD CUNA/DJGA		Flexible Coupling Kit	537626S
	2014.10-2018.08		Front	Combi van 4WD CUNA		Flexible Coupling Kit	537626S
	2014.10-2018.08		Rear	Estate 4WD CUNA/DJGA		Flexible Coupling Kit	533882S
2.0 (221 kw)	2016.11-2018.08		Front	Combi van 4WD CJXC		Flexible Coupling	537626
	2016.11-2018.08		Front	Combi van 4WD CJXC		Flexible Coupling Kit	537626S
	2016.11-2020.08		Front	Estate 4WD CJXC/DNUE		Flexible Coupling	537626
	2016.11-2020.08		Front	Estate 4WD CJXC/DNUE		Flexible Coupling Kit	537626S
Tarraco							
2.0 (110 kw)	2018.09-		Front	SUV 4WD DFGA		Flexible Coupling	537626
	2018.09-		Rear	SUV 4WD DFGA		Flexible Coupling	533882
	2018.09-		Front	SUV 4WD DFGA		Flexible Coupling Kit	537626S
	2018.09-		Rear	SUV 4WD DFGA		Flexible Coupling Kit	533882S
2.0 (140 kw)	2018.09-		Front	SUV 4WD DFHA		Flexible Coupling	537626
	2018.09-		Rear	SUV 4WD DFHA		Flexible Coupling	533882
	2018.09-		Front	SUV 4WD DFHA		Flexible Coupling Kit	537626S
	2018.09-		Rear	SUV 4WD DFHA		Flexible Coupling Kit	533882S
	2018.11-		Front	SUV 4WD DKZA		Flexible Coupling	537626
	2018.11-		Rear	SUV 4WD DKZA		Flexible Coupling	533882
	2018.11-		Front	SUV 4WD DKZA		Flexible Coupling Kit	537626S
2018.11-		Rear	SUV 4WD DKZA		Flexible Coupling Kit	533882S	



	 YEAR	TRANSM.	FITTING POSITION	BODY STYLE & DRIVE TYPE & ENGINE	REMARKS	 PRODUCT	GSP Ref.
SKODA							
Karoq							
2.0 (105 kw)	2018.07-		Rear	SUV 4WD CRVC		Propshaft	PS900585
2.0 (110 kw)	2017.07-		Rear	SUV 4WD DFFA		Propshaft	PS900585
	2017.07-		Front	SUV 4WD DFFA		Flexible Coupling	537626
	2017.07-		Rear	SUV 4WD DFFA		Flexible Coupling	533882
	2017.07-		Front	SUV 4WD DFFA		Flexible Coupling Kit	537626S
	2017.07-		Rear	SUV 4WD DFFA		Flexible Coupling Kit	533882S
2.0 (140 kw)	2017.07-		Rear	SUV 4WD DFHA		Propshaft	PS900585
	2017.07-		Front	SUV 4WD DFHA		Flexible Coupling	537626
	2017.07-		Rear	SUV 4WD DFHA		Flexible Coupling	533882
	2017.07-		Front	SUV 4WD DFHA		Flexible Coupling Kit	537626S
	2017.07-		Rear	SUV 4WD DFHA		Flexible Coupling Kit	533882S
Karoq Scout							
2.0 (110 kw)	2018.07-		Rear	SUV 4WD DFFA		Propshaft	PS900585
2.0 (140 kw)	2018.07-		Front	SUV 4WD DFFA		Flexible Coupling	537626
	2018.07-		Rear	SUV 4WD DFFA		Flexible Coupling	533882
	2018.07-		Front	SUV 4WD DFFA		Flexible Coupling Kit	537626S
	2018.07-		Rear	SUV 4WD DFFA		Flexible Coupling Kit	533882S
	2018.07-		Rear	SUV 4WD DFHA		Propshaft	PS900585
2.0 (140 kw)	2018.07-		Front	SUV 4WD DFHA		Flexible Coupling	537626
	2018.07-		Rear	SUV 4WD DFHA		Flexible Coupling	533882
	2018.07-		Front	SUV 4WD DFHA		Flexible Coupling Kit	537626S
	2018.07-		Rear	SUV 4WD DFHA		Flexible Coupling Kit	533882S
Kodiat							
1.4 (110 kw)	2016.10-	6MT	Rear	SUV 4WD CZDA/CZEA		Propshaft	PS900634
2.0 (110 kw)	2016.10-		Front	SUV 4WD CZDA/CZEA		Flexible Coupling	537626
	2016.10-		Rear	SUV 4WD CZDA/CZEA		Flexible Coupling	533882
	2016.10-		Front	SUV 4WD CZDA/CZEA		Flexible Coupling Kit	537626S
	2016.10-		Rear	SUV 4WD CZDA/CZEA		Flexible Coupling Kit	533882S
	2017.03-		Front	SUV 4WD DBGC/DFGA/DTSB		Flexible Coupling	537626
2.0 (132 kw)	2017.03-		Rear	SUV 4WD DBGC/DFGA/DTSB		Flexible Coupling	533882
	2017.03-		Front	SUV 4WD DBGC/DFGA/DTSB		Flexible Coupling Kit	537626S
	2017.03-		Rear	SUV 4WD DBGC/DFGA/DTSB		Flexible Coupling Kit	533882S
2.0 (140 kw)	2016.10-		Front	SUV 4WD CZPA		Flexible Coupling	537626
	2016.10-		Rear	SUV 4WD CZPA		Flexible Coupling	533882
	2016.10-		Front	SUV 4WD CZPA		Flexible Coupling Kit	537626S
	2016.10-		Rear	SUV 4WD CZPA		Flexible Coupling Kit	533882S
2.0 (140 kw)	2016.10-		Front	SUV 4WD DFHA		Flexible Coupling	537626
	2016.10-		Rear	SUV 4WD DFHA		Flexible Coupling	533882
	2016.10-		Front	SUV 4WD DFHA		Flexible Coupling Kit	537626S
	2016.10-		Rear	SUV 4WD DFHA		Flexible Coupling Kit	533882S
Kodiat Scout							
1.4 (110 kw)	2017.05-	6MT	Rear	SUV 4WD CZDA/CZEA		Propshaft	PS900634
2.0 (110 kw)	2017.05-		Front	SUV 4WD CZDA/CZEA		Flexible Coupling	537626
	2017.05-		Rear	SUV 4WD CZDA/CZEA		Flexible Coupling	533882
	2017.05-		Front	SUV 4WD CZDA/CZEA		Flexible Coupling Kit	537626S
	2017.05-		Rear	SUV 4WD CZDA/CZEA		Flexible Coupling Kit	533882S
	2017.05-		Front	SUV 4WD DBGC/DFGA		Flexible Coupling	537626
2.0 (132 kw)	2017.05-		Rear	SUV 4WD DBGC/DFGA		Flexible Coupling	533882
	2017.05-		Front	SUV 4WD DBGC/DFGA		Flexible Coupling Kit	537626S
	2017.05-		Rear	SUV 4WD DBGC/DFGA		Flexible Coupling Kit	533882S
2.0 (140 kw)	2017.05-		Front	SUV 4WD CZPA		Flexible Coupling	537626
	2017.05-		Rear	SUV 4WD CZPA		Flexible Coupling	533882
	2017.05-		Front	SUV 4WD CZPA		Flexible Coupling Kit	537626S
	2017.05-		Rear	SUV 4WD CZPA		Flexible Coupling Kit	533882S
2.0 (140 kw)	2017.05-		Front	SUV 4WD DFHA		Flexible Coupling	537626
	2017.05-		Rear	SUV 4WD DFHA		Flexible Coupling	533882
	2017.05-		Front	SUV 4WD DFHA		Flexible Coupling Kit	537626S
	2017.05-		Rear	SUV 4WD DFHA		Flexible Coupling Kit	533882S
Octavia							
1.6 (77 kw)	2009.06-2013.02		Rear	Estate 4WD CAYC		Flexible Coupling	533882
2.0 (140 kw)	2013.05-2015.05		Front	Estate 4WD CLHA		Flexible Coupling	537626
	2013.05-2015.05		Front	Hatchback 4WD CLHA		Flexible Coupling	537626
	2013.05-2015.05		Rear	Estate 4WD CLHA		Flexible Coupling	533882
	2013.05-2015.05		Rear	Hatchback 4WD CLHA		Flexible Coupling	533882

	 YEAR	TRANSM.	FITTING POSITION	BODY STYLE & DRIVE TYPE & ENGINE	REMARKS	 PRODUCT	GSP Ref.
SKODA Octavia							
1.6 (77 kw)	2013.05-2015.05		Front	Estate 4WD CLHA		Flexible Coupling Kit	537626S
	2013.05-2015.05		Front	Hatchback 4WD CLHA		Flexible Coupling Kit	537626S
	2013.05-2015.05		Rear	Estate 4WD CLHA		Flexible Coupling Kit	533882S
	2013.05-2015.05		Rear	Hatchback 4WD CLHA		Flexible Coupling Kit	533882S
1.6 (81 kw)	2015.05-		Front	Estate 4WD CRKB/CXXB		Flexible Coupling	537626
	2015.05-		Rear	Estate 4WD CRKB/CXXB		Flexible Coupling	533882
	2015.05-		Front	Estate 4WD CRKB/CXXB		Flexible Coupling Kit	537626S
	2015.05-		Rear	Estate 4WD CRKB/CXXB		Flexible Coupling Kit	533882S
	2015.05-2017.02		Front	Hatchback 4WD CRKB/CXXB		Flexible Coupling	537626
	2015.05-2017.02		Rear	Hatchback 4WD CRKB/CXXB		Flexible Coupling	533882
	2015.05-2017.02		Front	Hatchback 4WD CRKB/CXXB		Flexible Coupling Kit	537626S
	2015.05-2017.02		Rear	Hatchback 4WD CRKB/CXXB		Flexible Coupling Kit	533882S
1.8 (110 kw)	2000.08-2006.05		Front	Estate 4WD ARX		Flexible Coupling Kit	537626S
	2000.08-2006.05		Front	Hatchback 4WD ARX		Flexible Coupling Kit	537626S
1.8 (112 kw)	2009.03-2013.02		Rear	Estate 4WD CDAB		Flexible Coupling	533882
1.8 (118 kw)	2008.11-2013.02		Rear	Estate 4WD CDAA		Flexible Coupling	533882
1.8 (132 kw)	2013.05-		Front	Estate 4WD CJSB		Flexible Coupling	537626
	2013.05-		Rear	Estate 4WD CJSB		Flexible Coupling	533882
	2013.05-		Front	Estate 4WD CJSB		Flexible Coupling Kit	537626S
	2013.05-		Rear	Estate 4WD CJSB		Flexible Coupling Kit	533882S
1.9 (66 kw)	1999.11-2006.02		Front	Estate 4WD AGR		Flexible Coupling Kit	537626S
1.9 (74 kw)	2000.08-2006.01		Front	Estate 4WD ATD		Flexible Coupling	537626
	2000.08-2006.01		Front	Estate 4WD ATD		Flexible Coupling Kit	537626S
1.9 (77 kw)	2004.11-2010.12		Front	Estate 4WD BKC/BLS/BXE		Flexible Coupling	537626
	2004.11-2010.12		Rear	Estate 4WD BKC/BLS/BXE		Flexible Coupling	533882
2.0 (81 kw)	2011.05-2013.02		Rear	Estate 4WD CFHF		Flexible Coupling	533882
2.0 (85 kw)	1999.11-2004.09		Front	Estate 4WD AZH/AZJ		Flexible Coupling Kit	537626S
2.0 (103 kw)	2006.07-2010.05		Front	Estate 4WD BMM		Flexible Coupling	537626
	2006.07-2010.05		Rear	Estate 4WD BMM		Flexible Coupling	533882
	2010.05-2013.02		Rear	Estate 4WD CFHC		Flexible Coupling	533882
	2010.05-2013.02		Rear	Estate 4WD CFHC		Flexible Coupling	533882
2.0 (110 kw)	2004.11-2008.10		Front	Estate 4WD BLX/BVX		Flexible Coupling	537626
	2004.11-2008.10		Rear	Estate 4WD BLX/BVX		Flexible Coupling	533882
	2013.05-		Front	Estate 4WD CKFC/CRMB/DCYA		Flexible Coupling	537626
	2013.05-		Rear	Estate 4WD CKFC/CRMB/DCYA		Flexible Coupling	533882
	2013.05-		Front	Estate 4WD CKFC/CRMB/DCYA		Flexible Coupling Kit	537626S
	2013.05-		Rear	Estate 4WD CKFC/CRMB/DCYA		Flexible Coupling Kit	533882S
	2013.05-2020.10		Front	Hatchback 4WD CKFC/CRMB/DCYA/DFFA		Flexible Coupling	537626
	2013.05-2020.10		Rear	Hatchback 4WD CKFC/CRMB/DCYA/DFFA		Flexible Coupling	533882
	2013.05-2020.10		Front	Hatchback 4WD CKFC/CRMB/DCYA/DFFA		Flexible Coupling Kit	537626S
	2013.05-2020.10		Rear	Hatchback 4WD CKFC/CRMB/DCYA/DFFA		Flexible Coupling Kit	533882S
	2020.09-		Front	Estate 4WD DSTA/DTTA/DTTC		Flexible Coupling	537626
	2020.09-		Rear	Estate 4WD DSTA/DTTA/DTTC		Flexible Coupling	533882
	2020.09-		Front	Estate 4WD DSTA/DTTA/DTTC		Flexible Coupling Kit	537626S
	2.0 (135 kw)	2013.05-		Front	Estate 4WD CUNA		Flexible Coupling
2013.05-			Rear	Estate 4WD CUNA		Flexible Coupling	533882
2013.05-			Front	Estate 4WD CUNA		Flexible Coupling Kit	537626S
2013.05-			Rear	Estate 4WD CUNA		Flexible Coupling Kit	533882S
2013.05-2020.10			Front	Hatchback 4WD CUNA/CUPA/DJGA		Flexible Coupling	537626
2013.05-2020.10			Rear	Hatchback 4WD CUNA/CUPA/DJGA		Flexible Coupling	533882
2013.05-2020.10			Front	Hatchback 4WD CUNA/CUPA/DJGA		Flexible Coupling Kit	537626S
2013.05-2020.10			Rear	Hatchback 4WD CUNA/CUPA/DJGA		Flexible Coupling Kit	533882S
2.0 (140 kw)	2020.07-		Front	Estate 4WD CZPB/DNNA		Flexible Coupling	537626
	2020.07-		Rear	Estate 4WD CZPB/DNNA		Flexible Coupling	533882
	2020.07-		Front	Estate 4WD CZPB/DNNA		Flexible Coupling Kit	537626S
2.0 (147 kw)	2020.07-		Front	Estate 4WD DTUA		Flexible Coupling	537626
	2020.07-		Front	Hatchback 4WD DTUA		Flexible Coupling	537626
	2020.07-		Rear	Estate 4WD DTUA		Flexible Coupling	533882
	2020.07-		Rear	Hatchback 4WD DTUA		Flexible Coupling	533882
	2020.07-		Front	Estate 4WD DTUA		Flexible Coupling Kit	537626S
	2020.07-		Front	Hatchback 4WD DTUA		Flexible Coupling Kit	537626S
Octavia Scout							
1.6 (81 kw)	2015.05-		Front	Estate 4WD CRKB/CXXB/DBKA		Flexible Coupling	537626
	2015.05-		Rear	Estate 4WD CRKB/CXXB/DBKA		Flexible Coupling	533882
	2015.05-		Front	Estate 4WD CRKB/CXXB/DBKA		Flexible Coupling Kit	537626S



	 YEAR	TRANSM.	FITTING POSITION	BODY STYLE & DRIVE TYPE & ENGINE	REMARKS	 PRODUCT	GSP Ref.
SKODA Octavia Scout							
1.6 (81 kw)	2015.05-		Rear	Estate 4WD CRKB/CXXB/DBKA		Flexible Coupling Kit	533882S
1.8 (112 kw)	2009.03-2009.05		Rear	Estate 4WD CDAB		Flexible Coupling	533882
1.8 (118 kw)	2008.11-2013.02		Rear	Estate 4WD CDAA		Flexible Coupling	533882
1.8 (132 kw)	2013.05-		Front	Estate 4WD CJSB		Flexible Coupling	537626
	2013.05-		Rear	Estate 4WD CJSB		Flexible Coupling	533882
	2013.05-		Front	Estate 4WD CJSB		Flexible Coupling Kit	537626S
	2013.05-		Rear	Estate 4WD CJSB		Flexible Coupling Kit	533882S
2.0 (103 kw)	2004.02-2013.03		Rear	Estate 4WD BKD/CFHC/CLCB		Flexible Coupling	533882
	2006.10-2010.05		Front	Estate 4WD BMM		Flexible Coupling	537626
	2006.10-2010.05		Rear	Estate 4WD BMM		Flexible Coupling	533882
2.0 (110 kw)	2004.11-2009.04		Front	Estate 4WD BLX/BLY/BVX		Flexible Coupling	537626
	2004.11-2009.04		Rear	Estate 4WD BLX/BLY/BVX		Flexible Coupling	533882
	2012.11-		Front	Estate 4WD CKFC/CRMB/DCYA/DFFA		Flexible Coupling	537626
	2012.11-		Rear	Estate 4WD CKFC/CRMB/DCYA/DFFA		Flexible Coupling	533882
	2012.11-		Front	Estate 4WD CKFC/CRMB/DCYA/DFFA		Flexible Coupling Kit	537626S
2.0 (135 kw)	2013.05-		Front	Estate 4WD CUNA/CUPA/DJGA		Flexible Coupling	537626
	2013.05-		Rear	Estate 4WD CUNA/CUPA/DJGA		Flexible Coupling	533882
	2013.05-		Front	Estate 4WD CUNA/CUPA/DJGA		Flexible Coupling Kit	537626S
	2013.05-		Rear	Estate 4WD CUNA/CUPA/DJGA		Flexible Coupling Kit	533882S
2.0 (147 kw)	2020.06-		Front	Estate 4WD DTUA		Flexible Coupling	537626
	2020.06-		Front	Estate 4WD DTUA		Flexible Coupling Kit	537626S
Superb							
1.4 (110 kw)	2015.03-		Front	Estate 4WD CZEA		Flexible Coupling	537626
	2015.03-		Front	Hatchback 4WD CZEA		Flexible Coupling	537626
	2015.03-		Rear	Estate 4WD CZEA		Flexible Coupling	533882
	2015.03-		Rear	Hatchback 4WD CZEA		Flexible Coupling	533882
	2015.03-		Front	Estate 4WD CZEA		Flexible Coupling Kit	537626S
	2015.03-		Front	Hatchback 4WD CZEA		Flexible Coupling Kit	537626S
	2015.03-		Rear	Estate 4WD CZEA		Flexible Coupling Kit	533882S
	2015.03-		Rear	Hatchback 4WD CZEA		Flexible Coupling Kit	533882S
1.8 (112 kw)	2009.03-2015.05		Rear	Hatchback 4WD CDAB		Flexible Coupling	533882
	2009.03-2015.05		Rear	Estate 4WD CDAB		Flexible Coupling	533882
1.8 (118 kw)	2008.11-2015.05		Rear	Hatchback 4WD CDAA		Flexible Coupling	533882
	2009.10-2015.05		Rear	Estate 4WD CDAA		Flexible Coupling	533882
2.0 (103 kw)	2010.11-2015.05		Rear	Hatchback 4WD CFFB		Flexible Coupling	533882
	2010.11-2015.05		Rear	Estate 4WD CFFB		Flexible Coupling	533882
2.0 (110 kw)	2015.03-		Front	Hatchback 4WD CRLB/DFEA/DFGA		Flexible Coupling	537626
	2015.03-		Front	Estate 4WD CRLB/DFEA/DFGA		Flexible Coupling	537626
	2015.03-		Rear	Hatchback 4WD CRLB/DFEA/DFGA		Flexible Coupling	533882
	2015.03-		Rear	Estate 4WD CRLB/DFEA/DFGA		Flexible Coupling	533882
	2015.03-		Front	Hatchback 4WD CRLB/DFEA/DFGA		Flexible Coupling Kit	537626S
	2015.03-		Front	Estate 4WD CRLB/DFEA/DFGA		Flexible Coupling Kit	537626S
	2015.03-		Rear	Hatchback 4WD CRLB/DFEA/DFGA		Flexible Coupling Kit	533882S
2.0 (125 kw)	2008.09-2015.05		Rear	Hatchback 4WD CBBB/CFGB		Flexible Coupling	533882
	2009.10-2015.05		Rear	Estate 4WD CBBB/CFGB		Flexible Coupling	533882
2.0 (140 kw)	2015.03-		Front	Estate 4WD DDAA/DFCA/DFHA		Flexible Coupling	537626
	2015.03-		Rear	Estate 4WD DDAA/DFCA/DFHA		Flexible Coupling	533882
	2015.03-		Front	Estate 4WD DDAA/DFCA/DFHA		Flexible Coupling Kit	537626S
	2015.03-		Rear	Estate 4WD DDAA/DFCA/DFHA		Flexible Coupling Kit	533882S
	2015.08-		Front	Hatchback 4WD DDAA/DFCA		Flexible Coupling	537626
	2015.08-		Rear	Hatchback 4WD DDAA/DFCA		Flexible Coupling	533882
	2015.08-		Front	Hatchback 4WD DDAA/DFCA		Flexible Coupling Kit	537626S
	2015.08-		Rear	Hatchback 4WD DDAA/DFCA		Flexible Coupling Kit	533882S
2.0 (147 kw)	2020.09-		Front	Estate 4WD DTUA		Flexible Coupling	537626
	2020.09-		Front	Hatchback 4WD DTUA		Flexible Coupling	537626
	2020.09-		Rear	Estate 4WD DTUA		Flexible Coupling	533882
	2020.09-		Rear	Hatchback 4WD DTUA		Flexible Coupling	533882
	2020.09-		Front	Estate 4WD DTUA		Flexible Coupling Kit	537626S
	2020.09-		Front	Hatchback 4WD DTUA		Flexible Coupling Kit	537626S
2.0 (200 kw)	2015.03-		Front	Hatchback 4WD DNUA		Flexible Coupling	537626
	2015.03-		Front	Estate 4WD DNUA		Flexible Coupling	537626
	2015.03-		Rear	Hatchback 4WD DNUA		Flexible Coupling	533882



	 YEAR	TRANSM.	FITTING POSITION	BODY STYLE & DRIVE TYPE & ENGINE	REMARKS	 PRODUCT	GSP Ref.
SKODA Superb							
2.0 (200 kw)	2015.03-		Rear	Estate 4WD DNUA		Flexible Coupling	533882
	2015.03-		Front	Hatchback 4WD DNUA		Flexible Coupling Kit	537626S
	2015.03-		Front	Estate 4WD DNUA		Flexible Coupling Kit	537626S
2.0 (206 kw)	2015.03-		Front	Hatchback 4WD CJXA/DNFE		Flexible Coupling	537626
	2015.03-		Front	Estate 4WD CJXA/DNFE		Flexible Coupling	537626
	2015.03-		Rear	Hatchback 4WD CJXA/DNFE		Flexible Coupling	533882
	2015.03-		Rear	Estate 4WD CJXA/DNFE		Flexible Coupling	533882
	2015.03-		Front	Hatchback 4WD CJXA/DNFE		Flexible Coupling Kit	537626S
	2015.03-		Front	Estate 4WD CJXA/DNFE		Flexible Coupling Kit	537626S
	2015.03-		Rear	Hatchback 4WD CJXA/DNFE		Flexible Coupling Kit	533882S
	2015.03-		Rear	Estate 4WD CJXA/DNFE		Flexible Coupling Kit	533882S
3.6 (191 kw)	2008.09-2015.05		Rear	Hatchback 4WD CDVA		Flexible Coupling	533882
	2009.10-2015.05		Rear	Estate 4WD CDVA		Flexible Coupling	533882
Yeti							
1.4 (110 kw)	2015.05-2017.12		Rear	SUV 4WD CZDA		Flexible Coupling	533882
1.8 (112 kw)	2009.11-2017.12		Rear	SUV 4WD CDAB		Flexible Coupling	533882
1.8 (118 kw)	2009.05-2017.12		Rear	SUV 4WD CDAA		Flexible Coupling	533882
2.0 (81 kw)	2009.11-2017.12		Rear	SUV 4WD CFHF/CUUA/DFSA		Flexible Coupling	533882
2.0 (103 kw)	2009.05-2017.12		Rear	SUV 4WD CBDB/CFHC/CLCB		Flexible Coupling	533882
2.0 (110 kw)	2015.05-2017.12		Rear	SUV 4WD CUUB/DFSB		Flexible Coupling	533882
2.0 (125 kw)	2009.11-2015.12		Rear	SUV 4WD CEGA/CFJA		Flexible Coupling	533882
SSANGYONG Actyon							
2.0 (100 kw)	2007.07-2013.06		Centre	SUV 4WD D20DT		Center Bearing Support	514805
	2007.07-2013.06		Front;Rear	SUV 4WD D20DT		Flexible Coupling	533419
	2007.07-2013.06		Front;Rear	SUV 4WD D20DT	Date from:2010.08	Flexible Coupling	533419
2.0 (104 kw)	2006.04-2013.06		Centre	SUV 4WD D20DT		Center Bearing Support	514805
	2006.04-2013.06		Front;Rear	SUV 4WD D20DT		Flexible Coupling	533419
	2006.04-2013.06		Front;Rear	SUV 4WD D20DT	Date from:2010.08	Flexible Coupling	533419
2.0 (110 kw)	2011.01-		Centre	SUV 4WD G20DF		Center Bearing Support	514805
	2011.01-		Centre	SUV 4WD D20DTF		Center Bearing Support	514805
2.0 (129 kw)	2011.01-		Centre	SUV 4WD D20DTF		Center Bearing Support	514805
2.3 (110 kw)	2006.11-		Centre	SUV 4WD G23D		Center Bearing Support	514805
Actyon Sports							
2.0 (104 kw)	2007.04-2013.06		Centre	Pick up 4WD D20DT		Center Bearing Support	514805
	2007.04-2013.06		Front;Rear	Pick up 4WD D20DT		Flexible Coupling	533419
	2007.04-2013.06		Front;Rear	Pick up 4WD D20DT	Date from:2010.08	Flexible Coupling	533419
2.0 (110 kw)	2015.01-		Centre	Pick up 4WD D20DTR		Center Bearing Support	514805
2.0 (114 kw)	2012.01-		Centre	Pick up 4WD D20DTR		Center Bearing Support	514805
	2012.01-		Front;Rear	Pick up 4WD D20DTR		Flexible Coupling	533419
2.2 (131 kw)	2015.07-		Centre	Pick up 4WD D22DTR		Center Bearing Support	514805
	2015.07-		Front;Rear	Pick up 4WD D22DTR		Flexible Coupling	533419
2.3 (110 kw)	2011.09-		Centre	Pick up 4WD G23D		Center Bearing Support	514805
Chairman CM600S							
3.2 (162 kw)	1997.08-2008.08		Front;Rear	Saloon RWD 104992		Flexible Coupling	510579
Korando							
2.0 (108 kw)	2012.02-		Front;Rear	SUV 4WD G20D		Flexible Coupling	533419
2.0 (110 kw)	2010.11-		Front;Rear	SUV 4WD D20DTF		Flexible Coupling	533419
	2012.02-		Front;Rear	SUV 4WD G20D		Flexible Coupling	533419
	2015.07-		Front;Rear	SUV Van 4WD G20D		Flexible Coupling	533419
	2015.09-		Front;Rear	SUV 4WD G20D		Flexible Coupling	533419
2.0 (129 kw)	2010.11-		Front;Rear	SUV 4WD D20DTF		Flexible Coupling	533419
	2010.11-		Front;Rear	SUV Van 4WD D20DTF		Flexible Coupling	533419
2.2 (131 kw)	2015.07-		Front;Rear	SUV 4WD D22DTF		Flexible Coupling	533419
	2015.07-		Front;Rear	SUV Van 4WD D22DTF		Flexible Coupling	533419
Korando Sports							
2.0 (114 kw)	2012.01-		Centre	Pick up 4WD D20DTR		Center Bearing Support	514805
	2012.01-		Front;Rear	Pick up 4WD D20DTR		Flexible Coupling	533419
2.2 (131 kw)	2015.07-		Centre	Pick up 4WD D22DTR		Center Bearing Support	514805
	2015.07-		Front;Rear	Pick up 4WD D22DTR		Flexible Coupling	533419
Kyron							
2.0 (100 kw)	2005.09-	AT/MT	Rear	SUV 4WD D20DT		Propshaft	PS900458
	2005.09-		Centre	SUV 4WD D20DT		Center Bearing Support	514805
	2005.09-		Centre	SUV RWD D20DT		Center Bearing Support	514805



	 YEAR	TRANSM.	FITTING POSITION	BODY STYLE & DRIVE TYPE & ENGINE	REMARKS	 PRODUCT	GSP Ref.
SSANGYONG							
Kyron							
2.0 (101 kw)	2005.05-		Centre	SUV 4WD D20DT		Center Bearing Support	514805
2.0 (102 kw)	2006.01-		Front	SUV 4WD D20DT		Propshaft	PS900459
	2006.01-		Centre	SUV RWD D20DT		Center Bearing Support	514805
	2006.01-		Centre	SUV 4WD D20DT		Center Bearing Support	514805
2.0 (104 kw)	2005.09-	AT/MT	Rear	SUV 4WD D20DT		Propshaft	PS900458
	2005.09-		Centre	SUV 4WD D20DT		Center Bearing Support	514805
	2005.09-		Centre	SUV RWD D20DT		Center Bearing Support	514805
2.3 (110 kw)	2006.11-		Centre	SUV 4WD E23		Center Bearing Support	514805
	2010.01-		Centre	SUV RWD E23		Center Bearing Support	514805
2.7 (120 kw)	2005.05-		Centre	SUV 4WD D27DT		Center Bearing Support	514805
2.7 (121 kw)	2005.05-	AT/MT	Rear	SUV 4WD D27DT		Propshaft	PS900458
	2005.05-		Centre	SUV 4WD D27DT		Center Bearing Support	514805
3.2 (162 kw)	2006.05-		Centre	SUV 4WD G32D		Center Bearing Support	514805
Musso							
2.2 (133 kw)	2018.09-		Centre	Pick up RWD D22DTR(OM672980)		Center Bearing Support	514805
	2018.09-		Centre	Pick up 4WD D22DTR		Center Bearing Support	514805
Musso Grand							
2.2 (133 kw)	2019.01-		Centre	Pick up RWD D22DTR		Center Bearing Support	514805
	2019.01-		Centre	Pick up 4WD D22DTR		Center Bearing Support	514805
Rexton							
2.0 (114 kw)	2014.02-		Centre	SUV 4WD D20DTR		Center Bearing Support	514805
	2014.02-		Centre	SUV RWD D20DTR		Center Bearing Support	514805
REXTON							
2.0 (165 kw)	2018.07-		Centre	SUV RWD G20DTR		Center Bearing Support	514805
	2018.07-		Centre	SUV 4WD G20DTR		Center Bearing Support	514805
2.2 (133 kw)	2017.07-		Centre	SUV 4WD D22DTR(OM672980)		Center Bearing Support	514805
	2017.07-		Centre	SUV RWD D22DTR(OM672980)		Center Bearing Support	514805
Rexton							
2.3 (110 kw)	2002.05-2006.08		Centre	SUV 4WD G23D		Center Bearing Support	514805
2.7 (121 kw)	2004.05-2006.08		Centre	SUV 4WD D27DT		Center Bearing Support	514805
	2005.03-2006.08		Centre	SUV RWD D27DT		Center Bearing Support	514805
	2014.02-		Centre	SUV 4WD D27DT		Center Bearing Support	514805
2.7 (137 kw)	2006.05-2006.08		Centre	SUV 4WD D27DTP		Center Bearing Support	514805
	2014.02-		Centre	SUV 4WD D27DTP		Center Bearing Support	514805
2.8 (142 kw)	2003.03-2006.08		Centre	SUV 4WD M162E28		Center Bearing Support	514805
2.9 (88 kw)	2002.04-2006.08		Centre	SUV 4WD 662925		Center Bearing Support	514805
3.2 (162 kw)	2002.04-2006.08		Front	SUV 4WD G32D		Propshaft	PS900459
	2002.04-2006.08		Centre	SUV 4WD G32D		Center Bearing Support	514805
Rexton II							
2.7 (118 kw)	2011.03-2013.04		Centre	SUV 4WD D27DT		Center Bearing Support	514805
2.7 (120 kw)	2006.09-2013.04		Centre	SUV 4WD D27DT		Center Bearing Support	514805
2.7 (121 kw)	2006.09-2012.05		Centre	SUV 4WD D27DT		Center Bearing Support	514805
2.7 (130 kw)	2006.09-2009.12		Centre	SUV 4WD D27DT		Center Bearing Support	514805
2.7 (132 kw)	2008.02-2013.04	5AT	Front	SUV 4WD D27DTP		Propshaft	PS900459
	2008.02-2013.04		Centre	SUV 4WD D27DTP		Center Bearing Support	514805
2.7 (137 kw)	2006.06-2013.04		Centre	SUV 4WD D27DTP		Center Bearing Support	514805
3.2 (162 kw)	2006.09-2013.04		Front	SUV 4WD G32D		Propshaft	PS900459
	2006.09-2013.04		Centre	SUV 4WD G32D		Center Bearing Support	514805
Rexton Sports							
2.2 (133 kw)	2018.07-		Centre	Pick up 4WD D22DTR		Center Bearing Support	514805
Rexton Sports XL							
2.2 (133 kw)	2019.01-		Centre	Pick up RWD D22DTR		Center Bearing Support	514805
	2019.01-		Centre	Pick up 4WD D22DTR		Center Bearing Support	514805
Rexton W							
2.0 (110 kw)	2013.07-		Centre	SUV RWD D20DTR		Center Bearing Support	514805
	2013.07-		Centre	SUV 4WD D20DTR		Center Bearing Support	514805
2.0 (114 kw)	2012.07-		Centre	SUV 4WD D20DTR		Center Bearing Support	514805
	2013.01-		Centre	SUV RWD D20DTR		Center Bearing Support	514805
2.2 (131 kw)	2015.07-		Centre	SUV 4WD D22DTR(OM672980)		Center Bearing Support	514805
	2015.07-		Centre	SUV RWD D22DTR(OM672980)		Center Bearing Support	514805
2.7 (121 kw)	2012.07-		Centre	SUV 4WD D27DT		Center Bearing Support	514805
2.7 (137 kw)	2012.10-		Centre	SUV 4WD D27DTP		Center Bearing Support	514805

	 YEAR	TRANSM.	FITTING POSITION	BODY STYLE & DRIVE TYPE & ENGINE	REMARKS	 PRODUCT	GSP Ref.
SSANGYONG							
Rodiis							
2.0 (114 kw)	2012.06-		Centre	MPV 4WD D20DTR		Center Bearing Support	514805
	2012.06-		Centre	MPV RWD D20DTR		Center Bearing Support	514805
	2012.06-		Front;Rear	MPV 4WD D20DTR		Flexible Coupling	533419
2.2 (131 kw)	2015.07-		Centre	MPV 4WD D22DTR		Center Bearing Support	514805
	2015.07-		Centre	MPV RWD D22DTR		Center Bearing Support	514805
	2015.07-		Front;Rear	MPV 4WD D22DTR		Flexible Coupling	533419
	2015.07-		Front;Rear	SUV Van 4WD D22DTR(OM672980)		Flexible Coupling	533419
3.2 (162 kw)	2012.06-		Centre	MPV 4WD G32D		Center Bearing Support	514805
	2012.06-		Centre	MPV RWD M162E32		Center Bearing Support	514805
Stavic							
2.0 (110 kw)	2013.06-		Centre	MPV RWD D20DTR		Center Bearing Support	514805
Turismo							
2.0 (114 kw)	2013.08-		Centre	MPV 4WD D20DTR		Center Bearing Support	514805
	2013.08-		Centre	MPV RWD D20DTR		Center Bearing Support	514805
	2013.08-		Front;Rear	MPV 4WD D20DTR		Flexible Coupling	533419
2.2 (131 kw)	2015.08-		Centre	MPV RWD D22DTR		Center Bearing Support	514805
	2015.08-		Centre	MPV 4WD D22DTR		Center Bearing Support	514805
	2015.08-		Front;Rear	MPV 4WD D22DTR		Flexible Coupling	533419
SUBARU							
Forester							
2.0 (90 kw)	1997.08-2002.09		Centre	SUV 4WD EJ20J		Center Bearing Support	514780
2.0 (92 kw)	1998.09-2002.05		Centre	SUV 4WD EJ202		Center Bearing Support	514780
	2002.06-2005.05		Centre	SUV 4WD EJ201		Center Bearing Support	514804
2.0 (110 kw)	2008.01-2013.09	4AT	Rear	SUV 4WD EJ204		Propshaft	PS900460
	2010.01-2013.09	4AT	Rear	SUV 4WD FB20A/FB20B		Propshaft	PS900460
	2013.03-	MT	Rear	SUV 4WD FB20A/FB20B		Propshaft	PS900461
2.0 (116 kw)	2005.06-2008.05		Centre	SUV 4WD EJ204		Center Bearing Support	514804
2.0 (125 kw)	1998.09-2001.04		Centre	SUV 4WD EJ205		Center Bearing Support	514780
2.0 (130 kw)	2000.10-2002.05		Centre	SUV 4WD EJ205		Center Bearing Support	514780
	2002.02-2005.05		Centre	SUV 4WD EJ205		Center Bearing Support	514804
2.5 (123 kw)	1997.07-2002.05		Centre	SUV 4WD EJ254		Center Bearing Support	514780
2.5 (126 kw)	2008.06-2013.09	4AT	Rear	SUV 4WD EJ253		Propshaft	PS900460
	2011.03-2013.09	4AT	Rear	SUV 4WD FB25		Propshaft	PS900460
	2014.07-	MT	Rear	SUV 4WD FB25B		Propshaft	PS900461
2.5 (129 kw)	2005.01-2010.10		Centre	SUV 4WD EJ253		Center Bearing Support	514804
2.5 (169 kw)	2005.06-2008.05		Centre	SUV 4WD EJ255		Center Bearing Support	514804
	2008.06-2013.09	4AT	Rear	SUV 4WD EJ255		Propshaft	PS900460
2.5 (171 kw)	2003.09-2010.12		Centre	SUV 4WD EJ255		Center Bearing Support	514804
2.5 (188 kw)	2005.05-2005.09		Centre	SUV 4WD EJ255		Center Bearing Support	514804
2.5 (193 kw)	2011.02-2013.09	4AT	Rear	SUV 4WD EJ255		Propshaft	PS900460
Impreza							
2.0 (110 kw)	2007.09-2012.03	4AT	Rear	Hatchback 4WD EJ204		Propshaft	PS900460
	2007.09-2012.03	4AT	Rear	Saloon 4WD EJ204		Propshaft	PS900460
Impreza WRX							
2.5 (169 kw)	2007.09-2013.08	4AT	Rear	Saloon 4WD EJ255		Propshaft	PS900460
2.5 (195 kw)	2010.06-2013.08	4AT	Rear	Saloon 4WD EJ255		Propshaft	PS900460
2.5 (221 kw)	2008.01-2013.08	4AT	Rear	Hatchback 4WD EJ257		Propshaft	PS900460
	2010.06-2013.08	4AT	Rear	Saloon 4WD EJ257		Propshaft	PS900460
Legacy							
2.0 (121 kw)	2005.06-2009.04		Centre	Saloon 4WD EJ204		Center Bearing Support	514803
2.5 (121 kw)	2003.09-2009.04		Centre	Saloon 4WD EJ253		Center Bearing Support	514803
2.5 (123 kw)	2009.05-2014.12	CVT	Rear	Saloon 4WD EJ253		Propshaft	PS900464
2.5 (127 kw)	2007.09-2009.12	AT	Rear	Saloon 4WD EJ252		Propshaft	PS900463
	2007.09-2009.12		Centre	Saloon 4WD EJ252		Center Bearing Support	514803
3.0 (180 kw)	2003.09-2009.06	AT	Rear	Saloon 4WD 30D		Propshaft	PS900463
Legacy Estate/Wagon							
2.0 (121 kw)	2005.06-2009.04		Centre	Estate 4WD EJ204		Center Bearing Support	514803
2.5 (121 kw)	2003.09-2009.04		Centre	Estate 4WD EJ253		Center Bearing Support	514803
2.5 (127 kw)	2008.01-2009.12		Centre	Estate 4WD EJ252		Center Bearing Support	514803
Outback							
2.5 (127 kw)	2008.09-2009.09	AT	Rear	Estate 4WD EJ252		Propshaft	PS900463
2.5 (171 kw)	2006.09-2009.09	AT	Rear	Estate AWD EJ255		Propshaft	PS900463
2.5 (186 kw)	2005.01-2009.12	AT	Rear	Estate AWD EJ255		Propshaft	PS900463



	 YEAR	TRANSM.	FITTING POSITION	BODY STYLE & DRIVE TYPE & ENGINE	REMARKS	 PRODUCT	GSP Ref.
SUBARU							
Outback							
3.0 (180 kw)	2003.09-2009.09	AT	Rear	Estate 4WD 30D/EZ30D/EZ30R		Propshaft	PS900463
XV							
2.0 (110 kw)	2011.09-	MT	Rear	SUV 4WD FB20A/FB20B		Propshaft	PS900461
SUZUKI							
Equator							
4.0 (195 kw)	2008.09-2011.12		Rear	Pick up AWD VQ40DE		Joint,propshaft	801298
Grand Escudo							
1.6 (78 kw)	2005.04-2008.12	MT	Front	Terrain cab wagon closed 4WD M16A		Propshaft	PS900608
	2005.04-2008.12		Front	Terrain cab wagon closed 4WD M16A		Joint,propshaft	835068
	2005.10-2007.12		Front	Terrain cab wagon closed RWD M16A		Joint,propshaft	835068
2.0 (103 kw)	2005.09-2011.12	AT/MT	Front	Terrain cab wagon closed 4WD J20A		Propshaft	PS900608
	2005.09-2011.12		Front	Terrain cab wagon closed 4WD J20A		Joint,propshaft	835068
	2005.10-2011.12		Front	Terrain cab wagon closed RWD J20A		Joint,propshaft	835068
Grand Vitara							
1.6 (73 kw)	2005.09-2015.02		Front	Terrain cab wagon closed 4WD M16A		Joint,propshaft	835068
1.6 (77 kw)	2005.04-		Front	Terrain cab wagon closed 4WD M16A		Joint,propshaft	835068
1.6 (78 kw)	2005.04-2015.02	MT	Front	Terrain cab wagon closed 4WD M16A		Propshaft	PS900608
	2005.04-2015.02		Front	Terrain cab wagon closed 4WD M16A		Joint,propshaft	835068
	2005.10-2015.02		Front	Terrain cab wagon closed RWD M16A		Joint,propshaft	835068
1.9 (95 kw)	2005.10-2015.02	MT	Front	Terrain cab wagon closed 4WD F90B/F90C		Propshaft	PS900608
2.0 (99 kw)	2010.01-		Front	Terrain cab wagon closed RWD J20A		Joint,propshaft	835068
2.0 (103 kw)	2005.09-2015.02	AT/MT	Front	Terrain cab wagon closed 4WD J20A		Propshaft	PS900608
	2005.09-2015.02		Front	Terrain cab wagon closed 4WD J20A		Joint,propshaft	835068
2.4 (122 kw)	2008.06-	AT/MT	Front	Terrain cab wagon closed 4WD J24B		Propshaft	PS900608
	2008.06-		Front	Terrain cab wagon closed 4WD J24B		Joint,propshaft	835068
	2009.01-		Front	Terrain cab wagon closed RWD J24B		Joint,propshaft	835068
2.4 (124 kw)	2008.06-2015.02	AT/MT	Front	Terrain cab wagon closed 4WD J24B		Propshaft	PS900608
	2008.06-2015.02		Front	Terrain cab wagon closed 4WD J24B		Joint,propshaft	835068
	2009.01-2015.02		Front	Terrain cab wagon closed RWD J24B		Joint,propshaft	835068
2.7 (136 kw)	2007.01-2008.12	AT	Front	Terrain cab wagon closed 4WD H27A		Propshaft	PS900608
	2007.01-2008.12		Front	Terrain cab wagon closed 4WD H27A		Joint,propshaft	835068
2.7 (138 kw)	2005.09-	AT	Front	Terrain cab wagon closed 4WD H27A		Propshaft	PS900608
	2005.09-		Front	Terrain cab wagon closed 4WD H27A		Joint,propshaft	835068
	2006.01-2008.12	AT	Front	Terrain cab wagon closed RWD H27A	Date From:2006.01	Propshaft	PS900608
	2006.01-2008.12		Front	Terrain cab wagon closed RWD H27A		Joint,propshaft	835068
Grand Vitara II							
2.0 (101 kw)	2005.10-		Front	Closed Off-Road Vehicle RWD J20A		Joint,propshaft	835068
2.7 (126 kw)	2006.10-2007.11		Front	Closed Off-Road Vehicle AWD H 27 A		Joint,propshaft	835068
Grand Vitara II/Grand Escudo							
2.0 (95 kw)	2007.07-2010.02		Front	Closed Off-Road Vehicle AWD J20A		Joint,propshaft	835068
SX4							
1.4 (103 kw)	2016.08-	AT/MT	-	Hatchback 4WD K14C		Propshaft	PS900465
SX4 S-Cross							
1.0 (82 kw)	2016.08-	AT/MT	-	Hatchback 4WD K10C		Propshaft	PS900465
1.4 (103 kw)	2016.08-	AT/MT	-	Hatchback 4WD K14C		Propshaft	PS900465
1.6 (88 kw)	2013.08-	AT/MT	-	Hatchback 4WD M16A		Propshaft	PS900465
	2013.08-	AT/MT	-	Hatchback 4WD D16AA		Propshaft	PS900465
TOYOTA							
4 Runner							
3.0 (92 kw)	1993.08-1996.03		Centre	SUV 4WD 1KZT		Center Bearing Support	512093
	1993.08-1996.03		Centre	SUV 4WD 1KZT		Center Bearing Support	512369
	1995.11-2000.08		Centre	SUV 4WD 1KZT		Center Bearing Support	512093
	1995.11-2000.08		Centre	SUV 4WD 1KZT		Center Bearing Support	512369
3.0 (105 kw)	1990.01-1995.10		Centre	SUV 4WD 3VZE		Center Bearing Support	512093
	1990.01-1995.10		Centre	SUV 4WD 3VZE		Center Bearing Support	512369
Alex							
1.8 (100 kw)	2001.01-2006.09		Centre	Hatchback 4WD 1ZZFE		Center Bearing Support	514824
	2001.01-2006.09		Centre	Hatchback 4WD 1ZZFE		Center Bearing Support Kit	514824S
Allion							
1.8 (92 kw)	2001.06-2004.09		Front	Saloon 4WD 1ZZFE		Center Bearing Support	513043
1.8 (96 kw)	2013.03-		Front	Saloon 4WD 2ZRFAE		Center Bearing Support	513043
1.8 (97 kw)	2001.06-2007.04		Front	Saloon 4WD 1ZZFE		Center Bearing Support	513043
1.8 (98 kw)	2007.07-2013.02		Front	Saloon 4WD 2ZRFAE		Center Bearing Support	513043



	 YEAR	TRANSM.	FITTING POSITION	BODY STYLE & DRIVE TYPE & ENGINE	REMARKS	 PRODUCT	GSP Ref.
TOYOTA							
Alphard							
2.4 (117 kw)	2003.09-2008.04		Rear	MPV 4WD 2AZFE		Center Bearing Support	532824
3.0 (162 kw)	2003.04-2008.04		Rear	MPV 4WD 1MZFE		Center Bearing Support	532824
Altezza							
2.0 (118 kw)	1999.01-2005.05		Centre	Saloon RWD 1GF6		Center Bearing Support	513040
2.0 (147 kw)	1999.02-2005.11		Centre	Saloon RWD 3SGE		Center Bearing Support	513040
2.0 (154 kw)	1999.02-2005.11		Centre	Saloon RWD 3SGE		Center Bearing Support	513040
Altezza Gita							
2.0 (114 kw)	1999.01-2001.06		Centre	Estate RWD 1GF6		Center Bearing Support	513040
3.0 (157 kw)	2001.07-2005.11		Centre	Estate RWD 2JZGE		Center Bearing Support	513040
Aristo							
3.0 (169 kw)	1990.10-1997.07		Centre	Saloon RWD 2JZGE		Center Bearing Support	517626
3.0 (170 kw)	1997.08-2004.09		Centre	Saloon RWD 2JZGE		Center Bearing Support	517627
3.0 (205 kw)	1990.10-1997.07		Centre	Saloon RWD 2JZGTE		Center Bearing Support	517626
3.0 (206 kw)	1997.08-2004.09		Centre	Saloon RWD 2JZGTE		Center Bearing Support	517627
4.0 (173 kw)	1992.10-1997.07		Centre	Saloon 4WD 1UZFE		Center Bearing Support	517626
Avanza							
1.3 (63 kw)	2003.12-2011.10		Centre	MPV RWD K3DE/K3VE		Center Bearing Support	519034
1.3 (65 kw)	2002.09-2011.10		Centre	MPV RWD K3VE		Center Bearing Support	519034
1.3 (67 kw)	2006.08-2011.12		Centre	MPV RWD K3-VE		Center Bearing Support	519034
	2011.11-2015.07		Centre	MPV RWD K3VE		Center Bearing Support	519034
1.5 (76 kw)	2011.11-2015.07		Centre	MPV RWD 3SZVE		Center Bearing Support	519034
1.5 (80 kw)	2006.09-2011.12		Centre	MPV RWD 3SZVE		Center Bearing Support	519034
bB							
1.5 (80 kw)	2000.03-2005.12		Front;Rear	MPV FWD 1NZFE		Center Bearing Support	537001
Caldina							
2.0 (110 kw)	2002.09-2007.06		Front	Estate 4WD 1AZFSE		Center Bearing Support	513043
2.0 (114 kw)	2002.09-2007.06		Front	Estate 4WD 1AZFSE		Center Bearing Support	513043
2.0 (191 kw)	2002.09-2007.06		Front	Estate 4WD 3SGTE		Center Bearing Support	513043
2.0 (192 kw)	1997.08-2002.09		Rear	Estate 4WD 3SGTE		Center Bearing Support	532824
2.2 (69 kw)	1997.08-2002.09		Centre	Estate 4WD 3CTE		Center Bearing Support	513001
Celsior							
4.0 (180 kw)	1988.12-1993.04		Centre	Saloon RWD 1UZFE		Center Bearing Support	517626
4.3 (208 kw)	2000.08-2006.08		Centre	Saloon RWD 3UZFE		Center Bearing Support	517627
Chaser							
2.5 (132 kw)	1992.10-1996.08		Centre	Saloon RWD 1JZGE		Center Bearing Support	513041
2.5 (206 kw)	1992.10-1996.08		Centre	Saloon RWD 1JZGTE		Center Bearing Support	513041
Coaster							
2.4 (72 kw)	1982.05-1993.01		Centre	BUS RWD 22R		Center Bearing Support	517684
2.7 (107 kw)	2013.10-		Centre	BUS RWD 2TRFE		Center Bearing Support	517684
2.7 (112 kw)	1999.08-2003.10		Centre	BUS RWD 3RZFE		Center Bearing Support	517684
2.7 (119 kw)	1993.01-		Centre	BUS RWD 2TRFE		Center Bearing Support	517684
3.4 (66 kw)	1982.05-1993.01		Centre	BUS RWD 3B		Center Bearing Support	517684
	1993.01-1999.06		Centre	BUS RWD 3B		Center Bearing Support	517684
3.7 (71 kw)	1982.05-1993.01		Centre	BUS RWD 14B		Center Bearing Support	517684
3.7 (74 kw)	2004.08-2009.12		Centre	BUS RWD 14B		Center Bearing Support	517684
4.1 (85 kw)	2003.11-		Centre	BUS RWD 1BZFPE		Center Bearing Support	517684
4.1 (92 kw)	1995.12-1999.07		Centre	BUS RWD 15BF		Center Bearing Support	517684
4.1 (125 kw)	1999.07-2004.07		Centre	BUS RWD 15BFTE		Center Bearing Support	517684
4.2 (59 kw)	1987.10-1993.01		Centre	BUS RWD 1HZ		Center Bearing Support	517684
4.2 (92 kw)	1987.10-1993.01		Centre	BUS RWD 1HZ		Center Bearing Support	517684
4.2 (94 kw)	1993.01-		Centre	BUS RWD 1HZ		Center Bearing Support	517684
4.2 (96 kw)	1993.01-2008.08		Centre	BUS RWD 1HZ		Center Bearing Support	517684
4.2 (100 kw)	2004.08-		Centre	BUS RWD 1HZ		Center Bearing Support	517684
4.2 (118 kw)	1990.01-1993.01		Centre	BUS AWD 1HD-T		Center Bearing Support	517684
	1993.01-		Centre	BUS AWD 1HD-T		Center Bearing Support	517684
Corolla							
1.6 (85 kw)	1995.06-2000.07		Front;Rear	Saloon 4WD 4AFE		Center Bearing Support	514823
1.8 (92 kw)	2000.08-2006.10		Centre	Saloon 4WD 1ZZFE		Center Bearing Support	514824
	2002.05-2004.05		Centre	Saloon FWD 1ZZFE		Center Bearing Support	514824
1.8 (100 kw)	2001.12-2007.02		Centre	Hatchback 4WD 1ZZFE		Center Bearing Support	514824
	2001.12-2007.02		Centre	Hatchback 4WD 1ZZFE		Center Bearing Support Kit	514824S
Corolla Altis							
1.5 (80 kw)	2001.11-2004.05		Centre	Saloon 4WD 1NZFE		Center Bearing Support	514824
	2001.11-2007.07		Centre	Saloon FWD 1NZFE		Center Bearing Support	514824



	 YEAR	TRANSM.	FITTING POSITION	BODY STYLE & DRIVE TYPE & ENGINE	REMARKS	 PRODUCT	GSP Ref.
TOYOTA							
Corolla Axio							
1.5 (77 kw)	2007.08-2012.05		Front	Saloon 4WD 1NZFE		Center Bearing Support	513043
1.8 (98 kw)	2007.08-2012.05		Front	Saloon 4WD 2ZRFE		Center Bearing Support	513043
Corolla Estate/Wagon							
1.8 (81 kw)	1992.09-1997.04		Front;Rear	Estate FWD 7AFE		Center Bearing Support	514823
	1995.09-1997.04		Front;Rear	Estate 4WD 7AFE		Center Bearing Support	514823
	1997.04-2001.10		Front;Rear	Estate 4WD 7AFE		Center Bearing Support	514823
	1997.10-2001.10		Front;Rear	Estate FWD 7AFE		Center Bearing Support	514823
Corolla Fielder							
1.5 (77 kw)	2006.09-2012.04		Front	Estate 4WD 1NZFE		Center Bearing Support	513043
1.5 (81 kw)	2006.09-2012.04		Front	Estate FWD 1NZFE		Center Bearing Support	513043
1.8 (98 kw)	2006.09-2012.04		Front	Estate 4WD 2ZRFE		Center Bearing Support	513043
1.8 (100 kw)	2006.09-2012.04		Front	Estate FWD 2ZRFE		Center Bearing Support	513043
Corolla II							
1.5 (92 kw)	1990.08-1992.04		Front;Rear	Hatchback 4WD 5EFE		Center Bearing Support	537001
Corolla Levin							
1.6 (85 kw)	1991.06-1997.08		Front;Rear	Coupe FWD 4AFE		Center Bearing Support	514823
Corolla RunX							
1.8 (100 kw)	2001.01-2006.09		Centre	Hatchback 4WD 1ZZFE		Center Bearing Support	514824
	2001.01-2006.09		Centre	Hatchback 4WD 1ZZFE		Center Bearing Support Kit	514824S
Corolla Spacio							
1.5 (80 kw)	2001.07-2004.01		Centre	MPV FWD 1NZFE		Center Bearing Support	514824
1.8 (97 kw)	2004.02-2009.03		Centre	MPV FWD 1ZZFE		Center Bearing Support	514824
1.8 (99 kw)	2001.07-2007.05		Centre	MPV 4WD 1ZZFE		Center Bearing Support	514824
Corona							
2.0 (54 kw)	1992.08-1996.01		Centre	Saloon 4WD 2C		Center Bearing Support	513001
Corsa							
1.5 (67 kw)	1994.09-1997.12		Front;Rear	Hatchback 4WD 5EFE		Center Bearing Support	537001
	1994.09-1999.07		Front;Rear	Saloon 4WD 5EFE		Center Bearing Support	537001
1.5 (74 kw)	1990.10-1994.09		Front;Rear	Hatchback 4WD 5EFE		Center Bearing Support	537001
	1990.10-1994.09		Front;Rear	Saloon 4WD 5EFE		Center Bearing Support	537001
Crown							
2.5 (132 kw)	1995.12-2001.08		Centre	Saloon RWD 1JZGE		Center Bearing Support	513042
	1995.12-2001.08		Centre	Saloon RWD 1JZGE		Center Bearing Support	513055
3.0 (162 kw)	1995.12-2001.07		Centre	Saloon 4WD 2JZGE		Center Bearing Support	517626
Crown Majesta							
3.0 (162 kw)	1991.10-1995.08		Centre	Saloon RWD 2JZGE		Center Bearing Support	517626
3.0 (169 kw)	1991.08-1999.08		Centre	Saloon RWD 2JZGE		Center Bearing Support	517626
4.0 (191 kw)	1993.08-1995.08		Centre	Saloon RWD 1UZFE		Center Bearing Support	517626
4.0 (195 kw)	1991.08-1995.08		Centre	Saloon RWD 1UZFE		Center Bearing Support	517626
	1992.10-1995.08		Centre	Saloon 4WD 1UZFE		Center Bearing Support	517626
4.0 (206 kw)	1999.09-2003.08		Centre	Saloon RWD 1UZFE		Center Bearing Support	517627
	1999.09-2004.05		Centre	Saloon 4WD 1UZFE		Center Bearing Support	517627
Dyna							
3.4 (66 kw)	1984.09-1995.06		Centre	Chassis cabin RWD 13B/3B		Center Bearing Support	517684
Dyna 150							
3.4 (66 kw)	1988.09-1995.04		Centre	Chassis cabin RWD 3B		Center Bearing Support	513559
4.6 (96 kw)	2003.06-		Centre	Chassis cabin RWD S05C		Center Bearing Support	517684
Dyna 200							
3.0 (75 kw)	1988.08-1995.05		Centre	Chassis cabin RWD 11B		Center Bearing Support	513559
	1988.08-1995.05		Centre	Chassis cabin RWD 11B		Center Bearing Support	517684
3.4 (66 kw)	1992.10-1995.05		Centre	Chassis cabin RWD 3B		Center Bearing Support	517684
	1995.06-1999.05		Centre	Chassis cabin RWD 3B		Center Bearing Support	513559
	1995.06-1999.05		Centre	Chassis cabin RWD 3B		Center Bearing Support	517684
3.7 (71 kw)	1995.06-2001.07		Centre	Chassis cabin RWD 14B		Center Bearing Support	517684
3.7 (85 kw)	1989.10-1995.04		Centre	Platform/Chassis RWD 14BT		Center Bearing Support	517684
4.1 (125 kw)	1999.06-2001.07		Centre	Chassis cabin RWD 15BFTE		Center Bearing Support	513559
Dyna 300							
3.4 (66 kw)	1995.06-1999.05		Centre	Chassis cabin RWD 3B		Center Bearing Support	513559
Dyna 400							
4.6 (88 kw)	2000.10-2006.09		Centre	Platform/Chassis RWD S05C		Center Bearing Support	517684
Estima							
2.4 (99 kw)	1990.05-1999.12		Centre	MPV 4WD 2TZFE		Center Bearing Support	514822
	1990.05-1999.12		Front;Rear	MPV 4WD 2TZFE		Flexible Coupling	511086
	1990.05-1999.12		Front;Rear	MPV 4WD 2TZFE		Flexible Coupling Kit	511086S



	 YEAR	TRANSM.	FITTING POSITION	BODY STYLE & DRIVE TYPE & ENGINE	REMARKS	 PRODUCT	GSP Ref.
TOYOTA							
Estima							
2.4 (110 kw)	1990.05-1999.12		Centre	MPV 4WD 2TZFZE		Center Bearing Support	514822
	1990.05-1999.12		Front;Rear	MPV 4WD 2TZFZE		Flexible Coupling Kit	511086S
2.4 (118 kw)	1993.09-1999.12		Centre	MPV 4WD 2TZFZE		Center Bearing Support	514822
	1993.09-1999.12		Front;Rear	MPV RWD 2TZFZE		Flexible Coupling	511086
	1993.09-1999.12		Front;Rear	MPV 4WD 2TZFZE		Flexible Coupling	511086
	1993.09-1999.12		Front;Rear	MPV RWD 2TZFZE		Flexible Coupling Kit	511086S
	1993.09-1999.12		Front;Rear	MPV 4WD 2TZFZE		Flexible Coupling Kit	511086S
3.0 (162 kw)	2000.02-2006.01		Rear	MPV 4WD 2AZFE		Center Bearing Support	532824
	2000.02-2005.12		Rear	MPV 4WD 1MZFE		Center Bearing Support	532824
Estima Emina							
2.2 (74 kw)	1992.01-1999.08		Rear	MPV RWD 3CT/3CTE		Flexible Coupling	513053
	1992.01-1999.08		Rear	MPV RWD 3CT/3CTE		Flexible Coupling Kit	513053S
2.4 (99 kw)	1992.01-1999.12		Centre	MPV 4WD 2TZFE		Center Bearing Support	514822
	1992.01-1999.12		Front;Rear	MPV 4WD 2TZFE		Flexible Coupling Kit	511086S
Estima Lucida							
2.2 (74 kw)	1992.01-1999.08		Centre	MPV 4WD 3CT/3CTE		Center Bearing Support	514822
	1992.01-1999.08		Rear	MPV RWD 3CT/3CTE		Flexible Coupling	513053
	1992.01-1999.08		Rear	MPV 4WD 3CT/3CTE		Flexible Coupling	513053
	1992.01-1999.08		Rear	MPV RWD 3CT/3CTE		Flexible Coupling Kit	513053S
	1992.01-1999.08		Rear	MPV 4WD 3CT/3CTE		Flexible Coupling Kit	513053S
2.2 (77 kw)	1992.01-1999.08		Centre	MPV 4WD 3CTE		Center Bearing Support	514822
	1992.01-1999.08		Rear	MPV RWD 3CTE		Flexible Coupling	513053
	1992.01-1999.08		Rear	MPV 4WD 3CTE		Flexible Coupling	513053
	1992.01-1999.08		Rear	MPV RWD 3CTE		Flexible Coupling Kit	513053S
	1992.01-1999.08		Rear	MPV 4WD 3CTE		Flexible Coupling Kit	513053S
2.4 (99 kw)	1992.01-1999.12		Front;Rear	MPV RWD 2TZFE		Flexible Coupling	511086
	1992.01-1999.12		Front;Rear	MPV RWD 2TZFE		Flexible Coupling Kit	511086S
Fortuner							
2.4 (108 kw)	2016.01-		Front	SUV 4WD 2GDFTV	Bearing Center Height:8.5mm,For GUN12',135	Center Bearing Support	533532
	2016.01-		Front	SUV 4WD 2GDFTV	Bearing Center Height:15.5mm,For GDN1'',GUN1'',XUN1'',LAN125,TDN1''	Center Bearing Support	533533
2.4 (110 kw)	2015.05-		Front	SUV RWD 2GDFTV	Bearing Center Height:8.5mm,For GUN12',135	Center Bearing Support	533532
	2015.05-		Front	SUV 4WD 2GDFTV	Bearing Center Height:8.5mm,For GUN12',135	Center Bearing Support	533532
	2015.05-		Front	SUV RWD 2GDFTV	Bearing Center Height:15.5mm,For GDN1'',GUN1'',XUN1'',LAN125,TDN1''	Center Bearing Support	533533
	2015.05-		Front	SUV 4WD 2GDFTV	Bearing Center Height:15.5mm,For GDN1'',GUN1'',XUN1'',LAN125,TDN1''	Center Bearing Support	533533
2.5 (75 kw)	2005.01-2015.05		Front	SUV 4WD 2KDFTV	Bearing Center Height:8.5mm,For GUN12',135	Center Bearing Support	533532
	2005.01-2015.05		Front	SUV 4WD 2KDFTV	Bearing Center Height:15.5mm,For GDN1'',GUN1'',XUN1'',LAN125,TDN1''	Center Bearing Support	533533
	2008.01-2011.12		Front	SUV RWD 2KDFTV	Bearing Center Height:8.5mm,For GUN12',135	Center Bearing Support	533532
	2008.01-2011.12		Front	SUV RWD 2KDFTV	Bearing Center Height:15.5mm,For GDN1'',GUN1'',XUN1'',LAN125,TDN1''	Center Bearing Support	533533
2.5 (106 kw)	2009.01-2015.05		Centre	SUV RWD 2KDFTV		Center Bearing Support	518878
	2009.01-2015.05		Centre	SUV RWD 2KDFTV		Center Bearing Support	531656
	2011.07-2015.05		Front	SUV 4WD 2KDFTV	Bearing Center Height:8.5mm,For GUN12',135	Center Bearing Support	533532
	2011.07-2015.05		Front	SUV 4WD 2KDFTV	Bearing Center Height:15.5mm,For GDN1'',GUN1'',XUN1'',LAN125,TDN1''	Center Bearing Support	533533
2.7 (116 kw)	2013.05-2015.05		Front	SUV RWD 2TRFE	Bearing Center Height:8.5mm,For GUN12',135	Center Bearing Support	533532
	2013.05-2015.05		Front	SUV 4WD 2TRFE	Bearing Center Height:8.5mm,For GUN12',135	Center Bearing Support	533532
	2013.05-2015.05		Front	SUV RWD 2TRFE	Bearing Center Height:15.5mm,For GDN1'',GUN1'',XUN1'',LAN125,TDN1''	Center Bearing Support	533533
	2013.05-2015.05		Front	SUV 4WD 2TRFE	Bearing Center Height:15.5mm,For GDN1'',GUN1'',XUN1'',LAN125,TDN1''	Center Bearing Support	533533
	2013.05-2015.05		Centre	SUV RWD 2TRFE	Bracket Fix Hole:30.5mm	Center Bearing Support	518878
	2013.05-2015.05		Centre	SUV RWD 2TRFE	Date from:2011.08	Center Bearing Support	531656
2.7 (118 kw)	2004.06-2015.05		Front	SUV RWD 2TRFE	Bearing Center Height:8.5mm,For GUN12',135	Center Bearing Support	533532
	2004.06-2015.05		Front	SUV 4WD 2TRFE	Bearing Center Height:8.5mm,For GUN12',135	Center Bearing Support	533532
	2004.06-2015.05		Front	SUV RWD 2TRFE	Bearing Center Height:15.5mm,For GDN1'',GUN1'',XUN1'',LAN125,TDN1''	Center Bearing Support	533533
	2004.06-2015.05		Front	SUV 4WD 2TRFE	Bearing Center Height:15.5mm,For GDN1'',GUN1'',XUN1'',LAN125,TDN1''	Center Bearing Support	533533
	2004.06-2015.05		Centre	SUV RWD 2TRFE	Date from:2005.04	Center Bearing Support	518878
	2004.06-2015.05		Centre	SUV RWD 2TRFE	Date from:2011.08	Center Bearing Support	531656
2.7 (120 kw)	2015.05-		Front	SUV 4WD 2TRFE	Bearing Center Height:8.5mm,For GUN12',135	Center Bearing Support	533532
	2015.05-		Front	SUV 4WD 2TRFE	Bearing Center Height:15.5mm,For GDN1'',GUN1'',XUN1'',LAN125,TDN1''	Center Bearing Support	533533
	2016.01-		Front	SUV RWD 2TRFE	Bearing Center Height:8.5mm,For GUN12',135	Center Bearing Support	533532
	2016.01-		Front	SUV RWD 2TRFE	Bearing Center Height:15.5mm,For GDN1'',GUN1'',XUN1'',LAN125,TDN1''	Center Bearing Support	533533
2.7 (121 kw)	2015.05-		Front	SUV 4WD 2TRFE	Bearing Center Height:8.5mm,For GUN12',135	Center Bearing Support	533532
	2015.05-		Front	SUV 4WD 2TRFE	Bearing Center Height:15.5mm,For GDN1'',GUN1'',XUN1'',LAN125,TDN1''	Center Bearing Support	533533
2.7 (122 kw)	2015.05-		Front	SUV 4WD 2TRFE	Bearing Center Height:8.5mm,For GUN12',135	Center Bearing Support	533532
	2015.05-		Front	SUV RWD 2TRFE	Bearing Center Height:8.5mm,For GUN12',135	Center Bearing Support	533532
	2015.05-		Front	SUV 4WD 2TRFE	Bearing Center Height:15.5mm,For GDN1'',GUN1'',XUN1'',LAN125,TDN1''	Center Bearing Support	533533
	2015.05-		Front	SUV RWD 2TRFE	Bearing Center Height:15.5mm,For GDN1'',GUN1'',XUN1'',LAN125,TDN1''	Center Bearing Support	533533



	 YEAR	TRANSM.	FITTING POSITION	BODY STYLE & DRIVE TYPE & ENGINE	REMARKS	 PRODUCT	GSP Ref.
TOYOTA Fortuner							
2.8 (130 kw)	2015.05-		Front	SUV 4WD 1GDFTV	Bearing Center Height:8.5mm,For GUN12',135	Center Bearing Support	533532
	2015.05-		Front	SUV 4WD 1GDFTV	Bearing Center Height:15.5mm,For GDN11',GUN11',LAN125,TGN11'	Center Bearing Support	533533
4.0 (175 kw)	2005.01-2015.05		Centre	SUV 4WD 1GRFE		Center Bearing Support	531656
	2005.08-2015.05		Centre	SUV RWD 1GRFE		Center Bearing Support	531656
Harrier							
2.4 (118 kw)	2000.10-2003.02	4AT	Rear	SUV 4WD 2AZFE		Propshaft	PS900503
	2003.10-2013.12	4AT	Rear	SUV 4WD 2AZFE		Propshaft	PS900503
	2003.10-2013.12		Rear	SUV 4WD 2AZFE		Center Bearing Support	532824
3.0 (164 kw)	1997.05-2003.02		Rear	SUV 4WD 1MZFE		Center Bearing Support	532824
	2003.08-2006.01	5AT	Rear	SUV 4WD 1MZFE		Propshaft	PS900503
	2003.08-2006.01		Rear	SUV 4WD 1MZFE		Center Bearing Support	532824
3.5 (206 kw)	2005.04-2008.12	AT	Rear	SUV 4WD 2GRFE		Propshaft	PS900503
	2005.04-2008.12		Rear	SUV 4WD 2GRFE		Center Bearing Support	532824
Hiace							
2.4 (55 kw)	1989.08-1995.08		Centre	BUS RWD 2L		Center Bearing Support	513562
2.4 (58 kw)	1995.08-2001.08		Centre	BUS RWD 2L		Center Bearing Support	512094
	1995.08-2001.08		Centre	VAN RWD 2L		Center Bearing Support	512094
2.4 (66 kw)	1995.08-2001.08		Centre	BUS RWD 2LT		Center Bearing Support	512094
	1995.08-2001.08		Centre	VAN RWD 2LT		Center Bearing Support	512094
	1996.10-2001.08		Centre	BUS 4WD 2LT		Center Bearing Support	512094
	1996.10-2001.08		Centre	VAN 4WD 2LT		Center Bearing Support	512094
2.4 (85 kw)	1995.08-1998.04		Centre	BUS RWD 2RZE		Center Bearing Support	512094
	1995.08-2003.11		Centre	VAN RWD 2RZE		Center Bearing Support	512094
2.5 (65 kw)	2001.08-2006.08		Centre	BUS RWD 2KDFTV		Center Bearing Support	512094
	2001.08-2006.08		Centre	VAN RWD 2KDFTV		Center Bearing Support	512094
2.5 (75 kw)	2001.08-2006.08		Centre	VAN 4WD 2KDFTV		Center Bearing Support	512094
	2001.08-2006.08		Centre	VAN RWD 2KDFTV		Center Bearing Support	512094
2.7 (105 kw)	1998.04-2001.11		Centre	BUS RWD 3RZFE		Center Bearing Support	512094
	1998.04-2006.06		Centre	VAN RWD 3RZFE		Center Bearing Support	512094
Highlander							
2.4 (115 kw)	2000.06-2003.09	4AT	Rear	SUV 4WD 2AZFE		Propshaft	PS900503
	2000.06-2003.09		Rear	SUV 4WD 2AZFE		Center Bearing Support	532824
2.4 (118 kw)	2000.06-2003.09	AT	Rear	SUV 4WD 2AZFE		Propshaft	PS900503
3.0 (164 kw)	2000.11-2007.05	4AT	Rear	SUV 4WD 1MZFE		Propshaft	PS900503
	2000.11-2007.05		Rear	SUV 4WD 1MZFE		Center Bearing Support	532824
3.5 (201 kw)	2007.06-2014.02		Rear	SUV 4WD 2GRFE		Propshaft	PS900476
	2007.06-2014.02		Rear	SUV 4WD 2GRFE		Center Bearing Support	532824
Highlander Hybrid							
3.3 (200 kw)	2006.01-2010.12	5AT	Rear	SUV 4WD 3MZFE		Propshaft	PS900503
Hilux							
1.8 (61 kw)	1988.08-1997.11		Centre	Pick up RWD 2Y		Center Bearing Support	512093
	1988.08-1997.11		Centre	Pick up RWD 2Y		Center Bearing Support	512369
	1988.08-1997.11		Centre	Pick up RWD 2Y		Center Bearing Support	513763
2.0 (81 kw)	1997.08-2005.07		Centre	Pick up RWD 1RZE		Center Bearing Support	531656
2.4 (55 kw)	1994.09-1997.07		Centre	Pick up 4WD 2L		Center Bearing Support	513557
	1997.08-2005.04	MT	Rear	Pick up RWD 2L		Propshaft	PS900484
	1997.08-2005.04		Centre	Pick up RWD 2L		Center Bearing Support	512089
	1997.08-2005.04		Centre	Pick up RWD 2L		Center Bearing Support	512090
	1997.08-2005.04		Centre	Pick up RWD 2L		Center Bearing Support	531656
2.4 (58 kw)	1991.10-1997.07		Centre	Pick up 4WD 2L		Center Bearing Support	512093
	1991.10-1997.07		Centre	Pick up 4WD 2L		Center Bearing Support	512369
	1991.10-1997.07		Centre	Pick up 4WD 2L		Center Bearing Support	513557
	1991.10-1997.07		Centre	Pick up 4WD 2L		Center Bearing Support	513763
	1995.03-1997.07		Centre	Pick up RWD 2L		Center Bearing Support	512093
	1995.03-1997.07		Centre	Pick up RWD 2L		Center Bearing Support	512369
	1995.03-1997.07		Centre	Pick up RWD 2L		Center Bearing Support	513763
	1997.08-2005.07		Centre	Pick up RWD 2L		Center Bearing Support	512090
	1997.08-2005.07		Centre	Pick up RWD 2L		Center Bearing Support	531656
2.4 (59 kw)	1991.10-1997.07		Centre	Pick up RWD 2L		Center Bearing Support	512093
	1991.10-1997.07		Centre	Pick up RWD 2L		Center Bearing Support	512369
	1991.10-1997.07		Centre	Pick up RWD 2L		Center Bearing Support	513763
2.4 (61 kw)	1997.08-2001.08		Centre	Pick up RWD 2L		Center Bearing Support	531656
2.4 (66 kw)	1997.08-2001.07		Centre	Pick up RWD 2LT		Center Bearing Support	512090
	1997.08-2001.07		Centre	Pick up RWD 2LT		Center Bearing Support	531656

	 YEAR	TRANSM.	FITTING POSITION	BODY STYLE & DRIVE TYPE & ENGINE	REMARKS	 PRODUCT	GSP Ref.
TOYOTA Hilux							
2.4 (66 kw)	1998.08-2001.07	MT	Rear	Pick up 4WD 2LT		Propshaft	PS900484
	1998.08-2001.07		Centre	Pick up 4WD 2LT		Center Bearing Support	512091
	1998.08-2001.07		Centre	Pick up 4WD 2LT		Center Bearing Support	512369
2.4 (84 kw)	1989.09-1997.07		Centre	Pick up 4WD 22RE		Center Bearing Support	512093
	1989.09-1997.07		Centre	Pick up 4WD 22RE		Center Bearing Support	512369
	1989.09-1997.07		Centre	Pick up 4WD 22RE		Center Bearing Support	513557
	1989.09-1997.07		Centre	Pick up 4WD 22RE		Center Bearing Support	513763
2.4 (103 kw)	1997.08-2001.08		Centre	Pick up 4WD 2RZFE		Center Bearing Support	512093
	1997.08-2001.08		Centre	Pick up 4WD 2RZFE		Center Bearing Support	512369
	1997.08-2001.08		Centre	Pick up 4WD 2RZFE		Center Bearing Support	513763
	1997.08-2001.08		Centre	Pick up 4WD 2RZFE		Center Bearing Support	531656
2.4 (108 kw)	2015.05-		Front	Pick up RWD 2GDFTV	Bearing Center Height:8.5mm,For GUN12",135	Center Bearing Support	533532
	2015.05-		Front	Pick up 4WD 2GDFTV	Bearing Center Height:8.5mm,For GUN12",135	Center Bearing Support	533532
	2015.05-		Front	Pick up RWD 2GDFTV	Bearing Center Height:15.5mm,For GDN1",GUN1",XUN1",LAN125,TDN1"	Center Bearing Support	533533
	2015.05-		Front	Pick up 4WD 2GDFTV	Bearing Center Height:15.5mm,For GDN1",GUN1",XUN1",LAN125,TDN1"	Center Bearing Support	533533
2.4 (110 kw)	2015.05-	MT	Front	Pick up 4WD 2GDFTV	for OE No.:37140-0K010	Propshaft	PS900472
	2015.05-	MT	Front	Pick up 4WD 2GDFTV	for OE No.:37140-0K030	Propshaft	PS900479
	2015.05-		Front	Pick up RWD 2GDFTV	Bearing Center Height:8.5mm,For GUN12",135	Center Bearing Support	533532
	2015.05-		Front	Pick up 4WD 2GDFTV	Bearing Center Height:8.5mm,For GUN12",135	Center Bearing Support	533532
	2015.05-		Front	Pick up RWD 2GDFTV	Bearing Center Height:15.5mm,For GDN1",GUN1",XUN1",LAN125,TDN1"	Center Bearing Support	533533
	2015.05-		Front	Pick up 4WD 2GDFTV	Bearing Center Height:15.5mm,For GDN1",GUN1",XUN1",LAN125,TDN1"	Center Bearing Support	533533
2.4 (125 kw)	2018.10-		Front	Pick up 4WD 2GDFTV	Bearing Center Height:8.5mm,For GUN12",135	Center Bearing Support	533532
	2018.10-		Front	Pick up RWD 2GDFTV	Bearing Center Height:8.5mm,For GUN12",135	Center Bearing Support	533532
	2018.10-		Front	Pick up 4WD 2GDFTV	Bearing Center Height:15.5mm,For GDN1",GUN1",XUN1",LAN125,TDN1"	Center Bearing Support	533533
	2018.10-		Front	Pick up RWD 2GDFTV	Bearing Center Height:15.5mm,For GDN1",GUN1",XUN1",LAN125,TDN1"	Center Bearing Support	533533
2.5 (65 kw)	2001.11-2005.07		Centre	Pick up RWD 2KDFTV		Center Bearing Support	512090
	2001.11-2005.07		Centre	Pick up RWD 2KDFTV		Center Bearing Support	512093
	2001.11-2005.07		Centre	Pick up RWD 2KDFTV		Center Bearing Support	512369
	2001.11-2005.07		Centre	Pick up RWD 2KDFTV		Center Bearing Support	531656
	2005.08-2006.10		Centre	Pick up RWD 2KDFTV		Center Bearing Support	518878
	2005.08-2006.10		Centre	Pick up RWD 2KDFTV		Center Bearing Support	531656
2.5 (75 kw)	2001.08-2005.08		Centre	Pick up 4WD 2KDFTV		Center Bearing Support	512093
	2001.08-2005.08		Centre	Pick up 4WD 2KDFTV		Center Bearing Support	512369
	2001.08-2005.08		Centre	Pick up 4WD 2KDFTV		Center Bearing Support	513763
	2001.08-2005.08		Centre	Pick up 4WD 2KDFTV		Center Bearing Support	531656
	2005.03-2015.05	MT	Front	Pick up 4WD 2KDFTV	for OE No.:37140-0K010	Propshaft	PS900472
	2005.03-2015.05	MT	Front	Pick up 4WD 2KDFTV	for OE No.:37140-0K030	Propshaft	PS900479
	2005.03-2015.05	5MT	Rear	Pick up 4WD 2KDFTV		Propshaft	PS900481
	2005.03-2015.05		Centre	Pick up 4WD 2KDFTV		Center Bearing Support	518878
	2005.03-2015.05		Centre	Pick up RWD 2KDFTV		Center Bearing Support	518878
	2005.03-2015.05		Centre	Pick up 4WD 2KDFTV		Center Bearing Support	531656
	2005.03-2015.05		Centre	Pick up RWD 2KDFTV		Center Bearing Support	531656
2.5 (88 kw)	2006.06-2015.05	MT	Front	Pick up 4WD 2KDFTV	for OE No.:37140-0K010	Propshaft	PS900472
	2006.06-2015.05	MT	Front	Pick up 4WD 2KDFTV	for OE No.:37140-0K030	Propshaft	PS900479
	2006.06-2015.05	5MT	Rear	Pick up 4WD 2KDFTV		Propshaft	PS900481
	2006.06-2015.05		Centre	Pick up 4WD 2KDFTV		Center Bearing Support	518878
	2006.06-2015.05		Centre	Pick up RWD 2KDFTV		Center Bearing Support	518878
	2006.06-2015.05		Centre	Pick up 4WD 2KDFTV		Center Bearing Support	531656
	2006.06-2015.05		Centre	Pick up RWD 2KDFTV		Center Bearing Support	531656
	2006.06-2015.05		Centre	Pick up RWD 2KDFTV		Center Bearing Support	531656
2.5 (94 kw)	2004.11-2005.12	5MT	Rear	Pick up 4WD 2KDFTV		Propshaft	PS900481
	2004.11-2005.12		Centre	Pick up 4WD 2KDFTV		Center Bearing Support	518878
	2004.11-2005.12		Centre	Pick up 4WD 2KDFTV		Center Bearing Support	531656
2.5 (106 kw)	2007.12-2015.05	MT	Front	Pick up 4WD 2KDFTV	Date From:2008.01,for OE No.:37140-0K030	Propshaft	PS900479
	2007.12-2015.05	5MT	Rear	Pick up 4WD 2KDFTV		Propshaft	PS900481
	2007.12-2015.05		Centre	Pick up 4WD 2KDFTV		Center Bearing Support	518878
	2007.12-2015.05		Centre	Pick up 4WD 2KDFTV		Center Bearing Support	531656
	2010.01-2015.05		Centre	Pick up RWD 2KDFTV		Center Bearing Support	518878
	2010.01-2015.05		Centre	Pick up RWD 2KDFTV		Center Bearing Support	531656
2.7 (107 kw)	1997.08-2005.08		Centre	Chassis cabin RWD 3RZFE		Center Bearing Support	531656
	1998.01-2004.07		Centre	Pick up RWD 3RZFE		Center Bearing Support	531656
2.7 (116 kw)	2015.05-		Front	Pick up 4WD 2TRFE	Bearing Center Height:8.5mm,For GUN12",135	Center Bearing Support	533532
	2015.05-		Front	Pick up 4WD 2TRFE	Bearing Center Height:15.5mm,For GDN1",GUN1",XUN1",LAN125,TDN1"	Center Bearing Support	533533
2.7 (118 kw)	2005.08-2015.05		Front	Pick up RWD 2TRFE	Bearing Center Height:8.5mm,For GUN12",135	Center Bearing Support	533532
	2005.08-2015.05		Front	Pick up 4WD 2TRFE	Bearing Center Height:8.5mm,For GUN12",135	Center Bearing Support	533532



	 YEAR	TRANSM.	FITTING POSITION	BODY STYLE & DRIVE TYPE & ENGINE	REMARKS	 PRODUCT	GSP Ref.
TOYOTA Hilux							
2.7 (118 kw)	2005.08-2015.05		Front	Pick up RWD 2TRFE	Bearing Center Height:15.5mm,For GDN1**GUN1**XUN1**LAN125,TDN1**	Center Bearing Support	533533
	2005.08-2015.05		Front	Pick up 4WD 2TRFE	Bearing Center Height:15.5mm,For GDN1**GUN1**XUN1**LAN125,TDN1**	Center Bearing Support	533533
	2005.08-2015.05		Centre	Pick up RWD 2TRFE	Bracket Fix Hole:30.5mm	Center Bearing Support	518878
	2005.08-2015.05		Centre	Pick up 4WD 2TRFE	Bracket Fix Hole:30.5mm	Center Bearing Support	518878
	2005.08-2015.05		Centre	Pick up RWD 2TRFE	Bracket Fix Hole:30.5mm	Center Bearing Support	531656
	2005.08-2015.05		Centre	Pick up 4WD 2TRFE	Bracket Fix Hole:30.5mm	Center Bearing Support	531656
2.7 (121 kw)	2015.05-		Front	Pick up RWD 2TRFE	Bearing Center Height:8.5mm,For GUN12*,135	Center Bearing Support	533532
	2015.05-		Front	Pick up 4WD 2TRFE	Bearing Center Height:8.5mm,For GUN12*,135	Center Bearing Support	533532
	2015.05-		Front	Pick up RWD 2TRFE	Bearing Center Height:15.5mm,For GDN1**GUN1**XUN1**LAN125,TDN1**	Center Bearing Support	533533
	2015.05-		Front	Pick up 4WD 2TRFE	Bearing Center Height:15.5mm,For GDN1**GUN1**XUN1**LAN125,TDN1**	Center Bearing Support	533533
2.7 (122 kw)	2015.05-		Front	Pick up RWD 2TRFE	Bearing Center Height:8.5mm,For GUN12*,135	Center Bearing Support	533532
	2015.05-		Front	Pick up RWD 2TRFE	Bearing Center Height:15.5mm,For GDN1**GUN1**XUN1**LAN125,TDN1**	Center Bearing Support	533533
2.8 (130 kw)	2015.05-	MT	Front	Pick up 4WD 1GDFTV	for OE No.:37140-0K010	Propshaft	PS900472
	2015.05-	MT	Front	Pick up 4WD 1GDFTV	for OE No.:37140-0K030	Propshaft	PS900479
	2015.05-		Front	Pick up RWD 1GDFTV	Bearing Center Height:8.5mm,For GUN12*,135	Center Bearing Support	533532
	2015.05-		Front	Pick up 4WD 1GDFTV	Bearing Center Height:8.5mm,For GUN12*,135	Center Bearing Support	533532
	2015.05-		Front	Pick up RWD 1GDFTV	Bearing Center Height:15.5mm,For GDN1**GUN1**XUN1**LAN125,TDN1**	Center Bearing Support	533533
	2015.05-		Front	Pick up 4WD 1GDFTV	Bearing Center Height:15.5mm,For GDN1**GUN1**XUN1**LAN125,TDN1**	Center Bearing Support	533533
3.0 (65 kw)	1997.11-2005.04		Centre	Pick up RWD 5L		Center Bearing Support	531656
3.0 (67 kw)	2001.08-2005.07		Centre	Pick up RWD 5L		Center Bearing Support	531656
3.0 (70 kw)	1997.11-2005.05		Centre	SUV RWD 5L		Center Bearing Support	531656
	1997.11-2005.05		Centre	SUV 4WD 5L		Center Bearing Support	531656
3.0 (71 kw)	1998.01-2005.04		Centre	Pick up RWD 5L		Center Bearing Support	531656
3.0 (120 kw)	2005.03-2015.05	5MT	Rear	Pick up 4WD 1KDFTV		Propshaft	PS900481
	2005.03-2015.05	AT	Rear	Pick up 4WD 1KDFTV		Propshaft	PS900482
	2005.03-2015.05		Front	Pick up 4WD 1KDFTV	Bearing Center Height:8.5mm,For GUN12*,135	Center Bearing Support	533532
	2005.03-2015.05		Front	Pick up 4WD 1KDFTV	Bearing Center Height:15.5mm,For GDN1**GUN1**XUN1**LAN125,TDN1**	Center Bearing Support	533533
	2005.03-2015.05		Centre	Pick up 4WD 1KDFTV	Bracket Fix Hole:30.5mm	Center Bearing Support	518878
	2005.03-2015.05		Centre	Pick up 4WD 1KDFTV	Bracket Fix Hole:30.5mm	Center Bearing Support	531656
3.0 (124 kw)	2005.08-2015.05	5MT	Rear	Pick up AWD 1KD-FTV		Propshaft	PS900481
	2005.08-2015.05	AT	Rear	Pick up AWD 1KD-FTV		Propshaft	PS900482
3.0 (126 kw)	2005.02-2015.05		Front	Chassis cabin 4WD 1KDFTV	Bearing Center Height:8.5mm,For GUN12*,135	Center Bearing Support	533532
	2005.02-2015.05		Front	Chassis cabin 4WD 1KDFTV	Bearing Center Height:15.5mm,For GDN1**GUN1**XUN1**LAN125,TDN1**	Center Bearing Support	533533
	2005.02-2015.05		Centre	Chassis cabin 4WD 1KDFTV	Date to:2016.09	Center Bearing Support	518878
	2005.02-2015.05		Centre	Chassis cabin 4WD 1KDFTV	Bracket Fix Hole:30.5mm	Center Bearing Support	531656
	2006.10-2015.05	MT	Front	Pick up 4WD 1KDFTV	for OE No.:37140-0K010	Propshaft	PS900472
	2006.10-2015.05	MT	Front	Pick up 4WD 1KDFTV	for OE No.:37140-0K030	Propshaft	PS900479
	2006.10-2015.05	5MT	Rear	Pick up 4WD 1KDFTV		Propshaft	PS900481
	2006.10-2015.05	AT	Rear	Pick up 4WD 1KDFTV		Propshaft	PS900482
	2006.10-2015.05		Front	Pick up 4WD 1KDFTV	Bearing Center Height:8.5mm,For GUN12*,135	Center Bearing Support	533532
	2006.10-2015.05		Front	Pick up RWD 1KDFTV	Bearing Center Height:8.5mm,For GUN12*,135	Center Bearing Support	533532
	2006.10-2015.05		Front	Pick up 4WD 1KDFTV	Bearing Center Height:15.5mm,For GDN1**GUN1**XUN1**LAN125,TDN1**	Center Bearing Support	533533
	2006.10-2015.05		Front	Pick up RWD 1KDFTV	Bearing Center Height:15.5mm,For GDN1**GUN1**XUN1**LAN125,TDN1**	Center Bearing Support	533533
	2006.10-2015.05		Centre	Pick up 4WD 1KDFTV	Bracket Fix Hole:30.5mm	Center Bearing Support	518878
	2006.10-2015.05		Centre	Pick up RWD 1KDFTV		Center Bearing Support	518878
	2006.10-2015.05		Centre	Pick up 4WD 1KDFTV	Bracket Fix Hole:30.5mm	Center Bearing Support	531656
3.0 (130 kw)	2013.06-2015.05	5MT	Rear	Pick up AWD 1KD-FTV		Propshaft	PS900481
3.0 (145 kw)	2008.05-2012.12	MT	Front	Pick up 4WD 1KDFTV	for OE No.:37140-0K010	Propshaft	PS900472
	2008.05-2012.12	MT	Front	Pick up 4WD 1KDFTV	for OE No.:37140-0K030	Propshaft	PS900479
	2008.05-2012.12	5MT	Rear	Pick up 4WD 1KDFTV		Propshaft	PS900481
	2008.05-2012.12		Front	Pick up 4WD 1KDFTV	Bearing Center Height:8.5mm,For GUN12*,135	Center Bearing Support	533532
	2008.05-2012.12		Front	Pick up 4WD 1KDFTV	Bearing Center Height:15.5mm,For GDN1**GUN1**XUN1**LAN125,TDN1**	Center Bearing Support	533533
	2008.05-2012.12		Centre	Pick up 4WD 1KDFTV	Bracket Fix Hole:30.5mm	Center Bearing Support	518878
	2008.05-2012.12		Centre	Pick up 4WD 1KDFTV	Bracket Fix Hole:30.5mm	Center Bearing Support	531656
3.4 (131 kw)	2001.08-2005.07		Centre	Pick up RWD 5VZFE		Center Bearing Support	531656
4.0 (175 kw)	2005.08-		Front	Pick up 4WD 1GRFE	Bearing Center Height:8.5mm,For GUN12*,135	Center Bearing Support	533532
	2005.08-		Front	Pick up 4WD 1GRFE	Bearing Center Height:15.5mm,For GDN1**GUN1**XUN1**LAN125,TDN1**	Center Bearing Support	533533
	2005.08-		Centre	Pick up 4WD 1GRFE	Date to:2016.09	Center Bearing Support	518878
	2005.08-		Centre	Pick up 4WD 1GRFE	Bracket Fix Hole:30.5mm	Center Bearing Support	531656
	2015.07-		Front	Pick up 4WD 1GRFE	Bearing Center Height:8.5mm,For GUN12*,135	Center Bearing Support	533532
	2015.07-		Front	Pick up 4WD 1GRFE	Bearing Center Height:15.5mm,For GDN1**GUN1**XUN1**LAN125,TDN1**	Center Bearing Support	533533
Hilux Surf							
2.4 (69 kw)	1989.08-1995.10		Centre	SUV 4WD 2LT		Center Bearing Support	512093
	1989.08-1995.10		Centre	SUV 4WD 2LT		Center Bearing Support	512369



 YEAR	TRANSM.	FITTING POSITION	BODY STYLE & DRIVE TYPE & ENGINE	REMARKS	 PRODUCT	GSP Ref.
TOYOTA						
Hilux Surf						
2.8 (61 kw)	1989.08-1995.10		Centre	SUV 4WD 3L	Center Bearing Support	513557
Innova						
2.0 (100 kw)	2004.08-		Centre	MPV RWD 1TRFE	Center Bearing Support	518878
2.7 (118 kw)	2004.04-		Centre	MPV RWD 2TRFE	Center Bearing Support	518878
Innova/Kijanginnova/Zace						
2.0 (98 kw)	2009.01-2016.03		Centre	MPV RWD 1TR-FE	Center Bearing Support	518878
Ipsum						
2.4 (118 kw)	2001.05-2010.12		Rear	MPV 4WD 2AZFE	Center Bearing Support	532824
Isis						
1.8 (98 kw)	2007.04-2014.08		Front	MPV 4WD 2ZRFAE	Center Bearing Support	513043
2.0 (114 kw)	2004.07-2014.08		Front	MPV 4WD 1AZFSE	Center Bearing Support	513043
IST						
1.5 (80 kw)	2002.05-2007.07		Front;Rear	Hatchback 4WD 1NZFE	Center Bearing Support	537001
Kluger						
3.0 (150 kw)	2003.10-2007.05	AT	Rear	SUV 4WD 1MZFE	Propshaft	PS900503
	2003.10-2007.05		Rear	SUV 4WD 1MZFE	Center Bearing Support	532824
3.3 (171 kw)	2003.10-2007.05	5AT	Rear	SUV 4WD 3MZFE	Propshaft	PS900503
	2003.10-2007.05		Rear	SUV 4WD 3MZFE	Center Bearing Support	532824
Land Cruiser						
4.0 (110 kw)	1984.11-1992.08	MT	Front	Closed Off-Road Vehicle AWD 3F	Propshaft	PS900488
4.0 (202 kw)	2010.01-	5MT	Rear	Terrain cab wagon closed 4WD 1GRFE	Propshaft	PS900487
4.0 (205 kw)	2010.01-	5MT	Rear	Terrain cab wagon closed 4WD 1GRFE	Propshaft	PS900487
4.0 (207 kw)	2010.01-	5MT	Rear	Terrain cab wagon closed 4WD 1GRFE	Propshaft	PS900487
4.2 (96 kw)	1990.01-1999.01	5MT	Front	Chassis cabin 4WD 1HZ	Propshaft	PS900490
	1990.01-1999.01	5MT	Rear	Chassis cabin 4WD 1HZ	Propshaft	PS900487
4.2 (123 kw)	1990.01-2001.08	5MT	Front	Terrain cab wagon closed 4WD 1HZ	Propshaft	PS900490
	1990.01-2001.08	5MT	Front	Terrain cab open 4WD 1HZ	Propshaft	PS900490
	1990.01-2001.08	5MT	Rear	Terrain cab wagon closed 4WD 1HZ	Propshaft	PS900487
	1990.01-2001.08	5MT	Rear	Terrain cab open 4WD 1HZ	Propshaft	PS900487
4.2 (150 kw)	2001.09-2006.06	5MT	Rear	Terrain cab wagon closed 4WD 1HDFTE	Propshaft	PS900487
4.5 (151 kw)	2007.01-	5MT	Rear	Platform/Chassis AWD 1VD-FTV	Propshaft	PS900487
4.5 (158 kw)	1992.08-1997.12	5MT	Rear	Terrain cab wagon closed 4WD 1FZFE	Propshaft	PS900487
	1992.11-1999.11	5MT	Rear	Terrain cab wagon closed 4WD 1FZFE	Propshaft	PS900487
4.5 (165 kw)	1990.11-2007.11	5MT	Rear	Platform/Chassis AWD 1FZ-FE	Propshaft	PS900487
Land Cruiser 100						
4.2 (150 kw)	1998.01-2008.07	5MT	Rear	Terrain cab wagon closed 4WD 1HDFTE	Propshaft	PS900487
4.5 (165 kw)	1998.03-2008.07	5MT	Rear	Terrain cab wagon closed 4WD 1FZFE	Propshaft	PS900487
4.5 (173 kw)	1998.01-2008.07	5MT	Rear	Terrain cab wagon closed 4WD 1FZFE	Propshaft	PS900487
Land Cruiser 200						
4.0 (176 kw)	2010.01-	5MT	Rear	Terrain cab wagon closed 4WD 1GRFE	Propshaft	PS900487
4.0 (199 kw)	2012.01-	5MT	Rear	Terrain cab wagon closed 4WD 1GRFE	Propshaft	PS900487
4.5 (171 kw)	2013.01-	5MT	Rear	Terrain cab wagon closed 4WD 1VDFTV	Propshaft	PS900487
4.5 (173 kw)	2007.06-	5MT	Rear	Terrain cab wagon closed 4WD 1VDFTV	Propshaft	PS900487
4.5 (183 kw)	2015.08-	5MT	Rear	Terrain cab wagon closed 4WD 1VDFTV	Propshaft	PS900487
4.5 (195 kw)	2007.09-	5MT	Rear	Terrain cab wagon closed 4WD 1VDFTV	Propshaft	PS900487
4.5 (200 kw)	2012.01-	5MT	Rear	Terrain cab wagon closed 4WD 1VDFTV	Propshaft	PS900487
4.5 (210 kw)	2007.08-	5MT	Rear	Terrain cab wagon closed 4WD 1VDFTV	Propshaft	PS900487
Land Cruiser 400						
4.2 (96 kw)	1996.04-2001.08	5MT	Front	Terrain cab wagon closed 4WD 1HZ	Propshaft	PS900490
	1996.04-2001.08	5MT	Rear	Terrain cab wagon closed 4WD 1HZ	Propshaft	PS900487
Land Cruiser 70						
4.0 (170 kw)	2007.03-	5MT	Rear	Terrain cab wagon closed 4WD 1GRFE	Propshaft	PS900487
	2007.03-	5MT	Rear	Chassis cabin 4WD 1GRFE	Propshaft	PS900487
4.2 (100 kw)	2007.03-	5MT	Front	Chassis cabin 4WD 1HZ	Propshaft	PS900490
	2007.03-	5MT	Rear	Chassis cabin 4WD 1HZ	Propshaft	PS900487
4.5 (151 kw)	2007.03-	5MT	Rear	Terrain cab wagon closed 4WD 1VDFTV	Propshaft	PS900487
4.5 (165 kw)	1996.01-1999.11	5MT	Rear	Terrain cab wagon closed 4WD 1FZFE	Propshaft	PS900487
Land Cruiser 80						
4.2 (99 kw)	1990.01-1997.12	5MT	Front	Terrain cab wagon closed 4WD 1HZ	Propshaft	PS900490
	1990.01-1997.12	5MT	Rear	Terrain cab wagon closed 4WD 1HZ	Propshaft	PS900487
4.2 (118 kw)	1992.10-1997.12	5MT	Front	Terrain cab wagon closed 4WD 1HDT	Propshaft	PS900490
4.2 (123 kw)	1990.01-1997.12	5MT	Front	Terrain cab wagon closed 4WD 1HDT	Propshaft	PS900490
4.5 (151 kw)	1992.08-1997.12	5MT	Rear	Terrain cab wagon closed 4WD 1FZFE	Propshaft	PS900487



	 YEAR	TRANSM.	FITTING POSITION	BODY STYLE & DRIVE TYPE & ENGINE	REMARKS	 PRODUCT	GSP Ref.
TOYOTA							
Land Cruiser 90							
4.2 (123 kw)	1999.08-2001.08	5MT	Front	Terrain cab wagon closed 4WD 1HZ		Propshaft	PS900490
	1999.08-2001.08	5MT	Rear	Terrain cab wagon closed 4WD 1HZ		Propshaft	PS900487
Land Cruiser Amazon							
4.2 (150 kw)	1998.01-2003.07	5MT	Rear	Terrain cab wagon closed 4WD 1HDFTE		Propshaft	PS900487
Land Cruiser Cygnus							
4.2 (151 kw)	1998.01-2007.08	5MT	Rear	Terrain cab wagon closed 4WD 1HDFTE		Propshaft	PS900487
Land Cruiser Prado							
4.0 (179 kw)	2002.09-2010.08	5MT	Rear	Terrain cab wagon closed 4WD 1GRFE		Propshaft	PS900487
4.0 (183 kw)	2002.12-2010.12	5MT	Rear	Terrain cab wagon closed 4WD 1GRFE		Propshaft	PS900487
	2012.11-	5MT	Rear	Terrain cab wagon closed 4WD 1GRFE		Propshaft	PS900487
4.0 (203 kw)	2005.08-2010.12	5MT	Rear	Terrain cab wagon closed 4WD 1GRFE		Propshaft	PS900487
	2010.01-	5MT	Rear	Terrain cab wagon closed 4WD 1GRFE		Propshaft	PS900487
4.0 (204 kw)	2013.08-	5MT	Rear	Terrain cab wagon closed 4WD 1GRFE		Propshaft	PS900487
4.0 (207 kw)	2003.01-2009.07	5MT	Rear	Terrain cab wagon closed 4WD 1GRFE		Propshaft	PS900487
	2010.01-	5MT	Rear	Terrain cab wagon closed 4WD 1GRFE		Propshaft	PS900487
Land Cruiser V8							
4.5 (160 kw)	2008.05-	5MT	Rear	Terrain cab wagon closed 4WD 1VDFTV		Propshaft	PS900487
4.5 (195 kw)	2007.11-	5MT	Rear	Terrain cab wagon closed 4WD 1VDFTV		Propshaft	PS900487
4.5 (200 kw)	2012.01-	5MT	Rear	Terrain cab wagon closed 4WD 1VDFTV		Propshaft	PS900487
4.5 (210 kw)	2008.05-	5MT	Rear	Terrain cab wagon closed 4WD 1VDFTV		Propshaft	PS900487
Land Cruiser V8 Van							
4.5 (200 kw)	2014.02-	5MT	Rear	Terrain cab wagon closed 4WD 1VDFTV		Propshaft	PS900487
Mark II							
3.0 (169 kw)	1992.10-1996.09		Centre	Saloon RWD 2JZGE		Center Bearing Support	513041
Matrix							
1.8 (91 kw)	2001.09-2004.02		Centre	Hatchback 4WD 1ZZFE		Center Bearing Support	514824
	2001.09-2004.02		Centre	Hatchback FWD 1ZZFE		Center Bearing Support	514824
	2001.09-2004.02		Centre	Hatchback 4WD 1ZZFE		Center Bearing Support Kit	514824S
1.8 (96 kw)	2002.02-2008.02		Centre	Hatchback FWD 1ZZFE		Center Bearing Support	514824
1.8 (97 kw)	2002.09-2008.12		Centre	Hatchback FWD 1ZZFE		Center Bearing Support	514824
Opa							
1.8 (92 kw)	2000.04-2003.08		Front	Estate 4WD 1ZZFE		Center Bearing Support	513043
	2000.04-2003.08		Rear	Estate 4WD 1ZZFE		Center Bearing Support Kit	519036S
1.8 (100 kw)	2000.04-2003.08		Front	Estate FWD 1ZZFE		Center Bearing Support	513043
Platz							
1.3 (63 kw)	2002.09-2005.08		Front;Rear	Saloon FWD 2NZFE		Center Bearing Support	537001
	2002.09-2005.08		Front;Rear	Saloon 4WD 2NZFE		Center Bearing Support	537001
Porte							
1.5 (77 kw)	2004.07-2012.07		Front;Rear	Hatchback 4WD 1NZFE		Center Bearing Support	537001
Prado							
4.2 (96 kw)	1998.01-2008.07	5MT	Front	Terrain cab wagon closed 4WD 1HZ		Propshaft	PS900490
	1998.01-2008.07	5MT	Rear	Terrain cab wagon closed 4WD 1HZ		Propshaft	PS900487
Premio							
1.8 (92 kw)	2001.12-2007.06		Front	Saloon 4WD 1ZZFE		Center Bearing Support	513043
	2008.01-		Front	Saloon 4WD 2ZRFAE		Center Bearing Support	513043
1.8 (96 kw)	2013.03-		Front	Saloon 4WD 2ZRFAE		Center Bearing Support	513043
1.8 (97 kw)	2001.12-2007.06		Front	Saloon 4WD 1ZZFE		Center Bearing Support	513043
1.8 (98 kw)	2007.07-2013.02		Front	Saloon 4WD 2ZRFAE		Center Bearing Support	513043
Previa							
2.4 (97 kw)	1990.05-2000.08		Centre	MPV 4WD 2TZFE		Center Bearing Support	514822
	1990.05-2000.08		Front;Rear	MPV 4WD 2TZFE		Flexible Coupling	511086
	1990.05-2000.08		Front;Rear	MPV RWD 2TZFE		Flexible Coupling	511086
	1990.05-2000.08		Front;Rear	MPV 4WD 2TZFE		Flexible Coupling Kit	511086S
	1990.05-2000.08		Front;Rear	MPV RWD 2TZFE		Flexible Coupling Kit	511086S
Previa (Nato)							
2.4 (118 kw)	1993.09-1997.07		Front;Rear	MPV RWD 2TZFE		Flexible Coupling	511086
	1993.09-1997.07		Front;Rear	MPV RWD 2TZFE		Flexible Coupling Kit	511086S
Probox							
1.5 (76 kw)	2014.09-		Front;Rear	Estate 4WD 1NZFE		Center Bearing Support	537001
1.5 (80 kw)	2002.07-2014.08		Front;Rear	Estate 4WD 1NZFE		Center Bearing Support	537001
Raum							
1.5 (66 kw)	1997.05-2003.03		Front;Rear	MPV FWD 5EFE		Center Bearing Support	537001
1.5 (67 kw)	1997.05-2003.04		Front;Rear	MPV 4WD 5EFE		Center Bearing Support	537001

	 YEAR	TRANSM.	FITTING POSITION	BODY STYLE & DRIVE TYPE & ENGINE	REMARKS	 PRODUCT	GSP Ref.
TOYOTA							
Raum							
1.5 (69 kw)	1997.08-2003.04		Front;Rear	MPV FWD 5EFE		Center Bearing Support	537001
1.5 (77 kw)	2003.05-2011.10		Front;Rear	MPV 4WD 1NZFE		Center Bearing Support	537001
1.5 (80 kw)	2003.05-2011.10		Front;Rear	MPV FWD 1NZFE		Center Bearing Support	537001
RAV 4							
2.0 (85 kw)	2001.09-2005.11	AT/MT	Rear	SUV 4WD 1CDFTV	Model Code:ACA20/ACA22/CLA20	Propshaft	PS900565
	2001.09-2005.11	MT	Rear	SUV 4WD 1CDFTV	Model Code:ACA21/ACA23/CLA21	Propshaft	PS900492
	2001.09-2005.11	MT	Rear	SUV 4WD 1CDFTV	Model Code:CLA21,Date From:2001.09	Propshaft	PS900589
	2001.09-2005.11		Centre	SUV 4WD 1CDFTV		Center Bearing Support	513001
2.0 (91 kw)	2013.11-2018.11	MT	Rear	SUV 4WD 1ADFTV		Propshaft	PS900493
	2013.11-2018.11		Centre	SUV 4WD 1ADFTV		Center Bearing Support Kit	519035S
2.0 (94 kw)	1997.12-2000.06		Centre	SUV 4WD 3SFE		Center Bearing Support	514085
2.0 (95 kw)	1994.04-2000.08		Centre	SUV FWD 3SFE		Center Bearing Support	514085
	1994.06-2000.08		Centre	SUV 4WD 3SFE		Center Bearing Support	514085
2.0 (109 kw)	2009.03-2013.06	CVT/6MT	Rear	SUV 4WD 3ZRFAE		Propshaft	PS900551
2.0 (110 kw)	2000.05-2005.11	AT/MT	Rear	SUV 4WD 1AZFE	Model Code:ACA21/ACA23/CLA21	Propshaft	PS900492
	2000.05-2005.11	AT/MT	Rear	SUV 4WD 1AZFE	Model Code:ACA20/ACA22/CLA20	Propshaft	PS900565
	2000.05-2005.11	AT/MT	Rear	SUV 4WD 1AZFE	Model Code:ACA21	Propshaft	PS900589
	2000.05-2005.11		Centre	SUV 4WD 1AZFE		Center Bearing Support	513001
2.0 (111 kw)	2012.12-	CVT/6MT	Rear	SUV 4WD 3ZRFAE		Propshaft	PS900551
	2012.12-	MT	Rear	SUV 4WD 3ZRFAE		Propshaft	PS900493
	2012.12-		Centre	SUV 4WD 3ZRFAE		Center Bearing Support Kit	519035S
	2012.12-2018.11	CVT/6MT	Rear	SUV Van 4WD 3ZRFAE		Propshaft	PS900551
2.0 (112 kw)	2006.02-2013.06	4AT/5MT	Rear	SUV 4WD 1AZFE		Propshaft	PS900551
	2006.02-2013.06		Centre	SUV 4WD 1AZFE		Center Bearing Support Kit	519035S
	2015.04-	CVT/6MT	Rear	SUV 4WD 3ZRFAE		Propshaft	PS900551
	2015.04-	MT	Rear	SUV 4WD 3ZRFAE		Propshaft	PS900493
	2015.04-		Centre	SUV 4WD 3ZRFAE		Center Bearing Support Kit	519035S
	2015.04-2018.11	CVT/6MT	Rear	SUV Van 4WD 3ZRFAE		Propshaft	PS900551
2.0 (116 kw)	2008.12-2013.06	CVT/6MT	Rear	SUV 4WD 3ZRFAE		Propshaft	PS900551
	2008.12-2013.06		Centre	SUV 4WD 3ZRFAE		Center Bearing Support Kit	519035S
2.2 (98 kw)	2005.11-2010.12	6AT/6MT	Rear	SUV 4WD 2ADFTV		Propshaft	PS900551
2.2 (100 kw)	2006.02-2012.12	6AT/6MT	Rear	SUV 4WD 2ADFTV		Propshaft	PS900551
			Centre	SUV 4WD 2ADFTV		Center Bearing Support Kit	519035S
2.2 (110 kw)	2008.12-2013.06	6AT/6MT	Rear	SUV 4WD 2ADFTV		Propshaft	PS900551
	2008.12-2013.06		Centre	SUV 4WD 2ADFTV		Center Bearing Support Kit	519035S
	2012.12-	6AT/6MT	Rear	SUV 4WD 2ADFTV		Propshaft	PS900551
	2012.12-	MT	Rear	SUV 4WD 2ADFTV		Propshaft	PS900493
	2012.12-2018.11	6AT/6MT	Rear	SUV Van 4WD 2ADFTV		Propshaft	PS900551
2.2 (130 kw)	2006.02-2013.06	6AT/6MT	Rear	SUV 4WD 2ADFHV		Propshaft	PS900551
	2006.02-2013.06		Centre	SUV 4WD 2ADFHV		Center Bearing Support Kit	519035S
	2012.12-	6AT/6MT	Rear	SUV 4WD 2ADFHV		Propshaft	PS900551
2.4 (112 kw)	2000.08-2005.11	AT/MT	Rear	SUV 4WD 2AZFE	Model Code:ACA20/ACA22/CLA20	Propshaft	PS900565
2.4 (120 kw)	2003.08-2005.11	AT/MT	Rear	SUV AWD 2AZ-FE		Propshaft	PS900565
2.4 (125 kw)	2005.11-2013.06	CVT/4AT	Rear	SUV 4WD 2AZFE		Propshaft	PS900551
2.5 (131 kw)	2013.01-2018.11		Rear	SUV 4WD 2ARFE		Propshaft	PS900493
2.5 (132 kw)	2012.12-		Rear	SUV 4WD 2ARFE		Propshaft	PS900493
RAV 4L							
2.0 (99 kw)	1994.01-2000.05		Centre	SUV 4WD 3SFE		Center Bearing Support	514085
2.0 (121 kw)	1994.01-1999.09		Centre	SUV 4WD 3SGE		Center Bearing Support	514085
Royal							
3.0 (147 kw)	1999.09-2003.08		Centre	Saloon RWD 2JZFSE		Center Bearing Support	517627
Rush							
1.5 (80 kw)	2006.03-		Centre	Terrain cab wagon closed RWD 3SZVE		Center Bearing Support	519034
Sienna							
3.3 (169 kw)	2003.06-2010.02		Rear	MPV 4WD 3MZFE		Center Bearing Support	532824
3.5 (196 kw)	2010.02-	6AT	Rear	MPV 4WD 2GRFE		Propshaft	PS900497
	2010.02-		Rear	MPV 4WD 2GRFE		Center Bearing Support	532824
3.5 (198 kw)	2007.01-2010.03		Rear	MPV 4WD 2GRFE		Center Bearing Support	532824
	2011.09-	6AT	Rear	MPV 4WD 2GRFE		Propshaft	PS900497
	2011.09-		Rear	MPV 4WD 2GRFE		Center Bearing Support	532824
3.5 (220 kw)	2016.08-	8AT	Rear	MPV 4WD 2GRFKS		Propshaft	PS900497
3.5 (221 kw)	2017.01-	8AT	Rear	MPV 4WD 2GRFKS		Propshaft	PS900497

	 YEAR	TRANSM.	FITTING POSITION	BODY STYLE & DRIVE TYPE & ENGINE	REMARKS	 PRODUCT	GSP Ref.
TOYOTA							
Soarer							
4.3 (208 kw)	2000.10-2005.10		Centre	Coupe RWD 3UZFE		Center Bearing Support	517627
Sprinter							
1.6 (81 kw)	1992.06-1997.04		Front;Rear	Saloon FWD 4AFE		Center Bearing Support	514823
1.6 (85 kw)	1991.09-1995.05		Front;Rear	Saloon 4WD 4AFE		Center Bearing Support	514823
1.6 (100 kw)	1995.04-2000.11		Front;Rear	Saloon FWD 4AFE		Center Bearing Support	514823
1.8 (50 kw)	1996.11-1997.04		Front;Rear	Saloon FWD		Center Bearing Support	514823
1.8 (81 kw)	1992.11-1997.04		Front;Rear	Saloon FWD 7A-FE		Center Bearing Support	514823
2.0 (54 kw)	1995.05-1998.04		Front;Rear	Saloon FWD 2C		Center Bearing Support	514823
2.2 (58 kw)	1995.04-2002.11		Front;Rear	Saloon FWD 3CE		Center Bearing Support	514823
	1998.04-2000.08		Front;Rear	Saloon 4WD 3CE		Center Bearing Support	514823
Sprinter Carib							
1.6 (81 kw)	1995.08-2001.10		Front;Rear	Estate FWD 4AFE		Center Bearing Support	514823
1.6 (85 kw)	1996.05-2002.05		Front;Rear	Station Wagon AWD 4A-FE		Center Bearing Support	514823
1.8 (50 kw)	1996.11-1997.04		Front;Rear	Station Wagon FWD		Center Bearing Support	514823
1.8 (81 kw)	1992.11-1997.04		Front;Rear	Estate FWD 7AFE		Center Bearing Support	514823
1.8 (85 kw)	1995.08-2001.10		Front;Rear	Estate FWD 7AFE		Center Bearing Support	514823
	1995.08-2001.10		Front;Rear	Estate 4WD 7AFE		Center Bearing Support	514823
Sprinter Cielo							
1.6 (81 kw)	1992.06-1997.04		Front;Rear	Hatchback FWD 4A-FE		Center Bearing Support	514823
1.6 (100 kw)	1995.04-2000.11		Front;Rear	Hatchback FWD 4A-FE		Center Bearing Support	514823
1.6 (136 kw)	1992.05-1997.07		Front;Rear	Hatchback FWD 4AFE		Center Bearing Support	514823
1.8 (81 kw)	1992.11-1997.04		Front;Rear	Hatchback FWD 7AFE		Center Bearing Support	514823
2.0 (54 kw)	1995.04-2000.11		Front;Rear	Hatchback FWD 2C		Center Bearing Support	514823
Starlet							
1.3 (60 kw)	1996.01-1999.07		Front;Rear	Hatchback 4WD 4EFE		Center Bearing Support	537001
Succeed							
1.5 (77 kw)	2002.07-2014.08		Front;Rear	Estate 4WD 1NZFE		Center Bearing Support	537001
Supra							
2.0 (145 kw)	2019.06-		Front	Coupe RWD B48L		Flexible Coupling	533422
2.0 (190 kw)	2019.06-		Front	Coupe RWD B48H		Flexible Coupling	533422
3.0 (250 kw)	2019.03-		Front;Rear	Coupe RWD B58		Flexible Coupling	517955
Tacoma							
2.4 (107 kw)	1994.08-2005.07		Centre	Pick up RWD 2RZFE		Center Bearing Support	531656
	2000.08-2005.07		Centre	Pick up 4WD 2RZFE		Center Bearing Support	531656
3.4 (136 kw)	1994.08-2000.07		Centre	Pick up 4WD 5VZFE		Center Bearing Support	531656
3.4 (140 kw)	1995.01-2005.07		Centre	Pick up RWD 5VZFE		Center Bearing Support	531656
	1995.01-2005.07		Centre	Pick up 4WD 5VZFE		Center Bearing Support	531656
4.0 (174 kw)	2004.09-2015.12	6MT	Rear	Pick up 4WD 1GRFE		Propshaft	PS900499
	2004.09-2015.12		Centre	Pick up 4WD 1GRFE		Center Bearing Support	531656
4.0 (175 kw)	2004.09-2015.07	6MT	Rear	Pick up 4WD 1GRFE		Propshaft	PS900499
Tercel							
1.5 (67 kw)	1994.09-1999.07		Front;Rear	Hatchback 4WD 5EFE		Center Bearing Support	537001
	1994.09-1999.07		Front;Rear	Saloon FWD 5E-FE		Center Bearing Support	537001
1.5 (74 kw)	1990.09-1994.09		Front;Rear	Hatchback 4WD 5EFE		Center Bearing Support	537001
	1990.09-1994.09		Front;Rear	Saloon 4WD 5EFE		Center Bearing Support	537001
Tundra							
3.4 (140 kw)	1999.04-2006.10		Centre	Pick up 4WD 5VZFE		Center Bearing Support	531656
	1999.04-2006.10		Centre	Pick up RWD 5VZFE		Center Bearing Support	531656
4.7 (183 kw)	1999.02-2006.10		Centre	Pick up 4WD 2UZFE		Center Bearing Support	531656
4.7 (207 kw)	1999.02-2006.10		Centre	Pick up RWD 2UZFE		Center Bearing Support	531656
Verossa							
2.0 (118 kw)	2000.10-2003.11		Centre	Saloon RWD 1GFE		Center Bearing Support	513040
Vitz							
1.3 (65 kw)	1999.09-2005.01		Front;Rear	Hatchback 4WD 2NZFE		Center Bearing Support	537001
Voxy							
2.0 (112 kw)	2001.11-2007.06		Rear	MPV 4WD 1AZFSE		Center Bearing Support	532824
Will Cypha							
1.5 (78 kw)	2001.05-2005.10		Front;Rear	Hatchback 4WD 1NZFE		Center Bearing Support	537001
Will VS							
1.5 (81 kw)	2001.03-2004.11		Centre	Hatchback 4WD 1NZFE		Center Bearing Support Kit	514824S
1.8 (100 kw)	2001.03-2004.11		Centre	Hatchback FWD 1ZZFE		Center Bearing Support	514824
	2001.03-2004.11		Centre	Hatchback 4WD 1ZZFE		Center Bearing Support	514824

	 YEAR	TRANSM.	FITTING POSITION	BODY STYLE & DRIVE TYPE & ENGINE	REMARKS	 PRODUCT	GSP Ref.
TOYOTA							
Wish							
1.8 (92 kw)	2003.04-2009.03		Front	MPV 4WD 1ZZFE		Center Bearing Support	513043
1.8 (96 kw)	2012.04-		Front	MPV 4WD 2ZRFAE		Center Bearing Support	513043
1.8 (97 kw)	2003.04-2009.03		Front	MPV FWD 1ZZFE		Center Bearing Support	513043
1.8 (98 kw)	2009.04-2012.03		Front	MPV 4WD 2ZRFAE		Center Bearing Support	513043
TOYOTA (FAW)							
Corolla							
1.8 (93 kw)	2004.02-2007.04		Centre	Saloon FWD 1ZZFE		Center Bearing Support	514824
1.8 (100 kw)	2004.02-2007.01		Centre	Saloon FWD 1ZZFE		Center Bearing Support	514824
Land Cruiser							
4.5 (155 kw)	2003.10-2007.04	5MT	Rear	Terrain cab wagon closed 4WD 1FZFE		Propshaft	PS900487
Land Cruiser 200							
4.0 (179 kw)	2007.12-2012.02	5MT	Rear	Terrain cab wagon closed 4WD 1GRFE		Propshaft	PS900487
4.0 (202 kw)	2012.01-2017.12	5MT	Rear	Terrain cab wagon closed 4WD 1GRFE		Propshaft	PS900487
Land Cruiser Prado							
4.0 (202 kw)	2010.01-	5MT	Rear	Terrain cab wagon closed 4WD 1GRFE		Propshaft	PS900487
VAUXHALL							
Omega							
2.0 (74 kw)	1998.01-2001.12		Centre	Estate RWD X20DTH		Center Bearing Support	512464
	1998.01-2001.12		Centre	Saloon RWD X20DTH		Center Bearing Support	512464
2.0 (85 kw)	1994.03-1999.09		Centre	Estate RWD X20SE		Center Bearing Support	512464
	1994.04-1999.09		Centre	Saloon RWD 20SE/X20SE		Center Bearing Support	512464
2.0 (100 kw)	1994.03-2001.02		Centre	Estate RWD X20XEV		Center Bearing Support	512464
	1994.06-1999.05		Centre	Saloon RWD X20XEV		Center Bearing Support	512464
	1998.05-2001.07		Centre	Saloon RWD X20XEV		Center Bearing Support	512464
2.2 (88 kw)	2000.08-2003.08		Centre	Estate RWD Y22DTH		Center Bearing Support	512464
	2000.08-2003.08		Centre	Saloon RWD Y22DTH		Center Bearing Support	512464
2.2 (106 kw)	1999.06-2003.12		Centre	Estate RWD Y22XE/Z22XE		Center Bearing Support	512464
	1999.06-2003.12		Centre	Saloon RWD Y22XE/Z22XE		Center Bearing Support	512464
2.5 (96 kw)	1994.06-2000.07		Centre	Estate RWD U25DT/U25TDI/X25DTI/X25TD		Center Bearing Support	512464
	1994.06-2000.07		Centre	Saloon RWD U25DT/U25TDI/X25DTI/X25TD		Center Bearing Support	512464
2.5 (125 kw)	1994.06-2000.07		Centre	Estate RWD X25XE		Center Bearing Support	512464
	1994.06-2000.07		Centre	Saloon RWD X25XE		Center Bearing Support	512464
2.6 (132 kw)	2000.08-2003.08		Centre	Estate RWD Y26SE		Center Bearing Support	512464
	2000.08-2003.08		Centre	Saloon RWD Y26SE		Center Bearing Support	512464
3.0 (155 kw)	1994.06-2000.07		Centre	Estate RWD X30XE		Center Bearing Support	512464
	1994.06-2000.07		Centre	Saloon RWD X30XE		Center Bearing Support	512464
3.2 (160 kw)	2001.02-2003.08		Centre	Estate RWD Y32SE		Center Bearing Support	512464
	2001.02-2003.08		Centre	Saloon RWD Y32SE		Center Bearing Support	512464
VOLVO							
240							
2.0 (82 kw)	1985.09-1993.12		Front	Saloon RWD B200F		Flexible Coupling	510596
2.0 (89 kw)	1984.09-1993.12		Front	Saloon RWD B200E		Flexible Coupling	510596
2.3 (83 kw)	1986.08-1993.07		Front	Saloon RWD B230F		Flexible Coupling	510596
2.3 (85 kw)	1984.09-1993.07		Front	Saloon RWD B230F/B230K		Flexible Coupling	510596
2.4 (58 kw)	1987.08-1993.08		Front	Saloon RWD D24		Flexible Coupling	510596
240 Estate/Combi							
2.0 (82 kw)	1989.09-1993.12		Front	Estate RWD B200F		Flexible Coupling	510596
2.0 (86 kw)	1983.08-1993.07		Front	Estate RWD B200E		Flexible Coupling	510596
2.3 (83 kw)	1986.08-1993.12		Front	Estate RWD B230F		Flexible Coupling	510596
2.3 (85 kw)	1984.09-1993.07		Front	Estate RWD B230F/B230K		Flexible Coupling	510596
2.3 (100 kw)	1988.09-1993.12		Front	Estate RWD B230EF		Flexible Coupling	510596
2.4 (58 kw)	1988.08-1993.08		Front	Estate RWD D24		Flexible Coupling	510596
740							
2.0 (82 kw)	1990.09-1992.08		Centre	Saloon RWD B200F		Center Bearing Support	530187
	1990.09-1992.08		Front	Saloon RWD B200F		Flexible Coupling	510596
2.0 (89 kw)	1985.08-1992.07		Centre	Saloon RWD B200G		Center Bearing Support	530187
	1985.08-1992.07		Front	Saloon RWD B200G		Flexible Coupling	510596
2.3 (85 kw)	1984.09-1992.07		Centre	Saloon RWD B230F		Center Bearing Support	530187
	1984.09-1992.07		Front	Saloon RWD B230F		Flexible Coupling	510596
2.3 (96 kw)	1984.08-1992.12		Centre	Saloon RWD B230E/B230FB		Center Bearing Support	530187
	1984.08-1992.12		Front	Saloon RWD B230E/B230FB		Flexible Coupling	510596
2.3 (111 kw)	1988.08-1992.08		Centre	Saloon RWD B234F		Center Bearing Support	530187
	1988.08-1992.08		Front	Saloon RWD B234F		Flexible Coupling	510596



	 YEAR	TRANSM.	FITTING POSITION	BODY STYLE & DRIVE TYPE & ENGINE	REMARKS	 PRODUCT	GSP Ref.
VOLVO							
740							
2.4 (60 kw)	1984.08-1992.07		Centre	Saloon RWD D24		Center Bearing Support	530187
	1984.08-1992.07		Front	Saloon RWD D24		Flexible Coupling	510596
740 Estate/Combi							
2.0 (89 kw)	1985.08-1992.08		Centre	Estate RWD B200G		Center Bearing Support	530187
	1985.08-1992.08		Front	Estate RWD B200G		Flexible Coupling	510596
2.3 (85 kw)	1984.09-1992.07		Centre	Estate RWD B230F		Center Bearing Support	530187
	1984.09-1992.07		Front	Estate RWD B230F		Flexible Coupling	510596
2.3 (96 kw)	1985.08-1992.12		Centre	Estate RWD B230E/B230FB		Center Bearing Support	530187
	1985.08-1992.12		Front	Estate RWD B230E/B230FB		Flexible Coupling	510596
2.3 (111 kw)	1989.09-1992.08		Centre	Estate RWD B234F		Center Bearing Support	530187
	1989.09-1992.08		Front	Estate RWD B234F		Flexible Coupling	510596
760							
2.4 (80 kw)	1982.06-1992.07		Centre	Saloon RWD D24T		Center Bearing Support	530187
	1982.06-1992.07		Front	Saloon RWD D24T		Flexible Coupling	510596
940							
2.0 (82 kw)	1990.09-1994.07		Centre	Saloon RWD B200F		Center Bearing Support	530187
	1990.09-1994.07		Front	Saloon RWD B200F		Flexible Coupling	510596
2.0 (114 kw)	1990.09-1998.10		Centre	Saloon RWD B200FT		Center Bearing Support	530187
	1990.09-1998.10		Front	Saloon RWD B200FT		Flexible Coupling	510596
2.3 (85 kw)	1990.09-1995.07		Centre	Saloon RWD B230F/B230FD		Center Bearing Support	530187
	1990.09-1995.07		Front	Saloon RWD B230F/B230FD		Flexible Coupling	510596
2.3 (96 kw)	1990.09-1997.05		Centre	Saloon RWD B230E/B230FB		Center Bearing Support	530187
	1990.09-1997.05		Front	Saloon RWD B230E/B230FB		Flexible Coupling	510596
2.3 (99 kw)	1995.01-1998.10		Centre	Saloon RWD B230FK		Center Bearing Support	530187
	1995.01-1998.10		Front	Saloon RWD B230FK		Flexible Coupling	510596
2.3 (114 kw)	1990.09-1992.08		Centre	Saloon RWD B234F/B234G		Center Bearing Support	530187
	1990.09-1992.08		Front	Saloon RWD B234F/B234G		Flexible Coupling	510596
2.3 (121 kw)	1990.08-1998.10		Centre	Saloon RWD B230FT/B230GT		Center Bearing Support	530187
	1990.08-1998.10		Front	Saloon RWD B230FT/B230GT		Flexible Coupling	510596
2.4 (60 kw)	1990.09-1994.12		Centre	Saloon RWD D24		Center Bearing Support	530187
	1990.09-1994.12		Front	Saloon RWD D24		Flexible Coupling	510596
2.4 (80 kw)	1990.09-1994.12		Centre	Saloon RWD D24T		Center Bearing Support	530187
	1990.09-1994.12		Front	Saloon RWD D24T		Flexible Coupling	510596
2.4 (90 kw)	1990.08-1998.10		Centre	Saloon RWD D24TIC		Center Bearing Support	530187
	1990.08-1998.10		Front	Saloon RWD D24TIC		Flexible Coupling	510596
940 Estate/Combi							
2.0 (82 kw)	1990.09-1993.09		Centre	Estate RWD B200F		Center Bearing Support	530187
	1990.09-1993.09		Front	Estate RWD B200F		Flexible Coupling	510596
2.0 (114 kw)	1991.01-1998.10		Centre	Estate RWD B200FT		Center Bearing Support	530187
	1991.01-1998.10		Front	Estate RWD B200FT		Flexible Coupling	510596
2.3 (85 kw)	1992.08-1995.07		Centre	Estate RWD B230F/B230FD		Center Bearing Support	530187
	1992.08-1995.07		Front	Estate RWD B230F/B230FD		Flexible Coupling	510596
2.3 (96 kw)	1990.09-1998.10		Centre	Estate RWD B230E/B230FB/B230G		Center Bearing Support	530187
	1990.09-1998.10		Front	Estate RWD B230E/B230FB/B230G		Flexible Coupling	510596
2.3 (99 kw)	1995.01-1998.10		Centre	Estate RWD B230FK		Center Bearing Support	530187
	1995.01-1998.10		Front	Estate RWD B230FK		Flexible Coupling	510596
2.3 (114 kw)	1990.08-1992.08		Centre	Estate RWD B234F/B234G		Center Bearing Support	530187
	1990.08-1992.08		Front	Estate RWD B234F/B234G		Flexible Coupling	510596
2.3 (121 kw)	1990.09-1998.10		Centre	Estate RWD B230FT/B230GT		Center Bearing Support	530187
	1990.09-1998.10		Front	Estate RWD B230FT/B230GT		Flexible Coupling	510596
2.4 (60 kw)	1990.08-1995.07		Centre	Estate RWD D24		Center Bearing Support	530187
	1990.08-1995.07		Front	Estate RWD D24		Flexible Coupling	510596
2.4 (80 kw)	1990.09-1994.07		Centre	Estate RWD D24T		Center Bearing Support	530187
	1990.09-1994.07		Front	Estate RWD D24T		Flexible Coupling	510596
2.4 (90 kw)	1990.09-1998.10		Centre	Estate RWD D24TIC		Center Bearing Support	530187
	1990.09-1998.10		Front	Estate RWD D24TIC		Flexible Coupling	510596
960							
2.0 (82 kw)	1990.09-1993.09		Centre	Saloon RWD B200F		Center Bearing Support	530187
	1990.09-1993.09		Front	Saloon RWD B200F		Flexible Coupling	510596
2.0 (103 kw)	1990.09-1993.08		Centre	Saloon RWD B204E		Center Bearing Support	530187
	1990.09-1993.08		Front	Saloon RWD B204E		Flexible Coupling	510596
2.0 (140 kw)	1990.09-1993.08		Centre	Saloon RWD B204FT		Center Bearing Support	530187
	1990.09-1993.08		Front	Saloon RWD B204FT		Flexible Coupling	510596



	 YEAR	TRANSM.	FITTING POSITION	BODY STYLE & DRIVE TYPE & ENGINE	REMARKS	 PRODUCT	GSP Ref.
VOLVO							
960							
2.3 (121 kw)	1990.09-1993.08		Centre	Saloon RWD B230FT		Center Bearing Support	530187
	1990.09-1993.08		Front	Saloon RWD B230FT		Flexible Coupling	510596
2.4 (85 kw)	1990.09-1993.08		Centre	Saloon RWD D24TIC		Center Bearing Support	530187
	1990.09-1993.08		Front	Saloon RWD D24TIC		Flexible Coupling	510596
2.5 (125 kw)	1993.09-1996.10		Centre	Saloon RWD B6254S		Center Bearing Support	530187
2.8 (108 kw)	1990.09-1992.05		Centre	Saloon RWD B280F		Center Bearing Support	530187
	1990.09-1992.05		Front	Saloon RWD B280F		Flexible Coupling	510596
2.9 (150 kw)	1990.09-1996.12		Centre	Saloon RWD B6304FS/B6304GS		Center Bearing Support	530187
960 Estate/Combi							
2.0 (103 kw)	1990.09-1993.08		Centre	Estate RWD B204E		Center Bearing Support	530187
	1990.09-1993.08		Front	Estate RWD B204E		Flexible Coupling	510596
2.0 (140 kw)	1990.09-1993.08		Centre	Estate RWD B204FT		Center Bearing Support	530187
	1990.09-1993.08		Front	Estate RWD B204FT		Flexible Coupling	510596
2.3 (121 kw)	1990.09-1993.08		Centre	Estate RWD B230FT		Center Bearing Support	530187
	1990.09-1993.08		Front	Estate RWD B230FT		Flexible Coupling	510596
2.4 (85 kw)	1991.09-1994.07		Centre	Estate RWD D24TIC		Center Bearing Support	530187
	1991.09-1994.07		Front	Estate RWD D24TIC		Flexible Coupling	510596
2.4 (90 kw)	1990.09-1993.08		Centre	Estate RWD D24TIC		Center Bearing Support	530187
	1990.09-1993.08		Front	Estate RWD D24TIC		Flexible Coupling	510596
2.5 (125 kw)	1993.09-1996.10		Centre	Estate RWD B6254S		Center Bearing Support	530187
2.9 (150 kw)	1990.08-1996.12		Centre	Estate RWD B6304FS/B6304GS		Center Bearing Support	530187
S60							
2.4 (147 kw)	2001.01-2010.04		Rear	Saloon 4WD B5244T3		Propshaft	PS900515
2.4 (151 kw)	2010.04-2011.05	AT/MT	Rear	Saloon 4WD D5244T10		Propshaft	PS900513
2.4 (158 kw)	2011.06-2016.12	AT	Rear	Saloon 4WD D5244T15	Date To:2013.01,For Engine Code:D 5244 T15	Propshaft	PS900513
	2011.06-2016.12	AT	Rear	Saloon 4WD D5244T15	Date From:2013.01,Trans. code:TF-80SC	Propshaft	PS900516
2.4 (169 kw)	2014.04-2015.12		Rear	Saloon 4WD D5244T15	Trans. code:TF-80SC	Propshaft	PS900516
2.5 (154 kw)	2002.06-2010.03		Rear	Saloon 4WD B5254T2		Propshaft	PS900515
3.0 (224 kw)	2010.04-2016.12	AT	Rear	Saloon 4WD B6304T4	Date To:2013.01	Propshaft	PS900513
	2010.04-2016.12	AT	Rear	Saloon 4WD B6304T4	Date From:2013.01,Trans. code:TF-80SC	Propshaft	PS900516
3.0 (242 kw)	2010.09-2015.12		Rear	Saloon 4WD B6304T4	Trans. code:TF-80SC	Propshaft	PS900516
3.0 (258 kw)	2014.05-2018.12		Rear	Saloon 4WD B6304T5	Trans. code:TF-80SC	Propshaft	PS900516
S70							
2.4 (103 kw)	1999.04-2000.11		Front	Saloon FWD B5244S2		Joint,propshaft	699195
S80							
2.4 (136 kw)	2008.03-2009.05	AT/MT	Rear	Saloon 4WD D5244T4	Date From:2008.01,Chassis no. from:87001	Propshaft	PS900511
	2008.03-2009.05	AT/MT	Rear	Saloon 4WD D5244T4	Date From:2008.01,Chassis no. to:87000	Propshaft	PS900512
2.4 (151 kw)	2010.01-2011.12	AT/MT	Rear	Saloon 4WD D5244T10	Chassis no. from:87001	Propshaft	PS900511
	2010.01-2011.12	AT/MT	Rear	Saloon 4WD D5244T10	Chassis no. to:87000	Propshaft	PS900512
3.0 (210 kw)	2007.01-2010.12	AT	Rear	Saloon 4WD B6304T2	Chassis no. from:87001	Propshaft	PS900511
	2007.01-2010.12	AT	Rear	Saloon 4WD B6304T2	Chassis no. to:87000	Propshaft	PS900512
3.0 (224 kw)	2011.01-	AT	Rear	Saloon 4WD B6304T4	Chassis no. from:87001	Propshaft	PS900511
	2011.01-	AT	Rear	Saloon 4WD B6304T4	Chassis no. to:87000	Propshaft	PS900512
3.2 (175 kw)	2006.10-2010.03	AT	Rear	Saloon 4WD B6324S	Chassis no. from:87001	Propshaft	PS900511
	2006.10-2010.03	AT	Rear	Saloon 4WD B6324S	Chassis no. to:87000	Propshaft	PS900512
3.2 (179 kw)	2010.09-	AT	Rear	Saloon 4WD B6324S5	Chassis no. from:87001	Propshaft	PS900511
	2010.09-	AT	Rear	Saloon 4WD B6324S5	Chassis no. to:87000	Propshaft	PS900512
4.4 (232 kw)	2006.08-2012.03	AT	Rear	Saloon 4WD B8444S	Chassis no. from:87001	Propshaft	PS900511
	2006.08-2012.03	AT	Rear	Saloon 4WD B8444S	Chassis no. to:87000	Propshaft	PS900512
	2006.08-2012.03		Front	Saloon 4WD B8444S		Joint,propshaft	699195
S90							
2.5 (125 kw)	1996.11-1998.10		Centre	Saloon RWD B6254FS		Center Bearing Support	530187
2.9 (132 kw)	1996.11-1998.10		Centre	Saloon RWD B6304FS2		Center Bearing Support	530187
2.9 (150 kw)	1997.01-1998.12		Centre	Saloon RWD B6304FS/B6304FS2		Center Bearing Support	530187
V60							
2.4 (120 kw)	2012.09-2015.12		Rear	Estate 4WD D5244T17	Date From:2012.09 to 2015.12,Trans. code:TF-80SC	Propshaft	PS900516
2.4 (133 kw)	2013.09-2015.12		Rear	Combi van 4WD D5244T12	Trans. code:TF-80SC	Propshaft	PS900516
	2013.10-2015.12		Rear	Estate 4WD D5244T12	Trans. code:TF-80SC	Propshaft	PS900516
2.4 (151 kw)	2010.11-2011.05	AT/MT	Rear	Estate 4WD D5244T10	Chassis no. to:90000	Propshaft	PS900513
2.4 (158 kw)	2011.06-2015.12	AT	Rear	Estate 4WD D5244T15	Chassis no. to:90000,For Engine Code:D 5244 T15	Propshaft	PS900513
	2011.06-2015.12	AT	Rear	Estate 4WD D5244T15	Chassis no. from:90001,Transm.Type:TF-80SC	Propshaft	PS900516
2.4 (169 kw)	2014.04-2015.12		Rear	Estate 4WD D5244T15	Trans. code:TF-80SC	Propshaft	PS900516
3.0 (224 kw)	2010.11-2015.12	AT	Rear	Estate 4WD B6304T4	Chassis no. to:90000	Propshaft	PS900513
	2010.11-2015.12	AT	Rear	Estate 4WD B6304T4	Date From:2010.11,Chassis no from:90001,Trans. code:TF-80SC	Propshaft	PS900516



	 YEAR	TRANSM.	FITTING POSITION	BODY STYLE & DRIVE TYPE & ENGINE	REMARKS	 PRODUCT	GSP Ref.
VOLVO							
V60							
3.0 (242 kw)	2014.04-2015.12		Rear	Estate 4WD B6304T4	Trans. code:TF-80SC	Propshaft	PS900516
3.0 (258 kw)	2014.05-2018.05		Rear	Estate 4WD B6304T5		Propshaft	PS900516
V70							
2.0 (166 kw)	1996.11-2000.02	5MT	Rear	Estate 4WD B5204T3		Propshaft	PS900515
2.3 (176 kw)	1997.01-1999.03		Rear	Estate 4WD B5234T3		Propshaft	PS900515
2.3 (184 kw)	1997.04-2000.03		Rear	Estate 4WD B5234T4/B5234T6		Propshaft	PS900515
2.3 (195 kw)	2000.10-2004.09		Front	Estate 4WD B5234T7		Joint,propshaft	699195
2.4 (103 kw)	2000.03-2007.08		Front	Estate FWD B5244S2		Joint,propshaft	699195
2.4 (121 kw)	2000.03-2003.09		Front	Estate FWD B5254SDENS		Joint,propshaft	699195
2.4 (136 kw)	2005.05-2007.08	AT/MT	Rear	Estate 4WD D5244T4		Propshaft	PS900509
2.4 (147 kw)	2000.07-2002.08	AT/MT	Rear	Estate 4WD B5244T3	Chassis no. to:285999	Propshaft	PS900510
2.5 (154 kw)	2002.08-2007.08	AT/MT	Rear	Estate 4WD B5254T2	Chassis no. from:286000	Propshaft	PS900506
	2002.08-2007.08	AT/MT	Rear	Estate 4WD B5254T2	Chassis no. to:285999	Propshaft	PS900510
V70 XC							
2.4 (147 kw)	2000.03-2002.09	AT/MT	Rear	Estate 4WD B5244T3	Chassis no. to:94999	Propshaft	PS900510
V90							
2.5 (125 kw)	1996.11-1998.10		Centre	Estate RWD B6254FS/B6254GS		Center Bearing Support	530187
2.9 (132 kw)	1996.11-1999.04		Centre	Estate RWD B6304FS2		Center Bearing Support	530187
2.9 (150 kw)	1997.01-1998.12		Centre	Estate RWD B6304FS/B6304GS		Center Bearing Support	530187
XC60							
2.4 (120 kw)	2009.05-2017.02	AT/MT	Rear	SUV 4WD D5244T16/D5244T17	Chassis no. to:364999,For Engine Code:D 5244 T17	Propshaft	PS900513
	2009.05-2017.02	AT/MT	Rear	SUV 4WD D5244T16/D5244T17	Date From:2009.05,Chassis no. from:365000,For Engine Code:D5244T17,Trans. code:M66,TF-80SC	Propshaft	PS900516
2.4 (133 kw)	2013.10-2017.02	AT/MT	Rear	SUV 4WD D5244T12	Trans. code:M66,TF-80SC	Propshaft	PS900516
2.4 (136 kw)	2008.06-2009.12	AT/MT	Rear	SUV 4WD D5244T4	Chassis no. to:364999	Propshaft	PS900513
2.4 (151 kw)	2009.05-2017.02	AT/MT	Rear	SUV 4WD D5244T10	Chassis no. to:364999	Propshaft	PS900513
2.4 (158 kw)	2011.06-2017.02	AT/MT	Rear	SUV 4WD D5244T11/D5244T15	Chassis no. to:364999	Propshaft	PS900513
	2011.06-2017.02	AT/MT	Rear	SUV 4WD D5244T11/D5244T15	Chassis no. from:365000,For Engine Code:D 5244 T11,Trans. code:M66	Propshaft	PS900516
2.4 (169 kw)	2014.04-2017.02	AT/MT	Rear	SUV 4WD D5244T11/D5244T15	For Engine Code:D5244T11,Trans. code:M66	Propshaft	PS900516
3.0 (210 kw)	2008.07-2010.03	AT	Rear	SUV 4WD B6304T2	Chassis no. to:364999	Propshaft	PS900513
3.0 (224 kw)	2009.03-2017.02	AT	Rear	SUV 4WD B6304T4	Chassis no. to:364999	Propshaft	PS900513
	2009.03-2017.02	AT	Rear	SUV 4WD B6304T4	Chassis no. from:365000,Trans. code:TF-80SC	Propshaft	PS900516
3.0 (242 kw)	2014.04-2015.12		Rear	SUV 4WD B6304T4	Trans. code:TF-80SC	Propshaft	PS900516
3.2 (179 kw)	2010.04-2017.02	AT	Rear	SUV 4WD B6324S5	Chassis no. from:365000,Trans. code:TF-80SC	Propshaft	PS900516
XC70							
2.4 (120 kw)	2002.09-2007.08	AT/MT	Rear	Estate 4WD D5244T	Chassis no. to:94999	Propshaft	PS900510
2.4 (136 kw)	2005.05-2008.04	AT/MT	Rear	Estate 4WD D5244T4		Propshaft	PS900509
2.5 (154 kw)	2002.06-2007.10	AT/MT	Rear	Estate 4WD B5254T2	Chassis no. from:95000	Propshaft	PS900506
	2002.06-2007.10	AT/MT	Rear	Estate 4WD B5254T2	Chassis no. to:94999	Propshaft	PS900510
XC90							
2.0 (140 kw)	2015.10-2018.12	AT	Rear	SUV 4WD D4204T6	Chassis no. to:174564,Date From:2016.01	Propshaft	PS900517
2.0 (165 kw)	2014.09-2016.12	AT	Rear	SUV 4WD D4204T11	Date From:2015.01	Propshaft	PS900517
2.0 (173 kw)	2016.03-2019.12	AT	Rear	SUV 4WD D4204T23	Chassis no. to:174564	Propshaft	PS900517
2.0 (183 kw)	2016.02-2018.12	AT	Rear	SUV 4WD B4204T20	Chassis no. to:174564	Propshaft	PS900517
2.0 (187 kw)	2015.06-2018.12	AT	Rear	SUV 4WD B4204T23	Chassis no. to:174564,Date From:2016.01	Propshaft	PS900517
2.0 (235 kw)	2014.09-2018.12	AT	Rear	SUV 4WD B4204T27	Chassis no. to:174564,	Propshaft	PS900517
2.4 (120 kw)	2002.06-2014.12	AT/MT	Rear	SUV 4WD D5244T/D5244T5	Date From:2009.01,Chassis no. from:593216	Propshaft	PS900505
	2002.06-2014.12	AT/MT	Rear	SUV 4WD D5244T/D5244T5	Date To:2009.01	Propshaft	PS900507
	2002.06-2014.12	AT/MT	Front	SUV 4WD D5244T/D5244T5		Joint,propshaft	602148
2.4 (136 kw)	2005.05-2014.12	AT/MT	Rear	SUV 4WD D5244T4	Date From:2009.01,Chassis no. from:593216	Propshaft	PS900505
	2005.05-2014.12	AT/MT	Rear	SUV 4WD D5244T4	Date From:2006.01 to 2009.12,Date To:2009.01	Propshaft	PS900507
2.4 (147 kw)	2010.11-2014.12	AT	Rear	SUV 4WD D5244T18	Date To:2013.12,Chassis no. from:593216	Propshaft	PS900505
2.4 (155 kw)	2013.11-2014.09	AT	Rear	SUV 4WD D5244T18	Chassis no. from:593216	Propshaft	PS900505
2.5 (154 kw)	2002.06-2014.12	AT	Rear	SUV 4WD B5254T2	Date To:2007.12,Chassis no. from 524231,until 650000	Propshaft	PS900515
	2002.06-2014.12	AT/MT	Front	SUV 4WD B5254T2	Date To:2007.12	Joint,propshaft	602148
	2012.10-2014.12		Rear	SUV 4WD B5254T9		Propshaft	PS900515
2.9 (200 kw)	2002.06-2005.08		Rear	SUV 4WD B6294T		Propshaft	PS900515
	2002.06-2005.08	AT	Rear	SUV 4WD B6294T		Propshaft	PS900514
3.2 (175 kw)	2006.04-2014.12	AT	Rear	SUV 4WD B6324S	Date From:2009.01,Chassis no. from:593216	Propshaft	PS900505
	2006.04-2014.12	AT	Rear	SUV 4WD B6324S	Date To:2009.01,Date To:2009.12	Propshaft	PS900507
	2011.09-2014.12		Front	SUV FWD B6324S5		Joint,propshaft	699195
3.2 (179 kw)	2011.04-2014.12	AT	Rear	SUV 4WD B6324S5	Chassis no. from:593216	Propshaft	PS900505
4.4 (232 kw)	2004.09-2011.12	AT	Rear	SUV 4WD B8444S	Date To:2007.12	Propshaft	PS900507



	 YEAR	TRANSM.	FITTING POSITION	BODY STYLE & DRIVE TYPE & ENGINE	REMARKS	 PRODUCT	GSP Ref.
VW							
Amarok							
2.0 (90 kw)	2010.09-2013.10	6MT	Rear	Pick up 4WD CDBA/CNFA		Propshaft	PS901348
	2010.09-2013.10	6MT	Rear	Pick up RWD CDBA/CNFA		Propshaft	PS901348
2.0 (103 kw)	2012.05-		Rear	Pick up 4WD CNFB		Propshaft	PS900573
	2012.05-	6MT	Rear	Pick up 4WD CNFB		Propshaft	PS901348
	2012.06-	6MT	Rear	Pick up RWD CNFB		Propshaft	PS901348
2.0 (120 kw)	2009.11-2012.08		Rear	Pick up 4WD CDCA		Propshaft	PS900573
	2009.11-2012.08	6MT	Rear	Pick up 4WD CDCA		Propshaft	PS901348
	2009.11-2012.08	6MT	Rear	Pick up RWD CDCA		Propshaft	PS901348
2.0 (132 kw)	2011.11-	6MT	Rear	Pick up 4WD CNEA/CSHA		Propshaft	PS901348
	2011.11-	6MT	Rear	Pick up RWD CNEA/CSHA		Propshaft	PS901348
Arteon							
2.0 (140 kw)	2017.05-		Rear	Hatchback 4WD DFHA		Flexible Coupling Kit	533882S
2.0 (176 kw)	2017.03-2020.07		Front	Hatchback 4WD CUAA		Flexible Coupling	537626
	2017.03-2020.07		Rear	Hatchback 4WD CUAA		Flexible Coupling	533882
	2017.03-2020.07		Front	Hatchback 4WD CUAA		Flexible Coupling Kit	537626S
	2017.03-2020.07		Rear	Hatchback 4WD CUAA		Flexible Coupling Kit	533882S
2.0 (206 kw)	2017.04-		Front	Hatchback 4WD DJHC		Flexible Coupling	537626
	2017.04-		Rear	Hatchback 4WD DJHC		Flexible Coupling	533882
	2017.04-		Front	Hatchback 4WD DJHC		Flexible Coupling Kit	537626S
	2017.04-		Rear	Hatchback 4WD DJHC		Flexible Coupling Kit	533882S
Bora							
1.8 (92 kw)	1999.02-2000.10		Front	Saloon 4WD AGN		Flexible Coupling	537626
	1999.02-2000.10		Front	Saloon 4WD AGN		Flexible Coupling Kit	537626S
1.9 (66 kw)	1998.11-2002.04		Front	Saloon 4WD AGR		Flexible Coupling	537626
	1998.11-2002.04		Front	Saloon 4WD AGR		Flexible Coupling Kit	537626S
1.9 (74 kw)	2000.01-2003.05		Front	Saloon 4WD ATD		Flexible Coupling	537626
	2000.01-2003.05		Front	Saloon 4WD ATD		Flexible Coupling Kit	537626S
1.9 (85 kw)	1999.02-2001.07		Front	Saloon 4WD AJM/AUY		Flexible Coupling	537626
	1999.02-2001.07		Front	Saloon 4WD AJM/AUY		Flexible Coupling Kit	537626S
1.9 (96 kw)	2001.04-2003.05		Front	Saloon 4WD ASZ		Flexible Coupling	537626
	2001.04-2003.05		Front	Saloon 4WD ASZ		Flexible Coupling Kit	537626S
1.9 (110 kw)	2000.09-2005.05		Front	Saloon 4WD ARL		Flexible Coupling	537626
	2000.09-2005.05		Front	Saloon 4WD ARL		Flexible Coupling Kit	537626S
2.0 (85 kw)	2000.04-2003.05		Front	Saloon 4WD AZH/AZJ		Flexible Coupling	537626
	2000.04-2003.05		Front	Saloon 4WD AZH/AZJ		Flexible Coupling Kit	537626S
2.3 (110 kw)	1998.09-2001.02		Front	Saloon 4WD AGZ		Flexible Coupling	537626
	1998.09-2001.02		Front	Saloon 4WD AGZ		Flexible Coupling Kit	537626S
2.3 (125 kw)	2000.09-2005.05		Front	Saloon 4WD AQN		Flexible Coupling	537626
	2000.09-2005.05		Front	Saloon 4WD AQN		Flexible Coupling Kit	537626S
2.8 (150 kw)	1999.05-2003.05		Front	Saloon 4WD AQP/AUE/BDE		Flexible Coupling	537626
	1999.05-2003.05		Front	Saloon 4WD AQP/AUE/BDE		Flexible Coupling Kit	537626S
Bora Estate/Variant							
1.8 (92 kw)	1999.05-2000.10		Front	Estate 4WD AGN		Flexible Coupling	537626
	1999.05-2000.10		Front	Estate 4WD AGN		Flexible Coupling Kit	537626S
1.9 (74 kw)	2000.05-2003.05		Front	Estate 4WD ATD		Flexible Coupling	537626
	2000.05-2003.05		Front	Estate 4WD ATD		Flexible Coupling Kit	537626S
1.9 (85 kw)	1999.05-2001.07		Front	Estate 4WD AJM/AUY		Flexible Coupling	537626
	1999.05-2001.07		Front	Estate 4WD AJM/AUY		Flexible Coupling Kit	537626S
1.9 (96 kw)	2001.04-2003.05		Front	Estate 4WD ASZ		Flexible Coupling	537626
	2001.04-2003.05		Front	Estate 4WD ASZ		Flexible Coupling Kit	537626S
1.9 (110 kw)	2001.05-2005.05		Front	Estate 4WD ARL		Flexible Coupling	537626
	2001.05-2005.05		Front	Estate 4WD ARL		Flexible Coupling Kit	537626S
2.0 (85 kw)	2000.04-2005.03		Front	Estate 4WD AZH/AZJ		Flexible Coupling	537626
	2000.04-2005.03		Front	Estate 4WD AZH/AZJ		Flexible Coupling Kit	537626S
2.3 (110 kw)	1999.05-2001.02		Front	Estate 4WD AGZ		Flexible Coupling	537626
	1999.05-2001.02		Front	Estate 4WD AGZ		Flexible Coupling Kit	537626S
2.3 (125 kw)	2000.09-2003.06		Front	Estate 4WD AQN		Flexible Coupling	537626
	2000.09-2003.06		Front	Estate 4WD AQN		Flexible Coupling Kit	537626S
2.8 (150 kw)	1999.05-2003.05		Front	Estate 4WD AQP/AUE/BDE		Flexible Coupling	537626
	1999.05-2003.05		Front	Estate 4WD AQP/AUE/BDE		Flexible Coupling Kit	537626S
Caddy							
1.9 (77 kw)	2008.11-2010.08		Front	MPV 4WD BLS		Flexible Coupling	537626
	2008.11-2010.08		Front	MPV Van 4WD BLS		Flexible Coupling	537626



	 YEAR	TRANSM.	FITTING POSITION	BODY STYLE & DRIVE TYPE & ENGINE	REMARKS	 PRODUCT	GSP Ref.
VW Caddy							
2.0 (62 kw)	2010.12-2015.05		Front	MPV Van 4WD CFHE		Flexible Coupling	537626
2.0 (81 kw)	2010.08-2015.05		Front	MPV Van 4WD CFHF		Flexible Coupling	537626
	2010.08-2015.05		Front	MPV 4WD CFHF		Flexible Coupling	537626
2.0 (103 kw)	2010.11-2015.05		Front	MPV 4WD CFHC		Flexible Coupling	537626
	2010.11-2015.05		Front	MPV Van 4WD CFHC		Flexible Coupling	537626
Caddy Maxi							
1.9 (77 kw)	2009.12-2010.08		Front	MPV 4WD BLS		Flexible Coupling	537626
	2009.12-2010.08		Front	MPV Van 4WD BLS		Flexible Coupling	537626
2.0 (62 kw)	2010.12-2015.05		Front	MPV Van 4WD CFHE		Flexible Coupling	537626
2.0 (81 kw)	2010.08-2015.05		Front	MPV Van 4WD CFHF		Flexible Coupling	537626
	2010.10-2015.05		Front	MPV 4WD CFHF		Flexible Coupling	537626
2.0 (103 kw)	2010.11-2015.05		Front	MPV 4WD CFHC		Flexible Coupling	537626
	2010.11-2015.05		Front	MPV Van 4WD CFHC		Flexible Coupling	537626
California							
1.9 (63 kw)	2007.05-2009.11		Centre	BUS FWD AXC		Center Bearing Support	514809
1.9 (75 kw)	2007.05-2009.11		Centre	BUS FWD BRS		Center Bearing Support	514809
1.9 (77 kw)	2007.05-2009.11		Centre	BUS FWD AXB		Center Bearing Support	514809
2.0 (62 kw)	2009.09-2015.08		Centre	BUS FWD CAAA		Center Bearing Support	514809
2.0 (75 kw)	2009.08-2015.08		Centre	BUS FWD CAAB		Center Bearing Support	514809
2.0 (84 kw)	2011.05-2015.08		Centre	BUS FWD CAAD		Center Bearing Support	514809
2.0 (100 kw)	2010.05-2015.08		Centre	BUS 4WD CAAE/CCHB		Center Bearing Support	514809
	2010.05-2015.08		Centre	BUS FWD CAAE/CCHB		Center Bearing Support	514809
2.0 (103 kw)	2009.08-2015.08		Centre	BUS FWD CAAC/CCHA		Center Bearing Support	514809
	2009.10-2015.08		Centre	BUS 4WD CAAC/CCHA		Center Bearing Support	514809
2.0 (110 kw)	2012.07-2015.08		Centre	BUS FWD CJKB		Center Bearing Support	514809
2.0 (132 kw)	2009.09-2015.08		Centre	BUS FWD CFCA		Center Bearing Support	514809
	2010.01-2015.08		Centre	BUS 4WD CFCA		Center Bearing Support	514809
2.0 (150 kw)	2011.05-2015.08		Centre	BUS FWD CJKA		Center Bearing Support	514809
	2011.07-2015.08		Centre	BUS 4WD CJKA		Center Bearing Support	514809
2.5 (65 kw)	1998.05-2003.04		Centre	BUS FWD AJT/AYY		Center Bearing Support	514801
2.5 (75 kw)	2001.04-2003.04		Centre	BUS FWD AYC		Center Bearing Support	514801
2.5 (85 kw)	1999.05-2003.04		Centre	BUS FWD APL/AVT		Center Bearing Support	514801
2.5 (96 kw)	2007.05-2009.11		Front	BUS 4WD AXD/BNZ		Center Bearing Support	537799
	2007.05-2009.11		Rear	BUS 4WD AXD/BNZ		Center Bearing Support	537800
	2007.05-2009.11		Centre	BUS 4WD AXD/BNZ		Center Bearing Support	514809
	2007.05-2009.11		Centre	BUS FWD AXD/BNZ		Center Bearing Support	514809
2.5 (120 kw)	2007.05-2009.11		Centre	BUS FWD BLJ		Center Bearing Support	514809
2.5 (128 kw)	2007.05-2009.11		Front	BUS 4WD AXE/BPC		Center Bearing Support	537799
	2007.05-2009.11		Rear	BUS 4WD AXE/BPC		Center Bearing Support	537800
	2007.05-2009.11		Centre	BUS 4WD AXE/BPC		Center Bearing Support	514809
	2007.05-2009.11		Centre	BUS FWD AXE/BPC		Center Bearing Support	514809
2.8 (150 kw)	2000.05-2001.04		Centre	BUS FWD AMV		Center Bearing Support	514801
Campmobile							
1.9 (50 kw)	1992.10-2003.01		Centre	BUS FWD ABL		Center Bearing Support	514801
2.0 (62 kw)	1990.09-1998.05		Centre	BUS FWD AAC		Center Bearing Support	514801
2.0 (75 kw)	2009.08-2015.08		Centre	BUS FWD CAAB		Center Bearing Support	514809
2.0 (84 kw)	2011.05-2015.08		Centre	BUS FWD CAAD		Center Bearing Support	514809
2.0 (100 kw)	2010.05-2015.08		Centre	BUS 4WD CCHB		Center Bearing Support	514809
	2010.05-2015.08		Centre	BUS FWD CAAE/CCHB		Center Bearing Support	514809
2.0 (103 kw)	2009.08-2015.08		Centre	BUS FWD CAAC/CCHA		Center Bearing Support	514809
	2009.10-2015.08		Centre	BUS 4WD CAAC/CCHA		Center Bearing Support	514809
2.0 (110 kw)	2012.07-2015.08		Centre	BUS FWD CJKB		Center Bearing Support	514809
2.0 (132 kw)	2009.09-2015.08		Centre	BUS FWD CFCA		Center Bearing Support	514809
	2010.01-2015.08		Centre	BUS 4WD CFCA		Center Bearing Support	514809
2.0 (150 kw)	2011.05-2015.08		Centre	BUS FWD CJKA		Center Bearing Support	514809
	2011.07-2015.08		Centre	BUS 4WD CJKA		Center Bearing Support	514809
2.4 (55 kw)	1997.05-2002.04		Centre	BUS FWD AJA		Center Bearing Support	514801
2.4 (57 kw)	1990.09-1998.05		Centre	BUS FWD AAB		Center Bearing Support	514801
2.5 (65 kw)	1998.05-2003.09		Centre	BUS FWD AJT/AYY		Center Bearing Support	514801
2.5 (75 kw)	1996.01-2003.09		Centre	BUS 4WD ACV/AXL		Center Bearing Support	514801
	1996.01-2003.09		Centre	BUS FWD ACV/AUF/AYC		Center Bearing Support	514801
	1996.01-2003.09		Front	BUS 4WD ACV/AXL		Flexible Coupling	537853
2.5 (81 kw)	1990.09-2002.04		Centre	BUS FWD AAF/ACU/AEU		Center Bearing Support	514801
	1993.08-1998.05		Centre	BUS 4WD ACU		Center Bearing Support	514801



	 YEAR	TRANSM.	FITTING POSITION	BODY STYLE & DRIVE TYPE & ENGINE	REMARKS	 PRODUCT	GSP Ref.
VW							
Campmobile							
2.5 (81 kw)	1993.08-1998.05		Front	BUS 4WD ACU		Flexible Coupling	537853
2.5 (85 kw)	1996.08-2002.04		Centre	BUS FWD AET/APL/AVT		Center Bearing Support	514801
	1996.08-2003.09		Centre	BUS 4WD AET		Center Bearing Support	514801
	1996.08-2003.09		Front	BUS 4WD AET		Flexible Coupling	537853
	1999.07-2003.09		Centre	BUS FWD AHY/AXG		Center Bearing Support	514801
2.8 (103 kw)	1996.01-2000.05		Centre	BUS FWD AES		Center Bearing Support	514801
2.8 (150 kw)	2000.05-2003.09		Centre	BUS FWD AMV		Center Bearing Support	514801
Caravelle							
1.9 (50 kw)	1992.08-2003.04		Centre	BUS FWD ABL		Center Bearing Support	514801
1.9 (62 kw)	2006.01-2009.11		Centre	BUS FWD BRR		Center Bearing Support	514809
1.9 (63 kw)	2003.04-2009.11		Centre	BUS FWD AXC		Center Bearing Support	514809
1.9 (75 kw)	2006.01-2009.11		Centre	BUS FWD BRS		Center Bearing Support	514809
1.9 (77 kw)	2003.04-2009.11		Centre	BUS FWD AXB		Center Bearing Support	514809
2.0 (62 kw)	1990.09-2003.04		Centre	BUS FWD AAC		Center Bearing Support	514801
	2009.09-2015.11		Centre	BUS FWD CAAA		Center Bearing Support	514809
2.0 (75 kw)	2009.09-2015.11		Centre	BUS FWD CAAB		Center Bearing Support	514809
2.0 (84 kw)	2011.05-2015.11		Centre	BUS FWD CAAD		Center Bearing Support	514809
2.0 (85 kw)	2003.11-2015.11		Centre	BUS FWD AXA		Center Bearing Support	514809
	2006.01-2014.03		Centre	BUS FWD AXACNG		Center Bearing Support	514809
2.0 (100 kw)	2010.05-2015.11		Centre	BUS FWD CAAE/CCHB		Center Bearing Support	514809
	2010.05-2015.11		Centre	BUS 4WD CAAE/CCHB		Center Bearing Support	514809
2.0 (103 kw)	2009.09-2015.11		Centre	BUS 4WD CAAC/CCHA		Center Bearing Support	514809
	2009.09-2015.11		Centre	BUS FWD CAAC/CCHA		Center Bearing Support	514809
2.0 (110 kw)	2012.07-2015.11		Centre	BUS FWD CJKB		Center Bearing Support	514809
2.0 (132 kw)	2009.09-2015.11		Centre	BUS FWD CFCA		Center Bearing Support	514809
	2010.01-2015.11		Centre	BUS 4WD CFCA		Center Bearing Support	514809
2.0 (150 kw)	2011.05-2015.11		Centre	BUS 4WD CJKA		Center Bearing Support	514809
	2011.05-2015.11		Centre	BUS FWD CJKA		Center Bearing Support	514809
2.4 (55 kw)	1997.04-2003.06		Centre	BUS FWD AJA		Center Bearing Support	514801
2.4 (57 kw)	1990.09-1998.04		Centre	BUS FWD AAB		Center Bearing Support	514801
	1992.08-1998.09		Centre	BUS 4WD AAB		Center Bearing Support	514801
	1992.08-1998.09		Front	BUS 4WD AAB		Flexible Coupling	537853
2.5 (65 kw)	1998.05-2003.04		Centre	BUS FWD AJT/AYY		Center Bearing Support	514801
2.5 (75 kw)	1995.09-2003.04		Centre	BUS FWD ACV/AUF/AYC		Center Bearing Support	514801
	1996.01-2003.04		Centre	BUS 4WD ACV/AXL		Center Bearing Support	514801
	1996.01-2003.04		Front	BUS 4WD ACV/AXL		Flexible Coupling	537853
2.5 (81 kw)	1990.09-2003.06		Centre	BUS FWD AAF/ACU/AEN/AEU		Center Bearing Support	514801
	1992.11-1996.08		Centre	BUS 4WD AAF/ACU		Center Bearing Support	514801
	1992.11-1996.08		Front	BUS 4WD AAF/ACU		Flexible Coupling	537853
2.5 (85 kw)	1996.08-2003.06		Centre	BUS 4WD AET/APL/AVT		Center Bearing Support	514801
	1996.08-2003.06		Centre	BUS FWD AET/APL/AVT		Center Bearing Support	514801
	1996.08-2003.06		Front	BUS 4WD AET/APL/AVT		Flexible Coupling	537853
2.5 (96 kw)	2003.04-2009.11	6MT	Rear	BUS 4WD AXD/BNZ	wheel base:3400mm,For PR code:0E2	Propshaft	PS900569
	2003.04-2009.11	6MT	Rear	BUS 4WD AXD/BNZ	Chassis No. from 7H-8-105-001,wheel base 3000mm,For PR code:0E1/0E2/0E3/0E4/0E5/0E6/0E7/0E8/0E9	Propshaft	PS900570
	2003.04-2009.11		Front	BUS 4WD AXD/BNZ		Center Bearing Support	537799
	2003.04-2009.11		Rear	BUS 4WD AXD/BNZ		Center Bearing Support	537800
	2003.04-2009.11		Centre	BUS FWD AXD/BNZ		Center Bearing Support	514809
	2003.04-2009.11		Centre	BUS 4WD AXD/BNZ		Center Bearing Support	514809
2.5 (111 kw)	1998.05-2003.04		Centre	BUS FWD AHY/AXG		Center Bearing Support	514801
2.5 (120 kw)	2006.01-2009.11		Centre	BUS FWD BLJ		Center Bearing Support	514809
2.5 (128 kw)	2003.04-2009.11		Centre	BUS FWD AXE/BPC		Center Bearing Support	514809
	2004.07-2009.11	6MT	Rear	BUS 4WD AXE/BPC	wheel base:3400mm,For PR code:0E2	Propshaft	PS900569
	2004.07-2009.11	6MT	Rear	BUS 4WD AXE/BPC	Chassis No. from 7H-8-105-001,wheel base 3000mm,For PR code:0E1/0E2/0E3/0E4/0E5/0E6/0E7/0E8/0E9	Propshaft	PS900570
	2004.07-2009.11		Front	BUS 4WD AXE/BPC		Center Bearing Support	537799
	2004.07-2009.11		Rear	BUS 4WD AXE/BPC		Center Bearing Support	537800
	2004.07-2009.11		Centre	BUS 4WD AXE/BPC		Center Bearing Support	514809
2.8 (103 kw)	1996.01-2000.05		Centre	BUS FWD AES		Center Bearing Support	514801
2.8 (150 kw)	2000.06-2003.04		Centre	BUS FWD AMV		Center Bearing Support	514801
3.2 (170 kw)	2004.02-2004.06		Centre	BUS FWD BDL		Center Bearing Support	514809
3.2 (173 kw)	2008.05-2009.11		Centre	BUS FWD BKK/CFLA		Center Bearing Support	514809
	2008.05-2009.12	6MT	Rear	BUS 4WD BKK/CFLA	wheel base:3400mm,For PR code:0E2	Propshaft	PS900569
	2008.05-2009.12	6MT	Rear	BUS 4WD BKK/CFLA	Chassis No. from 7H-8-105-001,wheel base 3000mm,For PR code:0E1/0E2/0E3/0E4/0E5/0E6/0E7/0E8/0E9	Propshaft	PS900570
	2008.05-2009.12		Front	BUS 4WD BKK/CFLA		Center Bearing Support	537799



	 YEAR	TRANSM.	FITTING POSITION	BODY STYLE & DRIVE TYPE & ENGINE	REMARKS	 PRODUCT	GSP Ref.
VW							
Caravelle							
3.2 (173 kw)	2008.05-2009.12		Rear	BUS 4WD BKK/CFLA		Center Bearing Support	537800
	2008.05-2009.12		Centre	BUS 4WD BKK/CFLA		Center Bearing Support	514809
CC							
2.0 (103 kw)	2011.11-2016.12		Rear	Coupe 4WD CFFB		Flexible Coupling	533882
2.0 (125 kw)	2011.11-2013.01		Rear	Coupe 4WD CFGB		Flexible Coupling	533882
2.0 (130 kw)	2012.12-2016.12		Rear	Coupe 4WD CFGC		Flexible Coupling	533882
3.6 (220 kw)	2011.11-2016.12		Front	Coupe 4WD BWS		Flexible Coupling Kit	537626S
Crafter 28							
2.0 (80 kw)	2011.05-2016.12		Front;Rear	Chassis cabin RWD CKTB		Center Bearing Support	514807
	2011.05-2016.12		Front;Rear	VAN RWD CKTB		Center Bearing Support	514807
	2011.05-2016.12		Centre	Chassis cabin RWD CKTB		Center Bearing Support Kit	514795S
	2011.05-2016.12		Centre	VAN RWD CKTB		Center Bearing Support Kit	514795S
2.0 (100 kw)	2011.05-2016.12		Front;Rear	VAN RWD CKTC		Center Bearing Support	514807
	2011.05-2016.12		Centre	VAN RWD CKTC		Center Bearing Support Kit	514795S
2.0 (103 kw)	2015.11-2016.12		Front;Rear	VAN RWD CSLC		Center Bearing Support	514807
	2015.11-2016.12		Centre	VAN RWD CSLC		Center Bearing Support Kit	514795S
2.0 (105 kw)	2011.10-2016.12		Front;Rear	Chassis cabin RWD CKUC		Center Bearing Support	514807
	2011.10-2016.12		Front;Rear	VAN RWD CKUC		Center Bearing Support	514807
	2011.10-2016.12		Centre	Chassis cabin RWD CKUC		Center Bearing Support Kit	514795S
	2011.10-2016.12		Centre	VAN RWD CKUC		Center Bearing Support Kit	514795S
2.0 (120 kw)	2011.07-2016.12		Front;Rear	Chassis cabin RWD CKUB		Center Bearing Support	514807
	2011.07-2016.12		Front;Rear	VAN RWD CKUB		Center Bearing Support	514807
	2011.07-2016.12		Centre	Chassis cabin RWD CKUB		Center Bearing Support Kit	514795S
	2011.07-2016.12		Centre	VAN RWD CKUB		Center Bearing Support Kit	514795S
2.5 (65 kw)	2006.04-2011.07		Front;Rear	Chassis cabin RWD BJJ/CEBA		Center Bearing Support	514807
	2006.04-2011.07		Front;Rear	VAN RWD BJJ/CEBA		Center Bearing Support	514807
	2006.04-2011.07		Centre	Chassis cabin RWD BJJ/CEBA		Center Bearing Support Kit	514795S
	2006.04-2011.07		Centre	VAN RWD BJJ/CEBA		Center Bearing Support Kit	514795S
2.5 (80 kw)	2006.04-2013.05	6MT	Front	Chassis cabin RWD BJK/CEBB	For Engine Code:CEBB,Wheelbase:4325 mm,for PR Code:G9K/9R9	Propshaft	PS900609
	2006.04-2013.05	6MT	Front	VAN RWD BJK/CEBB	For Engine Code:CEBB,Wheelbase:4325 mm,for PR Code:G9K/9R9	Propshaft	PS900609
	2006.04-2013.05		Front;Rear	Chassis cabin RWD BJK/CEBB		Center Bearing Support	514807
	2006.04-2013.05		Front;Rear	VAN RWD BJK/CEBB		Center Bearing Support	514807
	2006.04-2013.05		Centre	Chassis cabin RWD BJK/CEBB		Center Bearing Support Kit	514795S
	2006.04-2013.05		Centre	VAN RWD BJK/CEBB		Center Bearing Support Kit	514795S
2.5 (100 kw)	2006.04-2013.05		Front	Chassis cabin RWD BJL/CECA	For Engine Code:CECA,Wheelbase:4325 mm,for PR Code:G9K/9R9	Propshaft	PS900609
	2006.04-2013.05		Front	VAN RWD BJL/CECA	For Engine Code:CECA,Wheelbase:4325 mm,for PR Code:G9K/9R9	Propshaft	PS900609
	2006.04-2013.05		Front;Rear	Chassis cabin RWD BJL/CECA		Center Bearing Support	514807
	2006.04-2013.05		Front;Rear	VAN RWD BJL/CECA		Center Bearing Support	514807
	2006.04-2013.05		Centre	Chassis cabin RWD BJL/CECA		Center Bearing Support Kit	514795S
	2006.04-2013.05		Centre	VAN RWD BJL/CECA		Center Bearing Support Kit	514795S
2.5 (120 kw)	2006.04-2011.07	6MT	Front	VAN RWD BJM/CECB	For Engine Code:CECB,Wheelbase:4325 mm,for PR Code:G9K/9R9	Propshaft	PS900609
	2006.04-2011.07	6MT	Front	Chassis cabin RWD BJM/CECB	Not For Engine Code:BJM,Wheelbase:4325 mm,for PR Code:G9K/9R9	Propshaft	PS900609
	2006.04-2011.07		Front;Rear	VAN RWD BJM/CECB		Center Bearing Support	514807
	2006.04-2011.07		Front;Rear	Chassis cabin RWD BJM/CECB		Center Bearing Support	514807
	2006.04-2011.07		Centre	VAN RWD BJM/CECB		Center Bearing Support Kit	514795S
	2006.04-2011.07		Centre	Chassis cabin RWD BJM/CECB		Center Bearing Support Kit	514795S
Crafter 30							
2.0 (80 kw)	2011.05-2016.12	MT	Rear	BUS RWD CKTB/CSLA	Wheel base:3985 mm,For PR code:9WC/9R9/15A/1UA/1UB/1UC/1UM/1UJ/9W9	Propshaft	PS900370
	2011.05-2016.12	MT	Rear	Chassis cabin RWD CKTB/CSLA	Wheel base:3985 mm,For PR code:9WC/9R9/15A/1UA/1UB/1UC/1UM/1UJ/9W9	Propshaft	PS900370
	2011.05-2016.12	MT	Rear	VAN RWD CKTB/CSLA	Wheel base:3985 mm,For PR code:9WC/9R9/15A/1UA/1UB/1UC/1UM/1UJ/9W9	Propshaft	PS900370
	2011.05-2016.12		Front;Rear	BUS RWD CKTB/CSLA		Center Bearing Support	514807
	2011.05-2016.12		Front;Rear	Chassis cabin RWD CKTB/CSLA		Center Bearing Support	514807
	2011.05-2016.12		Front;Rear	VAN RWD CKTB/CSLA		Center Bearing Support	514807
	2011.05-2016.12		Centre	BUS RWD CKTB/CSLA		Center Bearing Support Kit	514795S
	2011.05-2016.12		Centre	Chassis cabin RWD CKTB/CSLA		Center Bearing Support Kit	514795S
	2011.05-2016.12		Centre	VAN RWD CKTB/CSLA		Center Bearing Support Kit	514795S
2.0 (84 kw)	2013.11-2016.12		Front;Rear	VAN RWD CSLB		Center Bearing Support	514807
	2013.11-2016.12		Front;Rear	Chassis cabin RWD CSLB		Center Bearing Support	514807
	2013.11-2016.12		Front;Rear	BUS RWD CSLB		Center Bearing Support	514807
	2013.11-2016.12		Centre	VAN RWD CSLB		Center Bearing Support Kit	514795S
	2013.11-2016.12		Centre	Chassis cabin RWD CSLB		Center Bearing Support Kit	514795S
	2013.11-2016.12		Centre	BUS RWD CSLB		Center Bearing Support Kit	514795S
2.0 (100 kw)	2011.05-2016.12	MT	Rear	BUS RWD CKTC	Wheel base:3985 mm,For PR code:9WC/9R9/15A/1UA/1UB/1UC/1UM/1UJ/9W9	Propshaft	PS900370
	2011.05-2016.12	MT	Rear	Chassis cabin RWD CKTC	Wheel base:3985 mm,For PR code:9WC/9R9/15A/1UA/1UB/1UC/1UM/1UJ/9W9	Propshaft	PS900370



	 YEAR	TRANSM.	FITTING POSITION	BODY STYLE & DRIVE TYPE & ENGINE	REMARKS	 PRODUCT	GSP Ref.	
VW Crafter 30								
2.0 (100 kw)	2011.05-2016.12	MT	Rear	VAN RWD CKTC	wheel base:3665 mm,For PR code:0W0C0R015A11UA1UB1UC1UM1U1UW	Propshaft	PS900370	
	2011.05-2016.12		Front;Rear	BUS RWD CKTC		Center Bearing Support	514807	
	2011.05-2016.12		Front;Rear	Chassis cabin RWD CKTC		Center Bearing Support	514807	
	2011.05-2016.12		Front;Rear	VAN RWD CKTC		Center Bearing Support	514807	
	2011.05-2016.12		Centre	BUS RWD CKTC		Center Bearing Support Kit	514795S	
	2011.05-2016.12		Centre	Chassis cabin RWD CKTC		Center Bearing Support Kit	514795S	
2.0 (103 kw)	2015.11-2016.12	MT	Rear	Chassis cabin RWD CSLC	wheel base:3665 mm,For PR code:0W0C0R015A11UA1UB1UC1UM1U1UW	Propshaft	PS900370	
	2015.11-2016.12	MT	Rear	VAN RWD CSLC	wheel base:3665 mm,For PR code:0W0C0R015A11UA1UB1UC1UM1U1UW	Propshaft	PS900370	
	2015.11-2016.12		Front;Rear	Chassis cabin RWD CSLC		Center Bearing Support	514807	
	2015.11-2016.12		Front;Rear	VAN RWD CSLC		Center Bearing Support	514807	
	2015.11-2016.12		Centre	Chassis cabin RWD CSLC		Center Bearing Support Kit	514795S	
	2015.11-2016.12		Centre	VAN RWD CSLC		Center Bearing Support Kit	514795S	
2.0 (105 kw)	2011.10-2016.12		Front;Rear	Chassis cabin RWD CKUC		Center Bearing Support	514807	
	2011.10-2016.12		Front;Rear	VAN RWD CKUC		Center Bearing Support	514807	
	2011.10-2016.12		Centre	Chassis cabin RWD CKUC		Center Bearing Support Kit	514795S	
	2011.10-2016.12		Centre	VAN RWD CKUC		Center Bearing Support Kit	514795S	
2.0 (120 kw)	2011.07-2016.12		Front;Rear	BUS RWD CKUB/CSNA		Center Bearing Support	514807	
	2011.07-2016.12		Front;Rear	Chassis cabin RWD CKUB/CSNA		Center Bearing Support	514807	
	2011.07-2016.12		Front;Rear	VAN RWD CKUB/CSNA		Center Bearing Support	514807	
	2011.07-2016.12		Centre	BUS RWD CKUB/CSNA		Center Bearing Support Kit	514795S	
	2011.07-2016.12		Centre	Chassis cabin RWD CKUB/CSNA		Center Bearing Support Kit	514795S	
2.5 (65 kw)	2006.04-2011.07		Front;Rear	BUS RWD BJJ/CEBA		Center Bearing Support	514807	
	2006.04-2011.07		Front;Rear	Chassis cabin RWD BJJ/CEBA		Center Bearing Support	514807	
	2006.04-2011.07		Front;Rear	VAN RWD BJJ/CEBA		Center Bearing Support	514807	
	2006.04-2011.07		Centre	BUS RWD BJJ/CEBA		Center Bearing Support Kit	514795S	
	2006.04-2011.07		Centre	Chassis cabin RWD BJJ/CEBA		Center Bearing Support Kit	514795S	
2.5 (80 kw)	2006.04-2013.05	6MT	Front	BUS RWD BJK/CEBB	Date From:2009.08,For Engine Code:BJK,Wheelbase:4325mm,For PR code:0R0	Propshaft	PS900365	
	2006.04-2013.05	6MT	Front	BUS RWD BJK/CEBB	For Engine Code:CEBB,Wheelbase:4325 mm,for PR Code:G0K0R0	Propshaft	PS900609	
	2006.04-2013.05	6MT	Front	Chassis cabin RWD BJK/CEBB	For Engine Code:CEBB,Wheelbase:4325 mm,for PR Code:G0K0R0	Propshaft	PS900609	
	2006.04-2013.05	6MT	Front	VAN RWD BJK/CEBB	For Engine Code:CEBB,Wheelbase:4325 mm,for PR Code:G0K0R0	Propshaft	PS900609	
	2006.04-2013.05		Rear	BUS RWD BJK/CEBB	Date:10.2008.10,For Engine Code:BJK,Wheelbase:3665 mm,For PR code:04G0R0	Propshaft	PS900368	
	2006.04-2013.05		Rear	BUS RWD BJK/CEBB	Date:10.2008.10,For Engine Code:BJK,Wheelbase:3665 mm,For PR code:0R05KA	Propshaft	PS900368	
	2006.04-2013.05		Rear	BUS RWD BJK/CEBB	Date:From:2008.08,Engine Code:BJK,Wheelbase:3665 mm,For PR code:0R05KA,Wheelbase:3665 mm,For PR code:0R05KA	Propshaft	PS900368	
	2006.04-2013.05		Rear	BUS RWD BJK/CEBB	Date:From:2008.08,Engine Code:BJK,Wheelbase:3665 mm,For PR code:0R05KA,Wheelbase:3665 mm,For PR code:0R05KA	Propshaft	PS900368	
	2006.04-2013.05		Rear	BUS RWD BJK/CEBB	Date:From:2008.08,Engine Code:BJK,Wheelbase:3665 mm,For PR code:0R05KA,Wheelbase:3665 mm,For PR code:0R05KA	Propshaft	PS900368	
	2006.04-2013.05		Rear	BUS RWD BJK/CEBB	Date:From:2008.08,Engine Code:BJK,Wheelbase:3665 mm,For PR code:0R05KA,Wheelbase:3665 mm,For PR code:0R05KA	Propshaft	PS900368	
	2006.04-2013.05		Rear	BUS RWD BJK/CEBB	Date:From:2008.08,Engine Code:BJK,Wheelbase:3665 mm,For PR code:0R05KA,Wheelbase:3665 mm,For PR code:0R05KA	Propshaft	PS900368	
	2006.04-2013.05		Rear	BUS RWD BJK/CEBB	Date:From:2008.08,Engine Code:BJK,Wheelbase:3665 mm,For PR code:0R05KA,Wheelbase:3665 mm,For PR code:0R05KA	Propshaft	PS900368	
	2006.04-2013.05		Rear	BUS RWD BJK/CEBB	Date:From:2008.08,Engine Code:BJK,Wheelbase:3665 mm,For PR code:0R05KA,Wheelbase:3665 mm,For PR code:0R05KA	Propshaft	PS900368	
	2006.04-2013.05		Rear	BUS RWD BJK/CEBB	Date:From:2008.08,Engine Code:BJK,Wheelbase:3665 mm,For PR code:0R05KA,Wheelbase:3665 mm,For PR code:0R05KA	Propshaft	PS900368	
	2006.04-2013.05		Rear	BUS RWD BJK/CEBB	Date:From:2008.08,Engine Code:BJK,Wheelbase:3665 mm,For PR code:0R05KA,Wheelbase:3665 mm,For PR code:0R05KA	Propshaft	PS900368	
	2006.04-2013.05		Rear	BUS RWD BJK/CEBB	Date:From:2008.08,Engine Code:BJK,Wheelbase:3665 mm,For PR code:0R05KA,Wheelbase:3665 mm,For PR code:0R05KA	Propshaft	PS900368	
	2006.04-2013.05		Rear	BUS RWD BJK/CEBB	Date:From:2008.08,Engine Code:BJK,Wheelbase:3665 mm,For PR code:0R05KA,Wheelbase:3665 mm,For PR code:0R05KA	Propshaft	PS900368	
	2006.04-2013.05		Rear	BUS RWD BJK/CEBB	Date:From:2008.08,Engine Code:BJK,Wheelbase:3665 mm,For PR code:0R05KA,Wheelbase:3665 mm,For PR code:0R05KA	Propshaft	PS900368	
	2.5 (100 kw)	2006.04-2013.05		Front	Chassis cabin RWD BJL/CECA	For Engine Code:CECA,Wheelbase:4325 mm,for PR Code:G0K0R0	Propshaft	PS900609
		2006.04-2013.05		Front	VAN RWD BJL/CECA	For Engine Code:CECA,Wheelbase:4325 mm,for PR Code:G0K0R0	Propshaft	PS900609
2006.04-2013.05			Front;Rear	BUS RWD BJL/CECA		Center Bearing Support	514807	
2006.04-2013.05			Front;Rear	Chassis cabin RWD BJL/CECA		Center Bearing Support	514807	
2006.04-2013.05			Front;Rear	VAN RWD BJL/CECA		Center Bearing Support	514807	
2006.04-2013.05			Centre	BUS RWD BJL/CECA		Center Bearing Support Kit	514795S	
2006.04-2013.05			Centre	Chassis cabin RWD BJL/CECA		Center Bearing Support Kit	514795S	
2.5 (120 kw)	2006.04-2011.07	6MT	Front	BUS RWD BJM/CECB	For Engine Code:CECB,Wheelbase:4325 mm,for PR Code:G0K0R0	Propshaft	PS900609	
	2006.04-2011.07	6MT	Front	Chassis cabin RWD BJM/CECB	Not For Engine Code:BJM,Wheelbase:4325 mm,for PR Code:G0K0R0	Propshaft	PS900609	
	2006.04-2011.07	6MT	Front	VAN RWD BJM/CECB	For Engine Code:CECB,Wheelbase:4325 mm,for PR Code:G0K0R0	Propshaft	PS900609	
	2006.04-2011.07		Rear	BUS RWD BJM/CECB	Date:10.2010.12,For Engine Code:CECB,Wheelbase:3665 mm,For PR code:0R05KA,Wheelbase:3665 mm,For PR code:0R05KA	Propshaft	PS900550	
	2006.04-2011.07		Rear	Chassis cabin RWD BJM/CECB	Date:10.2010.12,For Engine Code:CECB,Wheelbase:3665 mm,For PR code:0R05KA,Wheelbase:3665 mm,For PR code:0R05KA	Propshaft	PS900550	
	2006.04-2011.07		Rear	VAN RWD BJM/CECB	Date:10.2010.12,For Engine Code:CECB,Wheelbase:3665 mm,For PR code:0R05KA,Wheelbase:3665 mm,For PR code:0R05KA	Propshaft	PS900550	
	2006.04-2011.07		Rear	VAN RWD BJM/CECB	For Engine Code:CECB,Wheelbase:4325 mm	Propshaft	PS900558	
	2006.04-2011.07		Front;Rear	BUS RWD BJM/CECB		Center Bearing Support	514807	
	2006.04-2011.07		Front;Rear	Chassis cabin RWD BJM/CECB		Center Bearing Support	514807	



	 YEAR	TRANSM.	FITTING POSITION	BODY STYLE & DRIVE TYPE & ENGINE	REMARKS	 PRODUCT	GSP Ref.
VW Crafter 30							
2.5 (120 kw)	2006.04-2011.07		Front;Rear	VAN RWD BJM/CECB		Center Bearing Support	514807
	2006.04-2011.07		Centre	BUS RWD BJM/CECB		Center Bearing Support Kit	514795S
	2006.04-2011.07		Centre	Chassis cabin RWD BJM/CECB		Center Bearing Support Kit	514795S
	2006.04-2011.07		Centre	VAN RWD BJM/CECB		Center Bearing Support Kit	514795S
Crafter 32							
2.0 (80 kw)	2011.05-2016.12		Front;Rear	BUS RWD CKTB/CSLA		Center Bearing Support	514807
	2011.05-2016.12		Front;Rear	Chassis cabin RWD CKTB		Center Bearing Support	514807
	2011.05-2016.12		Front;Rear	VAN RWD CKTB		Center Bearing Support	514807
	2011.05-2016.12		Centre	BUS RWD CKTB/CSLA		Center Bearing Support Kit	514795S
	2011.05-2016.12		Centre	Chassis cabin RWD CKTB		Center Bearing Support Kit	514795S
	2011.05-2016.12		Centre	VAN RWD CKTB		Center Bearing Support Kit	514795S
2.0 (84 kw)	2013.11-2016.12		Front;Rear	VAN RWD CSLB		Center Bearing Support	514807
	2013.11-2016.12		Front;Rear	BUS RWD CSLB		Center Bearing Support	514807
	2013.11-2016.12		Centre	VAN RWD CSLB		Center Bearing Support Kit	514795S
	2013.11-2016.12		Centre	BUS RWD CSLB		Center Bearing Support Kit	514795S
2.0 (100 kw)	2011.05-2016.12		Front;Rear	BUS RWD CKTC		Center Bearing Support	514807
	2011.05-2016.12		Front;Rear	Chassis cabin RWD CKTC		Center Bearing Support	514807
	2011.05-2016.12		Front;Rear	VAN RWD CKTC		Center Bearing Support	514807
	2011.05-2016.12		Centre	BUS RWD CKTC		Center Bearing Support Kit	514795S
	2011.05-2016.12		Centre	Chassis cabin RWD CKTC		Center Bearing Support Kit	514795S
	2011.05-2016.12		Centre	VAN RWD CKTC		Center Bearing Support Kit	514795S
2.0 (105 kw)	2011.10-2016.12		Front;Rear	Chassis cabin RWD CKUC		Center Bearing Support	514807
	2011.10-2016.12		Front;Rear	VAN RWD CKUC		Center Bearing Support	514807
	2011.10-2016.12		Centre	Chassis cabin RWD CKUC		Center Bearing Support Kit	514795S
	2011.10-2016.12		Centre	VAN RWD CKUC		Center Bearing Support Kit	514795S
2.0 (120 kw)	2011.07-2016.12		Front;Rear	BUS RWD CKUB		Center Bearing Support	514807
	2011.07-2016.12		Front;Rear	Chassis cabin RWD CKUB		Center Bearing Support	514807
	2011.07-2016.12		Front;Rear	VAN RWD CKUB/CSNA		Center Bearing Support	514807
	2011.07-2016.12		Centre	BUS RWD CKUB		Center Bearing Support Kit	514795S
	2011.07-2016.12		Centre	Chassis cabin RWD CKUB		Center Bearing Support Kit	514795S
	2011.07-2016.12		Centre	VAN RWD CKUB/CSNA		Center Bearing Support Kit	514795S
2.5 (65 kw)	2006.04-2011.07		Front;Rear	Chassis cabin RWD BJJ/CEBA		Center Bearing Support	514807
	2006.04-2011.07		Front;Rear	VAN RWD BJJ/CEBA		Center Bearing Support	514807
	2006.04-2011.07		Front;Rear	BUS RWD BJJ/CEBA		Center Bearing Support	514807
	2006.04-2011.07		Centre	Chassis cabin RWD BJJ/CEBA		Center Bearing Support Kit	514795S
	2006.04-2011.07		Centre	VAN RWD BJJ/CEBA		Center Bearing Support Kit	514795S
	2006.04-2011.07		Centre	BUS RWD BJJ/CEBA		Center Bearing Support Kit	514795S
2.5 (80 kw)	2006.04-2013.05	6MT	Front	BUS RWD BJK/CEBB	For Engine Code:CEBB,Wheelbase:4325 mm,for PR Code:G9K0R9D	Propshaft	PS900609
	2006.04-2013.05	6MT	Front	VAN RWD BJK/CEBB	For Engine Code:CEBB,Wheelbase:4325 mm,for PR Code:G9K0R9D	Propshaft	PS900609
	2006.04-2013.05	6MT	Front	Chassis cabin RWD BJK/CEBB	For Engine Code:CEBB,Wheelbase:4325 mm,for PR Code:G9K0R9D	Propshaft	PS900609
	2006.04-2013.05		Front;Rear	BUS RWD BJK/CEBB		Center Bearing Support	514807
	2006.04-2013.05		Front;Rear	VAN RWD BJK/CEBB		Center Bearing Support	514807
	2006.04-2013.05		Front;Rear	Chassis cabin RWD BJK/CEBB		Center Bearing Support	514807
	2006.04-2013.05		Centre	BUS RWD BJK/CEBB		Center Bearing Support Kit	514795S
	2006.04-2013.05		Centre	VAN RWD BJK/CEBB		Center Bearing Support Kit	514795S
	2006.04-2013.05		Centre	Chassis cabin RWD BJK/CEBB		Center Bearing Support Kit	514795S
	2006.04-2013.05		Centre	VAN RWD BJK/CEBB		Center Bearing Support Kit	514795S
2.5 (100 kw)	2006.04-2013.05		Front	Chassis cabin RWD BJL/CECA	For Engine Code:CECA,Wheelbase:4325 mm,for PR Code:G9K0R9D	Propshaft	PS900609
	2006.04-2013.05		Front	VAN RWD BJL/CECA	For Engine Code:CECA,Wheelbase:4325 mm,for PR Code:G9K0R9D	Propshaft	PS900609
	2006.04-2013.05		Front;Rear	Chassis cabin RWD BJL/CECA		Center Bearing Support	514807
	2006.04-2013.05		Front;Rear	VAN RWD BJL/CECA		Center Bearing Support	514807
	2006.04-2013.05		Centre	Chassis cabin RWD BJL/CECA		Center Bearing Support Kit	514795S
	2006.04-2013.05		Centre	VAN RWD BJL/CECA		Center Bearing Support Kit	514795S
2.5 (120 kw)	2006.04-2011.07	6MT	Front	VAN RWD BJM/CECB	For Engine Code:CECB,Wheelbase:4325 mm,for PR Code:G9K0R9D	Propshaft	PS900609
	2006.04-2011.07	6MT	Front	Chassis cabin RWD BJM/CECB	Not For Engine Code:BJM,Wheelbase:4325 mm,for PR Code:G9K0R9D	Propshaft	PS900609
	2006.04-2011.07		Front;Rear	VAN RWD BJM/CECB		Center Bearing Support	514807
	2006.04-2011.07		Front;Rear	Chassis cabin RWD BJM/CECB		Center Bearing Support	514807
	2006.04-2011.07		Centre	VAN RWD BJM/CECB		Center Bearing Support Kit	514795S
	2006.04-2011.07		Centre	Chassis cabin RWD BJM/CECB		Center Bearing Support Kit	514795S
Crafter 35							
2.0 (80 kw)	2011.05-2016.12		Rear	BUS RWD CKTB/CSLA	Wheel base 4325 mm,For PR code:1SA1UA1UB1UC1UM1UJ	Propshaft	PS900367
	2011.05-2016.12		Rear	Chassis cabin RWD CKTB/CSLA	Wheel base 4325 mm,For PR code:1SA1UA1UB1UC1UM1UJ	Propshaft	PS900367
	2011.05-2016.12		Rear	VAN RWD CKTB/CSLA	Wheel base 4325 mm,For PR code:1SA1UA1UB1UC1UM1UJ	Propshaft	PS900367
	2011.05-2016.12	MT	Rear	BUS RWD CKTB/CSLA	Wheel base 3985 mm,For PR code:2WC0R9D1SA1UA1UB1UC1UM1UJ09S	Propshaft	PS900370
	2011.05-2016.12	MT	Rear	Chassis cabin RWD CKTB/CSLA	Wheel base 3985 mm,For PR code:2WC0R9D1SA1UA1UB1UC1UM1UJ09S	Propshaft	PS900370



 YEAR	TRANSM.	FITTING POSITION	BODY STYLE & DRIVE TYPE & ENGINE	REMARKS	 PRODUCT	GSP Ref.	
VW Crafter 35							
2.0 (80 kw)	2011.05-2016.12	MT	Rear	VAN RWD CKTB/CSLA	Wheel base 3965 mm,For PR code:0WC0R915A11UA1UB1UC1UM1UJ1UW	Propshaft	PS900370
	2011.05-2016.12		Front;Rear	BUS RWD CKTB/CSLA		Center Bearing Support	514807
	2011.05-2016.12		Front;Rear	Chassis cabin RWD CKTB/CSLA		Center Bearing Support	514807
	2011.05-2016.12		Front;Rear	VAN RWD CKTB/CSLA		Center Bearing Support	514807
	2011.05-2016.12		Centre	BUS RWD CKTB/CSLA		Center Bearing Support Kit	514795S
	2011.05-2016.12		Centre	Chassis cabin RWD CKTB/CSLA		Center Bearing Support Kit	514795S
2.0 (84 kw)	2013.11-2016.12		Front;Rear	BUS RWD CSLB		Center Bearing Support	514807
	2013.11-2016.12		Front;Rear	VAN RWD CSLB		Center Bearing Support	514807
	2013.11-2016.12		Front;Rear	Chassis cabin RWD CSLB		Center Bearing Support	514807
	2013.11-2016.12		Centre	BUS RWD CSLB		Center Bearing Support Kit	514795S
	2013.11-2016.12		Centre	VAN RWD CSLB		Center Bearing Support Kit	514795S
	2013.11-2016.12		Centre	Chassis cabin RWD CSLB		Center Bearing Support Kit	514795S
2.0 (100 kw)	2011.05-2016.12		Rear	BUS RWD CKTC	Wheel base 4325 mm,For PR code:1SA11UA1UB1UC1UM1UJ1U	Propshaft	PS900367
	2011.05-2016.12		Rear	Chassis cabin RWD CKTC	Wheel base 4325 mm,For PR code:1SA11UA1UB1UC1UM1UJ1U	Propshaft	PS900367
	2011.05-2016.12		Rear	VAN RWD CKTC	Wheel base 4325 mm,For PR code:1SA11UA1UB1UC1UM1UJ1U	Propshaft	PS900367
	2011.05-2016.12	MT	Rear	BUS RWD CKTC	Wheel base 3965 mm,For PR code:0WC0R915A11UA1UB1UC1UM1UJ1UW	Propshaft	PS900370
	2011.05-2016.12	MT	Rear	Chassis cabin RWD CKTC	Wheel base 3965 mm,For PR code:0WC0R915A11UA1UB1UC1UM1UJ1UW	Propshaft	PS900370
	2011.05-2016.12	MT	Rear	VAN RWD CKTC	Wheel base 3965 mm,For PR code:0WC0R915A11UA1UB1UC1UM1UJ1UW	Propshaft	PS900370
	2011.05-2016.12		Front;Rear	BUS RWD CKTC		Center Bearing Support	514807
	2011.05-2016.12		Front;Rear	Chassis cabin RWD CKTC		Center Bearing Support	514807
	2011.05-2016.12		Front;Rear	VAN RWD CKTC		Center Bearing Support	514807
	2011.05-2016.12		Centre	BUS RWD CKTC		Center Bearing Support Kit	514795S
	2011.05-2016.12		Centre	Chassis cabin RWD CKTC		Center Bearing Support Kit	514795S
	2011.05-2016.12		Centre	VAN RWD CKTC		Center Bearing Support Kit	514795S
2.0 (103 kw)	2015.11-2016.12		Rear	Chassis cabin RWD CSLC	Wheel base 4325 mm,For PR code:1SA11UA1UB1UC1UM1UJ1U	Propshaft	PS900367
	2015.11-2016.12		Rear	VAN RWD CSLC	Wheel base 4325 mm,For PR code:1SA11UA1UB1UC1UM1UJ1U	Propshaft	PS900367
	2015.11-2016.12	MT	Rear	Chassis cabin RWD CSLC	Wheel base 3965 mm,For PR code:0WC0R915A11UA1UB1UC1UM1UJ1UW	Propshaft	PS900370
	2015.11-2016.12	MT	Rear	VAN RWD CSLC	Wheel base 3965 mm,For PR code:0WC0R915A11UA1UB1UC1UM1UJ1UW	Propshaft	PS900370
	2015.11-2016.12		Front;Rear	Chassis cabin RWD CSLC		Center Bearing Support	514807
	2015.11-2016.12		Front;Rear	VAN RWD CSLC		Center Bearing Support	514807
	2015.11-2016.12		Centre	Chassis cabin RWD CSLC		Center Bearing Support Kit	514795S
2.0 (105 kw)	2011.10-2016.12		Rear	Chassis cabin RWD CKUC	For PR code:1SA11UA1UB1UC1UM1UJ1U,Wheel base 4325 mm	Propshaft	PS900367
	2011.10-2016.12		Rear	VAN RWD CKUC	For PR code:1SA11UA1UB1UC1UM1UJ1U,Wheel base 4325 mm	Propshaft	PS900367
	2011.10-2016.12		Front;Rear	Chassis cabin RWD CKUC		Center Bearing Support	514807
	2011.10-2016.12		Front;Rear	VAN RWD CKUC		Center Bearing Support	514807
	2011.10-2016.12		Front;Rear	BUS RWD CKUC		Center Bearing Support	514807
	2011.10-2016.12		Centre	Chassis cabin RWD CKUC		Center Bearing Support Kit	514795S
	2011.10-2016.12		Centre	VAN RWD CKUC		Center Bearing Support Kit	514795S
	2011.10-2016.12		Centre	BUS RWD CKUC		Center Bearing Support Kit	514795S
2.0 (120 kw)	2011.05-2016.12		Front;Rear	VAN RWD CKUB/CSNA		Center Bearing Support	514807
	2011.05-2016.12		Centre	VAN RWD CKUB/CSNA		Center Bearing Support Kit	514795S
	2011.07-2016.12		Front;Rear	BUS RWD CKUB/CSNA		Center Bearing Support	514807
	2011.07-2016.12		Front;Rear	Chassis cabin RWD CKUB/CSNA		Center Bearing Support	514807
	2011.07-2016.12		Front;Rear	BUS 4WD CKUB/CSNA		Center Bearing Support	514807
	2011.07-2016.12		Front;Rear	Chassis cabin 4WD CKUB/CSNA		Center Bearing Support	514807
	2011.07-2016.12		Front;Rear	VAN 4WD CKUB/CSNA		Center Bearing Support	514807
	2011.07-2016.12		Centre	BUS RWD CKUB/CSNA		Center Bearing Support Kit	514795S
	2011.07-2016.12		Centre	Chassis cabin RWD CKUB/CSNA		Center Bearing Support Kit	514795S
	2011.07-2016.12		Centre	BUS 4WD CKUB/CSNA		Center Bearing Support Kit	514795S
	2011.07-2016.12		Centre	Chassis cabin 4WD CKUB/CSNA		Center Bearing Support Kit	514795S
	2011.07-2016.12		Centre	VAN 4WD CKUB/CSNA		Center Bearing Support Kit	514795S
2.5 (65 kw)	2006.04-2011.07		Front;Rear	BUS RWD BJJ/CEBA		Center Bearing Support	514807
	2006.04-2011.07		Front;Rear	Chassis cabin RWD BJJ/CEBA		Center Bearing Support	514807
	2006.04-2011.07		Front;Rear	VAN RWD BJJ/CEBA		Center Bearing Support	514807
	2006.04-2011.07		Centre	BUS RWD BJJ/CEBA		Center Bearing Support Kit	514795S
	2006.04-2011.07		Centre	Chassis cabin RWD BJJ/CEBA		Center Bearing Support Kit	514795S
	2006.04-2011.07		Centre	VAN RWD BJJ/CEBA		Center Bearing Support Kit	514795S
2.5 (80 kw)	2006.04-2013.05	6MT	Front	BUS RWD BJK/CEBB	Date From 2009.06,For Engine Code:BJK,Wheelbase:4325mm,For PR code:0R9	Propshaft	PS900365
	2006.04-2013.05	6MT	Front	BUS RWD BJK/CEBB	For Engine Code:CEBB,Wheelbase:4325 mm,For PR Code:GDK0R9	Propshaft	PS900609
	2006.04-2013.05	6MT	Front	Chassis cabin RWD BJK/CEBB	For Engine Code:CEBB,Wheelbase:4325 mm,For PR Code:GDK0R9	Propshaft	PS900609
	2006.04-2013.05	6MT	Front	VAN RWD BJK/CEBB	For Engine Code:CEBB,Wheelbase:4325 mm,For PR Code:GDK0R9	Propshaft	PS900609
	2006.04-2013.05		Rear	BUS RWD BJK/CEBB	Wheel base 4325 mm,For PR code:1SA11UA1UB1UC1UM1UJ1U,For Engine Code:CEBB,B	Propshaft	PS900367



	 YEAR	TRANSM.	FITTING POSITION	BODY STYLE & DRIVE TYPE & ENGINE	REMARKS	 PRODUCT	GSP Ref.
VW Crafter 35							
2.5 (80 kw)	2006.04-2013.05		Rear	BUS RWD BJK/CEBB	Date To 2006.10 For Engine Code BJK, wheel base 3655 mm, For PR Code 09D064A	Propshaft	PS900368
	2006.04-2013.05		Rear	BUS RWD BJK/CEBB	Date To 2006.10 For Engine Code BJK, wheel base 3655 mm, For PR Code 09D064C	Propshaft	PS900368
	2006.04-2013.05		Rear	BUS RWD BJK/CEBB	Date From 200.04 For Engine Code BJK, wheel base 3655 mm, For PR Code 09D064A	Propshaft	PS900368
	2006.04-2013.05		Rear	BUS RWD BJK/CEBB	Date From 200.04 For Engine Code BJK, wheel base 3655 mm, For PR Code 09D064C	Propshaft	PS900368
	2006.04-2013.05		Rear	BUS RWD BJK/CEBB	Date From 200.04 For Engine Code BJK, wheel base 3655 mm, For PR Code 09D064A	Propshaft	PS900368
	2006.04-2013.05		Rear	BUS RWD BJK/CEBB	Date From 200.04 For Engine Code BJK, wheel base 3655 mm, For PR Code 09D064C	Propshaft	PS900368
	2006.04-2013.05		Rear	BUS RWD BJK/CEBB	Date To 2011.12 For Engine Code BJK, wheel base 3655 mm, For PR Code 09D064A	Propshaft	PS900550
	2006.04-2013.05		Front;Rear	BUS RWD BJK/CEBB		Center Bearing Support	514807
	2006.04-2013.05		Front;Rear	Chassis cabin RWD BJK/CEBB		Center Bearing Support	514807
	2006.04-2013.05		Front;Rear	VAN RWD BJK/CEBB		Center Bearing Support	514807
	2006.04-2013.05		Centre	BUS RWD BJK/CEBB		Center Bearing Support Kit	514795S
	2006.04-2013.05		Centre	Chassis cabin RWD BJK/CEBB		Center Bearing Support Kit	514795S
	2006.04-2013.05		Centre	VAN RWD BJK/CEBB		Center Bearing Support Kit	514795S
	2.5 (100 kw)	2006.04-2013.05		Front	Chassis cabin RWD BJL/CECA	For Engine Code CECA, Wheelbase: 4325 mm, for PR Code G0K0R0	Propshaft
2006.04-2013.05			Front	VAN RWD BJL/CECA	For Engine Code CECA, Wheelbase: 4325 mm, for PR Code G0K0R0	Propshaft	PS900609
2006.04-2013.05			Front;Rear	BUS RWD BJL/CECA		Center Bearing Support	514807
2006.04-2013.05			Front;Rear	Chassis cabin RWD BJL/CECA		Center Bearing Support	514807
2006.04-2013.05			Front;Rear	VAN RWD BJL/CECA		Center Bearing Support	514807
2006.04-2013.05			Centre	BUS RWD BJL/CECA		Center Bearing Support Kit	514795S
2006.04-2013.05			Centre	Chassis cabin RWD BJL/CECA		Center Bearing Support Kit	514795S
2006.04-2013.05			Centre	VAN RWD BJL/CECA		Center Bearing Support Kit	514795S
2.5 (120 kw)	2006.04-2011.07	6MT	Front	BUS RWD BJM/CECB	For Engine Code CECB, Wheelbase: 4325 mm, for PR Code G0K0R0	Propshaft	PS900609
	2006.04-2011.07	6MT	Front	Chassis cabin RWD BJM/CECB	Not For Engine Code BJM, Wheelbase: 4325 mm, for PR Code G0K0R0	Propshaft	PS900609
	2006.04-2011.07	6MT	Front	VAN RWD BJM/CECB	For Engine Code CECB, Wheelbase: 4325 mm, for PR Code G0K0R0	Propshaft	PS900609
	2006.04-2011.07		Rear	BUS RWD BJM/CECB	Date To 2010.12 For Engine Code CECB, wheel base 3655 mm, For PR Code 09D064A/B/C	Propshaft	PS900550
	2006.04-2011.07		Rear	Chassis cabin RWD BJM/CECB	Date To 2010.12 For Engine Code CECB, wheel base 3655 mm, For PR Code 09D064A/B/C	Propshaft	PS900550
	2006.04-2011.07		Rear	VAN RWD BJM/CECB	Date To 2010.12 For Engine Code CECB, wheel base 3655 mm, For PR Code 09D064A/B/C	Propshaft	PS900550
	2006.04-2011.07		Rear	VAN RWD BJM/CECB	For Engine Code CECB, wheel base: 4325 mm	Propshaft	PS900558
	2006.04-2011.07		Front;Rear	BUS RWD BJM/CECB		Center Bearing Support	514807
	2006.04-2011.07		Front;Rear	Chassis cabin RWD BJM/CECB		Center Bearing Support	514807
	2006.04-2011.07		Front;Rear	VAN RWD BJM/CECB		Center Bearing Support	514807
	2006.04-2011.07		Centre	BUS RWD BJM/CECB		Center Bearing Support Kit	514795S
	2006.04-2011.07		Centre	Chassis cabin RWD BJM/CECB		Center Bearing Support Kit	514795S
	2006.04-2011.07		Centre	VAN RWD BJM/CECB		Center Bearing Support Kit	514795S
	Crafter 46						
2.0 (80 kw)	2011.05-2016.12		Front;Rear	Chassis cabin RWD CKTB		Center Bearing Support	514807
	2011.05-2016.12		Front;Rear	VAN RWD CKTB		Center Bearing Support	514807
	2011.05-2016.12		Centre	Chassis cabin RWD CKTB		Center Bearing Support Kit	514795S
	2011.05-2016.12		Centre	VAN RWD CKTB		Center Bearing Support Kit	514795S
2.0 (84 kw)	2013.11-2016.12		Front;Rear	VAN RWD CSLB		Center Bearing Support	514807
	2013.11-2016.12		Centre	VAN RWD CSLB		Center Bearing Support Kit	514795S
2.0 (100 kw)	2011.05-2016.12		Front;Rear	VAN RWD CKTC		Center Bearing Support	514807
	2011.05-2016.12		Front;Rear	Chassis cabin RWD CKTC		Center Bearing Support	514807
	2011.05-2016.12		Centre	VAN RWD CKTC		Center Bearing Support Kit	514795S
2.0 (105 kw)	2011.05-2016.12		Centre	Chassis cabin RWD CKTC		Center Bearing Support Kit	514795S
	2011.10-2016.12		Front;Rear	Chassis cabin RWD CKUC		Center Bearing Support	514807
	2011.10-2016.12		Front;Rear	VAN RWD CKUC		Center Bearing Support	514807
	2011.10-2016.12		Centre	Chassis cabin RWD CKUC		Center Bearing Support Kit	514795S
2.0 (120 kw)	2011.10-2016.12		Centre	VAN RWD CKUC		Center Bearing Support Kit	514795S
	2011.07-2016.12		Front;Rear	Chassis cabin RWD CKUB		Center Bearing Support	514807
	2011.07-2016.12		Front;Rear	VAN RWD CKUB/CSNA		Center Bearing Support	514807
	2011.07-2016.12		Centre	Chassis cabin RWD CKUB		Center Bearing Support Kit	514795S
2.5 (80 kw)	2011.07-2016.12		Centre	VAN RWD CKUB/CSNA		Center Bearing Support Kit	514795S
	2006.04-2013.05	6MT	Front	Chassis cabin RWD BJK/CEBB	For Engine Code CEBB, Wheelbase: 4325 mm, for PR Code G0K0R0	Propshaft	PS900609
	2006.04-2013.05	6MT	Front	VAN RWD BJK/CEBB	For Engine Code CEBB, Wheelbase: 4325 mm, for PR Code G0K0R0	Propshaft	PS900609
	2006.04-2013.05		Front;Rear	Chassis cabin RWD BJK/CEBB		Center Bearing Support	514807
	2006.04-2013.05		Front;Rear	VAN RWD BJK/CEBB		Center Bearing Support	514807
	2006.04-2013.05		Centre	Chassis cabin RWD BJK/CEBB		Center Bearing Support Kit	514795S
2.5 (100 kw)	2006.04-2013.05		Centre	VAN RWD BJK/CEBB		Center Bearing Support Kit	514795S
	2006.04-2013.05		Front	Chassis cabin RWD BJL/CECA	For Engine Code CECA, Wheelbase: 4325 mm, for PR Code G0K0R0	Propshaft	PS900609
	2006.04-2013.05		Front	VAN RWD BJL/CECA	For Engine Code CECA, Wheelbase: 4325 mm, for PR Code G0K0R0	Propshaft	PS900609
	2006.04-2013.05		Front;Rear	Chassis cabin RWD BJL/CECA		Center Bearing Support	514807
	2006.04-2013.05		Front;Rear	VAN RWD BJL/CECA		Center Bearing Support	514807
	2006.04-2013.05		Centre	Chassis cabin RWD BJL/CECA		Center Bearing Support Kit	514795S



	 YEAR	TRANSM.	FITTING POSITION	BODY STYLE & DRIVE TYPE & ENGINE	REMARKS	 PRODUCT	GSP Ref.
VW							
Crafter 46							
2.5 (100 kw)	2006.04-2013.05		Centre	VAN RWD BJL/CECA		Center Bearing Support Kit	514795S
2.5 (120 kw)	2006.04-2011.07	6MT	Front	Chassis cabin RWD BJM/CECB	Not For Engine Code BJM, Wheelbase:4325 mm, For PR Code:G0K0R0	Propshaft	PS900609
	2006.04-2011.07	6MT	Front	VAN RWD BJM/CECB	For Engine Code:CECB, Wheelbase:4325 mm, For PR Code:G0K0R0	Propshaft	PS900609
	2006.04-2011.07		Front;Rear	Chassis cabin RWD BJM/CECB		Center Bearing Support	514807
	2006.04-2011.07		Front;Rear	VAN RWD BJM/CECB		Center Bearing Support	514807
	2006.04-2011.07		Centre	Chassis cabin RWD BJM/CECB		Center Bearing Support Kit	514795S
	2006.04-2011.07		Centre	VAN RWD BJM/CECB		Center Bearing Support Kit	514795S
Crafter 50							
2.0 (80 kw)	2011.05-2016.12		Front;Rear	Chassis cabin RWD CKTB		Center Bearing Support	514807
	2011.05-2016.12		Front;Rear	VAN RWD CKTB		Center Bearing Support	514807
	2011.05-2016.12		Centre	Chassis cabin RWD CKTB		Center Bearing Support Kit	514795S
	2011.05-2016.12		Centre	VAN RWD CKTB		Center Bearing Support Kit	514795S
2.0 (84 kw)	2013.11-2016.12		Front;Rear	VAN RWD CSLB		Center Bearing Support	514807
	2013.11-2016.12		Front;Rear	Chassis cabin RWD CSLB		Center Bearing Support	514807
	2013.11-2016.12		Centre	VAN RWD CSLB		Center Bearing Support Kit	514795S
	2013.11-2016.12		Centre	Chassis cabin RWD CSLB		Center Bearing Support Kit	514795S
2.0 (100 kw)	2011.05-2016.12		Front;Rear	VAN RWD CKTC		Center Bearing Support	514807
	2011.05-2016.12		Front;Rear	Chassis cabin RWD CKTC		Center Bearing Support	514807
	2011.05-2016.12		Centre	VAN RWD CKTC		Center Bearing Support Kit	514795S
	2011.05-2016.12		Centre	Chassis cabin RWD CKTC		Center Bearing Support Kit	514795S
2.0 (105 kw)	2011.10-2016.12		Front;Rear	Chassis cabin RWD CKUC		Center Bearing Support	514807
	2011.10-2016.12		Front;Rear	VAN RWD CKUC		Center Bearing Support	514807
	2011.10-2016.12		Centre	Chassis cabin RWD CKUC		Center Bearing Support Kit	514795S
	2011.10-2016.12		Centre	VAN RWD CKUC		Center Bearing Support Kit	514795S
2.0 (120 kw)	2011.07-2016.12		Front;Rear	Chassis cabin RWD CKUB/CSNA		Center Bearing Support	514807
	2011.07-2016.12		Front;Rear	VAN RWD CKUB/CSNA		Center Bearing Support	514807
	2011.07-2016.12		Centre	Chassis cabin RWD CKUB/CSNA		Center Bearing Support Kit	514795S
	2011.07-2016.12		Centre	VAN RWD CKUB/CSNA		Center Bearing Support Kit	514795S
2.5 (80 kw)	2006.04-2013.05	6MT	Front	Chassis cabin RWD BJK/CEBB	Not For Engine Code:BJK, Wheelbase:4325mm, For PR Code:G0U0R0	Propshaft	PS900365
	2006.04-2013.05	6MT	Front	VAN RWD BJK/CEBB	For Engine Code:CEBB, Wheelbase:4325mm, For PR Code:G0U0R0	Propshaft	PS900365
	2006.04-2013.05	6MT	Front	Chassis cabin RWD BJK/CEBB	For Engine Code:CEBB, Wheelbase:4325mm, For PR Code:G0K0R0	Propshaft	PS900609
	2006.04-2013.05	6MT	Front	VAN RWD BJK/CEBB	For Engine Code:CEBB, Wheelbase:4325mm, For PR Code:G0K0R0	Propshaft	PS900609
	2006.04-2013.05		Rear	Chassis cabin RWD BJK/CEBB	Wheelbase::3665mm	Propshaft	PS900550
	2006.04-2013.05		Rear	VAN RWD BJK/CEBB	Wheelbase::3665mm	Propshaft	PS900550
	2006.04-2013.05		Front;Rear	Chassis cabin RWD BJK/CEBB		Center Bearing Support	514807
	2006.04-2013.05		Front;Rear	VAN RWD BJK/CEBB		Center Bearing Support	514807
	2006.04-2013.05		Centre	Chassis cabin RWD BJK/CEBB		Center Bearing Support Kit	514795S
	2006.04-2013.05		Centre	VAN RWD BJK/CEBB		Center Bearing Support Kit	514795S
2.5 (100 kw)	2006.04-2013.05		Front	Chassis cabin RWD BJL/CECA	For Engine Code:CECA, Wheelbase:4325mm, For PR Code:G0K0R0	Propshaft	PS900609
	2006.04-2013.05		Front	VAN RWD BJL/CECA	For Engine Code:CECA, Wheelbase:4325mm, For PR Code:G0K0R0	Propshaft	PS900609
	2006.04-2013.05	6MT	Front	Chassis cabin RWD BJL/CECA	For Engine Code:CECA, Wheelbase:4325mm, For PR Code:G0U0R0	Propshaft	PS900365
	2006.04-2013.05	6MT	Front	VAN RWD BJL/CECA	For Engine Code:CECA, Wheelbase:4325mm, For PR Code:G0U0R0	Propshaft	PS900365
	2006.04-2013.05		Rear	Chassis cabin RWD BJL/CECA	Wheelbase::3665mm	Propshaft	PS900550
	2006.04-2013.05		Rear	VAN RWD BJL/CECA	Wheelbase:3665 mm	Propshaft	PS900550
	2006.04-2013.05		Front;Rear	Chassis cabin RWD BJL/CECA		Center Bearing Support	514807
	2006.04-2013.05		Front;Rear	VAN RWD BJL/CECA		Center Bearing Support	514807
	2006.04-2013.05		Centre	Chassis cabin RWD BJL/CECA		Center Bearing Support Kit	514795S
	2006.04-2013.05		Centre	VAN RWD BJL/CECA		Center Bearing Support Kit	514795S
2.5 (120 kw)	2006.04-2011.07	6MT	Front	Chassis cabin RWD BJM/CECB	Not For Engine Code:BJM, Wheelbase:4325mm, For PR Code:G0U0R0	Propshaft	PS900365
	2006.04-2011.07	6MT	Front	VAN RWD BJM/CECB	For Engine Code:CECB, Wheelbase:4325mm, For PR Code:G0K0R0	Propshaft	PS900365
	2006.04-2011.07	6MT	Front	Chassis cabin RWD BJM/CECB	Not For Engine Code:BJM, Wheelbase:4325mm, For PR Code:G0K0R0	Propshaft	PS900609
	2006.04-2011.07	6MT	Front	VAN RWD BJM/CECB	For Engine Code:CECB, Wheelbase:4325mm, For PR Code:G0K0R0	Propshaft	PS900609
	2006.04-2011.07		Rear	Chassis cabin RWD BJM/CECB	Wheelbase::3665mm	Propshaft	PS900550
	2006.04-2011.07		Rear	VAN RWD BJM/CECB	Wheelbase::3665mm	Propshaft	PS900550
	2006.04-2011.07		Rear	VAN RWD BJM/CECB	For Engine Code:CECB, wheel base:4325mm	Propshaft	PS900558
	2006.04-2011.07		Front;Rear	Chassis cabin RWD BJM/CECB		Center Bearing Support	514807
	2006.04-2011.07		Front;Rear	VAN RWD BJM/CECB		Center Bearing Support	514807
	2006.04-2011.07		Centre	Chassis cabin RWD BJM/CECB		Center Bearing Support Kit	514795S
	2006.04-2011.07		Centre	VAN RWD BJM/CECB		Center Bearing Support Kit	514795S
	Golf						
1.6 (77 kw)	2012.11-2017.03		Front	Hatchback 4WD CLHA		Flexible Coupling	537626
	2012.11-2017.03		Rear	Hatchback 4WD CLHA		Flexible Coupling	533882
	2012.11-2017.03		Front	Hatchback 4WD CLHA		Flexible Coupling Kit	537626S
	2012.11-2017.03		Rear	Hatchback 4WD CLHA		Flexible Coupling Kit	533882S



	 YEAR	TRANSM.	FITTING POSITION	BODY STYLE & DRIVE TYPE & ENGINE	REMARKS	 PRODUCT	GSP Ref.
VW Golf							
1.6 (81 kw)	2013.01-		Front	Hatchback 4WD CRKB		Flexible Coupling	537626
	2013.01-		Rear	Hatchback 4WD CRKB		Flexible Coupling	533882
	2013.01-		Front	Hatchback 4WD CRKB		Flexible Coupling Kit	537626S
	2013.01-		Rear	Hatchback 4WD CRKB		Flexible Coupling Kit	533882S
1.8 (92 kw)	1998.05-2000.10		Front	Hatchback 4WD AGN		Flexible Coupling	537626
	2017.07-		Front	Estate AWD CXBA/CXBB		Flexible Coupling	537626
1.8 (125 kw)	2017.07-		Rear	Estate AWD CXBA/CXBB		Flexible Coupling	533882
	2017.07-		Front	Estate AWD CXBA/CXBB		Flexible Coupling Kit	537626S
	2017.07-		Rear	Estate AWD CXBA/CXBB		Flexible Coupling Kit	533882S
1.9 (66 kw)	1998.07-2002.04		Front	Hatchback 4WD AGR		Flexible Coupling	537626
1.9 (74 kw)	2000.02-2005.06		Front	Hatchback 4WD ATD		Flexible Coupling	537626
	2000.02-2005.06		Front	Hatchback 4WD ATD		Flexible Coupling Kit	537626S
1.9 (77 kw)	2003.10-2007.07		Front	Hatchback 4WD BKC		Flexible Coupling	537626
	2003.10-2007.07		Rear	Hatchback 4WD BKC		Flexible Coupling	533882
1.9 (85 kw)	2000.01-2001.07		Front	Hatchback 4WD AJM/AUY		Flexible Coupling	537626
	2000.01-2001.07		Front	Hatchback 4WD AJM/AUY		Flexible Coupling Kit	537626S
1.9 (96 kw)	2001.04-2005.06		Front	Hatchback 4WD ASZ		Flexible Coupling	537626
	2001.04-2005.06		Front	Hatchback 4WD ASZ		Flexible Coupling Kit	537626S
1.9 (110 kw)	2001.05-2005.06		Front	Hatchback 4WD ARL		Flexible Coupling	537626
	2001.05-2005.06		Front	Hatchback 4WD ARL		Flexible Coupling Kit	537626S
2.0 (85 kw)	2000.04-2005.06		Front	Hatchback 4WD AZH/AZJ		Flexible Coupling	537626
	2000.04-2005.06		Front	Hatchback 4WD AZH/AZJ		Flexible Coupling Kit	537626S
2.0 (103 kw)	2004.08-2008.11		Front	Hatchback 4WD BKD		Flexible Coupling	537626
	2004.08-2008.11		Rear	Hatchback 4WD BKD		Flexible Coupling	533882
	2007.01-2008.11		Front	Hatchback 4WD BMM		Flexible Coupling	537626
	2007.01-2008.11		Rear	Hatchback 4WD BMM		Flexible Coupling	533882
	2008.10-2012.11		Front	Hatchback 4WD CBAB/CFFB		Flexible Coupling	537626
	2008.10-2012.11		Rear	Hatchback 4WD CBAB/CFFB		Flexible Coupling	533882
2.0 (110 kw)	2005.05-2008.11		Front	Hatchback 4WD BLX/BVX		Flexible Coupling	537626
	2005.05-2008.11		Rear	Hatchback 4WD BLX/BVX		Flexible Coupling	533882
	2012.11-2020.08		Front	Hatchback 4WD CKFC/CRBC/CRLB/CRMB/DCYA		Flexible Coupling	537626
	2012.11-2020.08		Rear	Hatchback 4WD CKFC/CRBC/CRLB/CRMB/DCYA		Flexible Coupling	533882
	2012.11-2020.08		Front	Hatchback 4WD CKFC/CRBC/CRLB/CRMB/DCYA		Flexible Coupling Kit	537626S
	2012.11-2020.08		Rear	Hatchback 4WD CKFC/CRBC/CRLB/CRMB/DCYA		Flexible Coupling Kit	533882S
	2013.05-		Front	Hatchback van 4WD CRBC		Flexible Coupling	537626
	2013.05-		Rear	Hatchback van 4WD CRBC		Flexible Coupling	533882
	2013.05-		Front	Hatchback van 4WD CRBC		Flexible Coupling Kit	537626S
	2013.05-		Rear	Hatchback van 4WD CRBC		Flexible Coupling Kit	533882S
2.0 (188 kw)	2009.11-2012.11		Rear	Hatchback 4WD CDLC		Flexible Coupling	533882
2.0 (195 kw)	2009.11-2011.05		Rear	Hatchback 4WD CDLA		Flexible Coupling	533882
2.0 (199 kw)	2009.11-2012.11		Front	Hatchback 4WD CDLF		Flexible Coupling	537626
	2009.11-2012.11		Rear	Hatchback 4WD CDLF		Flexible Coupling	533882
	2009.11-2012.11		Rear	Hatchback van 4WD CDLF		Flexible Coupling	533882
2.0 (206 kw)	2013.11-		Front	Hatchback 4WD CJXB		Flexible Coupling	537626
	2013.11-		Rear	Hatchback 4WD CJXB		Flexible Coupling	533882
	2013.11-		Front	Hatchback 4WD CJXB		Flexible Coupling Kit	537626S
	2013.11-		Rear	Hatchback 4WD CJXB		Flexible Coupling Kit	533882S
2.0 (213 kw)	2013.11-		Front	Hatchback 4WD CJXD/DJHB/DNUC		Flexible Coupling	537626
	2013.11-		Rear	Hatchback 4WD CJXD/DJHB/DNUC		Flexible Coupling	533882
	2013.11-		Front	Hatchback 4WD CJXD/DJHB/DNUC		Flexible Coupling Kit	537626S
	2013.11-		Rear	Hatchback 4WD CJXD/DJHB/DNUC		Flexible Coupling Kit	533882S
2.0 (215 kw)	2015.01-		Front	Hatchback 4WD CYFB/DLRA		Flexible Coupling	537626
	2015.01-		Rear	Hatchback 4WD CYFB/DLRA		Flexible Coupling	533882
	2015.01-		Front	Hatchback 4WD CYFB/DLRA		Flexible Coupling Kit	537626S
	2015.01-		Rear	Hatchback 4WD CYFB/DLRA		Flexible Coupling Kit	533882S
2.0 (221 kw)	2013.11-		Rear	Hatchback 4WD CJXC/DNUE		Propshaft	PS900585
	2013.11-		Front	Hatchback 4WD CJXC/DNUE		Flexible Coupling	537626
	2013.11-		Rear	Hatchback 4WD CJXC/DNUE		Flexible Coupling	533882
	2013.11-		Front	Hatchback 4WD CJXC/DNUE		Flexible Coupling Kit	537626S
	2013.11-		Rear	Hatchback 4WD CJXC/DNUE		Flexible Coupling Kit	533882S
2.0 (228 kw)	2016.12-		Front	Hatchback 4WD CJXG/DJHA		Flexible Coupling	537626
	2016.12-		Rear	Hatchback 4WD CJXG/DJHA		Flexible Coupling	533882
	2016.12-		Front	Hatchback 4WD CJXG/DJHA		Flexible Coupling Kit	537626S
	2016.12-		Rear	Hatchback 4WD CJXG/DJHA		Flexible Coupling Kit	533882S



	 YEAR	TRANSM.	FITTING POSITION	BODY STYLE & DRIVE TYPE & ENGINE	REMARKS	 PRODUCT	GSP Ref.
VW Golf							
2.0 (265 kw)	2016.09-		Front	Hatchback 4WD CJXC		Flexible Coupling	537626
	2016.09-		Rear	Hatchback 4WD CJXC		Flexible Coupling	533882
	2016.09-		Front	Hatchback 4WD CJXC		Flexible Coupling Kit	537626S
	2016.09-		Rear	Hatchback 4WD CJXC		Flexible Coupling Kit	533882S
2.3 (110 kw)	1998.11-2000.05		Front	Hatchback 4WD AGZ		Flexible Coupling	537626
	1998.11-2000.05		Front	Hatchback 4WD AGZ		Flexible Coupling Kit	537626S
2.3 (125 kw)	2000.09-2005.06		Front	Hatchback 4WD AQN		Flexible Coupling	537626
	2000.09-2005.06		Front	Hatchback 4WD AQN		Flexible Coupling Kit	537626S
2.8 (150 kw)	1999.05-2005.06		Front	Hatchback 4WD AQP/AUE/BDE		Flexible Coupling	537626
	1999.05-2005.06		Front	Hatchback 4WD AQP/AUE/BDE		Flexible Coupling Kit	537626S
3.2 (177 kw)	2002.06-2005.06		Front	Hatchback 4WD BFH/BML		Flexible Coupling	537626
	2002.06-2005.06		Front	Hatchback 4WD BFH/BML		Flexible Coupling Kit	537626S
3.2 (184 kw)	2005.05-2008.11		-	Hatchback 4WD BUB/CBRA		Propshaft	PS900102
	2005.05-2008.11		Front	Hatchback 4WD BUB/CBRA		Flexible Coupling	537626
	2005.05-2008.11		Front	Hatchback 4WD BUB/CBRA		Flexible Coupling Kit	537626S
Golf Alltrack							
1.6 (81 kw)	2014.12-2017.03		Rear	Estate 4WD CRKB/CXXB		Propshaft	PS900585
	2014.12-2017.03		Front	Estate 4WD CRKB/CXXB		Flexible Coupling	537626
	2014.12-2017.03		Rear	Estate 4WD CRKB/CXXB		Flexible Coupling	533882
	2014.12-2017.03		Front	Estate 4WD CRKB/CXXB		Flexible Coupling Kit	537626S
	2014.12-2017.03		Rear	Estate 4WD CRKB/CXXB		Flexible Coupling Kit	533882S
1.8 (132 kw)	2014.12-		Front	Estate 4WD CJSB		Flexible Coupling	537626
	2014.12-		Rear	Estate 4WD CJSB		Flexible Coupling	533882
	2014.12-		Front	Estate 4WD CJSB		Flexible Coupling Kit	537626S
	2014.12-		Rear	Estate 4WD CJSB		Flexible Coupling Kit	533882S
2.0 (110 kw)	2014.12-2018.05		Front	Estate 4WD CRBC/CRLB/DCYA		Flexible Coupling	537626
	2014.12-2018.05		Rear	Estate 4WD CRBC/CRLB/DCYA		Flexible Coupling	533882
	2014.12-2018.05		Front	Estate 4WD CRBC/CRLB/DCYA		Flexible Coupling Kit	537626S
	2014.12-2018.05		Rear	Estate 4WD CRBC/CRLB/DCYA		Flexible Coupling Kit	533882S
2.0 (135 kw)	2014.12-		Front	Estate 4WD CUNA/DGCA/DJGA		Flexible Coupling	537626
	2014.12-		Rear	Estate 4WD CUNA/DGCA/DJGA		Flexible Coupling	533882
	2014.12-		Front	Estate 4WD CUNA/DGCA/DJGA		Flexible Coupling Kit	537626S
	2014.12-		Rear	Estate 4WD CUNA/DGCA/DJGA		Flexible Coupling Kit	533882S
Golf Estate/Variant							
1.6 (77 kw)	2009.07-2013.07		Front	Estate 4WD CAYC		Flexible Coupling	537626
	2009.07-2013.07		Rear	Estate 4WD CAYC		Flexible Coupling	533882
	2013.05-2017.03		Front	Estate 4WD CLHA		Flexible Coupling	537626
	2013.05-2017.03		Rear	Estate 4WD CLHA		Flexible Coupling	533882
	2013.05-2017.03		Front	Estate 4WD CLHA		Flexible Coupling Kit	537626S
	2013.05-2017.03		Rear	Estate 4WD CLHA		Flexible Coupling Kit	533882S
1.6 (81 kw)	2013.05-2017.03		Front	Estate 4WD CRKB		Flexible Coupling	537626
	2013.05-2017.03		Rear	Estate 4WD CRKB		Flexible Coupling	533882
	2013.05-2017.03		Front	Estate 4WD CRKB		Flexible Coupling Kit	537626S
	2013.05-2017.03		Rear	Estate 4WD CRKB		Flexible Coupling Kit	533882S
1.8 (92 kw)	1999.05-2000.10		Front	Estate 4WD AGN		Flexible Coupling	537626
1.8 (132 kw)	2016.11-		Front	Estate 4WD CJSB		Flexible Coupling	537626
	2016.11-		Rear	Estate 4WD CJSB		Flexible Coupling	533882
	2016.11-		Front	Estate 4WD CJSB		Flexible Coupling Kit	537626S
	2016.11-		Rear	Estate 4WD CJSB		Flexible Coupling Kit	533882S
1.9 (66 kw)	1999.05-2002.04		Front	Estate 4WD AGR		Flexible Coupling	537626
1.9 (74 kw)	2000.02-2005.06		Front	Estate 4WD ATD		Flexible Coupling	537626
	2000.02-2005.06		Front	Estate 4WD ATD		Flexible Coupling Kit	537626S
1.9 (77 kw)	2007.12-2009.07		Front	Estate 4WD BLS		Flexible Coupling	537626
1.9 (85 kw)	1999.12-2001.07		Front	Estate 4WD AJM/AUY		Flexible Coupling	537626
	1999.12-2001.07		Front	Estate 4WD AJM/AUY		Flexible Coupling Kit	537626S
1.9 (96 kw)	2001.04-2005.06		Front	Estate 4WD ASZ		Flexible Coupling	537626
	2001.04-2005.06		Front	Estate 4WD ASZ		Flexible Coupling Kit	537626S
2.0 (85 kw)	2000.04-2005.06		Front	Estate 4WD AZH/AZJ		Flexible Coupling	537626
	2000.04-2005.06		Front	Estate 4WD AZH/AZJ		Flexible Coupling Kit	537626S
2.0 (110 kw)	2013.04-2018.05		Front	Estate 4WD CRBC/CRLB/DCYA		Flexible Coupling	537626
	2013.04-2018.05		Rear	Estate 4WD CRBC/CRLB/DCYA		Flexible Coupling	533882
	2013.04-2018.05		Front	Estate 4WD CRBC/CRLB/DCYA		Flexible Coupling Kit	537626S
	2013.04-2018.05		Rear	Estate 4WD CRBC/CRLB/DCYA		Flexible Coupling Kit	533882S



	 YEAR	TRANSM.	FITTING POSITION	BODY STYLE & DRIVE TYPE & ENGINE	REMARKS	 PRODUCT	GSP Ref.
VW							
Golf Estate/Variant							
2.0 (206 kw)	2015.03-2017.03		Front	Estate 4WD CJXB		Flexible Coupling	537626
	2015.03-2017.03		Rear	Estate 4WD CJXB		Flexible Coupling	533882
	2015.03-2017.03		Front	Estate 4WD CJXB		Flexible Coupling Kit	537626S
	2015.03-2017.03		Rear	Estate 4WD CJXB		Flexible Coupling Kit	533882S
2.0 (213 kw)	2016.12-		Front	Estate 4WD CJXD/DJHB/DNUC		Flexible Coupling	537626
	2016.12-		Rear	Estate 4WD CJXD/DJHB/DNUC		Flexible Coupling	533882
	2016.12-		Front	Estate 4WD CJXD/DJHB/DNUC		Flexible Coupling Kit	537626S
	2016.12-		Rear	Estate 4WD CJXD/DJHB/DNUC		Flexible Coupling Kit	533882S
2.0 (221 kw)	2015.03-		Front	Estate 4WD CJXC/DNUE		Flexible Coupling	537626
	2015.03-		Rear	Estate 4WD CJXC/DNUE		Flexible Coupling	533882
	2015.03-		Front	Estate 4WD CJXC/DNUE		Flexible Coupling Kit	537626S
	2015.03-		Rear	Estate 4WD CJXC/DNUE		Flexible Coupling Kit	533882S
2.0 (228 kw)	2016.12-		Front	Estate 4WD CJXG/DJHA		Flexible Coupling	537626
	2016.12-		Rear	Estate 4WD CJXG/DJHA		Flexible Coupling	533882
	2016.12-		Front	Estate 4WD CJXG/DJHA		Flexible Coupling Kit	537626S
	2016.12-		Rear	Estate 4WD CJXG/DJHA		Flexible Coupling Kit	533882S
2.0 (265 kw)	2016.09-		Front	Estate 4WD CJXC		Flexible Coupling	537626
	2016.09-		Rear	Estate 4WD CJXC		Flexible Coupling	533882
	2016.09-		Front	Estate 4WD CJXC		Flexible Coupling Kit	537626S
	2016.09-		Rear	Estate 4WD CJXC		Flexible Coupling Kit	533882S
2.3 (110 kw)	1999.05-2001.02		Front	Estate 4WD AGZ		Flexible Coupling	537626
	1999.05-2001.02		Front	Estate 4WD AGZ		Flexible Coupling Kit	537626S
2.3 (125 kw)	2000.09-2005.06		Front	Estate 4WD AQN		Flexible Coupling	537626
	2000.09-2005.06		Front	Estate 4WD AQN		Flexible Coupling Kit	537626S
2.8 (150 kw)	1999.05-2005.06		Front	Estate 4WD AQP/AUE/BDE		Flexible Coupling	537626
	1999.05-2005.06		Front	Estate 4WD AQP/AUE/BDE		Flexible Coupling Kit	537626S
Golf Van (Hatchback)							
1.9 (85 kw)	2000.01-2001.04		Front	Hatchback van 4WD AUY		Flexible Coupling	537626
	2000.01-2001.04		Front	Hatchback van 4WD AUY		Flexible Coupling Kit	537626S
Golf Van (Variant)							
1.6 (77 kw)	2013.05-2017.03		Front	Combi van 4WD CLHA		Flexible Coupling	537626
	2013.05-2017.03		Rear	Combi van 4WD CLHA		Flexible Coupling	533882
	2013.05-2017.03		Front	Combi van 4WD CLHA		Flexible Coupling Kit	537626S
	2013.05-2017.03		Rear	Combi van 4WD CLHA		Flexible Coupling Kit	533882S
2.0 (110 kw)	2013.04-2017.03		Front	Combi van 4WD CRBC/CRLB		Flexible Coupling	537626
	2013.04-2017.03		Rear	Combi van 4WD CRBC/CRLB		Flexible Coupling	533882
	2013.04-2017.03		Front	Combi van 4WD CRBC/CRLB		Flexible Coupling Kit	537626S
	2013.04-2017.03		Rear	Combi van 4WD CRBC/CRLB		Flexible Coupling Kit	533882S
LT 28							
2.3 (105 kw)	1996.05-2001.11		-	BUS RWD AGL	Date To:2001.11,wheel base:4025 mm	Propshaft	PS900371
	1996.05-2001.11		-	Chassis cabin RWD AGL	Date To:2001.11,wheel base:4025 mm	Propshaft	PS900371
	1996.05-2001.11		-	VAN RWD AGL	Date To:2001.11,wheel base:4025 mm	Propshaft	PS900371
	1996.05-2001.11		Centre	BUS RWD AGL		Center Bearing Support	510503
	1996.05-2001.11		Centre	Chassis cabin RWD AGL		Center Bearing Support	510503
	1996.05-2001.11		Centre	VAN RWD AGL		Center Bearing Support	510503
	1996.05-2001.11		Centre	BUS RWD AGL		Center Bearing Support Kit	531028S
	1996.05-2001.11		Centre	Chassis cabin RWD AGL		Center Bearing Support Kit	531028S
	1996.05-2001.11		Centre	VAN RWD AGL		Center Bearing Support Kit	531028S
2.5 (55 kw)	1996.07-2001.04		Front	BUS RWD AGX	Date To:2001.04,wheel base:4025 mm	Propshaft	PS900568
	1996.07-2001.04		Front	Chassis cabin RWD AGX	Date To:2001.04,wheel base:4025 mm	Propshaft	PS900568
	1996.07-2001.04		Front	VAN RWD AGX	Date To:2001.04,wheel base:4025 mm	Propshaft	PS900568
	1996.07-2001.04		-	BUS RWD AGX	Date To:2001.04,Wheelbase:3550 mm,for OE No.:2D0521101AM	Propshaft	PS900373
	1996.07-2001.04		-	Chassis cabin RWD AGX	Date To:2001.04,Wheelbase:3550 mm,for OE No.:2D0521101AM	Propshaft	PS900373
	1996.07-2001.04		-	VAN RWD AGX	Date To:2001.04,Wheelbase:3550 mm,for OE No.:2D0521101AM	Propshaft	PS900373
	1996.07-2001.04		Centre	BUS RWD AGX		Center Bearing Support	510503
	1996.07-2001.04		Centre	Chassis cabin RWD AGX		Center Bearing Support	510503
	1996.07-2001.04		Centre	VAN RWD AGX		Center Bearing Support	510503
	1996.07-2001.04		Centre	BUS RWD AGX		Center Bearing Support Kit	531028S
	1996.07-2001.04		Centre	Chassis cabin RWD AGX		Center Bearing Support Kit	531028S
	1996.07-2001.04		Centre	VAN RWD AGX		Center Bearing Support Kit	531028S
2.5 (61 kw)	2001.04-2006.07		Front	BUS RWD BBE	wheel base:4025 mm	Propshaft	PS900568
	2001.04-2006.07		-	BUS RWD BBE	Wheelbase:3550 mm,for OE No.:2D0521101AM	Propshaft	PS900373
	2001.04-2006.07		Centre	BUS RWD BBE		Center Bearing Support	510503
	2001.04-2006.07		Centre	BUS RWD BBE		Center Bearing Support Kit	531028S



	 YEAR	TRANSM.	FITTING POSITION	BODY STYLE & DRIVE TYPE & ENGINE	REMARKS	 PRODUCT	GSP Ref.
VW LT 28							
2.5 (61 kw)	2001.05-2006.06		Front	VAN RWD BBE	wheel base:4025 mm	Propshaft	PS900568
	2001.05-2006.06		Front	Chassis cabin RWD BBE	wheel base:4025 mm	Propshaft	PS900568
	2001.05-2006.06		-	VAN RWD BBE	Wheelbase:3550 mm,for OE No.:2D0521101AM	Propshaft	PS900373
	2001.05-2006.06		-	Chassis cabin RWD BBE	Wheelbase:3550 mm,for OE No.:2D0521101AM	Propshaft	PS900373
	2001.05-2006.06		Centre	VAN RWD BBE		Center Bearing Support	510503
	2001.05-2006.06		Centre	Chassis cabin RWD BBE		Center Bearing Support	510503
	2001.05-2006.06		Centre	VAN RWD BBE		Center Bearing Support Kit	531028S
	2001.05-2006.06		Centre	Chassis cabin RWD BBE		Center Bearing Support Kit	531028S
2.5 (66 kw)	1999.05-2001.04		Front	Chassis cabin RWD APA	Date To:2001.04, wheel base:4025 mm	Propshaft	PS900568
	1999.05-2001.04		-	Chassis cabin RWD APA	Date To:2001.04,Wheelbase:3550 mm,for OE No.:2D0521101AM	Propshaft	PS900373
	1999.05-2001.04		Centre	Chassis cabin RWD APA		Center Bearing Support	510503
	1999.05-2001.04		Centre	Chassis cabin RWD APA		Center Bearing Support Kit	531028S
	1999.05-2003.05		-	BUS RWD APA	Date To:2003.05,Wheelbase:3550 mm,for OE No.:2D0521101AM	Propshaft	PS900373
	1999.05-2003.05		-	VAN RWD APA	Date To:2003.05,Wheelbase:3550 mm,for OE No.:2D0521101AM	Propshaft	PS900373
	1999.05-2003.05		Centre	BUS RWD APA		Center Bearing Support	510503
	1999.05-2003.05		Centre	VAN RWD APA		Center Bearing Support	510503
	1999.05-2003.05		Centre	BUS RWD APA		Center Bearing Support Kit	531028S
	1999.05-2003.05		Centre	VAN RWD APA		Center Bearing Support Kit	531028S
2.5 (70 kw)	2001.05-2006.06		Front	BUS RWD BBF	wheel base:4025 mm	Propshaft	PS900568
	2001.05-2006.06		Front	VAN RWD BBF	wheel base:4025 mm	Propshaft	PS900568
	2001.05-2006.06		-	BUS RWD BBF	Wheelbase:3550 mm,for OE No.:2D0521101AM	Propshaft	PS900373
	2001.05-2006.06		-	VAN RWD BBF	Wheelbase:3550 mm,for OE No.:2D0521101AM	Propshaft	PS900373
	2001.05-2006.06		Centre	BUS RWD BBF		Center Bearing Support	510503
	2001.05-2006.06		Centre	VAN RWD BBF		Center Bearing Support	510503
	2001.05-2006.06		Centre	BUS RWD BBF		Center Bearing Support Kit	531028S
	2001.05-2006.06		Centre	VAN RWD BBF		Center Bearing Support Kit	531028S
	2001.05-2006.07		Front	Chassis cabin RWD BBF	wheel base:4025 mm	Propshaft	PS900568
	2001.05-2006.07		-	Chassis cabin RWD BBF	Wheelbase:3550 mm,for OE No.:2D0521101AM	Propshaft	PS900373
	2001.05-2006.07		Centre	Chassis cabin RWD BBF		Center Bearing Support	510503
	2001.05-2006.07		Centre	Chassis cabin RWD BBF		Center Bearing Support Kit	531028S
2.5 (75 kw)	1996.05-1999.05		Front	BUS RWD AHD	Date To:1999.05, wheel base:4025 mm	Propshaft	PS900568
	1996.05-1999.05		Front	Chassis cabin RWD AHD	Date To:1999.05, wheel base:4025 mm	Propshaft	PS900568
	1996.05-1999.05		Front	VAN RWD AHD	Date To:1999.05, wheel base:4025 mm	Propshaft	PS900568
	1996.05-1999.05		-	BUS RWD AHD	Date To:1999.05,Wheelbase:3550 mm,for OE No.:2D0521101AM	Propshaft	PS900373
	1996.05-1999.05		-	Chassis cabin RWD AHD	Date To:1999.05,Wheelbase:3550 mm,for OE No.:2D0521101AM	Propshaft	PS900373
	1996.05-1999.05		-	VAN RWD AHD	Date To:1999.05,Wheelbase:3550 mm,for OE No.:2D0521101AM	Propshaft	PS900373
	1996.05-1999.05		Centre	BUS RWD AHD		Center Bearing Support	510503
	1996.05-1999.05		Centre	Chassis cabin RWD AHD		Center Bearing Support	510503
	1996.05-1999.05		Centre	VAN RWD AHD		Center Bearing Support	510503
	1996.05-1999.05		Centre	BUS RWD AHD		Center Bearing Support Kit	531028S
	1996.05-1999.05		Centre	Chassis cabin RWD AHD		Center Bearing Support Kit	531028S
	1996.05-1999.05		Centre	VAN RWD AHD		Center Bearing Support Kit	531028S
	2.5 (80 kw)	1996.05-2006.06		Front	Chassis cabin RWD ANJ/AVR	wheel base:4025 mm	Propshaft
1996.05-2006.06			-	Chassis cabin RWD ANJ/AVR	Wheelbase:3550 mm,for OE No.:2D0521101AM	Propshaft	PS900373
1996.05-2006.06			-	VAN RWD ANJ/AVR	Wheelbase:3550 mm,for OE No.:2D0521101AM	Propshaft	PS900373
1996.05-2006.06			Centre	Chassis cabin RWD ANJ/AVR		Center Bearing Support	510503
1996.05-2006.06			Centre	VAN RWD ANJ/AVR		Center Bearing Support	510503
1996.05-2006.06			Centre	Chassis cabin RWD ANJ/AVR		Center Bearing Support Kit	531028S
1996.05-2006.06			Centre	VAN RWD ANJ/AVR		Center Bearing Support Kit	531028S
1999.05-2006.06			-	BUS RWD ANJ	Wheelbase:3550 mm,for OE No.:2D0521101AM	Propshaft	PS900373
1999.05-2006.06			Centre	BUS RWD ANJ		Center Bearing Support	510503
1999.05-2006.06			Centre	BUS RWD ANJ		Center Bearing Support Kit	531028S
2.8 (92 kw)		1997.07-2002.01		Centre	Chassis cabin RWD AGK		Center Bearing Support
	1997.07-2002.01		Centre	VAN RWD AGK		Center Bearing Support	510503
	1997.07-2002.01		Centre	Chassis cabin RWD AGK		Center Bearing Support Kit	531028S
	1997.07-2002.01		Centre	VAN RWD AGK		Center Bearing Support Kit	531028S
	1997.07-2003.05		Centre	BUS RWD AGK		Center Bearing Support	510503
	1997.07-2003.05		Centre	BUS RWD AGK		Center Bearing Support Kit	531028S
2.8 (96 kw)	1997.07-2002.01		Centre	Chassis cabin RWD ATA		Center Bearing Support	510503
	1997.07-2002.01		Centre	VAN RWD ATA		Center Bearing Support	510503
	1997.07-2002.01		Centre	Chassis cabin RWD ATA		Center Bearing Support Kit	531028S
	1997.07-2002.01		Centre	VAN RWD ATA		Center Bearing Support Kit	531028S
2.8 (116 kw)	2002.02-2006.07		Centre	Chassis cabin RWD AUH		Center Bearing Support	510503
	2002.02-2006.07		Centre	VAN RWD AUH		Center Bearing Support	510503



	 YEAR	TRANSM.	FITTING POSITION	BODY STYLE & DRIVE TYPE & ENGINE	REMARKS	 PRODUCT	GSP Ref.	
VW								
LT 28								
2.8 (116 kw)	2002.02-2006.07		Centre	Chassis cabin RWD AUH		Center Bearing Support Kit	531028S	
	2002.02-2006.07		Centre	VAN RWD AUH		Center Bearing Support Kit	531028S	
	2002.05-2006.06		Centre	BUS RWD BCQ		Center Bearing Support	510503	
	2002.05-2006.06		Centre	BUS RWD BCQ		Center Bearing Support Kit	531028S	
LT 32								
2.5 (61 kw)	2001.05-2003.05		Front	VAN RWD BBE	Date To:2003.05,wheel base:4025 mm	Propshaft	PS900568	
	2001.05-2003.05		-	VAN RWD BBE	Date To:2003.05,Wheelbase:3550 mm,for OE No.:2D0521101AM	Propshaft	PS900373	
	2001.05-2003.05		Centre	VAN RWD BBE		Center Bearing Support	510503	
	2001.05-2003.05		Centre	VAN RWD BBE		Center Bearing Support Kit	531028S	
2.5 (70 kw)	2001.05-2003.05		Front	VAN RWD BBF	Date To:2003.05,wheel base:4025 mm	Propshaft	PS900568	
	2001.05-2003.05		-	VAN RWD BBF	Date To:2003.05,Wheelbase:3550 mm,for OE No.:2D0521101AM	Propshaft	PS900373	
	2001.05-2003.05		Centre	VAN RWD BBF		Center Bearing Support	510503	
	2001.05-2003.05		Centre	VAN RWD BBF		Center Bearing Support Kit	531028S	
2.5 (80 kw)	1996.05-2006.06		-	VAN RWD ANJ/AVR	Wheelbase:3550 mm,for OE No.:2D0521101AM	Propshaft	PS900373	
	1996.05-2006.06		Centre	VAN RWD ANJ/AVR		Center Bearing Support	510503	
	1996.05-2006.06		Centre	VAN RWD ANJ/AVR		Center Bearing Support Kit	531028S	
2.8 (116 kw)	2003.06-2006.06		Centre	VAN RWD BCQ		Center Bearing Support	510503	
	2003.06-2006.06		Centre	VAN RWD BCQ		Center Bearing Support Kit	531028S	
LT 35								
2.3 (105 kw)	1996.05-2001.11		-	BUS RWD AGL	Date To:2001.11,wheel base:4025 mm	Propshaft	PS900371	
	1996.05-2001.11		-	Chassis cabin RWD AGL	Date To:2001.11,wheel base:4025 mm	Propshaft	PS900371	
	1996.05-2001.11		-	VAN RWD AGL	Date To:2001.11,wheel base:4025 mm	Propshaft	PS900371	
	1996.05-2001.11		Centre	BUS RWD AGL		Center Bearing Support	510503	
	1996.05-2001.11		Centre	Chassis cabin RWD AGL		Center Bearing Support	510503	
	1996.05-2001.11		Centre	VAN RWD AGL		Center Bearing Support	510503	
	1996.05-2001.11		Centre	BUS RWD AGL		Center Bearing Support Kit	531028S	
	1996.05-2001.11		Centre	Chassis cabin RWD AGL		Center Bearing Support Kit	531028S	
	1996.05-2001.11		Centre	VAN RWD AGL		Center Bearing Support Kit	531028S	
2.5 (55 kw)	1996.07-2001.04		Front	BUS RWD AGX	Date To:2001.04,wheel base:4025 mm	Propshaft	PS900568	
	1996.07-2001.04		Front	Chassis cabin RWD AGX	Date To:2001.04,wheel base:4025 mm	Propshaft	PS900568	
	1996.07-2001.04		Front	VAN RWD AGX	Date To:2001.04,wheel base:4025 mm	Propshaft	PS900568	
	1996.07-2001.04		-	BUS RWD AGX	Date To:2001.04,Wheelbase:3550 mm,for OE No.:2D0521101AM	Propshaft	PS900373	
	1996.07-2001.04		-	Chassis cabin RWD AGX	Date To:2001.04,Wheelbase:3550 mm,for OE No.:2D0521101AM	Propshaft	PS900373	
	1996.07-2001.04		-	VAN RWD AGX	Date To:2001.04,Wheelbase:3550 mm,for OE No.:2D0521101AM	Propshaft	PS900373	
	1996.07-2001.04		Centre	BUS RWD AGX		Center Bearing Support	510503	
	1996.07-2001.04		Centre	Chassis cabin RWD AGX		Center Bearing Support	510503	
	1996.07-2001.04		Centre	VAN RWD AGX		Center Bearing Support	510503	
	1996.07-2001.04		Centre	BUS RWD AGX		Center Bearing Support Kit	531028S	
	1996.07-2001.04		Centre	Chassis cabin RWD AGX		Center Bearing Support Kit	531028S	
	1996.07-2001.04		Centre	VAN RWD AGX		Center Bearing Support Kit	531028S	
	2.5 (61 kw)	2001.05-2006.06		Front	BUS RWD BBE	wheel base:4025 mm	Propshaft	PS900568
		2001.05-2006.06		Front	VAN RWD BBE	wheel base:4025 mm	Propshaft	PS900568
2001.05-2006.06			-	BUS RWD BBE	Wheelbase:3550 mm,for OE No.:2D0521101AM	Propshaft	PS900373	
2001.05-2006.06			-	VAN RWD BBE	Wheelbase:3550 mm,for OE No.:2D0521101AM	Propshaft	PS900373	
2001.05-2006.06			Centre	BUS RWD BBE		Center Bearing Support	510503	
2001.05-2006.06			Centre	VAN RWD BBE		Center Bearing Support	510503	
2001.05-2006.06			Centre	BUS RWD BBE		Center Bearing Support Kit	531028S	
2001.05-2006.06			Centre	VAN RWD BBE		Center Bearing Support Kit	531028S	
2001.05-2006.07			Front	Chassis cabin RWD BBE	wheel base:4025 mm	Propshaft	PS900568	
2001.05-2006.07			-	Chassis cabin RWD BBE	Wheelbase:3550 mm,for OE No.:2D0521101AM	Propshaft	PS900373	
2001.05-2006.07			Centre	Chassis cabin RWD BBE		Center Bearing Support	510503	
2001.05-2006.07			Centre	Chassis cabin RWD BBE		Center Bearing Support Kit	531028S	
2.5 (66 kw)		1999.05-2001.04		Front	Chassis cabin RWD APA	Date To:2001.04,wheel base:4025 mm	Propshaft	PS900568
		1999.05-2001.04		-	Chassis cabin RWD APA	Date To:2001.04,Wheelbase:3550 mm,for OE No.:2D0521101AM	Propshaft	PS900373
	1999.05-2001.04		Centre	Chassis cabin RWD APA		Center Bearing Support	510503	
	1999.05-2001.04		Centre	Chassis cabin RWD APA		Center Bearing Support Kit	531028S	
	1999.05-2003.05		-	BUS RWD APA	Date To:2003.05,Wheelbase:3550 mm,for OE No.:2D0521101AM	Propshaft	PS900373	
	1999.05-2003.05		-	VAN RWD APA	Date To:2003.05,Wheelbase:3550 mm,for OE No.:2D0521101AM	Propshaft	PS900373	
	1999.05-2003.05		Centre	BUS RWD APA		Center Bearing Support	510503	
	1999.05-2003.05		Centre	VAN RWD APA		Center Bearing Support	510503	
	1999.05-2003.05		Centre	BUS RWD APA		Center Bearing Support Kit	531028S	
	1999.05-2003.05		Centre	VAN RWD APA		Center Bearing Support Kit	531028S	
	2.5 (70 kw)	2001.05-2006.06		Front	BUS RWD BBF	wheel base:4025 mm	Propshaft	PS900568
		2001.05-2006.06		Front	VAN RWD BBF	wheel base:4025 mm	Propshaft	PS900568



	 YEAR	TRANSM.	FITTING POSITION	BODY STYLE & DRIVE TYPE & ENGINE	REMARKS	 PRODUCT	GSP Ref.
VW							
LT 35							
2.5 (70 kw)	2001.05-2006.06		-	BUS RWD BBF	Wheelbase:3550 mm,for OE No.:2D0521101AM	Propshaft	PS900373
	2001.05-2006.06		-	VAN RWD BBF	Wheelbase:3550 mm,for OE No.:2D0521101AM	Propshaft	PS900373
	2001.05-2006.06		Centre	BUS RWD BBF		Center Bearing Support	510503
	2001.05-2006.06		Centre	VAN RWD BBF		Center Bearing Support	510503
	2001.05-2006.06		Centre	BUS RWD BBF		Center Bearing Support Kit	531028S
	2001.05-2006.06		Centre	VAN RWD BBF		Center Bearing Support Kit	531028S
	2001.05-2006.07		Front	Chassis cabin RWD BBF	wheel base:4025 mm	Propshaft	PS900568
	2001.05-2006.07		-	Chassis cabin RWD BBF	Wheelbase:3550 mm,for OE No.:2D0521101AM	Propshaft	PS900373
	2001.05-2006.07		Centre	Chassis cabin RWD BBF		Center Bearing Support	510503
	2001.05-2006.07		Centre	Chassis cabin RWD BBF		Center Bearing Support Kit	531028S
2.5 (75 kw)	1996.05-1999.05		Front	BUS RWD AHD	Date To:1999.05,wheel base:4025 mm	Propshaft	PS900568
	1996.05-1999.05		Front	Chassis cabin RWD AHD	Date To:1999.05,wheel base:4025 mm	Propshaft	PS900568
	1996.05-1999.05		Front	VAN RWD AHD	Date To:1999.05,wheel base:4025 mm	Propshaft	PS900568
	1996.05-1999.05		-	BUS RWD AHD	Date To:1999.05,Wheelbase:3550 mm,for OE No.:2D0521101AM	Propshaft	PS900373
	1996.05-1999.05		-	Chassis cabin RWD AHD	Date To:1999.05,Wheelbase:3550 mm,for OE No.:2D0521101AM	Propshaft	PS900373
	1996.05-1999.05		-	VAN RWD AHD	Date To:1999.05,Wheelbase:3550 mm,for OE No.:2D0521101AM	Propshaft	PS900373
	1996.05-1999.05		Centre	BUS RWD AHD		Center Bearing Support	510503
	1996.05-1999.05		Centre	Chassis cabin RWD AHD		Center Bearing Support	510503
	1996.05-1999.05		Centre	VAN RWD AHD		Center Bearing Support	510503
	1996.05-1999.05		Centre	BUS RWD AHD		Center Bearing Support Kit	531028S
	1996.05-1999.05		Centre	Chassis cabin RWD AHD		Center Bearing Support Kit	531028S
	1996.05-1999.05		Centre	VAN RWD AHD		Center Bearing Support Kit	531028S
2.5 (80 kw)	1996.05-2006.06		Front	Chassis cabin RWD ANJ/AVR	wheel base:4025 mm	Propshaft	PS900568
	1996.05-2006.06		-	BUS RWD ANJ/AVR	Wheelbase:3550 mm,for OE No.:2D0521101AM	Propshaft	PS900373
	1996.05-2006.06		-	Chassis cabin RWD ANJ/AVR	Wheelbase:3550 mm,for OE No.:2D0521101AM	Propshaft	PS900373
	1996.05-2006.06		-	VAN RWD ANJ/AVR	Wheelbase:3550 mm,for OE No.:2D0521101AM	Propshaft	PS900373
	1996.05-2006.06		Centre	BUS RWD ANJ/AVR		Center Bearing Support	510503
	1996.05-2006.06		Centre	Chassis cabin RWD ANJ/AVR		Center Bearing Support	510503
	1996.05-2006.06		Centre	VAN RWD ANJ/AVR		Center Bearing Support	510503
	1996.05-2006.06		Centre	BUS RWD ANJ/AVR		Center Bearing Support Kit	531028S
	1996.05-2006.06		Centre	Chassis cabin RWD ANJ/AVR		Center Bearing Support Kit	531028S
	1996.05-2006.06		Centre	VAN RWD ANJ/AVR		Center Bearing Support Kit	531028S
2.8 (92 kw)	1997.07-2002.01		Centre	Chassis cabin RWD AGK		Center Bearing Support	510503
	1997.07-2002.01		Centre	VAN RWD AGK		Center Bearing Support	510503
	1997.07-2002.01		Centre	Chassis cabin RWD AGK		Center Bearing Support Kit	531028S
	1997.07-2002.01		Centre	VAN RWD AGK		Center Bearing Support Kit	531028S
	1997.07-2003.05		Centre	BUS RWD AGK		Center Bearing Support	510503
	1997.07-2003.05		Centre	BUS RWD AGK		Center Bearing Support Kit	531028S
2.8 (96 kw)	1997.07-2002.01		Centre	BUS RWD ATA		Center Bearing Support	510503
	1997.07-2002.01		Centre	Chassis cabin RWD ATA		Center Bearing Support	510503
	1997.07-2002.01		Centre	VAN RWD ATA		Center Bearing Support	510503
	1997.07-2002.01		Centre	BUS RWD ATA		Center Bearing Support Kit	531028S
	1997.07-2002.01		Centre	Chassis cabin RWD ATA		Center Bearing Support Kit	531028S
	1997.07-2002.01		Centre	VAN RWD ATA		Center Bearing Support Kit	531028S
2.8 (116 kw)	2002.02-2006.07		Centre	Chassis cabin RWD AUH		Center Bearing Support	510503
	2002.02-2006.07		Centre	VAN RWD AUH		Center Bearing Support	510503
	2002.02-2006.07		Centre	Chassis cabin RWD AUH		Center Bearing Support Kit	531028S
	2002.02-2006.07		Centre	VAN RWD AUH		Center Bearing Support Kit	531028S
	2002.05-2006.06		Centre	BUS RWD AUH/BCQ		Center Bearing Support	510503
	2002.05-2006.06		Centre	BUS RWD AUH/BCQ		Center Bearing Support Kit	531028S
LT 46							
2.3 (105 kw)	1996.12-2001.11		-	Chassis cabin RWD AGL	Date From:1996.12 to 2001.11,wheel base:4025 mm	Propshaft	PS900371
	1996.12-2001.11		-	VAN RWD AGL	Date From:1996.12 to 2001.11,wheel base:4025 mm	Propshaft	PS900371
	1996.12-2001.11		Centre	Chassis cabin RWD AGL		Center Bearing Support	510503
	1996.12-2001.11		Centre	VAN RWD AGL		Center Bearing Support	510503
	1996.12-2001.11		Centre	Chassis cabin RWD AGL		Center Bearing Support Kit	531028S
	1996.12-2001.11		Centre	VAN RWD AGL		Center Bearing Support Kit	531028S
2.5 (61 kw)	2004.01-2006.07		Front	Chassis cabin RWD BBE	Date From:2004.01,wheel base:4025 mm	Propshaft	PS900568
	2004.01-2006.07		-	Chassis cabin RWD BBE	Date From:2004.01,Wheelbase:3550 mm,for OE No.:2D0521101AM	Propshaft	PS900373
	2004.01-2006.07		Centre	Chassis cabin RWD BBE		Center Bearing Support	510503
	2004.01-2006.07		Centre	Chassis cabin RWD BBE		Center Bearing Support Kit	531028S
2.5 (66 kw)	1999.05-2001.04		Front	Chassis cabin RWD APA	Date To:2001.04,wheel base:4025 mm	Propshaft	PS900568
	1999.05-2001.04		-	Chassis cabin RWD APA	Date To:2001.04,Wheelbase:3550 mm,for OE No.:2D0521101AM	Propshaft	PS900373
	1999.05-2001.04		Centre	Chassis cabin RWD APA		Center Bearing Support	510503



	 YEAR	TRANSM.	FITTING POSITION	BODY STYLE & DRIVE TYPE & ENGINE	REMARKS	 PRODUCT	GSP Ref.
VW							
LT 46							
2.5 (66 kw)	1999.05-2001.04		Centre	Chassis cabin RWD APA		Center Bearing Support Kit	531028S
	1999.05-2003.05		-	VAN RWD APA	Date To:2003.05,Wheelbase:3550 mm,for OE No.:2D0521101AM	Propshaft	PS900373
	1999.05-2003.05		Centre	VAN RWD APA		Center Bearing Support	510503
	1999.05-2003.05		Centre	VAN RWD APA		Center Bearing Support Kit	531028S
2.5 (70 kw)	2001.04-2006.07		Front	Chassis cabin RWD BBF	wheel base:4025 mm	Propshaft	PS900568
	2001.04-2006.07		-	Chassis cabin RWD BBF	Wheelbase:3550 mm,for OE No.:2D0521101AM	Propshaft	PS900373
	2001.04-2006.07		Centre	Chassis cabin RWD BBF		Center Bearing Support	510503
	2001.04-2006.07		Centre	Chassis cabin RWD BBF		Center Bearing Support Kit	531028S
	2001.05-2006.06		Front	VAN RWD BBF	wheel base:4025 mm	Propshaft	PS900568
	2001.05-2006.06		-	VAN RWD BBF	Wheelbase:3550 mm,for OE No.:2D0521101AM	Propshaft	PS900373
	2001.05-2006.06		Centre	VAN RWD BBF		Center Bearing Support	510503
	2001.05-2006.06		Centre	VAN RWD BBF		Center Bearing Support Kit	531028S
2.5 (75 kw)	1996.05-1999.05		Front	Chassis cabin RWD AHD	Date To:1999.05,wheel base:4025 mm	Propshaft	PS900568
	1996.05-1999.05		Front	VAN RWD AHD	Date To:1999.05,wheel base:4025 mm	Propshaft	PS900568
	1996.05-1999.05		-	Chassis cabin RWD AHD	Date To:1999.05,Wheelbase:3550 mm,for OE No.:2D0521101AM	Propshaft	PS900373
	1996.05-1999.05		-	VAN RWD AHD	Date To:1999.05,Wheelbase:3550 mm,for OE No.:2D0521101AM	Propshaft	PS900373
	1996.05-1999.05		Centre	Chassis cabin RWD AHD		Center Bearing Support	510503
	1996.05-1999.05		Centre	VAN RWD AHD		Center Bearing Support	510503
	1996.05-1999.05		Centre	Chassis cabin RWD AHD		Center Bearing Support Kit	531028S
	1996.05-1999.05		Centre	VAN RWD AHD		Center Bearing Support Kit	531028S
2.5 (80 kw)	1996.05-2006.06		-	VAN RWD ANJ/AVR	Wheelbase:3550 mm,for OE No.:2D0521101AM	Propshaft	PS900373
	1996.05-2006.06		Centre	VAN RWD ANJ/AVR		Center Bearing Support	510503
	1996.05-2006.06		Centre	VAN RWD ANJ/AVR		Center Bearing Support Kit	531028S
	1996.05-2006.07		Front	Chassis cabin RWD ANJ/AVR	wheel base:4025 mm	Propshaft	PS900568
	1996.05-2006.07		-	Chassis cabin RWD ANJ/AVR	Wheelbase:3550 mm,for OE No.:2D0521101AM	Propshaft	PS900373
	1996.05-2006.07		Centre	Chassis cabin RWD ANJ/AVR		Center Bearing Support	510503
	1996.05-2006.07		Centre	Chassis cabin RWD ANJ/AVR		Center Bearing Support Kit	531028S
2.8 (92 kw)	1997.07-2002.01		Centre	Chassis cabin RWD AGK		Center Bearing Support	510503
	1997.07-2002.01		Centre	VAN RWD AGK		Center Bearing Support	510503
	1997.07-2002.01		Centre	Chassis cabin RWD AGK		Center Bearing Support Kit	531028S
	1997.07-2002.01		Centre	VAN RWD AGK		Center Bearing Support Kit	531028S
2.8 (96 kw)	1997.07-2002.01		Centre	VAN RWD ATA		Center Bearing Support	510503
	1997.07-2002.01		Centre	Chassis cabin RWD ATA		Center Bearing Support	510503
	1997.07-2002.01		Centre	VAN RWD ATA		Center Bearing Support Kit	531028S
	1997.07-2002.01		Centre	Chassis cabin RWD ATA		Center Bearing Support Kit	531028S
2.8 (116 kw)	2002.02-2006.07		Centre	VAN RWD AUH		Center Bearing Support	510503
	2002.02-2006.07		Centre	Chassis cabin RWD AUH		Center Bearing Support	510503
	2002.02-2006.07		Centre	VAN RWD AUH		Center Bearing Support Kit	531028S
	2002.02-2006.07		Centre	Chassis cabin RWD AUH		Center Bearing Support Kit	531028S
Multivan							
1.9 (50 kw)	1994.07-2003.04		Centre	BUS FWD ABL		Center Bearing Support	514801
1.9 (62 kw)	2006.01-2009.11		Centre	BUS FWD BRR		Center Bearing Support	514809
1.9 (63 kw)	2005.06-2009.11		Centre	BUS FWD AXC		Center Bearing Support	514809
1.9 (75 kw)	2006.01-2009.11		Centre	BUS FWD BRS		Center Bearing Support	514809
1.9 (77 kw)	2003.04-2009.11		Centre	BUS FWD AXB		Center Bearing Support	514809
2.0 (62 kw)	1992.08-2003.04		Centre	BUS FWD AAC		Center Bearing Support	514801
	2009.09-2015.11		Centre	BUS FWD CAAA		Center Bearing Support	514809
2.0 (75 kw)	2009.09-2015.11		Centre	BUS FWD CAAB		Center Bearing Support	514809
	2011.05-2015.08		Centre	BUS FWD CAAD		Center Bearing Support	514809
2.0 (85 kw)	2003.11-2015.11		Centre	BUS FWD AXA		Center Bearing Support	514809
2.0 (100 kw)	2010.05-2015.11		Centre	BUS 4WD CAAE/CCHB		Center Bearing Support	514809
	2010.05-2015.11		Centre	BUS FWD CAAE/CCHB		Center Bearing Support	514809
2.0 (103 kw)	2009.09-2015.11		Centre	BUS FWD CAAC/CCHA		Center Bearing Support	514809
	2009.09-2015.11		Centre	BUS 4WD CAAC/CCHA		Center Bearing Support	514809
2.0 (110 kw)	2012.07-2015.11		Centre	BUS FWD CJKB		Center Bearing Support	514809
2.0 (132 kw)	2009.09-2015.11		Centre	BUS FWD CFCA		Center Bearing Support	514809
	2010.01-2015.11		Centre	BUS 4WD CFCA		Center Bearing Support	514809
2.0 (150 kw)	2011.05-2015.11		Centre	BUS FWD CJKA		Center Bearing Support	514809
	2011.07-2015.11		Centre	BUS 4WD CJKA		Center Bearing Support	514809
2.4 (55 kw)	1997.04-2003.04		Centre	BUS FWD AJA		Center Bearing Support	514801
2.4 (57 kw)	1992.05-1998.04		Centre	BUS FWD AAB		Center Bearing Support	514801
	1995.08-1995.12		Centre	BUS 4WD AAB		Center Bearing Support	514801
	1995.08-1995.12		Front	BUS 4WD AAB		Flexible Coupling	537853



	 YEAR	TRANSM.	FITTING POSITION	BODY STYLE & DRIVE TYPE & ENGINE	REMARKS	 PRODUCT	GSP Ref.
VW							
Multivan							
2.5 (65 kw)	1998.05-2003.04		Centre	BUS FWD AJT/AYY		Center Bearing Support	514801
2.5 (75 kw)	1994.07-2003.04		Centre	BUS FWD ACV/AUF/AYC		Center Bearing Support	514801
	1996.01-2003.09		Centre	BUS 4WD ACV/AXL		Center Bearing Support	514801
	1996.01-2003.09		Front	BUS 4WD ACV/AXL		Flexible Coupling	537853
2.5 (81 kw)	1990.09-2002.04		Centre	BUS FWD AAF/ACU/AEN/AEU		Center Bearing Support	514801
	1995.08-1996.10		Centre	BUS 4WD ACU		Center Bearing Support	514801
	1995.08-1996.10		Front	BUS 4WD ACU		Flexible Coupling	537853
2.5 (85 kw)	1996.08-2003.04		Centre	BUS FWD AET/APL/AVT		Center Bearing Support	514801
	1999.05-2003.04		Centre	BUS 4WD APL/AVT		Center Bearing Support	514801
	1999.05-2003.04		Front	BUS 4WD APL/AVT		Flexible Coupling	537853
2.5 (96 kw)	2003.04-2009.11		Centre	BUS FWD AXD/BNZ		Center Bearing Support	514809
	2004.07-2009.11	6AT/6MT	Rear	BUS 4WD AXD/BNZ	wheel base:3400mm,For PR code:0E2	Propshaft	PS900569
	2004.07-2009.11	6AT/6MT	Rear	BUS 4WD AXD/BNZ	wheel base:3000mm,For PR code:0E1	Propshaft	PS900570
	2004.07-2009.11		Front	BUS 4WD AXD/BNZ		Center Bearing Support	537799
	2004.07-2009.11		Rear	BUS 4WD AXD/BNZ		Center Bearing Support	537800
	2004.07-2009.11		Centre	BUS 4WD AXD/BNZ		Center Bearing Support	514809
2.5 (111 kw)	1998.05-2003.04		Centre	BUS FWD AHY/AXG		Center Bearing Support	514801
2.5 (120 kw)	2003.11-2009.11		Centre	BUS FWD BLJ		Center Bearing Support	514809
2.5 (128 kw)	2003.04-2009.11		Centre	BUS FWD AXE/BPC		Center Bearing Support	514809
	2004.07-2009.11	6AT/6MT	Rear	BUS 4WD AXE/BPC	wheel base:3400mm,For PR code:0E2	Propshaft	PS900569
	2004.07-2009.11	6AT/6MT	Rear	BUS 4WD AXE/BPC	wheel base:3000mm,For PR code:0E1	Propshaft	PS900570
	2004.07-2009.11		Front	BUS 4WD AXE/BPC		Center Bearing Support	537799
	2004.07-2009.11		Rear	BUS 4WD AXE/BPC		Center Bearing Support	537800
	2004.07-2009.11		Centre	BUS 4WD AXE/BPC		Center Bearing Support	514809
2.8 (103 kw)	1996.01-2000.05		Centre	BUS FWD AES		Center Bearing Support	514801
2.8 (150 kw)	2000.06-2003.04		Centre	BUS FWD AMV		Center Bearing Support	514801
3.2 (170 kw)	2004.02-2004.06		Centre	BUS FWD BDL		Center Bearing Support	514809
3.2 (173 kw)	2004.02-2009.12		Centre	BUS FWD BKK/CFLA		Center Bearing Support	514809
	2004.07-2009.12	6MT	Rear	BUS 4WD BKK/CFLA	wheel base:3400mm,For PR code:0E2	Propshaft	PS900569
	2004.07-2009.12	6MT	Rear	BUS 4WD BKK/CFLA	wheel base:3000mm,For PR code:0E1	Propshaft	PS900570
	2004.07-2009.12		Front	BUS 4WD BKK/CFLA		Center Bearing Support	537799
	2004.07-2009.12		Rear	BUS 4WD BKK/CFLA		Center Bearing Support	537800
	2004.07-2009.12		Centre	BUS 4WD BKK/CFLA		Center Bearing Support	514809
New Beetle							
3.2 (165 kw)	2000.07-2001.05		Front	Hatchback 4WD AXJ		Flexible Coupling	537626
	2000.07-2001.05		Front	Hatchback 4WD AXJ		Flexible Coupling Kit	537626S
Passat							
1.4 (110 kw)	2014.08-		Front	Saloon 4WD CZEA		Flexible Coupling	537626
	2014.08-		Rear	Saloon 4WD CZEA		Flexible Coupling	533882
	2014.08-		Front	Saloon 4WD CZEA		Flexible Coupling Kit	537626S
	2014.08-		Rear	Saloon 4WD CZEA		Flexible Coupling Kit	533882S
2.0 (103 kw)	2005.03-2008.05		Front	Saloon 4WD BMP		Flexible Coupling	537626
	2005.03-2008.05		Rear	Saloon 4WD BMP		Flexible Coupling	533882
	2005.03-2010.07		Front	Saloon 4WD BKP/CBAB		Flexible Coupling	537626
	2005.03-2010.07		Rear	Saloon 4WD BKP/CBAB		Flexible Coupling	533882
	2010.11-2014.12		Front	Saloon 4WD CFFB		Flexible Coupling	537626
	2010.11-2014.12		Rear	Saloon 4WD CFFB		Flexible Coupling	533882
2.0 (110 kw)	2005.03-2010.11		Front	Saloon 4WD BLX/BLY/BVX		Flexible Coupling	537626
	2005.03-2010.11		Rear	Saloon 4WD BLX/BLY/BVX		Flexible Coupling	533882
	2014.08-		Front	Saloon 4WD CRLB/DFEA/DFGA/DTSA		Flexible Coupling	537626
	2014.08-		Rear	Saloon 4WD CRLB/DFEA/DFGA/DTSA		Flexible Coupling	533882
	2014.08-		Front	Saloon 4WD CRLB/DFEA/DFGA/DTSA		Flexible Coupling Kit	537626S
	2014.08-		Rear	Saloon 4WD CRLB/DFEA/DFGA/DTSA		Flexible Coupling Kit	533882S
	2014.08-		Centre	Saloon 4WD CRLB/DFEA/DFGA/DTSA		Flexible Coupling Kit	533882S
2.0 (125 kw)	2009.05-2010.11		Front	Saloon 4WD CBBB		Flexible Coupling	537626
	2009.05-2010.11		Rear	Saloon 4WD CBBB		Flexible Coupling	533882
	2010.11-2013.01		Front	Saloon 4WD CFGB		Flexible Coupling	537626
	2010.11-2013.01		Rear	Saloon 4WD CFGB		Flexible Coupling	533882
2.0 (130 kw)	2013.01-2014.12		Rear	Saloon 4WD CFGC		Flexible Coupling	533882
2.0 (140 kw)	2014.11-		Front	Saloon 4WD DDA/DFCA/DFHA		Flexible Coupling	537626
	2014.11-		Rear	Saloon 4WD DDA/DFCA/DFHA		Flexible Coupling	533882
	2014.11-		Front	Saloon 4WD DDA/DFCA/DFHA		Flexible Coupling Kit	537626S
	2014.11-		Rear	Saloon 4WD DDA/DFCA/DFHA		Flexible Coupling Kit	533882S
2.0 (147 kw)	2020.08-		Front	Saloon 4WD DTUA		Flexible Coupling	537626
	2020.08-		Rear	Saloon 4WD DTUA		Flexible Coupling	533882



	 YEAR	TRANSM.	FITTING POSITION	BODY STYLE & DRIVE TYPE & ENGINE	REMARKS	 PRODUCT	GSP Ref.
VW							
Passat							
2.0 (147 kw)	2020.08-		Front	Saloon 4WD DTUA		Flexible Coupling Kit	537626S
2.0 (176 kw)	2014.08-		Front	Saloon 4WD CUAA		Flexible Coupling	537626
	2014.08-		Rear	Saloon 4WD CUAA		Flexible Coupling	533882
	2014.08-		Front	Saloon 4WD CUAA		Flexible Coupling Kit	537626S
	2014.08-		Rear	Saloon 4WD CUAA		Flexible Coupling Kit	533882S
	2018.09-		Front	Saloon 4WD DNUA		Flexible Coupling	537626
2.0 (200 kw)	2018.09-		Rear	Saloon 4WD DNUA		Flexible Coupling	533882
	2018.09-		Front	Saloon 4WD DNUA		Flexible Coupling Kit	537626S
	2014.08-		Front	Saloon 4WD CJXA/DNFE		Flexible Coupling	537626
2.0 (206 kw)	2014.08-		Rear	Saloon 4WD CJXA/DNFE		Flexible Coupling	533882
	2014.08-		Front	Saloon 4WD CJXA/DNFE		Flexible Coupling Kit	537626S
	2014.08-		Rear	Saloon 4WD CJXA/DNFE		Flexible Coupling Kit	533882S
	2014.08-		Rear	Saloon 4WD CJXA/DNFE		Flexible Coupling Kit	533882S
3.2 (184 kw)	2005.09-2010.11		Front	Saloon 4WD AXZ		Flexible Coupling	537626
3.6 (206 kw)	2005.09-2010.07		Front	Saloon 4WD BLV		Flexible Coupling	537626
	2005.09-2010.07		Front	Saloon 4WD BLV		Flexible Coupling Kit	537626S
	2006.09-2007.12		Front	Estate AWD BLV		Flexible Coupling	537626
	2006.09-2007.12		Front	Estate AWD BLV		Flexible Coupling Kit	537626S
	2007.04-2010.11		Front	Saloon 4WD BWS		Flexible Coupling	537626
2007.04-2010.11		Front	Saloon 4WD BWS		Flexible Coupling Kit	537626S	
Passat Alltrack							
1.4 (110 kw)	2015.05-		Front	Estate 4WD CZEA		Flexible Coupling	537626
	2015.05-		Rear	Estate 4WD CZEA		Flexible Coupling	533882
	2015.05-		Front	Estate 4WD CZEA		Flexible Coupling Kit	537626S
	2015.05-		Rear	Estate 4WD CZEA		Flexible Coupling Kit	533882S
2.0 (103 kw)	2010.11-2014.12		Rear	Estate 4WD CFFB		Flexible Coupling	533882
2.0 (110 kw)	2015.05-2017.11		Front	Estate 4WD CRLB/DFEA		Flexible Coupling	537626
	2015.05-2017.11		Rear	Estate 4WD CRLB/DFEA		Flexible Coupling	533882
	2015.05-2017.11		Front	Estate 4WD CRLB/DFEA		Flexible Coupling Kit	537626S
	2015.05-2017.11		Rear	Estate 4WD CRLB/DFEA		Flexible Coupling Kit	533882S
2.0 (125 kw)	2010.11-2013.01		Rear	Estate 4WD CFGB		Flexible Coupling	533882
2.0 (130 kw)	2013.01-2014.12		Rear	Estate 4WD CFGC		Flexible Coupling	533882
2.0 (135 kw)	2015.07-		Front	Estate 4WD CUPA		Flexible Coupling	537626
	2015.07-		Rear	Estate 4WD CUPA		Flexible Coupling	533882
	2015.07-		Front	Estate 4WD CUPA		Flexible Coupling Kit	537626S
	2015.07-		Rear	Estate 4WD CUPA		Flexible Coupling Kit	533882S
	2015.05-		Front	Estate 4WD DDA/DFCA/DFHA		Flexible Coupling	537626
2.0 (140 kw)	2015.05-		Rear	Estate 4WD DDA/DFCA/DFHA		Flexible Coupling	533882
	2015.05-		Front	Estate 4WD DDA/DFCA/DFHA		Flexible Coupling Kit	537626S
	2015.05-		Rear	Estate 4WD DDA/DFCA/DFHA		Flexible Coupling Kit	533882S
	2015.05-		Rear	Estate 4WD DDA/DFCA/DFHA		Flexible Coupling Kit	533882S
2.0 (155 kw)	2012.01-2014.12		Rear	Estate 4WD CCZB		Flexible Coupling	533882
2.0 (162 kw)	2015.07-		Front	Estate 4WD CHHB		Flexible Coupling	537626
	2015.07-		Rear	Estate 4WD CHHB		Flexible Coupling	533882
	2015.07-		Front	Estate 4WD CHHB		Flexible Coupling Kit	537626S
	2015.07-		Rear	Estate 4WD CHHB		Flexible Coupling Kit	533882S
2.0 (176 kw)	2015.05-		Front	Estate 4WD CUAA		Flexible Coupling	537626
	2015.05-		Rear	Estate 4WD CUAA		Flexible Coupling	533882
	2015.05-		Front	Estate 4WD CUAA		Flexible Coupling Kit	537626S
	2015.05-		Rear	Estate 4WD CUAA		Flexible Coupling Kit	533882S
2.0 (200 kw)	2018.08-		Front	Estate 4WD DNUA		Flexible Coupling	537626
	2018.08-		Rear	Estate 4WD DNUA		Flexible Coupling	533882
	2018.08-		Front	Estate 4WD DNUA		Flexible Coupling Kit	537626S
2.0 (206 kw)	2018.11-		Front	Estate 4WD CJXA/DNFE		Flexible Coupling	537626
	2018.11-		Rear	Estate 4WD CJXA/DNFE		Flexible Coupling	533882
	2018.11-		Front	Estate 4WD CJXA/DNFE		Flexible Coupling Kit	537626S
Passat CC							
2.0 (103 kw)	2008.05-2011.12		Front	Coupe 4WD CBAB/CFFB		Flexible Coupling	537626
	2008.05-2011.12		Rear	Coupe 4WD CBAB/CFFB		Flexible Coupling	533882
2.0 (125 kw)	2009.11-2011.12		Front	Coupe 4WD CBBB/CFGB		Flexible Coupling	537626
	2009.11-2011.12		Rear	Coupe 4WD CBBB/CFGB		Flexible Coupling	533882
3.6 (206 kw)	2008.06-2012.01		Front	Coupe 4WD BLV/CNNA		Flexible Coupling	537626
	2008.06-2012.01		Front	Coupe 4WD BLV/CNNA		Flexible Coupling Kit	537626S
3.6 (220 kw)	2008.02-2011.12		Front	Coupe 4WD BWS		Flexible Coupling	537626
	2008.02-2011.12		Front	Coupe 4WD BWS		Flexible Coupling Kit	537626S



	 YEAR	TRANSM.	FITTING POSITION	BODY STYLE & DRIVE TYPE & ENGINE	REMARKS	 PRODUCT	GSP Ref.
VW							
Passat Estate/Variant							
1.4 (110 kw)	2014.08-		Front	Estate 4WD CZEA		Flexible Coupling	537626
	2014.08-		Rear	Estate 4WD CZEA		Flexible Coupling	533882
	2014.08-		Front	Estate 4WD CZEA		Flexible Coupling Kit	537626S
	2014.08-		Rear	Estate 4WD CZEA		Flexible Coupling Kit	533882S
2.0 (103 kw)	2005.03-2010.11		Front	Estate 4WD BKP/CBAB		Flexible Coupling	537626
	2005.03-2010.11		Rear	Estate 4WD BKP/CBAB		Flexible Coupling	533882
	2005.08-2008.05		Front	Estate 4WD BMP		Flexible Coupling	537626
	2005.08-2008.05		Rear	Estate 4WD BMP		Flexible Coupling	533882
	2010.11-2014.12		Front	Estate 4WD CFFB		Flexible Coupling	537626
	2010.11-2014.12		Rear	Estate 4WD CFFB		Flexible Coupling	533882
2.0 (110 kw)	2005.09-2010.11		Front	Estate 4WD BLX/BLY/BVX		Flexible Coupling	537626
	2005.09-2010.11		Rear	Estate 4WD BLX/BLY/BVX		Flexible Coupling	533882
	2014.08-		Front	Estate 4WD CRLB/DFEA/DFGA/DTSA		Flexible Coupling	537626
	2014.08-		Rear	Estate 4WD CRLB/DFEA/DFGA/DTSA		Flexible Coupling	533882
	2014.08-		Front	Estate 4WD CRLB/DFEA/DFGA/DTSA		Flexible Coupling Kit	537626S
	2014.08-		Rear	Estate 4WD CRLB/DFEA/DFGA/DTSA		Flexible Coupling Kit	533882S
2.0 (125 kw)	2009.11-2010.11		Front	Estate 4WD CBBB		Flexible Coupling	537626
	2009.11-2010.11		Rear	Estate 4WD CBBB		Flexible Coupling	533882
	2010.08-2013.01		Front	Estate 4WD CFGB		Flexible Coupling	537626
	2010.08-2013.01		Rear	Estate 4WD CFGB		Flexible Coupling	533882
2.0 (130 kw)	2013.01-2014.12		Rear	Estate 4WD CFGC		Flexible Coupling	533882
2.0 (140 kw)	2014.11-		Front	Estate 4WD DDAA/DFCA/DFHA		Flexible Coupling	537626
	2014.11-		Rear	Estate 4WD DDAA/DFCA/DFHA		Flexible Coupling	533882
	2014.11-		Front	Estate 4WD DDAA/DFCA/DFHA		Flexible Coupling Kit	537626S
	2014.11-		Rear	Estate 4WD DDAA/DFCA/DFHA		Flexible Coupling Kit	533882S
2.0 (147 kw)	2020.08-		Front	Estate 4WD DTUA		Flexible Coupling	537626
	2020.08-		Rear	Estate 4WD DTUA		Flexible Coupling	533882
	2020.08-		Front	Estate 4WD DTUA		Flexible Coupling Kit	537626S
2.0 (176 kw)	2014.08-		Front	Estate 4WD CUAA		Flexible Coupling	537626
	2014.08-		Rear	Estate 4WD CUAA		Flexible Coupling	533882
	2014.08-		Front	Estate 4WD CUAA		Flexible Coupling Kit	537626S
	2014.08-		Rear	Estate 4WD CUAA		Flexible Coupling Kit	533882S
	2.0 (200 kw)	2018.09-		Front	Estate 4WD DNUA		Flexible Coupling
	2018.09-		Rear	Estate 4WD DNUA		Flexible Coupling	533882
	2018.09-		Front	Estate 4WD DNUA		Flexible Coupling Kit	537626S
2.0 (206 kw)	2014.08-		Front	Estate 4WD CJXA/DNFE		Flexible Coupling	537626
	2014.08-		Rear	Estate 4WD CJXA/DNFE		Flexible Coupling	533882
	2014.08-		Front	Estate 4WD CJXA/DNFE		Flexible Coupling Kit	537626S
	2014.08-		Rear	Estate 4WD CJXA/DNFE		Flexible Coupling Kit	533882S
3.2 (184 kw)	2005.09-2010.11		Front	Estate 4WD AXZ		Flexible Coupling	537626
3.6 (220 kw)	2007.04-2010.11		Front	Estate 4WD BWS		Flexible Coupling	537626
	2007.04-2010.11		Front	Estate 4WD BWS		Flexible Coupling Kit	537626S
	2011.01-2014.12		Front	Estate 4WD BWS		Flexible Coupling	537626
	2011.01-2014.12		Front	Combi van 4WD BWS		Flexible Coupling	537626
Sharan							
2.0 (103 kw)	2011.05-2015.11		Front	MPV 4WD CFFB		Flexible Coupling	537626
	2011.05-2015.11		Rear	MPV 4WD CFFB		Flexible Coupling	533882
2.0 (110 kw)	2015.05-		Rear	MPV 4WD CUVC/DFLA/DLTA		Flexible Coupling	533882
2.0 (135 kw)	2016.05-		Rear	MPV 4WD DFMA		Flexible Coupling	533882
T-Roc							
2.0 (110 kw)	2017.09-		Rear	SUV 4WD DFFA/DTTA/DTTC		Propshaft	PS900584
	2017.09-		Front	SUV 4WD DFFA/DTTA/DTTC		Flexible Coupling	537626
	2017.09-		Rear	SUV 4WD DFFA/DTTA/DTTC		Flexible Coupling	533882
	2017.09-		Front	SUV 4WD DFFA/DTTA/DTTC		Flexible Coupling Kit	537626S
	2017.09-		Rear	SUV 4WD DFFA/DTTA/DTTC		Flexible Coupling Kit	533882S
	2018.03-		Rear	SUV FWD DFFA/DTTA/DTTC		Flexible Coupling Kit	533882S
2.0 (140 kw)	2017.07-		Front	SUV 4WD CZPB/DKZA/DNNA		Flexible Coupling	537626
	2017.07-		Rear	SUV 4WD CZPB/DKZA/DNNA		Flexible Coupling	533882
	2017.07-		Front	SUV 4WD CZPB/DKZA/DNNA		Flexible Coupling Kit	537626S
	2017.07-		Rear	SUV 4WD CZPB/DKZA/DNNA		Flexible Coupling Kit	533882S
	2019.07-2021.06		Rear	SUV 4WD DFHA		Propshaft	PS900584
Teramont							
2.0 (162 kw)	2017.12-		Front	SUV 4WD CXDA		Flexible Coupling	537626
	2017.12-		Rear	SUV 4WD CXDA		Flexible Coupling	533882



	 YEAR	TRANSM.	FITTING POSITION	BODY STYLE & DRIVE TYPE & ENGINE	REMARKS	 PRODUCT	GSP Ref.
VW							
Teramont							
2.0 (162 kw)	2017.12-		Front	SUV 4WD CXDA		Flexible Coupling Kit	537626S
	2017.12-		Rear	SUV 4WD CXDA		Flexible Coupling Kit	533882S
3.6 (206 kw)	2016.12-		Front	SUV 4WD CDVC		Flexible Coupling	537626
	2016.12-		Rear	SUV 4WD CDVC		Flexible Coupling	533882
	2016.12-		Front	SUV 4WD CDVC		Flexible Coupling Kit	537626S
	2016.12-		Rear	SUV 4WD CDVC		Flexible Coupling Kit	533882S
Tiguan							
1.4 (110 kw)	2007.11-2018.07	MT	Rear	SUV 4WD BWK/CAVA/CTHA	Model:5N1;For PR code:5C0/5C6,Model:5N2	Propshaft	PS900520
	2007.11-2018.07		Centre	SUV 4WD BWK/CAVA/CTHA		Center Bearing Support	514808
	2007.11-2018.07		Centre	SUV 4WD BWK/CAVA/CTHA	Date from-to:2008-2011	Center Bearing Support Kit	514808S
	2007.11-2018.07		Centre	SUV 4WD BWK/CAVA/CTHA		Center Bearing Support Kit	514808S
	2007.11-2018.07		Rear	SUV 4WD BWK/CAVA/CTHA		Flexible Coupling	533882
	2008.05-2018.07		Centre	SUV FWD CAVA/CTHA		Center Bearing Support	514808
	2008.05-2018.07		Centre	SUV FWD CAVA/CTHA		Center Bearing Support Kit	514808S
	2016.03-		Front	SUV 4WD CZDA/CZEA		Flexible Coupling	537626
	2016.03-		Rear	SUV 4WD CZDA/CZEA		Flexible Coupling	533882
	2016.03-		Front	SUV 4WD CZDA/CZEA		Flexible Coupling Kit	537626S
	2016.03-		Rear	SUV 4WD CZDA/CZEA		Flexible Coupling Kit	533882S
1.4 (118 kw)	2011.05-2018.07	MT	Rear	SUV 4WD CAVD/CTHD	For PR code:5C0/5C6	Propshaft	PS900520
	2011.05-2018.07	MT	Rear	SUV FWD CAVD/CTHD	For PR code:5C0	Propshaft	PS900520
	2011.05-2018.07		Centre	SUV 4WD CAVD/CTHD		Center Bearing Support	514808
	2011.05-2018.07		Centre	SUV FWD CAVD/CTHD		Center Bearing Support	514808
	2011.05-2018.07		Centre	SUV 4WD CAVD/CTHD	Date from:2012	Center Bearing Support Kit	514808S
	2011.05-2018.07		Centre	SUV 4WD CAVD/CTHD		Center Bearing Support Kit	514808S
	2011.05-2018.07		Centre	SUV FWD CAVD/CTHD		Center Bearing Support Kit	514808S
	2011.05-2018.07		Rear	SUV 4WD CAVD/CTHD		Flexible Coupling	533882
	2012.09-2018.07		Centre	SUV Van 4WD CTHD		Center Bearing Support Kit	514808S
	2012.09-2018.07		Centre	SUV Van FWD CTHD		Center Bearing Support Kit	514808S
	2012.09-2018.07		Rear	SUV Van 4WD CTHD		Flexible Coupling	533882
2.0 (100 kw)	2007.11-2018.07	MT	Rear	SUV 4WD CBAA/CFFA	Model:5N1;For PR code:5C0/5C6,Model:5N2	Propshaft	PS900520
	2007.11-2018.07		Centre	SUV 4WD CBAA/CFFA		Center Bearing Support	514808
	2007.11-2018.07		Centre	SUV 4WD CBAA/CFFA	Date from-to:2008-2011	Center Bearing Support Kit	514808S
	2007.11-2018.07		Centre	SUV 4WD CBAA/CFFA		Center Bearing Support Kit	514808S
	2007.11-2018.07		Rear	SUV 4WD CBAA/CFFA		Flexible Coupling	533882
2.0 (103 kw)	2007.11-2018.07	MT	Rear	SUV 4WD CBAB/CFFB/CLJA	Model:5N1;For PR code:5C0/5C6,Model:5N2	Propshaft	PS900520
	2007.11-2018.07		Centre	SUV 4WD CBAB/CFFB/CLJA		Center Bearing Support	514808
	2007.11-2018.07		Centre	SUV FWD CBAB/CFFB		Center Bearing Support	514808
	2007.11-2018.07		Centre	SUV 4WD CBAB/CFFB/CLJA	Date from-to:2008-2011	Center Bearing Support Kit	514808S
	2007.11-2018.07		Centre	SUV 4WD CBAB/CFFB/CLJA		Center Bearing Support Kit	514808S
	2007.11-2018.07		Centre	SUV FWD CBAB/CFFB		Center Bearing Support Kit	514808S
	2007.11-2018.07		Centre	SUV Van 4WD CBAB/CFFB/CLJA		Center Bearing Support Kit	514808S
	2007.11-2018.07		Rear	SUV 4WD CBAB/CFFB/CLJA		Flexible Coupling	533882
	2007.11-2018.07		Rear	SUV Van 4WD CBAB/CFFB/CLJA		Flexible Coupling	533882
	2009.11-2018.07		Centre	SUV Van FWD CFFB		Center Bearing Support Kit	514808S
2.0 (105 kw)	2016.06-2020.07		Front	SUV 4WD CRFD		Flexible Coupling	537626
	2016.06-2020.07		Rear	SUV 4WD CRFD		Flexible Coupling	533882
	2016.06-2020.07		Front	SUV 4WD CRFD		Flexible Coupling Kit	537626S
	2016.06-2020.07		Rear	SUV 4WD CRFD		Flexible Coupling Kit	533882S
2.0 (110 kw)	2015.05-2018.07	MT	Rear	SUV 4WD CUVC	Date To:2015.08;For PR code:5C0;For PR code:5C6;Date From:2015.08;For PR code:5C0-5C2	Propshaft	PS900520
	2015.05-2018.07		Centre	SUV 4WD CUVC		Center Bearing Support Kit	514808S
	2015.05-2018.07		Centre	SUV FWD CUVC		Center Bearing Support Kit	514808S
	2015.05-2018.07		Rear	SUV 4WD CUVC		Flexible Coupling	533882
	2016.01-		Front	SUV 4WD DBGCC/DFGA/DTSA/DTSB		Flexible Coupling	537626
	2016.01-		Rear	SUV 4WD DBGCC/DFGA/DTSA/DTSB		Flexible Coupling	533882
	2016.01-		Front	SUV 4WD DBGCC/DFGA/DTSA/DTSB		Flexible Coupling Kit	537626S
	2016.01-		Rear	SUV 4WD DBGCC/DFGA/DTSA/DTSB		Flexible Coupling Kit	533882S
2.0 (120 kw)	2008.02-2009.08	MT	Rear	SUV 4WD CBBA		Propshaft	PS900520
	2008.02-2009.08		Centre	SUV 4WD CBBA		Center Bearing Support	514808
	2008.02-2009.08		Centre	SUV 4WD CBBA		Center Bearing Support Kit	514808S
	2008.02-2009.08		Rear	SUV 4WD CBBA		Flexible Coupling	533882
2.0 (125 kw)	2008.01-2018.07	MT	Rear	SUV 4WD CAWA/CCTB/CCZC	Date From:2008.01;Model:5N1;Date From:2008.01;For PR code:5C0/5C6,Model:5N2	Propshaft	PS900520
	2008.01-2018.07		Centre	SUV 4WD CAWA/CCTB/CCZC		Center Bearing Support	514808
	2008.01-2018.07		Centre	SUV 4WD CAWA/CCTB/CCZC	Date from-to:2008-2011	Center Bearing Support Kit	514808S
	2008.01-2018.07		Centre	SUV 4WD CAWA/CCTB/CCZC		Center Bearing Support Kit	514808S



	 YEAR	TRANSM.	FITTING POSITION	BODY STYLE & DRIVE TYPE & ENGINE	REMARKS	 PRODUCT	GSP Ref.
VW Tiguan							
2.0 (125 kw)	2008.01-2018.07		Rear	SUV 4WD CAWA/CCTB/CCZC		Flexible Coupling	533882
	2008.02-2018.07	MT	Rear	SUV 4WD CBBB/CFGB	<small>Date From:2008.02 Model:SN1/Date From:2008.02 For PR code:5C0/5C6,Model:SN2</small>	Propshaft	PS900520
	2008.02-2018.07		Centre	SUV 4WD CBBB/CFGB		Center Bearing Support	514808
	2008.02-2018.07		Centre	SUV 4WD CBBB/CFGB	Date from-to:2008-2011	Center Bearing Support Kit	514808S
	2008.02-2018.07		Centre	SUV 4WD CBBB/CFGB		Center Bearing Support Kit	514808S
	2008.02-2018.07		Rear	SUV 4WD CBBB/CFGB		Flexible Coupling	533882
	2009.11-2011.05		Rear	SUV Van 4WD CCZC		Flexible Coupling	533882
2.0 (130 kw)	2010.05-2013.05		Rear	SUV Van 4WD CFGB		Flexible Coupling	533882
	2012.11-2018.07	MT	Rear	SUV 4WD CFGC	For PR code:5C0/5C6	Propshaft	PS900520
	2012.11-2018.07		Centre	SUV 4WD CFGC		Center Bearing Support	514808
	2012.11-2018.07		Centre	SUV 4WD CFGC		Center Bearing Support Kit	514808S
	2012.11-2018.07		Centre	SUV Van 4WD CFGC		Center Bearing Support Kit	514808S
	2012.11-2018.07		Rear	SUV 4WD CFGC		Flexible Coupling	533882
	2012.11-2018.07		Rear	SUV Van 4WD CFGC		Flexible Coupling	533882
	2016.08-2020.07		Front	SUV 4WD CRGB		Flexible Coupling	537626
	2016.08-2020.07		Rear	SUV 4WD CRGB		Flexible Coupling	533882
	2016.08-2020.07		Front	SUV 4WD CRGB		Flexible Coupling Kit	537626S
2.0 (132 kw)	2016.08-2020.07		Rear	SUV 4WD CRGB		Flexible Coupling Kit	533882S
	2011.05-2018.07	MT	Rear	SUV 4WD CCZD	For PR code:5C0/5C6	Propshaft	PS900520
	2011.05-2018.07		Centre	SUV 4WD CCZD		Center Bearing Support	514808
	2011.05-2018.07		Centre	SUV 4WD CCZD	Date from:2012	Center Bearing Support Kit	514808S
	2011.05-2018.07		Centre	SUV 4WD CCZD		Center Bearing Support Kit	514808S
	2011.05-2018.07		Rear	SUV 4WD CCZD		Flexible Coupling	533882
	2016.01-		Front	SUV 4WD CZPA		Flexible Coupling	537626
	2016.01-		Rear	SUV 4WD CZPA		Flexible Coupling	533882
2.0 (135 kw)	2016.01-		Front	SUV 4WD CZPA		Flexible Coupling Kit	537626S
	2016.01-		Rear	SUV 4WD CZPA		Flexible Coupling Kit	533882S
	2015.05-2018.07	MT	Rear	SUV 4WD CUWA	<small>Date To:2015.05 For PR code:5C0/5C6 For PR code:5C0/5C6,Model:5N2</small>	Propshaft	PS900520
	2015.05-2018.07		Centre	SUV 4WD CUWA		Center Bearing Support Kit	514808S
2.0 (140 kw)	2015.05-2018.07		Rear	SUV 4WD CUWA		Flexible Coupling	533882
	2016.01-2020.07		Front	SUV 4WD DFHA		Flexible Coupling	537626
	2016.01-2020.07		Rear	SUV 4WD DFHA		Flexible Coupling	533882
	2016.01-2020.07		Front	SUV 4WD DFHA		Flexible Coupling Kit	537626S
	2016.01-2020.07		Rear	SUV 4WD DFHA		Flexible Coupling Kit	533882S
	2018.09-		Front	SUV 4WD DKZA/DNNA		Flexible Coupling	537626
	2018.09-		Rear	SUV 4WD DKZA/DNNA		Flexible Coupling	533882
	2018.09-		Front	SUV 4WD DKZA/DNNA		Flexible Coupling Kit	537626S
2.0 (147 kw)	2018.09-		Rear	SUV 4WD DKZA/DNNA		Flexible Coupling Kit	533882S
	2007.11-2018.07	MT	Rear	SUV 4WD CAWB/CCTA/CCZA	Model:5N1:/For PR code:5C0/5C6,Model:5N2	Propshaft	PS900520
	2007.11-2018.07		Centre	SUV 4WD CAWB/CCTA/CCZA		Center Bearing Support	514808
	2007.11-2018.07		Centre	SUV 4WD CAWB/CCTA/CCZA		Center Bearing Support Kit	514808S
	2007.11-2018.07		Centre	SUV FWD CAWB/CCTA		Center Bearing Support Kit	514808S
	2007.11-2018.07		Rear	SUV 4WD CAWB/CCTA/CCZA		Flexible Coupling	533882
	2009.11-2011.05		Centre	SUV Van 4WD CCZA		Center Bearing Support Kit	514808S
	2009.11-2011.05		Rear	SUV Van 4WD CCZA		Flexible Coupling	533882
	2020.06-		Front	SUV 4WD DTUA		Flexible Coupling	537626
	2020.06-		Rear	SUV 4WD DTUA		Flexible Coupling	533882
	2020.06-		Front	SUV 4WD DTUA		Flexible Coupling Kit	537626S
2.0 (155 kw)	2020.06-		Rear	SUV 4WD DTUA		Flexible Coupling Kit	533882S
	2011.05-2018.07	MT	Rear	SUV 4WD CCZB	For PR code:5C0/5C6	Propshaft	PS900520
	2011.05-2018.07		Centre	SUV 4WD CCZB		Center Bearing Support	514808
	2011.05-2018.07		Centre	SUV 4WD CCZB	Date from:2012	Center Bearing Support Kit	514808S
	2011.05-2018.07		Centre	SUV 4WD CCZB		Center Bearing Support Kit	514808S
	2011.05-2018.07		Centre	SUV Van 4WD CCZB		Center Bearing Support Kit	514808S
	2011.05-2018.07		Rear	SUV 4WD CCZB		Flexible Coupling	533882
2.0 (162 kw)	2011.05-2018.07		Rear	SUV Van 4WD CCZB		Flexible Coupling	533882
	2016.05-		Front	SUV 4WD CHHB		Flexible Coupling	537626
	2016.05-		Rear	SUV 4WD CHHB		Flexible Coupling	533882
	2016.05-		Front	SUV 4WD CHHB		Flexible Coupling Kit	537626S
2.0 (169 kw)	2016.05-		Rear	SUV 4WD CHHB		Flexible Coupling Kit	533882S
	2018.09-2020.07		Front	SUV 4WD DKTA		Flexible Coupling	537626
	2018.09-2020.07		Rear	SUV 4WD DKTA		Flexible Coupling	533882
	2018.09-2020.07		Front	SUV 4WD DKTA		Flexible Coupling Kit	537626S
	2018.09-2020.07		Rear	SUV 4WD DKTA		Flexible Coupling Kit	533882S

	 YEAR	TRANSM.	FITTING POSITION	BODY STYLE & DRIVE TYPE & ENGINE	REMARKS	 PRODUCT	GSP Ref.
VW Tiguan							
2.0 (176 kw)	2016.05-2020.07		Front	SUV 4WD CUAA		Flexible Coupling	537626
	2016.05-2020.07		Rear	SUV 4WD CUAA		Flexible Coupling	533882
	2016.05-2020.07		Front	SUV 4WD CUAA		Flexible Coupling Kit	537626S
	2016.05-2020.07		Rear	SUV 4WD CUAA		Flexible Coupling Kit	533882S
2.0 (235 kw)	2020.11-		Front	SUV 4WD DNFG		Flexible Coupling	537626
	2020.11-		Rear	SUV 4WD DNFG		Flexible Coupling	533882
	2020.11-		Front	SUV 4WD DNFG		Flexible Coupling Kit	537626S
	2020.11-		Rear	SUV 4WD DNFG		Flexible Coupling Kit	533882S
Tiguan Allspace							
2.0 (110 kw)	2017.06-		Front	SUV 4WD DBGC/DFGA/D TSA/D TSB		Flexible Coupling	537626
	2017.06-		Rear	SUV 4WD DBGC/DFGA/D TSA/D TSB		Flexible Coupling	533882
	2017.06-		Front	SUV 4WD DBGC/DFGA/D TSA/D TSB		Flexible Coupling Kit	537626S
	2017.06-		Rear	SUV 4WD DBGC/DFGA/D TSA/D TSB		Flexible Coupling Kit	533882S
2.0 (132 kw)	2017.03-2021.07		Front	SUV 4WD DGVA		Flexible Coupling	537626
	2017.03-2021.07		Rear	SUV 4WD DGVA		Flexible Coupling	533882
	2017.03-2021.07		Front	SUV 4WD DGVA		Flexible Coupling Kit	537626S
	2017.03-2021.07		Rear	SUV 4WD DGVA		Flexible Coupling Kit	533882S
2.0 (140 kw)	2017.06-2021.07		Front	SUV 4WD DFHA		Flexible Coupling	537626
	2017.06-2021.07		Rear	SUV 4WD DFHA		Flexible Coupling	533882
	2017.06-2021.07		Front	SUV 4WD DFHA		Flexible Coupling Kit	537626S
	2017.06-2021.07		Rear	SUV 4WD DFHA		Flexible Coupling Kit	533882S
2.0 (162 kw)	2017.06-		Front	SUV 4WD CXDA/DNJA		Flexible Coupling	537626
	2017.06-		Rear	SUV 4WD CXDA/DNJA		Flexible Coupling	533882
	2017.06-		Front	SUV 4WD CXDA/DNJA		Flexible Coupling Kit	537626S
	2017.06-		Rear	SUV 4WD CXDA/DNJA		Flexible Coupling Kit	533882S
2.0 (176 kw)	2017.06-2020.09		Front	SUV 4WD CUAA		Flexible Coupling	537626
	2017.06-2020.09		Rear	SUV 4WD CUAA		Flexible Coupling	533882
	2017.06-2020.09		Front	SUV 4WD CUAA		Flexible Coupling Kit	537626S
	2017.06-2020.09		Rear	SUV 4WD CUAA		Flexible Coupling Kit	533882S
Touareg							
2.5 (120 kw)	2003.07-2010.05		Front	SUV 4WD BLK/BPD		Propshaft	PS900526
	2003.07-2010.05		Rear	SUV 4WD BLK/BPD		Propshaft	PS900528
	2003.07-2010.05		Centre	SUV 4WD BLK/BPD		Center Bearing Support	514781
	2003.07-2010.05		Centre	SUV 4WD BLK/BPD		Center Bearing Support	519037
	2003.07-2010.05		Rear	SUV 4WD BLK/BPD		Flexible Coupling	517957
	2003.07-2010.05		Front	SUV 4WD BLK/BPD		Flexible Coupling Kit	517957S
2.5 (128 kw)	2003.01-2010.05		Front	SUV 4WD BAC/BPE		Propshaft	PS900526
	2003.01-2010.05		Rear	SUV 4WD BAC/BPE		Propshaft	PS900528
	2003.01-2010.05		Centre	SUV 4WD BAC/BPE		Center Bearing Support	514781
	2003.01-2010.05		Centre	SUV 4WD BAC/BPE		Center Bearing Support	519037
	2003.01-2010.05		Rear	SUV 4WD BAC/BPE		Flexible Coupling	517957
	2003.01-2010.05		Front	SUV 4WD BAC/BPE		Flexible Coupling Kit	517957S
3.0 (150 kw)	2010.01-2018.03		Front	SUV 4WD CASD/CJMA/CRCD/CVWA		Propshaft	PS900522
3.0 (155 kw)	2006.12-2010.05		Front	SUV 4WD BUN/CASB	Date From:2006.12	Propshaft	PS900525
	2006.12-2010.05		Rear	SUV 4WD BUN/CASB	Date From:2006.12	Propshaft	PS900527
	2006.12-2010.05		Front	SUV 4WD BUN/CASB	Date From:2006.12	Joint,propshaft	661094
	2006.12-2010.05		Centre	SUV 4WD BUN/CASB		Center Bearing Support	514781
	2006.12-2010.05		Centre	SUV 4WD BUN/CASB		Center Bearing Support	519037
	2006.12-2010.05		Rear	SUV 4WD BUN/CASB		Flexible Coupling	517957
	2006.12-2010.05		Front	SUV 4WD BUN/CASB		Flexible Coupling Kit	517957S
3.0 (165 kw)	2004.11-2010.05		Front	SUV 4WD BKS/CATA		Propshaft	PS900525
	2004.11-2010.05		Rear	SUV 4WD BKS/CATA		Propshaft	PS900527
	2004.11-2010.05		Front	SUV 4WD BKS/CATA		Joint,propshaft	661094
	2004.11-2010.05		Centre	SUV 4WD BKS/CATA		Center Bearing Support	514781
	2004.11-2010.05		Centre	SUV 4WD BKS/CATA		Center Bearing Support	519037
	2004.11-2010.05		Rear	SUV 4WD BKS/CATA		Flexible Coupling	517957
3.0 (176 kw)	2007.11-2010.05		Front	SUV 4WD CASA/CASC		Propshaft	PS900525
	2007.11-2010.05		Rear	SUV 4WD CASA/CASC		Propshaft	PS900527
	2007.11-2010.05		Front	SUV 4WD CASA/CASC		Joint,propshaft	661094
	2007.11-2010.05		Centre	SUV 4WD CASA/CASC		Center Bearing Support	514781
	2007.11-2010.05		Centre	SUV 4WD CASA/CASC		Center Bearing Support	519037
	2007.11-2010.05		Rear	SUV 4WD CASA/CASC		Flexible Coupling	517957
	2007.11-2010.05		Front	SUV 4WD CASA/CASC		Flexible Coupling Kit	517957S

	 YEAR	TRANSM.	FITTING POSITION	BODY STYLE & DRIVE TYPE & ENGINE	REMARKS	 PRODUCT	GSP Ref.
VW							
Touareg							
3.0 (176 kw)	2010.01-2014.12		Front	SUV 4WD CASA/CNRB		Propshaft	PS900522
3.0 (180 kw)	2011.05-2018.03		Front	SUV 4WD CJGD/CRCA		Propshaft	PS900522
3.0 (193 kw)	2014.08-2018.03		Front	SUV 4WD CVVA		Propshaft	PS900522
3.0 (213 kw)	2010.08-2014.12		Front	SUV 4WD CJTA		Propshaft	PS900522
3.0 (235 kw)	2015.01-2018.03		Front	SUV 4WD CYJA		Propshaft	PS900522
3.0 (245 kw)	2010.04-2018.03		Front	SUV 4WD CGEA/CGFA		Propshaft	PS900522
3.0 (283 kw)	2010.09-2018.03		Front	SUV AWD CGFA		Propshaft	PS900522
3.2 (162 kw)	2002.11-2006.11		Front	SUV 4WD AZZ/BKJ/BMV/BMX/BRJ		Propshaft	PS900525
	2002.11-2006.11		Rear	SUV 4WD AZZ/BKJ/BMV/BMX/BRJ		Propshaft	PS900527
	2002.11-2006.11		Front	SUV 4WD AZZ/BKJ/BMV/BMX/BRJ		Joint,propshaft	661094
	2002.11-2006.11		Centre	SUV 4WD AZZ/BKJ/BMV/BMX/BRJ		Center Bearing Support	514781
	2002.11-2006.11		Centre	SUV 4WD AZZ/BKJ/BMV/BMX/BRJ		Center Bearing Support	519037
	2002.11-2006.11		Rear	SUV 4WD AZZ/BKJ/BMV/BMX/BRJ		Flexible Coupling	517957
	2002.11-2006.11		Front	SUV 4WD AZZ/BKJ/BMV/BMX/BRJ		Flexible Coupling Kit	517957S
3.2 (177 kw)	2004.11-2006.11		Front	SUV 4WD BKJ/BMV/BMX/BRJ		Propshaft	PS900525
	2004.11-2006.11		Rear	SUV 4WD BKJ/BMV/BMX/BRJ		Propshaft	PS900527
	2004.11-2006.11		Front	SUV 4WD BKJ/BMV/BMX/BRJ		Joint,propshaft	661094
	2004.11-2006.11		Centre	SUV 4WD BKJ/BMV/BMX/BRJ		Center Bearing Support	514781
	2004.11-2006.11		Centre	SUV 4WD BKJ/BMV/BMX/BRJ		Center Bearing Support	519037
	2004.11-2006.11		Rear	SUV 4WD BKJ/BMV/BMX/BRJ		Flexible Coupling	517957
2004.11-2006.11		Front	SUV 4WD BKJ/BMV/BMX/BRJ		Flexible Coupling Kit	517957S	
3.6 (183 kw)	2010.08-2018.03		Front	SUV 4WD CMTA		Propshaft	PS900522
3.6 (206 kw)	2005.10-2010.12		Front	SUV 4WD BHK		Propshaft	PS900525
	2005.10-2010.12		Rear	SUV 4WD BHK		Propshaft	PS900527
	2005.10-2010.12		Front	SUV 4WD BHK		Joint,propshaft	661094
	2005.10-2010.12		Centre	SUV 4WD BHK		Center Bearing Support	514781
	2005.10-2010.12		Centre	SUV 4WD BHK		Center Bearing Support	519037
	2005.10-2010.12		Rear	SUV 4WD BHK		Flexible Coupling	517957
	2005.10-2010.12		Front	SUV 4WD BHK		Flexible Coupling Kit	517957S
	2010.04-2018.03		Front	SUV 4WD CGRA		Propshaft	PS900522
4.2 (228 kw)	2002.12-2006.11		Front	SUV 4WD AXQ		Propshaft	PS900525
	2002.12-2006.11		Rear	SUV 4WD AXQ		Propshaft	PS900527
	2002.12-2006.11		Front	SUV 4WD AXQ		Joint,propshaft	661094
	2002.12-2006.11		Centre	SUV 4WD AXQ		Center Bearing Support	514781
	2002.12-2006.11		Centre	SUV 4WD AXQ		Center Bearing Support	519037
	2002.12-2006.11		Rear	SUV 4WD AXQ		Flexible Coupling	517957
	2002.12-2006.11		Front	SUV 4WD AXQ		Flexible Coupling Kit	517957S
	2002.12-2006.11		Front	SUV 4WD AXQ		Flexible Coupling Kit	517957S
4.2 (257 kw)	2006.06-2010.05		Front	SUV 4WD BAR		Propshaft	PS900525
	2006.06-2010.05		Rear	SUV 4WD BAR		Propshaft	PS900527
	2006.06-2010.05		Front	SUV 4WD BAR		Joint,propshaft	661094
	2006.06-2010.05		Centre	SUV 4WD BAR		Center Bearing Support	514781
	2006.06-2010.05		Centre	SUV 4WD BAR		Center Bearing Support	519037
	2006.06-2010.05		Rear	SUV 4WD BAR		Flexible Coupling	517957
	2006.06-2010.05		Front	SUV 4WD BAR		Flexible Coupling Kit	517957S
4.2 (265 kw)	2011.01-2018.03		Front	SUV 4WD CGNA		Propshaft	PS900522
5.0 (230 kw)	2002.11-2010.05		Front	SUV 4WD AYH/BLE/BWF		Propshaft	PS900526
	2002.11-2010.05		Rear	SUV 4WD AYH/BLE/BWF		Propshaft	PS900528
	2002.11-2010.05		Centre	SUV 4WD AYH/BLE/BWF		Center Bearing Support	514781
	2002.11-2010.05		Centre	SUV 4WD AYH/BLE/BWF		Center Bearing Support	519037
	2002.11-2010.05		Rear	SUV 4WD AYH/BLE/BWF		Flexible Coupling	517957
	2002.11-2010.05		Front	SUV 4WD AYH/BLE/BWF		Flexible Coupling Kit	517957S
5.0 (258 kw)	2007.08-2010.05		Front	SUV 4WD CBWA		Propshaft	PS900526
	2007.08-2010.05		Rear	SUV 4WD CBWA		Propshaft	PS900528
	2007.08-2010.05		Centre	SUV 4WD CBWA		Center Bearing Support	514781
	2007.08-2010.05		Centre	SUV 4WD CBWA		Center Bearing Support	519037
	2007.08-2010.05		Rear	SUV 4WD CBWA		Flexible Coupling	517957
	2007.08-2010.05		Front	SUV 4WD CBWA		Flexible Coupling Kit	517957S
6.0 (331 kw)	2004.08-2010.05		Front	SUV 4WD BJN/CFRA		Propshaft	PS900525
	2004.08-2010.05		Rear	SUV 4WD BJN/CFRA	Chassis no. from:7L-5-042 001	Propshaft	PS900527
	2004.08-2010.05		Front	SUV 4WD BJN/CFRA		Joint,propshaft	661094
	2004.08-2010.05		Centre	SUV 4WD BJN/CFRA		Center Bearing Support	514781
	2004.08-2010.05		Centre	SUV 4WD BJN/CFRA		Center Bearing Support	519037
	2004.08-2010.05		Rear	SUV 4WD BJN/CFRA		Flexible Coupling	517957
	2004.08-2010.05		Front	SUV 4WD BJN/CFRA		Flexible Coupling Kit	517957S
	2004.08-2010.05		Front	SUV 4WD BJN/CFRA		Flexible Coupling Kit	517957S

	 YEAR	TRANSM.	FITTING POSITION	BODY STYLE & DRIVE TYPE & ENGINE	REMARKS	 PRODUCT	GSP Ref.
VW							
Transporter							
1.9 (50 kw)	1992.10-2003.04		Centre	VAN FWD ABL		Center Bearing Support	514801
	1992.10-2003.04		Centre	Chassis cabin FWD ABL		Center Bearing Support	514801
	1994.07-2003.04		Centre	BUS FWD ABL		Center Bearing Support	514801
1.9 (62 kw)	2006.01-2009.11		Centre	VAN FWD BRR		Center Bearing Support	514809
	2006.01-2009.11		Centre	Chassis cabin FWD BRR		Center Bearing Support	514809
1.9 (63 kw)	2003.04-2009.11		Centre	Chassis cabin FWD AXC		Center Bearing Support	514809
	2003.04-2009.11		Centre	VAN FWD AXC		Center Bearing Support	514809
1.9 (75 kw)	2006.01-2009.11		Centre	Chassis cabin FWD BRS		Center Bearing Support	514809
	2006.01-2009.11		Centre	VAN FWD BRS		Center Bearing Support	514809
1.9 (77 kw)	2003.04-2009.11		Centre	Chassis cabin FWD AXB		Center Bearing Support	514809
	2003.04-2009.11		Centre	VAN FWD AXB		Center Bearing Support	514809
2.0 (62 kw)	1990.09-2000.05		Centre	BUS FWD AAC		Center Bearing Support	514801
	1990.09-2003.04		Centre	Chassis cabin FWD AAC		Center Bearing Support	514801
	1990.09-2003.04		Centre	VAN FWD AAC		Center Bearing Support	514801
	2009.08-2015.08		Centre	Chassis cabin FWD CAAA		Center Bearing Support	514809
	2009.09-2015.08		Centre	VAN FWD CAAA		Center Bearing Support	514809
2.0 (75 kw)	2009.09-2015.08		Centre	BUS FWD CAAA		Center Bearing Support	514809
	2009.09-2015.08		Centre	VAN FWD CAAB		Center Bearing Support	514809
	2009.09-2015.08		Centre	Chassis cabin FWD CAAB		Center Bearing Support	514809
2.0 (84 kw)	2011.04-2015.08		Centre	BUS FWD CAAB		Center Bearing Support	514809
	2011.05-2015.08		Centre	Chassis cabin FWD CAAD		Center Bearing Support	514809
	2011.05-2015.08		Centre	VAN FWD CAAD		Center Bearing Support	514809
2.0 (85 kw)	2011.05-2015.08		Centre	BUS FWD CAAD		Center Bearing Support	514809
	2003.11-2011.05		Centre	Chassis cabin FWD AXACNG		Center Bearing Support	514809
	2003.11-2015.08		Centre	VAN FWD AXA		Center Bearing Support	514809
	2003.11-2015.08		Centre	Chassis cabin FWD AXA		Center Bearing Support	514809
	2009.09-2013.05		Centre	BUS FWD AXA		Center Bearing Support	514809
2.0 (100 kw)	2009.09-2015.08		Centre	BUS FWD AXACNG		Center Bearing Support	514809
	2010.05-2015.08		Centre	Chassis cabin 4WD CAAE/CCHB		Center Bearing Support	514809
	2010.05-2015.08		Centre	Chassis cabin FWD CAAE		Center Bearing Support	514809
	2010.05-2015.08		Centre	VAN 4WD CAAE/CCHB		Center Bearing Support	514809
	2010.05-2015.08		Centre	VAN FWD CAAE/CCHB		Center Bearing Support	514809
	2010.05-2015.08		Centre	BUS 4WD CAAE/CCHB		Center Bearing Support	514809
2.0 (103 kw)	2010.05-2015.08		Centre	BUS FWD CAAE/CCHB		Center Bearing Support	514809
	2009.09-2015.08		Centre	VAN 4WD CAAC/CCHA		Center Bearing Support	514809
	2009.09-2015.08		Centre	VAN FWD CAAC/CCHA		Center Bearing Support	514809
	2009.09-2015.08		Centre	Chassis cabin 4WD CAAC/CCHA		Center Bearing Support	514809
	2009.09-2015.08		Centre	Chassis cabin FWD CAAC/CCHA		Center Bearing Support	514809
	2009.09-2015.08		Centre	BUS FWD CAAC/CCHA		Center Bearing Support	514809
	2009.10-2015.08		Centre	BUS 4WD CAAC/CCHA		Center Bearing Support	514809
2.0 (110 kw)	2011.05-2015.08		Centre	BUS FWD CJKB		Center Bearing Support	514809
	2012.07-2015.08		Centre	Chassis cabin FWD CJKB		Center Bearing Support	514809
	2012.07-2015.08		Centre	VAN FWD CJKB		Center Bearing Support	514809
2.0 (132 kw)	2009.09-2015.08		Centre	VAN FWD CFCA		Center Bearing Support	514809
	2009.09-2015.08		Centre	Chassis cabin FWD CFCA		Center Bearing Support	514809
	2009.09-2015.08		Centre	BUS FWD CFCA		Center Bearing Support	514809
	2010.01-2015.08		Centre	VAN 4WD CFCA		Center Bearing Support	514809
	2010.01-2015.08		Centre	Chassis cabin 4WD CFCA		Center Bearing Support	514809
	2010.01-2015.08		Centre	BUS 4WD CFCA		Center Bearing Support	514809
2.0 (150 kw)	2011.05-2015.08		Centre	VAN FWD CJKA		Center Bearing Support	514809
	2011.05-2015.08		Centre	BUS 4WD CJKA		Center Bearing Support	514809
	2011.05-2015.08		Centre	BUS FWD CJKA		Center Bearing Support	514809
	2011.07-2015.08		Centre	VAN 4WD CJKA		Center Bearing Support	514809
2.4 (55 kw)	1997.04-1999.04		Centre	Chassis cabin FWD AJA		Center Bearing Support	514801
	1997.04-2003.06		Centre	BUS FWD AJA		Center Bearing Support	514801
	1997.04-2003.06		Centre	VAN FWD AJA		Center Bearing Support	514801
2.4 (57 kw)	1990.09-1998.04		Centre	BUS FWD AAB		Center Bearing Support	514801
	1990.09-1998.04		Centre	VAN FWD AAB		Center Bearing Support	514801
	1990.09-1999.05		Centre	Chassis cabin FWD AAB		Center Bearing Support	514801
	1992.03-2000.05		Centre	Chassis cabin 4WD AAB		Center Bearing Support	514801
	1992.03-2000.05		Centre	VAN 4WD AAB		Center Bearing Support	514801
	1992.03-2000.05		Front	Chassis cabin 4WD AAB		Flexible Coupling	537853
	1992.03-2000.05		Front	VAN 4WD AAB		Flexible Coupling	537853
1996.01-2000.05		Centre	BUS 4WD AAB		Center Bearing Support	514801	

	 YEAR	TRANSM.	FITTING POSITION	BODY STYLE & DRIVE TYPE & ENGINE	REMARKS	 PRODUCT	GSP Ref.
VW Transporter							
2.4 (57 kw)	1996.01-2000.05		Front	BUS 4WD AAB		Flexible Coupling	537853
2.5 (65 kw)	1998.05-2003.04		Centre	BUS FWD AJT/AYY		Center Bearing Support	514801
	1998.05-2003.04		Centre	VAN FWD AJT/AYY		Center Bearing Support	514801
	1998.05-2003.04		Centre	Chassis cabin FWD AJT/AYY		Center Bearing Support	514801
2.5 (75 kw)	1994.07-2003.04		Centre	VAN FWD ACV/AUF/AYC		Center Bearing Support	514801
	1995.08-2003.04		Centre	Chassis cabin 4WD ACV/AXL		Center Bearing Support	514801
	1995.08-2003.04		Front	Chassis cabin 4WD ACV/AXL		Flexible Coupling	537853
	1995.08-2003.06		Centre	Chassis cabin FWD ACV/AUF/AYC		Center Bearing Support	514801
	1995.09-2003.04		Centre	BUS FWD ACV/AUF/AYC		Center Bearing Support	514801
	1996.01-2003.04		Centre	BUS 4WD ACV/AXL		Center Bearing Support	514801
	1996.01-2003.04		Front	BUS 4WD ACV/AXL		Flexible Coupling	537853
	1996.01-2003.06		Centre	VAN 4WD ACV/AXL		Center Bearing Support	514801
	1996.01-2003.06		Front	VAN 4WD ACV/AXL		Flexible Coupling	537853
2.5 (81 kw)	1990.09-2000.05		Centre	BUS FWD AAF/ACU/AEN/AEU		Center Bearing Support	514801
	1990.09-2000.05		Centre	Chassis cabin FWD AAF/ACU/AEN/AEU		Center Bearing Support	514801
	1990.11-2003.04		Centre	VAN FWD AAF/ACU/AEN/AEU		Center Bearing Support	514801
	1992.11-2001.11		Centre	Chassis cabin 4WD AAF/ACU/AEU		Center Bearing Support	514801
	1992.11-2001.11		Front	Chassis cabin 4WD AAF/ACU/AEU		Flexible Coupling	537853
	1996.01-2001.11		Centre	VAN 4WD ACU/AEU		Center Bearing Support	514801
	1996.01-2001.11		Front	VAN 4WD ACU/AEU		Flexible Coupling	537853
	1996.01-2003.04		Centre	BUS 4WD ACU/AEU		Center Bearing Support	514801
	1996.01-2003.04		Front	BUS 4WD ACU/AEU		Flexible Coupling	537853
2.5 (85 kw)	1996.08-2003.04		Centre	BUS 4WD AET/AVT		Center Bearing Support	514801
	1996.08-2003.04		Centre	BUS FWD AET/APL/AVT		Center Bearing Support	514801
	1996.08-2003.04		Centre	VAN 4WD AET/APL/AVT		Center Bearing Support	514801
	1996.08-2003.04		Centre	VAN FWD AET/APL/AVT		Center Bearing Support	514801
	1996.08-2003.04		Centre	Chassis cabin 4WD AET/APL/AVT		Center Bearing Support	514801
	1996.08-2003.04		Front	BUS 4WD AET/AVT		Flexible Coupling	537853
	1996.08-2003.04		Front	VAN 4WD AET/APL/AVT		Flexible Coupling	537853
	1996.08-2003.04		Front	Chassis cabin 4WD AET/APL/AVT		Flexible Coupling	537853
	1996.08-2003.06		Centre	Chassis cabin FWD AET/APL/AVT		Center Bearing Support	514801
2.5 (96 kw)	2003.04-2009.11		Centre	Chassis cabin FWD AXD/BNZ		Center Bearing Support	514809
	2003.04-2009.11		Centre	VAN FWD AXD/BNZ		Center Bearing Support	514809
	2004.07-2009.11	6AT/6MT	Rear	Chassis cabin 4WD AXD/BNZ	wheel base:3400mm,For PR code:0E2	Propshaft	PS900569
	2004.07-2009.11	6AT/6MT	Rear	VAN 4WD AXD/BNZ	wheel base:3400mm,For PR code:0E2	Propshaft	PS900569
	2004.07-2009.11	6AT/6MT	Rear	Chassis cabin 4WD AXD/BNZ	wheel base:3000mm,For PR code:0E1	Propshaft	PS900570
	2004.07-2009.11	6AT/6MT	Rear	VAN 4WD AXD/BNZ	wheel base:3000mm,For PR code:0E1	Propshaft	PS900570
	2004.07-2009.11		Front	Chassis cabin 4WD AXD/BNZ		Center Bearing Support	537799
	2004.07-2009.11		Front	VAN 4WD AXD/BNZ		Center Bearing Support	537799
	2004.07-2009.11		Rear	Chassis cabin 4WD AXD/BNZ		Center Bearing Support	537800
	2004.07-2009.11		Rear	VAN 4WD AXD/BNZ		Center Bearing Support	537800
	2004.07-2009.11		Centre	Chassis cabin 4WD AXD/BNZ		Center Bearing Support	514809
2004.07-2009.11		Centre	VAN 4WD AXD/BNZ		Center Bearing Support	514809	
2.5 (111 kw)	1998.05-2003.04		Centre	VAN FWD AHY/AXG		Center Bearing Support	514801
2.5 (128 kw)	2003.05-2009.11		Centre	Chassis cabin FWD AXE/BPC		Center Bearing Support	514809
	2003.05-2009.11		Centre	VAN FWD AXE/BPC		Center Bearing Support	514809
	2003.10-2009.11	6AT/6MT	Rear	Chassis cabin 4WD AXE/BPC	wheel base:3400mm,For PR code:0E2	Propshaft	PS900569
	2003.10-2009.11	6AT/6MT	Rear	Chassis cabin 4WD AXE/BPC	wheel base:3000mm,For PR code:0E1	Propshaft	PS900570
	2003.10-2009.11		Front	Chassis cabin 4WD AXE/BPC		Center Bearing Support	537799
	2003.10-2009.11		Rear	Chassis cabin 4WD AXE/BPC		Center Bearing Support	537800
	2003.10-2009.11		Centre	Chassis cabin 4WD AXE/BPC		Center Bearing Support	514809
	2004.07-2009.11	6AT/6MT	Rear	VAN 4WD AXE/BPC	wheel base:3400mm,For PR code:0E2	Propshaft	PS900569
	2004.07-2009.11	6AT/6MT	Rear	VAN 4WD AXE/BPC	wheel base:3000mm,For PR code:0E1	Propshaft	PS900570
	2004.07-2009.11		Front	VAN 4WD AXE/BPC		Center Bearing Support	537799
	2004.07-2009.11		Rear	VAN 4WD AXE/BPC		Center Bearing Support	537800
	2004.07-2009.11		Centre	VAN 4WD AXE/BPC		Center Bearing Support	514809
	2.8 (103 kw)	1996.01-2000.05		Centre	BUS FWD AES		Center Bearing Support
2.8 (150 kw)	2000.06-2003.04		Centre	BUS FWD AMV		Center Bearing Support	514801
3.2 (170 kw)	2003.11-2009.11		Centre	Chassis cabin 4WD BDL		Center Bearing Support	514809
	2004.02-2004.06		Centre	VAN FWD BDL		Center Bearing Support	514809
	2004.02-2009.11		Centre	Chassis cabin FWD BDL		Center Bearing Support	514809
	2004.03-2005.06		Centre	VAN 4WD BDL		Center Bearing Support	514809
3.2 (173 kw)	2003.08-2006.05		Centre	Chassis cabin FWD BKK		Center Bearing Support	514809
	2004.02-2009.11		Centre	VAN FWD BKK/CFLA		Center Bearing Support	514809

	 YEAR	TRANSM.	FITTING POSITION	BODY STYLE & DRIVE TYPE & ENGINE	REMARKS	 PRODUCT	GSP Ref.
VW							
Transporter							
3.2 (173 kw)	2004.07-2009.11	6AT/6MT	Rear	VAN 4WD BKK/CFLA	wheel base:3400mm,For PR code:0E2	Propshaft	PS900569
	2004.07-2009.11	6AT/6MT	Rear	VAN 4WD BKK/CFLA	wheel base:3000mm,For PR code:0E1	Propshaft	PS900570
	2004.07-2009.11		Front	VAN 4WD BKK/CFLA		Center Bearing Support	537799
	2004.07-2009.11		Rear	VAN 4WD BKK/CFLA		Center Bearing Support	537800
	2004.07-2009.11		Centre	VAN 4WD BKK/CFLA		Center Bearing Support	514809
Transporter Shuttle							
1.9 (62 kw)	2006.01-2009.11		Centre	BUS FWD BRR		Center Bearing Support	514809
1.9 (63 kw)	2003.04-2009.11		Centre	BUS FWD AXC		Center Bearing Support	514809
1.9 (75 kw)	2005.06-2009.11		Centre	BUS FWD BRS		Center Bearing Support	514809
1.9 (77 kw)	2003.04-2009.11		Centre	BUS FWD AXB		Center Bearing Support	514809
2.0 (62 kw)	2009.09-2015.08		Centre	BUS FWD CAAA		Center Bearing Support	514809
2.0 (75 kw)	2009.09-2015.08		Centre	BUS FWD CAAB		Center Bearing Support	514809
2.0 (84 kw)	2011.05-2015.08		Centre	BUS FWD CAAD		Center Bearing Support	514809
2.0 (85 kw)	2003.11-2009.11		Centre	BUS FWD AXA		Center Bearing Support	514809
2.0 (103 kw)	2009.09-2015.08		Centre	BUS FWD CAAC/CCHA		Center Bearing Support	514809
	2009.10-2015.08		Centre	BUS 4WD CAAC/CCHA		Center Bearing Support	514809
2.0 (132 kw)	2011.05-2015.08		Centre	BUS 4WD CFCA		Center Bearing Support	514809
	2011.05-2015.08		Centre	BUS FWD CFCA		Center Bearing Support	514809
2.5 (96 kw)	2003.04-2009.11		Centre	BUS FWD AXD/BNZ		Center Bearing Support	514809
	2004.07-2009.11	6MT	Rear	BUS 4WD AXD	wheel base:3400mm,For PR code:0E2	Propshaft	PS900569
	2004.07-2009.11	6MT	Rear	BUS 4WD AXD	Check to Item 764-100-001, wheel base 3000mm,For PR code:0E1	Propshaft	PS900570
	2004.07-2009.11		Front	BUS 4WD AXD		Center Bearing Support	537799
	2004.07-2009.11		Rear	BUS 4WD AXD		Center Bearing Support	537800
	2004.07-2009.11		Centre	BUS 4WD AXD		Center Bearing Support	514809
2.5 (120 kw)	2003.11-2009.11		Centre	BUS FWD BLJ		Center Bearing Support	514809
2.5 (128 kw)	2004.07-2009.11		Front	BUS 4WD AXE		Center Bearing Support	537799
	2004.07-2009.11		Rear	BUS 4WD AXE		Center Bearing Support	537800
	2004.07-2009.11		Centre	BUS FWD AXE/BPC		Center Bearing Support	514809
	2004.07-2009.11		Centre	BUS 4WD AXE		Center Bearing Support	514809
3.2 (170 kw)	2004.02-2004.06		Centre	BUS FWD BDL		Center Bearing Support	514809
3.2 (173 kw)	2003.11-2009.12	6MT	Rear	BUS 4WD BKK/CFLA	wheel base:3400mm,For PR code:0E2	Propshaft	PS900569
	2003.11-2009.12	6MT	Rear	BUS 4WD BKK/CFLA	Check to Item 764-100-001, wheel base 3000mm,For PR code:0E1	Propshaft	PS900570
	2003.11-2009.12		Front	BUS 4WD BKK/CFLA		Center Bearing Support	537799
	2003.11-2009.12		Rear	BUS 4WD BKK/CFLA		Center Bearing Support	537800
	2003.11-2009.12		Centre	BUS 4WD BKK/CFLA		Center Bearing Support	514809
	2004.02-2009.11		Centre	BUS FWD BKK		Center Bearing Support	514809
VW (SVW)							
Tiguan							
1.8 (118 kw)	2010.03-		Rear	SUV 4WD CEAA		Propshaft	PS900519
2.0 (147 kw)	2010.03-		Rear	SUV 4WD CGMA		Propshaft	PS900519

Drive Line Part

Photo.....

201406		201782		201958		201972	
CHRYSLER	52105990AA	JEEP	52105884AA	MERCEDES-BENZ	1644100501	FORD	6L2Z4A376B
CHRYSLER	52123021AA			MERCEDES-BENZ	1644100701		
CHRYSLER	52123021AB			MERCEDES-BENZ	A1644100501		
				MERCEDES-BENZ	A1644100701		





202065		202067		202068		202072	
MERCEDES-BENZ	4634100102	MERCEDES-BENZ	4634100202	MERCEDES-BENZ	4634100502	MERCEDES-BENZ	4634100902
MERCEDES-BENZ	A4634100102	MERCEDES-BENZ	A4634100202	MERCEDES-BENZ	A4634100502	MERCEDES-BENZ	A4634100902

202100		202101		202102		202280	
CHRYSLER	52853641AD	JEEP	52853431AA	JEEP	52853432AA	CHRYSLER	52105758AB
DODGE	52853641AC					CHRYSLER	52105758AE
DODGE	52853641AE					JEEP	52105758AD

Drive Line Part

Photo.....

202281		202398		202440		202442	
CHRYSLER	52105728AB	MERCEDES-BENZ	4634100106	CHRYSLER	52099497	JEEP	52099498AB
CHRYSLER	52105728AC	MERCEDES-BENZ	A4634100106	JEEP	52099497AD	JEEP	52099498AD
CHRYSLER	52105728AE					JEEP	52099498AE
							

299302		299303		299304		510434S	
FORD	AL3Z4A376D	HUMMER	15860584	CHEVROLET	15114531	MERCEDES-BENZ	1244100115
		HUMMER	25859867	CHEVROLET	15188059	MERCEDES-BENZ	1244100615
				GENERAL MOTORS	15038488	MERCEDES-BENZ	1244100715
				GENERAL MOTORS	15762970	MERCEDES-BENZ	1264100515
				GENERAL MOTORS	26032451	MERCEDES-BENZ	A1244100115
				GENERAL MOTORS	94717722	MERCEDES-BENZ	A1244100615
						MERCEDES-BENZ	A1244100715
						MERCEDES-BENZ	A1264100515
							

510436		510453		510458		510459S	
MERCEDES-BENZ	1234110315	MERCEDES-BENZ	2014100581	MERCEDES-BENZ	2024100615	MERCEDES-BENZ	2014100715
MERCEDES-BENZ	1244110415	MERCEDES-BENZ	2014100581S			MERCEDES-BENZ	2024101015
MERCEDES-BENZ	A1234110315					MERCEDES-BENZ	A2014100715
MERCEDES-BENZ	A1244110415					MERCEDES-BENZ	A2024101015
							

Drive Line Part

Photo.....





<p>510460</p> <p>MERCEDES-BENZ 1244110015 MERCEDES-BENZ 2024110615</p> 	<p>510489</p> <p>MERCEDES-BENZ 6014101210</p> 	<p>510503</p> <p>MERCEDES-BENZ 6014102110 MERCEDES-BENZ 9014110312 MERCEDES-BENZ 9014110412 MERCEDES-BENZ A9014110312 MERCEDES-BENZ A9014110412 VW 2D0521351</p> 	<p>510511</p> <p>MERCEDES-BENZ 1244100181 MERCEDES-BENZ 1244100181S MERCEDES-BENZ 1244100681 MERCEDES-BENZ 1244100681S</p> 
---	--	--	---

<p>510568</p> <p>MERCEDES-BENZ 2104101281 MERCEDES-BENZ 2104101881 MERCEDES-BENZ 2104101881S</p> 	<p>510569</p> <p>MERCEDES-BENZ 1244110115 MERCEDES-BENZ 1244110615 MERCEDES-BENZ 2024100315</p> 	<p>510570S</p> <p>MERCEDES-BENZ 1244100215 MERCEDES-BENZ 1244110115 MERCEDES-BENZ 1244110615 MERCEDES-BENZ 2014101715 MERCEDES-BENZ 2024100315 MERCEDES-BENZ 2024101315 MERCEDES-BENZ A1244100215 MERCEDES-BENZ A2014101715</p> 	<p>510571</p> <p>MERCEDES-BENZ 1244110515</p> 
---	--	---	--

<p>510571S</p> <p>MERCEDES-BENZ 1294100215 MERCEDES-BENZ 2104101115 MERCEDES-BENZ A1294100215 MERCEDES-BENZ A2104101115</p> 	<p>510575</p> <p>MERCEDES-BENZ 1074110015 MERCEDES-BENZ 1074110215 MERCEDES-BENZ 1264110215</p> 	<p>510576S</p> <p>MERCEDES-BENZ 1074100015 MERCEDES-BENZ 1075860041 MERCEDES-BENZ 1264100415 MERCEDES-BENZ A1264100415</p> 	<p>510578S</p> <p>MERCEDES-BENZ 2024101115 MERCEDES-BENZ A2024101115</p> 
--	--	--	---

Drive Line Part

Photo.....

<p>510579</p> <p>MERCEDES-BENZ 1244110215 MERCEDES-BENZ 2104110515 MERCEDES-BENZ A1244110215</p> 	<p>510579S</p> <p>MERCEDES-BENZ 1704100215 MERCEDES-BENZ A1704100215</p> 	<p>510580S</p> <p>MERCEDES-BENZ 1294100015 MERCEDES-BENZ 1704100015 MERCEDES-BENZ 2024100915 MERCEDES-BENZ 2024101915 MERCEDES-BENZ 2104100815 MERCEDES-BENZ A1294100015 MERCEDES-BENZ A1704100015 MERCEDES-BENZ A2024100915</p> 	<p>510596</p> <p>BMW 26111209168 BMW 26111227420 BMW 26117511454 BMW 7511454 VOLVO 1220843</p> 
---	--	---	---

<p>510596S</p> <p>BMW 26111209168 BMW 26111227420 BMW 26117511454</p> 	<p>510597</p> <p>BMW 26111227410 BMW 26111227869 BMW 26111229516</p> 	<p>510597S</p> <p>BMW 26111227410 BMW 26111227869</p> 	<p>510599</p> <p>BMW 26112225620 BMW 26121225774 BMW 26121225774S BMW 26121226415 BMW 26121226415S BMW 26121226723 BMW 26121226723S</p> 
--	---	--	--

<p>510627</p> <p>BMW 26121225152</p> 	<p>510641</p> <p>BMW 26111204294 BMW 26111207785 BMW 26111225624 BMW 26117503159</p> 	<p>510641S</p> <p>BMW 26111204294 BMW 26111207785 BMW 26111225624</p> 	<p>510658</p> <p>BMW 26121227997</p> 
---	--	---	---

Drive Line Part

Photo.....

510659		510663		511086		511086S	
BMW	26121226731	BMW	26111227690	TOYOTA	0437428010	TOYOTA	0437428010
BMW	26121229089	BMW	26111229065	TOYOTA	0437428011	TOYOTA	0437428011
							

511380		511381		511573		511574	
FORD	6649122	FORD	1810012	MERCEDES-BENZ 1634100010		MERCEDES-BENZ 1244100281	
FORD	6649122S2	FORD	4060617			MERCEDES-BENZ 1244100281S	
FORD	92VB4826BB	FORD	4060617S1			MERCEDES-BENZ 1244100781	
		FORD	4104708			MERCEDES-BENZ 1244100781S	
		FORD	6635542			MERCEDES-BENZ 1244100781S1	
		FORD	7239265				
		FORD	92VB4826CA				
		FORD	95VB4826AA				
							

511891		511891S		512089		512090	
NISSAN	3752132G25	NISSAN	3752133G25	TOYOTA	3723022140	TOYOTA	372300K030
NISSAN	3752133G25	NISSAN	3752156G25	TOYOTA	3723024010	TOYOTA	372300K040
NISSAN	3752134G25	NISSAN	3752156G26			TOYOTA	3723034010
NISSAN	3752136G25	NISSAN	C752156G27			TOYOTA	3723035120
NISSAN	3752156G25						
NISSAN	3752156G26						
NISSAN	3752156G27						
NISSAN	3752157G25						
							

Drive Line Part

Photo.....

512091	512093	512094	512301
TOYOTA 3723035130	TOYOTA 3723035090	TOYOTA 3723026020	BMW 26121229492 BMW 26127501257
			

512315	512316	512326	512369
MERCEDES-BENZ 2024100281 MERCEDES-BENZ 2024100481 MERCEDES-BENZ 2024100481S1	MERCEDES-BENZ 2024100381 MERCEDES-BENZ 2024100381S MERCEDES-BENZ 2024100581 MERCEDES-BENZ 2024100581S MERCEDES-BENZ 2024100581S1	MERCEDES-BENZ 2024100015 MERCEDES-BENZ 2024101115 MERCEDES-BENZ A2024100015 MERCEDES-BENZ A2024101115	TOYOTA 3723035060 TOYOTA 3723035061 TOYOTA 3723035080 TOYOTA 3723035100
			

512464	512668	512671S	512672
GENERAL MOTORS 90470670 OPEL 0458014 OPEL 458014	MERCEDES-BENZ 2104101681 MERCEDES-BENZ 2104101981 MERCEDES-BENZ 2114100081 MERCEDES-BENZ 2114100081S1	MERCEDES-BENZ 1294100115 MERCEDES-BENZ A1294100115	MERCEDES-BENZ 2034100015 MERCEDES-BENZ A2034100015
			

Drive Line Part

Photo.....

<p>512672S</p> <p>MERCEDES-BENZ 1404100315 MERCEDES-BENZ A1404100315</p> 	<p>512673S</p> <p>MERCEDES-BENZ 0004110000 MERCEDES-BENZ 1704100115 MERCEDES-BENZ 2024101815 MERCEDES-BENZ 2104101215 MERCEDES-BENZ 2104110415 MERCEDES-BENZ 2104110415S MERCEDES-BENZ 2114100115 MERCEDES-BENZ A0004110000</p> 	<p>512676</p> <p>MERCEDES-BENZ 1294110015</p> 	<p>512677</p> <p>CHRYSLER 05127291AA CHRYSLER 5127291AA CHRYSLER K05127291AA MERCEDES-BENZ 0004110200 MERCEDES-BENZ 0004110200SK MERCEDES-BENZ 2034100215 MERCEDES-BENZ 2034100215SK MERCEDES-BENZ 2034110015</p> 
---	--	---	--

<p>512677S</p> <p>MERCEDES-BENZ 0004110200 MERCEDES-BENZ 1404100415 MERCEDES-BENZ 2034100215 MERCEDES-BENZ 2034110015 MERCEDES-BENZ 2104100615 MERCEDES-BENZ 2304100115 MERCEDES-BENZ A0004110200 MERCEDES-BENZ A1404100415</p> 	<p>512678</p> <p>MERCEDES-BENZ 1704100115 MERCEDES-BENZ 1714110015 MERCEDES-BENZ 2104110415 MERCEDES-BENZ 5144110015 MERCEDES-BENZ A1714110015 MERCEDES-BENZ A2104110415</p> 	<p>512678S</p> <p>MERCEDES-BENZ 2114100115 MERCEDES-BENZ A2114100115</p> 	<p>512692</p> <p>BMW 26121226442 BMW 26121226657</p> 
--	---	--	---

<p>513001</p> <p>TOYOTA 3723020130 TOYOTA 3723029025</p> 	<p>513040</p> <p>LEXUS 3723059015</p> 	<p>513040S</p> <p>LEXUS 3723059015</p> 	<p>513041</p> <p>TOYOTA 3723022190</p> 
---	--	--	---

Drive Line Part

Photo.....

513042		513043		513053		513053S	
TOYOTA	3723030152	TOYOTA	3723039035	TOYOTA	0437428020	TOYOTA	0437428020
							

513055		513557		513559		513562	
TOYOTA	3723030090	TOYOTA	3723035070	TOYOTA	3723036061	TOYOTA	3723026010
		TOYOTA	3723035080				
		TOYOTA	3723035100				
							

513565		513582		513763		513771	
NISSAN	3752106R25	MITSUBISHI	MB154199	TOYOTA	3723035050	BMW	26127521855
NISSAN	3752106R26	MITSUBISHI	MB154706	TOYOTA	3723035070		
NISSAN	3752141L25	MITSUBISHI	MR357998				
NISSAN	3752141L28						
NISSAN	3752154C25						
NISSAN	37521P0125						
NISSAN	37521P0126						
NISSAN	37521Q0125						
							

Drive Line Part

Photo.....

513772		514085		514780		514781	
BMW	26127521856	TOYOTA	3723042010	SUBARU	27031FC001	AUDI	1000008900022
				SUBARU	27031FC030	AUDI	7L0521101A
				SUBARU	27031FC041	AUDI	7L0521101B
						AUDI	7L0521101D
						AUDI	7L0521101F
						AUDI	7L0521101G
						AUDI	7L0521101H
						PORSCHE	7L6521102B
							

514782		514783		514785		514786	
HONDA	40520SR7J01	ISUZU	5375160051	TOYOTA	3710087402	MITSUBISHI	MB505495
		ISUZU	5375160061	TOYOTA	3710087403	MITSUBISHI	MB837388
							

514788		514789S		514790S		514791S	
HONDA	40100S2H003	LEXUS	3723048010	NISSAN	375215C525	INFINITI	37000JD000
HONDA	40100S4N003	LEXUS	3723049015			INFINITI	3752106R25
		TOYOTA	3723059035			INFINITI	375216P026
						NISSAN	3752106R26
						NISSAN	3752141L25
						NISSAN	3752141L28
						NISSAN	3752154C25
						NISSAN	37521Q0125
							

Drive Line Part

Photo.....

514792		514793		514793S		514795S	
BMW	26121229726	HYUNDAI	493002E000	HYUNDAI	493002E000	MERCEDES-BENZ	5154106882
BMW	26127507740			HYUNDAI	495752E000	MERCEDES-BENZ	5154107282
						MERCEDES-BENZ	9064100281
						MERCEDES-BENZ	9064100281SK
						MERCEDES-BENZ	9064100681
						MERCEDES-BENZ	9064100681SK
						MERCEDES-BENZ	9064100881
						MERCEDES-BENZ	9064100881SK

514796		514797		514798S		514799	
mitsubishi	MR953919	mitsubishi	3450A017	LAND ROVER	TOQ000010	LAND ROVER	LR037027
		mitsubishi	MR580647	LAND ROVER	TOQ000040	LAND ROVER	TVB500360

514800S		514801		514802		514803	
CITROËN	280191	FORD	02G409335A	CHEVROLET	0446073	SUBARU	27111AG220
MITSUBISHI	3401A022	FORD	1094821	CHEVROLET	20781756		
		FORD	7222317	CHEVROLET	446073		
		FORD	96BG3C08E1A	CHEVROLET	4807201		
				CHEVROLET	96624772		

Drive Line Part

Photo.....

514804	514805	514806S	514807
SUBARU 27111SA011	SSANGYONG 3320008000 SSANGYONG 3320008300	FORD 1454605 FORD 5031497 MAZDA SA6825300 MAZDA SA6825300A	MERCEDES-BENZ 9064100181 MERCEDES-BENZ 9064100381 MERCEDES-BENZ 9064101781 MERCEDES-BENZ A9064100101 MERCEDES-BENZ A9064103401 VW 2E0598351C
			

514808	514808S	514809	514810
AUDI 5N0521101C	AUDI 5N0521101C AUDI 5N0521101E	VW 7H0407181 VW 7H0407181B	MAZDA KG0325109U
			



514811	514811S	514812	514813S
HYUNDAI 495752P000	HYUNDAI 493002P100 HYUNDAI 495752P000	MAZDA PH0125100	LEXUS 3723039095
			

Drive Line Part

Photo.....

514814		514815		514816		514817	
MAZDA	PH0125100B	MAZDA	KG0325109U	HONDA	40100S9AE01	HONDA	40100S10A01
				HONDA	40100S9AJ01	HONDA	40520S10003
							

514818		514819		514820		514821	
HYUNDAI	4913026000	MITSUBISHI	MN171429	MITSUBISHI	MR196669	MITSUBISHI	MR953922
HYUNDAI	491304A000	MITSUBISHI	MR223119				
HYUNDAI	491304A400						
MITSUBISHI	MR165252						
MITSUBISHI	MR357998						
							

514822		514823		514824		514824S	
TOYOTA	3723028010	TOYOTA	3723012120	TOYOTA	3723019015	TOYOTA	3723019015
		TOYOTA	3723012170				
							

Drive Line Part

Photo.....

517185		517626		517627		517682	
BMW	26121229242	LEXUS	3723030110	LEXUS	3723030170	MAZDA	P03025310A
		LEXUS	3723050010			MAZDA	P03025310C
		TOYOTA	3723030130				
		TOYOTA	3723030160				
							

517683S		517684		517747		517955	
MAZDA	SA5125300	TOYOTA	3720735011	MERCEDES-BENZ	2024100715	BMW	26117546425
		TOYOTA	3723036140	MERCEDES-BENZ	2024110515	BMW	26117610061
				MERCEDES-BENZ	A2024110515		
							





517955S		517956		517956S		517957	
BMW	26117546425	BMW	26117512619	BMW	26117512619	PORSCHE	95542101000
BMW	26117605629	BMW	26117573276	BMW	26117573276	PORSCHE	95542102011
BMW	26117610061					PORSCHE	95542102012
						PORSCHE	95542102013
						PORSCHE	95542102014
						PORSCHE	95542102015
						PORSCHE	95542102021
						VW	7L0521102B
							

Drive Line Part

Photo.....

517957S	518107	518108	518416
PORSCHE 95542101000 PORSCHE 95542102021 VW 7L0521403 VW 7L6521403	ALFA ROMEO 7541164	ALFA ROMEO 10179037 ALFA ROMEO 808682	MERCEDES-BENZ 1704100081 MERCEDES-BENZ 2034102081 MERCEDES-BENZ A2034102081
			



518418	518419S	518878	519034
BMW 26123413997	MERCEDES-BENZ 6014101510 MERCEDES-BENZ 6014101710 MERCEDES-BENZ 6015860041 MERCEDES-BENZ A6014101510 MERCEDES-BENZ A6014101710 MERCEDES-BENZ A6015860041	TOYOTA 372300K010 TOYOTA 372300K011 TOYOTA 372300K020 TOYOTA 372300K021	DAIHATSU 37230BZ010
			

519035S	519036S	519037	519580
LEXUS 3710042080	TOYOTA 3723039045	PORSCHE 95542102015 VW 7L0521102D VW 7L0521102H VW 7L6521102P	HYUNDAI 4919026000 HYUNDAI 491902EB00
			

Drive Line Part

Photo.....

530151		530152		530153		530154	
BMW	26127526631	BMW	26127526632	BMW	26127507318	BMW	26121229317
BMW	26127597883	BMW	26128615622	BMW	26127513218	BMW	26121229682
BMW	26128615621						
							

530160		530160S		530178		530187	
BMW	26111229754	BMW	26111229754	MERCEDES-BENZ	1404100781	VOLVO	1340501
BMW	261117572664	BMW	261117572664	MERCEDES-BENZ	1404100781S		
							

530440		530473		530758		530758S	
MITSUBISHI	MR553202	MERCEDES-BENZ	1634100010	BMW	26117542238	BMW	26117542238
				BMW	7542238		
							

Drive Line Part

Photo.....

530764	531013	531014	531016
ISUZU 8979428770	BMW 26127599802	BMW 26127564694	BMW 26127629466
			

531018	531020S	531021S	531026
BMW 26127564695	MERCEDES-BENZ 6394100681 MERCEDES-BENZ A6394100681	MERCEDES-BENZ 6394100481 MERCEDES-BENZ A6394100481	BMW 26103413996
			

531028S	531031	531049	531050
MERCEDES-BENZ 05104574AA MERCEDES-BENZ 2D0598351A MERCEDES-BENZ 5104574AA MERCEDES-BENZ 9014110415 MERCEDES-BENZ 9014110415S1 MERCEDES-BENZ 9034100010 MERCEDES-BENZ A9034100010 VW 2D0598351	BMW 26122282496 BMW 26127501258 BMW 26127506783	IVECO 042535254 IVECO 42535254 IVECO 42554407 IVECO 42561251	IRISBUS 042538439 IRISBUS 093156460 IVECO 42538439 IVECO 93156460 IVECO 93157025
			

Drive Line Part

Photo.....

531051	531052	531053	531056
MERCEDES-BENZ 2044100981 MERCEDES-BENZ 2044100981S1 MERCEDES-BENZ 2044101181 MERCEDES-BENZ 2044101181S1 MERCEDES-BENZ 2044101581 MERCEDES-BENZ 2044101581S1	MERCEDES-BENZ 6394100681 MERCEDES-BENZ 6394100681S1	MERCEDES-BENZ 6394100481 MERCEDES-BENZ 6394100481S1	EVOBUS 0004110212 EVOBUS 9704110012
			

531058S	531656	531667S	531679S
MAN 81394106013 MAN 81394106017 MAN 81394106019	TOYOTA 372300K050	FIAT 42535254 IVECO 42554407 IVECO 42561251	HYUNDAI 495752B000
			

531680	532824	532827	532840
HYUNDAI 495752B000	TOYOTA 3723029015	MAZDA SA0225310	DAF 1288220 DAF 1323765 DAF 1435557 DAF 1779697
			

Drive Line Part

Photo.....





533418		533419		533420		533422	
FORD	4165078	HYUNDAI	491302B000	FORD	4393343	BMW	26117522027
FORD USA	2L1W4684AA	HYUNDAI	491303W000	FORD	YC1W4684AA		
		HYUNDAI	49300D3000				
		SSANGYONG	3320034000				
		SSANGYONG	3320034001				
		SSANGYONG	3320034100				
		SSANGYONG	3320034101				
							

533422S		533532		533533		533842	
BMW	26117522027	TOYOTA	3723009090	TOYOTA	3723009100	MERCEDES-BENZ	2214102581
						MERCEDES-BENZ	2214105081
						MERCEDES-BENZ	A2214102581
						MERCEDES-BENZ	A2214105081
							

533871		533878		533882		533882S	
BMW	26117589746	BMW	26117527392	AUDI	1K0521307	AUDI	5Q0521307
BMW	7589746			AUDI	1K0521307A	VW	1K0521307
				AUDI	5Q0521307	VW	1K0521307A
							

Drive Line Part

Photo.....

533884	533884S	537001	537625
<p>MERCEDES-BENZ 0004110600 MERCEDES-BENZ 0004110700 MERCEDES-BENZ 2094100215 MERCEDES-BENZ 2154100015 MERCEDES-BENZ 2214100415 MERCEDES-BENZ 2214110115 MERCEDES-BENZ 2404100215 MERCEDES-BENZ 2404100415</p> 	<p>MERCEDES-BENZ 0004110800 MERCEDES-BENZ 0004111000 MERCEDES-BENZ 2124100215 MERCEDES-BENZ A0004110800 MERCEDES-BENZ A0004111000 MERCEDES-BENZ A2124100215</p> 	<p>TOYOTA 3723010030 TOYOTA 3723010031 TOYOTA 3723059025</p> 	<p>BMW 26112226842 BMW 26117610372 GENERAL MOTORS 96RC100344 LAND ROVER TIJ000012</p> 

537625S	537626	537626S	537627
<p>BMW 26117610372</p> 	<p>AUDI 1J0521127 AUDI 1J0521127A VW 5Q0521127</p> 	<p>AUDI 1J0521127 AUDI 1J0521127A VW 5Q0521127</p> 	<p>MERCEDES-BENZ 2054110000 MERCEDES-BENZ A2054110000</p> 





537627S	537630	537630S	537631
<p>MERCEDES-BENZ 2054110000 MERCEDES-BENZ A2054110000</p> 	<p>MERCEDES-BENZ 1724110500 MERCEDES-BENZ 2054110100 MERCEDES-BENZ A1724110500</p> 	<p>MERCEDES-BENZ 2054110100 MERCEDES-BENZ A2054110100</p> 	<p>BMW 26111227717 BMW 26111229080 BMW 26111229360</p> 

Drive Line Part

Photo.....

537631S		537668		537668S		537669	
BMW	26111227717	BMW	26117546426	BMW	26117546426	BMW	26117518443
BMW	26111229080	MERCEDES-BENZ	5144110315				
BMW	26111229360						
							

537669S		537766		537769		537784	
BMW	26117518443	MERCEDES-BENZ	2224101081	FORD	1510905	MERCEDES-BENZ	2054100402
		MERCEDES-BENZ	A2224101081	FORD	1824066	MERCEDES-BENZ	A2054100402
				FORD	8C114826AA		
				FORD	8C114826AB		
							





537791S		537792S		537793S		537794S	
MERCEDES-BENZ	2024101615	MERCEDES-BENZ	0004111100	MERCEDES-BENZ	2114100215	MERCEDES-BENZ	2114100415
MERCEDES-BENZ	A2024101615	MERCEDES-BENZ	1644100015	MERCEDES-BENZ	A2114100215	MERCEDES-BENZ	A2114100415
RENAULT	8200058705	MERCEDES-BENZ	A0004111100				
		MERCEDES-BENZ	A1644100015				
							

Drive Line Part

Photo.....

<p>537796S</p> <p>MERCEDES-BENZ 2104100515 MERCEDES-BENZ A2104100515</p> 	<p>537797S</p> <p>MERCEDES-BENZ 2034100315 MERCEDES-BENZ A2034100315</p> 	<p>537798S</p> <p>BMW 26117503159</p> 	<p>537799</p> <p>VW 7H3521102A</p> 
---	---	---	---

<p>537800</p> <p>VW 7H3521102A</p> 	<p>537818</p> <p>CHRYSLER 05157005AD CHRYSLER 05157005AE CHRYSLER 05157005AF MERCEDES-BENZ 1764100100 MERCEDES-BENZ 2464110015 MERCEDES-BENZ 2474104800 MERCEDES-BENZ A1764100100 MERCEDES-BENZ A2464110015</p> 	<p>537819S</p> <p>MERCEDES-BENZ 2104101515 MERCEDES-BENZ 2104101615 MERCEDES-BENZ A2104101515 MERCEDES-BENZ A2104101615</p> 	<p>537820S</p> <p>MERCEDES-BENZ 2024100715 MERCEDES-BENZ A2024100715</p> 
---	--	---	---





<p>537821S</p> <p>MERCEDES-BENZ 2024100815 MERCEDES-BENZ A2024100815</p> 	<p>537822S</p> <p>MERCEDES-BENZ 2014101515 MERCEDES-BENZ 2014102015 MERCEDES-BENZ A2014101515 MERCEDES-BENZ A2014102015</p> 	<p>537832S</p> <p>MERCEDES-BENZ 0004110600 MERCEDES-BENZ 2094100215 MERCEDES-BENZ 2154100015 MERCEDES-BENZ 2304100015 MERCEDES-BENZ 2404100215 MERCEDES-BENZ 2404100415 MERCEDES-BENZ A0004110600 MERCEDES-BENZ A2094100215</p> 	<p>537843</p> <p>MERCEDES-BENZ 2404100115 MERCEDES-BENZ A2404100115</p> 
---	--	---	--

Drive Line Part

Photo.....

<p>537843S</p> <p>MERCEDES-BENZ 2044100215 MERCEDES-BENZ A2044100215</p> 	<p>537847</p> <p>MERCEDES-BENZ 2054101800 MERCEDES-BENZ A2054101800</p> 	<p>537848S</p> <p>MERCEDES-BENZ 2034100015 MERCEDES-BENZ A2034100015</p> 	<p>537849</p> <p>BMW 26118487178</p> 
---	--	--	---





<p>537850S</p> <p>MERCEDES-BENZ 2024101515 MERCEDES-BENZ A2024101515</p> 	<p>537851</p> <p>MERCEDES-BENZ 2054110200 MERCEDES-BENZ A2054110200</p> 	<p>537853</p> <p>VW 701521127 VW 7D0521127</p> 	<p>537854S</p> <p>MERCEDES-BENZ 1244100915 MERCEDES-BENZ A1244100915</p> 
---	--	--	---

<p>537889S</p> <p>MERCEDES-BENZ 0004110100 MERCEDES-BENZ A0004110100</p> 	<p>601297</p> <p>PORSCHE 95542102015</p> 	<p>601910</p> <p>LAND ROVER TVB500510</p> 	<p>602001</p> <p>ALFA ROMEO 700611</p> 
---	---	---	---

Drive Line Part

Photo.....

602148		602494		602495		605057	
VOLVO	30713272	LAND ROVER	TVB000450	LAND ROVER	TVB000450	BMW	26111229522
VOLVO	31216175					BMW	26117503103
						BMW	26117504667
						BMW	26117526822
							

608072		608073		616005		616011	
CHEVROLET	15114531	CHEVROLET	15114530	JEEP	52105884AA	CHEVROLET	52098379
		CHEVROLET	25833034	JEEP	52111591AB	CHEVROLET	52098501
		CHEVROLET	25833035	JEEP	52111593AB	CHEVROLET	52098850
				JEEP	52111594AA	CHEVROLET	52099246
				JEEP	52111596AB	CHEVROLET	52099260
				JEEP	52111597AA		
				JEEP	52853299AB		
							

618001		630003		635045		635046	
FORD	72GG4635BA	BMW	26117548392	KIA	15922549	CHEVROLET	10395274
FORD	92333203200	BMW	26117585922	KIA	15922550	CHEVROLET	22729203
HOLDEN	153120188003			KIA	491003E070	CHEVROLET	3AMW3B413AE
				KIA	491003E150	KIA	15296383
							

Drive Line Part

Photo.....

635047		635064		661093		661094	
FORD	2L8Z4R602AA	FIAT	55193595	AUDI	8R0521101B	AUDI	7L0521101H
FORD	2L8Z4R602DA	FIAT	55197051	AUDI	8R0521101J	AUDI	7L6521101M
FORD	7L8Z4R602A	FIAT	55222107	AUDI	8R0521101P	AUDI	7L6521101Q
FORD	7L8Z4R602B	FIAT	55264146	AUDI	8R0521101Q	VW	7H3521102A
FORD	7M6Z4R602A	FIAT	552641461				
VW	5L844K145BA	FIAT	552641462				
							

661100		699117		699195		699217	
FORD	1L2Z4A376AA	CHEVROLET	26035527	VOLVO	30614441	LAND ROVER	LR037027
FORD	K4A376AFR			VOLVO	31216176	LAND ROVER	TVB500360
FORD	XL2Z4A37						
FORD	XL2Z4A376AA						
							

699239		699240		801298		808078	
VOLVO	25775163	FORD	9R3Z4R602A	NISSAN	2710082Z80	JEEP	52105990AB
				NISSAN	370004W015	JEEP	52123021AC
				NISSAN	37000ZZ71A		
				NISSAN	37300EA105		
				NISSAN	37300EA115		
				NISSAN	37300ZL81A		
				NISSAN	37300ZL82A		
				NISSAN	37300ZP90A		
							

Drive Line Part

Photo.....

816011		818279		835068		899032	
JEEP	52123553AA	FORD	7L1Z4602A	LAND ROVER	LR007804	JEEP	52098208
JEEP	52853330AA			LAND ROVER	LR023283	JEEP	52099422
JEEP	52853330AB			SUZUKI	2710166J01	JEEP	52099497AC
JEEP	52853330AC					JEEP	52099497AD
JEEP	528533FRK					JEEP	52099497AE
JEEP	68022104AA					JEEP	52099499AD
JEEP	68022104AB					JEEP	52099499AG
						JEEP	52111591AA

899297		PS900102		PS900103		PS900104	
JEEP	52105728AD	AUDI	1K0521101D	AUDI	8K0521101AA	AUDI	4B0521106A
JEEP	52105758AD	AUDI	1K0521101G	AUDI	8K0521101G	AUDI	4B0521106D
JEEP	P52853431AA	AUDI	1K0521101K	AUDI	8K0521101N		
JEEP	P52853432AA	AUDI	1K0521101N				

PS900105		PS900107		PS900108		PS900109	
AUDI	4F0521101B	AUDI	8R0521101B	AUDI	8R0521101F	AUDI	7L8521102D
AUDI	4F0521101F			AUDI	8R0521101L	AUDI	7L8521102F
				AUDI	8R0521101M	AUDI	7L8521102M
				AUDI	8R0521101Q		

Drive Line Part

Photo.....





PS900110		PS900111		PS900112		PS900113	
AUDI	7L8521102S	AUDI	7L8521101C	BMW	26207632650	BMW	26111229565
AUDI	7L8521105G			BMW	26208626955		
AUDI	7L8521105L						
							





PS900114		PS900116		PS900117		PS900121	
BMW	26111229557	BMW	26117506840	BMW	26107527355	BMW	26111229569
BMW	26117523925	BMW	26117510840	BMW	26107551199		
		BMW	26117519303				
							

PS900122		PS900123		PS900124		PS900125	
BMW	20207525969	BMW	26107527376	BMW	26207529294	BMW	26107527333
BMW	26207502968	BMW	26107573482	BMW	26207620520		
BMW	26207525969			BMW	26207629987		
BMW	26207526677			BMW	26208628042		
				BMW	26209488491		
							

Drive Line Part

Photo.....





PS900127		PS900128		PS900129		PS900130	
BMW	26107522030	BMW	26207534636	BMW	26107542120	BMW	26107557145
BMW	26107557161	BMW	26209488490	BMW	26107557158	BMW	26107576478
BMW	26107573574			BMW	26107573493		
BMW	7522030						
							





PS900131		PS900132		PS900133		PS900134	
BMW	26107506968	BMW	26107561808	BMW	26107588577	BMW	26107582254
BMW	26107513770	BMW	26107573528				
							





PS900135		PS900137		PS900138		PS900139	
BMW	26107639214	BMW	26112284490	BMW	26207593164	BMW	26208678680
BMW	26108648854			BMW	26207620521	BMW	26208698362
BMW	26108693404			BMW	26207629988		
				BMW	26208628043		
				BMW	26209425906		
							

Drive Line Part

Photo.....





PS900143		PS900145		PS900147		PS900149	
BMW	26104473980	BMW	26107520454	BMW	26107614653	BMW	26207508629
BMW	26107526496	BMW	26107527624	BMW	26117562810		
BMW	26107527627						
							





PS900150		PS900152		PS900153		PS900155	
BMW	26207524371	BMW	26107524364	BMW	26203401609	BMW	26207556019
		BMW	26107549298				
							





PS900156		PS900157		PS900158		PS900159	
BMW	26107564736	BMW	26107564740	BMW	26207556020	BMW	26207597649
				BMW	7556020	BMW	26208605866
							

Drive Line Part

Photo.....





PS900160		PS900161		PS900162		PS900164	
BMW	26107589128	BMW	26207589985	BMW	26107614755	BMW	26107589801
		BMW	26208605867				
		BMW	26209425909				
		BMW	7589985				
		BMW	8605867				
							





PS900166		PS900168		PS900180		PS900182	
BMW	26107564398	BMW	26107589129	CADILLAC	22885388	CHEVROLET	20781756
						CHEVROLET	96624771
						OPEL	0446073
							



PS900193		PS900195		PS900196		PS900197	
DODGE	04593542AB	DAIHATSU	3711087Z24	DAIHATSU	3711087Z19000	DAIHATSU	263585
		DAIHATSU	3711087Z24000	DAIHATSU	3711087Z19A	DAIHATSU	565333
		DAIHATSU	615339	DAIHATSU	615338	DAIHATSU	615340
		DAIHATSU	6153390001	DAIHATSU	6153380001		
							

Drive Line Part

Photo.....





PS900198		PS900199		PS900209		PS900210	
DAIHATSU	264286	DAIHATSU	3711087D04000	DODGE	52123639AA	CHRYSLER	52123021AD
DAIHATSU	565341	DAIHATSU	3711087Z06000			CHRYSLER	52123021AE
DAIHATSU	615341	DAIHATSU	3711087Z22A				
							





PS900219		PS900222		PS900250		PS900251	
CHRYSLER	52853642AC	FIAT	46349688	HONDA	40100S9AE01	HONDA	40100S10003
CHRYSLER	52853642AD	FIAT	55193595	HONDA	40100SCAA01	HONDA	40100S10A01
CHRYSLER	52853642AE	FIAT	55197051				
		FIAT	55222107				
		FIAT	55264146				
							





PS900252		PS900253		PS900260		PS900264	
HONDA	40100SWAA01	HONDA	40100T0AA01	HYUNDAI	491004H000	HYUNDAI	4930026103
HONDA	40100SWYE01	HONDA	40100T0AA02				
HONDA	40100SXSA01						
							

Drive Line Part

Photo.....

PS900265	PS900268	PS900269	PS900270
HYUNDAI 493001U000	HYUNDAI 493002B950	HYUNDAI 493002B500	HYUNDAI 493000L000 HYUNDAI 493000L000Z
			





PS900271	PS900272	PS900273	PS900275
HYUNDAI 493002S000	HYUNDAI 493003W000	HYUNDAI 493002E000 HYUNDAI 493002E050	INFINITI 372001CA1A
			



PS900276	PS900281	PS900282	PS900292
JEEP 53005542 JEEP 53005542AC	CHRYSLER 52123627AA CHRYSLER 52123627AB	JEEP 52099499 JEEP 52099499AD JEEP 52099499AF JEEP 52099499AG	JEEP 53005543 JEEP 53005543AC
			

Drive Line Part

Photo.....





PS900303		PS900308		PS900309		PS900310	
JEEP	05273310AA	KIA	493002P500	KIA	491003E110	KIA	491003E150
JEEP	05273310AB						
JEEP	5273310AA						
JEEP	5273310AB						
							





PS900313		PS900315		PS900316		PS900318	
LAND ROVER	BR1846	LAND ROVER	FRC8393	LAND ROVER	FRC8391	LAND ROVER	FRC8389
LAND ROVER	FRC5566			LAND ROVER	FTC3245	LAND ROVER	FTC3905
LAND ROVER	FRC8390						
							

PS900319		PS900320		PS900321		PS900324	
LAND ROVER	TVB000330	LAND ROVER	TVB000140	LAND ROVER	FTC5320	LAND ROVER	7H223214AA
		LAND ROVER	TVB100380	LAND ROVER	TVB000100	LAND ROVER	TVB500160
				LAND ROVER	TVB000110	LAND ROVER	TVB500510
				LAND ROVER	TVB000220		
				LAND ROVER	TVB000320		
				LAND ROVER	TVB000320K		
				LAND ROVER	TVB100370		
							

Drive Line Part

Photo.....

PS900325	PS900326	PS900327	PS900328
LAND ROVER LR037027 LAND ROVER LR037027R LAND ROVER TVB500270 LAND ROVER TVB500360 LAND ROVER TVB500360R	LAND ROVER FRC8386 LAND ROVER TVB100610	LAND ROVER FRC8387	LAND ROVER FTC4140 LAND ROVER TVB000050 LAND ROVER TVB000130
			





PS900329	PS900330	PS900331	PS900332
LAND ROVER FTC4141	LAND ROVER FTC5428 LAND ROVER TVB000090	LAND ROVER FTC5430 LAND ROVER TVB000190	LAND ROVER LR006959 LAND ROVER LR007804 LAND ROVER LR021553 LAND ROVER LR023283
			

PS900333	PS900334	PS900335	PS900336
LAND ROVER TVB500040 LAND ROVER TVB500520	LAND ROVER TVB000370 LAND ROVER TVB500290	LAND ROVER LR022574 LAND ROVER LR030049 LAND ROVER TVB500250 LAND ROVER TVB500380 LAND ROVER TVB500400 LAND ROVER TVB500530	LAND ROVER LR021552 LAND ROVER LR024750 LAND ROVER LR031394 LAND ROVER LR049820 LAND ROVER LR049821 LAND ROVER LR072600
			

Drive Line Part

Photo.....





PS900337	PS900338	PS900339	PS900345
FORD 5H324365AB LAND ROVER LR037028 LAND ROVER TVB500370 LAND ROVER TVB500390	LAND ROVER LR007035 LAND ROVER LR008102	LAND ROVER TVB000450	MERCEDES-BENZ 1664100101 MERCEDES-BENZ 1664100501 MERCEDES-BENZ A1664100101 MERCEDES-BENZ A1664100501
			





PS900346	PS900347	PS900348	PS900349
MERCEDES-BENZ 2034106106 MERCEDES-BENZ A2034106106	MERCEDES-BENZ 1764100100 MERCEDES-BENZ A1764100100	MERCEDES-BENZ 2104103716 MERCEDES-BENZ 2104104316 MERCEDES-BENZ A2104103716 MERCEDES-BENZ A2104104316	MERCEDES-BENZ 2104107106 MERCEDES-BENZ A2104107106
			

PS900350	PS900351	PS900352	PS900353
MERCEDES-BENZ 2114106306 MERCEDES-BENZ A2114106306	MERCEDES-BENZ 2204107106 MERCEDES-BENZ A2204107106	MERCEDES-BENZ 1634100201 MERCEDES-BENZ A1634100201	MERCEDES-BENZ 1634100101 MERCEDES-BENZ A1634100101
			

Drive Line Part

Photo.....





PS900354	PS900355	PS900357	PS900359
MERCEDES-BENZ 1634100301 MERCEDES-BENZ A1634100301 	MERCEDES-BENZ 1634100901 MERCEDES-BENZ A1634100901 	MERCEDES-BENZ A2044107001 	MERCEDES-BENZ 2044101801 MERCEDES-BENZ 2044102401 MERCEDES-BENZ 2044102601 MERCEDES-BENZ 2044106701 MERCEDES-BENZ 2044106801 MERCEDES-BENZ 2044106901 MERCEDES-BENZ 2214101701 MERCEDES-BENZ 2214103501 





PS900363	PS900365	PS900367	PS900368
MERCEDES-BENZ A1644103102 	MERCEDES-BENZ 9064100001 MERCEDES-BENZ 9064101501 MERCEDES-BENZ 9064102201 MERCEDES-BENZ A9064100001 MERCEDES-BENZ A9064101501 MERCEDES-BENZ A9064102201 VW 2E0521099B 	MERCEDES-BENZ 9064107516 MERCEDES-BENZ A9064100016 MERCEDES-BENZ A9064107516 MERCEDES-BENZ A906410751680 VW 2E0521163Q 	MERCEDES-BENZ 9064100106 MERCEDES-BENZ 9064102016 MERCEDES-BENZ 9064102116 MERCEDES-BENZ 9064104406 MERCEDES-BENZ A9064100106 MERCEDES-BENZ A9064102016 MERCEDES-BENZ A9064102116 MERCEDES-BENZ A9064104406 





PS900369	PS900370	PS900371	PS900373
MERCEDES-BENZ 9064100806 MERCEDES-BENZ 9064109606 MERCEDES-BENZ A68006622AA MERCEDES-BENZ A9064100806 MERCEDES-BENZ A9064109606 MERCEDES-BENZ A906410960680 	MERCEDES-BENZ 9064103616 MERCEDES-BENZ A9064103616 MERCEDES-BENZ A906410361680 VW 2E0521101CB 	MERCEDES-BENZ 9034102906 MERCEDES-BENZ A9034102906 MERCEDES-BENZ A903410290680 VW 2D0521101AJ 	MERCEDES-BENZ 9014101217 MERCEDES-BENZ 9014102406 MERCEDES-BENZ 9014107406 MERCEDES-BENZ A9014101217 MERCEDES-BENZ A9014102406 MERCEDES-BENZ A9014107406 MERCEDES-BENZ A901410740680 VW 2D0521101AM 

Drive Line Part

Photo.....





<p>PS900376</p> <p>MERCEDES-BENZ 6394103006 MERCEDES-BENZ 639410300680 MERCEDES-BENZ A6394103006 MERCEDES-BENZ A639410300680</p> 	<p>PS900377</p> <p>MERCEDES-BENZ 6394103106 MERCEDES-BENZ A6394103106 MERCEDES-BENZ A639410310680</p> 	<p>PS900378</p> <p>MERCEDES-BENZ 6394103206 MERCEDES-BENZ 639410320680 MERCEDES-BENZ A6394103206 MERCEDES-BENZ A639410320680</p> 	<p>PS900379</p> <p>MERCEDES-BENZ 6394103306 MERCEDES-BENZ A6394103306</p> 
--	--	---	---

<p>PS900380</p> <p>MERCEDES-BENZ 6394103406 MERCEDES-BENZ A6394103406 MERCEDES-BENZ A639410340680</p> 	<p>PS900381</p> <p>MERCEDES-BENZ 6394103506 MERCEDES-BENZ A6394103506</p> 	<p>PS900390</p> <p>MERCEDES-BENZ 6394101716 MERCEDES-BENZ 6394106706 MERCEDES-BENZ A6394101716 MERCEDES-BENZ A6394101916 MERCEDES-BENZ A6394106706 MERCEDES-BENZ A6394107006</p> 	<p>PS900393</p> <p>MERCEDES-BENZ 6394103416 MERCEDES-BENZ A6394103416</p> 
--	---	---	---





<p>PS900397</p> <p>mitsubishi MR388691</p> 	<p>PS900399</p> <p>MITSUBISHI 3401A448 MITSUBISHI MN168569</p> 	<p>PS900401</p> <p>MITSUBISHI 3401A022</p> 	<p>PS900418</p> <p>MITSUBISHI 3401A018</p> 
---	--	--	---

Drive Line Part

Photo.....





PS900419	PS900420	PS900421	PS900431
MITSUBISHI 3401A019 	MITSUBISHI MR580390 	MITSUBISHI MR410559 MITSUBISHI MR453516 MITSUBISHI MR580389 	MITSUBISHI MR553798 MITSUBISHI MR980151 



PS900432	PS900433	PS900434	PS900439
MITSUBISHI MR953726 	NISSAN 37000CB00A 	NISSAN 372005X30A NISSAN 37200DY235 NISSAN 37200EB300 NISSAN 37200EB30A 	NISSAN 370007C001 NISSAN 370008C801 NISSAN 370009C001 





PS900441	PS900442	PS900445	PS900446
NISSAN 370007C002 NISSAN 370008C802 NISSAN 370009C002 	NISSAN 370007C003 NISSAN 370009C504 	NISSAN 370001DA0B NISSAN 370001DB0E NISSAN 37000BR50A NISSAN 37000BR50B NISSAN 37000BR52A NISSAN 37000JD200 	NISSAN 370001DA0D NISSAN 370001DF0B NISSAN 370001DF0D NISSAN 370003UD3B 

Drive Line Part

Photo.....





PS900447		PS900448		PS900450		PS900451	
NISSAN	370008H310	NISSAN	370004BA2A	PORSCHE	97042101152	RENAULT	8200144401
NISSAN	370008H510	NISSAN	370005068R	PORSCHE	97042101153	RENAULT	8200149811
NISSAN	370008H800	NISSAN	37000JM13A	PORSCHE	97042101154		
							





PS900452		PS900453		PS900458		PS900459	
RENAULT	37000JY00C	RENAULT	7711135224	SSANGYONG	3310009001	SSANGYONG	3310009502
		RENAULT	8200058705				
							

PS900460		PS900461		PS900463		PS900464	
SUBARU	27111SC021	SUBARU	27111FJ080	SUBARU	27111AG11A	SUBARU	27111AJ110
		SUBARU	27111FJ081	SUBARU	27111AG15A		
							

Drive Line Part

Photo.....





PS900465		PS900470		PS900472		PS900476	
SUZUKI	2710061M00	TOYOTA	3714087404	TOYOTA	371400K010	TOYOTA	3710048030
		TOYOTA	37140B4020				
							





PS900477		PS900479		PS900481		PS900482	
TOYOTA	3710048050	TOYOTA	371400K030	TOYOTA	371000K030	TOYOTA	371000K040
							





PS900484		PS900487		PS900488		PS900490	
TOYOTA	3711035580	TOYOTA	371106A260	TOYOTA	3714060170	TOYOTA	3714060350
							

Drive Line Part

Photo.....





PS900492	PS900493	PS900497	PS900499
TOYOTA 3710042060	TOYOTA 3710042090	TOYOTA 3710045020	TOYOTA 3710004343
			





PS900503	PS900505	PS900506	PS900507
TOYOTA 3710048020	VOLVO 31325356	VOLVO 30713371 VOLVO 8689915 VOLVO P30713371	VOLVO 30681235 VOLVO 30711838 VOLVO 31256272
			





PS900509	PS900510	PS900511	PS900512
VOLVO 30735022 VOLVO 30759971	VOLVO 9480702	VOLVO 31256001	VOLVO 30735566 VOLVO 30783365 VOLVO 30787839
			

Drive Line Part

Photo.....





PS900513		PS900514		PS900515		PS900516	
VOLVO	30651997	VOLVO	30614432	VOLVO	31302006	VOLVO	31325194
VOLVO	31259593	VOLVO	30735027			VOLVO	31367159
VOLVO	31367625	VOLVO	8636926			VOLVO	31367461
		VOLVO	8689885			VOLVO	31367784
		VOLVO	P30735027			VOLVO	31367840
						VOLVO	31437418
						VOLVO	31437611
						VOLVO	31492432
							





PS900517		PS900519		PS900520		PS900522	
VOLVO	31437119	VW (SVW)	5N7521101	VW	5N0521101	PORSCHE	95842101003
VOLVO	31492479			VW	5N0521101A	PORSCHE	95842101004
				VW	5N0521101C	VW	7P0521101E
				VW	5N0521101E	VW	7P0521101H
				VW	5N0521101EX	VW	7P0521101J
				VW	5N0521101J	VW	7P0521101M
				VW	5N0521101M	VW	7P0521101Q
				VW	5N0521101MX		
							





PS900525		PS900526		PS900527		PS900528	
AUDI	7L0521101H	VW	7L6521101	PORSCHE	95542102011	VW	7L6521102B
AUDI	7L6521101M	VW	7L6521101A	PORSCHE	95542102012	VW	7L6521102C
AUDI	7L6521101Q	VW	7L6521101C	PORSCHE	95542102013	VW	7L6521102D
PORSCHE	95542102000	VW	7L6521101E	PORSCHE	95542102014	VW	7L6521102E
PORSCHE	95542102001	VW	7L6521101G	PORSCHE	95542102015	VW	7L6521102F
PORSCHE	95542102002	VW	7L6521101L	VW	7L0521102B	VW	7L6521102H
PORSCHE	95542102003	VW	7L6521101N	VW	7L0521102D	VW	7L6521102N
PORSCHE	95542102004			VW	7L0521102G	VW	7L6521102Q
							

Drive Line Part

Photo.....





PS900530	PS900536	PS900537	PS900550
LAND ROVER LR034513 LAND ROVER LR057620 LAND ROVER LR082562	LAND ROVER LR034508 LAND ROVER LR058371 LAND ROVER LR071994	LAND ROVER LR041960 LAND ROVER LR058372 LAND ROVER LR072500	MERCEDES-BENZ 9064105806 MERCEDES-BENZ A9064105806 MERCEDES-BENZ A906410580680 VW 2E0521101BB
			

PS900551	PS900552	PS900554	PS900557
TOYOTA 3710042080	AUDI 8R0521101E AUDI 8R0521101K AUDI 8R0521101P	MERCEDES-BENZ 4634101202 MERCEDES-BENZ A4634101202	DACIA 320003602R DACIA 370002820R DACIA 8200945335
			

PS900558	PS900559	PS900560	PS900561
MERCEDES-BENZ 9064102716 MERCEDES-BENZ 9064107916 MERCEDES-BENZ A9064102716 MERCEDES-BENZ A9064107916 MERCEDES-BENZ A906410791680 VW 2E0521101BE VW 2E0521101E VW 2E0521101J	MERCEDES-BENZ 9064102616 MERCEDES-BENZ 9064107816 MERCEDES-BENZ A9064102616 MERCEDES-BENZ A9064107816 MERCEDES-BENZ A906410781680 VW 2E0521163T VW 2E0521293M	PORSCHE 97042101132 PORSCHE 97042101133	KIA 491003E100
			

Drive Line Part

Photo.....





PS900562		PS900563		PS900564		PS900565	
NISSAN	370003UC3A	NISSAN	373003X33C	NISSAN	373004JA0B	TOYOTA	3710042050
NISSAN	37000BR51A						
NISSAN	37000EB52A						
NISSAN	37000JD000						
NISSAN	37000JG70A						
NISSAN	37000JG70B						
							





PS900566		PS900567		PS900568		PS900569	
PORSCHE	97042101102	MERCEDES-BENZ	6394108406	MERCEDES-BENZ	9014101101	VW	7H3521102A
PORSCHE	97042101104	MERCEDES-BENZ	A6394108406	MERCEDES-BENZ	9014102401		
				MERCEDES-BENZ	A9014101101		
				MERCEDES-BENZ	A9014102401		
				VW	2D0521107F		
							

PS900570		PS900571		PS900572		PS900573	
VW	7H1521102A	MERCEDES-BENZ	2054100402	AUDI	4FD521101A	AUDI	2H0521102AG
		MERCEDES-BENZ	A2054100402	AUDI	4FD521101B	AUDI	2H0521102AJ
						AUDI	2H0521102AN
						AUDI	2H0521102AT
						AUDI	2H0521102F
						AUDI	2H0521102K
						AUDI	2H0521102P
						VW	2H6521102D
							

Drive Line Part

Photo.....

PS900581		PS900582		PS900583		PS900584	
AUDI	4G0521101	MITSUBISHI	3401B041	FORD	1447190	AUDI	5Q0521101AR
AUDI	4G0521101B			FORD	5042330	AUDI	5Q0521101AS
AUDI	4G0521101C			FORD	5064477	AUDI	5Q0521101BH
AUDI	4G0521101D			FORD	5223453		
AUDI	4G0521101F			FORD	6M344602CB		
AUDI	4G0521101K			FORD	6M344602CC		
				FORD	6M344602CD		
				FORD	6M344602CE		
							





PS900585		PS900586		PS900589		PS900590	
VW	5Q0521101AG	MERCEDES-BENZ	1664100601	TOYOTA	3711042040	AUDI	8R0521101D
VW	5Q0521101AJ	MERCEDES-BENZ	1664102401			AUDI	8R0521101J
VW	5Q0521101AT	MERCEDES-BENZ	A1664100601			AUDI	8R0521101N
VW	5Q0521101BA	MERCEDES-BENZ	A1664102401				
VW	5Q0521101BJ						
							





PS900591		PS900593		PS900594		PS900595	
PORSCHE	95B521101C	MERCEDES-BENZ	2534101201	NISSAN	37000EB30C	AUDI	4M0521101
PORSCHE	95B521101R	MERCEDES-BENZ	A2534101201				
							

Drive Line Part

Photo.....





PS900598		PS900599		PS900600		PS900601	
KIA	491003E300	KIA	491003E420	KIA	491003E320	KIA	491003E330
							





PS900602		PS900603		PS900604		PS900605	
JEEP	52853010AB	KIA	491003E910	KIA	491003E900	KIA	491003E000
JEEP	52853010AC						
JEEP	52853010AD						
JEEP	52853417AA						
JEEP	52853417AB						
JEEP	52853417AC						
JEEP	52853417AD						
JEEP	52853464AA						
							



PS900606		PS900607		PS900608		PS900609	
MERCEDES-BENZ	1664102901	MERCEDES-BENZ	2514100601	SUZUKI	2710166J01	MERCEDES-BENZ	9064102001
MERCEDES-BENZ	1664109000	MERCEDES-BENZ	2514100701			MERCEDES-BENZ	A9064102001
MERCEDES-BENZ	A1664102901	MERCEDES-BENZ	A2514100601			MERCEDES-BENZ	A906410200180
MERCEDES-BENZ	A1664109000	MERCEDES-BENZ	A2514100701			VW	2E0521099
							

Drive Line Part

Photo.....

PS900610		PS900611		PS900612		PS900613	
BMW	26107567953	BMW	26107645651	MAZDA	MF0425100	BMW	26107565290
				MAZDA	MF0425100A	BMW	26107614380
							

PS900633		PS900634		PS901341		PS901342	
MITSUBISHI	3401A209	VAG	5QF521101R	FORD	1734067	FORD	1734069
				FORD	1899710	FORD	1899709
				FORD	2129099	FORD	2129098
				FORD	2350872	FORD	5287174
				FORD	5287175	FORD	AB394K145CD
				FORD	AB394K145DD	FORD	AB394K145CE
				FORD	AB394K145DE	FORD	EB3G4K145DA
				FORD	EB3G4K145EA	FORD	EB3G4K145DB
							

PS901343		PS901348	
FORD	1720534	AUDI	2H0521102D
FORD	1723636		
FORD	1736197		
FORD	1899712		
FORD	2071475		
FORD	2350874		
FORD	5287176		
FORD	AB394K145EB		
			

Joint, Propeller Shaft

Basic Dimension Table GSP to Dimension.....

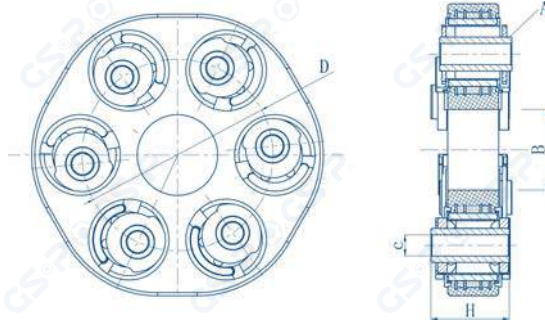

Product	GSP Ref.	BASIC DIMENSIONS(mm)				
		A	B	C	D	H
Flexible Coupling Kit	510434S	6	37	10	90	37.5
Flexible Coupling	510436	6	37	10	90	37.5
Flexible Coupling	510458	6	38.5	10	80	34
Flexible Coupling Kit	510459S	6	38.5	10	80	26
Flexible Coupling	510460	6	38.5	10	80	115
Flexible Coupling	510569	6	39	10	90	28.5
Flexible Coupling Kit	510570S	6	39	10	90	28.5
Flexible Coupling	510571	6	42	12	100	36
Flexible Coupling Kit	510571S	6	42	12	100	36
Flexible Coupling	510575	6	51.5	12	110	26
Flexible Coupling Kit	510576S	6	51.5	12	110	26
Flexible Coupling Kit	510578S	6	37	10	90	37.5
Flexible Coupling	510579	6	46.5	12	100	30
Flexible Coupling Kit	510579S	6	46.5	12	100	30
Flexible Coupling Kit	510580S	6	46.5	12	100	30
Flexible Coupling	510596	6	50	12	96	30
Flexible Coupling Kit	510596S	6	50	12	96	30
Flexible Coupling	510597	6	38	12	78	32
Flexible Coupling Kit	510597S	6	38.5	12	78	32
Flexible Coupling	510641	6	38.5	10	78	28
Flexible Coupling Kit	510641S	6	38.5	10	78	28
Flexible Coupling	510663	6	53	14	105	35
Flexible Coupling	511086	6	40	8.3	80	28
Flexible Coupling Kit	511086S	6	40	8.3	80	
Flexible Coupling	512326	6	37	10	90	37.5
Flexible Coupling Kit	512671S	6	58	12	108	31.2
Flexible Coupling	512672	6	57.5	12	110	34.9
Flexible Coupling Kit	512672S	6	57.5		110	34.9
Flexible Coupling Kit	512673S	6	50	12	100	32
Flexible Coupling	512676	6	58	12	108	31.2
Flexible Coupling	512677	6	57.5	12	110	35
Flexible Coupling Kit	512677S	6	57.5	12	110	35
Flexible Coupling	512678	6	49.5	12	100.2	32
Flexible Coupling Kit	512678S	6	50	12	100	32
Flexible Coupling	513053	6	41.6	8.2	85	28
Flexible Coupling Kit	513053S	6	42	8.2	85	
Flexible Coupling	517747	6	31.5	10	80	36.5
Flexible Coupling	517955	6	54.5	12	105	41.3
Flexible Coupling Kit	517955S	6	54.5	12	105	41.3
Flexible Coupling	517956	6	57.5	10	105.5	35.6
Flexible Coupling Kit	517956S	6	56.5	10	105	35.5
Flexible Coupling	517957	6	58	12	110	38.5
Flexible Coupling Kit	517957S	6	56	12	110	38.5
Flexible Coupling	519580	6	38.5	12	78	32
Flexible Coupling	530160	6	44	12	110	42
Flexible Coupling Kit	530160S	6	44	12	110	42
Flexible Coupling	530758	6	43.5	12	110	42
Flexible Coupling Kit	530758S	6	43.5	12	110	42
Flexible Coupling	533418	6	64.5	14	120	43.5
Flexible Coupling	533419	6	43	10	90	32
Flexible Coupling	533420	6	56	12	105	35

Joint, Propeller Shaft

Basic Dimension Table GSP to Dimension.....

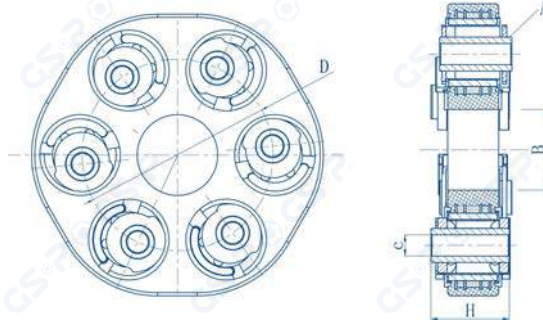

Product	GSP Ref.	BASIC DIMENSIONS(mm)				
		A	B	C	D	H
Flexible Coupling	533422	6	50	12	96	32
Flexible Coupling Kit	533422S	6	50	12	96	32
Flexible Coupling	533878	6	49	10	96	33.3
Flexible Coupling	533882	6	38	11	96	33
Flexible Coupling Kit	533882S	6	38	11	96	40.5
Flexible Coupling	533884	6	69.5	12	120	36
Flexible Coupling Kit	533884S	6	69.5	12	120	44
Flexible Coupling	537625	6	50	12	96	29.5
Flexible Coupling Kit	537625S	6		12	96	30
Flexible Coupling	537626	6	56	10	105	18
Flexible Coupling Kit	537626S	6	56	10	105	31
Flexible Coupling	537627	6	48.5	12	100	28
Flexible Coupling Kit	537627S	6	48.5	12	100	32
Flexible Coupling	537630	6	57.5	12	110	31
Flexible Coupling Kit	537630S	6	57.5	12	110	35
Flexible Coupling	537631	6	48.5	12	96	29.5
Flexible Coupling Kit	537631S	6	48.5	12	96	30
Flexible Coupling	537668	6	56	12	110	34
Flexible Coupling Kit	537668S	6	56	12	110	38.5
Flexible Coupling	537669	6	55	12	105	37
Flexible Coupling Kit	537669S	6	55	12	105	41.3
Flexible Coupling Kit	537791S	6	32	10	80	37
Flexible Coupling Kit	537792S	6	57.5	12	110	35
Flexible Coupling Kit	537793S	6	57.5	12	110	35
Flexible Coupling Kit	537794S	6	57.5	12	110	35
Flexible Coupling Kit	537796S	6	46.5	12	100	30
Flexible Coupling Kit	537797S	6	50	12	100	32
Flexible Coupling Kit	537798S	6	38.5	10	78	28
Flexible Coupling	537818	6	40	10	80	28.5
Flexible Coupling Kit	537819S	6	50	12	100	40
Flexible Coupling Kit	537820S	6	31.5	10	80	44
Flexible Coupling Kit	537821S	6	41	10	90	36
Flexible Coupling Kit	537822S	6	38.5	10	80	34
Flexible Coupling Kit	537832S	6	69.5	12	120	36
Flexible Coupling	537843	6	69.5		120	44
Flexible Coupling Kit	537843S	6	69.5		120	44
Flexible Coupling	537847	6	48.5	12	100	32
Flexible Coupling Kit	537848S	6	57.5	12	110	34.9
Flexible Coupling	537849	6	48.5	12	96	30
Flexible Coupling Kit	537850S	6	42	12	100	36
Flexible Coupling	537851	6	70.5	12	120	36
Flexible Coupling	537853	6	63	10	120	23
Flexible Coupling Kit	537854S	6	42	12	100	36
Flexible Coupling Kit	537889S	6	57.5	12	110	34.9

Propshaft

Basic Dimension Table GSP to Dimension.....

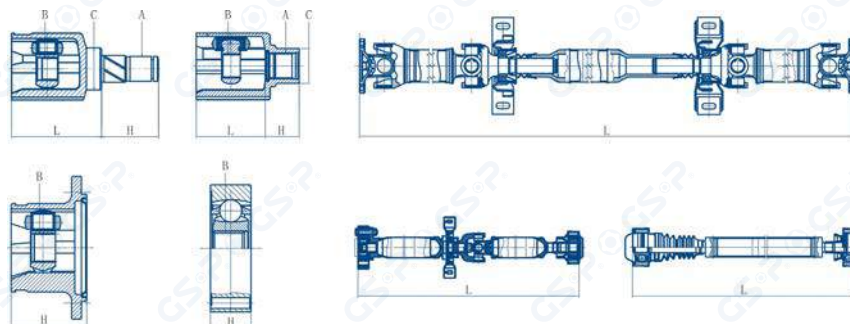

Product	GSP Ref.	BASIC DIMENSIONS(mm)					
		A	B	C	H	L	P
Propshaft	201406					835	
Propshaft	201782					862	
Propshaft	201958					598	
Propshaft	201972					710	
Propshaft	202065					336	
Propshaft	202067					234	
Propshaft	202068					209	
Propshaft	202072					259	
Propshaft	202100					679	
Propshaft	202101					859	
Propshaft	202102					768	
Propshaft	202280					778	
Propshaft	202281					867	
Propshaft	202398					321	
Propshaft	202440					835	
Propshaft	202442					793	
Propshaft	299302					780	
Propshaft	299303					760	
Propshaft	299304					727	
Joint,propshaft	601297		25			29	
Joint,propshaft	601910		30			26.8	
Joint,propshaft	602001		24			32	
Joint,propshaft	602148		24			23.5	
Joint,propshaft	602494		34			30.5	
Joint,propshaft	602495		32			28	
Joint,propshaft	605057		32			28	
Joint,propshaft	608072	17	22	36	53	66	
Joint,propshaft	608073	17	22	36	53	66	
Joint,propshaft	616005		25			40	
Joint,propshaft	616011		25			32	
Joint,propshaft	618001		25			32	
Joint,propshaft	630003		32			28	
Joint,propshaft	635045		24			32	
Joint,propshaft	635046		25			26	
Joint,propshaft	635047		26			42	
Joint,propshaft	635064		20			21	
Joint,propshaft	661093		25			27	
Joint,propshaft	661094		25			29	
Joint,propshaft	661100		26			35	
Joint,propshaft	699117		22			88.5	
Joint,propshaft	699195		19			22.6	
Joint,propshaft	699217		32			28	
Joint,propshaft	699239		30			37	
Joint,propshaft	699240		30			33	
Joint,propshaft	801298		35			48.5	
Joint,propshaft	808078	30	28	60	86	79	
Joint,propshaft	816011		35			28.5	
Joint,propshaft	818279		28			38	
Joint,propshaft	835068		21			27.5	
Joint,propshaft	899032		25			30	
Joint,propshaft	899297		25			30	

Propshaft

Basic Dimension Table GSP to Dimension.....

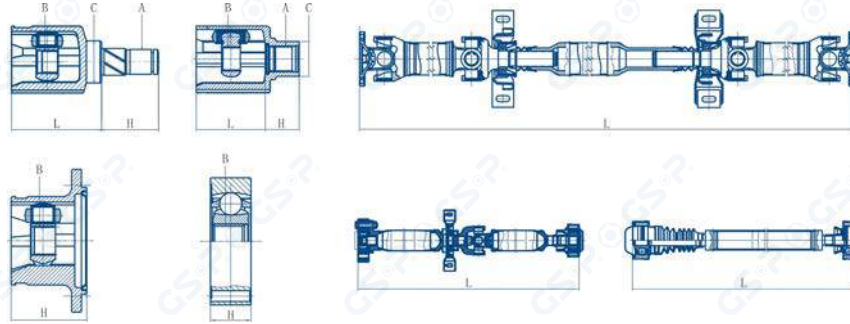

Product	GSP Ref.	BASIC DIMENSIONS(mm)					
		A	B	C	H	L	P
Propshaft	PS900102					2170	
Propshaft	PS900103					1478	
Propshaft	PS900104					1665	
Propshaft	PS900105					1763	
Propshaft	PS900107					1493	
Propshaft	PS900108					1494	
Propshaft	PS900109					1438	
Propshaft	PS900110					1562	
Propshaft	PS900111					648	
Propshaft	PS900112					715	
Propshaft	PS900113					1353	
Propshaft	PS900114					1554	
Propshaft	PS900116					1401	
Propshaft	PS900117					1423	
Propshaft	PS900121					1568	
Propshaft	PS900122					718	
Propshaft	PS900123					1235	
Propshaft	PS900124					738	
Propshaft	PS900125					1477	
Propshaft	PS900127					1619	
Propshaft	PS900128					644	
Propshaft	PS900129					1432	
Propshaft	PS900130					1597	
Propshaft	PS900131					1699	
Propshaft	PS900132					1760	
Propshaft	PS900133					1850	
Propshaft	PS900134					1718	
Propshaft	PS900135					1580	
Propshaft	PS900137					1597	
Propshaft	PS900138					730	
Propshaft	PS900139					808	
Propshaft	PS900143					1846	
Propshaft	PS900145					1828	
Propshaft	PS900147					1795	
Propshaft	PS900149					780	
Propshaft	PS900150					693	
Propshaft	PS900152					1338	
Propshaft	PS900153					702	
Propshaft	PS900155					709	
Propshaft	PS900156					1270	
Propshaft	PS900157					1254	
Propshaft	PS900158					705	
Propshaft	PS900159					709	
Propshaft	PS900160					1418	
Propshaft	PS900161					733	
Propshaft	PS900162					1494	
Propshaft	PS900164					1280	
Propshaft	PS900166					1376	
Propshaft	PS900168					1400	
Propshaft	PS900180					2389	
Propshaft	PS900182					1932	

Propshaft

Basic Dimension Table GSP to Dimension.....

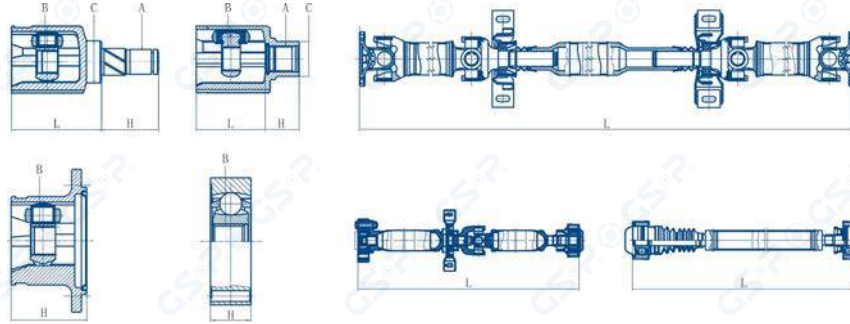

Product	GSP Ref.	BASIC DIMENSIONS(mm)					
		A	B	C	H	L	P
Propshaft	PS900193					659	
Propshaft	PS900195					513	
Propshaft	PS900196					496	
Propshaft	PS900197					624	
Propshaft	PS900198					639	
Propshaft	PS900199					444	
Propshaft	PS900209					857	
Propshaft	PS900210					840	
Propshaft	PS900219					603	
Propshaft	PS900222					1726	
Propshaft	PS900250					2051	
Propshaft	PS900251					2098	
Propshaft	PS900252					2058	
Propshaft	PS900253					2058	
Propshaft	PS900260					2204	
Propshaft	PS900264					2068	
Propshaft	PS900265					1925	
Propshaft	PS900268					2005	
Propshaft	PS900269					1943	
Propshaft	PS900270					1960	
Propshaft	PS900271					1956	
Propshaft	PS900272					1986	
Propshaft	PS900273					1958	
Propshaft	PS900275					903	
Propshaft	PS900276					780	
Propshaft	PS900281					1210	
Propshaft	PS900282					805	
Propshaft	PS900292					740	
Propshaft	PS900303					2023	
Propshaft	PS900308					2045	
Propshaft	PS900309					671	
Propshaft	PS900310					650	
Propshaft	PS900313					649	
Propshaft	PS900315					684	
Propshaft	PS900316					1015	
Propshaft	PS900318					1070	
Propshaft	PS900319					838	
Propshaft	PS900320					823	
Propshaft	PS900321					604	
Propshaft	PS900324					688	
Propshaft	PS900325					1295	
Propshaft	PS900326					604	
Propshaft	PS900327					859	
Propshaft	PS900328					748	
Propshaft	PS900329					969	
Propshaft	PS900330					816	
Propshaft	PS900331					880	
Propshaft	PS900332					1997	
Propshaft	PS900333					657	
Propshaft	PS900334					750	
Propshaft	PS900335					1261	

Propshaft

Basic Dimension Table GSP to Dimension.....

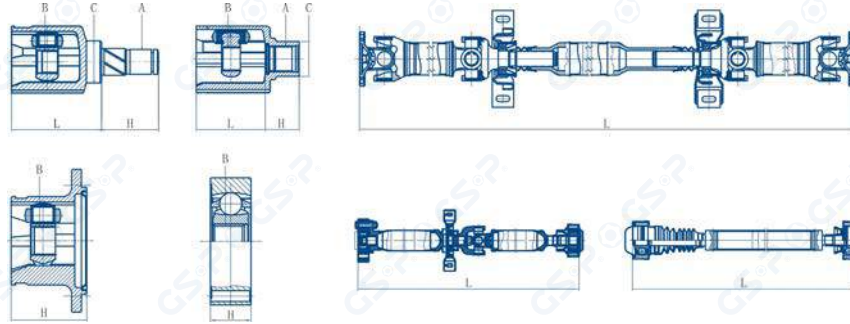

Product	GSP Ref.	BASIC DIMENSIONS(mm)					
		A	B	C	H	L	P
Propshaft	PS900336					2002	
Propshaft	PS900337					1150	
Propshaft	PS900338					745	
Propshaft	PS900339					1272	
Propshaft	PS900345					616	
Propshaft	PS900346					628	
Propshaft	PS900347					2077	
Propshaft	PS900348					669	
Propshaft	PS900349					579	
Propshaft	PS900350					609	
Propshaft	PS900351					610	
Propshaft	PS900352					674	
Propshaft	PS900353					550	
Propshaft	PS900354					744	
Propshaft	PS900355					696	
Propshaft	PS900357					671	
Propshaft	PS900359					657	
Propshaft	PS900363					1382	
Propshaft	PS900365					920	
Propshaft	PS900367					2579	
Propshaft	PS900368					2840	
Propshaft	PS900369					2752	
Propshaft	PS900370					2805	
Propshaft	PS900371					2245	
Propshaft	PS900373					2720	
Propshaft	PS900376					2240	
Propshaft	PS900377					2469	
Propshaft	PS900378					2211	
Propshaft	PS900379					2440	
Propshaft	PS900380					2143	
Propshaft	PS900381					2372	
Propshaft	PS900390					2139	
Propshaft	PS900393					2171	
Propshaft	PS900397					657	
Propshaft	PS900399					1469	
Propshaft	PS900401					2060	
Propshaft	PS900418					940	
Propshaft	PS900419					955	
Propshaft	PS900420					890	
Propshaft	PS900421					882	
Propshaft	PS900431					657	
Propshaft	PS900432					993	
Propshaft	PS900433					2188	
Propshaft	PS900434					790	
Propshaft	PS900439					672	
Propshaft	PS900441					767	
Propshaft	PS900442					832	
Propshaft	PS900445					1961	
Propshaft	PS900446					1979	
Propshaft	PS900447					2020	
Propshaft	PS900448					2218	

Propshaft

Basic Dimension Table GSP to Dimension.....

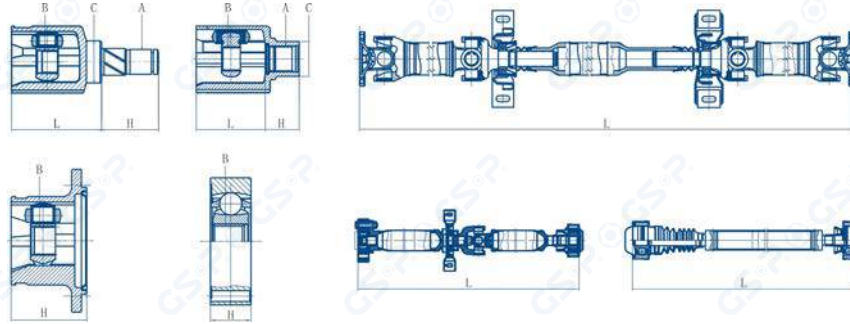

Product	GSP Ref.	BASIC DIMENSIONS(mm)					
		A	B	C	H	L	P
Propshaft	PS900450					1496	
Propshaft	PS900451					1976	
Propshaft	PS900452					2039	
Propshaft	PS900453					1991	
Propshaft	PS900458					638	
Propshaft	PS900459					630	
Propshaft	PS900460					1526	
Propshaft	PS900461					1551	
Propshaft	PS900463					1574	
Propshaft	PS900464					1561	
Propshaft	PS900465					1980	
Propshaft	PS900470					476	
Propshaft	PS900472					689	
Propshaft	PS900476					2316	
Propshaft	PS900477					2235	
Propshaft	PS900479					597	
Propshaft	PS900481					1616	
Propshaft	PS900482					1570	
Propshaft	PS900484					1375	
Propshaft	PS900487					1434	
Propshaft	PS900488					624	
Propshaft	PS900490					649	
Propshaft	PS900492					1966	
Propshaft	PS900493					2273	
Propshaft	PS900497					2535	
Propshaft	PS900499					1658	
Propshaft	PS900503					2248	
Propshaft	PS900505					2196	
Propshaft	PS900506					2165	
Propshaft	PS900507					2207	
Propshaft	PS900509					2136	
Propshaft	PS900510					2136	
Propshaft	PS900511					2146	
Propshaft	PS900512					2153	
Propshaft	PS900513					2070	
Propshaft	PS900514					2139	
Propshaft	PS900515					2228	
Propshaft	PS900516					2114	
Propshaft	PS900517					2270	
Propshaft	PS900519					2216	
Propshaft	PS900520					2138	
Propshaft	PS900522					670	
Propshaft	PS900525					612	
Propshaft	PS900526					678	
Propshaft	PS900527					1225	
Propshaft	PS900528					1165	
Propshaft	PS900530					721	
Propshaft	PS900536					1287	
Propshaft	PS900537					1350	
Propshaft	PS900550					2783	
Propshaft	PS900551					2165	

Propshaft

Basic Dimension Table GSP to Dimension.....

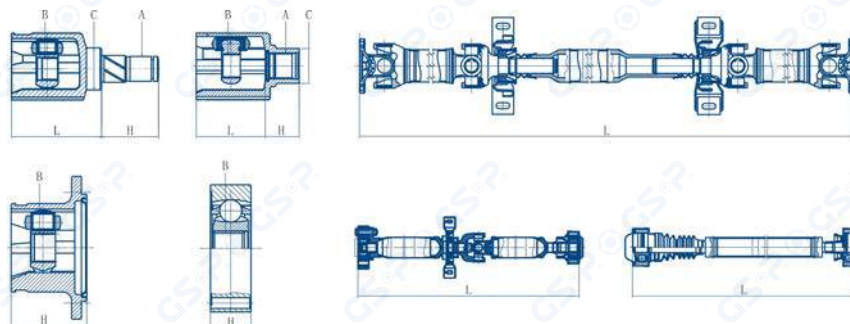

Product	GSP Ref.	BASIC DIMENSIONS(mm)					
		A	B	C	H	L	P
Propshaft	PS900552					1476	
Propshaft	PS900554					550	
Propshaft	PS900557					2071	
Propshaft	PS900558					2554	
Propshaft	PS900559					2580	
Propshaft	PS900560					1503	
Propshaft	PS900561					683	
Propshaft	PS900562					1978	
Propshaft	PS900563					1521	
Propshaft	PS900564					1605	
Propshaft	PS900565					1758	
Propshaft	PS900566					1644	
Propshaft	PS900567					2156	
Propshaft	PS900568					949	
Propshaft	PS900569					1920	
Propshaft	PS900570					1519	
Propshaft	PS900571					1610	
Propshaft	PS900572					1858	
Propshaft	PS900573					1589	
Propshaft	PS900581					1579	
Propshaft	PS900582					764	
Propshaft	PS900583					1422	
Propshaft	PS900584					2176	
Propshaft	PS900585					2218	
Propshaft	PS900586					622	
Propshaft	PS900589					979	
Propshaft	PS900590					1628	
Propshaft	PS900591					1449	
Propshaft	PS900593					1472	
Propshaft	PS900594					1915	
Propshaft	PS900595					1670	
Propshaft	PS900598					1101	
Propshaft	PS900599					637	
Propshaft	PS900600					1157	
Propshaft	PS900601					1124	
Propshaft	PS900602					787	
Propshaft	PS900603					1172	
Propshaft	PS900604					622	
Propshaft	PS900605					651	
Propshaft	PS900606					627	
Propshaft	PS900607					604	
Propshaft	PS900608					835	
Propshaft	PS900609					889	
Propshaft	PS900610					1417	
Propshaft	PS900611					1327	
Propshaft	PS900612					999	
Propshaft	PS900613					1369	
Propshaft	PS900633					1290	
Propshaft	PS900634					2372	
Propshaft	PS901341					1970	
Propshaft	PS901342					1602	

Propshaft

Basic Dimension Table GSP to Dimension.....

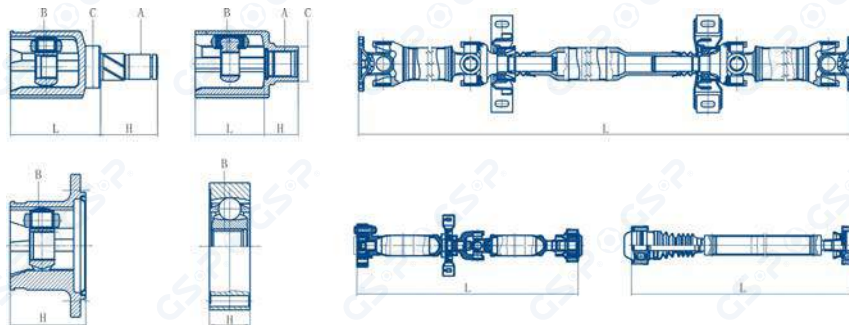

Product	GSP Ref.	BASIC DIMENSIONS(mm)					
		A	B	C	H	L	P
Propshaft	PS901343					1923	
Propshaft	PS901348					1690	

New applications (compared with catalogue 2022)

GSP Ref.	GSP Ref.	GSP Ref.	GSP Ref.	GSP Ref.	GSP Ref.	GSP Ref.
510571	PS901341					
510571S	PS901342					
512672	PS901343					
512672S	PS901348					
532827						
533419						
533420						
533842						
533871						
537766						
537843S						
537847						
537848S						
537849						
537850S						
537851						
537853						
537854S						
537889S						
602494						
602495						
PS900104						
PS900116						
PS900123						
PS900129						
PS900130						
PS900131						
PS900134						
PS900137						
PS900139						
PS900147						
PS900162						
PS900180						
PS900193						
PS900209						
PS900210						
PS900260						
PS900265						
PS900308						
PS900316						
PS900349						
PS900418						
PS900419						
PS900420						
PS900431						
PS900432						
PS900446						
PS900481						
PS900487						
PS900490						
PS900497						
PS900499						
PS900503						
PS900536						
PS900537						
PS900551						
PS900572						
PS900593						
PS900633						
PS900634						



GSP Automotive Group

No.1 Gaoxiang Road, High-tech Industrial Zone
Ouhai District, Wenzhou, China.
Tel: +86-577-8629311886293268
Fax: +86-577-86293313
E-mail: internationalsales@gsp.cn
Http: [//www.gsp.cn](http://www.gsp.cn)

GSP Germany Cologne

Leyboldstrasse 10 D-50354 Huerth/Germany
Tel: +49 2233 80884 18

GSP Germany Hamburg

Werkstrasse, 1 22844 Norderstedt, Germany
Tel: +49 40 64 66 99 460
Mail: gsp@elbex-hamburg.de

GSP Poland Gdansk

Elblqaska 130, 80-718 Gdańsk, Poland

GSP N.A South California

2725 New Cut rd.
Spartanburg, SC 29323
Tel: 864.578.6900
Fax: 864.578.6978
E-mail: info@gsp-na.com

GSP America Avondale

950 N 119th Ave Building A, Avondale, AZ 85323
Tel: +1-562-926-3525

GSP Latin America Florida

3150 SW 38th Ave., Suite 1312, Coral Gables, FL 33146, USA
Tel: +1-305-446-7702

GSP Mexico Queretaro

Manuel Gomez Morin #3960
Centro Sur, Querétaro, QRO.76090 Level 1, Office D
Tel: +52-442-2449414

GSP Malaysia Johor

No. 18 (PLO 36), Jalan Teknologi 4, Taman Teknologi Johor, 81400 Senai, Johor, Malaysia
Tel: +0086-577-86293120
mail: internationalsales@gsp.cn

GSP China Nanjing

No.59 Shuanghu Road, Gaochun county, Nanjing City
Tel: +0577-8629-3223

GSP China Shanghai

2138, 21/F, Mirae Asset Tower, No. 166 Lujiazui Ring Road, Pudong District, Shanghai
Tel: +021-60631213
Fax: +021-60631289



LinkedIn



Facebook