

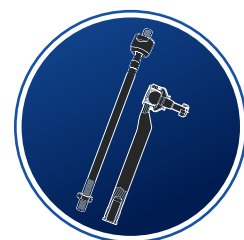

Quality Driven Performance

STEERING & SUSPENSION PARTS



**CATALOGUE
2023**

BRAZIL

www.gsplatina.com



Quality Driven Performance

STEERING & SUSPENSION PARTS



CATALOGUE
2023

BRAZIL

www.gsplatina.com

GSP AUTOMOTIVE GROUP



WIDE RANGE PRODUCTS

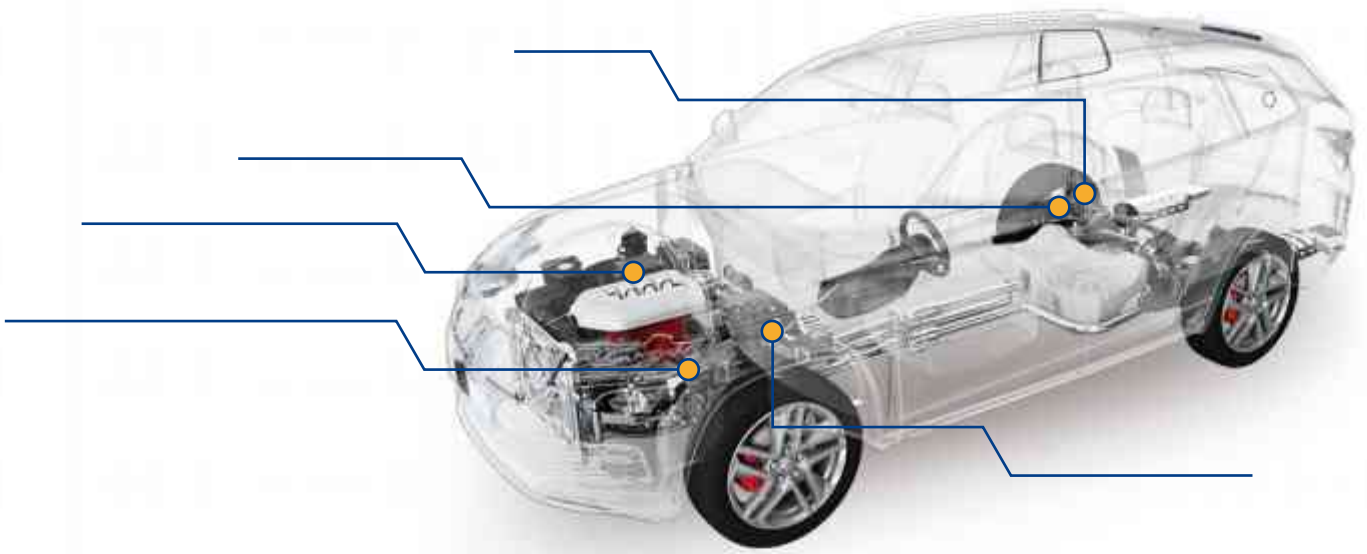

-
-
-

WORLDWIDE LOCATION

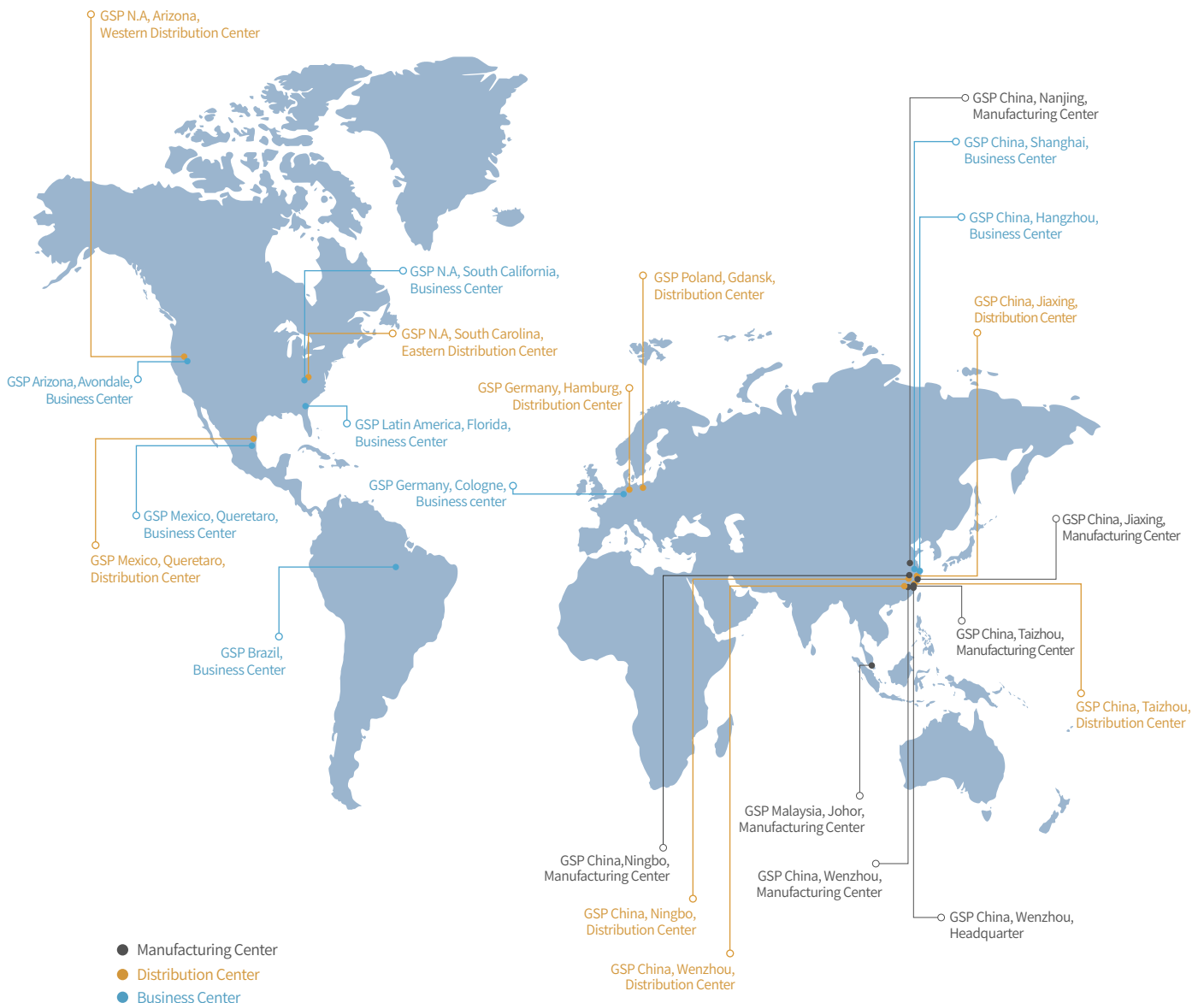

PREMIUM QUALITY



CUSTOMER SERVICES





GENERAL INDEX



Vehicle Index	page.I-IV
Application	page.001-438
Cross References List And Photo	page.439-782



MAKE-MODEL	PAGE	MAKE-MODEL	PAGE	MAKE-MODEL	PAGE
ALFA ROMEO		BENTLEY		BMW	
145	1	Continental GTC	69	M3	105
147	1	Flying Spur	69	M3 Coupe	105
155	1	Mulsanne	69	M340i xDrive	106
156	1	BMW		M4 Cabrio	106
159	3	116i	69	M4 Coupe	106
164	3	118i	70	M5	106
166	3	120i	71	M6 Gran Coupe	107
AUDI		120i Cabrio	72	X1 sDrive 18i	107
100 Quattro	3	125i	73	X1 sDrive 20i	108
80	4	130i	74	X1 xDrive 25i	108
80 Quattro	4	135i Coupe	75	X1 xDrive 28i	108
80 RS2 Quattro	5	218i Gran Coupe	75	X2 sDrive 20i	109
A1	5	225i Active Tourer	75	X3	109
A1 Quattro	6	228i xDrive Gran Coupe	75	X3 xDrive 20i	110
A1 Sportback	6	316i	75	X3 xDrive 28i	110
A3	7	316i Touring	76	X3 xDrive 30i	110
A3 Cabrio	10	318i	76	X3 xDrive 35i	111
A3 Sportback	11	318i Compact	77	X3 xDrive M40i	111
A3 Sportback Quattro	12	320i	77	X4 xDrive 28i	111
A3/S3 Limousine quattro	13	320i Gran Turismo	79	X4 xDrive 30i	111
A4	13	320i xDrive	79	X4 xDrive 35i	111
A4 Cabrio	23	323i	79	X4 xDrive M40i	112
A4 Quattro	23	323i Compact	80	X5	112
A4/S4	26	323i Touring	80	X5 M	113
A4/S4 Avant quattro	27	325i	81	X5 xDrive 30d	113
A4/S4 quattro	27	325i Cabrio	82	X5 xDrive 30i	114
A5	27	325i Touring	82	X5 xDrive 35i	114
A5 Cabrio Quattro	30	325xi Touring	83	X5 xDrive 48i	115
A5 Quattro	30	328i	83	X5 xDrive 50i	115
A5 Sportback	31	328i Coupe	84	X5 xDrive M50d	115
A5 Sportback Quattro	33	328i Touring	84	X6 M	116
A6	34	328i xDrive	84	X6 xDrive 35i	116
A6 Allroad Quattro	37	330i	85	X6 xDrive 50i	116
A6 Quattro	38	330i Cabrio	86	Z3 Cabrio	117
A7 Sportback	42	335i	86	Z3 Coupe	118
A7 Sportback Quattro	42	335i Cabrio	87	Z4 Cabrio	118
A8 Quattro	43	420i Cabrio	87	Z4 Coupe	118
A8/S8	46	428i Cabrio	87	Z4 M40i Cabrio	119
A8/S8 quattro	46	428i Coupe	87	Z4 sDrive 20i Cabrio	119
Allroad Quattro	47	428i Gran Coupe	88	Z4 sDrive 23i Cabrio	119
e-tron Quattro	47	430i Cabrio	88	Z4 sDrive 30i Cabrio	119
e-tron Sportback Quattro	47	430i Gran Coupe	88	Z4 sDrive 35i Cabrio	119
Q3	47	435i Coupe	89	CADILLAC	
Q3 Quattro	48	525i	89	Escalade	120
Q5 Quattro	49	528i	90	SRX	120
Q7 Quattro	51	528i xDrive	91	CHERY	
Q8 Quattro	54	530i	91	A3	120
R8 Quattro	54	535i	93	Chance	120
R8 Spyder Quattro	54	535i Gran Turismo	93	M11	120
RS3 Quattro	54	535i xDrive Gran Turismo	94	Niche	120
RS3 Sportback Quattro	54	540i	94	Tengo	120
RS4 Quattro	55	540i Touring	95	Tiggo	120
RS5 Quattro	56	545i	95	CHEVROLET	
RS6 Quattro	57	550i	96	Caprice	120
RS7 Sportback Quattro	58	640i Coupe	97	Captiva Sport	120
RSQ3 Quattro	58	645i Coupe	97	Corsa	120
S3 Quattro	59	650i Coupe	97	Equinox	120
S3 Sportback Quattro	59	650i Gran Coupe	98	Lumina APV	120
S4 Quattro	60	650i xDrive Coupe	98	Malibu	120
S5 Cabrio Quattro	61	735i	99	SSR	120
S5 Quattro	62	740i	99	CHRYSLER	
S5 Sportback Quattro	63	745i	100	300C	120
S6 Quattro	63	750i	100	300M	121
S7 Sportback Quattro	64	750i xDrive	102	Grand Voyager	122
S8 Plus Quattro	64	760i	102	Neon	122
S8 Quattro	65	840i	103	PT Cruiser	122
SQ5 Quattro	65	850i	103	Sebring	122
TT	66	i8	103	Stratus	122
TT Quattro	66	M Coupe	103	Town & Country	123
TTRS Quattro	67	M135i	103	CITROËN	
TTS Quattro	68	M135i xDrive	104	AX	123
BENTLEY		M140i	104	Berlingo	123
Bentayga	69	M2 Coupe	104	BX	124
Continental GT	69	M235i Coupe	104	C2	124

MAKE-MODEL	PAGE	MAKE-MODEL	PAGE	MAKE-MODEL	PAGE
CITROËN		FIAT		HYUNDAI	
C3	124	Punto	145	Starex	182
C4	125	Siena	146	Terracan	182
C4 Grand Picasso	125	Siena/Albea	146	Tucson	183
C4 Picasso	126	Strada Pick Up	146	Veloster	184
C5	126	Tipo	146	Veracruz	184
C5 Estate/Break	127	Uno	146	INFINITI	
C6	127	FORD		EX35	185
C8	128	Escort	146	FX35	185
DS3	128	Fiesta	147	IVECO	
DS4	128	Focus	148	Daily	185
DS5	128	KA	151	Daily 35C13	185
Evasion	128	Mondeo	152	Daily 35C13P	186
Jumper	129	Mondeo Estate/Wagon	154	Daily 35C14	186
Jumper 27	129	Transit 300	155	Daily 35C14P	186
Jumper 31	130	Transit 330	155	Daily 35C17	186
Jumper 35	130	Transit 350	157	Daily 35S13	186
Relay	131	Transit 370	158	Daily 35S13P	186
Relay 1400	132	Transit 430	158	Daily 35S14	187
Relay 1800	132	Transit 460	159	Daily 35S14P	187
Xantia	132	FORD ASIA & OCEANIA		JAGUAR	
XM	133	Fiesta	159	E-Pace	187
Xsara	133	Mustang	160	F-Pace	187
Xsara Estate/Break	134	Ranger	160	F-Type	187
Xsara Picasso	135	FORD USA		I-Pace	188
ZX	135	Edge	160	S-Type	188
DAEWOO		Explorer	160	Sovereign	189
Espero	136	F-150 Extended Cab	161	Vanden Plas	189
Kondor (Doninvest)	136	F-150 Standard Cab	161	X-Type	189
Lanos	136	F150	161	XF	189
Leganza	137	Mustang	161	XFR	189
Nubira	137	Ranger	161	XJ12	190
Orion	137	Taurus	162	XJ6	190
Sens	137	HONDA		XJ8	190
DAIHATSU		Accord	162	XJR	190
Applause	138	Accord Aerodeck	164	XJSC	190
Charade	138	Accord VIII/Inspire	164	XK	190
Cuore	138	City	164	XK8	190
Feroza	138	Civic	164	XKR	190
Gran Move	138	Civic Coupe	168	XKRS	190
Mira	138	CR-V	168	JEEP	
Pyzar	138	CRX	170	Cherokee	190
Sportrak	138	Fit	171	Cherokee Classic	191
Terios	138	Odyssey	171	Commander	191
DODGE		Prelude	171	Compass	192
Caravan	138	HUMMER		Grand Cherokee	192
Challenger	139	H3	171	Liberty	193
Durango	139	HYUNDAI		Renegade	194
Grand Caravan	139	Amica	171	Wagoneer	194
Journey	139	Atos	171	Wrangler	194
Nitro	139	Atos Prime	172	KIA	
DS		Azera	172	Cadenza	194
DS5	139	Coupe	172	Carens	194
FERRARI		Creta	172	Carnival	195
550 Maranello	139	Elantra	172	Cerato	195
FIAT		Equus	173	Cerato Koup	196
147	140	Excel	173	Ceres	196
500	140	Galloper	174	Clarus	196
Albea	140	Genesis	174	Credos	196
Coupe	140	Grace	174	Grand Carnival	196
Croma	140	Grand Santa Fe	174	K2500	196
Ducato 10	140	Grandeur	174	Lotze	196
Ducato 14	141	H1	174	Magentis	196
Ducato 18	142	H100	175	Mentor	197
Ducato 28	143	H150	175	Mohave	197
Ducato 30	143	H200	176	Opirus	197
Ducato 33	143	i30	176	Optima	198
Ducato 35	144	i30 CW	177	Picanto	198
Ducato 40	144	iX55	177	Sedona	199
Elba	144	Lantra	177	Sephia	199
Freemont	145	Pony	177	Shuma	199
Marea	145	Santa Fe	178	Sorento	199
Palio	145	Satellite	179	Soul	201
Palio Weekend	145	Sonata	179	Sportage	202
Premio	145	Sonica	181		



MAKE-MODEL	PAGE	MAKE-MODEL	PAGE	MAKE-MODEL	PAGE
LADA		MERCEDES-BENZ		MERCEDES-BENZ	
Kalinka	204	C36 AMG	244	S400	287
Niva	204	C43 AMG	244	S500	288
Nova	204	C55 AMG	245	S500 Maybach	289
Samara	204	C63 AMG	245	S55 AMG	290
Taiga	204	CL500	246	S560	290
LAMBORGHINI		CL55 AMG	246	S600	290
Murcielago	204	CL600	246	S63 AMG	291
LANCIA		CL63 AMG	247	S65 AMG	292
Lybra Estate/Wagon	204	CL65 AMG	247	SL280	292
LAND ROVER		CLA180	247	SL320	293
Defender 110	204	CLA200	248	SL350	293
Defender 130	205	CLA250	248	SL400	293
Defender 90	205	CLA45 AMG	248	SL500	293
Discovery	205	CLC200	249	SL600	294
Discovery III	207	CLK230	249	SL63 AMG	294
Discovery Sport	207	CLK320	249	SL65 AMG	295
Freelander	207	CLK350	250	SLC300	295
Range Rover	208	CLK430	251	SLC43 AMG	295
Range Rover Evoque	210	CLK500	251	SLK200	295
Range Rover Sport	211	CLK55 AMG	251	SLK230	296
Range Rover Velar	214	CLS350	252	SLK250	296
LEXUS		CLS400	253	SLK300	297
CT 200h	214	CLS500	253	SLK32 AMG	297
ES 330	214	CLS53 AMG	254	SLK320	297
ES 350	214	CLS55 AMG	254	SLK350	297
IS 250	214	CLS550	255	SLK55 AMG	298
IS 300	214	CLS63 AMG	255	SLS AMG	299
LS 430	215	E200	256	Sprinter 311D	299
LS 460	215	E220	257	Sprinter 313D	300
LS 600h	215	E230	258	Sprinter 314D	301
NX 200t	215	E240	258	Sprinter 413D	301
NX 300	216	E250	260	Sprinter 416D	302
RX 350	216	E280	261	Sprinter 516D	302
MASERATI		E300	263	Vito 111	302
3200 GT	216	E320	263	MINI	
Quattroporte	216	E350	266	Mini Clubman	302
MAZDA		E420	269	Mini Cooper	303
626	217	E43 AMG	269	Mini Countryman	305
AZ3	217	E430	270	Mini Coupe	306
B2200	217	E500	270	Mini One	306
B2500	217	E55 AMG	272	Mini Paceman	306
Cronos	217	E63 AMG	273	Mini Roadster	306
MX3	217	G320	274	MITSUBISHI	
Roadster	218	G55 AMG	274	3000 GT	307
Telstar	218	G63 AMG	274	Challenger	307
MERCEDES-BENZ		GLA200	274	Colt	307
190	218	GLA250	274	Eclipse	309
230	219	GLA45 AMG	275	Expo	309
250	219	GLB200	275	G-Wagon	309
260	220	GLC250	275	Galant	310
300	220	GLC300	276	Grandis	310
500	222	GLC43 AMG	276	GTO	310
600	223	GLC63 AMG	277	L200	310
A160	223	GLE350	278	L200/Triton/Hunter	311
A190	224	GLE400	278	L300	311
A200	224	GLE43 AMG	278	Lancer	311
A250	224	GLE450 AMG	278	Lancer Evolution	312
A35 AMG	225	GLE63 AMG	278	Lancer Sportback	312
A45 AMG	225	GLK220	279	Montero	313
AMG GT	226	GLK280	279	Montero Sport	315
AMG GT 63	226	GLK300	280	Outlander	316
B180	226	GLS350	280	Pajero	317
B200	226	ML230	280	Pajero Sport	319
C180	226	ML270	281	Shogun	319
C200	230	ML320	281	Space Wagon	321
C220	232	ML350	282	NISSAN	
C230	233	ML430	283	350Z	322
C240	235	ML500	284	370Z	323
C250	236	ML55 AMG	285	Altima	323
C280	238	ML63 AMG	285	Frontier	323
C300	239	R500	286	Leaf	323
C32 AMG	241	S280	286	Maxima	323
C320	242	S320	286	Maxima QX	323
C350	243	S350	287	Murano	324



MAKE-MODEL	PAGE	MAKE-MODEL	PAGE	MAKE-MODEL	PAGE
NISSAN		RENAULT		VOLVO	
Navara	324	Twingo	358	960	386
Navara/Frontier/Skystar/Datsun	326	Zoe	359	C30	386
NP300 Frontier	326	ROLLS-ROYCE		C70	387
NP300 Navara	326	Ghost	359	S40	388
Pathfinder	326	Phantom	359	S60	390
QX	328	Wraith	359	S70	391
Sentra (USA)	328	SEAT		S80	391
Terrano (Pick Up)	328	Cordoba	359	V40	392
Terrano II	328	Cordoba Vario	360	V40 Cross Country	393
X-Trail	329	Ibiza	360	V50	393
PEUGEOT		Inca	362	V60	396
106	329	SMART		V70	397
205	330	Fortwo Cabrio	362	XC60	398
206	330	Fortwo Coupe	362	XC70	400
206 CC	331	SSANGYONG		XC90	400
206 SW	331	Actyon	362	VW	
207	332	Actyon Sports	363	Amarok	401
207 SW	332	Korando	363	Beetle	403
3008	332	Korando Family	363	Bjalla	404
306	332	Kyron	363	Bora	405
306 Cabrio	335	Musso	364	Caddy	405
307	335	Rexton	364	Campmobile	405
307 CC	336	Rexton II	365	Caravelle	405
307 SW	336	Rexton W	366	CC	406
405	337	SUBARU		Eos	406
406	337	Forester	366	Fox	407
406 Coupe	338	Impreza	367	Gol	410
407	338	Impreza Estate/Wagon Plus	368	Golf	410
407 SW	339	Impreza WRX	368	Golf Cabrio	416
5008	340	Legacy	369	Golf Estate/Variant	417
508	340	Legacy Estate/Wagon	371	Jetta	417
605	340	Legacy II	372	Jetta City	420
607	340	Outback	372	Kaefer/Kaver	420
806	341	SVX	372	Lupo	420
807	341	Tribeca	372	Multivan	420
Boxer	341	WRX	373	New Beetle	421
Partner	341	XV	373	Passat	421
PORSCHE		SUZUKI		Passat CC	425
718 Boxster	342	Baleno Estate/Wagon	373	Passat Estate/Variant	425
718 Cayman	342	Escudo	373	Polo	429
911	342	Grand Escudo	374	Polo Classic	431
911 GT2	343	Grand Vitara	374	Polo Vivo	431
911 GT3	343	Ignis	375	Quantum	431
911 R	343	Jimny	375	Saveiro	432
911 Turbo	343	Samurai	376	Spacefox/Space Cross	432
968	343	Sidekick	376	Suran	432
Boxster	343	Swift	376	Suran Variant	432
Cayenne	343	SX4	376	T-Cross	432
Cayman	348	SX4 S-Cross	376	Tiguan	432
Macan	348	Vitara	376	Tiguan Allspace	433
Panamera	349	TESLA		Touareg	434
RENAULT		Model 3	377	Transporter	436
19	350	Model S P100D	377	UP!	438
21	350	Model S P85D	377	Virtus	438
Clio	350	Model S P90D	377	Voyage	438
Clio II/Lutecia	351	Model X P90D	377	TOYOTA	
Clio Symbol	351	TOYOTA		4 Runner/Surf/Hilux Surf	377
Fluence	352	4 Runner/Surf/Hilux Surf	377	Camry	378
Kangoo	352	Camry	378	Corolla	380
Kangoo Express	352	Corolla	380	Corolla Altis	380
Laguna	352	Corolla Altis	380	Corolla Estate/Wagon	381
Laguna Estate/Break	353	Corolla Estate/Wagon	381	FJ Cruiser	381
Master T28	353	FJ Cruiser	381	Fortuner	381
Master T33	354	Fortuner	381	Hilux	381
Master T35	355	Hilux	381	Hilux Surf	382
Master T39	356	Hilux Surf	382	Land Cruiser Prado	382
Megane	356	Land Cruiser Prado	382	Paseo	383
Megane CC	357	Paseo	383	Previa	383
Megane Classic	357	Previa	383	Rav 4	383
Megane Estate/Break	357	Rav 4	383	VOLVO	
Oroch	357	VOLVO		460	385
Safrane	358	460	385	850	385
Sandero Stepway	358	850	385	850 Estate/Combi	386
Scenic	358	850 Estate/Combi	386		



	 YEAR	FITTING POSITION	BODY STYLE & DRIVE TYPE & ENGINE	REMARKS	PRODUCT	GSP Ref.
ALFA ROMEO						
145						
1.8 (103 kw)	1996.12-1998.12	Front Axle Left Lower	Hatchback FWD AR67106		Track Control Arm	S060019
	1996.12-1998.12	Front Axle Right Lower	Hatchback FWD AR67106		Track Control Arm	S060020
	1996.12-1998.12	Rear Axle Left Lower	Hatchback FWD AR67106		Track Control Arm	S060329
	1996.12-1998.12	Rear Axle Right Lower	Hatchback FWD AR67106		Track Control Arm	S060328
	1996.12-1998.12	Front Axle Left & Right	Hatchback FWD AR67106		Tie Rod Axle Joint	S030005
	1996.12-1998.12	Front Axle Left & Right	Hatchback FWD AR67106		Tie Rod End	S070562
	1996.12-1998.12	Front Axle Left & Right	Hatchback FWD AR67106		Rod/Strut, stabiliser	S050016
	1996.12-1998.12	Rear Axle Left & Right	Hatchback FWD AR67106		Bellow Set, suspension	511465S
2.0 (110 kw)	1995.10-2001.01	Front Axle Left Lower	Hatchback FWD AR67204		Track Control Arm	S060019
	1995.10-2001.01	Front Axle Right Lower	Hatchback FWD AR67204		Track Control Arm	S060020
	1995.10-2001.01	Rear Axle Left Lower	Hatchback FWD AR67204		Track Control Arm	S060329
	1995.10-2001.01	Rear Axle Right Lower	Hatchback FWD AR67204		Track Control Arm	S060328
	1995.10-2001.01	Front Axle Left & Right	Hatchback FWD AR67204		Tie Rod Axle Joint	S030005
	1995.10-2001.01	Front Axle Left	Hatchback FWD AR67204		Tie Rod End	S070010
	1995.10-2001.01	Front Axle Right	Hatchback FWD AR67204		Tie Rod End	S070011
	1995.10-2001.01	Front Axle Left & Right	Hatchback FWD AR67204		Tie Rod End	S070562
	1995.10-2001.01	Front Axle Left & Right	Hatchback FWD AR67204		Rod/Strut, stabiliser	S050016
1995.10-2001.01	Rear Axle Left & Right	Hatchback FWD AR67204		Bellow Set, suspension	511465S	
147						
2.0 (110 kw)	2000.10-2010.03	Front Axle Left Lower	Hatchback FWD AR32310		Track Control Arm	S060003
	2000.10-2010.03	Front Axle Left Upper	Hatchback FWD AR32310		Track Control Arm	S060001
	2000.10-2010.03	Front Axle Right Lower	Hatchback FWD AR32310		Track Control Arm	S060004
	2000.10-2010.03	Front Axle Right Upper	Hatchback FWD AR32310		Track Control Arm	S060002
	2000.10-2010.03	Rear Axle Left Lower	Hatchback FWD AR32310		Track Control Arm	S060795
	2000.10-2010.03	Rear Axle Right Lower	Hatchback FWD AR32310		Track Control Arm	S060796
	2000.10-2010.03	Rear Axle Left & Right Lower Inner	Hatchback FWD AR32310		Track Control Arm	S060008
	2000.10-2010.03	Rear Axle Left & Right Lower Outer	Hatchback FWD AR32310		Track Control Arm	S060007
	2000.10-2010.03	Front Axle Left Lower	Hatchback FWD AR32310		Control Arm Bushing	531951
	2000.10-2010.03	Rear Axle Left & Right Lower Inner	Hatchback FWD AR32310		Control Arm Bushing	535470
	2000.10-2010.03	Rear Axle Left & Right Lower Outer	Hatchback FWD AR32310		Control Arm Bushing	535469
	2000.10-2010.03	Front Axle	Hatchback FWD AR32310		Suspension Repair Kit	S990033SK
	2000.10-2010.03	Front Axle Left & Right	Hatchback FWD AR32310		Tie Rod Axle Joint	S030001
	2000.10-2010.03	Front Axle Left	Hatchback FWD AR32310		Tie Rod End	S070002
	2000.10-2010.03	Front Axle Right	Hatchback FWD AR32310		Tie Rod End	S070003
	2000.10-2010.03	Front Axle Left & Right	Hatchback FWD AR32310		Rod/Strut, stabiliser	S050002
	2000.10-2010.03	Rear Axle Left & Right	Hatchback FWD AR32310		Rod/Strut, stabiliser	S050015
	2000.10-2010.03	Front Axle	Hatchback FWD AR32310		Steering Boot	540201
	2000.10-2010.03	Front Axle	Hatchback FWD AR32310		Steering Rack Bellow Kit	540201S
	155					
2.0 (110 kw)	1995.03-1997.12	Front Axle Left Lower	Saloon FWD AR67204		Track Control Arm	S060019
	1995.03-1997.12	Front Axle Right Lower	Saloon FWD AR67204		Track Control Arm	S060020
	1995.03-1997.12	Front Axle Left & Right	Saloon FWD AR67204		Tie Rod Axle Joint	S030005
	1995.03-1997.12	Front Axle Left	Saloon FWD AR67204		Tie Rod End	S070010
	1995.03-1997.12	Front Axle Right	Saloon FWD AR67204		Tie Rod End	S070011
	1995.03-1997.12	Front Axle Left & Right	Saloon FWD AR67204		Tie Rod End	S070562
	1995.03-1997.12	Front Axle Left & Right	Saloon FWD AR67204		Tie Rod End	S070840
	1995.03-1997.12	Front Axle Left & Right	Saloon FWD AR67204		Rod/Strut, stabiliser	S050016
156						
2.0 (110 kw)	2000.10-2002.03	Front Axle Left Lower	Estate FWD AR32310		Track Control Arm	S060003
	2000.10-2002.03	Front Axle Left Upper	Estate FWD AR32310		Track Control Arm	S060001
	2000.10-2002.03	Front Axle Right Lower	Estate FWD AR32310		Track Control Arm	S060004
	2000.10-2002.03	Front Axle Right Upper	Estate FWD AR32310		Track Control Arm	S060002
	2000.10-2002.03	Rear Axle Left Lower	Estate FWD AR32310		Track Control Arm	S060795
	2000.10-2002.03	Rear Axle Right Lower	Estate FWD AR32310		Track Control Arm	S060796
	2000.10-2002.03	Rear Axle Left & Right Lower Inner	Estate FWD AR32310		Track Control Arm	S060008
	2000.10-2002.03	Rear Axle Left & Right Lower Outer	Estate FWD AR32310		Track Control Arm	S060007
	2000.10-2002.03	Front Axle Left Lower	Estate FWD AR32310		Control Arm Bushing	531951
	2000.10-2002.03	Rear Axle Left & Right Lower Inner	Estate FWD AR32310		Control Arm Bushing	535470
	2000.10-2002.03	Rear Axle Left & Right Lower Outer	Estate FWD AR32310		Control Arm Bushing	535469
	2000.10-2002.03	Front Axle Left & Right	Estate FWD AR32310		Tie Rod Axle Joint	S030001
	2000.10-2002.03	Front Axle Left	Estate FWD AR32310		Tie Rod End	S070002
	2000.10-2002.03	Front Axle Right	Estate FWD AR32310		Tie Rod End	S070003
	2000.10-2002.03	Front Axle Left & Right	Estate FWD AR32310		Rod/Strut, stabiliser	S050002
	2000.10-2002.03	Rear Axle Left & Right	Estate FWD AR32310		Rod/Strut, stabiliser	S050015



	 YEAR	FITTING POSITION	BODY STYLE & DRIVE TYPE & ENGINE	REMARKS	PRODUCT	GSP Ref.
ALFA ROMEO						
156						
2.0 (110 kw)	2000.10-2002.03	Front Axle	Estate FWD AR32310		Steering Boot	540201
	2000.10-2002.03	Front Axle	Estate FWD AR32310		Steering Rack Bellow Kit	540201S
2.0 (114 kw)	1997.09-2001.07	Front Axle Left Lower	Saloon FWD AR32301		Track Control Arm	S060003
	1997.09-2001.07	Front Axle Left Upper	Saloon FWD AR32301		Track Control Arm	S060001
	1997.09-2001.07	Front Axle Right Lower	Saloon FWD AR32301		Track Control Arm	S060004
	1997.09-2001.07	Front Axle Right Upper	Saloon FWD AR32301		Track Control Arm	S060002
	1997.09-2001.07	Rear Axle Left Lower	Saloon FWD AR32301		Track Control Arm	S060795
	1997.09-2001.07	Rear Axle Right Lower	Saloon FWD AR32301		Track Control Arm	S060796
	1997.09-2001.07	Rear Axle Left & Right Lower Inner	Saloon FWD AR32301		Track Control Arm	S060008
	1997.09-2001.07	Rear Axle Left & Right Lower Outer	Saloon FWD AR32301		Track Control Arm	S060007
	1997.09-2001.07	Front Axle Left Lower	Saloon FWD AR32301		Control Arm Bushing	531951
	1997.09-2001.07	Rear Axle Left & Right Lower Inner	Saloon FWD AR32301		Control Arm Bushing	535470
	1997.09-2001.07	Rear Axle Left & Right Lower Outer	Saloon FWD AR32301		Control Arm Bushing	535469
	1997.09-2001.07	Front Axle Left & Right	Saloon FWD AR32301		Tie Rod Axle Joint	S030001
	1997.09-2001.07	Front Axle Left	Saloon FWD AR32301		Tie Rod End	S070002
	1997.09-2001.07	Front Axle Right	Saloon FWD AR32301		Tie Rod End	S070003
	1997.09-2001.07	Front Axle Left & Right	Saloon FWD AR32301		Rod/Strut, stabiliser	S050002
	1997.09-2001.07	Rear Axle Left & Right	Saloon FWD AR32301		Rod/Strut, stabiliser	S050015
	1997.09-2001.07	Front Axle	Saloon FWD AR32301		Steering Boot	540201
1997.09-2001.07	Front Axle	Saloon FWD AR32301		Steering Rack Bellow Kit	540201S	
2.0 (122 kw)	2002.03-2006.05	Front Axle Left Lower	Estate FWD 937A1000		Track Control Arm	S060003
	2002.03-2006.05	Front Axle Left Upper	Estate FWD 937A1000		Track Control Arm	S060001
	2002.03-2006.05	Front Axle Right Lower	Estate FWD 937A1000		Track Control Arm	S060004
	2002.03-2006.05	Front Axle Right Upper	Estate FWD 937A1000		Track Control Arm	S060002
	2002.03-2006.05	Rear Axle Left Lower	Estate FWD 937A1000		Track Control Arm	S060795
	2002.03-2006.05	Rear Axle Right Lower	Estate FWD 937A1000		Track Control Arm	S060796
	2002.03-2006.05	Rear Axle Left & Right Lower Inner	Estate FWD 937A1000		Track Control Arm	S060008
	2002.03-2006.05	Rear Axle Left & Right Lower Outer	Estate FWD 937A1000		Track Control Arm	S060007
	2002.03-2006.05	Front Axle Left Lower	Estate FWD 937A1000		Control Arm Bushing	531951
	2002.03-2006.05	Rear Axle Left & Right Lower Inner	Estate FWD 937A1000		Control Arm Bushing	535470
	2002.03-2006.05	Rear Axle Left & Right Lower Outer	Estate FWD 937A1000		Control Arm Bushing	535469
	2002.03-2006.05	Front Axle	Estate FWD 937A1000		Suspension Repair Kit	S990033SK
	2002.03-2006.05	Front Axle Left & Right	Estate FWD 937A1000		Tie Rod Axle Joint	S030001
	2002.03-2006.05	Front Axle Left	Estate FWD 937A1000		Tie Rod End	S070002
	2002.03-2006.05	Front Axle Right	Estate FWD 937A1000		Tie Rod End	S070003
	2002.03-2006.05	Front Axle Left & Right	Estate FWD 937A1000		Rod/Strut, stabiliser	S050002
	2002.03-2006.05	Rear Axle Left & Right	Estate FWD 937A1000		Rod/Strut, stabiliser	S050015
2002.03-2006.05	Front Axle	Estate FWD 937A1000		Steering Boot	540201	
2002.03-2006.05	Front Axle	Estate FWD 937A1000		Steering Rack Bellow Kit	540201S	
2.5 (140 kw)	1997.02-2002.09	Front Axle Left Lower	Saloon FWD AR32401		Track Control Arm	S060003
	1997.02-2002.09	Front Axle Left Upper	Saloon FWD AR32401		Track Control Arm	S060001
	1997.02-2002.09	Front Axle Right Lower	Saloon FWD AR32401		Track Control Arm	S060004
	1997.02-2002.09	Front Axle Right Upper	Saloon FWD AR32401		Track Control Arm	S060002
	1997.02-2002.09	Rear Axle Left Lower	Saloon FWD AR32401		Track Control Arm	S060795
	1997.02-2002.09	Rear Axle Right Lower	Saloon FWD AR32401		Track Control Arm	S060796
	1997.02-2002.09	Rear Axle Left & Right Lower Inner	Saloon FWD AR32401		Track Control Arm	S060008
	1997.02-2002.09	Rear Axle Left & Right Lower Outer	Saloon FWD AR32401		Track Control Arm	S060007
	1997.02-2002.09	Front Axle Left Lower	Saloon FWD AR32401		Control Arm Bushing	531951
	1997.02-2002.09	Rear Axle Left & Right Lower Inner	Saloon FWD AR32401		Control Arm Bushing	535470
	1997.02-2002.09	Rear Axle Left & Right Lower Outer	Saloon FWD AR32401		Control Arm Bushing	535469
	1997.02-2002.09	Front Axle Left & Right	Saloon FWD AR32401		Tie Rod Axle Joint	S030001
	1997.02-2002.09	Front Axle Left	Saloon FWD AR32401		Tie Rod End	S070002
	1997.02-2002.09	Front Axle Right	Saloon FWD AR32401		Tie Rod End	S070003
	1997.02-2002.09	Front Axle Left & Right	Saloon FWD AR32401		Rod/Strut, stabiliser	S050002
	1997.02-2002.09	Rear Axle Left & Right	Saloon FWD AR32401		Rod/Strut, stabiliser	S050015
	1997.02-2002.09	Front Axle	Saloon FWD AR32401		Steering Boot	540201
1997.02-2002.09	Front Axle	Saloon FWD AR32401		Steering Rack Bellow Kit	540201S	
2.5 (141 kw)	1997.02-2005.10	Front Axle Left Lower	Saloon FWD AR32405		Track Control Arm	S060003
	1997.02-2005.10	Front Axle Left Upper	Saloon FWD AR32405		Track Control Arm	S060001
	1997.02-2005.10	Front Axle Right Lower	Saloon FWD AR32405		Track Control Arm	S060004
	1997.02-2005.10	Front Axle Right Upper	Saloon FWD AR32405		Track Control Arm	S060002
	1997.02-2005.10	Rear Axle Left Lower	Saloon FWD AR32405		Track Control Arm	S060795
	1997.02-2005.10	Rear Axle Right Lower	Saloon FWD AR32405		Track Control Arm	S060796
	1997.02-2005.10	Rear Axle Left & Right Lower Inner	Saloon FWD AR32405		Track Control Arm	S060008



 YEAR	FITTING POSITION	BODY STYLE & DRIVE TYPE & ENGINE	REMARKS	PRODUCT	GSP Ref.
ALFA ROMEO					
156					
2.5 (141 kw)	1997.02-2005.10	Rear Axle Left & Right Lower Outer	Saloon FWD AR32405		Track Control Arm S060007
	1997.02-2005.10	Front Axle Left Lower	Saloon FWD AR32405		Control Arm Bushing 531951
	1997.02-2005.10	Rear Axle Left & Right Lower Inner	Saloon FWD AR32405		Control Arm Bushing 535470
	1997.02-2005.10	Rear Axle Left & Right Lower Outer	Saloon FWD AR32405		Control Arm Bushing 535469
	1997.02-2005.10	Front Axle	Saloon FWD AR32405		Suspension Repair Kit S990033SK
	1997.02-2005.10	Front Axle Left & Right	Saloon FWD AR32405		Tie Rod Axle Joint S030001
	1997.02-2005.10	Front Axle Left	Saloon FWD AR32405		Tie Rod End S070002
	1997.02-2005.10	Front Axle Right	Saloon FWD AR32405		Tie Rod End S070003
	1997.02-2005.10	Front Axle Left & Right	Saloon FWD AR32405		Rod/Strut, stabiliser S050002
	1997.02-2005.10	Rear Axle Left & Right	Saloon FWD AR32405		Rod/Strut, stabiliser S050015
	1997.02-2005.10	Front Axle	Saloon FWD AR32405		Steering Boot 540201
	1997.02-2005.10	Front Axle	Saloon FWD AR32405		Steering Rack Bellow Kit 540201S
159					
3.2 (191 kw)	2005.12-2011.11	Front Axle Left Lower	Saloon 4WD 939A000		Track Control Arm S060011
	2005.12-2011.11	Front Axle Left Upper	Saloon 4WD 939A000		Track Control Arm S060009
	2005.12-2011.11	Front Axle Right Lower	Saloon 4WD 939A000		Track Control Arm S060012
	2005.12-2011.11	Front Axle Right Upper	Saloon 4WD 939A000		Track Control Arm S060010
	2005.12-2011.11	Front Axle Left Lower	Saloon 4WD 939A000		Control Arm Bushing 519066
	2005.12-2011.11	Front Axle Right Lower	Saloon 4WD 939A000		Control Arm Bushing 519067
	2005.12-2011.11	Front Axle Left	Saloon 4WD 939A000		Tie Rod End S070005
	2005.12-2011.11	Front Axle Right	Saloon 4WD 939A000		Tie Rod End S070006
	2005.12-2011.11	Front Axle Left	Saloon 4WD 939A000		Rod/Strut, stabiliser S050010
	2005.12-2011.11	Front Axle Right	Saloon 4WD 939A000		Rod/Strut, stabiliser S050009
164					
3.0 (132 kw)	1992.09-1998.10	Front Axle Left & Right	Saloon FWD AR64305/AR66303		Tie Rod End S070824
	1992.09-1998.10	Front Axle Left & Right	Saloon FWD AR64305/AR66303		Tie Rod End S070866
3.0 (141 kw)	1987.06-1992.10	Front Axle Left & Right	Saloon FWD AR64303		Tie Rod End S070824
	1987.06-1992.10	Front Axle Left & Right	Saloon FWD AR64303		Tie Rod End S070866
3.0 (155 kw)	1992.09-1998.09	Rear Axle Left Lower	Saloon FWD AR66301/AR66302		Track Control Arm S060795
	1992.09-1998.09	Rear Axle Right Lower	Saloon FWD AR66301/AR66302		Track Control Arm S060796
166					
3.0 (166 kw)	1998.09-2002.06	Front Axle Left Lower	Saloon FWD AR34301		Track Control Arm S060017
	1998.09-2002.06	Front Axle Left Upper	Saloon FWD AR34301		Track Control Arm S060322
	1998.09-2002.06	Front Axle Right Lower	Saloon FWD AR34301		Track Control Arm S060018
	1998.09-2002.06	Front Axle Right Upper	Saloon FWD AR34301		Track Control Arm S060323
	1998.09-2002.06	Front Axle Left & Right	Saloon FWD AR34301		Tie Rod Axle Joint S030002
	1998.09-2002.06	Front Axle Left	Saloon FWD AR34301		Tie Rod End S070002
	1998.09-2002.06	Front Axle Right	Saloon FWD AR34301		Tie Rod End S070003
	1998.09-2002.06	Front Axle	Saloon FWD AR34301		Steering Boot 540201
	1998.09-2002.06	Front Axle	Saloon FWD AR34301		Steering Rack Bellow Kit 540201S
	AUDI				
100 Quattro					
2.2 (169 kw)	1990.12-1994.07	Front Axle Left Lower	Saloon 4WD AAN		Track Control Arm S060040
	1990.12-1994.07	Front Axle Right Lower	Saloon 4WD AAN		Track Control Arm S060041
	1990.12-1994.07	Rear Axle Left Upper	Saloon 4WD AAN		Track Control Arm S060036
	1990.12-1994.07	Rear Axle Right Upper	Saloon 4WD AAN		Track Control Arm S060037
	1990.12-1994.07	Front Axle Left & Right Lower	Saloon 4WD AAN		Control Arm Bushing 510126
	1990.12-1994.07	Front Axle Left & Right Lower	Saloon 4WD AAN		Control Arm Bushing 510127
	1990.12-1994.07	Rear Axle Left & Right	Saloon 4WD AAN		Control Arm Bushing 530206
	1990.12-1994.07	Rear Axle Left & Right Lower	Saloon 4WD AAN		Control Arm Bushing 510132
	1990.12-1994.07	Rear Axle Left & Right Lower	Saloon 4WD AAN		Control Arm Bushing 530207
	1990.12-1994.07	Front Axle Left	Saloon 4WD AAN		Tie Rod End S070022
	1990.12-1994.07	Front Axle Right	Saloon 4WD AAN		Tie Rod End S070023
	1990.12-1994.07	Front Axle	Saloon 4WD AAN		Stabiliser Bushing 510128
	1991.08-1994.07	Front Axle Left Lower	Estate 4WD AAN		Track Control Arm S060040
	1991.08-1994.07	Front Axle Right Lower	Estate 4WD AAN		Track Control Arm S060041
	1991.08-1994.07	Rear Axle Left Upper	Estate 4WD AAN		Track Control Arm S060036
	1991.08-1994.07	Rear Axle Right Upper	Estate 4WD AAN		Track Control Arm S060037
	1991.08-1994.07	Front Axle Left & Right Lower	Estate 4WD AAN		Control Arm Bushing 510126
	1991.08-1994.07	Front Axle Left & Right Lower	Estate 4WD AAN		Control Arm Bushing 510127
	1991.08-1994.07	Rear Axle Left & Right	Estate 4WD AAN		Control Arm Bushing 530206
	1991.08-1994.07	Rear Axle Left & Right Lower	Estate 4WD AAN		Control Arm Bushing 510132
	1991.08-1994.07	Rear Axle Left & Right Lower	Estate 4WD AAN		Control Arm Bushing 530207
	1991.08-1994.07	Front Axle Left	Estate 4WD AAN		Tie Rod End S070022



	 YEAR	FITTING POSITION	BODY STYLE & DRIVE TYPE & ENGINE	REMARKS	PRODUCT	GSP Ref.
AUDI						
100 Quattro						
2.2 (169 kw)	1991.08-1994.07	Front Axle Right	Estate 4WD AAN		Tie Rod End	S070023
	1991.08-1994.07	Front Axle	Estate 4WD AAN		Stabiliser Bushing	510128
2.8 (128 kw)	1990.12-1994.07	Front Axle Left Lower	Saloon 4WD AAH		Track Control Arm	S060040
	1990.12-1994.07	Front Axle Right Lower	Saloon 4WD AAH		Track Control Arm	S060041
	1990.12-1994.07	Rear Axle Left Upper	Saloon 4WD AAH		Track Control Arm	S060036
	1990.12-1994.07	Rear Axle Right Upper	Saloon 4WD AAH		Track Control Arm	S060037
	1990.12-1994.07	Front Axle Left & Right Lower	Saloon 4WD AAH		Control Arm Bushing	510126
	1990.12-1994.07	Front Axle Left & Right Lower	Saloon 4WD AAH		Control Arm Bushing	510127
	1990.12-1994.07	Rear Axle Left & Right	Saloon 4WD AAH		Control Arm Bushing	530206
	1990.12-1994.07	Rear Axle Left & Right Lower	Saloon 4WD AAH		Control Arm Bushing	510114
	1990.12-1994.07	Rear Axle Left & Right Lower	Saloon 4WD AAH		Control Arm Bushing	510132
	1990.12-1994.07	Rear Axle Left & Right Lower	Saloon 4WD AAH		Control Arm Bushing	530207
	1990.12-1994.07	Front Axle Left	Saloon 4WD AAH		Tie Rod End	S070022
	1990.12-1994.07	Front Axle Right	Saloon 4WD AAH		Tie Rod End	S070023
	1990.12-1994.07	Front Axle	Saloon 4WD AAH		Stabiliser Bushing	510128
	1990.12-1994.07	Front Axle	Saloon 4WD AAH		Steering Boot	540021
	1990.12-1994.07	Front Axle	Saloon 4WD AAH		Sleeve,control arm mounting	530196
80						
2.0 (85 kw)	1992.08-1995.07	Front Axle Left Lower	Estate FWD ABK		Track Control Arm	S060336
	1992.08-1995.07	Front Axle Right Lower	Estate FWD ABK		Track Control Arm	S060781
	1992.08-1995.07	Front Axle Left & Right Lower Outer	Estate FWD ABK		Track Control Arm	S060054
	1992.08-1995.07	Front Axle Left Lower	Estate FWD ABK		Ball Joint	S080008
	1992.08-1995.07	Front Axle Right Lower	Estate FWD ABK		Ball Joint	S080009
	1992.08-1995.07	Front Axle Left & Right Lower	Estate FWD ABK		Control Arm Bushing	510169
	1992.08-1995.07	Front Axle Left & Right Lower	Estate FWD ABK		Control Arm Bushing	510217
	1992.08-1995.07	Front Axle Left & Right Lower	Estate FWD ABK	Quantity:4,To Chassis:8CN175591	Control Arm Bushing	510253
	1992.08-1995.07	Front Axle Left	Estate FWD ABK		Rod Assembly	S100012
	1992.08-1995.07	Front Axle Left & Right	Estate FWD ABK		Tie Rod End	S070018
	1992.08-1995.07	Front Axle Left & Right	Estate FWD ABK		Rod/Strut,stabiliser	S050027
	1992.08-1995.07	Rear Axle Left	Estate FWD ABK		Rod/Strut,stabiliser	S050030
	1992.08-1995.07	Rear Axle Right	Estate FWD ABK		Rod/Strut,stabiliser	S050031
	1992.08-1995.07	Front Axle	Estate FWD ABK		Stabiliser Bushing	510167
	1992.08-1995.07	Front Axle	Estate FWD ABK		Stabiliser Bushing	512278
	1992.08-1995.07	Front Axle	Estate FWD ABK		Steering Rack Bellow Kit	540245S
80 Quattro						
2.0 (85 kw)	1991.09-1994.12	Front Axle Left Lower	Saloon 4WD ABK		Track Control Arm	S060336
	1991.09-1994.12	Front Axle Right Lower	Saloon 4WD ABK		Track Control Arm	S060781
	1991.09-1994.12	Front Axle Left Lower	Saloon 4WD ABK		Ball Joint	S080008
	1991.09-1994.12	Front Axle Right Lower	Saloon 4WD ABK		Ball Joint	S080009
	1991.09-1994.12	Front Axle Left & Right Lower	Saloon 4WD ABK		Control Arm Bushing	510169
	1991.09-1994.12	Front Axle Left & Right Lower	Saloon 4WD ABK		Control Arm Bushing	510217
	1991.09-1994.12	Rear Axle Left & Right Lower	Saloon 4WD ABK		Control Arm Bushing	517142
	1991.09-1994.12	Rear Axle Left & Right Lower	Saloon 4WD ABK		Control Arm Bushing	530207
	1991.09-1994.12	Front Axle Left	Saloon 4WD ABK		Rod Assembly	S100012
	1991.09-1994.12	Front Axle Left & Right	Saloon 4WD ABK		Tie Rod End	S070018
	1991.09-1994.12	Front Axle Left & Right	Saloon 4WD ABK		Rod/Strut,stabiliser	S050027
	1991.09-1994.12	Rear Axle Left	Saloon 4WD ABK		Rod/Strut,stabiliser	S050030
	1991.09-1994.12	Rear Axle Right	Saloon 4WD ABK		Rod/Strut,stabiliser	S050031
	1991.09-1994.12	Front Axle	Saloon 4WD ABK		Stabiliser Bushing	510167
	1991.09-1994.12	Front Axle	Saloon 4WD ABK		Stabiliser Bushing	512278
	1991.09-1994.12	Front Axle	Saloon 4WD ABK		Steering Rack Bellow Kit	540245S
2.2 (169 kw)	1993.07-1995.07	Front Axle Left Lower	Estate 4WD ABY		Track Control Arm	S060336
	1993.07-1995.07	Front Axle Right Lower	Estate 4WD ABY		Track Control Arm	S060781
	1993.07-1995.07	Front Axle Left Lower	Estate 4WD ABY		Ball Joint	S080008
	1993.07-1995.07	Front Axle Right Lower	Estate 4WD ABY		Ball Joint	S080009
	1993.07-1995.07	Front Axle Left & Right Lower	Estate 4WD ABY		Control Arm Bushing	510169
	1993.07-1995.07	Front Axle Left & Right Lower	Estate 4WD ABY		Control Arm Bushing	510217
	1993.07-1995.07	Front Axle Left & Right Lower	Estate 4WD ABY		Control Arm Bushing	510253
	1993.07-1995.07	Rear Axle Left & Right Lower	Estate 4WD ABY		Control Arm Bushing	517142
	1993.07-1995.07	Rear Axle Left & Right Lower	Estate 4WD ABY		Control Arm Bushing	530207
	1993.07-1995.07	Front Axle Left	Estate 4WD ABY		Rod Assembly	S100012
	1993.07-1995.07	Front Axle Left & Right	Estate 4WD ABY		Tie Rod End	S070018
	1993.07-1995.07	Front Axle Left & Right	Estate 4WD ABY		Rod/Strut,stabiliser	S050027
	1993.07-1995.07	Rear Axle Left	Estate 4WD ABY		Rod/Strut,stabiliser	S050030



	 YEAR	FITTING POSITION	BODY STYLE & DRIVE TYPE & ENGINE	REMARKS	PRODUCT	GSP Ref.
AUDI						
80 Quattro						
2.2 (169 kw)	1993.07-1995.07	Rear Axle Right	Estate 4WD ABY		Rod/Strut, stabiliser	S050031
	1993.07-1995.07	Front Axle	Estate 4WD ABY		Stabiliser Bushing	510167
	1993.07-1995.07	Front Axle	Estate 4WD ABY		Steering Rack Bellow Kit	540245S
2.6 (110 kw)	1992.08-1995.07	Front Axle Left Lower	Estate 4WD ABC		Track Control Arm	S060336
	1992.08-1995.07	Front Axle Right Lower	Estate 4WD ABC		Track Control Arm	S060781
	1992.08-1995.07	Front Axle Left Lower	Estate 4WD ABC		Ball Joint	S080008
	1992.08-1995.07	Front Axle Right Lower	Estate 4WD ABC		Ball Joint	S080009
	1992.08-1995.07	Front Axle Left & Right Lower	Estate 4WD ABC		Control Arm Bushing	510169
	1992.08-1995.07	Front Axle Left & Right Lower	Estate 4WD ABC		Control Arm Bushing	510217
	1992.08-1995.07	Front Axle Left & Right Lower	Estate 4WD ABC	Quantity:4, To Chassis:8CR125000	Control Arm Bushing	510253
	1992.08-1995.07	Rear Axle Left & Right Lower	Estate 4WD ABC		Control Arm Bushing	517142
	1992.08-1995.07	Rear Axle Left & Right Lower	Estate 4WD ABC		Control Arm Bushing	530207
	1992.08-1995.07	Front Axle Left	Estate 4WD ABC		Rod Assembly	S100012
	1992.08-1995.07	Front Axle Left & Right	Estate 4WD ABC		Tie Rod End	S070018
	1992.08-1995.07	Front Axle Left & Right	Estate 4WD ABC		Rod/Strut, stabiliser	S050027
	1992.08-1995.07	Rear Axle Left	Estate 4WD ABC		Rod/Strut, stabiliser	S050030
	1992.08-1995.07	Rear Axle Right	Estate 4WD ABC		Rod/Strut, stabiliser	S050031
	1992.08-1995.07	Front Axle	Estate 4WD ABC		Stabiliser Bushing	510167
	1992.08-1995.07	Front Axle	Estate 4WD ABC		Stabiliser Bushing	512278
	1992.08-1995.07	Front Axle	Estate 4WD ABC		Steering Rack Bellow Kit	540245S
2.8 (128 kw)	1992.08-1995.05	Front Axle Left Lower	Estate 4WD AAH		Track Control Arm	S060336
	1992.08-1995.05	Front Axle Left Upper Inner	Estate 4WD AAH		Track Control Arm	S060021
	1992.08-1995.05	Front Axle Right Lower	Estate 4WD AAH		Track Control Arm	S060781
	1992.08-1995.05	Front Axle Left Lower	Estate 4WD AAH		Ball Joint	S080008
	1992.08-1995.05	Front Axle Right Lower	Estate 4WD AAH		Ball Joint	S080009
	1992.08-1995.05	Front Axle Left & Right Lower	Estate 4WD AAH		Control Arm Bushing	510169
	1992.08-1995.05	Front Axle Left & Right Lower	Estate 4WD AAH		Control Arm Bushing	510217
	1992.08-1995.05	Front Axle Left & Right Lower	Estate 4WD AAH		Control Arm Bushing	510253
	1992.08-1995.05	Rear Axle Left & Right Lower	Estate 4WD AAH		Control Arm Bushing	517142
	1992.08-1995.05	Rear Axle Left & Right Lower	Estate 4WD AAH		Control Arm Bushing	530207
	1992.08-1995.05	Front Axle Left	Estate 4WD AAH		Rod Assembly	S100012
	1992.08-1995.05	Front Axle Left & Right	Estate 4WD AAH		Tie Rod End	S070018
	1992.08-1995.05	Front Axle Left & Right	Estate 4WD AAH		Rod/Strut, stabiliser	S050027
	1992.08-1995.05	Rear Axle Left	Estate 4WD AAH		Rod/Strut, stabiliser	S050030
	1992.08-1995.05	Rear Axle Right	Estate 4WD AAH		Rod/Strut, stabiliser	S050031
	1992.08-1995.05	Front Axle	Estate 4WD AAH		Stabiliser Bushing	510167
	1992.08-1995.05	Front Axle	Estate 4WD AAH		Stabiliser Bushing	512278
	1992.08-1995.05	Front Axle	Estate 4WD AAH		Steering Rack Bellow Kit	540245S
80 RS2 Quattro						
2.2 (232 kw)	1994.03-1995.07	Front Axle Left Lower	Estate 4WD ADU		Track Control Arm	S060336
	1994.03-1995.07	Front Axle Right Lower	Estate 4WD ADU		Track Control Arm	S060781
	1994.03-1995.07	Front Axle Left Lower	Estate 4WD ADU		Ball Joint	S080008
	1994.03-1995.07	Front Axle Right Lower	Estate 4WD ADU		Ball Joint	S080009
	1994.03-1995.07	Front Axle Left & Right Lower	Estate 4WD ADU		Control Arm Bushing	510169
	1994.03-1995.07	Rear Axle Left & Right Lower	Estate 4WD ADU	Quantity:4	Control Arm Bushing	517142
	1994.03-1995.07	Rear Axle Left & Right Lower	Estate 4WD ADU	Quantity:2	Control Arm Bushing	530207
	1994.03-1995.07	Front Axle Left	Estate 4WD ADU		Rod Assembly	S100012
	1994.03-1995.07	Front Axle Left & Right	Estate 4WD ADU		Tie Rod End	S070018
	1994.03-1995.07	Front Axle Left & Right	Estate 4WD ADU		Rod/Strut, stabiliser	S050027
	1994.03-1995.07	Rear Axle Left	Estate 4WD ADU		Rod/Strut, stabiliser	S050030
	1994.03-1995.07	Rear Axle Right	Estate 4WD ADU		Rod/Strut, stabiliser	S050031
	1994.03-1995.07	Front Axle	Estate 4WD ADU		Stabiliser Bushing	510167
	1994.03-1995.07	Front Axle	Estate 4WD ADU		Steering Rack Bellow Kit	540245S
A1						
1.4 (90 kw)	2010.05-2015.04	Front Axle Left Lower	Hatchback FWD CAXA/CNVA		Track Control Arm	S060350
	2010.05-2015.04	Front Axle Right Lower	Hatchback FWD CAXA/CNVA		Track Control Arm	S060351
	2010.05-2015.04	Front Axle Left Lower	Hatchback FWD CAXA/CNVA		Ball Joint	S080015
	2010.05-2015.04	Front Axle Right Lower	Hatchback FWD CAXA/CNVA		Ball Joint	S080014
	2010.05-2015.04	Front Axle Left & Right Lower	Hatchback FWD CAXA/CNVA		Control Arm Bushing	510065
	2010.05-2015.04	Front Axle Left & Right Lower	Hatchback FWD CAXA/CNVA		Control Arm Bushing	510084
	2010.05-2015.04	Front Axle Left & Right Lower	Hatchback FWD CAXA/CNVA		Control Arm Bushing	518115
	2010.05-2015.04	Front Axle Left & Right	Hatchback FWD CAXA/CNVA		Tie Rod Axle Joint	S030658
	2010.05-2015.04	Front Axle Left	Hatchback FWD CAXA/CNVA		Tie Rod End	S070014
	2010.05-2015.04	Front Axle Right	Hatchback FWD CAXA/CNVA		Tie Rod End	S070015



	 YEAR	FITTING POSITION	BODY STYLE & DRIVE TYPE & ENGINE	REMARKS	PRODUCT	GSP Ref.
AUDI A1						
1.4 (90 kw)	2010.05-2015.04	Front Axle Left & Right	Hatchback FWD CAXA/CNVA		Rod/Strut,stabiliser	S050038
	2010.05-2015.04	Front Axle	Hatchback FWD CAXA/CNVA		Stabiliser Bushing	517168
	2010.05-2015.04	Front Axle	Hatchback FWD CAXA/CNVA	for vehicles with electro-hydraulic steering	Steering Boot	540203
	2010.05-2015.04	Front Axle	Hatchback FWD CAXA/CNVA	for vehicles with electro-hydraulic steering	Steering Rack Bellow Kit	540203S
1.4 (136 kw)	2011.01-2015.04	Front Axle Left Lower	Hatchback FWD CAVG/CTHG		Track Control Arm	S060350
	2011.01-2015.04	Front Axle Right Lower	Hatchback FWD CAVG/CTHG		Track Control Arm	S060351
	2011.01-2015.04	Front Axle Left Lower	Hatchback FWD CAVG/CTHG		Ball Joint	S080015
	2011.01-2015.04	Front Axle Right Lower	Hatchback FWD CAVG/CTHG		Ball Joint	S080014
	2011.01-2015.04	Front Axle Left & Right Lower	Hatchback FWD CAVG/CTHG		Control Arm Bushing	510065
	2011.01-2015.04	Front Axle Left & Right Lower	Hatchback FWD CAVG/CTHG		Control Arm Bushing	510084
	2011.01-2015.04	Front Axle Left & Right Lower	Hatchback FWD CAVG/CTHG		Control Arm Bushing	518115
	2011.01-2015.04	Front Axle Left & Right	Hatchback FWD CAVG/CTHG		Tie Rod Axle Joint	S030658
	2011.01-2015.04	Front Axle Left	Hatchback FWD CAVG/CTHG		Tie Rod End	S070014
	2011.01-2015.04	Front Axle Right	Hatchback FWD CAVG/CTHG		Tie Rod End	S070015
	2011.01-2015.04	Front Axle Left & Right	Hatchback FWD CAVG/CTHG		Rod/Strut,stabiliser	S050038
	2011.01-2015.04	Front Axle	Hatchback FWD CAVG/CTHG		Stabiliser Bushing	517168
	2011.01-2015.04	Front Axle	Hatchback FWD CAVG/CTHG	VIN: until 8X-EB200000	Steering Boot	540203
	2011.01-2015.04	Front Axle	Hatchback FWD CAVG/CTHG	VIN to:8X-EB200000	Steering Rack Bellow Kit	540203S
A1 Quattro						
2.0 (188 kw)	2012.03-2012.11	Rear Axle Left Centre	Hatchback 4WD CDLH		Track Control Arm	S061407
	2012.03-2012.11	Rear Axle Right Centre	Hatchback 4WD CDLH		Track Control Arm	S061408
	2012.03-2012.11	Rear Axle Left & Right Lower Outer	Hatchback 4WD CDLH		Track Control Arm	S061468
	2012.03-2012.11	Front Axle Left Lower	Hatchback 4WD CDLH		Ball Joint	S080015
	2012.03-2012.11	Front Axle Right Lower	Hatchback 4WD CDLH		Ball Joint	S080014
	2012.03-2012.11	Front Axle Left & Right Lower	Hatchback 4WD CDLH		Control Arm Bushing	510084
	2012.03-2012.11	Front Axle Left & Right Lower	Hatchback 4WD CDLH		Control Arm Bushing	518115
	2012.03-2012.11	Rear Axle Left & Right Upper	Hatchback 4WD CDLH		Control Arm Bushing	516372
	2012.03-2012.11	Rear Axle Left & Right Upper	Hatchback 4WD CDLH		Control Arm Bushing	516408
	2012.03-2012.11	Rear Axle Left & Right Lower Inner	Hatchback 4WD CDLH		Control Arm Bushing	510352
	2012.03-2012.11	Rear Axle Left & Right Lower Outer	Hatchback 4WD CDLH		Control Arm Bushing	516370
	2012.03-2012.11	Front Axle Left & Right	Hatchback 4WD CDLH		Tie Rod Axle Joint	S030658
	2012.03-2012.11	Front Axle Left	Hatchback 4WD CDLH		Tie Rod End	S070014
	2012.03-2012.11	Front Axle Right	Hatchback 4WD CDLH		Tie Rod End	S070015
	2012.03-2012.11	Front Axle Left & Right	Hatchback 4WD CDLH		Rod/Strut,stabiliser	S050038
	2012.03-2012.11	Rear Axle Left & Right	Hatchback 4WD CDLH		Rod/Strut,stabiliser	S050035
	2012.03-2012.11	Front Axle	Hatchback 4WD CDLH	for vehicles with electro-hydraulic steering	Steering Boot	540203
	2012.03-2012.11	Front Axle	Hatchback 4WD CDLH	for vehicles with electro-hydraulic steering	Steering Rack Bellow Kit	540203S
	A1 Sportback					
1.4 (92 kw)	2014.11-2018.10	Front Axle Left Lower	Hatchback FWD CZCA/CZDD		Track Control Arm	S060350
	2014.11-2018.10	Front Axle Right Lower	Hatchback FWD CZCA/CZDD		Track Control Arm	S060351
	2014.11-2018.10	Front Axle Left Lower	Hatchback FWD CZCA/CZDD		Ball Joint	S080015
	2014.11-2018.10	Front Axle Right Lower	Hatchback FWD CZCA/CZDD		Ball Joint	S080014
	2014.11-2018.10	Front Axle Left & Right Lower	Hatchback FWD CZCA/CZDD		Control Arm Bushing	510065
	2014.11-2018.10	Front Axle Left & Right Lower	Hatchback FWD CZCA/CZDD		Control Arm Bushing	510084
	2014.11-2018.10	Front Axle Left & Right	Hatchback FWD CZCA/CZDD		Tie Rod Axle Joint	S030658
	2014.11-2018.10	Front Axle Left & Right	Hatchback FWD CZCA/CZDD		Tie Rod Axle Joint	S030713
	2014.11-2018.10	Front Axle Left	Hatchback FWD CZCA/CZDD		Tie Rod End	S070014
	2014.11-2018.10	Front Axle Right	Hatchback FWD CZCA/CZDD		Tie Rod End	S070015
	2014.11-2018.10	Front Axle Left & Right	Hatchback FWD CZCA/CZDD		Rod/Strut,stabiliser	S050038
	2014.11-2018.10	Front Axle	Hatchback FWD CZCA/CZDD		Stabiliser Bushing	517168
	2014.11-2018.10	Front Axle	Hatchback FWD CZCA/CZDD		Stabiliser Bushing	517169
	2014.11-2018.10	Front Axle	Hatchback FWD CZCA/CZDD		Steering Boot	540203
2014.11-2018.10	Front Axle	Hatchback FWD CZCA/CZDD	Equipment Vari.:HYDRO PS.Date to:2015.04	Steering Rack Bellow Kit	540203S	
1.4 (136 kw)	2011.11-2015.04	Front Axle Left Lower	Hatchback FWD CAVG/CTHG		Track Control Arm	S060350
	2011.11-2015.04	Front Axle Right Lower	Hatchback FWD CAVG/CTHG		Track Control Arm	S060351
	2011.11-2015.04	Front Axle Left Lower	Hatchback FWD CAVG/CTHG		Ball Joint	S080015
	2011.11-2015.04	Front Axle Right Lower	Hatchback FWD CAVG/CTHG		Ball Joint	S080014
	2011.11-2015.04	Front Axle Left & Right Lower	Hatchback FWD CAVG/CTHG		Control Arm Bushing	510065
	2011.11-2015.04	Front Axle Left & Right Lower	Hatchback FWD CAVG/CTHG		Control Arm Bushing	510084
	2011.11-2015.04	Front Axle Left & Right Lower	Hatchback FWD CAVG/CTHG		Control Arm Bushing	518115
	2011.11-2015.04	Front Axle Left & Right	Hatchback FWD CAVG/CTHG		Tie Rod Axle Joint	S030658
	2011.11-2015.04	Front Axle Left & Right	Hatchback FWD CAVG/CTHG		Tie Rod Axle Joint	S030713
	2011.11-2015.04	Front Axle Left	Hatchback FWD CAVG/CTHG		Tie Rod End	S070014
	2011.11-2015.04	Front Axle Right	Hatchback FWD CAVG/CTHG		Tie Rod End	S070015



	 YEAR	FITTING POSITION	BODY STYLE & DRIVE TYPE & ENGINE	REMARKS	PRODUCT	GSP Ref.
AUDI						
A1 Sportback						
1.4 (136 kw)	2011.11-2015.04	Front Axle Left & Right	Hatchback FWD CAVG/CTHG		Rod/Strut,stabiliser	S050038
	2011.11-2015.04	Front Axle	Hatchback FWD CAVG/CTHG		Stabiliser Bushing	517168
	2011.11-2015.04	Front Axle	Hatchback FWD CAVG/CTHG		Stabiliser Bushing	517169
	2011.11-2015.04	Front Axle	Hatchback FWD CAVG/CTHG	for vehicles with electro-hydraulic steering.Date to:2014	Steering Boot	540203
	2011.11-2015.04	Front Axle	Hatchback FWD CAVG/CTHG	for vehicles with electro-hydraulic steering.Date to:2014	Steering Rack Bellow Kit	540203S
1.8 (141 kw)	2015.02-2018.10	Front Axle Left Lower	Hatchback FWD DAJB		Track Control Arm	S060350
	2015.02-2018.10	Front Axle Right Lower	Hatchback FWD DAJB		Track Control Arm	S060351
	2015.02-2018.10	Front Axle Left Lower	Hatchback FWD DAJB		Ball Joint	S080015
	2015.02-2018.10	Front Axle Right Lower	Hatchback FWD DAJB		Ball Joint	S080014
	2015.02-2018.10	Front Axle Left & Right Lower	Hatchback FWD DAJB		Control Arm Bushing	510065
	2015.02-2018.10	Front Axle Left & Right Lower	Hatchback FWD DAJB		Control Arm Bushing	510084
	2015.02-2018.10	Front Axle Left & Right	Hatchback FWD DAJB		Tie Rod Axle Joint	S030658
	2015.02-2018.10	Front Axle Left & Right	Hatchback FWD DAJB		Tie Rod Axle Joint	S030713
	2015.02-2018.10	Front Axle Left	Hatchback FWD DAJB		Tie Rod End	S070014
	2015.02-2018.10	Front Axle Right	Hatchback FWD DAJB		Tie Rod End	S070015
	2015.02-2018.10	Front Axle Left & Right	Hatchback FWD DAJB		Rod/Strut,stabiliser	S050038
	2015.02-2018.10	Front Axle	Hatchback FWD DAJB		Stabiliser Bushing	517168
	2015.02-2018.10	Front Axle	Hatchback FWD DAJB		Stabiliser Bushing	517169
	2015.02-2018.10	Front Axle	Hatchback FWD DAJB		Steering Boot	540203
	2015.02-2018.10	Front Axle	Hatchback FWD DAJB	Equipment Vart.,HYDRO PS.Date to:2015.04	Steering Rack Bellow Kit	540203S
A3						
1.4 (90 kw)	2013.09-2016.08	Front Axle Left Lower	Saloon FWD CXSA	Steering arm type:Control Arm,Without ball joint	Track Control Arm	S062137
	2013.09-2016.08	Front Axle Left Lower	Saloon FWD CXSA	For OE no.5QM407151A,With ball joint	Track Control Arm	S062976
	2013.09-2016.08	Front Axle Right Lower	Saloon FWD CXSA	Steering arm type:Control Arm,Without ball joint	Track Control Arm	S062134
	2013.09-2016.08	Front Axle Right Lower	Saloon FWD CXSA	With ball joint	Track Control Arm	S062977
	2013.09-2016.08	Rear Axle Left & Right Lower Inner	Saloon FWD CXSA		Track Control Arm	S062791
	2013.09-2016.08	Rear Axle Left & Right Lower Outer	Saloon FWD CXSA		Track Control Arm	S062899
	2013.09-2016.08	Front Axle Left Lower	Saloon FWD CXSA		Ball Joint	S080258
	2013.09-2016.08	Front Axle Right Lower	Saloon FWD CXSA		Ball Joint	S080259
	2013.09-2016.08	Front Axle Left & Right Lower	Saloon FWD CXSA		Control Arm Bushing	510361
	2013.09-2016.08	Front Axle Left & Right Lower	Saloon FWD CXSA		Control Arm Bushing	531431
	2013.09-2016.08	Rear Axle Left & Right Centre	Saloon FWD CXSA		Control Arm Bushing	512203
	2013.09-2016.08	Rear Axle Left & Right Lower Inner	Saloon FWD CXSA		Control Arm Bushing	535309
	2013.09-2016.08	Front Axle	Saloon FWD CXSA		Suspension Repair Kit	S990061SK
	2013.09-2016.08	Front Axle Left & Right	Saloon FWD CXSA		Tie Rod Axle Joint	S030009
	2013.09-2016.08	Front Axle Left	Saloon FWD CXSA		Tie Rod End	S070032
	2013.09-2016.08	Front Axle Right	Saloon FWD CXSA		Tie Rod End	S070033
	2013.09-2016.08	Front Axle Left & Right	Saloon FWD CXSA		Rod/Strut,stabiliser	S050040
	2013.09-2016.08	Rear Axle Left & Right	Saloon FWD CXSA		Rod/Strut,stabiliser	S051234
1.6 (74 kw)	1996.09-2006.09	Front Axle Left Lower	Hatchback FWD AEH/AKL/APF		Track Control Arm	S060339
	1996.09-2006.09	Front Axle Right Lower	Hatchback FWD AEH/AKL/APF		Track Control Arm	S060340
	1996.09-2006.09	Front Axle Left & Right Lower	Hatchback FWD AEH/AKL/APF		Track Control Arm	S061643
	1996.09-2006.09	Front Axle Left Lower	Hatchback FWD AEH/AKL/APF		Ball Joint	S080016
	1996.09-2006.09	Front Axle Right Lower	Hatchback FWD AEH/AKL/APF		Ball Joint	S080017
	1996.09-2006.09	Front Axle Left & Right Lower	Hatchback FWD AEH/AKL/APF		Control Arm Bushing	510065
	1996.09-2006.09	Front Axle Left & Right Lower	Hatchback FWD AEH/AKL/APF		Control Arm Bushing	510084
	1996.09-2006.09	Front Axle	Hatchback FWD AEH/AKL/APF		Suspension Repair Kit	S990016SK
	1996.09-2006.09	Front Axle Left	Hatchback FWD AEH/AKL/APF	Engine code:APF,Engine code:AKL,AEH,Chassis no:from:8L-W-050 422	Rod Assembly	S100011
	1996.09-2006.09	Front Axle Left	Hatchback FWD AEH/AKL/APF	Engine code:AKL,AEH,Chassis no:to:8L-W-050 421	Rod Assembly	S100015
	1996.09-2006.09	Front Axle Right	Hatchback FWD AEH/AKL/APF	Engine code:APF,Engine code:AKL,AEH,Chassis no:from:8L-W-050 422	Rod Assembly	S100010
	1996.09-2006.09	Front Axle Right	Hatchback FWD AEH/AKL/APF	Engine code:AKL,AEH,Chassis no:to:8L-W-050 421	Rod Assembly	S100016
	1996.09-2006.09	Front Axle Left & Right	Hatchback FWD AEH/AKL/APF		Tie Rod Axle Joint	S030011
	1996.09-2006.09	Front Axle Left	Hatchback FWD AEH/AKL/APF	Engine code:AKL,AEH,Chassis no:to:8L-W-050 421	Tie Rod End	S070039
	1996.09-2006.09	Front Axle Left	Hatchback FWD AEH/AKL/APF	Engine code:APF,Engine code:AKL,AEH,Chassis no:from:8L-W-050 422	Tie Rod End	S071340
	1996.09-2006.09	Front Axle Right	Hatchback FWD AEH/AKL/APF	Engine code:AKL,AEH,Chassis no:to:8L-W-050 422	Tie Rod End	S070040
	1996.09-2006.09	Front Axle Right	Hatchback FWD AEH/AKL/APF	Engine code:APF,Engine code:AKL,AEH,Chassis no:from:8L-W-050 422	Tie Rod End	S071341
	1996.09-2006.09	Front Axle Left & Right	Hatchback FWD AEH/AKL/APF	Chassis no:from:8L-1-000 001	Rod/Strut,stabiliser	510067
	1996.09-2006.09	Front Axle Left & Right	Hatchback FWD AEH/AKL/APF		Rod/Strut,stabiliser	510067S
	1996.09-2006.09	Front Axle Left & Right	Hatchback FWD AEH/AKL/APF		Rod/Strut,stabiliser	510068
	1996.09-2006.09	Front Axle Left & Right	Hatchback FWD AEH/AKL/APF		Rod/Strut,stabiliser	510068S
	1996.09-2006.09	Front Axle	Hatchback FWD AEH/AKL/APF	Engine Code:AKL,AEH	Stabiliser Bushing	510316
	1996.09-2006.09	Front Axle	Hatchback FWD AEH/AKL/APF	for PR no.:0AG	Stabiliser Bushing	517166
	1996.09-2006.09	Front Axle	Hatchback FWD AEH/AKL/APF		Steering Boot	540227



	 YEAR	FITTING POSITION	BODY STYLE & DRIVE TYPE & ENGINE	REMARKS	PRODUCT	GSP Ref.
AUDI A3						
1.6 (75 kw)	2003.06-2012.08	Front Axle Left Lower	Hatchback FWD BGU/BSE/BSF/CCSA		Track Control Arm	S060342
	2003.06-2012.08	Front Axle Left Lower	Hatchback FWD BGU/BSE/BSF/CCSA	Engine code BGU, not For PR no.:1A0U/A2/2U/A2U/B	Track Control Arm	S060344
	2003.06-2012.08	Front Axle Left Lower	Hatchback FWD BGU/BSE/BSF/CCSA	Engine code BSE/Chassis no.from:0F/A411/01/0F/0B00/01/01/0F/PR no.:1A0U/A2	Track Control Arm	S062032
	2003.06-2012.08	Front Axle Left Lower	Hatchback FWD BGU/BSE/BSF/CCSA		Track Control Arm	S063005
	2003.06-2012.08	Front Axle Right Lower	Hatchback FWD BGU/BSE/BSF/CCSA		Track Control Arm	S060341
	2003.06-2012.08	Front Axle Right Lower	Hatchback FWD BGU/BSE/BSF/CCSA	Engine code BGU, not For PR no.:1A0U/A2/2U/A2U/B	Track Control Arm	S060343
	2003.06-2012.08	Front Axle Right Lower	Hatchback FWD BGU/BSE/BSF/CCSA		Track Control Arm	S062033
	2003.06-2012.08	Front Axle Right Lower	Hatchback FWD BGU/BSE/BSF/CCSA		Track Control Arm	S063006
	2003.06-2012.08	Rear Axle Left Centre	Hatchback FWD BGU/BSE/BSF/CCSA		Track Control Arm	S061407
	2003.06-2012.08	Rear Axle Left Lower Inner	Hatchback FWD BGU/BSE/BSF/CCSA		Track Control Arm	510349
	2003.06-2012.08	Rear Axle Right Centre	Hatchback FWD BGU/BSE/BSF/CCSA		Track Control Arm	S061408
	2003.06-2012.08	Rear Axle Right Lower Inner	Hatchback FWD BGU/BSE/BSF/CCSA		Track Control Arm	510350
	2003.06-2012.08	Rear Axle Left & Right Lower Outer	Hatchback FWD BGU/BSE/BSF/CCSA		Track Control Arm	S061468
	2003.06-2012.08	Front Axle Left Lower	Hatchback FWD BGU/BSE/BSF/CCSA		Ball Joint	S080013
	2003.06-2012.08	Front Axle Right Lower	Hatchback FWD BGU/BSE/BSF/CCSA		Ball Joint	S080012
	2003.06-2012.08	Front Axle Left Lower	Hatchback FWD BGU/BSE/BSF/CCSA		Control Arm Bushing	510333
	2003.06-2012.08	Front Axle Left Lower	Hatchback FWD BGU/BSE/BSF/CCSA		Control Arm Bushing	510354
	2003.06-2012.08	Front Axle Right Lower	Hatchback FWD BGU/BSE/BSF/CCSA		Control Arm Bushing	510334
	2003.06-2012.08	Front Axle Right Lower	Hatchback FWD BGU/BSE/BSF/CCSA		Control Arm Bushing	510355
	2003.06-2012.08	Front Axle Left & Right Lower	Hatchback FWD BGU/BSE/BSF/CCSA	Engine Code BSE/Chassis no.from:0F/A411/01/0F/0B00/01/01/0F/PR no.:1A0U/A2	Control Arm Bushing	510332
	2003.06-2012.08	Front Axle Left & Right Lower	Hatchback FWD BGU/BSE/BSF/CCSA	Engine Code BSE/Chassis no.from:0F/A411/01/0F/0B00/01/01/0F/PR no.:1A0U/A2	Control Arm Bushing	510353
	2003.06-2012.08	Front Axle Left & Right Lower	Hatchback FWD BGU/BSE/BSF/CCSA		Control Arm Bushing	510361
	2003.06-2012.08	Rear Axle Left & Right Upper	Hatchback FWD BGU/BSE/BSF/CCSA		Control Arm Bushing	516372
	2003.06-2012.08	Rear Axle Left & Right Upper	Hatchback FWD BGU/BSE/BSF/CCSA		Control Arm Bushing	516408
	2003.06-2012.08	Rear Axle Left & Right Lower Inner	Hatchback FWD BGU/BSE/BSF/CCSA		Control Arm Bushing	510351
	2003.06-2012.08	Rear Axle Left & Right Lower Inner	Hatchback FWD BGU/BSE/BSF/CCSA		Control Arm Bushing	510352
	2003.06-2012.08	Rear Axle Left & Right Lower Outer	Hatchback FWD BGU/BSE/BSF/CCSA		Control Arm Bushing	516370
	2003.06-2012.08	Rear Axle	Hatchback FWD BGU/BSE/BSF/CCSA		Suspension Repair Kit	S990019SK
	2003.06-2012.08	Front Axle Left & Right	Hatchback FWD BGU/BSE/BSF/CCSA		Tie Rod Axle Joint	S030009
	2003.06-2012.08	Front Axle Left	Hatchback FWD BGU/BSE/BSF/CCSA		Tie Rod End	S070032
	2003.06-2012.08	Front Axle Right	Hatchback FWD BGU/BSE/BSF/CCSA		Tie Rod End	S070033
	2003.06-2012.08	Front Axle Left & Right	Hatchback FWD BGU/BSE/BSF/CCSA		Rod/Strut, stabiliser	S050040
	2003.06-2012.08	Rear Axle Left & Right	Hatchback FWD BGU/BSE/BSF/CCSA		Rod/Strut, stabiliser	S050035
	2003.06-2012.08	Front Axle	Hatchback FWD BGU/BSE/BSF/CCSA		Stabiliser Bushing	535187K
	2003.06-2012.08	Rear Axle	Hatchback FWD BGU/BSE/BSF/CCSA	for PR no.:0BE	Stabiliser Bushing	516447
	2003.06-2012.08	Rear Axle	Hatchback FWD BGU/BSE/BSF/CCSA		Stabiliser Bushing	530199
1.8 (92 kw)	1996.09-2006.09	Front Axle Left Lower	Hatchback FWD AGN/APG		Track Control Arm	S060339
	1996.09-2006.09	Front Axle Right Lower	Hatchback FWD AGN/APG		Track Control Arm	S060340
	1996.09-2006.09	Front Axle Left & Right Lower	Hatchback FWD AGN/APG		Track Control Arm	S061643
	1996.09-2006.09	Front Axle Left Lower	Hatchback FWD AGN/APG		Ball Joint	S080016
	1996.09-2006.09	Front Axle Right Lower	Hatchback FWD AGN/APG		Ball Joint	S080017
	1996.09-2006.09	Front Axle Left & Right Lower	Hatchback FWD AGN/APG		Control Arm Bushing	510065
	1996.09-2006.09	Front Axle Left & Right Lower	Hatchback FWD AGN/APG		Control Arm Bushing	510084
	1996.09-2006.09	Front Axle	Hatchback FWD AGN/APG		Suspension Repair Kit	S990016SK
	1996.09-2006.09	Front Axle Left	Hatchback FWD AGN/APG	Engine code APG, Engine code AGN, Chassis no.from:BL-W-050 422	Rod Assembly	S100011
	1996.09-2006.09	Front Axle Left	Hatchback FWD AGN/APG	Engine code AGU, Chassis no.to:BL-W-050 421	Rod Assembly	S100015
	1996.09-2006.09	Front Axle Right	Hatchback FWD AGN/APG	Engine code APG, Engine code AGN, Chassis no.from:BL-W-050 422	Rod Assembly	S100010
	1996.09-2006.09	Front Axle Right	Hatchback FWD AGN/APG	Engine code AGN, Chassis no.to:BL-W-050 421	Rod Assembly	S100016
	1996.09-2006.09	Front Axle Left & Right	Hatchback FWD AGN/APG		Tie Rod Axle Joint	S030011
	1996.09-2006.09	Front Axle Left	Hatchback FWD AGN/APG	Engine code AGN, Chassis no.to:BL-W-050 421	Tie Rod End	S070039
	1996.09-2006.09	Front Axle Left	Hatchback FWD AGN/APG	Engine code APG, Engine code AGN, Chassis no.from:BL-W-050 422	Tie Rod End	S071340
	1996.09-2006.09	Front Axle Right	Hatchback FWD AGN/APG	Engine code AGN, Chassis no.to:BL-W-050 422	Tie Rod End	S070040
	1996.09-2006.09	Front Axle Right	Hatchback FWD AGN/APG	Engine code APG, Engine code AGN, Chassis no.from:BL-W-050 422	Tie Rod End	S071341
	1996.09-2006.09	Front Axle Left & Right	Hatchback FWD AGN/APG	Chassis no.from:BL-1-000 001	Rod/Strut, stabiliser	510067
	1996.09-2006.09	Front Axle Left & Right	Hatchback FWD AGN/APG		Rod/Strut, stabiliser	510067S
	1996.09-2006.09	Front Axle Left & Right	Hatchback FWD AGN/APG		Rod/Strut, stabiliser	510068
	1996.09-2006.09	Front Axle Left & Right	Hatchback FWD AGN/APG		Rod/Strut, stabiliser	510068S
	1996.09-2006.09	Front Axle	Hatchback FWD AGN/APG		Stabiliser Bushing	510316
	1996.09-2006.09	Front Axle	Hatchback FWD AGN/APG	for PR no.:0AG	Stabiliser Bushing	517166
	1996.09-2006.09	Front Axle	Hatchback FWD AGN/APG		Steering Boot	540227
1.8 (110 kw)	1996.09-2006.09	Front Axle Left Lower	Hatchback FWD AGU/AQA/ARZ/AUM		Track Control Arm	S060339
	1996.09-2006.09	Front Axle Right Lower	Hatchback FWD AGU/AQA/ARZ/AUM		Track Control Arm	S060340
	1996.09-2006.09	Front Axle Left & Right Lower	Hatchback FWD AGU/AQA/ARZ/AUM		Track Control Arm	S061643
	1996.09-2006.09	Front Axle Left Lower	Hatchback FWD AGU/AQA/ARZ/AUM		Ball Joint	S080016



	 YEAR	FITTING POSITION	BODY STYLE & DRIVE TYPE & ENGINE	REMARKS	PRODUCT	GSP Ref.
AUDI A3						
1.8 (110 kw)	1996.09-2006.09	Front Axle Right Lower	Hatchback FWD AGU/AQA/ARZ/AUM		Ball Joint	S080017
	1996.09-2006.09	Front Axle Left & Right Lower	Hatchback FWD AGU/AQA/ARZ/AUM		Control Arm Bushing	510065
	1996.09-2006.09	Front Axle Left & Right Lower	Hatchback FWD AGU/AQA/ARZ/AUM		Control Arm Bushing	510084
	1996.09-2006.09	Front Axle Left	Hatchback FWD AGU/AQA/ARZ/AUM	Engine code:AGA-AJM-ARZ;Engine code:AGU;Chassis no from:8L-W-050 422	Rod Assembly	S100011
	1996.09-2006.09	Front Axle Left	Hatchback FWD AGU/AQA/ARZ/AUM	Engine code:AGU;Chassis no.10L:8L-W-050 421	Rod Assembly	S100015
	1996.09-2006.09	Front Axle Right	Hatchback FWD AGU/AQA/ARZ/AUM	Engine code:AGA-AJM-ARZ;Engine code:AGU;Chassis no from:8L-W-050 422	Rod Assembly	S100010
	1996.09-2006.09	Front Axle Right	Hatchback FWD AGU/AQA/ARZ/AUM	Engine code:AGU;Chassis no.10L:8L-W-050 421	Rod Assembly	S100016
	1996.09-2006.09	Front Axle Left & Right	Hatchback FWD AGU/AQA/ARZ/AUM		Tie Rod Axle Joint	S030011
	1996.09-2006.09	Front Axle Left	Hatchback FWD AGU/AQA/ARZ/AUM	Engine code:AGU;Chassis no.10L:8L-W-050 421	Tie Rod End	S070039
	1996.09-2006.09	Front Axle Left	Hatchback FWD AGU/AQA/ARZ/AUM	Engine code:AGA-AJM-ARZ;Engine code:AGU;Chassis no from:8L-W-050 422	Tie Rod End	S071340
	1996.09-2006.09	Front Axle Right	Hatchback FWD AGU/AQA/ARZ/AUM	Engine code:AGU;Chassis no.10L:8L-W-050 422	Tie Rod End	S070040
	1996.09-2006.09	Front Axle Right	Hatchback FWD AGU/AQA/ARZ/AUM	Engine code:AGA-AJM-ARZ;Engine code:AGU;Chassis no from:8L-W-050 422	Tie Rod End	S071341
	1996.09-2006.09	Front Axle Left & Right	Hatchback FWD AGU/AQA/ARZ/AUM	Chassis no.from:8L-1-000 001	Rod/Strut,stabiliser	510067
	1996.09-2006.09	Front Axle Left & Right	Hatchback FWD AGU/AQA/ARZ/AUM		Rod/Strut,stabiliser	510067S
	1996.09-2006.09	Front Axle Left & Right	Hatchback FWD AGU/AQA/ARZ/AUM		Rod/Strut,stabiliser	510068
	1996.09-2006.09	Front Axle Left & Right	Hatchback FWD AGU/AQA/ARZ/AUM		Rod/Strut,stabiliser	510068S
	1996.09-2006.09	Front Axle	Hatchback FWD AGU/AQA/ARZ/AUM	Engine Code:AGU,AUM	Stabiliser Bushing	510316
	1996.09-2006.09	Front Axle	Hatchback FWD AGU/AQA/ARZ/AUM	for PR no.:OAG	Stabiliser Bushing	517166
	1996.09-2006.09	Front Axle	Hatchback FWD AGU/AQA/ARZ/AUM		Steering Boot	540227
1.8 (132 kw)	1998.11-2006.09	Front Axle Left Lower	Hatchback FWD AJQ/APP/ARY/AUQ		Track Control Arm	S060339
	1998.11-2006.09	Front Axle Right Lower	Hatchback FWD AJQ/APP/ARY/AUQ		Track Control Arm	S060340
	1998.11-2006.09	Front Axle Left & Right Lower	Hatchback FWD AJQ/APP/ARY/AUQ		Track Control Arm	S061643
	1998.11-2006.09	Front Axle Left Lower	Hatchback FWD AJQ/APP/ARY/AUQ		Ball Joint	S080016
	1998.11-2006.09	Front Axle Right Lower	Hatchback FWD AJQ/APP/ARY/AUQ		Ball Joint	S080017
	1998.11-2006.09	Front Axle Left & Right Lower	Hatchback FWD AJQ/APP/ARY/AUQ		Control Arm Bushing	510065
	1998.11-2006.09	Front Axle Left & Right Lower	Hatchback FWD AJQ/APP/ARY/AUQ		Control Arm Bushing	510084
	1998.11-2006.09	Front Axle	Hatchback FWD AJQ/APP/ARY/AUQ		Suspension Repair Kit	S990016SK
	1998.11-2006.09	Front Axle Left	Hatchback FWD AJQ/APP/ARY/AUQ		Rod Assembly	S100011
	1998.11-2006.09	Front Axle Right	Hatchback FWD AJQ/APP/ARY/AUQ		Rod Assembly	S100010
	1998.11-2006.09	Front Axle Left & Right	Hatchback FWD AJQ/APP/ARY/AUQ		Tie Rod Axle Joint	S030011
	1998.11-2006.09	Front Axle Left	Hatchback FWD AJQ/APP/ARY/AUQ		Tie Rod End	S071340
	1998.11-2006.09	Front Axle Right	Hatchback FWD AJQ/APP/ARY/AUQ		Tie Rod End	S071341
	1998.11-2006.09	Front Axle Left & Right	Hatchback FWD AJQ/APP/ARY/AUQ	Engine Code:AUQ;Chassis no from:8L-1-000 001;Engine Code:ARY	Rod/Strut,stabiliser	510067
	1998.11-2006.09	Front Axle Left & Right	Hatchback FWD AJQ/APP/ARY/AUQ		Rod/Strut,stabiliser	510067S
	1998.11-2006.09	Front Axle Left & Right	Hatchback FWD AJQ/APP/ARY/AUQ		Rod/Strut,stabiliser	510068
	1998.11-2006.09	Front Axle Left & Right	Hatchback FWD AJQ/APP/ARY/AUQ		Rod/Strut,stabiliser	510068S
	1998.11-2006.09	Front Axle	Hatchback FWD AJQ/APP/ARY/AUQ	Engine Code:AUQ	Stabiliser Bushing	510316
	1998.11-2006.09	Front Axle	Hatchback FWD AJQ/APP/ARY/AUQ	for PR no.:OAG	Stabiliser Bushing	517166
	1998.11-2006.09	Front Axle	Hatchback FWD AJQ/APP/ARY/AUQ		Steering Boot	540227
	2012.04-2016.08	Front Axle Left Lower	Hatchback FWD C.JSA	Steering arm type:Control Arm,Without ball joint	Track Control Arm	S062137
	2012.04-2016.08	Front Axle Left Lower	Hatchback FWD C.JSA	For OE no.5QM407151A,With ball joint	Track Control Arm	S062976
	2012.04-2016.08	Front Axle Right Lower	Hatchback FWD C.JSA	Steering arm type:Control Arm,Without ball joint	Track Control Arm	S062134
	2012.04-2016.08	Front Axle Right Lower	Hatchback FWD C.JSA	With ball joint	Track Control Arm	S062977
	2012.04-2016.08	Rear Axle Left & Right Lower Inner	Hatchback FWD C.JSA		Track Control Arm	S062791
	2012.04-2016.08	Rear Axle Left & Right Lower Outer	Hatchback FWD C.JSA		Track Control Arm	S062899
	2012.04-2016.08	Front Axle Left Lower	Hatchback FWD C.JSA		Ball Joint	S080258
	2012.04-2016.08	Front Axle Right Lower	Hatchback FWD C.JSA		Ball Joint	S080259
	2012.04-2016.08	Front Axle Left & Right Lower	Hatchback FWD C.JSA		Control Arm Bushing	510361
	2012.04-2016.08	Front Axle Left & Right Lower	Hatchback FWD C.JSA		Control Arm Bushing	531431
	2012.04-2016.08	Rear Axle Left & Right Centre	Hatchback FWD C.JSA		Control Arm Bushing	512203
	2012.04-2016.08	Rear Axle Left & Right Lower Inner	Hatchback FWD C.JSA		Control Arm Bushing	535309
	2012.04-2016.08	Front Axle	Hatchback FWD C.JSA		Suspension Repair Kit	S990061SK
	2012.04-2016.08	Front Axle Left & Right	Hatchback FWD C.JSA		Tie Rod Axle Joint	S030009
	2012.04-2016.08	Front Axle Left	Hatchback FWD C.JSA		Tie Rod End	S070032
	2012.04-2016.08	Front Axle Right	Hatchback FWD C.JSA		Tie Rod End	S070033
	2012.04-2016.08	Front Axle Left & Right	Hatchback FWD C.JSA		Rod/Strut,stabiliser	S050040
	2012.04-2016.08	Rear Axle Left & Right	Hatchback FWD C.JSA		Rod/Strut,stabiliser	S051234
	2012.04-2016.08	Rear Axle	Hatchback FWD C.JSA		Stabiliser Bushing	516447
	2013.05-2016.08	Front Axle Left Lower	Saloon FWD C.JSA/C.JSB	Steering arm type:Control Arm,Without ball joint	Track Control Arm	S062137
	2013.05-2016.08	Front Axle Left Lower	Saloon FWD C.JSA/C.JSB	For OE no.5QM407151A,With ball joint	Track Control Arm	S062976
	2013.05-2016.08	Front Axle Right Lower	Saloon FWD C.JSA/C.JSB	Steering arm type:Control Arm,Without ball joint	Track Control Arm	S062134
	2013.05-2016.08	Front Axle Right Lower	Saloon FWD C.JSA/C.JSB	With ball joint	Track Control Arm	S062977
	2013.05-2016.08	Rear Axle Left & Right Lower Inner	Saloon FWD C.JSA/C.JSB		Track Control Arm	S062791
	2013.05-2016.08	Rear Axle Left & Right Lower Outer	Saloon FWD C.JSA/C.JSB		Track Control Arm	S062899



	 YEAR	FITTING POSITION	BODY STYLE & DRIVE TYPE & ENGINE	REMARKS	PRODUCT	GSP Ref.
AUDI						
A3						
1.8 (132 kw)	2013.05-2016.08	Front Axle Left Lower	Saloon FWD C.JSA/CJSB		Ball Joint	S080258
	2013.05-2016.08	Front Axle Right Lower	Saloon FWD C.JSA/CJSB		Ball Joint	S080259
	2013.05-2016.08	Front Axle Left & Right Lower	Saloon FWD C.JSA/CJSB		Control Arm Bushing	510361
	2013.05-2016.08	Front Axle Left & Right Lower	Saloon FWD C.JSA/CJSB		Control Arm Bushing	531431
	2013.05-2016.08	Rear Axle Left & Right Centre	Saloon FWD C.JSA/CJSB		Control Arm Bushing	512203
	2013.05-2016.08	Rear Axle Left & Right Lower Inner	Saloon FWD C.JSA/CJSB		Control Arm Bushing	535309
	2013.05-2016.08	Front Axle	Saloon FWD C.JSA/CJSB		Suspension Repair Kit	S990061SK
	2013.05-2016.08	Front Axle Left & Right	Saloon FWD C.JSA/CJSB		Tie Rod Axle Joint	S030009
	2013.05-2016.08	Front Axle Left	Saloon FWD C.JSA/CJSB		Tie Rod End	S070032
	2013.05-2016.08	Front Axle Right	Saloon FWD C.JSA/CJSB		Tie Rod End	S070033
	2013.05-2016.08	Front Axle Left & Right	Saloon FWD C.JSA/CJSB		Rod/Strut, stabiliser	S050040
	2013.05-2016.08	Rear Axle Left & Right	Saloon FWD C.JSA/CJSB		Rod/Strut, stabiliser	S051234
2.0 (137 kw)	2016.09-	Front Axle Left	Convertible FWD CZRA		Rod Assembly	S100435
	2016.09-	Front Axle Right	Convertible FWD CZRA		Rod Assembly	S100434
	2016.09-	Front Axle Left & Right	Convertible FWD CZRA		Rod/Strut, stabiliser	S050040
	2016.09-	Rear Axle Left & Right	Convertible FWD CZRA		Rod/Strut, stabiliser	S051234
	2016.09-	Front Axle	Convertible FWD CZRA		Steering Boot	541209
	2016.09-	Front Axle	Convertible FWD CZRA		Steering Rack Bellow Kit	541209S
2.0 (162 kw)	2015.08-2016.11	Front Axle Left Lower	Saloon FWD CHHB	Engine code:CHHB	Track Control Arm	S062137
	2015.08-2016.11	Front Axle Left Lower	Saloon FWD CHHB		Track Control Arm	S062976
	2015.08-2016.11	Front Axle Right Lower	Saloon FWD CHHB	Engine code:CHHB	Track Control Arm	S062134
	2015.08-2016.11	Front Axle Right Lower	Saloon FWD CHHB		Track Control Arm	S062977
	2015.08-2016.11	Rear Axle Left & Right Lower Inner	Saloon FWD CHHB		Track Control Arm	S062791
	2015.08-2016.11	Rear Axle Left & Right Lower Outer	Saloon FWD CHHB		Track Control Arm	S062899
	2015.08-2016.11	Front Axle Left Lower	Saloon FWD CHHB		Ball Joint	S080258
	2015.08-2016.11	Front Axle Right Lower	Saloon FWD CHHB		Ball Joint	S080259
	2015.08-2016.11	Front Axle Left & Right Lower	Saloon FWD CHHB		Control Arm Bushing	510361
	2015.08-2016.11	Front Axle Left & Right Lower	Saloon FWD CHHB		Control Arm Bushing	531431
	2015.08-2016.11	Rear Axle Left & Right Centre	Saloon FWD CHHB		Control Arm Bushing	512203
	2015.08-2016.11	Front Axle Left & Right	Saloon FWD CHHB		Tie Rod Axle Joint	S030009
	2015.08-2016.11	Front Axle Left	Saloon FWD CHHB		Tie Rod End	S070032
	2015.08-2016.11	Front Axle Right	Saloon FWD CHHB		Tie Rod End	S070033
	2015.08-2016.11	Front Axle Left & Right	Saloon FWD CHHB		Rod/Strut, stabiliser	S050040
	2015.08-2016.11	Rear Axle Left & Right	Saloon FWD CHHB		Rod/Strut, stabiliser	S051234
A3 Cabrio						
1.8 (132 kw)	2013.10-2016.07	Front Axle Left Lower	Cabriolet FWD C.JSA/CJSB	Steering arm type:Control Arm,Without ball joint	Track Control Arm	S062137
	2013.10-2016.07	Front Axle Left Lower	Cabriolet FWD C.JSA/CJSB	For OE no.5QM407151A,With ball joint	Track Control Arm	S062976
	2013.10-2016.07	Front Axle Right Lower	Cabriolet FWD C.JSA/CJSB	Steering arm type:Control Arm,Without ball joint	Track Control Arm	S062134
	2013.10-2016.07	Front Axle Right Lower	Cabriolet FWD C.JSA/CJSB	With ball joint	Track Control Arm	S062977
	2013.10-2016.07	Rear Axle Left & Right Lower Inner	Cabriolet FWD C.JSA/CJSB		Track Control Arm	S062791
	2013.10-2016.07	Rear Axle Left & Right Lower Outer	Cabriolet FWD C.JSA/CJSB		Track Control Arm	S062899
	2013.10-2016.07	Front Axle Left Lower	Cabriolet FWD C.JSA/CJSB		Ball Joint	S080258
	2013.10-2016.07	Front Axle Right Lower	Cabriolet FWD C.JSA/CJSB		Ball Joint	S080259
	2013.10-2016.07	Front Axle Left & Right Lower	Cabriolet FWD C.JSA/CJSB		Control Arm Bushing	510361
	2013.10-2016.07	Front Axle Left & Right Lower	Cabriolet FWD C.JSA/CJSB		Control Arm Bushing	531431
	2013.10-2016.07	Rear Axle Left & Right Centre	Cabriolet FWD C.JSA/CJSB		Control Arm Bushing	512203
	2013.10-2016.07	Rear Axle Left & Right Lower Inner	Cabriolet FWD C.JSA/CJSB		Control Arm Bushing	535309
	2013.10-2016.07	Front Axle	Cabriolet FWD C.JSA/CJSB		Suspension Repair Kit	S990061SK
	2013.10-2016.07	Front Axle Left & Right	Cabriolet FWD C.JSA/CJSB		Tie Rod Axle Joint	S030009
	2013.10-2016.07	Front Axle Left	Cabriolet FWD C.JSA/CJSB		Tie Rod End	S070032
	2013.10-2016.07	Front Axle Right	Cabriolet FWD C.JSA/CJSB		Tie Rod End	S070033
	2013.10-2016.07	Front Axle Left & Right	Cabriolet FWD C.JSA/CJSB		Rod/Strut, stabiliser	S050040
	2013.10-2016.07	Rear Axle Left & Right	Cabriolet FWD C.JSA/CJSB		Rod/Strut, stabiliser	S051234
2.0 (140 kw)	2016.05-2020.10	Front Axle Left Lower	Cabriolet FWD CZPB/DKZA		Track Control Arm	S062137
	2016.05-2020.10	Front Axle Left Lower	Cabriolet FWD CZPB/DKZA		Track Control Arm	S062976
	2016.05-2020.10	Front Axle Right Lower	Cabriolet FWD CZPB/DKZA		Track Control Arm	S062134
	2016.05-2020.10	Front Axle Right Lower	Cabriolet FWD CZPB/DKZA		Track Control Arm	S062977
	2016.05-2020.10	Rear Axle Left & Right Lower Inner	Cabriolet FWD CZPB/DKZA		Track Control Arm	S062791
	2016.05-2020.10	Rear Axle Left & Right Lower Outer	Cabriolet FWD CZPB/DKZA		Track Control Arm	S062899
	2016.05-2020.10	Front Axle Left Lower	Cabriolet FWD CZPB/DKZA	For PR code:1LC/1LJ/1ZA/1ZD	Ball Joint	S080258
	2016.05-2020.10	Front Axle Left Lower	Cabriolet FWD CZPB/DKZA	For PR no.:1ZA	Ball Joint	S080258
	2016.05-2020.10	Front Axle Right Lower	Cabriolet FWD CZPB/DKZA	For PR code:1LC/1LJ/1ZA/1ZD	Ball Joint	S080259
	2016.05-2020.10	Front Axle Right Lower	Cabriolet FWD CZPB/DKZA	For PR no.:1ZA	Ball Joint	S080259
	2016.05-2020.10	Front Axle Left & Right Lower	Cabriolet FWD CZPB/DKZA		Control Arm Bushing	510361



	 YEAR	FITTING POSITION	BODY STYLE & DRIVE TYPE & ENGINE	REMARKS	PRODUCT	GSP Ref.
AUDI						
A3 Cabrio						
2.0 (140 kw)	2016.05-2020.10	Front Axle Left & Right Lower	Cabriolet FWD CZPB/DKZA		Control Arm Bushing	531431
	2016.05-2020.10	Rear Axle Left & Right Centre	Cabriolet FWD CZPB/DKZA		Control Arm Bushing	512203
	2016.05-2020.10	Front Axle Left & Right	Cabriolet FWD CZPB/DKZA		Tie Rod Axle Joint	S030009
	2016.05-2020.10	Front Axle Left	Cabriolet FWD CZPB/DKZA		Tie Rod End	S070032
	2016.05-2020.10	Front Axle Right	Cabriolet FWD CZPB/DKZA		Tie Rod End	S070033
	2016.05-2020.10	Front Axle Left & Right	Cabriolet FWD CZPB/DKZA		Rod/Strut, stabiliser	S050040
	2016.05-2020.10	Rear Axle Left & Right	Cabriolet FWD CZPB/DKZA		Rod/Strut, stabiliser	S051234
A3 Sportback						
1.4 (90 kw)	2012.09-2016.08	Front Axle Left Lower	Hatchback FWD CMBA/CXSA		Track Control Arm	S062137
	2012.09-2016.08	Front Axle Left Lower	Hatchback FWD CMBA/CXSA		Track Control Arm	S062976
	2012.09-2016.08	Front Axle Right Lower	Hatchback FWD CMBA/CXSA		Track Control Arm	S062134
	2012.09-2016.08	Front Axle Right Lower	Hatchback FWD CMBA/CXSA		Track Control Arm	S062977
	2012.09-2016.08	Rear Axle Left & Right Lower Inner	Hatchback FWD CMBA/CXSA		Track Control Arm	S062791
	2012.09-2016.08	Rear Axle Left & Right Lower Outer	Hatchback FWD CMBA/CXSA		Track Control Arm	S062899
	2012.09-2016.08	Front Axle Left Lower	Hatchback FWD CMBA/CXSA		Ball Joint	S080258
	2012.09-2016.08	Front Axle Right Lower	Hatchback FWD CMBA/CXSA		Ball Joint	S080259
	2012.09-2016.08	Front Axle Left & Right Lower	Hatchback FWD CMBA/CXSA		Control Arm Bushing	510361
	2012.09-2016.08	Front Axle Left & Right Lower	Hatchback FWD CMBA/CXSA		Control Arm Bushing	531431
	2012.09-2016.08	Rear Axle Left & Right Centre	Hatchback FWD CMBA/CXSA		Control Arm Bushing	512203
	2012.09-2016.08	Rear Axle Left & Right Lower Inner	Hatchback FWD CMBA/CXSA		Control Arm Bushing	535309
	2012.09-2016.08	Front Axle	Hatchback FWD CMBA/CXSA		Suspension Repair Kit	S990061SK
	2012.09-2016.08	Front Axle Left & Right	Hatchback FWD CMBA/CXSA		Tie Rod Axle Joint	S030009
	2012.09-2016.08	Front Axle Left	Hatchback FWD CMBA/CXSA		Tie Rod End	S070032
	2012.09-2016.08	Front Axle Right	Hatchback FWD CMBA/CXSA		Tie Rod End	S070033
	2012.09-2016.08	Front Axle Left & Right	Hatchback FWD CMBA/CXSA		Rod/Strut, stabiliser	S050040
	2012.09-2016.08	Rear Axle Left & Right	Hatchback FWD CMBA/CXSA		Rod/Strut, stabiliser	S051234
1.6 (75 kw)	2004.09-2013.03	Front Axle Left Lower	Hatchback FWD BGU/BSE/BSF/CCSA		Track Control Arm	S060342
	2004.09-2013.03	Front Axle Left Lower	Hatchback FWD BGU/BSE/BSF/CCSA	Engine code:BGU,not For PR no.:UWAUUA22UAZUB	Track Control Arm	S060344
	2004.09-2013.03	Front Axle Left Lower	Hatchback FWD BGU/BSE/BSF/CCSA	Engine code:BGU,not For PR no.:UWAUUA22UAZUB	Track Control Arm	S062032
	2004.09-2013.03	Front Axle Left Lower	Hatchback FWD BGU/BSE/BSF/CCSA		Track Control Arm	S063005
	2004.09-2013.03	Front Axle Right Lower	Hatchback FWD BGU/BSE/BSF/CCSA		Track Control Arm	S060341
	2004.09-2013.03	Front Axle Right Lower	Hatchback FWD BGU/BSE/BSF/CCSA	Engine code:BGU,not For PR no.:UWAUUA22UAZUB	Track Control Arm	S060343
	2004.09-2013.03	Front Axle Right Lower	Hatchback FWD BGU/BSE/BSF/CCSA	Engine code:BGU,not For PR no.:UWAUUA22UAZUB	Track Control Arm	S062033
	2004.09-2013.03	Front Axle Right Lower	Hatchback FWD BGU/BSE/BSF/CCSA		Track Control Arm	S063006
	2004.09-2013.03	Rear Axle Left Centre	Hatchback FWD BGU/BSE/BSF/CCSA		Track Control Arm	S061407
	2004.09-2013.03	Rear Axle Left Lower Inner	Hatchback FWD BGU/BSE/BSF/CCSA		Track Control Arm	510349
	2004.09-2013.03	Rear Axle Right Centre	Hatchback FWD BGU/BSE/BSF/CCSA		Track Control Arm	S061408
	2004.09-2013.03	Rear Axle Right Lower Inner	Hatchback FWD BGU/BSE/BSF/CCSA		Track Control Arm	510350
	2004.09-2013.03	Rear Axle Left & Right Upper	Hatchback FWD BGU/BSE/BSF/CCSA		Track Control Arm	510346
	2004.09-2013.03	Rear Axle Left & Right Lower Outer	Hatchback FWD BGU/BSE/BSF/CCSA		Track Control Arm	S061468
	2004.09-2013.03	Front Axle Left Lower	Hatchback FWD BGU/BSE/BSF/CCSA		Ball Joint	S080013
	2004.09-2013.03	Front Axle Right Lower	Hatchback FWD BGU/BSE/BSF/CCSA		Ball Joint	S080012
	2004.09-2013.03	Front Axle Left Lower	Hatchback FWD BGU/BSE/BSF/CCSA		Control Arm Bushing	510333
	2004.09-2013.03	Front Axle Left Lower	Hatchback FWD BGU/BSE/BSF/CCSA		Control Arm Bushing	510354
	2004.09-2013.03	Front Axle Right Lower	Hatchback FWD BGU/BSE/BSF/CCSA		Control Arm Bushing	510334
	2004.09-2013.03	Front Axle Right Lower	Hatchback FWD BGU/BSE/BSF/CCSA		Control Arm Bushing	510355
	2004.09-2013.03	Front Axle Left & Right Lower	Hatchback FWD BGU/BSE/BSF/CCSA	Engine code:BGU,not For PR no.:UWAUUA22UAZUB	Control Arm Bushing	510353
	2004.09-2013.03	Front Axle Left & Right Lower	Hatchback FWD BGU/BSE/BSF/CCSA		Control Arm Bushing	510361
	2004.09-2013.03	Rear Axle Left & Right Upper	Hatchback FWD BGU/BSE/BSF/CCSA		Control Arm Bushing	516372
	2004.09-2013.03	Rear Axle Left & Right Upper	Hatchback FWD BGU/BSE/BSF/CCSA		Control Arm Bushing	516408
	2004.09-2013.03	Rear Axle Left & Right Lower Inner	Hatchback FWD BGU/BSE/BSF/CCSA		Control Arm Bushing	510351
	2004.09-2013.03	Rear Axle Left & Right Lower Inner	Hatchback FWD BGU/BSE/BSF/CCSA		Control Arm Bushing	510352
	2004.09-2013.03	Rear Axle Left & Right Lower Outer	Hatchback FWD BGU/BSE/BSF/CCSA		Control Arm Bushing	516370
	2004.09-2013.03	Rear Axle	Hatchback FWD BGU/BSE/BSF/CCSA		Suspension Repair Kit	S990019SK
	2004.09-2013.03	Front Axle Left & Right	Hatchback FWD BGU/BSE/BSF/CCSA		Tie Rod Axle Joint	S030009
	2004.09-2013.03	Front Axle Left	Hatchback FWD BGU/BSE/BSF/CCSA		Tie Rod End	S070032
	2004.09-2013.03	Front Axle Right	Hatchback FWD BGU/BSE/BSF/CCSA		Tie Rod End	S070033
	2004.09-2013.03	Front Axle Left & Right	Hatchback FWD BGU/BSE/BSF/CCSA		Rod/Strut, stabiliser	S050040
	2004.09-2013.03	Rear Axle Left & Right	Hatchback FWD BGU/BSE/BSF/CCSA		Rod/Strut, stabiliser	S050035
	2004.09-2013.03	Rear Axle	Hatchback FWD BGU/BSE/BSF/CCSA	for PR no.:0BE	Stabiliser Bushing	516447
	2004.09-2013.03	Rear Axle	Hatchback FWD BGU/BSE/BSF/CCSA		Stabiliser Bushing	530199
2.0 (147 kw)	2004.09-2013.03	Front Axle Left Lower	Hatchback FWD AXX/BPY/BWA/CAWB/CBFA/CCZA		Track Control Arm	S060342
	2004.09-2013.03	Front Axle Left Lower	Hatchback FWD AXX/BPY/BWA/CAWB/CBFA/CCZA		Track Control Arm	S060344
	2004.09-2013.03	Front Axle Left Lower	Hatchback FWD AXX/BPY/BWA/CAWB/CBFA/CCZA		Track Control Arm	S062032



	 YEAR	FITTING POSITION	BODY STYLE & DRIVE TYPE & ENGINE	REMARKS	PRODUCT	GSP Ref.
AUDI						
A3 Sportback Quattro						
2.0 (147 kw)	2004.06-2013.03	Front Axle Left & Right	Hatchback 4WD AXX/BPY/BWA/CCZA		Rod/Strut,stabiliser	S050040
	2004.06-2013.03	Rear Axle Left & Right	Hatchback 4WD AXX/BPY/BWA/CCZA		Rod/Strut,stabiliser	S050035
	2004.06-2013.03	Rear Axle	Hatchback 4WD AXX/BPY/BWA/CCZA	Engine code AXX,BWA,CBFA,CCZA,BPY,for PR no.:0BE	Stabiliser Bushing	516447
	2004.06-2013.03	Rear Axle	Hatchback 4WD AXX/BPY/BWA/CCZA	Engine code AXX,CCZA,BWA,for PR no.:0BC	Stabiliser Bushing	530199
A3/S3 Limousine quattro						
2.0 (162 kw)	2013.11-	Rear Axle Left & Right Lower Inner	Saloon AWD CNTC		Control Arm Bushing	535309
	2013.11-	Front Axle Left	Saloon AWD CNTC		Rod Assembly	S100435
	2013.11-	Front Axle Right	Saloon AWD CNTC		Rod Assembly	S100434
	2013.11-	Front Axle Left & Right	Saloon AWD CNTC		Rod/Strut,stabiliser	S050040
	2013.11-	Rear Axle Left & Right	Saloon AWD CNTC		Rod/Strut,stabiliser	S051234
	2013.11-	Front Axle	Saloon AWD CNTC		Steering Boot	541209
	2013.11-	Front Axle	Saloon AWD CNTC		Steering Rack Bellow Kit	541209S
A4						
1.8 (92 kw)	1994.11-2000.10	Front Axle Left Lower Inner	Saloon FWD ADR/APT/ARG/AVV		Track Control Arm	S060055
	1994.11-2000.10	Front Axle Left Upper Inner	Saloon FWD ADR/APT/ARG/AVV	Engine code APT,ADR,ARG,Chassis no. to:8D-V-152 087	Track Control Arm	S060021
	1994.11-2000.10	Front Axle Left Upper Inner	Saloon FWD ADR/APT/ARG/AVV	Chassis no. from:8D-V-152 088,for vehicles without sports suspension,not for PR no.:1W	Track Control Arm	S062331
	1994.11-2000.10	Front Axle Left Upper Outer	Saloon FWD ADR/APT/ARG/AVV		Track Control Arm	S060048
	1994.11-2000.10	Front Axle Left Upper Outer	Saloon FWD ADR/APT/ARG/AVV	for vehicles with lowered suspension,For PR no.:1BV	Track Control Arm	S060798
	1994.11-2000.10	Front Axle Left Upper Outer	Saloon FWD ADR/APT/ARG/AVV	not For PR no.:1BV	Track Control Arm	S062530
	1994.11-2000.10	Front Axle Right Lower Inner	Saloon FWD ADR/APT/ARG/AVV		Track Control Arm	S060056
	1994.11-2000.10	Front Axle Right Upper Inner	Saloon FWD ADR/APT/ARG/AVV	Engine code APT,ADR,ARG,Chassis no. to:8D-V-152 087	Track Control Arm	S060022
	1994.11-2000.10	Front Axle Right Upper Inner	Saloon FWD ADR/APT/ARG/AVV	for vehicles with sports suspension	Track Control Arm	S060801
	1994.11-2000.10	Front Axle Right Upper Inner	Saloon FWD ADR/APT/ARG/AVV	Chassis no. from:8D-V-152 088,for vehicles without sports suspension,not for PR no.:1W	Track Control Arm	S062332
	1994.11-2000.10	Front Axle Right Upper Outer	Saloon FWD ADR/APT/ARG/AVV		Track Control Arm	S060049
	1994.11-2000.10	Front Axle Right Upper Outer	Saloon FWD ADR/APT/ARG/AVV	for vehicles with lowered suspension,For PR no.:1BV	Track Control Arm	S060799
	1994.11-2000.10	Front Axle Right Upper Outer	Saloon FWD ADR/APT/ARG/AVV	not For PR no.:1BV	Track Control Arm	S062531
	1994.11-2000.10	Front Axle Left & Right Lower Outer	Saloon FWD ADR/APT/ARG/AVV		Track Control Arm	S060054
	1994.11-2000.10	Front Axle Left & Right Upper	Saloon FWD ADR/APT/ARG/AVV		Control Arm Bushing	510136
	1994.11-2000.10	Front Axle Left & Right Lower Inner	Saloon FWD ADR/APT/ARG/AVV		Control Arm Bushing	510135
	1994.11-2000.10	Front Axle Left & Right Lower Inner	Saloon FWD ADR/APT/ARG/AVV		Control Arm Bushing	510287
	1994.11-2000.10	Front Axle Left & Right Lower Outer	Saloon FWD ADR/APT/ARG/AVV		Control Arm Bushing	510133
	1994.11-2000.10	Front Axle Left & Right Lower Outer	Saloon FWD ADR/APT/ARG/AVV		Control Arm Bushing	510134
	1994.11-2000.10	Front Axle	Saloon FWD ADR/APT/ARG/AVV		Suspension Repair Kit	S990001SK
	1994.11-2000.10	Front Axle Left & Right	Saloon FWD ADR/APT/ARG/AVV		Rod Assembly	S100014
	1994.11-2000.10	Front Axle Left & Right	Saloon FWD ADR/APT/ARG/AVV	for vehicles with sports suspension,For PR no.:1BV	Tie Rod End	S070016
	1994.11-2000.10	Front Axle Left & Right	Saloon FWD ADR/APT/ARG/AVV	not For PR no.:1BV	Tie Rod End	S070038
	1994.11-2000.10	Front Axle Left	Saloon FWD ADR/APT/ARG/AVV		Rod/Strut,stabiliser	520008
	1994.11-2000.10	Front Axle Left	Saloon FWD ADR/APT/ARG/AVV		Rod/Strut,stabiliser	S050034
	1994.11-2000.10	Front Axle Right	Saloon FWD ADR/APT/ARG/AVV		Rod/Strut,stabiliser	520010
	1994.11-2000.10	Front Axle Right	Saloon FWD ADR/APT/ARG/AVV		Rod/Strut,stabiliser	S050033
	1994.11-2000.10	Front Axle Left & Right	Saloon FWD ADR/APT/ARG/AVV		Rod/Strut,stabiliser	S050032
	1994.11-2000.10	Rear Axle Left	Saloon FWD ADR/APT/ARG/AVV		Rod/Strut,stabiliser	S050030
	1994.11-2000.10	Rear Axle Right	Saloon FWD ADR/APT/ARG/AVV		Rod/Strut,stabiliser	S050031
	1994.11-2000.10	Front Axle	Saloon FWD ADR/APT/ARG/AVV		Stabiliser Bushing	510138
	1994.11-2000.10	Front Axle	Saloon FWD ADR/APT/ARG/AVV		Stabiliser Bushing	510139
	1994.11-2000.10	Front Axle	Saloon FWD ADR/APT/ARG/AVV		Stabiliser Bushing	517806
	1994.11-2000.10	Front Axle Left	Saloon FWD ADR/APT/ARG/AVV		Steering Boot	540043
	1994.11-2000.10	Front Axle Left	Saloon FWD ADR/APT/ARG/AVV		Steering Rack Bellow Kit	540043S
	1994.11-2001.09	Front Axle Left Lower Inner	Estate FWD ADR/APT/ARG/AVV		Track Control Arm	S060055
	1994.11-2001.09	Front Axle Left Upper Inner	Estate FWD ADR/APT/ARG/AVV	Engine code APT,ADR,ARG,Chassis no. to:8D-V-152 087	Track Control Arm	S060021
	1994.11-2001.09	Front Axle Left Upper Inner	Estate FWD ADR/APT/ARG/AVV	Chassis no. from:8D-V-152 088,for vehicles without sports suspension,not for PR no.:1W	Track Control Arm	S062331
	1994.11-2001.09	Front Axle Left Upper Outer	Estate FWD ADR/APT/ARG/AVV		Track Control Arm	S060048
	1994.11-2001.09	Front Axle Left Upper Outer	Estate FWD ADR/APT/ARG/AVV	for vehicles with lowered suspension,For PR no.:1BV	Track Control Arm	S060798
	1994.11-2001.09	Front Axle Left Upper Outer	Estate FWD ADR/APT/ARG/AVV	not For PR no.:1BV	Track Control Arm	S062530
	1994.11-2001.09	Front Axle Right Lower Inner	Estate FWD ADR/APT/ARG/AVV		Track Control Arm	S060056
	1994.11-2001.09	Front Axle Right Upper Inner	Estate FWD ADR/APT/ARG/AVV	Engine code APT,ADR,ARG,Chassis no. to:8D-V-152 087	Track Control Arm	S060022
	1994.11-2001.09	Front Axle Right Upper Inner	Estate FWD ADR/APT/ARG/AVV	for vehicles with sports suspension	Track Control Arm	S060801
	1994.11-2001.09	Front Axle Right Upper Inner	Estate FWD ADR/APT/ARG/AVV	Chassis no. from:8D-V-152 088,for vehicles without sports suspension,not for PR no.:1W	Track Control Arm	S062332
	1994.11-2001.09	Front Axle Right Upper Outer	Estate FWD ADR/APT/ARG/AVV		Track Control Arm	S060049
	1994.11-2001.09	Front Axle Right Upper Outer	Estate FWD ADR/APT/ARG/AVV	for vehicles with lowered suspension,For PR no.:1BV	Track Control Arm	S060799
	1994.11-2001.09	Front Axle Right Upper Outer	Estate FWD ADR/APT/ARG/AVV	not For PR no.:1BV	Track Control Arm	S062531
	1994.11-2001.09	Front Axle Left & Right Lower Outer	Estate FWD ADR/APT/ARG/AVV		Track Control Arm	S060054
	1994.11-2001.09	Front Axle Left & Right Upper	Estate FWD ADR/APT/ARG/AVV		Control Arm Bushing	510136
	1994.11-2001.09	Front Axle Left & Right Lower Inner	Estate FWD ADR/APT/ARG/AVV		Control Arm Bushing	510135



	 YEAR	FITTING POSITION	BODY STYLE & DRIVE TYPE & ENGINE	REMARKS	PRODUCT	GSP Ref.
AUDI A4						
1.8 (92 kw)	1994.11-2001.09	Front Axle Left & Right Lower Inner	Estate FWD ADR/APT/ARG/AVV		Control Arm Bushing	510287
	1994.11-2001.09	Front Axle Left & Right Lower Outer	Estate FWD ADR/APT/ARG/AVV		Control Arm Bushing	510133
	1994.11-2001.09	Front Axle Left & Right Lower Outer	Estate FWD ADR/APT/ARG/AVV		Control Arm Bushing	510134
	1994.11-2001.09	Front Axle	Estate FWD ADR/APT/ARG/AVV		Suspension Repair Kit	S990001SK
	1994.11-2001.09	Front Axle Left & Right	Estate FWD ADR/APT/ARG/AVV		Rod Assembly	S100014
	1994.11-2001.09	Front Axle Left & Right	Estate FWD ADR/APT/ARG/AVV	for vehicles with sports suspension.For PR no.:1BV	Tie Rod End	S070016
	1994.11-2001.09	Front Axle Left & Right	Estate FWD ADR/APT/ARG/AVV	not For PR no.:1BV	Tie Rod End	S070038
	1994.11-2001.09	Front Axle Left	Estate FWD ADR/APT/ARG/AVV		Rod/Strut,stabiliser	520008
	1994.11-2001.09	Front Axle Left	Estate FWD ADR/APT/ARG/AVV		Rod/Strut,stabiliser	S050034
	1994.11-2001.09	Front Axle Right	Estate FWD ADR/APT/ARG/AVV		Rod/Strut,stabiliser	520010
	1994.11-2001.09	Front Axle Right	Estate FWD ADR/APT/ARG/AVV		Rod/Strut,stabiliser	S050033
	1994.11-2001.09	Front Axle Left & Right	Estate FWD ADR/APT/ARG/AVV		Rod/Strut,stabiliser	S050032
	1994.11-2001.09	Rear Axle Left	Estate FWD ADR/APT/ARG/AVV		Rod/Strut,stabiliser	S050030
	1994.11-2001.09	Rear Axle Right	Estate FWD ADR/APT/ARG/AVV		Rod/Strut,stabiliser	S050031
	1994.11-2001.09	Front Axle	Estate FWD ADR/APT/ARG/AVV	Stabiliser Ø:25 mm	Stabiliser Bushing	510138
	1994.11-2001.09	Front Axle	Estate FWD ADR/APT/ARG/AVV		Stabiliser Bushing	510139
	1994.11-2001.09	Front Axle	Estate FWD ADR/APT/ARG/AVV		Stabiliser Bushing	517806
	1994.11-2001.09	Front Axle Left	Estate FWD ADR/APT/ARG/AVV		Steering Boot	540043
	1994.11-2001.09	Front Axle Left	Estate FWD ADR/APT/ARG/AVV		Steering Rack Bellow Kit	540043S
	1.8 (110 kw)	1995.10-2001.09	Front Axle Left Lower Inner	Estate FWD AEB/ANB/APU/ARK/AWT		Track Control Arm
1995.10-2001.09		Front Axle Left Upper Inner	Estate FWD AEB/ANB/APU/ARK/AWT	Chassis no. to:8D-V-152 087	Track Control Arm	S060021
1995.10-2001.09		Front Axle Left Upper Inner	Estate FWD AEB/ANB/APU/ARK/AWT	Chassis no. from:8D-V-152 088 for vehicles without sports suspension not For PR no.:1BV	Track Control Arm	S062331
1995.10-2001.09		Front Axle Left Upper Outer	Estate FWD AEB/ANB/APU/ARK/AWT		Track Control Arm	S060048
1995.10-2001.09		Front Axle Left Upper Outer	Estate FWD AEB/ANB/APU/ARK/AWT	Engine code ANB, AEB, APT, APU for vehicles with limited suspension For PR no.:1BV	Track Control Arm	S060798
1995.10-2001.09		Front Axle Left Upper Outer	Estate FWD AEB/ANB/APU/ARK/AWT	Engine code AEB, ARK, Engine code ANB, APT, APU, not For PR no.:1BV	Track Control Arm	S062530
1995.10-2001.09		Front Axle Right Lower Inner	Estate FWD AEB/ANB/APU/ARK/AWT		Track Control Arm	S060056
1995.10-2001.09		Front Axle Right Upper Inner	Estate FWD AEB/ANB/APU/ARK/AWT	Chassis no. to:8D-V-152 087	Track Control Arm	S060022
1995.10-2001.09		Front Axle Right Upper Inner	Estate FWD AEB/ANB/APU/ARK/AWT	for vehicles with sports suspension	Track Control Arm	S060801
1995.10-2001.09		Front Axle Right Upper Inner	Estate FWD AEB/ANB/APU/ARK/AWT	Chassis no. from:8D-V-152 088 for vehicles without sports suspension not For PR no.:1BV	Track Control Arm	S062332
1995.10-2001.09		Front Axle Right Upper Outer	Estate FWD AEB/ANB/APU/ARK/AWT		Track Control Arm	S060049
1995.10-2001.09		Front Axle Right Upper Outer	Estate FWD AEB/ANB/APU/ARK/AWT	Engine code ANB, AEB, APT, APU for vehicles with limited suspension For PR no.:1BV	Track Control Arm	S060799
1995.10-2001.09		Front Axle Right Upper Outer	Estate FWD AEB/ANB/APU/ARK/AWT	Engine code AEB, ARK, Engine code ANB, APT, APU, not For PR no.:1BV	Track Control Arm	S062531
1995.10-2001.09		Front Axle Left & Right Lower Outer	Estate FWD AEB/ANB/APU/ARK/AWT		Track Control Arm	S060054
1995.10-2001.09		Front Axle Left & Right Upper	Estate FWD AEB/ANB/APU/ARK/AWT		Control Arm Bushing	510136
1995.10-2001.09		Front Axle Left & Right Lower Inner	Estate FWD AEB/ANB/APU/ARK/AWT		Control Arm Bushing	510135
1995.10-2001.09		Front Axle Left & Right Lower Inner	Estate FWD AEB/ANB/APU/ARK/AWT		Control Arm Bushing	510287
1995.10-2001.09		Front Axle Left & Right Lower Outer	Estate FWD AEB/ANB/APU/ARK/AWT		Control Arm Bushing	510133
1995.10-2001.09		Front Axle Left & Right Lower Outer	Estate FWD AEB/ANB/APU/ARK/AWT		Control Arm Bushing	510134
1995.10-2001.09		Front Axle	Estate FWD AEB/ANB/APU/ARK/AWT		Suspension Repair Kit	S990001SK
1995.10-2001.09		Front Axle Left & Right	Estate FWD AEB/ANB/APU/ARK/AWT		Rod Assembly	S100014
1995.10-2001.09		Front Axle Left & Right	Estate FWD AEB/ANB/APU/ARK/AWT	Engine code ANB, AEB, APT, APU for vehicles with sports suspension For PR no.:1BV	Tie Rod End	S070016
1995.10-2001.09		Front Axle Left & Right	Estate FWD AEB/ANB/APU/ARK/AWT	not For PR no.:1BV	Tie Rod End	S070038
1995.10-2001.09		Front Axle Left	Estate FWD AEB/ANB/APU/ARK/AWT		Rod/Strut,stabiliser	520008
1995.10-2001.09		Front Axle Left	Estate FWD AEB/ANB/APU/ARK/AWT		Rod/Strut,stabiliser	S050034
1995.10-2001.09		Front Axle Right	Estate FWD AEB/ANB/APU/ARK/AWT		Rod/Strut,stabiliser	520010
1995.10-2001.09		Front Axle Right	Estate FWD AEB/ANB/APU/ARK/AWT		Rod/Strut,stabiliser	S050033
1995.10-2001.09		Front Axle Left & Right	Estate FWD AEB/ANB/APU/ARK/AWT		Rod/Strut,stabiliser	S050032
1995.10-2001.09		Rear Axle Left	Estate FWD AEB/ANB/APU/ARK/AWT		Rod/Strut,stabiliser	S050030
1995.10-2001.09		Rear Axle Right	Estate FWD AEB/ANB/APU/ARK/AWT		Rod/Strut,stabiliser	S050031
1995.10-2001.09		Front Axle	Estate FWD AEB/ANB/APU/ARK/AWT	Stabiliser Ø:25 mm	Stabiliser Bushing	510138
1995.10-2001.09		Front Axle	Estate FWD AEB/ANB/APU/ARK/AWT		Stabiliser Bushing	510139
1995.10-2001.09		Front Axle	Estate FWD AEB/ANB/APU/ARK/AWT		Stabiliser Bushing	517806
1995.10-2001.09		Front Axle Left	Estate FWD AEB/ANB/APU/ARK/AWT		Steering Boot	540043
1995.10-2001.09		Front Axle Left	Estate FWD AEB/ANB/APU/ARK/AWT		Steering Rack Bellow Kit	540043S
2000.12-2004.12		Front Axle Left Lower Inner	Saloon FWD AVJ		Track Control Arm	S060055
2000.12-2004.12		Front Axle Left Upper Inner	Saloon FWD AVJ		Track Control Arm	S062331
2000.12-2004.12		Front Axle Left Upper Outer	Saloon FWD AVJ		Track Control Arm	S060048
2000.12-2004.12		Front Axle Left Upper Outer	Saloon FWD AVJ	for vehicles with sports suspension.For PR no.:1BV	Track Control Arm	S060798
2000.12-2004.12		Front Axle Left Upper Outer	Saloon FWD AVJ	not For PR no.:1BV	Track Control Arm	S062530
2000.12-2004.12	Front Axle Right Lower Inner	Saloon FWD AVJ		Track Control Arm	S060056	
2000.12-2004.12	Front Axle Right Upper Inner	Saloon FWD AVJ	for vehicles with sports suspension	Track Control Arm	S060801	
2000.12-2004.12	Front Axle Right Upper Inner	Saloon FWD AVJ	not for PR no.:1BV	Track Control Arm	S062332	
2000.12-2004.12	Front Axle Right Upper Outer	Saloon FWD AVJ		Track Control Arm	S060049	
2000.12-2004.12	Front Axle Right Upper Outer	Saloon FWD AVJ	for vehicles with sports suspension.For PR no.:1BV	Track Control Arm	S060799	



	 YEAR	FITTING POSITION	BODY STYLE & DRIVE TYPE & ENGINE	REMARKS	PRODUCT	GSP Ref.
AUDI						
A4						
1.8 (110 kw)	2000.12-2004.12	Front Axle Right Upper Outer	Saloon FWD AVJ	not For PR no.:1BV	Track Control Arm	S062531
	2000.12-2004.12	Front Axle Left & Right Lower Outer	Saloon FWD AVJ		Track Control Arm	S060047
	2000.12-2004.12	Rear Axle Left & Right Lower Outer	Saloon FWD AVJ		Track Control Arm	S062965
	2000.12-2004.12	Front Axle Left & Right Upper	Saloon FWD AVJ		Control Arm Bushing	510136
	2000.12-2004.12	Front Axle Left & Right Lower Inner	Saloon FWD AVJ		Control Arm Bushing	510287
	2000.12-2004.12	Front Axle Left & Right Lower Outer	Saloon FWD AVJ		Control Arm Bushing	510134
	2000.12-2004.12	Rear Axle Left & Right Upper	Saloon FWD AVJ		Control Arm Bushing	517141
	2000.12-2004.12	Rear Axle Left & Right Lower Outer	Saloon FWD AVJ		Control Arm Bushing	510393
	2000.12-2004.12	Rear Axle Left & Right Lower Outer	Saloon FWD AVJ		Control Arm Bushing	510394
	2000.12-2004.12	Front Axle	Saloon FWD AVJ		Suspension Repair Kit	S990008SK
	2000.12-2004.12	Front Axle Left & Right	Saloon FWD AVJ		Tie Rod Axle Joint	S030013
	2000.12-2004.12	Front Axle Left & Right	Saloon FWD AVJ	for vehicles with sports suspension,For PR no.:1BV	Tie Rod End	S070016
	2000.12-2004.12	Front Axle Left & Right	Saloon FWD AVJ	not For PR no.:1BV	Tie Rod End	S070038
	2000.12-2004.12	Front Axle Left	Saloon FWD AVJ		Rod/Strut, stabiliser	520523
	2000.12-2004.12	Front Axle Right	Saloon FWD AVJ		Rod/Strut, stabiliser	520524
	2000.12-2004.12	Rear Axle Left & Right	Saloon FWD AVJ		Rod/Strut, stabiliser	S050042
	2000.12-2004.12	Front Axle	Saloon FWD AVJ	Stabiliser Ø:27 mm	Stabiliser Bushing	510139
	2000.12-2004.12	Front Axle	Saloon FWD AVJ		Stabiliser Bushing	517806
	2000.12-2004.12	Rear Axle	Saloon FWD AVJ	for PR number:1BA;for PR number:1BR	Stabiliser Bushing	517807
1.8 (120 kw)	2002.08-2004.12	Front Axle Left Lower Inner	Estate FWD BFB		Track Control Arm	S060055
	2002.08-2004.12	Front Axle Left Upper Inner	Estate FWD BFB		Track Control Arm	S062331
	2002.08-2004.12	Front Axle Left Upper Outer	Estate FWD BFB		Track Control Arm	S060048
	2002.08-2004.12	Front Axle Left Upper Outer	Estate FWD BFB	for vehicles with sports suspension,For PR no.:1BV	Track Control Arm	S060798
	2002.08-2004.12	Front Axle Left Upper Outer	Estate FWD BFB	not For PR no.:1BV	Track Control Arm	S062530
	2002.08-2004.12	Front Axle Right Lower Inner	Estate FWD BFB		Track Control Arm	S060056
	2002.08-2004.12	Front Axle Right Upper Inner	Estate FWD BFB	for vehicles with sports suspension	Track Control Arm	S060801
	2002.08-2004.12	Front Axle Right Upper Inner	Estate FWD BFB	not for PR no.:1BV	Track Control Arm	S062332
	2002.08-2004.12	Front Axle Right Upper Outer	Estate FWD BFB		Track Control Arm	S060049
	2002.08-2004.12	Front Axle Right Upper Outer	Estate FWD BFB	for vehicles with sports suspension,For PR no.:1BV	Track Control Arm	S060799
	2002.08-2004.12	Front Axle Right Upper Outer	Estate FWD BFB	not For PR no.:1BV	Track Control Arm	S062531
	2002.08-2004.12	Front Axle Left & Right Lower Outer	Estate FWD BFB		Track Control Arm	S060047
	2002.08-2004.12	Rear Axle Left & Right Lower Outer	Estate FWD BFB		Track Control Arm	S062965
	2002.08-2004.12	Front Axle Left & Right Upper	Estate FWD BFB		Control Arm Bushing	510136
	2002.08-2004.12	Front Axle Left & Right Lower Inner	Estate FWD BFB		Control Arm Bushing	510287
	2002.08-2004.12	Front Axle Left & Right Lower Outer	Estate FWD BFB		Control Arm Bushing	510134
	2002.08-2004.12	Rear Axle Left & Right Upper	Estate FWD BFB		Control Arm Bushing	517141
	2002.08-2004.12	Rear Axle Left & Right Lower Outer	Estate FWD BFB		Control Arm Bushing	510393
	2002.08-2004.12	Rear Axle Left & Right Lower Outer	Estate FWD BFB		Control Arm Bushing	510394
	2002.08-2004.12	Front Axle	Estate FWD BFB		Suspension Repair Kit	S990008SK
	2002.08-2004.12	Front Axle Left & Right	Estate FWD BFB		Tie Rod Axle Joint	S030013
	2002.08-2004.12	Front Axle Left & Right	Estate FWD BFB	for vehicles with sports suspension,For PR no.:1BV	Tie Rod End	S070016
	2002.08-2004.12	Front Axle Left & Right	Estate FWD BFB	not For PR no.:1BV	Tie Rod End	S070038
	2002.08-2004.12	Front Axle Left	Estate FWD BFB		Rod/Strut, stabiliser	520523
	2002.08-2004.12	Front Axle Right	Estate FWD BFB		Rod/Strut, stabiliser	520524
	2002.08-2004.12	Rear Axle Left & Right	Estate FWD BFB		Rod/Strut, stabiliser	S050042
	2002.08-2004.12	Front Axle	Estate FWD BFB	Stabiliser Ø:25 mm	Stabiliser Bushing	510138
	2002.08-2004.12	Front Axle	Estate FWD BFB	Stabiliser Ø:27 mm	Stabiliser Bushing	510139
	2002.08-2004.12	Front Axle	Estate FWD BFB		Stabiliser Bushing	517806
	2002.08-2004.12	Rear Axle	Estate FWD BFB	for PR number:1BA;for PR number:1BR	Stabiliser Bushing	517807
	2004.11-2008.06	Front Axle Left Lower Inner	Saloon FWD BFB		Track Control Arm	S060026
	2004.11-2008.06	Front Axle Left Upper Outer	Saloon FWD BFB		Track Control Arm	S060798
	2004.11-2008.06	Front Axle Right Lower Inner	Saloon FWD BFB		Track Control Arm	S060027
	2004.11-2008.06	Front Axle Right Upper Inner	Saloon FWD BFB		Track Control Arm	S060801
	2004.11-2008.06	Front Axle Right Upper Outer	Saloon FWD BFB		Track Control Arm	S060799
	2004.11-2008.06	Front Axle Left & Right Lower Outer	Saloon FWD BFB		Track Control Arm	S060047
	2004.11-2008.06	Rear Axle Left & Right Lower Outer	Saloon FWD BFB		Track Control Arm	S062965
	2004.11-2008.06	Front Axle Left & Right Upper	Saloon FWD BFB		Control Arm Bushing	510136
	2004.11-2008.06	Front Axle Left & Right Lower Inner	Saloon FWD BFB		Control Arm Bushing	510287
	2004.11-2008.06	Front Axle Left & Right Lower Inner	Saloon FWD BFB		Control Arm Bushing	510301
	2004.11-2008.06	Front Axle Left & Right Lower Outer	Saloon FWD BFB		Control Arm Bushing	510134
	2004.11-2008.06	Rear Axle Left & Right Upper	Saloon FWD BFB		Control Arm Bushing	517141
	2004.11-2008.06	Rear Axle Left & Right Lower Outer	Saloon FWD BFB		Control Arm Bushing	510393
	2004.11-2008.06	Front Axle	Saloon FWD BFB		Suspension Repair Kit	S990008SK
	2004.11-2008.06	Front Axle Left & Right	Saloon FWD BFB		Tie Rod Axle Joint	S030013



	 YEAR	FITTING POSITION	BODY STYLE & DRIVE TYPE & ENGINE	REMARKS	PRODUCT	GSP Ref.
AUDI						
A4						
1.8 (120 kw)	2004.11-2008.06	Front Axle Left & Right	Saloon FWD BFB		Tie Rod End	S070016
	2004.11-2008.06	Front Axle Left	Saloon FWD BFB		Rod/Strut,stabiliser	520523
	2004.11-2008.06	Front Axle Right	Saloon FWD BFB		Rod/Strut,stabiliser	520524
	2004.11-2008.06	Rear Axle Left & Right	Saloon FWD BFB		Rod/Strut,stabiliser	S050042
	2004.11-2008.06	Front Axle	Saloon FWD BFB	Stabiliser Ø:25 mm	Stabiliser Bushing	510138
	2004.11-2008.06	Front Axle	Saloon FWD BFB	Stabiliser Ø:27 mm	Stabiliser Bushing	510139
	2004.11-2008.06	Front Axle	Saloon FWD BFB		Stabiliser Bushing	517806
	2004.11-2008.06	Rear Axle	Saloon FWD BFB		Stabiliser Bushing	517807
1.8 (125 kw)	2011.11-2015.12	Front Axle Left Lower Inner	Estate FWD CJEB	for manufacturer: rear bush Ø65mm	Track Control Arm	S061601
	2011.11-2015.12	Front Axle Left Lower Inner	Estate FWD CJEB		Track Control Arm	S062261
	2011.11-2015.12	Front Axle Left Upper Inner	Estate FWD CJEB		Track Control Arm	S060804
	2011.11-2015.12	Front Axle Left Upper Inner	Saloon FWD CJEB		Track Control Arm	S060804
	2011.11-2015.12	Front Axle Left Lower Outer	Estate FWD CJEB		Track Control Arm	S062024
	2011.11-2015.12	Front Axle Left Upper Outer	Estate FWD CJEB		Track Control Arm	S060802
	2011.11-2015.12	Front Axle Left Upper Outer	Saloon FWD CJEB		Track Control Arm	S060802
	2011.11-2015.12	Front Axle Right Lower Inner	Estate FWD CJEB	for manufacturer:rear bush Ø65mm	Track Control Arm	S061602
	2011.11-2015.12	Front Axle Right Lower Inner	Estate FWD CJEB		Track Control Arm	S062177
	2011.11-2015.12	Front Axle Right Upper Inner	Estate FWD CJEB		Track Control Arm	S060805
	2011.11-2015.12	Front Axle Right Upper Inner	Saloon FWD CJEB		Track Control Arm	S060805
	2011.11-2015.12	Front Axle Right Lower Outer	Estate FWD CJEB		Track Control Arm	S062025
	2011.11-2015.12	Front Axle Right Upper Outer	Estate FWD CJEB		Track Control Arm	S060803
	2011.11-2015.12	Front Axle Right Upper Outer	Saloon FWD CJEB		Track Control Arm	S060803
	2011.11-2015.12	Rear Axle Left Upper	Estate FWD CJEB		Track Control Arm	S061397
	2011.11-2015.12	Rear Axle Left Upper	Saloon FWD CJEB		Track Control Arm	S061397
	2011.11-2015.12	Rear Axle Left Lower Inner	Estate FWD CJEB		Track Control Arm	S061574
	2011.11-2015.12	Rear Axle Left Lower Outer	Estate FWD CJEB		Track Control Arm	S062748
	2011.11-2015.12	Rear Axle Left Lower Outer	Saloon FWD CJEB		Track Control Arm	S062748
	2011.11-2015.12	Rear Axle Right Upper	Estate FWD CJEB		Track Control Arm	S061398
	2011.11-2015.12	Rear Axle Right Upper	Saloon FWD CJEB		Track Control Arm	S061398
	2011.11-2015.12	Rear Axle Right Lower Inner	Estate FWD CJEB		Track Control Arm	S061575
	2011.11-2015.12	Rear Axle Right Lower Outer	Estate FWD CJEB		Track Control Arm	S062749
	2011.11-2015.12	Rear Axle Right Lower Outer	Saloon FWD CJEB		Track Control Arm	S062749
	2011.11-2015.12	Rear Axle Left & Right Lower Inner	Estate FWD CJEB		Track Control Arm	S062964
	2011.11-2015.12	Rear Axle Left & Right Lower Inner	Saloon FWD CJEB		Track Control Arm	S062964
	2011.11-2015.12	Front Axle Left & Right Lower Outer	Estate FWD CJEB		Ball Joint	S080987
	2011.11-2015.12	Front Axle Left & Right Lower Outer	Saloon FWD CJEB		Ball Joint	S080987
	2011.11-2015.12	Front Axle Left & Right Upper	Estate FWD CJEB		Control Arm Bushing	510136
	2011.11-2015.12	Front Axle Left & Right Upper	Saloon FWD CJEB		Control Arm Bushing	510136
	2011.11-2015.12	Front Axle Left & Right Lower Inner	Estate FWD CJEB		Control Arm Bushing	531929
	2011.11-2015.12	Front Axle Left & Right Lower Inner	Saloon FWD CJEB		Control Arm Bushing	531929
	2011.11-2015.12	Front Axle Left & Right Lower Inner	Estate FWD CJEB		Control Arm Bushing	531931
	2011.11-2015.12	Front Axle Left & Right Lower Inner	Saloon FWD CJEB		Control Arm Bushing	531931
	2011.11-2015.12	Front Axle Left & Right Lower Outer	Estate FWD CJEB		Control Arm Bushing	510299
	2011.11-2015.12	Front Axle Left & Right Lower Outer	Saloon FWD CJEB		Control Arm Bushing	510299
	2011.11-2015.12	Front Axle Left & Right Lower Outer	Estate FWD CJEB		Control Arm Bushing	530215
	2011.11-2015.12	Front Axle Left & Right Lower Outer	Saloon FWD CJEB		Control Arm Bushing	530215
	2011.11-2015.12	Rear Axle Left & Right Lower Inner	Estate FWD CJEB		Control Arm Bushing	533477
	2011.11-2015.12	Rear Axle Left & Right Lower Inner	Saloon FWD CJEB		Control Arm Bushing	533477
	2011.11-2015.12	Front Axle Left & Right	Estate FWD CJEB		Tie Rod Axle Joint	S030342
	2011.11-2015.12	Front Axle Left & Right	Saloon FWD CJEB		Tie Rod Axle Joint	S030342
	2011.11-2015.12	Front Axle Left	Estate FWD CJEB		Tie Rod End	S070024
	2011.11-2015.12	Front Axle Left	Saloon FWD CJEB		Tie Rod End	S070024
	2011.11-2015.12	Front Axle Right	Estate FWD CJEB		Tie Rod End	S070025
	2011.11-2015.12	Front Axle Right	Saloon FWD CJEB		Tie Rod End	S070025
	2011.11-2015.12	Front Axle Left & Right	Estate FWD CJEB	Aluminum Material	Rod/Strut,stabiliser	S050473
	2011.11-2015.12	Front Axle Left & Right	Saloon FWD CJEB	Aluminum Material	Rod/Strut,stabiliser	S050473
	2011.11-2015.12	Front Axle Left & Right	Estate FWD CJEB	Not for country:spain,model:Ravon,Not for country:spain,model:Belina	Rod/Strut,stabiliser	S051258
	2011.11-2015.12	Front Axle Left & Right	Saloon FWD CJEB	Not for country:spain,model:Ravon,Not for country:spain,model:Belina	Rod/Strut,stabiliser	S051258
	2011.11-2015.12	Rear Axle Left & Right	Estate FWD CJEB		Rod/Strut,stabiliser	S050472
	2011.11-2015.12	Rear Axle Left & Right	Saloon FWD CJEB		Rod/Strut,stabiliser	S050472
	2011.11-2015.12	Front Axle	Estate FWD CJEB		Stabiliser Bushing	510138
	2011.11-2015.12	Front Axle	Saloon FWD CJEB		Stabiliser Bushing	510138
	2011.11-2015.12	Front Axle	Estate FWD CJEB	for PR no.:1BA	Stabiliser Bushing	532578
	2011.11-2015.12	Front Axle	Saloon FWD CJEB	for PR no.:1BA/1BL/1BR	Stabiliser Bushing	532578



	 YEAR	FITTING POSITION	BODY STYLE & DRIVE TYPE & ENGINE	REMARKS	PRODUCT	GSP Ref.
AUDI A4 2.0 (132 kw)	2008.06-2015.12	Front Axle Left Lower Inner	Estate FWD CDMB/CFKA	Date to: 2009.10	Track Control Arm	S060038
	2008.06-2015.12	Front Axle Left Lower Inner	Saloon FWD CDMB/CFKA	Date to: 2009.10	Track Control Arm	S060038
	2008.06-2015.12	Front Axle Left Lower Inner	Estate FWD CDMB/CFKA	Date from-to:2009.11-2010.05,VIN:WUJ***8K	Track Control Arm	S061601
	2008.06-2015.12	Front Axle Left Lower Inner	Saloon FWD CDMB/CFKA	Date from-to:2009.11-2010.05,VIN:WUJ***8K	Track Control Arm	S061601
	2008.06-2015.12	Front Axle Left Lower Inner	Estate FWD CDMB/CFKA		Track Control Arm	S062261
	2008.06-2015.12	Front Axle Left Lower Inner	Saloon FWD CDMB/CFKA		Track Control Arm	S062261
	2008.06-2015.12	Front Axle Left Upper Inner	Estate FWD CDMB/CFKA		Track Control Arm	S060804
	2008.06-2015.12	Front Axle Left Upper Inner	Saloon FWD CDMB/CFKA		Track Control Arm	S060804
	2008.06-2015.12	Front Axle Left Lower Outer	Estate FWD CDMB/CFKA	Date from:2011.08	Track Control Arm	S060806
	2008.06-2015.12	Front Axle Left Lower Outer	Saloon FWD CDMB/CFKA	Date from:2011.08	Track Control Arm	S060806
	2008.06-2015.12	Front Axle Left Lower Outer	Estate FWD CDMB/CFKA		Track Control Arm	S062024
	2008.06-2015.12	Front Axle Left Upper Outer	Estate FWD CDMB/CFKA		Track Control Arm	S060802
	2008.06-2015.12	Front Axle Left Upper Outer	Saloon FWD CDMB/CFKA		Track Control Arm	S060802
	2008.06-2015.12	Front Axle Right Lower Inner	Estate FWD CDMB/CFKA	Date to:2009.10	Track Control Arm	S060039
	2008.06-2015.12	Front Axle Right Lower Inner	Saloon FWD CDMB/CFKA	Date to:2009.10	Track Control Arm	S060039
	2008.06-2015.12	Front Axle Right Lower Inner	Estate FWD CDMB/CFKA	Date from-to:2009.11-2010.05,VIN:WUJ***8K	Track Control Arm	S061602
	2008.06-2015.12	Front Axle Right Lower Inner	Saloon FWD CDMB/CFKA	Date from-to:2009.11-2010.05,VIN:WUJ***8K	Track Control Arm	S061602
	2008.06-2015.12	Front Axle Right Lower Inner	Estate FWD CDMB/CFKA		Track Control Arm	S062177
	2008.06-2015.12	Front Axle Right Lower Inner	Saloon FWD CDMB/CFKA		Track Control Arm	S062177
	2008.06-2015.12	Front Axle Right Upper Inner	Estate FWD CDMB/CFKA		Track Control Arm	S060805
	2008.06-2015.12	Front Axle Right Upper Inner	Saloon FWD CDMB/CFKA		Track Control Arm	S060805
	2008.06-2015.12	Front Axle Right Lower Outer	Estate FWD CDMB/CFKA	Date from:2011.08	Track Control Arm	S060807
	2008.06-2015.12	Front Axle Right Lower Outer	Saloon FWD CDMB/CFKA	Date from:2011.08	Track Control Arm	S060807
	2008.06-2015.12	Front Axle Right Lower Outer	Estate FWD CDMB/CFKA		Track Control Arm	S062025
	2008.06-2015.12	Front Axle Right Upper Outer	Estate FWD CDMB/CFKA		Track Control Arm	S060803
	2008.06-2015.12	Front Axle Right Upper Outer	Saloon FWD CDMB/CFKA		Track Control Arm	S060803
	2008.06-2015.12	Rear Axle Left Upper	Estate FWD CDMB/CFKA		Track Control Arm	S061397
	2008.06-2015.12	Rear Axle Left Upper	Saloon FWD CDMB/CFKA		Track Control Arm	S061397
	2008.06-2015.12	Rear Axle Left Lower Inner	Estate FWD CDMB/CFKA		Track Control Arm	S061574
	2008.06-2015.12	Rear Axle Left Lower Inner	Saloon FWD CDMB/CFKA		Track Control Arm	S061574
	2008.06-2015.12	Rear Axle Left Lower Outer	Estate FWD CDMB/CFKA		Track Control Arm	S062748
	2008.06-2015.12	Rear Axle Left Lower Outer	Saloon FWD CDMB/CFKA		Track Control Arm	S062748
	2008.06-2015.12	Rear Axle Right Upper	Estate FWD CDMB/CFKA		Track Control Arm	S061398
	2008.06-2015.12	Rear Axle Right Upper	Saloon FWD CDMB/CFKA		Track Control Arm	S061398
	2008.06-2015.12	Rear Axle Right Lower Inner	Estate FWD CDMB/CFKA		Track Control Arm	S061575
	2008.06-2015.12	Rear Axle Right Lower Inner	Saloon FWD CDMB/CFKA		Track Control Arm	S061575
	2008.06-2015.12	Rear Axle Right Lower Outer	Estate FWD CDMB/CFKA		Track Control Arm	S062749
	2008.06-2015.12	Rear Axle Right Lower Outer	Saloon FWD CDMB/CFKA		Track Control Arm	S062749
	2008.06-2015.12	Rear Axle Left & Right Lower Inner	Estate FWD CDMB/CFKA		Track Control Arm	S062964
	2008.06-2015.12	Rear Axle Left & Right Lower Inner	Saloon FWD CDMB/CFKA		Track Control Arm	S062964
	2008.06-2015.12	Front Axle Left & Right Lower Outer	Estate FWD CDMB/CFKA	Date to:2011.12	Ball Joint	S080283
	2008.06-2015.12	Front Axle Left & Right Lower Outer	Saloon FWD CDMB/CFKA	Date to:2011.12	Ball Joint	S080283
	2008.06-2015.12	Front Axle Left & Right Lower Outer	Estate FWD CDMB/CFKA	Date from:2011.08	Ball Joint	S080987
	2008.06-2015.12	Front Axle Left & Right Lower Outer	Saloon FWD CDMB/CFKA	Date from:2011.08	Ball Joint	S080987
	2008.06-2015.12	Front Axle Left & Right Upper	Estate FWD CDMB/CFKA		Control Arm Bushing	510136
	2008.06-2015.12	Front Axle Left & Right Upper	Saloon FWD CDMB/CFKA		Control Arm Bushing	510136
	2008.06-2015.12	Front Axle Left & Right Lower Inner	Estate FWD CDMB/CFKA		Control Arm Bushing	530214
	2008.06-2015.12	Front Axle Left & Right Lower Inner	Saloon FWD CDMB/CFKA		Control Arm Bushing	530214
	2008.06-2015.12	Front Axle Left & Right Lower Inner	Estate FWD CDMB/CFKA		Control Arm Bushing	531929
	2008.06-2015.12	Front Axle Left & Right Lower Inner	Saloon FWD CDMB/CFKA		Control Arm Bushing	531929
2008.06-2015.12	Front Axle Left & Right Lower Inner	Estate FWD CDMB/CFKA		Control Arm Bushing	531931	
2008.06-2015.12	Front Axle Left & Right Lower Inner	Saloon FWD CDMB/CFKA		Control Arm Bushing	531931	
2008.06-2015.12	Front Axle Left & Right Lower Outer	Estate FWD CDMB/CFKA	Date to:2011.08	Control Arm Bushing	510299	
2008.06-2015.12	Front Axle Left & Right Lower Outer	Saloon FWD CDMB/CFKA	Date to:2011.08	Control Arm Bushing	510299	
2008.06-2015.12	Front Axle Left & Right Lower Outer	Estate FWD CDMB/CFKA		Control Arm Bushing	530215	
2008.06-2015.12	Front Axle Left & Right Lower Outer	Saloon FWD CDMB/CFKA		Control Arm Bushing	530215	
2008.06-2015.12	Rear Axle Left & Right Lower Inner	Estate FWD CDMB/CFKA		Control Arm Bushing	533477	
2008.06-2015.12	Rear Axle Left & Right Lower Inner	Saloon FWD CDMB/CFKA		Control Arm Bushing	533477	
2008.06-2015.12	Front Axle Left & Right	Estate FWD CDMB/CFKA		Tie Rod Axle Joint	S030342	
2008.06-2015.12	Front Axle Left & Right	Saloon FWD CDMB/CFKA		Tie Rod Axle Joint	S030342	
2008.06-2015.12	Front Axle Left	Estate FWD CDMB/CFKA		Tie Rod End	S070024	
2008.06-2015.12	Front Axle Left	Saloon FWD CDMB/CFKA		Tie Rod End	S070024	
2008.06-2015.12	Front Axle Right	Estate FWD CDMB/CFKA		Tie Rod End	S070025	
2008.06-2015.12	Front Axle Right	Saloon FWD CDMB/CFKA		Tie Rod End	S070025	



	 YEAR	FITTING POSITION	BODY STYLE & DRIVE TYPE & ENGINE	REMARKS	PRODUCT	GSP Ref.	
AUDI A4							
2.0 (132 kw)	2008.06-2015.12	Front Axle Left & Right	Estate FWD CDN/CFKA	Aluminum Material	Rod/Strut, stabiliser	S050473	
	2008.06-2015.12	Front Axle Left & Right	Saloon FWD CDN/CFKA	Aluminum Material	Rod/Strut, stabiliser	S050473	
	2008.06-2015.12	Front Axle Left & Right	Estate FWD CDN/CFKA	<small>Date from 2011.11.04 to country spec model Russia, Not for country spec model Belarus</small>	Rod/Strut, stabiliser	S051258	
	2008.06-2015.12	Front Axle Left & Right	Saloon FWD CDN/CFKA	<small>Date from 2011.11.04 to country spec model Russia, Not for country spec model Belarus</small>	Rod/Strut, stabiliser	S051258	
	2008.06-2015.12	Rear Axle Left & Right	Estate FWD CDN/CFKA		Rod/Strut, stabiliser	S050472	
	2008.06-2015.12	Rear Axle Left & Right	Saloon FWD CDN/CFKA		Rod/Strut, stabiliser	S050472	
	2008.06-2015.12	Front Axle	Estate FWD CDN/CFKA	for PR no.:1BE,1BL/1BD/1BP/1BV	Stabiliser Bushing	510138	
	2008.06-2015.12	Front Axle	Saloon FWD CDN/CFKA		Stabiliser Bushing	510138	
	2008.06-2015.12	Front Axle	Estate FWD CDN/CFKA	for PR no.:1BA	Stabiliser Bushing	532578	
	2008.06-2015.12	Front Axle	Saloon FWD CDN/CFKA	for PR no.:1BA/1BL/1BR	Stabiliser Bushing	532578	
2.0 (140 kw)	2015.05-2019.11	Front Axle Left Upper Inner	Saloon FWD CVKB/DBPA		Track Control Arm	S062930	
	2015.05-2019.11	Front Axle Left Lower Outer	Saloon FWD CVKB/DBPA		Track Control Arm	S062924	
	2015.05-2019.11	Front Axle Left Upper Outer	Saloon FWD CVKB/DBPA		Track Control Arm	S062928	
	2015.05-2019.11	Front Axle Right Upper Inner	Saloon FWD CVKB/DBPA		Track Control Arm	S062931	
	2015.05-2019.11	Front Axle Right Lower Outer	Saloon FWD CVKB/DBPA		Track Control Arm	S062925	
	2015.05-2019.11	Front Axle Right Upper Outer	Saloon FWD CVKB/DBPA		Track Control Arm	S062929	
	2015.05-2019.11	Front Axle Left & Right Lower Outer	Saloon FWD CVKB/DBPA		Ball Joint	S080987	
	2015.05-2019.11	Front Axle Left & Right Upper	Saloon FWD CVKB/DBPA		Control Arm Bushing	533522	
	2015.05-2019.11	Front Axle Left & Right Lower Inner	Saloon FWD CVKB/DBPA		Control Arm Bushing	531931	
	2015.05-2019.11	Front Axle Left & Right Lower Outer	Saloon FWD CVKB/DBPA		Control Arm Bushing	510299	
	2015.05-2019.11	Front Axle Left & Right Lower Outer	Saloon FWD CVKB/DBPA		Control Arm Bushing	530215	
	2015.05-2019.11	Front Axle Left & Right	Saloon FWD CVKB/DBPA		Tie Rod Axle Joint	S030931	
	2015.05-2019.11	Front Axle Left	Saloon FWD CVKB/DBPA		Tie Rod End	S071632	
	2015.05-2019.11	Front Axle Right	Saloon FWD CVKB/DBPA		Tie Rod End	S071634	
	2015.05-2019.11	Front Axle Left & Right	Saloon FWD CVKB/DBPA		Rod/Strut, stabiliser	S051258	
	2015.05-2019.11	Rear Axle Left & Right	Saloon FWD CVKB/DBPA		Rod/Strut, stabiliser	S051433	
	2015.05-2019.11	Front Axle	Saloon FWD CVKB/DBPA	<small>Engine code CVKB, for vehicles without sports suspension</small>	Stabiliser Bushing	510138	
	2015.05-2019.11	Front Axle	Saloon FWD CVKB/DBPA	<small>Engine code CVKB, for vehicles with sports suspension</small>	Stabiliser Bushing	532579	
	2015.08-	Front Axle Left Lower Inner	Estate FWD CVKB/DBPA		Track Control Arm	S062926	
	2015.08-	Front Axle Left Upper Inner	Estate FWD CVKB/DBPA		Track Control Arm	S062930	
	2015.08-	Front Axle Left Lower Outer	Estate FWD CVKB/DBPA		Track Control Arm	S062924	
	2015.08-	Front Axle Left Upper Outer	Estate FWD CVKB/DBPA		Track Control Arm	S062928	
	2015.08-	Front Axle Right Lower Inner	Estate FWD CVKB/DBPA		Track Control Arm	S062927	
	2015.08-	Front Axle Right Upper Inner	Estate FWD CVKB/DBPA		Track Control Arm	S062931	
	2015.08-	Front Axle Right Lower Outer	Estate FWD CVKB/DBPA		Track Control Arm	S062925	
	2015.08-	Front Axle Right Upper Outer	Estate FWD CVKB/DBPA		Track Control Arm	S062929	
	2015.08-	Front Axle Left & Right Lower Outer	Estate FWD CVKB/DBPA		Ball Joint	S080987	
	2015.08-	Front Axle Left & Right Upper	Estate FWD CVKB/DBPA		Control Arm Bushing	533522	
	2015.08-	Front Axle Left & Right Lower Inner	Estate FWD CVKB/DBPA		Control Arm Bushing	531931	
	2015.08-	Front Axle Left & Right Lower Inner	Estate FWD CVKB/DBPA	Equipment Vari.:HYDRO SB	Control Arm Bushing	531931	
	2015.08-	Front Axle Left & Right Lower Outer	Estate FWD CVKB/DBPA		Control Arm Bushing	510299	
	2015.08-	Front Axle Left & Right Lower Outer	Estate FWD CVKB/DBPA		Control Arm Bushing	530215	
	2015.08-	Front Axle Left & Right	Estate FWD CVKB/DBPA		Tie Rod Axle Joint	S030931	
	2015.08-	Front Axle Left	Estate FWD CVKB/DBPA		Tie Rod End	S071632	
	2015.08-	Front Axle Right	Estate FWD CVKB/DBPA		Tie Rod End	S071634	
	2015.08-	Front Axle Left & Right	Estate FWD CVKB/DBPA	not For PR no.:1BR/1BP/2MN	Rod/Strut, stabiliser	S051258	
	2015.08-	Front Axle Left & Right	Estate FWD CVKB/DBPA		Rod/Strut, stabiliser	S051258	
	2015.08-	Rear Axle Left & Right	Estate FWD CVKB/DBPA		Rod/Strut, stabiliser	S051433	
	2015.08-	Front Axle	Estate FWD CVKB/DBPA	<small>for vehicles without sports suspension</small>	Stabiliser Bushing	510138	
	2015.08-	Front Axle	Estate FWD CVKB/DBPA		Stabiliser Bushing	510138	
	2015.08-	Front Axle	Estate FWD CVKB/DBPA	<small>for vehicles with sports suspension</small>	Stabiliser Bushing	532579	
	2015.08-	Front Axle	Estate FWD CVKB/DBPA		Stabiliser Bushing	532579	
	2.0 (147 kw)	2004.11-2008.03	Front Axle Left Lower Inner	Estate FWD BGB/BWE		Track Control Arm	S060026
		2004.11-2008.03	Front Axle Left Upper Outer	Estate FWD BGB/BWE		Track Control Arm	S060798
		2004.11-2008.03	Front Axle Right Lower Inner	Estate FWD BGB/BWE		Track Control Arm	S060027
		2004.11-2008.03	Front Axle Right Upper Inner	Estate FWD BGB/BWE		Track Control Arm	S060801
		2004.11-2008.03	Front Axle Right Upper Outer	Estate FWD BGB/BWE		Track Control Arm	S060799
2004.11-2008.03		Front Axle Left & Right Lower Outer	Estate FWD BGB/BWE		Track Control Arm	S060047	
2004.11-2008.03		Rear Axle Left & Right Lower Outer	Estate FWD BGB/BWE		Track Control Arm	S062965	
2004.11-2008.03		Front Axle Left & Right Upper	Estate FWD BGB/BWE		Control Arm Bushing	510136	
2004.11-2008.03		Front Axle Left & Right Lower Inner	Estate FWD BGB/BWE		Control Arm Bushing	510287	
2004.11-2008.03		Front Axle Left & Right Lower Inner	Estate FWD BGB/BWE		Control Arm Bushing	510301	
2004.11-2008.03		Front Axle Left & Right Lower Outer	Estate FWD BGB/BWE		Control Arm Bushing	510134	
2004.11-2008.03		Rear Axle Left & Right Upper	Estate FWD BGB/BWE		Control Arm Bushing	517141	



	 YEAR	FITTING POSITION	BODY STYLE & DRIVE TYPE & ENGINE	REMARKS	PRODUCT	GSP Ref.
AUDI A4						
2.0 (147 kw)	2004.11-2008.03	Rear Axle Left & Right Lower Outer	Estate FWD BGB/BWE		Control Arm Bushing	510393
	2004.11-2008.03	Front Axle Left & Right	Estate FWD BGB/BWE		Tie Rod Axle Joint	S030013
	2004.11-2008.03	Front Axle Left & Right	Estate FWD BGB/BWE		Tie Rod End	S070016
	2004.11-2008.03	Front Axle Left	Estate FWD BGB/BWE		Rod/Strut, stabiliser	520523
	2004.11-2008.03	Front Axle Right	Estate FWD BGB/BWE		Rod/Strut, stabiliser	520524
	2004.11-2008.03	Rear Axle Left & Right	Estate FWD BGB/BWE		Rod/Strut, stabiliser	S050042
	2004.11-2008.03	Front Axle	Estate FWD BGB/BWE		Stabiliser Bushing	510138
	2004.11-2008.03	Front Axle	Estate FWD BGB/BWE		Stabiliser Bushing	510139
	2004.11-2008.03	Front Axle	Estate FWD BGB/BWE		Stabiliser Bushing	517806
	2004.11-2008.03	Rear Axle	Estate FWD BGB/BWE		Stabiliser Bushing	517807
2.0 (155 kw)	2008.06-2015.12	Front Axle Left Lower Inner	Saloon FWD CAEB/CDNC	Date to: 2009.10	Track Control Arm	S060038
	2008.06-2015.12	Front Axle Left Lower Inner	Saloon FWD CAEB/CDNC	Date from-to:2009.11-2010.05,VIN:WAU**8K	Track Control Arm	S061601
	2008.06-2015.12	Front Axle Left Lower Inner	Saloon FWD CAEB/CDNC		Track Control Arm	S062261
	2008.06-2015.12	Front Axle Left Upper Inner	Saloon FWD CAEB/CDNC		Track Control Arm	S060804
	2008.06-2015.12	Front Axle Left Lower Outer	Saloon FWD CAEB/CDNC	Date from:2011.08	Track Control Arm	S060806
	2008.06-2015.12	Front Axle Left Upper Outer	Saloon FWD CAEB/CDNC		Track Control Arm	S060802
	2008.06-2015.12	Front Axle Right Lower Inner	Saloon FWD CAEB/CDNC	Date to:2009.10	Track Control Arm	S060039
	2008.06-2015.12	Front Axle Right Lower Inner	Saloon FWD CAEB/CDNC	Date from-to:2009.11-2010.05,VIN:WAU**8K	Track Control Arm	S061602
	2008.06-2015.12	Front Axle Right Lower Inner	Saloon FWD CAEB/CDNC		Track Control Arm	S062177
	2008.06-2015.12	Front Axle Right Upper Inner	Saloon FWD CAEB/CDNC		Track Control Arm	S060805
	2008.06-2015.12	Front Axle Right Lower Outer	Saloon FWD CAEB/CDNC	Date from:2011.08	Track Control Arm	S060807
	2008.06-2015.12	Front Axle Right Upper Outer	Saloon FWD CAEB/CDNC		Track Control Arm	S060803
	2008.06-2015.12	Rear Axle Left Upper	Saloon FWD CAEB/CDNC		Track Control Arm	S061397
	2008.06-2015.12	Rear Axle Left Lower Inner	Saloon FWD CAEB/CDNC		Track Control Arm	S061574
	2008.06-2015.12	Rear Axle Left Lower Outer	Saloon FWD CAEB/CDNC		Track Control Arm	S062748
	2008.06-2015.12	Rear Axle Right Upper	Saloon FWD CAEB/CDNC		Track Control Arm	S061398
	2008.06-2015.12	Rear Axle Right Lower Inner	Saloon FWD CAEB/CDNC		Track Control Arm	S061575
	2008.06-2015.12	Rear Axle Right Lower Outer	Saloon FWD CAEB/CDNC		Track Control Arm	S062749
	2008.06-2015.12	Rear Axle Left & Right Lower Inner	Saloon FWD CAEB/CDNC		Track Control Arm	S062964
	2008.06-2015.12	Front Axle Left & Right Lower Outer	Saloon FWD CAEB/CDNC	Date to:2011.12	Ball Joint	S080283
	2008.06-2015.12	Front Axle Left & Right Lower Outer	Saloon FWD CAEB/CDNC	Date from:2011.08	Ball Joint	S080987
	2008.06-2015.12	Front Axle Left & Right Upper	Saloon FWD CAEB/CDNC		Control Arm Bushing	510136
	2008.06-2015.12	Front Axle Left & Right Lower Inner	Saloon FWD CAEB/CDNC		Control Arm Bushing	530214
	2008.06-2015.12	Front Axle Left & Right Lower Inner	Saloon FWD CAEB/CDNC		Control Arm Bushing	531929
	2008.06-2015.12	Front Axle Left & Right Lower Inner	Saloon FWD CAEB/CDNC		Control Arm Bushing	531931
	2008.06-2015.12	Front Axle Left & Right Lower Outer	Saloon FWD CAEB/CDNC	Date to:2011.08	Control Arm Bushing	510299
	2008.06-2015.12	Front Axle Left & Right Lower Outer	Saloon FWD CAEB/CDNC		Control Arm Bushing	530215
	2008.06-2015.12	Rear Axle Left & Right Lower Inner	Saloon FWD CAEB/CDNC		Control Arm Bushing	533477
	2008.06-2015.12	Front Axle Left & Right	Saloon FWD CAEB/CDNC		Tie Rod Axle Joint	S030342
	2008.06-2015.12	Front Axle Left	Saloon FWD CAEB/CDNC		Tie Rod End	S070024
	2008.06-2015.12	Front Axle Right	Saloon FWD CAEB/CDNC		Tie Rod End	S070025
	2008.06-2015.12	Front Axle Left & Right	Saloon FWD CAEB/CDNC	Aluminum Material	Rod/Strut, stabiliser	S050473
	2008.06-2015.12	Front Axle Left & Right	Saloon FWD CAEB/CDNC	Date from:2011.11,Not for country spec, model:Bushes,Not for country spec, model:Bushes	Rod/Strut, stabiliser	S051258
	2008.06-2015.12	Rear Axle Left & Right	Saloon FWD CAEB/CDNC		Rod/Strut, stabiliser	S050472
	2008.06-2015.12	Front Axle	Saloon FWD CAEB/CDNC		Stabiliser Bushing	510138
	2008.06-2015.12	Front Axle	Saloon FWD CAEB/CDNC	for PR no.:1BA/1BL/1BR	Stabiliser Bushing	532578
2.0 (165 kw)	2013.01-2015.12	Front Axle Left Lower Inner	Estate FWD CNCD	for manufacturer: rear bush Ø65mm	Track Control Arm	S061601
	2013.01-2015.12	Front Axle Left Lower Inner	Estate FWD CNCD		Track Control Arm	S062261
	2013.01-2015.12	Front Axle Left Upper Inner	Estate FWD CNCD		Track Control Arm	S060804
	2013.01-2015.12	Front Axle Left Upper Inner	Saloon FWD CNCD		Track Control Arm	S060804
	2013.01-2015.12	Front Axle Left Lower Outer	Estate FWD CNCD		Track Control Arm	S062024
	2013.01-2015.12	Front Axle Left Upper Outer	Estate FWD CNCD		Track Control Arm	S060802
	2013.01-2015.12	Front Axle Left Upper Outer	Saloon FWD CNCD		Track Control Arm	S060802
	2013.01-2015.12	Front Axle Right Lower Inner	Estate FWD CNCD	for manufacturer:rear bush Ø65mm	Track Control Arm	S061602
	2013.01-2015.12	Front Axle Right Lower Inner	Estate FWD CNCD		Track Control Arm	S062177
	2013.01-2015.12	Front Axle Right Upper Inner	Estate FWD CNCD		Track Control Arm	S060805
	2013.01-2015.12	Front Axle Right Upper Inner	Saloon FWD CNCD		Track Control Arm	S060805
	2013.01-2015.12	Front Axle Right Lower Outer	Estate FWD CNCD		Track Control Arm	S062025
	2013.01-2015.12	Front Axle Right Upper Outer	Estate FWD CNCD		Track Control Arm	S060803
	2013.01-2015.12	Front Axle Right Upper Outer	Saloon FWD CNCD		Track Control Arm	S060803
	2013.01-2015.12	Rear Axle Left Upper	Estate FWD CNCD		Track Control Arm	S061397
	2013.01-2015.12	Rear Axle Left Upper	Saloon FWD CNCD		Track Control Arm	S061397
	2013.01-2015.12	Rear Axle Left Lower Inner	Estate FWD CNCD		Track Control Arm	S061574
	2013.01-2015.12	Rear Axle Left Lower Outer	Estate FWD CNCD		Track Control Arm	S062748



	 YEAR	FITTING POSITION	BODY STYLE & DRIVE TYPE & ENGINE	REMARKS	PRODUCT	GSP Ref.	
AUDI A4 2.0 (165 kw)	2013.01-2015.12	Rear Axle Left Lower Outer	Saloon FWD CNCD		Track Control Arm	S062748	
	2013.01-2015.12	Rear Axle Right Upper	Estate FWD CNCD		Track Control Arm	S061398	
	2013.01-2015.12	Rear Axle Right Upper	Saloon FWD CNCD		Track Control Arm	S061398	
	2013.01-2015.12	Rear Axle Right Lower Inner	Estate FWD CNCD		Track Control Arm	S061575	
	2013.01-2015.12	Rear Axle Right Lower Outer	Estate FWD CNCD		Track Control Arm	S062749	
	2013.01-2015.12	Rear Axle Right Lower Outer	Saloon FWD CNCD		Track Control Arm	S062749	
	2013.01-2015.12	Rear Axle Left & Right Lower Inner	Estate FWD CNCD		Track Control Arm	S062964	
	2013.01-2015.12	Rear Axle Left & Right Lower Inner	Saloon FWD CNCD		Track Control Arm	S062964	
	2013.01-2015.12	Front Axle Left & Right Lower Outer	Estate FWD CNCD		Ball Joint	S080987	
	2013.01-2015.12	Front Axle Left & Right Lower Outer	Saloon FWD CNCD		Ball Joint	S080987	
	2013.01-2015.12	Front Axle Left & Right Upper	Estate FWD CNCD		Control Arm Bushing	510136	
	2013.01-2015.12	Front Axle Left & Right Upper	Saloon FWD CNCD		Control Arm Bushing	510136	
	2013.01-2015.12	Front Axle Left & Right Lower Inner	Estate FWD CNCD		Control Arm Bushing	531929	
	2013.01-2015.12	Front Axle Left & Right Lower Inner	Saloon FWD CNCD		Control Arm Bushing	531929	
	2013.01-2015.12	Front Axle Left & Right Lower Inner	Estate FWD CNCD		Control Arm Bushing	531931	
	2013.01-2015.12	Front Axle Left & Right Lower Inner	Saloon FWD CNCD		Control Arm Bushing	531931	
	2013.01-2015.12	Front Axle Left & Right Lower Outer	Estate FWD CNCD		Control Arm Bushing	510299	
	2013.01-2015.12	Front Axle Left & Right Lower Outer	Saloon FWD CNCD		Control Arm Bushing	510299	
	2013.01-2015.12	Front Axle Left & Right Lower Outer	Estate FWD CNCD		Control Arm Bushing	530215	
	2013.01-2015.12	Front Axle Left & Right Lower Outer	Saloon FWD CNCD		Control Arm Bushing	530215	
	2013.01-2015.12	Rear Axle Left & Right Lower Inner	Estate FWD CNCD		Control Arm Bushing	533477	
	2013.01-2015.12	Rear Axle Left & Right Lower Inner	Saloon FWD CNCD		Control Arm Bushing	533477	
	2013.01-2015.12	Front Axle Left & Right	Estate FWD CNCD		Tie Rod Axle Joint	S030342	
	2013.01-2015.12	Front Axle Left & Right	Saloon FWD CNCD		Tie Rod Axle Joint	S030342	
	2013.01-2015.12	Front Axle Left	Estate FWD CNCD		Tie Rod End	S070024	
	2013.01-2015.12	Front Axle Left	Saloon FWD CNCD		Tie Rod End	S070024	
	2013.01-2015.12	Front Axle Right	Estate FWD CNCD		Tie Rod End	S070025	
	2013.01-2015.12	Front Axle Right	Saloon FWD CNCD		Tie Rod End	S070025	
	2013.01-2015.12	Front Axle Left & Right	Estate FWD CNCD	Aluminum Material	Rod/Strut, stabiliser	S050473	
	2013.01-2015.12	Front Axle Left & Right	Saloon FWD CNCD	Aluminum Material	Rod/Strut, stabiliser	S050473	
	2013.01-2015.12	Front Axle Left & Right	Estate FWD CNCD	<small>Not for country-spec.model Flavia, Not for country-spec.model Banaia</small>	Rod/Strut, stabiliser	S051258	
	2013.01-2015.12	Front Axle Left & Right	Saloon FWD CNCD	<small>Not for country-spec.model Flavia, Not for country-spec.model Banaia</small>	Rod/Strut, stabiliser	S051258	
	2013.01-2015.12	Rear Axle Left & Right	Estate FWD CNCD		Rod/Strut, stabiliser	S050472	
	2013.01-2015.12	Rear Axle Left & Right	Saloon FWD CNCD		Rod/Strut, stabiliser	S050472	
	2013.01-2015.12	Front Axle	Estate FWD CNCD		Stabiliser Bushing	510138	
	2013.01-2015.12	Front Axle	Saloon FWD CNCD		Stabiliser Bushing	510138	
	2013.01-2015.12	Front Axle	Estate FWD CNCD	for PR no.:1BA	Stabiliser Bushing	532578	
	2013.01-2015.12	Front Axle	Saloon FWD CNCD	for PR no.:1BA/1BL/1BR	Stabiliser Bushing	532578	
	2.4 (125 kw)	2001.07-2004.10	Front Axle Left Lower Inner	Saloon FWD BDV		Track Control Arm	S060055
		2001.07-2004.10	Front Axle Left Upper Inner	Saloon FWD BDV		Track Control Arm	S062331
		2001.07-2004.10	Front Axle Left Upper Outer	Saloon FWD BDV		Track Control Arm	S060048
		2001.07-2004.10	Front Axle Left Upper Outer	Saloon FWD BDV	<small>for vehicles with sports suspension.For PR no.:1BV</small>	Track Control Arm	S060798
2001.07-2004.10		Front Axle Left Upper Outer	Saloon FWD BDV	not For PR no.:1BV	Track Control Arm	S062530	
2001.07-2004.10		Front Axle Right Lower Inner	Saloon FWD BDV		Track Control Arm	S060056	
2001.07-2004.10		Front Axle Right Upper Inner	Saloon FWD BDV	<small>for vehicles with sports suspension</small>	Track Control Arm	S060801	
2001.07-2004.10		Front Axle Right Upper Inner	Saloon FWD BDV	not for PR no.:1BV	Track Control Arm	S062332	
2001.07-2004.10		Front Axle Right Upper Outer	Saloon FWD BDV		Track Control Arm	S060049	
2001.07-2004.10		Front Axle Right Upper Outer	Saloon FWD BDV	<small>for vehicles with sports suspension.For PR no.:1BV</small>	Track Control Arm	S060799	
2001.07-2004.10		Front Axle Right Upper Outer	Saloon FWD BDV	not For PR no.:1BV	Track Control Arm	S062531	
2001.07-2004.10		Front Axle Left & Right Lower Outer	Saloon FWD BDV		Track Control Arm	S060047	
2001.07-2004.10		Rear Axle Left & Right Lower Outer	Saloon FWD BDV		Track Control Arm	S062965	
2001.07-2004.10		Front Axle Left & Right Upper	Saloon FWD BDV		Control Arm Bushing	510136	
2001.07-2004.10		Front Axle Left & Right Lower Inner	Saloon FWD BDV		Control Arm Bushing	510287	
2001.07-2004.10		Front Axle Left & Right Lower Outer	Saloon FWD BDV		Control Arm Bushing	510134	
2001.07-2004.10		Rear Axle Left & Right Upper	Saloon FWD BDV		Control Arm Bushing	517141	
2001.07-2004.10		Rear Axle Left & Right Lower Outer	Saloon FWD BDV		Control Arm Bushing	510393	
2001.07-2004.10		Rear Axle Left & Right Lower Outer	Saloon FWD BDV		Control Arm Bushing	510394	
2001.07-2004.10		Front Axle	Saloon FWD BDV		Suspension Repair Kit	S990008SK	
2001.07-2004.10		Front Axle Left & Right	Saloon FWD BDV		Tie Rod Axle Joint	S030013	
2001.07-2004.10		Front Axle Left & Right	Saloon FWD BDV	<small>for vehicles with sports suspension.For PR no.:1BV</small>	Tie Rod End	S070016	
2001.07-2004.10		Front Axle Left & Right	Saloon FWD BDV	not For PR no.:1BV	Tie Rod End	S070038	
2001.07-2004.10		Front Axle Left	Saloon FWD BDV		Rod/Strut, stabiliser	520523	
2001.07-2004.10		Front Axle Right	Saloon FWD BDV		Rod/Strut, stabiliser	520524	
2001.07-2004.10		Rear Axle Left & Right	Saloon FWD BDV		Rod/Strut, stabiliser	S050042	



	 YEAR	FITTING POSITION	BODY STYLE & DRIVE TYPE & ENGINE	REMARKS	PRODUCT	GSP Ref.	
AUDI A4							
2.4 (125 kw)	2001.07-2004.10	Front Axle	Saloon FWD BDV	Stabiliser Ø:27 mm	Stabiliser Bushing	510139	
	2001.07-2004.10	Front Axle	Saloon FWD BDV		Stabiliser Bushing	517806	
	2001.07-2004.10	Rear Axle	Saloon FWD BDV	for PR number:1BA;for PR number:1BR	Stabiliser Bushing	517807	
2.8 (128 kw)	1994.11-1997.07	Front Axle Left Lower Inner	Saloon FWD AAH		Track Control Arm	S060055	
	1994.11-1997.07	Front Axle Left Upper Inner	Saloon FWD AAH	Engine code:AAH,Chassis no. to:8D-V-152 087	Track Control Arm	S060021	
	1994.11-1997.07	Front Axle Left Upper Inner	Saloon FWD AAH	for vehicles with sports suspension	Track Control Arm	S062331	
	1994.11-1997.07	Front Axle Left Upper Outer	Saloon FWD AAH		Track Control Arm	S060048	
	1994.11-1997.07	Front Axle Left Upper Outer	Saloon FWD AAH		Track Control Arm	S060798	
	1994.11-1997.07	Front Axle Left Upper Outer	Saloon FWD AAH		Track Control Arm	S062530	
	1994.11-1997.07	Front Axle Right Lower Inner	Saloon FWD AAH		Track Control Arm	S060056	
	1994.11-1997.07	Front Axle Right Upper Inner	Saloon FWD AAH	Engine code:AAH,Chassis no. to:8D-V-152 087	Track Control Arm	S060022	
	1994.11-1997.07	Front Axle Right Upper Inner	Saloon FWD AAH	for vehicles with sports suspension	Track Control Arm	S060801	
	1994.11-1997.07	Front Axle Right Upper Inner	Saloon FWD AAH	for vehicles with sports suspension	Track Control Arm	S062332	
	1994.11-1997.07	Front Axle Right Upper Outer	Saloon FWD AAH		Track Control Arm	S060049	
	1994.11-1997.07	Front Axle Right Upper Outer	Saloon FWD AAH		Track Control Arm	S062531	
	1994.11-1997.07	Front Axle Left & Right Lower Outer	Saloon FWD AAH		Track Control Arm	S060054	
	1994.11-1997.07	Front Axle Left & Right Upper	Saloon FWD AAH		Control Arm Bushing	510136	
	1994.11-1997.07	Front Axle Left & Right Lower Inner	Saloon FWD AAH		Control Arm Bushing	510135	
	1994.11-1997.07	Front Axle Left & Right Lower Inner	Saloon FWD AAH		Control Arm Bushing	510287	
	1994.11-1997.07	Front Axle Left & Right Lower Outer	Saloon FWD AAH		Control Arm Bushing	510133	
	1994.11-1997.07	Front Axle Left & Right Lower Outer	Saloon FWD AAH		Control Arm Bushing	510134	
	1994.11-1997.07	Front Axle Left & Right	Saloon FWD AAH		Rod Assembly	S100014	
	1994.11-1997.07	Front Axle Left & Right	Saloon FWD AAH		Tie Rod End	S070038	
	1994.11-1997.07	Front Axle Left	Saloon FWD AAH	Engine Code:AAH	Rod/Strut,stabiliser	520008	
	1994.11-1997.07	Front Axle Left	Saloon FWD AAH	Engine code:AAH	Rod/Strut,stabiliser	S050034	
	1994.11-1997.07	Front Axle Right	Saloon FWD AAH	Engine Code:AAH	Rod/Strut,stabiliser	520010	
	1994.11-1997.07	Front Axle Right	Saloon FWD AAH	Engine code:AAH	Rod/Strut,stabiliser	S050033	
	1994.11-1997.07	Front Axle Left & Right	Saloon FWD AAH		Rod/Strut,stabiliser	S050032	
	1994.11-1997.07	Rear Axle Left	Saloon FWD AAH		Rod/Strut,stabiliser	S050030	
	1994.11-1997.07	Rear Axle Right	Saloon FWD AAH		Rod/Strut,stabiliser	S050031	
	1994.11-1997.07	Front Axle	Saloon FWD AAH		Stabiliser Bushing	510138	
	1994.11-1997.07	Front Axle	Saloon FWD AAH		Stabiliser Bushing	510139	
	1994.11-1997.07	Front Axle	Saloon FWD AAH		Stabiliser Bushing	517806	
	1994.11-1997.07	Front Axle Left	Saloon FWD AAH		Steering Boot	540043	
	1994.11-1997.07	Front Axle Left	Saloon FWD AAH		Steering Rack Bellow Kit	540043S	
	3.0 (160 kw)	2001.04-2004.10	Front Axle Left Lower Inner	Saloon FWD BBJ		Track Control Arm	S060055
2001.04-2004.10		Front Axle Left Upper Inner	Saloon FWD BBJ		Track Control Arm	S062331	
2001.04-2004.10		Front Axle Left Upper Outer	Saloon FWD BBJ		Track Control Arm	S060048	
2001.04-2004.10		Front Axle Left Upper Outer	Saloon FWD BBJ	for vehicles with sports suspension;For PR no.:1BV	Track Control Arm	S060798	
2001.04-2004.10		Front Axle Left Upper Outer	Saloon FWD BBJ	not For PR no.:1BV	Track Control Arm	S062530	
2001.04-2004.10		Front Axle Right Lower Inner	Saloon FWD BBJ		Track Control Arm	S060056	
2001.04-2004.10		Front Axle Right Upper Inner	Saloon FWD BBJ	for vehicles with sports suspension	Track Control Arm	S060801	
2001.04-2004.10		Front Axle Right Upper Inner	Saloon FWD BBJ	not for PR no.:1BV	Track Control Arm	S062332	
2001.04-2004.10		Front Axle Right Upper Outer	Saloon FWD BBJ		Track Control Arm	S060049	
2001.04-2004.10		Front Axle Right Upper Outer	Saloon FWD BBJ	For Vehicles With Sports Suspension;For PR no.:1BV	Track Control Arm	S060799	
2001.04-2004.10		Front Axle Right Upper Outer	Saloon FWD BBJ	not For PR no.:1BV	Track Control Arm	S062531	
2001.04-2004.10		Front Axle Left & Right Lower Outer	Saloon FWD BBJ		Track Control Arm	S060047	
2001.04-2004.10		Rear Axle Left & Right Lower Outer	Saloon FWD BBJ		Track Control Arm	S062965	
2001.04-2004.10		Front Axle Left & Right Upper	Saloon FWD BBJ		Control Arm Bushing	510136	
2001.04-2004.10		Front Axle Left & Right Lower Inner	Saloon FWD BBJ		Control Arm Bushing	510287	
2001.04-2004.10		Front Axle Left & Right Lower Outer	Saloon FWD BBJ		Control Arm Bushing	510134	
2001.04-2004.10		Rear Axle Left & Right Upper	Saloon FWD BBJ		Control Arm Bushing	517141	
2001.04-2004.10		Rear Axle Left & Right Lower Outer	Saloon FWD BBJ		Control Arm Bushing	510393	
2001.04-2004.10		Front Axle	Saloon FWD BBJ		Suspension Repair Kit	S990008SK	
2001.04-2004.10		Front Axle Left & Right	Saloon FWD BBJ		Tie Rod Axle Joint	S030013	
2001.04-2004.10		Front Axle Left & Right	Saloon FWD BBJ	for vehicles with sports suspension;For PR no.:1BV	Tie Rod End	S070016	
2001.04-2004.10		Front Axle Left & Right	Saloon FWD BBJ	not For PR no.:1BV	Tie Rod End	S070038	
2001.04-2004.10		Front Axle Left	Saloon FWD BBJ		Rod/Strut,stabiliser	520523	
2001.04-2004.10		Front Axle Right	Saloon FWD BBJ		Rod/Strut,stabiliser	520524	
2001.04-2004.10		Rear Axle Left & Right	Saloon FWD BBJ		Rod/Strut,stabiliser	S050042	
2001.04-2004.10		Front Axle	Saloon FWD BBJ	Stabiliser Ø:27 mm	Stabiliser Bushing	510139	
2001.04-2004.10		Front Axle	Saloon FWD BBJ		Stabiliser Bushing	517806	
2001.04-2004.10		Rear Axle	Saloon FWD BBJ	for PR number:1BA;for PR number:1BR	Stabiliser Bushing	517807	
2004.11-2006.02		Front Axle Left Lower Inner	Estate FWD BBJ			Track Control Arm	S060026



	 YEAR	FITTING POSITION	BODY STYLE & DRIVE TYPE & ENGINE	REMARKS	PRODUCT	GSP Ref.
AUDI						
A4						
3.0 (160 kw)	2004.11-2006.02	Front Axle Left Lower Inner	Saloon FWD BBJ		Track Control Arm	S060026
	2004.11-2006.02	Front Axle Left Upper Outer	Estate FWD BBJ		Track Control Arm	S060798
	2004.11-2006.02	Front Axle Right Lower Inner	Estate FWD BBJ		Track Control Arm	S060027
	2004.11-2006.02	Front Axle Right Upper Inner	Estate FWD BBJ		Track Control Arm	S060801
	2004.11-2006.02	Front Axle Right Upper Inner	Saloon FWD BBJ		Track Control Arm	S060801
	2004.11-2006.02	Front Axle Right Upper Outer	Estate FWD BBJ		Track Control Arm	S060799
	2004.11-2006.02	Front Axle Left & Right Lower Outer	Estate FWD BBJ		Track Control Arm	S060047
	2004.11-2006.02	Front Axle Left & Right Lower Outer	Saloon FWD BBJ		Track Control Arm	S060047
	2004.11-2006.02	Rear Axle Left & Right Lower Outer	Estate FWD BBJ		Track Control Arm	S062965
	2004.11-2006.02	Front Axle Left & Right Upper	Estate FWD BBJ		Control Arm Bushing	510136
	2004.11-2006.02	Front Axle Left & Right Lower Inner	Estate FWD BBJ		Control Arm Bushing	510287
	2004.11-2006.02	Front Axle Left & Right Lower Inner	Estate FWD BBJ		Control Arm Bushing	510301
	2004.11-2006.02	Front Axle Left & Right Lower Outer	Estate FWD BBJ		Control Arm Bushing	510134
	2004.11-2006.02	Rear Axle Left & Right Upper	Estate FWD BBJ		Control Arm Bushing	517141
	2004.11-2006.02	Rear Axle Left & Right Lower Outer	Estate FWD BBJ		Control Arm Bushing	510393
	2004.11-2006.02	Front Axle	Estate FWD BBJ		Suspension Repair Kit	S990008SK
	2004.11-2006.02	Front Axle Left & Right	Estate FWD BBJ		Tie Rod Axle Joint	S030013
	2004.11-2006.02	Front Axle Left & Right	Estate FWD BBJ		Tie Rod End	S070016
	2004.11-2006.02	Front Axle Left	Estate FWD BBJ		Rod/Strut,stabiliser	520523
	2004.11-2006.02	Front Axle Left	Saloon FWD BBJ		Rod/Strut,stabiliser	520523
	2004.11-2006.02	Front Axle Right	Estate FWD BBJ		Rod/Strut,stabiliser	520524
	2004.11-2006.02	Front Axle Right	Saloon FWD BBJ		Rod/Strut,stabiliser	520524
	2004.11-2006.02	Rear Axle Left & Right	Estate FWD BBJ		Rod/Strut,stabiliser	S050042
	2004.11-2006.02	Rear Axle Left & Right	Saloon FWD BBJ		Rod/Strut,stabiliser	S050042
	2004.11-2006.02	Front Axle	Estate FWD BBJ		Stabiliser Bushing	510138
	2004.11-2006.02	Front Axle	Saloon FWD BBJ	Stabiliser Ø:25 mm	Stabiliser Bushing	510138
	2004.11-2006.02	Front Axle	Estate FWD BBJ		Stabiliser Bushing	510139
	2004.11-2006.02	Front Axle	Saloon FWD BBJ	Stabiliser Ø:27 mm	Stabiliser Bushing	510139
	2004.11-2006.02	Front Axle	Estate FWD BBJ		Stabiliser Bushing	517806
	2004.11-2006.02	Front Axle	Saloon FWD BBJ		Stabiliser Bushing	517806
	2004.11-2006.02	Rear Axle	Estate FWD BBJ		Stabiliser Bushing	517807
	2004.11-2006.02	Rear Axle	Saloon FWD BBJ		Stabiliser Bushing	517807
3.2 (188 kw)	2004.11-2007.10	Front Axle Left Lower Inner	Saloon FWD AUK		Track Control Arm	S060026
	2004.11-2007.10	Front Axle Left Upper Outer	Saloon FWD AUK		Track Control Arm	S060798
	2004.11-2007.10	Front Axle Right Lower Inner	Saloon FWD AUK		Track Control Arm	S060027
	2004.11-2007.10	Front Axle Right Upper Inner	Saloon FWD AUK		Track Control Arm	S060801
	2004.11-2007.10	Front Axle Right Upper Outer	Saloon FWD AUK		Track Control Arm	S060799
	2004.11-2007.10	Front Axle Left & Right Lower Outer	Saloon FWD AUK		Track Control Arm	S060047
	2004.11-2007.10	Rear Axle Left & Right Lower Outer	Saloon FWD AUK		Track Control Arm	S062965
	2004.11-2007.10	Front Axle Left & Right Upper	Saloon FWD AUK		Control Arm Bushing	510136
	2004.11-2007.10	Front Axle Left & Right Lower Inner	Saloon FWD AUK		Control Arm Bushing	510287
	2004.11-2007.10	Front Axle Left & Right Lower Inner	Saloon FWD AUK		Control Arm Bushing	510301
	2004.11-2007.10	Front Axle Left & Right Lower Outer	Saloon FWD AUK		Control Arm Bushing	510134
	2004.11-2007.10	Rear Axle Left & Right Upper	Saloon FWD AUK		Control Arm Bushing	517141
	2004.11-2007.10	Rear Axle Left & Right Lower Outer	Saloon FWD AUK		Control Arm Bushing	510393
	2004.11-2007.10	Front Axle Left & Right	Saloon FWD AUK		Tie Rod Axle Joint	S030013
	2004.11-2007.10	Front Axle Left & Right	Saloon FWD AUK		Tie Rod End	S070016
	2004.11-2007.10	Front Axle Left	Saloon FWD AUK		Rod/Strut,stabiliser	520523
	2004.11-2007.10	Front Axle Right	Saloon FWD AUK		Rod/Strut,stabiliser	520524
	2004.11-2007.10	Rear Axle Left & Right	Saloon FWD AUK		Rod/Strut,stabiliser	S050042
	2004.11-2007.10	Front Axle	Saloon FWD AUK	Stabiliser Ø:25 mm	Stabiliser Bushing	510138
	2004.11-2007.10	Front Axle	Saloon FWD AUK	Stabiliser Ø:27 mm	Stabiliser Bushing	510139
	2004.11-2007.10	Front Axle	Saloon FWD AUK		Stabiliser Bushing	517806
	2004.11-2007.10	Rear Axle	Saloon FWD AUK		Stabiliser Bushing	517807
	2004.11-2008.03	Front Axle Left Lower Inner	Estate FWD AUK		Track Control Arm	S060026
	2004.11-2008.03	Front Axle Left Upper Outer	Estate FWD AUK		Track Control Arm	S060798
	2004.11-2008.03	Front Axle Right Lower Inner	Estate FWD AUK		Track Control Arm	S060027
	2004.11-2008.03	Front Axle Right Upper Inner	Estate FWD AUK		Track Control Arm	S060801
	2004.11-2008.03	Front Axle Right Upper Outer	Estate FWD AUK		Track Control Arm	S060799
	2004.11-2008.03	Front Axle Left & Right Lower Outer	Estate FWD AUK		Track Control Arm	S060047
	2004.11-2008.03	Rear Axle Left & Right Lower Outer	Estate FWD AUK		Track Control Arm	S062965
	2004.11-2008.03	Front Axle Left & Right Upper	Estate FWD AUK		Control Arm Bushing	510136
	2004.11-2008.03	Front Axle Left & Right Lower Inner	Estate FWD AUK		Control Arm Bushing	510287
	2004.11-2008.03	Front Axle Left & Right Lower Inner	Estate FWD AUK		Control Arm Bushing	510301



	 YEAR	FITTING POSITION	BODY STYLE & DRIVE TYPE & ENGINE	REMARKS	PRODUCT	GSP Ref.
AUDI						
A4						
3.2 (188 kw)	2004.11-2008.03	Front Axle Left & Right Lower Outer	Estate FWD AUK		Control Arm Bushing	510134
	2004.11-2008.03	Rear Axle Left & Right Upper	Estate FWD AUK		Control Arm Bushing	517141
	2004.11-2008.03	Rear Axle Left & Right Lower Outer	Estate FWD AUK		Control Arm Bushing	510393
	2004.11-2008.03	Front Axle Left & Right	Estate FWD AUK		Tie Rod Axle Joint	S030013
	2004.11-2008.03	Front Axle Left & Right	Estate FWD AUK		Tie Rod End	S070016
	2004.11-2008.03	Front Axle Left	Estate FWD AUK		Rod/Strut,stabiliser	520523
	2004.11-2008.03	Front Axle Right	Estate FWD AUK		Rod/Strut,stabiliser	520524
	2004.11-2008.03	Rear Axle Left & Right	Estate FWD AUK		Rod/Strut,stabiliser	S050042
	2004.11-2008.03	Front Axle	Estate FWD AUK		Stabiliser Bushing	510138
	2004.11-2008.03	Front Axle	Estate FWD AUK		Stabiliser Bushing	510139
	2004.11-2008.03	Front Axle	Estate FWD AUK		Stabiliser Bushing	517806
	2004.11-2008.03	Rear Axle	Estate FWD AUK		Stabiliser Bushing	517807
A4 Cabrio						
3.0 (160 kw)	2002.04-2005.12	Front Axle Left Lower Inner	Cabriolet FWD BBJ		Track Control Arm	S060055
	2002.04-2005.12	Front Axle Left Upper Inner	Cabriolet FWD BBJ		Track Control Arm	S062331
	2002.04-2005.12	Front Axle Left Upper Outer	Cabriolet FWD BBJ		Track Control Arm	S060048
	2002.04-2005.12	Front Axle Left Upper Outer	Cabriolet FWD BBJ	Chassis no. from:8H-5-014 476,For PR no.:1BA11BE/For PR no.:18111BE	Track Control Arm	S060798
	2002.04-2005.12	Front Axle Left Upper Outer	Cabriolet FWD BBJ	Chassis no. to:8H-5-014 475,For PR no.:1BA11BE	Track Control Arm	S062530
	2002.04-2005.12	Front Axle Right Lower Inner	Cabriolet FWD BBJ		Track Control Arm	S060056
	2002.04-2005.12	Front Axle Right Upper Inner	Cabriolet FWD BBJ	for vehicles with sports suspension	Track Control Arm	S060801
	2002.04-2005.12	Front Axle Right Upper Inner	Cabriolet FWD BBJ	Chassis no. to:8H-5-014 475,For PR no.:1BA11BE	Track Control Arm	S062332
	2002.04-2005.12	Front Axle Right Upper Outer	Cabriolet FWD BBJ		Track Control Arm	S060049
	2002.04-2005.12	Front Axle Right Upper Outer	Cabriolet FWD BBJ	Chassis no. from:8H-5-014 476,For PR no.:1BA11BE/For PR no.:18111BE	Track Control Arm	S060799
	2002.04-2005.12	Front Axle Right Upper Outer	Cabriolet FWD BBJ	Chassis no. to:8H-5-014 475,For PR no.:1BA11BE	Track Control Arm	S062531
	2002.04-2005.12	Front Axle Left & Right Lower Outer	Cabriolet FWD BBJ		Track Control Arm	S060047
	2002.04-2005.12	Rear Axle Left & Right Lower Outer	Cabriolet FWD BBJ		Track Control Arm	S062965
	2002.04-2005.12	Front Axle Left & Right Upper	Cabriolet FWD BBJ		Control Arm Bushing	510136
	2002.04-2005.12	Front Axle Left & Right Lower Inner	Cabriolet FWD BBJ		Control Arm Bushing	510287
	2002.04-2005.12	Front Axle Left & Right Lower Outer	Cabriolet FWD BBJ		Control Arm Bushing	510134
	2002.04-2005.12	Rear Axle Left & Right Upper	Cabriolet FWD BBJ		Control Arm Bushing	517141
	2002.04-2005.12	Front Axle	Cabriolet FWD BBJ		Suspension Repair Kit	S990008SK
	2002.04-2005.12	Front Axle Left & Right	Cabriolet FWD BBJ		Tie Rod Axle Joint	S030013
	2002.04-2005.12	Front Axle Left & Right	Cabriolet FWD BBJ	Chassis no. from:8H-5-014 477	Tie Rod End	S070016
	2002.04-2005.12	Front Axle Left & Right	Cabriolet FWD BBJ	Chassis no. to:8H-5-014 476	Tie Rod End	S070038
	2002.04-2005.12	Front Axle Left	Cabriolet FWD BBJ		Rod/Strut,stabiliser	520523
	2002.04-2005.12	Front Axle Right	Cabriolet FWD BBJ		Rod/Strut,stabiliser	520524
	2002.04-2005.12	Rear Axle Left & Right	Cabriolet FWD BBJ		Rod/Strut,stabiliser	S050042
	2002.04-2005.12	Front Axle	Cabriolet FWD BBJ		Stabiliser Bushing	517806
	2002.04-2005.12	Rear Axle	Cabriolet FWD BBJ	For OE No. 4B0511327	Stabiliser Bushing	517807
3.2 (188 kw)	2006.01-2009.03	Front Axle Left Lower Inner	Cabriolet FWD AUK		Track Control Arm	S060026
	2006.01-2009.03	Front Axle Left Upper Outer	Cabriolet FWD AUK		Track Control Arm	S060048
	2006.01-2009.03	Front Axle Left Upper Outer	Cabriolet FWD AUK		Track Control Arm	S060798
	2006.01-2009.03	Front Axle Right Lower Inner	Cabriolet FWD AUK		Track Control Arm	S060027
	2006.01-2009.03	Front Axle Right Upper Inner	Cabriolet FWD AUK		Track Control Arm	S060801
	2006.01-2009.03	Front Axle Right Upper Outer	Cabriolet FWD AUK		Track Control Arm	S060049
	2006.01-2009.03	Front Axle Right Upper Outer	Cabriolet FWD AUK		Track Control Arm	S060799
	2006.01-2009.03	Front Axle Left & Right Lower Outer	Cabriolet FWD AUK		Track Control Arm	S060047
	2006.01-2009.03	Rear Axle Left & Right Lower Outer	Cabriolet FWD AUK		Track Control Arm	S062965
	2006.01-2009.03	Front Axle Left & Right Upper	Cabriolet FWD AUK		Control Arm Bushing	510136
	2006.01-2009.03	Front Axle Left & Right Lower Inner	Cabriolet FWD AUK		Control Arm Bushing	510301
	2006.01-2009.03	Front Axle Left & Right Lower Outer	Cabriolet FWD AUK		Control Arm Bushing	510134
	2006.01-2009.03	Rear Axle Left & Right Upper	Cabriolet FWD AUK		Control Arm Bushing	517141
	2006.01-2009.03	Rear Axle Left & Right Lower Outer	Cabriolet FWD AUK		Control Arm Bushing	510393
	2006.01-2009.03	Front Axle Left & Right	Cabriolet FWD AUK		Tie Rod Axle Joint	S030013
	2006.01-2009.03	Front Axle Left & Right	Cabriolet FWD AUK		Tie Rod End	S070016
	2006.01-2009.03	Front Axle Left	Cabriolet FWD AUK		Rod/Strut,stabiliser	520523
	2006.01-2009.03	Front Axle Right	Cabriolet FWD AUK		Rod/Strut,stabiliser	520524
	2006.01-2009.03	Rear Axle Left & Right	Cabriolet FWD AUK		Rod/Strut,stabiliser	S050042
	2006.01-2009.03	Front Axle	Cabriolet FWD AUK		Stabiliser Bushing	517806
	2006.01-2009.03	Rear Axle	Cabriolet FWD AUK	For OE No. 4B0511327	Stabiliser Bushing	517807
A4 Quattro						
2.0 (147 kw)	2004.11-2008.06	Front Axle Left Lower Inner	Saloon 4WD BGB/BWE/BWT		Track Control Arm	S060026
	2004.11-2008.06	Front Axle Left Upper Outer	Saloon 4WD BGB/BWE/BWT		Track Control Arm	S060798
	2004.11-2008.06	Front Axle Right Lower Inner	Saloon 4WD BGB/BWE/BWT		Track Control Arm	S060027



	 YEAR	FITTING POSITION	BODY STYLE & DRIVE TYPE & ENGINE	REMARKS	PRODUCT	GSP Ref.
AUDI						
A4 Quattro						
2.0 (147 kw)	2004.11-2008.06	Front Axle Right Upper Inner	Saloon 4WD BGB/BWE/BWT		Track Control Arm	S060801
	2004.11-2008.06	Front Axle Right Upper Outer	Saloon 4WD BGB/BWE/BWT		Track Control Arm	S060799
	2004.11-2008.06	Front Axle Left & Right Lower Outer	Saloon 4WD BGB/BWE/BWT		Track Control Arm	S060047
	2004.11-2008.06	Rear Axle Left & Right Lower Outer	Saloon 4WD BGB/BWE/BWT		Track Control Arm	S062965
	2004.11-2008.06	Front Axle Left & Right Upper	Saloon 4WD BGB/BWE/BWT		Control Arm Bushing	510136
	2004.11-2008.06	Front Axle Left & Right Lower Inner	Saloon 4WD BGB/BWE/BWT		Control Arm Bushing	510287
	2004.11-2008.06	Front Axle Left & Right Lower Inner	Saloon 4WD BGB/BWE/BWT		Control Arm Bushing	510301
	2004.11-2008.06	Front Axle Left & Right Lower Outer	Saloon 4WD BGB/BWE/BWT		Control Arm Bushing	510134
	2004.11-2008.06	Rear Axle Left & Right Upper	Saloon 4WD BGB/BWE/BWT		Control Arm Bushing	517141
	2004.11-2008.06	Front Axle Left & Right	Saloon 4WD BGB/BWE/BWT		Tie Rod Axle Joint	S030013
	2004.11-2008.06	Front Axle Left & Right	Saloon 4WD BGB/BWE/BWT		Tie Rod End	S070016
	2004.11-2008.06	Front Axle Left	Saloon 4WD BGB/BWE/BWT		Rod/Strut, stabiliser	520523
	2004.11-2008.06	Front Axle Right	Saloon 4WD BGB/BWE/BWT		Rod/Strut, stabiliser	520524
	2004.11-2008.06	Rear Axle Left & Right	Saloon 4WD BGB/BWE/BWT		Rod/Strut, stabiliser	S050042
	2004.11-2008.06	Front Axle	Saloon 4WD BGB/BWE/BWT	Stabiliser Ø:25 mm	Stabiliser Bushing	510138
	2004.11-2008.06	Front Axle	Saloon 4WD BGB/BWE/BWT	Stabiliser Ø:27 mm	Stabiliser Bushing	510139
	2004.11-2008.06	Front Axle	Saloon 4WD BGB/BWE/BWT		Stabiliser Bushing	517806
	2004.11-2008.06	Rear Axle	Saloon 4WD BGB/BWE/BWT		Stabiliser Bushing	517807
2.0 (185 kw)	2015.05-2019.11	Front Axle Left Upper Inner	Saloon 4WD CYMC/CYRB		Track Control Arm	S062930
	2015.05-2019.11	Front Axle Left Lower Outer	Saloon 4WD CYMC/CYRB		Track Control Arm	S062924
	2015.05-2019.11	Front Axle Left Upper Outer	Saloon 4WD CYMC/CYRB		Track Control Arm	S062928
	2015.05-2019.11	Front Axle Right Upper Inner	Saloon 4WD CYMC/CYRB		Track Control Arm	S062931
	2015.05-2019.11	Front Axle Right Lower Outer	Saloon 4WD CYMC/CYRB		Track Control Arm	S062925
	2015.05-2019.11	Front Axle Right Upper Outer	Saloon 4WD CYMC/CYRB		Track Control Arm	S062929
	2015.05-2019.11	Front Axle Left & Right Lower Outer	Saloon 4WD CYMC/CYRB		Ball Joint	S080987
	2015.05-2019.11	Front Axle Left & Right Upper	Saloon 4WD CYMC/CYRB		Control Arm Bushing	533522
	2015.05-2019.11	Front Axle Left & Right Lower Inner	Saloon 4WD CYMC/CYRB		Control Arm Bushing	531931
	2015.05-2019.11	Front Axle Left & Right Lower Outer	Saloon 4WD CYMC/CYRB		Control Arm Bushing	510299
	2015.05-2019.11	Front Axle Left & Right Lower Outer	Saloon 4WD CYMC/CYRB		Control Arm Bushing	530215
	2015.05-2019.11	Front Axle Left & Right	Saloon 4WD CYMC/CYRB		Tie Rod Axle Joint	S030931
	2015.05-2019.11	Front Axle Left	Saloon 4WD CYMC/CYRB		Tie Rod End	S071632
	2015.05-2019.11	Front Axle Right	Saloon 4WD CYMC/CYRB		Tie Rod End	S071634
	2015.05-2019.11	Front Axle Left & Right	Saloon 4WD CYMC/CYRB		Rod/Strut, stabiliser	S051258
	2015.05-2019.11	Rear Axle Left & Right	Saloon 4WD CYMC/CYRB		Rod/Strut, stabiliser	S051433
	2015.05-2019.11	Front Axle	Saloon 4WD CYMC/CYRB	for vehicles without sports suspension	Stabiliser Bushing	510138
	2015.05-2019.11	Front Axle	Saloon 4WD CYMC/CYRB	for vehicles with sports suspension	Stabiliser Bushing	532579
2.4 (121 kw)	1997.08-2000.10	Front Axle Left Lower Inner	Saloon 4WD AGA/ALF/AML/APS/ARJ		Track Control Arm	S060055
	1997.08-2000.10	Front Axle Left Upper Inner	Saloon 4WD AGA/ALF/AML/APS/ARJ	Chassis no. to:8D-V-152 087	Track Control Arm	S060021
	1997.08-2000.10	Front Axle Left Upper Inner	Saloon 4WD AGA/ALF/AML/APS/ARJ	Chassis no. from:8D-V-152 088 for vehicles without sports suspension not for PR no.:1BV	Track Control Arm	S062331
	1997.08-2000.10	Front Axle Left Upper Outer	Saloon 4WD AGA/ALF/AML/APS/ARJ		Track Control Arm	S060048
	1997.08-2000.10	Front Axle Left Upper Outer	Saloon 4WD AGA/ALF/AML/APS/ARJ	for vehicles with lowered suspension. For PR no.:1BV	Track Control Arm	S060798
	1997.08-2000.10	Front Axle Left Upper Outer	Saloon 4WD AGA/ALF/AML/APS/ARJ	Engine code AGA/ALF/Engine code AML/ARJ/APS not for PR no.:1BV	Track Control Arm	S062530
	1997.08-2000.10	Front Axle Right Lower Inner	Saloon 4WD AGA/ALF/AML/APS/ARJ		Track Control Arm	S060056
	1997.08-2000.10	Front Axle Right Upper Inner	Saloon 4WD AGA/ALF/AML/APS/ARJ	Chassis no. to:8D-V-152 087	Track Control Arm	S060022
	1997.08-2000.10	Front Axle Right Upper Inner	Saloon 4WD AGA/ALF/AML/APS/ARJ	for vehicles with sports suspension	Track Control Arm	S060801
	1997.08-2000.10	Front Axle Right Upper Inner	Saloon 4WD AGA/ALF/AML/APS/ARJ	Chassis no. from:8D-V-152 088 for vehicles without sports suspension not for PR no.:1BV	Track Control Arm	S062332
	1997.08-2000.10	Front Axle Right Upper Outer	Saloon 4WD AGA/ALF/AML/APS/ARJ		Track Control Arm	S060049
	1997.08-2000.10	Front Axle Right Upper Outer	Saloon 4WD AGA/ALF/AML/APS/ARJ	for vehicles with lowered suspension. For PR no.:1BV	Track Control Arm	S060799
	1997.08-2000.10	Front Axle Right Upper Outer	Saloon 4WD AGA/ALF/AML/APS/ARJ	Engine code AGA/ALF/Engine code AML/ARJ/APS not for PR no.:1BV	Track Control Arm	S062531
	1997.08-2000.10	Front Axle Left & Right Lower Outer	Saloon 4WD AGA/ALF/AML/APS/ARJ		Track Control Arm	S060054
	1997.08-2000.10	Front Axle Left & Right Upper	Saloon 4WD AGA/ALF/AML/APS/ARJ		Control Arm Bushing	510136
	1997.08-2000.10	Front Axle Left & Right Lower Inner	Saloon 4WD AGA/ALF/AML/APS/ARJ		Control Arm Bushing	510135
	1997.08-2000.10	Front Axle Left & Right Lower Inner	Saloon 4WD AGA/ALF/AML/APS/ARJ		Control Arm Bushing	510287
	1997.08-2000.10	Front Axle Left & Right Lower Outer	Saloon 4WD AGA/ALF/AML/APS/ARJ		Control Arm Bushing	510133
	1997.08-2000.10	Front Axle Left & Right Lower Outer	Saloon 4WD AGA/ALF/AML/APS/ARJ		Control Arm Bushing	510134
	1997.08-2000.10	Front Axle Left & Right	Saloon 4WD AGA/ALF/AML/APS/ARJ		Rod Assembly	S100014
	1997.08-2000.10	Front Axle Left & Right	Saloon 4WD AGA/ALF/AML/APS/ARJ	Engine code AML/ARJ/APS for vehicles with sports suspension. For PR no.:1BV	Tie Rod End	S070016
	1997.08-2000.10	Front Axle Left & Right	Saloon 4WD AGA/ALF/AML/APS/ARJ	not For PR no.:1BV	Tie Rod End	S070038
	1997.08-2000.10	Front Axle Left	Saloon 4WD AGA/ALF/AML/APS/ARJ		Rod/Strut, stabiliser	520008
	1997.08-2000.10	Front Axle Left	Saloon 4WD AGA/ALF/AML/APS/ARJ		Rod/Strut, stabiliser	S050034
	1997.08-2000.10	Front Axle Right	Saloon 4WD AGA/ALF/AML/APS/ARJ		Rod/Strut, stabiliser	520010
	1997.08-2000.10	Front Axle Right	Saloon 4WD AGA/ALF/AML/APS/ARJ		Rod/Strut, stabiliser	S050033
	1997.08-2000.10	Rear Axle Left	Saloon 4WD AGA/ALF/AML/APS/ARJ		Rod/Strut, stabiliser	S050030
	1997.08-2000.10	Rear Axle Right	Saloon 4WD AGA/ALF/AML/APS/ARJ		Rod/Strut, stabiliser	S050031



	 YEAR	FITTING POSITION	BODY STYLE & DRIVE TYPE & ENGINE	REMARKS	PRODUCT	GSP Ref.
AUDI						
A4 Quattro						
2.4 (121 kw)	1997.08-2000.10	Front Axle	Saloon 4WD AGA/ALF/AML/APS/ARJ	for vehicles without sports suspension	Stabiliser Bushing	510138
	1997.08-2000.10	Front Axle	Saloon 4WD AGA/ALF/AML/APS/ARJ		Stabiliser Bushing	510139
	1997.08-2000.10	Front Axle	Saloon 4WD AGA/ALF/AML/APS/ARJ		Stabiliser Bushing	517806
	1997.08-2000.10	Front Axle Left	Saloon 4WD AGA/ALF/AML/APS/ARJ		Steering Boot	540043
	1997.08-2000.10	Front Axle Left	Saloon 4WD AGA/ALF/AML/APS/ARJ	for vehicles with power steering,Date to:1096.10,VIN to:8D-J-053 000	Steering Rack Bellow Kit	540043S
	1997.08-2000.10	Front Axle Right	Saloon 4WD AGA/ALF/AML/APS/ARJ	for vehicles with steering damper,VIN to:8D-X-303 809	Steering Rack Bellow Kit	540211S
2.8 (142 kw)	1996.06-2001.08	Front Axle Left Lower Inner	Saloon 4WD ACK/ALG/AMX/APR/AQD		Track Control Arm	S060055
	1996.06-2001.08	Front Axle Left Upper Inner	Saloon 4WD ACK/ALG/AMX/APR/AQD	Chassis no. to:8D-V-152 087	Track Control Arm	S060021
	1996.06-2001.08	Front Axle Left Upper Inner	Saloon 4WD ACK/ALG/AMX/APR/AQD	Chassis no:8D01102 088,for vehicles without sports suspension,not For PR no.:1BV	Track Control Arm	S062331
	1996.06-2001.08	Front Axle Left Upper Outer	Saloon 4WD ACK/ALG/AMX/APR/AQD		Track Control Arm	S060048
	1996.06-2001.08	Front Axle Left Upper Outer	Saloon 4WD ACK/ALG/AMX/APR/AQD	for vehicles with lowered suspension,For PR no.:1BV	Track Control Arm	S060798
	1996.06-2001.08	Front Axle Left Upper Outer	Saloon 4WD ACK/ALG/AMX/APR/AQD	Engine code:AMV,ALG,ACK,Engine code:APR,ATD,AWA,ADD,not For PR no.:1BV	Track Control Arm	S062530
	1996.06-2001.08	Front Axle Right Lower Inner	Saloon 4WD ACK/ALG/AMX/APR/AQD		Track Control Arm	S060056
	1996.06-2001.08	Front Axle Right Upper Inner	Saloon 4WD ACK/ALG/AMX/APR/AQD	Chassis no. to:8D-V-152 087	Track Control Arm	S060022
	1996.06-2001.08	Front Axle Right Upper Inner	Saloon 4WD ACK/ALG/AMX/APR/AQD	for vehicles with sports suspension	Track Control Arm	S060801
	1996.06-2001.08	Front Axle Right Upper Inner	Saloon 4WD ACK/ALG/AMX/APR/AQD	Chassis no:8D01102 088,for vehicles without sports suspension,not For PR no.:1BV	Track Control Arm	S062332
	1996.06-2001.08	Front Axle Right Upper Outer	Saloon 4WD ACK/ALG/AMX/APR/AQD		Track Control Arm	S060049
	1996.06-2001.08	Front Axle Right Upper Outer	Saloon 4WD ACK/ALG/AMX/APR/AQD	for vehicles with lowered suspension,For PR no.:1BV	Track Control Arm	S060799
	1996.06-2001.08	Front Axle Right Upper Outer	Saloon 4WD ACK/ALG/AMX/APR/AQD	Engine code:AMV,ALG,ACK,Engine code:APR,ATD,AWA,ADD,not For PR no.:1BV	Track Control Arm	S062531
	1996.06-2001.08	Front Axle Left & Right Lower Outer	Saloon 4WD ACK/ALG/AMX/APR/AQD		Track Control Arm	S060054
	1996.06-2001.08	Front Axle Left & Right Upper	Saloon 4WD ACK/ALG/AMX/APR/AQD		Control Arm Bushing	510136
	1996.06-2001.08	Front Axle Left & Right Lower Inner	Saloon 4WD ACK/ALG/AMX/APR/AQD		Control Arm Bushing	510135
	1996.06-2001.08	Front Axle Left & Right Lower Inner	Saloon 4WD ACK/ALG/AMX/APR/AQD		Control Arm Bushing	510287
	1996.06-2001.08	Front Axle Left & Right Lower Outer	Saloon 4WD ACK/ALG/AMX/APR/AQD		Control Arm Bushing	510133
	1996.06-2001.08	Front Axle Left & Right Lower Outer	Saloon 4WD ACK/ALG/AMX/APR/AQD		Control Arm Bushing	510134
	1996.06-2001.08	Front Axle	Saloon 4WD ACK/ALG/AMX/APR/AQD		Suspension Repair Kit	S990001SK
	1996.06-2001.08	Front Axle Left & Right	Saloon 4WD ACK/ALG/AMX/APR/AQD		Rod Assembly	S100014
	1996.06-2001.08	Front Axle Left & Right	Saloon 4WD ACK/ALG/AMX/APR/AQD	Engine code:ADD,APR,for vehicles with sports suspension,For PR no.:1BV	Tie Rod End	S070016
	1996.06-2001.08	Front Axle Left & Right	Saloon 4WD ACK/ALG/AMX/APR/AQD	not For PR no.:1BV	Tie Rod End	S070038
	1996.06-2001.08	Front Axle Left	Saloon 4WD ACK/ALG/AMX/APR/AQD		Rod/Strut, stabiliser	520008
	1996.06-2001.08	Front Axle Left	Saloon 4WD ACK/ALG/AMX/APR/AQD		Rod/Strut, stabiliser	S050034
	1996.06-2001.08	Front Axle Right	Saloon 4WD ACK/ALG/AMX/APR/AQD		Rod/Strut, stabiliser	520010
	1996.06-2001.08	Front Axle Right	Saloon 4WD ACK/ALG/AMX/APR/AQD		Rod/Strut, stabiliser	S050033
	1996.06-2001.08	Rear Axle Left	Saloon 4WD ACK/ALG/AMX/APR/AQD		Rod/Strut, stabiliser	S050030
	1996.06-2001.08	Rear Axle Right	Saloon 4WD ACK/ALG/AMX/APR/AQD		Rod/Strut, stabiliser	S050031
	1996.06-2001.08	Front Axle	Saloon 4WD ACK/ALG/AMX/APR/AQD	for vehicles without sports suspension	Stabiliser Bushing	510138
	1996.06-2001.08	Front Axle	Saloon 4WD ACK/ALG/AMX/APR/AQD		Stabiliser Bushing	510139
	1996.06-2001.08	Front Axle	Saloon 4WD ACK/ALG/AMX/APR/AQD		Stabiliser Bushing	517806
	1996.06-2001.08	Front Axle Left	Saloon 4WD ACK/ALG/AMX/APR/AQD		Steering Boot	540043
	1996.06-2001.08	Front Axle Left	Saloon 4WD ACK/ALG/AMX/APR/AQD	for vehicles with power steering,Date to:1096.10,VIN to:8D-J-053 000	Steering Rack Bellow Kit	540043S
	1996.06-2001.08	Front Axle Right	Saloon 4WD ACK/ALG/AMX/APR/AQD	for vehicles with steering damper,VIN to:8D-X-303 809	Steering Rack Bellow Kit	540211S
3.2 (195 kw)	2007.11-2012.03	Front Axle Left Lower Inner	Saloon 4WD CALA	Date to: 2009.10	Track Control Arm	S060038
	2007.11-2012.03	Front Axle Left Lower Inner	Saloon 4WD CALA	Date from-to:2009.11-2010.05,VIN:WAU***8K	Track Control Arm	S061601
	2007.11-2012.03	Front Axle Left Lower Inner	Saloon 4WD CALA		Track Control Arm	S062261
	2007.11-2012.03	Front Axle Left Upper Inner	Saloon 4WD CALA		Track Control Arm	S060804
	2007.11-2012.03	Front Axle Left Lower Outer	Saloon 4WD CALA	Date from:2011.08	Track Control Arm	S060806
	2007.11-2012.03	Front Axle Left Upper Outer	Saloon 4WD CALA		Track Control Arm	S060802
	2007.11-2012.03	Front Axle Right Lower Inner	Saloon 4WD CALA	Date to:2009.10	Track Control Arm	S060039
	2007.11-2012.03	Front Axle Right Lower Inner	Saloon 4WD CALA	Date from-to:2009.11-2010.05,VIN:WAU***8K	Track Control Arm	S061602
	2007.11-2012.03	Front Axle Right Lower Inner	Saloon 4WD CALA		Track Control Arm	S062177
	2007.11-2012.03	Front Axle Right Upper Inner	Saloon 4WD CALA		Track Control Arm	S060805
	2007.11-2012.03	Front Axle Right Lower Outer	Saloon 4WD CALA	Date from:2011.08	Track Control Arm	S060807
	2007.11-2012.03	Front Axle Right Upper Outer	Saloon 4WD CALA		Track Control Arm	S060803
	2007.11-2012.03	Rear Axle Left Upper	Saloon 4WD CALA		Track Control Arm	S061397
	2007.11-2012.03	Rear Axle Left Lower Inner	Saloon 4WD CALA		Track Control Arm	S061574
	2007.11-2012.03	Rear Axle Left Lower Outer	Saloon 4WD CALA		Track Control Arm	S062748
	2007.11-2012.03	Rear Axle Right Upper	Saloon 4WD CALA		Track Control Arm	S061398
	2007.11-2012.03	Rear Axle Right Lower Inner	Saloon 4WD CALA		Track Control Arm	S061575
	2007.11-2012.03	Rear Axle Right Lower Outer	Saloon 4WD CALA		Track Control Arm	S062749
	2007.11-2012.03	Rear Axle Left & Right Lower Inner	Saloon 4WD CALA		Track Control Arm	S062964
	2007.11-2012.03	Front Axle Left & Right Lower Outer	Saloon 4WD CALA		Ball Joint	S080283
	2007.11-2012.03	Front Axle Left & Right Lower Outer	Saloon 4WD CALA	Date from:2011.08	Ball Joint	S080987
	2007.11-2012.03	Front Axle Left & Right Upper	Saloon 4WD CALA		Control Arm Bushing	510136
	2007.11-2012.03	Front Axle Left & Right Lower Inner	Saloon 4WD CALA		Control Arm Bushing	530214



	 YEAR	FITTING POSITION	BODY STYLE & DRIVE TYPE & ENGINE	REMARKS	PRODUCT	GSP Ref.
AUDI						
A4 Quattro						
3.2 (195 kw)	2007.11-2012.03	Front Axle Left & Right Lower Inner	Saloon 4WD CALA		Control Arm Bushing	531929
	2007.11-2012.03	Front Axle Left & Right Lower Inner	Saloon 4WD CALA		Control Arm Bushing	531931
	2007.11-2012.03	Front Axle Left & Right Lower Outer	Saloon 4WD CALA	Date to:2011.08	Control Arm Bushing	510299
	2007.11-2012.03	Front Axle Left & Right Lower Outer	Saloon 4WD CALA		Control Arm Bushing	530215
	2007.11-2012.03	Rear Axle Left & Right Lower Inner	Saloon 4WD CALA		Control Arm Bushing	533477
	2007.11-2012.03	Front Axle Left & Right	Saloon 4WD CALA		Tie Rod Axle Joint	S030342
	2007.11-2012.03	Front Axle Left	Saloon 4WD CALA		Tie Rod End	S070024
	2007.11-2012.03	Front Axle Right	Saloon 4WD CALA		Tie Rod End	S070025
	2007.11-2012.03	Front Axle Left & Right	Saloon 4WD CALA	Aluminum Material	Rod/Strut,stabiliser	S050473
	2007.11-2012.03	Front Axle Left & Right	Saloon 4WD CALA		Rod/Strut,stabiliser	S051258
	2007.11-2012.03	Rear Axle Left & Right	Saloon 4WD CALA		Rod/Strut,stabiliser	S050472
	2007.11-2012.03	Front Axle	Saloon 4WD CALA		Stabiliser Bushing	510138
	2007.11-2012.03	Front Axle	Saloon 4WD CALA	for PR no.:1BA/1BL/1BR	Stabiliser Bushing	532578
	2008.04-2012.03	Front Axle Left Lower Inner	Estate 4WD CALA	Date to: 2009.10	Track Control Arm	S060038
	2008.04-2012.03	Front Axle Left Lower Inner	Estate 4WD CALA	Date from-to:2009.11-2010.05;VIN:WAU***8K	Track Control Arm	S061601
	2008.04-2012.03	Front Axle Left Lower Inner	Estate 4WD CALA		Track Control Arm	S062261
	2008.04-2012.03	Front Axle Left Upper Inner	Estate 4WD CALA		Track Control Arm	S060804
	2008.04-2012.03	Front Axle Left Lower Outer	Estate 4WD CALA	Date from:2011.08	Track Control Arm	S060806
	2008.04-2012.03	Front Axle Left Lower Outer	Estate 4WD CALA		Track Control Arm	S062024
	2008.04-2012.03	Front Axle Left Upper Outer	Estate 4WD CALA		Track Control Arm	S060802
	2008.04-2012.03	Front Axle Right Lower Inner	Estate 4WD CALA	Date to:2009.10	Track Control Arm	S060039
	2008.04-2012.03	Front Axle Right Lower Inner	Estate 4WD CALA	Date from-to:2009.11-2010.05;VIN:WAU***8K	Track Control Arm	S061602
	2008.04-2012.03	Front Axle Right Lower Inner	Estate 4WD CALA		Track Control Arm	S062177
	2008.04-2012.03	Front Axle Right Upper Inner	Estate 4WD CALA		Track Control Arm	S060805
	2008.04-2012.03	Front Axle Right Lower Outer	Estate 4WD CALA	Date from:2011.08	Track Control Arm	S060807
	2008.04-2012.03	Front Axle Right Lower Outer	Estate 4WD CALA		Track Control Arm	S062025
	2008.04-2012.03	Front Axle Right Upper Outer	Estate 4WD CALA		Track Control Arm	S060803
	2008.04-2012.03	Rear Axle Left Upper	Estate 4WD CALA		Track Control Arm	S061397
	2008.04-2012.03	Rear Axle Left Lower Inner	Estate 4WD CALA		Track Control Arm	S061574
	2008.04-2012.03	Rear Axle Left Lower Outer	Estate 4WD CALA		Track Control Arm	S062748
	2008.04-2012.03	Rear Axle Right Upper	Estate 4WD CALA		Track Control Arm	S061398
	2008.04-2012.03	Rear Axle Right Lower Inner	Estate 4WD CALA		Track Control Arm	S061575
	2008.04-2012.03	Rear Axle Right Lower Outer	Estate 4WD CALA		Track Control Arm	S062749
	2008.04-2012.03	Rear Axle Left & Right Lower Inner	Estate 4WD CALA		Track Control Arm	S062964
	2008.04-2012.03	Front Axle Left & Right Lower Outer	Estate 4WD CALA		Ball Joint	S080283
	2008.04-2012.03	Front Axle Left & Right Lower Outer	Estate 4WD CALA	Date from:2011.08	Ball Joint	S080987
	2008.04-2012.03	Front Axle Left & Right Upper	Estate 4WD CALA		Control Arm Bushing	510136
	2008.04-2012.03	Front Axle Left & Right Lower Inner	Estate 4WD CALA		Control Arm Bushing	530214
	2008.04-2012.03	Front Axle Left & Right Lower Inner	Estate 4WD CALA		Control Arm Bushing	531929
	2008.04-2012.03	Front Axle Left & Right Lower Inner	Estate 4WD CALA		Control Arm Bushing	531931
	2008.04-2012.03	Front Axle Left & Right Lower Outer	Estate 4WD CALA	Date to:2011.08	Control Arm Bushing	510299
	2008.04-2012.03	Front Axle Left & Right Lower Outer	Estate 4WD CALA		Control Arm Bushing	530215
	2008.04-2012.03	Rear Axle Left & Right Lower Inner	Estate 4WD CALA		Control Arm Bushing	533477
	2008.04-2012.03	Front Axle Left & Right	Estate 4WD CALA		Tie Rod Axle Joint	S030342
	2008.04-2012.03	Front Axle Left	Estate 4WD CALA		Tie Rod End	S070024
	2008.04-2012.03	Front Axle Right	Estate 4WD CALA		Tie Rod End	S070025
	2008.04-2012.03	Front Axle Left & Right	Estate 4WD CALA	Aluminum Material	Rod/Strut,stabiliser	S050473
	2008.04-2012.03	Front Axle Left & Right	Estate 4WD CALA		Rod/Strut,stabiliser	S051258
	2008.04-2012.03	Rear Axle Left & Right	Estate 4WD CALA		Rod/Strut,stabiliser	S050472
	2008.04-2012.03	Front Axle	Estate 4WD CALA	for PR no.:1BE,1BL/1BD/1BP/1BV	Stabiliser Bushing	510138
	2008.04-2012.03	Front Axle	Estate 4WD CALA	for PR no.:1BA	Stabiliser Bushing	532578
A4/S4						
1.8 (127 kw)	2001.01-2004.12	Front Axle Left Upper Outer	Saloon FWD AWM		Track Control Arm	S060798
	2001.01-2004.12	Front Axle Left	Saloon FWD AWM		Rod/Strut,stabiliser	520523
	2001.01-2004.12	Front Axle Right	Saloon FWD AWM		Rod/Strut,stabiliser	520524
	2001.01-2004.12	Rear Axle Left & Right	Saloon FWD AWM		Rod/Strut,stabiliser	S050042
	2001.01-2004.12	Front Axle	Saloon FWD AWM		Stabiliser Bushing	510139
	2001.01-2004.12	Rear Axle	Saloon FWD AWM		Stabiliser Bushing	517807
2.7 (186 kw)	2002.01-2005.12	Front Axle Left Upper Outer	Saloon AWD APB		Track Control Arm	S060798
	2002.01-2005.12	Front Axle Left	Saloon AWD APB		Rod/Strut,stabiliser	520523
	2002.01-2005.12	Front Axle Right	Saloon AWD APB		Rod/Strut,stabiliser	520524
	2002.01-2005.12	Rear Axle Left & Right	Saloon AWD APB		Rod/Strut,stabiliser	S050042
	2002.01-2005.12	Front Axle	Saloon AWD APB		Stabiliser Bushing	510139
	2002.01-2005.12	Rear Axle	Saloon AWD APB		Stabiliser Bushing	517807



	 YEAR	FITTING POSITION	BODY STYLE & DRIVE TYPE & ENGINE	REMARKS	PRODUCT	GSP Ref.
AUDI						
A4/S4						
3.0 (164 kw)	2005.01-2005.12	Front Axle Left Upper Outer	Saloon FWD BGN		Track Control Arm	S060798
	2005.01-2005.12	Front Axle Left	Saloon FWD BGN		Rod/Strut,stabiliser	520523
	2005.01-2005.12	Front Axle Right	Saloon FWD BGN		Rod/Strut,stabiliser	520524
	2005.01-2005.12	Rear Axle Left & Right	Saloon FWD BGN		Rod/Strut,stabiliser	S050042
	2005.01-2005.12	Front Axle	Saloon FWD BGN		Stabiliser Bushing	510139
	2005.01-2005.12	Rear Axle	Saloon FWD BGN		Stabiliser Bushing	517807
A4/S4 Avant quattro						
1.8 (127 kw)	2001.04-2004.12	Front Axle Left Upper Outer	Estate AWD AWM		Track Control Arm	S060798
	2001.04-2004.12	Front Axle Left	Estate AWD AWM		Rod/Strut,stabiliser	520523
	2001.04-2004.12	Front Axle Right	Estate AWD AWM		Rod/Strut,stabiliser	520524
	2001.04-2004.12	Rear Axle Left & Right	Estate AWD AWM		Rod/Strut,stabiliser	S050042
	2001.04-2004.12	Front Axle	Estate AWD AWM		Stabiliser Bushing	510139
	2001.04-2004.12	Rear Axle	Estate AWD AWM		Stabiliser Bushing	517807
2.7 (187 kw)	2001.04-2002.12	Front Axle Left Upper Outer	Estate AWD APB		Track Control Arm	S060798
	2001.04-2002.12	Front Axle Left	Estate AWD APB		Rod/Strut,stabiliser	520523
	2001.04-2002.12	Front Axle Right	Estate AWD APB		Rod/Strut,stabiliser	520524
	2001.04-2002.12	Rear Axle Left & Right	Estate AWD APB		Rod/Strut,stabiliser	S050042
	2001.04-2002.12	Front Axle	Estate AWD APB		Stabiliser Bushing	510139
	2001.04-2002.12	Rear Axle	Estate AWD APB		Stabiliser Bushing	517807
3.0 (164 kw)	2001.09-2004.12	Front Axle Left Upper Outer	Estate AWD AVK/BGN		Track Control Arm	S060798
	2001.09-2004.12	Front Axle Left	Estate AWD AVK/BGN		Rod/Strut,stabiliser	520523
	2001.09-2004.12	Front Axle Right	Estate AWD AVK/BGN		Rod/Strut,stabiliser	520524
	2001.09-2004.12	Rear Axle Left & Right	Estate AWD AVK/BGN		Rod/Strut,stabiliser	S050042
	2001.09-2004.12	Front Axle	Estate AWD AVK/BGN	Stabiliser Ø:27 mm	Stabiliser Bushing	510139
	2001.09-2004.12	Front Axle	Estate AWD AVK/BGN	Engine Code:AVK	Stabiliser Bushing	517806
2001.09-2004.12	Rear Axle	Estate AWD AVK/BGN		Stabiliser Bushing	517807	
A4/S4 quattro						
1.8 (125 kw)	2000.09-2001.12	Front Axle Left Upper Outer	Saloon AWD AWM		Track Control Arm	S060798
	2000.09-2001.12	Front Axle Left	Saloon AWD AWM		Rod/Strut,stabiliser	S050034
	2000.09-2001.12	Front Axle Right	Saloon AWD AWM		Rod/Strut,stabiliser	S050033
	2000.09-2001.12	Rear Axle Left	Saloon AWD AWM		Rod/Strut,stabiliser	S050030
	2000.09-2001.12	Rear Axle Right	Saloon AWD AWM		Rod/Strut,stabiliser	S050031
	2000.09-2001.12	Front Axle	Saloon AWD AWM	for vehicles without sports suspension	Stabiliser Bushing	510138
	2000.09-2001.12	Front Axle	Saloon AWD AWM	Stabiliser Ø:27 mm	Stabiliser Bushing	510139
2.0 (155 kw)	2012.09-2013.12	Front Axle Left Lower Outer	Saloon AWD CPMA		Track Control Arm	S060806
	2012.09-2013.12	Front Axle Right Lower Outer	Saloon AWD CPMA		Track Control Arm	S060807
	2012.09-2013.12	Front Axle Left & Right	Saloon AWD CPMA		Rod/Strut,stabiliser	S050473
	2012.09-2013.12	Front Axle Left & Right	Saloon AWD CPMA	not for country-spec.model:Russia,Belarus	Rod/Strut,stabiliser	S051258
	2012.09-2013.12	Rear Axle Left & Right	Saloon AWD CPMA		Rod/Strut,stabiliser	S050472
	2012.09-2013.12	Front Axle	Saloon AWD CPMA	for PR no.:1BE,1BL/1BD/1BP/1BV	Stabiliser Bushing	510138
	2012.09-2013.12	Front Axle	Saloon AWD CPMA	for PR no.:1BA/1BL/1BR	Stabiliser Bushing	532578
2.0 (162 kw)	2013.05-2015.12	Front Axle Left Lower Outer	Saloon AWD CPMB		Track Control Arm	S060806
	2013.05-2015.12	Front Axle Right Lower Outer	Saloon AWD CPMB		Track Control Arm	S060807
	2013.05-2015.12	Front Axle Left & Right	Saloon AWD CPMB		Rod/Strut,stabiliser	S050473
	2013.05-2015.12	Front Axle Left & Right	Saloon AWD CPMB	not for country-spec.model:Russia,Belarus	Rod/Strut,stabiliser	S051258
	2013.05-2015.12	Rear Axle Left & Right	Saloon AWD CPMB		Rod/Strut,stabiliser	S050472
	2013.05-2015.12	Front Axle	Saloon AWD CPMB	for PR no.:1BE,1BL/1BD/1BP/1BV	Stabiliser Bushing	510138
	2013.05-2015.12	Front Axle	Saloon AWD CPMB	for PR no.:1BA/1BL/1BR	Stabiliser Bushing	532578
	2013.05-2015.12	Front Axle Left	Saloon AWD CPMB		Steering Boot	541218
2.7 (187 kw)	2002.01-2002.12	Front Axle Left Upper Outer	Saloon AWD APB		Track Control Arm	S060798
	2002.01-2002.12	Front Axle Left	Saloon AWD APB		Rod/Strut,stabiliser	520523
	2002.01-2002.12	Front Axle Right	Saloon AWD APB		Rod/Strut,stabiliser	520524
	2002.01-2002.12	Rear Axle Left & Right	Saloon AWD APB		Rod/Strut,stabiliser	S050042
	2002.01-2002.12	Front Axle	Saloon AWD APB		Stabiliser Bushing	510139
	2002.01-2002.12	Rear Axle	Saloon AWD APB		Stabiliser Bushing	517807
3.0 (164 kw)	2005.01-2005.12	Front Axle Left Upper Outer	Saloon AWD BGN		Track Control Arm	S060798
	2005.01-2005.12	Front Axle Left	Saloon AWD BGN		Rod/Strut,stabiliser	520523
	2005.01-2005.12	Front Axle Right	Saloon AWD BGN		Rod/Strut,stabiliser	520524
	2005.01-2005.12	Rear Axle Left & Right	Saloon AWD BGN		Rod/Strut,stabiliser	S050042
	2005.01-2005.12	Front Axle	Saloon AWD BGN		Stabiliser Bushing	510139
	2005.01-2005.12	Rear Axle	Saloon AWD BGN		Stabiliser Bushing	517807
A5						
1.8 (125 kw)	2007.10-2017.01	Front Axle Left Lower Inner	Coupe FWD CABD/CJEB	Date to:2009.10;For Enginecode:CABD	Track Control Arm	S060038
	2007.10-2017.01	Front Axle Left Lower Inner	Coupe FWD CABD/CJEB	Engine code:CABD.Date from:to:2009.11-2011.08	Track Control Arm	S061601



	 YEAR	FITTING POSITION	BODY STYLE & DRIVE TYPE & ENGINE	REMARKS	PRODUCT	GSP Ref.	
AUDI A5 1.8 (125 kw)	2007.10-2017.01	Front Axle Left Upper Inner	Coupe FWD CABD/CJEB		Track Control Arm	S060804	
	2007.10-2017.01	Front Axle Left Lower Outer	Coupe FWD CABD/CJEB	Engine Code:CJEB	Track Control Arm	S060806	
	2007.10-2017.01	Front Axle Left Upper Outer	Coupe FWD CABD/CJEB		Track Control Arm	S060802	
	2007.10-2017.01	Front Axle Right Lower Inner	Coupe FWD CABD/CJEB	Date to:2009.10;For Enginecode:CABD	Track Control Arm	S060039	
	2007.10-2017.01	Front Axle Right Lower Inner	Coupe FWD CABD/CJEB	Engine code:CABD.Date from-to:2009.11-2011.08	Track Control Arm	S061602	
	2007.10-2017.01	Front Axle Right Upper Inner	Coupe FWD CABD/CJEB		Track Control Arm	S060805	
	2007.10-2017.01	Front Axle Right Lower Outer	Coupe FWD CABD/CJEB	Engine Code:CJEB	Track Control Arm	S060807	
	2007.10-2017.01	Front Axle Right Upper Outer	Coupe FWD CABD/CJEB		Track Control Arm	S060803	
	2007.10-2017.01	Rear Axle Left Upper	Coupe FWD CABD/CJEB		Track Control Arm	S061397	
	2007.10-2017.01	Rear Axle Left Lower Inner	Coupe FWD CABD/CJEB		Track Control Arm	S061574	
	2007.10-2017.01	Rear Axle Left Lower Outer	Coupe FWD CABD/CJEB		Track Control Arm	S062748	
	2007.10-2017.01	Rear Axle Right Upper	Coupe FWD CABD/CJEB		Track Control Arm	S061398	
	2007.10-2017.01	Rear Axle Right Lower Inner	Coupe FWD CABD/CJEB		Track Control Arm	S061575	
	2007.10-2017.01	Rear Axle Right Lower Outer	Coupe FWD CABD/CJEB		Track Control Arm	S062749	
	2007.10-2017.01	Rear Axle Left & Right Lower Inner	Coupe FWD CABD/CJEB		Track Control Arm	S062964	
	2007.10-2017.01	Front Axle Left & Right Lower Outer	Coupe FWD CABD/CJEB		Ball Joint	S080283	
	2007.10-2017.01	Front Axle Left & Right Lower Outer	Coupe FWD CABD/CJEB	Engine code:CJEB	Ball Joint	S080987	
	2007.10-2017.01	Front Axle Left & Right Upper	Coupe FWD CABD/CJEB		Control Arm Bushing	510136	
	2007.10-2017.01	Front Axle Left & Right Lower Inner	Coupe FWD CABD/CJEB		Control Arm Bushing	530214	
	2007.10-2017.01	Front Axle Left & Right Lower Inner	Coupe FWD CABD/CJEB	Date to:2008.10;For Enginecode:CABD	Control Arm Bushing	531929	
	2007.10-2017.01	Front Axle Left & Right Lower Inner	Coupe FWD CABD/CJEB		Control Arm Bushing	531931	
	2007.10-2017.01	Front Axle Left & Right Lower Outer	Coupe FWD CABD/CJEB		Control Arm Bushing	510299	
	2007.10-2017.01	Front Axle Left & Right Lower Outer	Coupe FWD CABD/CJEB		Control Arm Bushing	530215	
	2007.10-2017.01	Rear Axle Left & Right Lower Inner	Coupe FWD CABD/CJEB		Control Arm Bushing	533477	
	2007.10-2017.01	Front Axle	Coupe FWD CABD/CJEB		Suspension Repair Kit	S990011SK	
	2007.10-2017.01	Front Axle Left & Right	Coupe FWD CABD/CJEB		Tie Rod Axle Joint	S030342	
	2007.10-2017.01	Front Axle Left	Coupe FWD CABD/CJEB		Tie Rod End	S070024	
	2007.10-2017.01	Front Axle Right	Coupe FWD CABD/CJEB		Tie Rod End	S070025	
	2007.10-2017.01	Front Axle Left & Right	Coupe FWD CABD/CJEB	Chassis no.from:8T-8-011 201	Rod/Strut,stabiliser	S050473	
	2007.10-2017.01	Front Axle Left & Right	Coupe FWD CABD/CJEB	not For PR no.:X4M/X5F	Rod/Strut,stabiliser	S051258	
	2007.10-2017.01	Rear Axle Left & Right	Coupe FWD CABD/CJEB		Rod/Strut,stabiliser	S050472	
	2007.10-2017.01	Front Axle	Coupe FWD CABD/CJEB		Stabiliser Bushing	510138	
	2007.10-2017.01	Front Axle	Coupe FWD CABD/CJEB	Engine Code:CABD;for PR no.:K8C;Engine Code:CJEB	Stabiliser Bushing	532578	
	2.0 (140 kw)	2017.05-	Front Axle Left Upper Inner	Coupe FWD DEMA/DHDA/DKYA/DLVA		Track Control Arm	S062930
		2017.05-	Front Axle Left Lower Outer	Coupe FWD DEMA/DHDA/DKYA/DLVA		Track Control Arm	S062924
		2017.05-	Front Axle Left Upper Outer	Coupe FWD DEMA/DHDA/DKYA/DLVA		Track Control Arm	S062928
		2017.05-	Front Axle Right Upper Inner	Coupe FWD DEMA/DHDA/DKYA/DLVA		Track Control Arm	S062931
		2017.05-	Front Axle Right Lower Outer	Coupe FWD DEMA/DHDA/DKYA/DLVA		Track Control Arm	S062925
		2017.05-	Front Axle Right Upper Outer	Coupe FWD DEMA/DHDA/DKYA/DLVA		Track Control Arm	S062929
		2017.05-	Front Axle Left & Right Lower Outer	Coupe FWD DEMA/DHDA/DKYA/DLVA		Ball Joint	S080987
		2017.05-	Front Axle Left & Right Upper	Coupe FWD DEMA/DHDA/DKYA/DLVA		Control Arm Bushing	533522
		2017.05-	Front Axle Left & Right Lower Inner	Coupe FWD DEMA/DHDA/DKYA/DLVA		Control Arm Bushing	531931
		2017.05-	Front Axle Left & Right Lower Outer	Coupe FWD DEMA/DHDA/DKYA/DLVA		Control Arm Bushing	510299
2017.05-		Front Axle Left & Right Lower Outer	Coupe FWD DEMA/DHDA/DKYA/DLVA		Control Arm Bushing	530215	
2017.05-		Front Axle Left & Right	Coupe FWD DEMA/DHDA/DKYA/DLVA		Tie Rod Axle Joint	S030931	
2017.05-		Front Axle Left	Coupe FWD DEMA/DHDA/DKYA/DLVA		Tie Rod End	S071632	
2017.05-		Front Axle Right	Coupe FWD DEMA/DHDA/DKYA/DLVA		Tie Rod End	S071634	
2017.05-		Front Axle Left & Right	Coupe FWD DEMA/DHDA/DKYA/DLVA		Rod/Strut,stabiliser	S051258	
2017.05-		Rear Axle Left & Right	Coupe FWD DEMA/DHDA/DKYA/DLVA		Rod/Strut,stabiliser	S051433	
2017.05-		Front Axle	Coupe FWD DEMA/DHDA/DKYA/DLVA		Stabiliser Bushing	510138	
2017.05-		Front Axle	Coupe FWD DEMA/DHDA/DKYA/DLVA	Engine code:DKYA,DLVA;not for PR no.:18M	Stabiliser Bushing	532579	
2.0 (155 kw)		2008.06-2013.11	Front Axle Left Lower Inner	Coupe FWD CDNC	Date to: 2009.10	Track Control Arm	S060038
		2008.06-2013.11	Front Axle Left Lower Inner	Coupe FWD CDNC	Date from-to:2009.11-2011.06	Track Control Arm	S061601
	2008.06-2013.11	Front Axle Left Lower Inner	Coupe FWD CDNC	Date from-to:2009.11-2011.06	Track Control Arm	S062261	
	2008.06-2013.11	Front Axle Left Upper Inner	Coupe FWD CDNC		Track Control Arm	S060804	
	2008.06-2013.11	Front Axle Left Lower Outer	Coupe FWD CDNC	Date from:2011.08	Track Control Arm	S060806	
	2008.06-2013.11	Front Axle Left Upper Outer	Coupe FWD CDNC		Track Control Arm	S060802	
	2008.06-2013.11	Front Axle Right Lower Inner	Coupe FWD CDNC	Date to:2009.10	Track Control Arm	S060039	
	2008.06-2013.11	Front Axle Right Lower Inner	Coupe FWD CDNC	Date from-to:2009.11-2011.06	Track Control Arm	S061602	
	2008.06-2013.11	Front Axle Right Lower Inner	Coupe FWD CDNC	Date from-to:2009.11-2011.06	Track Control Arm	S062177	
	2008.06-2013.11	Front Axle Right Upper Inner	Coupe FWD CDNC		Track Control Arm	S060805	
	2008.06-2013.11	Front Axle Right Lower Outer	Coupe FWD CDNC	Date from:2011.08	Track Control Arm	S060807	
	2008.06-2013.11	Front Axle Right Upper Outer	Coupe FWD CDNC		Track Control Arm	S060803	
	2008.06-2013.11	Rear Axle Left Upper	Coupe FWD CDNC		Track Control Arm	S061397	



	 YEAR	FITTING POSITION	BODY STYLE & DRIVE TYPE & ENGINE	REMARKS	PRODUCT	GSP Ref.
AUDI A5 2.0 (155 kw)	2008.06-2013.11	Rear Axle Left Lower Inner	Coupe FWD CDNC		Track Control Arm	S061574
	2008.06-2013.11	Rear Axle Left Lower Outer	Coupe FWD CDNC		Track Control Arm	S062748
	2008.06-2013.11	Rear Axle Right Upper	Coupe FWD CDNC		Track Control Arm	S061398
	2008.06-2013.11	Rear Axle Right Lower Inner	Coupe FWD CDNC		Track Control Arm	S061575
	2008.06-2013.11	Rear Axle Right Lower Outer	Coupe FWD CDNC		Track Control Arm	S062749
	2008.06-2013.11	Rear Axle Left & Right Lower Inner	Coupe FWD CDNC		Track Control Arm	S062964
	2008.06-2013.11	Front Axle Left & Right Lower Outer	Coupe FWD CDNC		Ball Joint	S080283
	2008.06-2013.11	Front Axle Left & Right Lower Outer	Coupe FWD CDNC	Date from:2011.08	Ball Joint	S080987
	2008.06-2013.11	Front Axle Left & Right Upper	Coupe FWD CDNC		Control Arm Bushing	510136
	2008.06-2013.11	Front Axle Left & Right Lower Inner	Coupe FWD CDNC		Control Arm Bushing	530214
	2008.06-2013.11	Front Axle Left & Right Lower Inner	Coupe FWD CDNC		Control Arm Bushing	531929
	2008.06-2013.11	Front Axle Left & Right Lower Inner	Coupe FWD CDNC		Control Arm Bushing	531931
	2008.06-2013.11	Front Axle Left & Right Lower Outer	Coupe FWD CDNC	Date to:2011.08	Control Arm Bushing	510299
	2008.06-2013.11	Front Axle Left & Right Lower Outer	Coupe FWD CDNC		Control Arm Bushing	530215
	2008.06-2013.11	Rear Axle Left & Right Lower Inner	Coupe FWD CDNC		Control Arm Bushing	533477
	2008.06-2013.11	Front Axle	Coupe FWD CDNC		Suspension Repair Kit	S990011SK
	2008.06-2013.11	Front Axle Left & Right	Coupe FWD CDNC		Tie Rod Axle Joint	S030342
	2008.06-2013.11	Front Axle Left	Coupe FWD CDNC		Tie Rod End	S070024
	2008.06-2013.11	Front Axle Right	Coupe FWD CDNC		Tie Rod End	S070025
	2008.06-2013.11	Front Axle Left & Right	Coupe FWD CDNC	Chassis no.from:8T-8-011 201	Rod/Strut,stabliser	S050473
	2008.06-2013.11	Front Axle Left & Right	Coupe FWD CDNC	not For PR no.:X4M/X5F	Rod/Strut,stabliser	S051258
	2008.06-2013.11	Rear Axle Left & Right	Coupe FWD CDNC		Rod/Strut,stabliser	S050472
	2008.06-2013.11	Front Axle	Coupe FWD CDNC		Stabliser Bushing	510138
	2008.06-2013.11	Front Axle	Coupe FWD CDNC	for PR no.:K8C	Stabliser Bushing	532578
3.2 (195 kw)	2007.06-2012.03	Front Axle Left Lower Inner	Coupe FWD CALA	Date to: 2009.10	Track Control Arm	S060038
	2007.06-2012.03	Front Axle Left Lower Inner	Coupe FWD CALA	Date from-to:2009.11-2011.06	Track Control Arm	S061601
	2007.06-2012.03	Front Axle Left Lower Inner	Coupe FWD CALA		Track Control Arm	S062261
	2007.06-2012.03	Front Axle Left Upper Inner	Coupe FWD CALA		Track Control Arm	S060804
	2007.06-2012.03	Front Axle Left Lower Outer	Coupe FWD CALA	Date from:2011.08	Track Control Arm	S060806
	2007.06-2012.03	Front Axle Left Upper Outer	Coupe FWD CALA		Track Control Arm	S060802
	2007.06-2012.03	Front Axle Right Lower Inner	Coupe FWD CALA	Date to:2009.10	Track Control Arm	S060039
	2007.06-2012.03	Front Axle Right Lower Inner	Coupe FWD CALA	Date from-to:2009.11-2011.06	Track Control Arm	S061602
	2007.06-2012.03	Front Axle Right Lower Inner	Coupe FWD CALA		Track Control Arm	S062177
	2007.06-2012.03	Front Axle Right Upper Inner	Coupe FWD CALA		Track Control Arm	S060805
	2007.06-2012.03	Front Axle Right Lower Outer	Coupe FWD CALA	Date from:2011.08	Track Control Arm	S060807
	2007.06-2012.03	Front Axle Right Upper Outer	Coupe FWD CALA		Track Control Arm	S060803
	2007.06-2012.03	Rear Axle Left Upper	Coupe FWD CALA		Track Control Arm	S061397
	2007.06-2012.03	Rear Axle Left Lower Inner	Coupe FWD CALA		Track Control Arm	S061574
	2007.06-2012.03	Rear Axle Left Lower Outer	Coupe FWD CALA		Track Control Arm	S062748
	2007.06-2012.03	Rear Axle Right Upper	Coupe FWD CALA		Track Control Arm	S061398
	2007.06-2012.03	Rear Axle Right Lower Inner	Coupe FWD CALA		Track Control Arm	S061575
	2007.06-2012.03	Rear Axle Right Lower Outer	Coupe FWD CALA		Track Control Arm	S062749
	2007.06-2012.03	Rear Axle Left & Right Lower Inner	Coupe FWD CALA		Track Control Arm	S062964
	2007.06-2012.03	Front Axle Left & Right Lower Outer	Coupe FWD CALA		Ball Joint	S080283
	2007.06-2012.03	Front Axle Left & Right Lower Outer	Coupe FWD CALA	Date from:2011.08	Ball Joint	S080987
	2007.06-2012.03	Front Axle Left & Right Upper	Coupe FWD CALA		Control Arm Bushing	510136
	2007.06-2012.03	Front Axle Left & Right Lower Inner	Coupe FWD CALA		Control Arm Bushing	530214
	2007.06-2012.03	Front Axle Left & Right Lower Inner	Coupe FWD CALA		Control Arm Bushing	531929
	2007.06-2012.03	Front Axle Left & Right Lower Inner	Coupe FWD CALA		Control Arm Bushing	531931
	2007.06-2012.03	Front Axle Left & Right Lower Outer	Coupe FWD CALA	Date to:2011.08	Control Arm Bushing	510299
	2007.06-2012.03	Front Axle Left & Right Lower Outer	Coupe FWD CALA		Control Arm Bushing	530215
	2007.06-2012.03	Rear Axle Left & Right Lower Inner	Coupe FWD CALA		Control Arm Bushing	533477
	2007.06-2012.03	Front Axle	Coupe FWD CALA		Suspension Repair Kit	S990011SK
	2007.06-2012.03	Front Axle Left & Right	Coupe FWD CALA		Tie Rod Axle Joint	S030342
	2007.06-2012.03	Front Axle Left	Coupe FWD CALA		Tie Rod End	S070024
	2007.06-2012.03	Front Axle Right	Coupe FWD CALA		Tie Rod End	S070025
	2007.06-2012.03	Front Axle Left & Right	Coupe FWD CALA	Date from:2007.10,Chassis no.from:8T-8-011 201	Rod/Strut,stabliser	S050473
	2007.06-2012.03	Front Axle Left & Right	Coupe FWD CALA	Chassis no. to:8T-8-015 060,not For PR no.:X4M/X5F	Rod/Strut,stabliser	S050901
	2007.06-2012.03	Front Axle Left & Right	Coupe FWD CALA	Chassis no.from:8T-8-015 061,not For PR no.:X4M/X5F	Rod/Strut,stabliser	S051258
	2007.06-2012.03	Rear Axle Left & Right	Coupe FWD CALA		Rod/Strut,stabliser	S050472
	2007.06-2012.03	Front Axle	Coupe FWD CALA		Stabliser Bushing	510138
	2007.06-2012.03	Front Axle	Coupe FWD CALA	Date from:2007.09,for PR no.:K8C	Stabliser Bushing	532578
	2007.06-2012.03	Front Axle	Coupe FWD CALA	Stabliser Ø:28 mm	Stabliser Bushing	532579



	 YEAR	FITTING POSITION	BODY STYLE & DRIVE TYPE & ENGINE	REMARKS	PRODUCT	GSP Ref.
AUDI						
A5 Cabrio Quattro						
2.0 (155 kw)	2009.03-2017.01	Front Axle Left Lower Inner	Cabriolet 4WD CAEB/CDNC/CPMA	Date to:2009.10;For PR code:A8U	Track Control Arm	S060038
	2009.03-2017.01	Front Axle Left Lower Inner	Cabriolet 4WD CAEB/CDNC/CPMA	Engine code:CAEB_CDNC.Date from:2009.11-2010.05	Track Control Arm	S061601
	2009.03-2017.01	Front Axle Left Lower Inner	Cabriolet 4WD CAEB/CDNC/CPMA	Engine code:CAEB_CDNC.Date from:2010.05-2010.08	Track Control Arm	S062261
	2009.03-2017.01	Front Axle Left Upper Inner	Cabriolet 4WD CAEB/CDNC/CPMA	Engine code:CAEB_CDNC.Chassis no.from:8F-C-000 001	Track Control Arm	S060804
	2009.03-2017.01	Front Axle Left Lower Outer	Cabriolet 4WD CAEB/CDNC/CPMA	Engine Code:CAEB_CDNC.Date from:2011.08.Engine Code:CPMA	Track Control Arm	S060806
	2009.03-2017.01	Front Axle Left Upper Outer	Cabriolet 4WD CAEB/CDNC/CPMA		Track Control Arm	S060802
	2009.03-2017.01	Front Axle Right Lower Inner	Cabriolet 4WD CAEB/CDNC/CPMA	Date to:2009.10;For PR code:A8U	Track Control Arm	S060039
	2009.03-2017.01	Front Axle Right Lower Inner	Cabriolet 4WD CAEB/CDNC/CPMA	Engine code:CAEB_CDNC.Date from:2009.11-2010.05	Track Control Arm	S061602
	2009.03-2017.01	Front Axle Right Lower Inner	Cabriolet 4WD CAEB/CDNC/CPMA	Engine code:CAEB_CDNC.Date from:2010.05-2010.08	Track Control Arm	S062177
	2009.03-2017.01	Front Axle Right Upper Inner	Cabriolet 4WD CAEB/CDNC/CPMA	Engine code:CAEB_CDNC.Chassis no.from:8F-C-000 001	Track Control Arm	S060805
	2009.03-2017.01	Front Axle Right Lower Outer	Cabriolet 4WD CAEB/CDNC/CPMA	Engine Code:CAEB_CDNC.Date from:2011.08.Engine Code:CPMA	Track Control Arm	S060807
	2009.03-2017.01	Front Axle Right Upper Outer	Cabriolet 4WD CAEB/CDNC/CPMA		Track Control Arm	S060803
	2009.03-2017.01	Rear Axle Left Upper	Cabriolet 4WD CAEB/CDNC/CPMA		Track Control Arm	S061397
	2009.03-2017.01	Rear Axle Left Lower Inner	Cabriolet 4WD CAEB/CDNC/CPMA		Track Control Arm	S061574
	2009.03-2017.01	Rear Axle Left Lower Outer	Cabriolet 4WD CAEB/CDNC/CPMA		Track Control Arm	S062748
	2009.03-2017.01	Rear Axle Right Upper	Cabriolet 4WD CAEB/CDNC/CPMA		Track Control Arm	S061398
	2009.03-2017.01	Rear Axle Right Lower Inner	Cabriolet 4WD CAEB/CDNC/CPMA		Track Control Arm	S061575
	2009.03-2017.01	Rear Axle Right Lower Outer	Cabriolet 4WD CAEB/CDNC/CPMA		Track Control Arm	S062749
	2009.03-2017.01	Rear Axle Left & Right Lower Inner	Cabriolet 4WD CAEB/CDNC/CPMA		Track Control Arm	S062964
	2009.03-2017.01	Front Axle Left & Right Lower Outer	Cabriolet 4WD CAEB/CDNC/CPMA	Date to:2011.10	Ball Joint	S080283
	2009.03-2017.01	Front Axle Left & Right Lower Outer	Cabriolet 4WD CAEB/CDNC/CPMA	Engine code:CAEB_CDNC.Date from:2011.08	Ball Joint	S080987
	2009.03-2017.01	Front Axle Left & Right Upper	Cabriolet 4WD CAEB/CDNC/CPMA		Control Arm Bushing	510136
	2009.03-2017.01	Front Axle Left & Right Upper	Cabriolet 4WD CAEB/CDNC/CPMA		Control Arm Bushing	517974
	2009.03-2017.01	Front Axle Left & Right Lower Inner	Cabriolet 4WD CAEB/CDNC/CPMA		Control Arm Bushing	530214
	2009.03-2017.01	Front Axle Left & Right Lower Inner	Cabriolet 4WD CAEB/CDNC/CPMA		Control Arm Bushing	531929
	2009.03-2017.01	Front Axle Left & Right Lower Inner	Cabriolet 4WD CAEB/CDNC/CPMA		Control Arm Bushing	531931
	2009.03-2017.01	Front Axle Left & Right Lower Outer	Cabriolet 4WD CAEB/CDNC/CPMA	Date to:2011.08	Control Arm Bushing	510299
	2009.03-2017.01	Front Axle Left & Right Lower Outer	Cabriolet 4WD CAEB/CDNC/CPMA		Control Arm Bushing	530215
	2009.03-2017.01	Rear Axle Left & Right Lower Inner	Cabriolet 4WD CAEB/CDNC/CPMA		Control Arm Bushing	533477
	2009.03-2017.01	Front Axle	Cabriolet 4WD CAEB/CDNC/CPMA		Suspension Repair Kit	S990011SK
	2009.03-2017.01	Front Axle	Cabriolet 4WD CAEB/CDNC/CPMA	Date from:2009.11-2010.08;not for PR no.:1LA,1LB,1LT,1LY	Suspension Repair Kit	S990027SK
	2009.03-2017.01	Front Axle Left & Right	Cabriolet 4WD CAEB/CDNC/CPMA		Tie Rod Axle Joint	S030342
	2009.03-2017.01	Front Axle Left	Cabriolet 4WD CAEB/CDNC/CPMA		Tie Rod End	S070024
	2009.03-2017.01	Front Axle Right	Cabriolet 4WD CAEB/CDNC/CPMA		Tie Rod End	S070025
	2009.03-2017.01	Front Axle Left & Right	Cabriolet 4WD CAEB/CDNC/CPMA	Chassis no.from:8T-8-011 201	Rod/Strut,stabiliser	S050473
	2009.03-2017.01	Front Axle Left & Right	Cabriolet 4WD CAEB/CDNC/CPMA		Rod/Strut,stabiliser	S051258
	2009.03-2017.01	Rear Axle Left & Right	Cabriolet 4WD CAEB/CDNC/CPMA		Rod/Strut,stabiliser	S050472
	2009.03-2017.01	Front Axle	Cabriolet 4WD CAEB/CDNC/CPMA		Stabiliser Bushing	510138
	2009.03-2017.01	Front Axle	Cabriolet 4WD CAEB/CDNC/CPMA	for PR no.:1BL	Stabiliser Bushing	532578
A5 Quattro						
2.0 (155 kw)	2008.06-2017.01	Front Axle Left Lower Inner	Coupe 4WD CAEB/CDNC/CPMA	Date to: 2009.10	Track Control Arm	S060038
	2008.06-2017.01	Front Axle Left Lower Inner	Coupe 4WD CAEB/CDNC/CPMA	Engine code:CAEB_CDNC.Date from:2009.11-2011.05	Track Control Arm	S061601
	2008.06-2017.01	Front Axle Left Lower Inner	Coupe 4WD CAEB/CDNC/CPMA	Engine code:CAEB_CDNC.Date from:2010.05-2010.08;not for PR no.:1LA,1LB,1LT,1LY	Track Control Arm	S062261
	2008.06-2017.01	Front Axle Left Upper Inner	Coupe 4WD CAEB/CDNC/CPMA		Track Control Arm	S060804
	2008.06-2017.01	Front Axle Left Lower Outer	Coupe 4WD CAEB/CDNC/CPMA	Engine Code:CAEB_CDNC.Date from:2011.08.Engine Code:CPMA	Track Control Arm	S060806
	2008.06-2017.01	Front Axle Left Upper Outer	Coupe 4WD CAEB/CDNC/CPMA		Track Control Arm	S060802
	2008.06-2017.01	Front Axle Right Lower Inner	Coupe 4WD CAEB/CDNC/CPMA	Date to:2009.10	Track Control Arm	S060039
	2008.06-2017.01	Front Axle Right Lower Inner	Coupe 4WD CAEB/CDNC/CPMA	Engine code:CAEB_CDNC.Date from:2009.11-2011.05	Track Control Arm	S061602
	2008.06-2017.01	Front Axle Right Lower Inner	Coupe 4WD CAEB/CDNC/CPMA	Engine code:CAEB_CDNC.Date from:2010.05-2010.08;not for PR no.:1LA,1LB,1LT,1LY	Track Control Arm	S062177
	2008.06-2017.01	Front Axle Right Upper Inner	Coupe 4WD CAEB/CDNC/CPMA		Track Control Arm	S060805
	2008.06-2017.01	Front Axle Right Lower Outer	Coupe 4WD CAEB/CDNC/CPMA	Engine Code:CAEB_CDNC.Date from:2011.08.Engine Code:CPMA	Track Control Arm	S060807
	2008.06-2017.01	Front Axle Right Upper Outer	Coupe 4WD CAEB/CDNC/CPMA		Track Control Arm	S060803
	2008.06-2017.01	Rear Axle Left Upper	Coupe 4WD CAEB/CDNC/CPMA		Track Control Arm	S061397
	2008.06-2017.01	Rear Axle Left Lower Inner	Coupe 4WD CAEB/CDNC/CPMA		Track Control Arm	S061574
	2008.06-2017.01	Rear Axle Left Lower Outer	Coupe 4WD CAEB/CDNC/CPMA		Track Control Arm	S062748
	2008.06-2017.01	Rear Axle Right Upper	Coupe 4WD CAEB/CDNC/CPMA		Track Control Arm	S061398
	2008.06-2017.01	Rear Axle Right Lower Inner	Coupe 4WD CAEB/CDNC/CPMA		Track Control Arm	S061575
	2008.06-2017.01	Rear Axle Right Lower Outer	Coupe 4WD CAEB/CDNC/CPMA		Track Control Arm	S062749
	2008.06-2017.01	Rear Axle Left & Right Lower Inner	Coupe 4WD CAEB/CDNC/CPMA		Track Control Arm	S062964
	2008.06-2017.01	Front Axle Left & Right Lower Outer	Coupe 4WD CAEB/CDNC/CPMA	Date to:2011.10	Ball Joint	S080283
	2008.06-2017.01	Front Axle Left & Right Lower Outer	Coupe 4WD CAEB/CDNC/CPMA	Engine code:CAEB_CDNC.Date from:2011.08.Engine Code:CPMA	Ball Joint	S080987
	2008.06-2017.01	Front Axle Left & Right Upper	Coupe 4WD CAEB/CDNC/CPMA		Control Arm Bushing	510136
	2008.06-2017.01	Front Axle Left & Right Lower Inner	Coupe 4WD CAEB/CDNC/CPMA		Control Arm Bushing	530214
	2008.06-2017.01	Front Axle Left & Right Lower Inner	Coupe 4WD CAEB/CDNC/CPMA		Control Arm Bushing	531929



	 YEAR	FITTING POSITION	BODY STYLE & DRIVE TYPE & ENGINE	REMARKS	PRODUCT	GSP Ref.
AUDI						
A5 Quattro						
2.0 (155 kw)	2008.06-2017.01	Front Axle Left & Right Lower Inner	Coupe 4WD CAEB/CDNC/CPMA		Control Arm Bushing	531931
	2008.06-2017.01	Front Axle Left & Right Lower Outer	Coupe 4WD CAEB/CDNC/CPMA	Date to:2011.08	Control Arm Bushing	510299
	2008.06-2017.01	Front Axle Left & Right Lower Outer	Coupe 4WD CAEB/CDNC/CPMA		Control Arm Bushing	530215
	2008.06-2017.01	Rear Axle Left & Right Lower Inner	Coupe 4WD CAEB/CDNC/CPMA		Control Arm Bushing	533477
	2008.06-2017.01	Front Axle	Coupe 4WD CAEB/CDNC/CPMA		Suspension Repair Kit	S990011SK
	2008.06-2017.01	Front Axle Left & Right	Coupe 4WD CAEB/CDNC/CPMA		Tie Rod Axle Joint	S030342
	2008.06-2017.01	Front Axle Left	Coupe 4WD CAEB/CDNC/CPMA		Tie Rod End	S070024
	2008.06-2017.01	Front Axle Right	Coupe 4WD CAEB/CDNC/CPMA		Tie Rod End	S070025
	2008.06-2017.01	Front Axle Left & Right	Coupe 4WD CAEB/CDNC/CPMA	Chassis no.from:8T-8-011 201	Rod/Strut,stabiliser	S050473
	2008.06-2017.01	Front Axle Left & Right	Coupe 4WD CAEB/CDNC/CPMA	not For PR no.:X4M/X5F	Rod/Strut,stabiliser	S051258
	2008.06-2017.01	Rear Axle Left & Right	Coupe 4WD CAEB/CDNC/CPMA		Rod/Strut,stabiliser	S050472
	2008.06-2017.01	Front Axle	Coupe 4WD CAEB/CDNC/CPMA		Stabiliser Bushing	510138
	2008.06-2017.01	Front Axle	Coupe 4WD CAEB/CDNC/CPMA	Engine Code:CAEB,CDNC, for PR no. K8C,Engine Code:CPMA	Stabiliser Bushing	532578
A5 Sportback						
1.8 (125 kw)	2011.08-2017.01	Front Axle Left Upper Inner	Hatchback FWD CJEB		Track Control Arm	S060804
	2011.08-2017.01	Front Axle Left Upper Outer	Hatchback FWD CJEB		Track Control Arm	S060802
	2011.08-2017.01	Front Axle Right Upper Inner	Hatchback FWD CJEB		Track Control Arm	S060805
	2011.08-2017.01	Front Axle Right Upper Outer	Hatchback FWD CJEB		Track Control Arm	S060803
	2011.08-2017.01	Rear Axle Left Upper	Hatchback FWD CJEB		Track Control Arm	S061397
	2011.08-2017.01	Rear Axle Left Lower Outer	Hatchback FWD CJEB		Track Control Arm	S062748
	2011.08-2017.01	Rear Axle Right Upper	Hatchback FWD CJEB		Track Control Arm	S061398
	2011.08-2017.01	Rear Axle Right Lower Outer	Hatchback FWD CJEB		Track Control Arm	S062749
	2011.08-2017.01	Rear Axle Left & Right Lower Inner	Hatchback FWD CJEB		Track Control Arm	S062964
	2011.08-2017.01	Front Axle Left & Right Lower Outer	Hatchback FWD CJEB		Ball Joint	S080987
	2011.08-2017.01	Front Axle Left & Right Upper	Hatchback FWD CJEB		Control Arm Bushing	510136
	2011.08-2017.01	Front Axle Left & Right Lower Inner	Hatchback FWD CJEB		Control Arm Bushing	530214
	2011.08-2017.01	Front Axle Left & Right Lower Inner	Hatchback FWD CJEB		Control Arm Bushing	531929
	2011.08-2017.01	Front Axle Left & Right Lower Inner	Hatchback FWD CJEB		Control Arm Bushing	531931
	2011.08-2017.01	Front Axle Left & Right Lower Outer	Hatchback FWD CJEB		Control Arm Bushing	510299
	2011.08-2017.01	Front Axle Left & Right Lower Outer	Hatchback FWD CJEB		Control Arm Bushing	530215
	2011.08-2017.01	Rear Axle Left & Right Lower Inner	Hatchback FWD CJEB		Control Arm Bushing	533477
	2011.08-2017.01	Front Axle Left & Right	Hatchback FWD CJEB		Tie Rod Axle Joint	S030342
	2011.08-2017.01	Front Axle Left	Hatchback FWD CJEB		Tie Rod End	S070024
	2011.08-2017.01	Front Axle Right	Hatchback FWD CJEB		Tie Rod End	S070025
	2011.08-2017.01	Front Axle Left & Right	Hatchback FWD CJEB	Chassis no.from:8T-8-011 201	Rod/Strut,stabiliser	S050473
	2011.08-2017.01	Front Axle Left & Right	Hatchback FWD CJEB	not For PR no.:X4M/X5F	Rod/Strut,stabiliser	S051258
	2011.08-2017.01	Rear Axle Left & Right	Hatchback FWD CJEB		Rod/Strut,stabiliser	S050472
	2011.08-2017.01	Front Axle	Hatchback FWD CJEB		Stabiliser Bushing	510138
	2011.08-2017.01	Front Axle	Hatchback FWD CJEB		Stabiliser Bushing	532578
2.0 (132 kw)	2009.09-2014.06	Front Axle Left Lower Inner	Hatchback FWD CDNB	Date to: 2009.10	Track Control Arm	S060038
	2009.09-2014.06	Front Axle Left Lower Inner	Hatchback FWD CDNB	Date from-to:2009.11-2011.06	Track Control Arm	S061601
	2009.09-2014.06	Front Axle Left Lower Inner	Hatchback FWD CDNB	Date from-to:2009.11-2011.06 Date from-to:2010.08-2011.06 For PR no.:LJF3M13V	Track Control Arm	S062261
	2009.09-2014.06	Front Axle Left Upper Inner	Hatchback FWD CDNB		Track Control Arm	S060804
	2009.09-2014.06	Front Axle Left Upper Outer	Hatchback FWD CDNB	Date from:2011.08	Track Control Arm	S060806
	2009.09-2014.06	Front Axle Left Upper Outer	Hatchback FWD CDNB		Track Control Arm	S060802
	2009.09-2014.06	Front Axle Right Lower Inner	Hatchback FWD CDNB	Date to:2009.10	Track Control Arm	S060039
	2009.09-2014.06	Front Axle Right Lower Inner	Hatchback FWD CDNB	Date from-to:2009.11-2011.06	Track Control Arm	S061602
	2009.09-2014.06	Front Axle Right Lower Inner	Hatchback FWD CDNB	Date from-to:2009.11-2011.06 Date from-to:2010.08-2011.06 For PR no.:LJF3M13V	Track Control Arm	S062177
	2009.09-2014.06	Front Axle Right Upper Inner	Hatchback FWD CDNB		Track Control Arm	S060805
	2009.09-2014.06	Front Axle Right Lower Outer	Hatchback FWD CDNB	Date from:2011.08	Track Control Arm	S060807
	2009.09-2014.06	Front Axle Right Upper Outer	Hatchback FWD CDNB		Track Control Arm	S060803
	2009.09-2014.06	Rear Axle Left Upper	Hatchback FWD CDNB		Track Control Arm	S061397
	2009.09-2014.06	Rear Axle Left Lower Outer	Hatchback FWD CDNB		Track Control Arm	S062748
	2009.09-2014.06	Rear Axle Right Upper	Hatchback FWD CDNB		Track Control Arm	S061398
	2009.09-2014.06	Rear Axle Right Lower Outer	Hatchback FWD CDNB		Track Control Arm	S062749
	2009.09-2014.06	Rear Axle Left & Right Lower Inner	Hatchback FWD CDNB		Track Control Arm	S062964
	2009.09-2014.06	Front Axle Left & Right Lower Outer	Hatchback FWD CDNB	Date to:2011.08	Ball Joint	S080283
	2009.09-2014.06	Front Axle Left & Right Lower Outer	Hatchback FWD CDNB	Date from:2011.08	Ball Joint	S080987
	2009.09-2014.06	Front Axle Left & Right Upper	Hatchback FWD CDNB		Control Arm Bushing	510136
	2009.09-2014.06	Front Axle Left & Right Lower Inner	Hatchback FWD CDNB		Control Arm Bushing	530214
	2009.09-2014.06	Front Axle Left & Right Lower Inner	Hatchback FWD CDNB		Control Arm Bushing	531929
	2009.09-2014.06	Front Axle Left & Right Lower Inner	Hatchback FWD CDNB		Control Arm Bushing	531931
	2009.09-2014.06	Front Axle Left & Right Lower Outer	Hatchback FWD CDNB	Date to:2011.08	Control Arm Bushing	510299
	2009.09-2014.06	Front Axle Left & Right Lower Outer	Hatchback FWD CDNB		Control Arm Bushing	530215



	 YEAR	FITTING POSITION	BODY STYLE & DRIVE TYPE & ENGINE	REMARKS	PRODUCT	GSP Ref.
AUDI						
A5 Sportback						
2.0 (132 kw)	2009.09-2014.06	Rear Axle Left & Right Lower Inner	Hatchback FWD CDNB		Control Arm Bushing	533477
	2009.09-2014.06	Front Axle	Hatchback FWD CDNB		Suspension Repair Kit	S990011SK
	2009.09-2014.06	Front Axle Left & Right	Hatchback FWD CDNB		Tie Rod Axle Joint	S030342
	2009.09-2014.06	Front Axle Left	Hatchback FWD CDNB		Tie Rod End	S070024
	2009.09-2014.06	Front Axle Right	Hatchback FWD CDNB		Tie Rod End	S070025
	2009.09-2014.06	Front Axle Left & Right	Hatchback FWD CDNB	Chassis no.from:8T-8-011 201	Rod/Strut,stabiliser	S050473
	2009.09-2014.06	Front Axle Left & Right	Hatchback FWD CDNB	not For PR no.:X4M/X5F	Rod/Strut,stabiliser	S051258
	2009.09-2014.06	Rear Axle Left & Right	Hatchback FWD CDNB		Rod/Strut,stabiliser	S050472
	2009.09-2014.06	Front Axle	Hatchback FWD CDNB		Stabiliser Bushing	510138
	2009.09-2014.06	Front Axle	Hatchback FWD CDNB	for PR no.:1BA/1BB/1BL+K8R	Stabiliser Bushing	532578
2.0 (140 kw)	2017.01-2020.02	Front Axle Left Upper Inner	Hatchback FWD CVKB		Track Control Arm	S062930
	2017.01-2020.02	Front Axle Left Lower Outer	Hatchback FWD CVKB		Track Control Arm	S062924
	2017.01-2020.02	Front Axle Left Upper Outer	Hatchback FWD CVKB		Track Control Arm	S062928
	2017.01-2020.02	Front Axle Right Upper Inner	Hatchback FWD CVKB		Track Control Arm	S062931
	2017.01-2020.02	Front Axle Right Lower Outer	Hatchback FWD CVKB		Track Control Arm	S062925
	2017.01-2020.02	Front Axle Right Upper Outer	Hatchback FWD CVKB		Track Control Arm	S062929
	2017.01-2020.02	Front Axle Left & Right Lower Outer	Hatchback FWD CVKB		Ball Joint	S080987
	2017.01-2020.02	Front Axle Left & Right Upper	Hatchback FWD CVKB		Control Arm Bushing	533522
	2017.01-2020.02	Front Axle Left & Right Lower Inner	Hatchback FWD CVKB		Control Arm Bushing	531931
	2017.01-2020.02	Front Axle Left & Right Lower Outer	Hatchback FWD CVKB		Control Arm Bushing	510299
	2017.01-2020.02	Front Axle Left & Right Lower Outer	Hatchback FWD CVKB		Control Arm Bushing	530215
	2017.01-2020.02	Front Axle Left & Right	Hatchback FWD CVKB		Tie Rod Axle Joint	S030931
	2017.01-2020.02	Front Axle Left	Hatchback FWD CVKB		Tie Rod End	S071632
	2017.01-2020.02	Front Axle Right	Hatchback FWD CVKB		Tie Rod End	S071634
	2017.01-2020.02	Front Axle Left & Right	Hatchback FWD CVKB		Rod/Strut,stabiliser	S051258
	2017.01-2020.02	Rear Axle Left & Right	Hatchback FWD CVKB		Rod/Strut,stabiliser	S051433
	2017.01-2020.02	Front Axle	Hatchback FWD CVKB		Stabiliser Bushing	510138
	2017.01-2020.02	Front Axle	Hatchback FWD CVKB		Stabiliser Bushing	532579
2.0 (155 kw)	2009.09-2013.11	Front Axle Left Lower Inner	Hatchback FWD CDNC	Date to: 2009.10	Track Control Arm	S060038
	2009.09-2013.11	Front Axle Left Lower Inner	Hatchback FWD CDNC	Date from-to:2009.11-2011.06	Track Control Arm	S061601
	2009.09-2013.11	Front Axle Left Lower Inner	Hatchback FWD CDNC	Date from-to:2009.11-2011.06	Track Control Arm	S062261
	2009.09-2013.11	Front Axle Left Upper Inner	Hatchback FWD CDNC	Date from-to:2009.11-2011.06	Track Control Arm	S060804
	2009.09-2013.11	Front Axle Left Lower Outer	Hatchback FWD CDNC	Date from:2011.08	Track Control Arm	S060806
	2009.09-2013.11	Front Axle Left Upper Outer	Hatchback FWD CDNC		Track Control Arm	S060802
	2009.09-2013.11	Front Axle Right Lower Inner	Hatchback FWD CDNC	Date to:2009.10	Track Control Arm	S060039
	2009.09-2013.11	Front Axle Right Lower Inner	Hatchback FWD CDNC	Date from-to:2009.11-2011.06	Track Control Arm	S061602
	2009.09-2013.11	Front Axle Right Lower Inner	Hatchback FWD CDNC	Date from-to:2009.11-2011.06	Track Control Arm	S062177
	2009.09-2013.11	Front Axle Right Upper Inner	Hatchback FWD CDNC		Track Control Arm	S060805
	2009.09-2013.11	Front Axle Right Lower Outer	Hatchback FWD CDNC	Date from:2011.08	Track Control Arm	S060807
	2009.09-2013.11	Front Axle Right Upper Outer	Hatchback FWD CDNC		Track Control Arm	S060803
	2009.09-2013.11	Rear Axle Left Upper	Hatchback FWD CDNC		Track Control Arm	S061397
	2009.09-2013.11	Rear Axle Left Lower Outer	Hatchback FWD CDNC		Track Control Arm	S062748
	2009.09-2013.11	Rear Axle Right Upper	Hatchback FWD CDNC		Track Control Arm	S061398
	2009.09-2013.11	Rear Axle Right Lower Outer	Hatchback FWD CDNC		Track Control Arm	S062749
	2009.09-2013.11	Rear Axle Left & Right Lower Inner	Hatchback FWD CDNC		Track Control Arm	S062964
	2009.09-2013.11	Front Axle Left & Right Lower Outer	Hatchback FWD CDNC	Date to:2011.08	Ball Joint	S080283
	2009.09-2013.11	Front Axle Left & Right Lower Outer	Hatchback FWD CDNC	Date from:2011.08	Ball Joint	S080987
	2009.09-2013.11	Front Axle Left & Right Upper	Hatchback FWD CDNC		Control Arm Bushing	510136
	2009.09-2013.11	Front Axle Left & Right Lower Inner	Hatchback FWD CDNC		Control Arm Bushing	530214
	2009.09-2013.11	Front Axle Left & Right Lower Inner	Hatchback FWD CDNC		Control Arm Bushing	531929
	2009.09-2013.11	Front Axle Left & Right Lower Inner	Hatchback FWD CDNC		Control Arm Bushing	531931
	2009.09-2013.11	Front Axle Left & Right Lower Outer	Hatchback FWD CDNC	Date to:2011.08	Control Arm Bushing	510299
	2009.09-2013.11	Front Axle Left & Right Lower Outer	Hatchback FWD CDNC		Control Arm Bushing	530215
	2009.09-2013.11	Rear Axle Left & Right Lower Inner	Hatchback FWD CDNC		Control Arm Bushing	533477
	2009.09-2013.11	Front Axle Left & Right	Hatchback FWD CDNC		Tie Rod Axle Joint	S030342
	2009.09-2013.11	Front Axle Left	Hatchback FWD CDNC		Tie Rod End	S070024
	2009.09-2013.11	Front Axle Right	Hatchback FWD CDNC		Tie Rod End	S070025
	2009.09-2013.11	Front Axle Left & Right	Hatchback FWD CDNC	Chassis no.from:8T-8-011 201	Rod/Strut,stabiliser	S050473
	2009.09-2013.11	Front Axle Left & Right	Hatchback FWD CDNC	not For PR no.:X4M/X5F	Rod/Strut,stabiliser	S051258
	2009.09-2013.11	Rear Axle Left & Right	Hatchback FWD CDNC		Rod/Strut,stabiliser	S050472
	2009.09-2013.11	Front Axle	Hatchback FWD CDNC		Stabiliser Bushing	510138
	2009.09-2013.11	Front Axle	Hatchback FWD CDNC	for PR no.:1BA/1BB/1BL+K8R	Stabiliser Bushing	532578



	 YEAR	FITTING POSITION	BODY STYLE & DRIVE TYPE & ENGINE	REMARKS	PRODUCT	GSP Ref.
AUDI						
A5 Sportback Quattro						
2.0 (155 kw)	2009.09-2017.01	Front Axle Left Lower Inner	Hatchback 4WD CDNC	Date to: 2009.10	Track Control Arm	S060038
	2009.09-2017.01	Front Axle Left Lower Inner	Hatchback 4WD CDNC	Date from-to:2009.11-2011.06	Track Control Arm	S061601
	2009.09-2017.01	Front Axle Left Lower Inner	Hatchback 4WD CDNC	<small>Date from-to:2009.11-2011.06; Date from-to:2010.08-2011.06; For PR no.:1LJ733413V</small>	Track Control Arm	S062261
	2009.09-2017.01	Front Axle Left Upper Inner	Hatchback 4WD CDNC		Track Control Arm	S060804
	2009.09-2017.01	Front Axle Left Lower Outer	Hatchback 4WD CDNC	Date from:2011.08	Track Control Arm	S060806
	2009.09-2017.01	Front Axle Left Upper Outer	Hatchback 4WD CDNC		Track Control Arm	S060802
	2009.09-2017.01	Front Axle Right Lower Inner	Hatchback 4WD CDNC	Date to:2009.10	Track Control Arm	S060039
	2009.09-2017.01	Front Axle Right Lower Inner	Hatchback 4WD CDNC	Date from-to:2009.11-2011.06	Track Control Arm	S061602
	2009.09-2017.01	Front Axle Right Lower Inner	Hatchback 4WD CDNC	<small>Date from-to:2009.11-2011.06; Date from-to:2010.08-2011.06; For PR no.:1LJ733413V</small>	Track Control Arm	S062177
	2009.09-2017.01	Front Axle Right Upper Inner	Hatchback 4WD CDNC		Track Control Arm	S060805
	2009.09-2017.01	Front Axle Right Lower Outer	Hatchback 4WD CDNC	Date from:2011.08	Track Control Arm	S060807
	2009.09-2017.01	Front Axle Right Upper Outer	Hatchback 4WD CDNC		Track Control Arm	S060803
	2009.09-2017.01	Rear Axle Left Upper	Hatchback 4WD CDNC		Track Control Arm	S061397
	2009.09-2017.01	Rear Axle Left Lower Outer	Hatchback 4WD CDNC		Track Control Arm	S062748
	2009.09-2017.01	Rear Axle Right Upper	Hatchback 4WD CDNC		Track Control Arm	S061398
	2009.09-2017.01	Rear Axle Right Lower Outer	Hatchback 4WD CDNC		Track Control Arm	S062749
	2009.09-2017.01	Rear Axle Left & Right Lower Inner	Hatchback 4WD CDNC		Track Control Arm	S062964
	2009.09-2017.01	Front Axle Left & Right Lower Outer	Hatchback 4WD CDNC	Date to:2011.08	Ball Joint	S080283
	2009.09-2017.01	Front Axle Left & Right Lower Outer	Hatchback 4WD CDNC	Date from:2011.08	Ball Joint	S080987
	2009.09-2017.01	Front Axle Left & Right Upper	Hatchback 4WD CDNC		Control Arm Bushing	510136
	2009.09-2017.01	Front Axle Left & Right Lower Inner	Hatchback 4WD CDNC		Control Arm Bushing	530214
	2009.09-2017.01	Front Axle Left & Right Lower Inner	Hatchback 4WD CDNC		Control Arm Bushing	531929
	2009.09-2017.01	Front Axle Left & Right Lower Inner	Hatchback 4WD CDNC		Control Arm Bushing	531931
	2009.09-2017.01	Front Axle Left & Right Lower Outer	Hatchback 4WD CDNC	Date to:2011.08	Control Arm Bushing	510299
	2009.09-2017.01	Front Axle Left & Right Lower Outer	Hatchback 4WD CDNC		Control Arm Bushing	530215
	2009.09-2017.01	Rear Axle Left & Right Lower Inner	Hatchback 4WD CDNC		Control Arm Bushing	533477
	2009.09-2017.01	Front Axle Left & Right	Hatchback 4WD CDNC		Tie Rod Axle Joint	S030342
	2009.09-2017.01	Front Axle Left	Hatchback 4WD CDNC		Tie Rod End	S070024
	2009.09-2017.01	Front Axle Right	Hatchback 4WD CDNC		Tie Rod End	S070025
	2009.09-2017.01	Front Axle Left & Right	Hatchback 4WD CDNC	Chassis no.from:8T-8-011 201	Rod/Strut, stabiliser	S050473
	2009.09-2017.01	Front Axle Left & Right	Hatchback 4WD CDNC	not For PR no.:X4M/X5F	Rod/Strut, stabiliser	S051258
	2009.09-2017.01	Rear Axle Left & Right	Hatchback 4WD CDNC		Rod/Strut, stabiliser	S050472
	2009.09-2017.01	Front Axle	Hatchback 4WD CDNC		Stabiliser Bushing	510138
	2009.09-2017.01	Front Axle	Hatchback 4WD CDNC	for PR no.:1BA/1BB/1BL+K8R	Stabiliser Bushing	532578
2.0 (165 kw)	2013.05-2016.05	Front Axle Left Upper Inner	Hatchback 4WD CNCD		Track Control Arm	S060804
	2013.05-2016.05	Front Axle Left Upper Outer	Hatchback 4WD CNCD		Track Control Arm	S060802
	2013.05-2016.05	Front Axle Right Upper Inner	Hatchback 4WD CNCD		Track Control Arm	S060805
	2013.05-2016.05	Front Axle Right Upper Outer	Hatchback 4WD CNCD		Track Control Arm	S060803
	2013.05-2016.05	Rear Axle Left Upper	Hatchback 4WD CNCD		Track Control Arm	S061397
	2013.05-2016.05	Rear Axle Left Lower Outer	Hatchback 4WD CNCD		Track Control Arm	S062748
	2013.05-2016.05	Rear Axle Right Upper	Hatchback 4WD CNCD		Track Control Arm	S061398
	2013.05-2016.05	Rear Axle Right Lower Outer	Hatchback 4WD CNCD		Track Control Arm	S062749
	2013.05-2016.05	Rear Axle Left & Right Lower Inner	Hatchback 4WD CNCD		Track Control Arm	S062964
	2013.05-2016.05	Front Axle Left & Right Lower Outer	Hatchback 4WD CNCD		Ball Joint	S080987
	2013.05-2016.05	Front Axle Left & Right Upper	Hatchback 4WD CNCD		Control Arm Bushing	510136
	2013.05-2016.05	Front Axle Left & Right Lower Inner	Hatchback 4WD CNCD		Control Arm Bushing	530214
	2013.05-2016.05	Front Axle Left & Right Lower Inner	Hatchback 4WD CNCD		Control Arm Bushing	531929
	2013.05-2016.05	Front Axle Left & Right Lower Inner	Hatchback 4WD CNCD		Control Arm Bushing	531931
	2013.05-2016.05	Front Axle Left & Right Lower Outer	Hatchback 4WD CNCD		Control Arm Bushing	510299
	2013.05-2016.05	Front Axle Left & Right Lower Outer	Hatchback 4WD CNCD		Control Arm Bushing	530215
	2013.05-2016.05	Rear Axle Left & Right Lower Inner	Hatchback 4WD CNCD		Control Arm Bushing	533477
	2013.05-2016.05	Front Axle Left & Right	Hatchback 4WD CNCD		Tie Rod Axle Joint	S030342
	2013.05-2016.05	Front Axle Left	Hatchback 4WD CNCD		Tie Rod End	S070024
	2013.05-2016.05	Front Axle Right	Hatchback 4WD CNCD		Tie Rod End	S070025
	2013.05-2016.05	Front Axle Left & Right	Hatchback 4WD CNCD	Chassis no.from:8T-8-011 201	Rod/Strut, stabiliser	S050473
	2013.05-2016.05	Front Axle Left & Right	Hatchback 4WD CNCD	not For PR no.:X4M/X5F	Rod/Strut, stabiliser	S051258
	2013.05-2016.05	Rear Axle Left & Right	Hatchback 4WD CNCD		Rod/Strut, stabiliser	S050472
	2013.05-2016.05	Front Axle	Hatchback 4WD CNCD		Stabiliser Bushing	510138
	2013.05-2016.05	Front Axle	Hatchback 4WD CNCD		Stabiliser Bushing	532578
2.0 (185 kw)	2016.09-	Front Axle Left Upper Inner	Hatchback 4WD CYMC/CYRB		Track Control Arm	S062930
	2016.09-	Front Axle Left Lower Outer	Hatchback 4WD CYMC/CYRB		Track Control Arm	S062924
	2016.09-	Front Axle Left Upper Outer	Hatchback 4WD CYMC/CYRB		Track Control Arm	S062928
	2016.09-	Front Axle Right Upper Inner	Hatchback 4WD CYMC/CYRB		Track Control Arm	S062931
	2016.09-	Front Axle Right Lower Outer	Hatchback 4WD CYMC/CYRB		Track Control Arm	S062925



	 YEAR	FITTING POSITION	BODY STYLE & DRIVE TYPE & ENGINE	REMARKS	PRODUCT	GSP Ref.
AUDI						
A5 Sportback Quattro						
2.0 (185 kw)	2016.09-	Front Axle Right Upper Outer	Hatchback 4WD CYMC/CYRB		Track Control Arm	S062929
	2016.09-	Front Axle Left & Right Lower Outer	Hatchback 4WD CYMC/CYRB		Ball Joint	S080987
	2016.09-	Front Axle Left & Right Upper	Hatchback 4WD CYMC/CYRB		Control Arm Bushing	533522
	2016.09-	Front Axle Left & Right Lower Inner	Hatchback 4WD CYMC/CYRB		Control Arm Bushing	531931
	2016.09-	Front Axle Left & Right Lower Outer	Hatchback 4WD CYMC/CYRB		Control Arm Bushing	510299
	2016.09-	Front Axle Left & Right Lower Outer	Hatchback 4WD CYMC/CYRB		Control Arm Bushing	530215
	2016.09-	Front Axle Left & Right	Hatchback 4WD CYMC/CYRB		Tie Rod Axle Joint	S030931
	2016.09-	Front Axle Left	Hatchback 4WD CYMC/CYRB		Tie Rod End	S071632
	2016.09-	Front Axle Right	Hatchback 4WD CYMC/CYRB		Tie Rod End	S071634
	2016.09-	Front Axle Left & Right	Hatchback 4WD CYMC/CYRB		Rod/Strut, stabiliser	S051258
	2016.09-	Rear Axle Left & Right	Hatchback 4WD CYMC/CYRB		Rod/Strut, stabiliser	S051433
	2016.09-	Front Axle	Hatchback 4WD CYMC/CYRB		Stabiliser Bushing	510138
	2016.09-	Front Axle	Hatchback 4WD CYMC/CYRB		Stabiliser Bushing	532579
A6						
2.0 (185 kw)	2014.09-2018.09	Rear Axle Left Upper	Saloon FWD CYNB/CYPA		Track Control Arm	S061397
	2014.09-2018.09	Rear Axle Left Lower Inner	Saloon FWD CYNB/CYPA		Track Control Arm	S061574
	2014.09-2018.09	Rear Axle Left Lower Outer	Saloon FWD CYNB/CYPA		Track Control Arm	S062748
	2014.09-2018.09	Rear Axle Right Upper	Saloon FWD CYNB/CYPA		Track Control Arm	S061398
	2014.09-2018.09	Rear Axle Right Lower Inner	Saloon FWD CYNB/CYPA		Track Control Arm	S061575
	2014.09-2018.09	Rear Axle Right Lower Outer	Saloon FWD CYNB/CYPA		Track Control Arm	S062749
	2014.09-2018.09	Rear Axle Left & Right Lower Inner	Saloon FWD CYNB/CYPA		Track Control Arm	S062964
	2014.09-2018.09	Front Axle Left & Right Lower Outer	Saloon FWD CYNB/CYPA		Ball Joint	S080987
	2014.09-2018.09	Front Axle Left & Right Upper	Saloon FWD CYNB/CYPA		Control Arm Bushing	519053
	2014.09-2018.09	Front Axle Left & Right Lower Inner	Saloon FWD CYNB/CYPA		Control Arm Bushing	531929
	2014.09-2018.09	Front Axle Left & Right Lower Outer	Saloon FWD CYNB/CYPA		Control Arm Bushing	510299
	2014.09-2018.09	Front Axle Left & Right Lower Outer	Saloon FWD CYNB/CYPA		Control Arm Bushing	530215
	2014.09-2018.09	Rear Axle Left & Right Lower Inner	Saloon FWD CYNB/CYPA		Control Arm Bushing	533477
	2014.09-2018.09	Front Axle Left & Right	Saloon FWD CYNB/CYPA		Tie Rod Axle Joint	S030654
	2014.09-2018.09	Front Axle Left	Saloon FWD CYNB/CYPA		Tie Rod End	S070024
	2014.09-2018.09	Front Axle Right	Saloon FWD CYNB/CYPA		Tie Rod End	S070025
	2014.09-2018.09	Front Axle Left & Right	Saloon FWD CYNB/CYPA	Aluminum Material	Rod/Strut, stabiliser	S050473
	2014.09-2018.09	Front Axle Left & Right	Saloon FWD CYNB/CYPA	For PR no.:1BA/1BE/1BH/1BR,1BV	Rod/Strut, stabiliser	S051258
	2014.09-2018.09	Rear Axle Left & Right	Saloon FWD CYNB/CYPA		Rod/Strut, stabiliser	S050472
	2014.09-2018.09	Front Axle	Saloon FWD CYNB/CYPA		Stabiliser Bushing	510138
	2014.09-2018.09	Front Axle	Saloon FWD CYNB/CYPA		Stabiliser Bushing	532578
	2014.09-2018.09	Front Axle	Saloon FWD CYNB/CYPA		Stabiliser Bushing	532579
2.4 (100 kw)	1997.08-2005.01	Front Axle Left Lower Inner	Estate FWD ALW/ARN/ASM		Track Control Arm	S060055
	1997.08-2005.01	Front Axle Left Upper Inner	Estate FWD ALW/ARN/ASM		Track Control Arm	S062331
	1997.08-2005.01	Front Axle Left Upper Outer	Estate FWD ALW/ARN/ASM	Engine code:ASM,Chassis no. from 4B-2-000 001 / For PR no. 189118z	Track Control Arm	S060048
	1997.08-2005.01	Front Axle Left Upper Outer	Estate FWD ALW/ARN/ASM	Engine code:ASM,Chassis no. from 4B-2-000 001 / For PR no. 189118z	Track Control Arm	S060798
	1997.08-2005.01	Front Axle Left Upper Outer	Estate FWD ALW/ARN/ASM	Engine code:ASM,Chassis no. from 4B-2-000 001 / For PR no. 189118z	Track Control Arm	S062530
	1997.08-2005.01	Front Axle Right Lower Inner	Estate FWD ALW/ARN/ASM		Track Control Arm	S060056
	1997.08-2005.01	Front Axle Right Upper Inner	Estate FWD ALW/ARN/ASM	for vehicles with sports suspension	Track Control Arm	S060801
	1997.08-2005.01	Front Axle Right Upper Inner	Estate FWD ALW/ARN/ASM	Engine code:ASM,Chassis no. from 4B-2-000 001 / For PR no. 189118z	Track Control Arm	S062332
	1997.08-2005.01	Front Axle Right Upper Outer	Estate FWD ALW/ARN/ASM		Track Control Arm	S060049
	1997.08-2005.01	Front Axle Right Upper Outer	Estate FWD ALW/ARN/ASM	Engine code:ASM,Chassis no. from 4B-2-000 001 / For PR no. 189118z	Track Control Arm	S060799
	1997.08-2005.01	Front Axle Right Upper Outer	Estate FWD ALW/ARN/ASM	Engine code:ASM,Chassis no. from 4B-2-000 001 / For PR no. 189118z	Track Control Arm	S062531
	1997.08-2005.01	Front Axle Left & Right Lower Outer	Estate FWD ALW/ARN/ASM	Engine code:ASM,Chassis no. from 4B-2-031 501	Track Control Arm	S060023
	1997.08-2005.01	Front Axle Left & Right Lower Outer	Estate FWD ALW/ARN/ASM	Engine code:ARN,ALW,Engine code:ASM,Chassis no. to 4B-2-031 500	Track Control Arm	S060054
	1997.08-2005.01	Front Axle Left & Right Upper	Estate FWD ALW/ARN/ASM		Control Arm Bushing	510136
	1997.08-2005.01	Front Axle Left & Right Lower Inner	Estate FWD ALW/ARN/ASM		Control Arm Bushing	510287
	1997.08-2005.01	Front Axle Left & Right Lower Outer	Estate FWD ALW/ARN/ASM		Control Arm Bushing	510133
	1997.08-2005.01	Front Axle Left & Right Lower Outer	Estate FWD ALW/ARN/ASM		Control Arm Bushing	510134
	1997.08-2005.01	Front Axle	Estate FWD ALW/ARN/ASM		Suspension Repair Kit	S990067SK
	1997.08-2005.01	Front Axle Left & Right	Estate FWD ALW/ARN/ASM		Rod Assembly	S100014
	1997.08-2005.01	Front Axle Left & Right	Estate FWD ALW/ARN/ASM	Engine code:ASM,Chassis no. from 4B-2-000 001	Tie Rod End	S070016
	1997.08-2005.01	Front Axle Left & Right	Estate FWD ALW/ARN/ASM	Engine code:ARN,ALW,Engine code:ASM,4B-1200 000	Tie Rod End	S070038
	1997.08-2005.01	Front Axle Left	Estate FWD ALW/ARN/ASM		Rod/Strut, stabiliser	520008
	1997.08-2005.01	Front Axle Left	Estate FWD ALW/ARN/ASM	Equipment Vari.:exc.Allroad	Rod/Strut, stabiliser	S050034
	1997.08-2005.01	Front Axle Right	Estate FWD ALW/ARN/ASM		Rod/Strut, stabiliser	520010
	1997.08-2005.01	Front Axle Right	Estate FWD ALW/ARN/ASM	Equipment Vari.:exc.Allroad	Rod/Strut, stabiliser	S050033
	1997.08-2005.01	Front Axle	Estate FWD ALW/ARN/ASM		Stabiliser Bushing	510139
	1997.08-2005.01	Front Axle	Estate FWD ALW/ARN/ASM		Stabiliser Bushing	517806
	1997.08-2005.01	Front Axle Left	Estate FWD ALW/ARN/ASM		Steering Boot	540043



	 YEAR	FITTING POSITION	BODY STYLE & DRIVE TYPE & ENGINE	REMARKS	PRODUCT	GSP Ref.
AUDI A6						
2.4 (100 kw)	1997.08-2005.01	Front Axle Right	Estate FWD ALW/ARN/ASM		Steering Rack Bellow Kit	540211S
2.4 (121 kw)	1997.04-2001.09	Front Axle Left Lower Inner	Saloon FWD AGA/ALF/AML/APS/ARJ		Track Control Arm	S060055
	1997.04-2001.09	Front Axle Left Upper Inner	Saloon FWD AGA/ALF/AML/APS/ARJ		Track Control Arm	S062331
	1997.04-2001.09	Front Axle Left Upper Outer	Saloon FWD AGA/ALF/AML/APS/ARJ		Track Control Arm	S060048
	1997.04-2001.09	Front Axle Left Upper Outer	Saloon FWD AGA/ALF/AML/APS/ARJ		Track Control Arm	S060798
	1997.04-2001.09	Front Axle Left Upper Outer	Saloon FWD AGA/ALF/AML/APS/ARJ		Track Control Arm	S062530
	1997.04-2001.09	Front Axle Right Lower Inner	Saloon FWD AGA/ALF/AML/APS/ARJ		Track Control Arm	S060056
	1997.04-2001.09	Front Axle Right Upper Inner	Saloon FWD AGA/ALF/AML/APS/ARJ	for vehicles with sports suspension	Track Control Arm	S060801
	1997.04-2001.09	Front Axle Right Upper Inner	Saloon FWD AGA/ALF/AML/APS/ARJ		Track Control Arm	S062332
	1997.04-2001.09	Front Axle Right Upper Outer	Saloon FWD AGA/ALF/AML/APS/ARJ		Track Control Arm	S060049
	1997.04-2001.09	Front Axle Right Upper Outer	Saloon FWD AGA/ALF/AML/APS/ARJ		Track Control Arm	S062531
	1997.04-2001.09	Front Axle Left & Right Lower Outer	Saloon FWD AGA/ALF/AML/APS/ARJ		Track Control Arm	S060054
	1997.04-2001.09	Front Axle Left & Right Lower Inner	Saloon FWD AGA/ALF/AML/APS/ARJ		Control Arm Bushing	510287
	1997.04-2001.09	Front Axle Left & Right Lower Outer	Saloon FWD AGA/ALF/AML/APS/ARJ		Control Arm Bushing	510133
	1997.04-2001.09	Front Axle Left & Right Lower Outer	Saloon FWD AGA/ALF/AML/APS/ARJ		Control Arm Bushing	510134
	1997.04-2001.09	Front Axle	Saloon FWD AGA/ALF/AML/APS/ARJ		Suspension Repair Kit	S990001SK
	1997.04-2001.09	Front Axle	Saloon FWD AGA/ALF/AML/APS/ARJ	Equipment Var. exc.Allroad	Suspension Repair Kit	S990067SK
	1997.04-2001.09	Front Axle Left & Right	Saloon FWD AGA/ALF/AML/APS/ARJ		Rod Assembly	S100014
	1997.04-2001.09	Front Axle Left & Right	Saloon FWD AGA/ALF/AML/APS/ARJ		Tie Rod End	S070038
	1997.04-2001.09	Front Axle Left	Saloon FWD AGA/ALF/AML/APS/ARJ		Rod/Strut, stabiliser	520008
	1997.04-2001.09	Front Axle Left	Saloon FWD AGA/ALF/AML/APS/ARJ	Equipment Var. exc.Allroad	Rod/Strut, stabiliser	S050034
	1997.04-2001.09	Front Axle Right	Saloon FWD AGA/ALF/AML/APS/ARJ		Rod/Strut, stabiliser	520010
	1997.04-2001.09	Front Axle Right	Saloon FWD AGA/ALF/AML/APS/ARJ	Equipment Var. exc.Allroad	Rod/Strut, stabiliser	S050033
	1997.04-2001.09	Front Axle	Saloon FWD AGA/ALF/AML/APS/ARJ		Stabiliser Bushing	510139
	1997.04-2001.09	Front Axle	Saloon FWD AGA/ALF/AML/APS/ARJ		Stabiliser Bushing	517806
	1997.04-2001.09	Rear Axle	Saloon FWD AGA/ALF/AML/APS/ARJ		Stabiliser Bushing	517807
	1997.04-2001.09	Front Axle Left	Saloon FWD AGA/ALF/AML/APS/ARJ		Steering Boot	540043
	1997.04-2001.09	Front Axle Right	Saloon FWD AGA/ALF/AML/APS/ARJ		Steering Rack Bellow Kit	540211S
2.8 (128 kw)	1994.06-1997.10	Front Axle Left Lower	Saloon FWD AAH		Track Control Arm	S060040
	1994.06-1997.10	Front Axle Right Lower	Saloon FWD AAH		Track Control Arm	S060041
	1994.06-1997.10	Front Axle Left & Right Lower	Saloon FWD AAH	Quantity:2	Control Arm Bushing	510126
	1994.06-1997.10	Front Axle Left & Right Lower	Saloon FWD AAH		Control Arm Bushing	510127
	1994.06-1997.10	Front Axle Left	Saloon FWD AAH		Rod Assembly	S100007
	1994.06-1997.10	Front Axle Right	Saloon FWD AAH		Rod Assembly	S100008
	1994.06-1997.10	Front Axle Left	Saloon FWD AAH		Tie Rod End	S070022
	1994.06-1997.10	Front Axle Right	Saloon FWD AAH		Tie Rod End	S070023
	1994.06-1997.10	Rear Axle Left & Right	Saloon FWD AAH		Rod/Strut, stabiliser	S070017
	1994.06-1997.10	Front Axle	Saloon FWD AAH		Stabiliser Bushing	510128
	1994.06-1997.10	Front Axle	Saloon FWD AAH		Stabiliser Bushing	510139
	1994.06-1997.10	Front Axle	Saloon FWD AAH		Steering Boot	540021
	1994.06-1997.10	Front Axle	Saloon FWD AAH		Sleeve, control arm mounting	530196
	2.8 (142 kw)	1997.05-2001.09	Front Axle Left Lower Inner	Saloon FWD ACK/ALG/AMX/APR/AQD		Track Control Arm
1997.05-2001.09		Front Axle Left Upper Inner	Saloon FWD ACK/ALG/AMX/APR/AQD		Track Control Arm	S062331
1997.05-2001.09		Front Axle Left Upper Outer	Saloon FWD ACK/ALG/AMX/APR/AQD		Track Control Arm	S060048
1997.05-2001.09		Front Axle Left Upper Outer	Saloon FWD ACK/ALG/AMX/APR/AQD		Track Control Arm	S060798
1997.05-2001.09		Front Axle Left Upper Outer	Saloon FWD ACK/ALG/AMX/APR/AQD		Track Control Arm	S062530
1997.05-2001.09		Front Axle Right Lower Inner	Saloon FWD ACK/ALG/AMX/APR/AQD		Track Control Arm	S060056
1997.05-2001.09		Front Axle Right Upper Inner	Saloon FWD ACK/ALG/AMX/APR/AQD	for vehicles with sports suspension	Track Control Arm	S060801
1997.05-2001.09		Front Axle Right Upper Inner	Saloon FWD ACK/ALG/AMX/APR/AQD	Engine code:AMX,APR,ALG,ACK,AGD,Engine code:ATQ,not For PR no.18V	Track Control Arm	S062332
1997.05-2001.09		Front Axle Right Upper Outer	Saloon FWD ACK/ALG/AMX/APR/AQD		Track Control Arm	S060049
1997.05-2001.09		Front Axle Right Upper Outer	Saloon FWD ACK/ALG/AMX/APR/AQD		Track Control Arm	S062531
1997.05-2001.09		Front Axle Left & Right Lower Outer	Saloon FWD ACK/ALG/AMX/APR/AQD		Track Control Arm	S060054
1997.05-2001.09		Front Axle Left & Right Lower Inner	Saloon FWD ACK/ALG/AMX/APR/AQD		Control Arm Bushing	510287
1997.05-2001.09		Front Axle Left & Right Lower Outer	Saloon FWD ACK/ALG/AMX/APR/AQD		Control Arm Bushing	510133
1997.05-2001.09		Front Axle Left & Right Lower Outer	Saloon FWD ACK/ALG/AMX/APR/AQD		Control Arm Bushing	510134
1997.05-2001.09		Front Axle	Saloon FWD ACK/ALG/AMX/APR/AQD		Suspension Repair Kit	S990001SK
1997.05-2001.09		Front Axle	Saloon FWD ACK/ALG/AMX/APR/AQD	Equipment Var. exc.Allroad	Suspension Repair Kit	S990067SK
1997.05-2001.09		Front Axle Left & Right	Saloon FWD ACK/ALG/AMX/APR/AQD		Rod Assembly	S100014
1997.05-2001.09		Front Axle Left & Right	Saloon FWD ACK/ALG/AMX/APR/AQD	Engine code:ATQ	Tie Rod End	S070016
1997.05-2001.09		Front Axle Left & Right	Saloon FWD ACK/ALG/AMX/APR/AQD		Tie Rod End	S070038
1997.05-2001.09		Front Axle Left	Saloon FWD ACK/ALG/AMX/APR/AQD		Rod/Strut, stabiliser	520008
1997.05-2001.09		Front Axle Left	Saloon FWD ACK/ALG/AMX/APR/AQD	Equipment Var. exc.Allroad	Rod/Strut, stabiliser	S050034
1997.05-2001.09		Front Axle Right	Saloon FWD ACK/ALG/AMX/APR/AQD		Rod/Strut, stabiliser	520010
1997.05-2001.09		Front Axle Right	Saloon FWD ACK/ALG/AMX/APR/AQD	Equipment Var. exc.Allroad	Rod/Strut, stabiliser	S050033



	 YEAR	FITTING POSITION	BODY STYLE & DRIVE TYPE & ENGINE	REMARKS	PRODUCT	GSP Ref.
AUDI A6						
2.8 (142 kw)	1997.05-2001.09	Front Axle	Saloon FWD ACK/ALG/AMX/APR/AQD		Stabiliser Bushing	510139
	1997.05-2001.09	Front Axle	Saloon FWD ACK/ALG/AMX/APR/AQD		Stabiliser Bushing	517806
	1997.05-2001.09	Rear Axle	Saloon FWD ACK/ALG/AMX/APR/AQD		Stabiliser Bushing	517807
	1997.05-2001.09	Front Axle Left	Saloon FWD ACK/ALG/AMX/APR/AQD		Steering Boot	540043
	1997.05-2001.09	Front Axle Right	Saloon FWD ACK/ALG/AMX/APR/AQD		Steering Rack Bellow Kit	540211S
	1997.06-2001.09	Front Axle Left Lower Inner	Estate FWD ACK/ALG/AMX/APR/AQD		Track Control Arm	S060055
	1997.06-2001.09	Front Axle Left Upper Inner	Estate FWD ACK/ALG/AMX/APR/AQD		Track Control Arm	S062331
	1997.06-2001.09	Front Axle Left Upper Outer	Estate FWD ACK/ALG/AMX/APR/AQD		Track Control Arm	S060048
	1997.06-2001.09	Front Axle Left Upper Outer	Estate FWD ACK/ALG/AMX/APR/AQD		Track Control Arm	S060798
	1997.06-2001.09	Front Axle Left Upper Outer	Estate FWD ACK/ALG/AMX/APR/AQD		Track Control Arm	S062530
	1997.06-2001.09	Front Axle Right Lower Inner	Estate FWD ACK/ALG/AMX/APR/AQD		Track Control Arm	S060056
	1997.06-2001.09	Front Axle Right Upper Inner	Estate FWD ACK/ALG/AMX/APR/AQD	for vehicles with sports suspension	Track Control Arm	S060801
	1997.06-2001.09	Front Axle Right Upper Inner	Estate FWD ACK/ALG/AMX/APR/AQD		Track Control Arm	S062332
	1997.06-2001.09	Front Axle Right Upper Outer	Estate FWD ACK/ALG/AMX/APR/AQD		Track Control Arm	S060049
	1997.06-2001.09	Front Axle Right Upper Outer	Estate FWD ACK/ALG/AMX/APR/AQD		Track Control Arm	S062531
	1997.06-2001.09	Front Axle Left & Right Lower Outer	Estate FWD ACK/ALG/AMX/APR/AQD		Track Control Arm	S060054
	1997.06-2001.09	Front Axle Left & Right Lower Inner	Estate FWD ACK/ALG/AMX/APR/AQD		Control Arm Bushing	510287
	1997.06-2001.09	Front Axle Left & Right Lower Outer	Estate FWD ACK/ALG/AMX/APR/AQD		Control Arm Bushing	510133
	1997.06-2001.09	Front Axle Left & Right Lower Outer	Estate FWD ACK/ALG/AMX/APR/AQD		Control Arm Bushing	510134
	1997.06-2001.09	Front Axle	Estate FWD ACK/ALG/AMX/APR/AQD		Suspension Repair Kit	S990001SK
	1997.06-2001.09	Front Axle	Estate FWD ACK/ALG/AMX/APR/AQD	Equipment Vari. exc.Allroad	Suspension Repair Kit	S990067SK
	1997.06-2001.09	Front Axle Left & Right	Estate FWD ACK/ALG/AMX/APR/AQD		Rod Assembly	S100014
	1997.06-2001.09	Front Axle Left & Right	Estate FWD ACK/ALG/AMX/APR/AQD		Tie Rod End	S070038
	1997.06-2001.09	Front Axle Left	Estate FWD ACK/ALG/AMX/APR/AQD		Rod/Strut, stabiliser	520008
	1997.06-2001.09	Front Axle Left	Estate FWD ACK/ALG/AMX/APR/AQD	Equipment Vari. exc.Allroad	Rod/Strut, stabiliser	S050034
	1997.06-2001.09	Front Axle Right	Estate FWD ACK/ALG/AMX/APR/AQD		Rod/Strut, stabiliser	520010
	1997.06-2001.09	Front Axle Right	Estate FWD ACK/ALG/AMX/APR/AQD	Equipment Vari. exc.Allroad	Rod/Strut, stabiliser	S050033
	1997.06-2001.09	Front Axle	Estate FWD ACK/ALG/AMX/APR/AQD		Stabiliser Bushing	510139
	1997.06-2001.09	Front Axle	Estate FWD ACK/ALG/AMX/APR/AQD		Stabiliser Bushing	517806
	1997.06-2001.09	Rear Axle	Estate FWD ACK/ALG/AMX/APR/AQD		Stabiliser Bushing	517807
	1997.06-2001.09	Front Axle Left	Estate FWD ACK/ALG/AMX/APR/AQD		Steering Boot	540043
	1997.06-2001.09	Front Axle Right	Estate FWD ACK/ALG/AMX/APR/AQD		Steering Rack Bellow Kit	540211S
3.0 (160 kw)	2001.06-2005.01	Front Axle Left Lower Inner	Saloon FWD BBJ		Track Control Arm	S060055
	2001.06-2005.01	Front Axle Left Upper Outer	Saloon FWD BBJ		Track Control Arm	S060048
	2001.06-2005.01	Front Axle Right Lower Inner	Saloon FWD BBJ		Track Control Arm	S060056
	2001.06-2005.01	Front Axle Right Upper Inner	Saloon FWD BBJ		Track Control Arm	S060801
	2001.06-2005.01	Front Axle Right Upper Outer	Saloon FWD BBJ		Track Control Arm	S060049
	2001.06-2005.01	Front Axle Left & Right Upper	Saloon FWD BBJ		Control Arm Bushing	510136
	2001.06-2005.01	Front Axle	Saloon FWD BBJ		Suspension Repair Kit	S990067SK
	2001.06-2005.01	Front Axle Left & Right	Saloon FWD BBJ		Tie Rod End	S070038
	2001.06-2005.01	Front Axle Left	Saloon FWD BBJ		Rod/Strut, stabiliser	S050034
	2001.06-2005.01	Front Axle Right	Saloon FWD BBJ		Rod/Strut, stabiliser	S050033
	2001.06-2005.01	Rear Axle Left & Right	Saloon FWD BBJ		Rod/Strut, stabiliser	S070017
	2001.06-2005.01	Front Axle	Saloon FWD BBJ		Stabiliser Bushing	510139
	2001.06-2005.01	Front Axle	Saloon FWD BBJ		Stabiliser Bushing	517806
	2004.04-2006.05	Front Axle Left Lower Inner	Saloon FWD BBJ		Track Control Arm	S060029
	2004.04-2006.05	Front Axle Left Upper Inner	Saloon FWD BBJ		Track Control Arm	S060050
	2004.04-2006.05	Front Axle Left Upper Outer	Saloon FWD BBJ		Track Control Arm	S060052
	2004.04-2006.05	Front Axle Right Lower Inner	Saloon FWD BBJ		Track Control Arm	S060030
	2004.04-2006.05	Front Axle Right Upper Inner	Saloon FWD BBJ		Track Control Arm	S060051
	2004.04-2006.05	Front Axle Right Upper Outer	Saloon FWD BBJ		Track Control Arm	S060053
	2004.04-2006.05	Front Axle Left & Right Lower Outer	Saloon FWD BBJ		Track Control Arm	S060028
	2004.04-2006.05	Rear Axle Left & Right Lower Outer	Saloon FWD BBJ		Track Control Arm	S061506
	2004.04-2006.05	Front Axle Left & Right Upper	Saloon FWD BBJ		Control Arm Bushing	510136
	2004.04-2006.05	Front Axle Left & Right Lower Inner	Saloon FWD BBJ		Control Arm Bushing	510301
	2004.04-2006.05	Front Axle Left & Right Lower Inner	Saloon FWD BBJ		Control Arm Bushing	531929
	2004.04-2006.05	Front Axle Left & Right Lower Outer	Saloon FWD BBJ		Control Arm Bushing	510299
	2004.04-2006.05	Front Axle Left & Right Lower Outer	Saloon FWD BBJ		Control Arm Bushing	531954
	2004.04-2006.05	Rear Axle Left & Right Lower Outer	Saloon FWD BBJ		Control Arm Bushing	510393
	2004.04-2006.05	Rear Axle Left & Right Lower Outer	Saloon FWD BBJ		Control Arm Bushing	510394
	2004.04-2006.05	Front Axle Left & Right	Saloon FWD BBJ		Tie Rod Axle Joint	S030341
	2004.04-2006.05	Front Axle Left & Right	Saloon FWD BBJ		Tie Rod End	S070016
	2004.04-2006.05	Front Axle Left & Right	Saloon FWD BBJ		Rod/Strut, stabiliser	S050022
	2004.04-2006.05	Rear Axle Left & Right	Saloon FWD BBJ		Rod/Strut, stabiliser	S050025



	 YEAR	FITTING POSITION	BODY STYLE & DRIVE TYPE & ENGINE	REMARKS	PRODUCT	GSP Ref.	
AUDI A6							
3.0 (160 kw)	2004.04-2006.05	Rear Axle Left & Right	Saloon FWD BBJ	Chassis no.to:4B-5-050 000	Rod/Strut,stabiliser	S070017	
	2004.04-2006.05	Front Axle	Saloon FWD BBJ	Stabiliser Ø:27 mm	Stabiliser Bushing	510139	
	2004.04-2006.05	Front Axle	Saloon FWD BBJ		Stabiliser Bushing	517806	
3.2 (188 kw)	2004.04-2009.05	Front Axle Left Lower Inner	Saloon FWD AUK/BKH		Track Control Arm	S060029	
	2004.04-2009.05	Front Axle Left Upper Inner	Saloon FWD AUK/BKH		Track Control Arm	S060050	
	2004.04-2009.05	Front Axle Left Upper Outer	Saloon FWD AUK/BKH		Track Control Arm	S060052	
	2004.04-2009.05	Front Axle Right Lower Inner	Saloon FWD AUK/BKH		Track Control Arm	S060030	
	2004.04-2009.05	Front Axle Right Upper Inner	Saloon FWD AUK/BKH		Track Control Arm	S060051	
	2004.04-2009.05	Front Axle Right Upper Outer	Saloon FWD AUK/BKH		Track Control Arm	S060053	
	2004.04-2009.05	Front Axle Left & Right Lower Outer	Saloon FWD AUK/BKH		Track Control Arm	S060028	
	2004.04-2009.05	Rear Axle Left & Right Lower Outer	Saloon FWD AUK/BKH		Track Control Arm	S061506	
	2004.04-2009.05	Front Axle Left & Right Upper	Saloon FWD AUK/BKH		Control Arm Bushing	510136	
	2004.04-2009.05	Front Axle Left & Right Lower Inner	Saloon FWD AUK/BKH		Control Arm Bushing	510301	
	2004.04-2009.05	Front Axle Left & Right Lower Inner	Saloon FWD AUK/BKH		Control Arm Bushing	531929	
	2004.04-2009.05	Front Axle Left & Right Lower Outer	Saloon FWD AUK/BKH		Control Arm Bushing	510299	
	2004.04-2009.05	Front Axle Left & Right Lower Outer	Saloon FWD AUK/BKH		Control Arm Bushing	531954	
	2004.04-2009.05	Rear Axle Left & Right Lower Outer	Saloon FWD AUK/BKH		Control Arm Bushing	510393	
	2004.04-2009.05	Rear Axle Left & Right Lower Outer	Saloon FWD AUK/BKH		Control Arm Bushing	510394	
	2004.04-2009.05	Front Axle	Saloon FWD AUK/BKH		Suspension Repair Kit	S990014SK	
	2004.04-2009.05	Front Axle Left & Right	Saloon FWD AUK/BKH		Tie Rod Axle Joint	S030341	
	2004.04-2009.05	Front Axle Left & Right	Saloon FWD AUK/BKH		Tie Rod End	S070016	
	2004.04-2009.05	Front Axle Left & Right	Saloon FWD AUK/BKH		Rod/Strut,stabiliser	S050022	
	2004.04-2009.05	Rear Axle Left & Right	Saloon FWD AUK/BKH		Rod/Strut,stabiliser	S050025	
	2004.04-2009.05	Rear Axle Left & Right	Saloon FWD AUK/BKH	Chassis no.to:4B-5-050 000	Rod/Strut,stabiliser	S070017	
	2004.04-2009.05	Front Axle	Saloon FWD AUK/BKH	Stabiliser Ø:27 mm	Stabiliser Bushing	510139	
	2004.04-2009.05	Front Axle	Saloon FWD AUK/BKH		Stabiliser Bushing	517806	
	3.2 (195 kw)	2009.05-2011.03	Front Axle Left Lower Inner	Saloon FWD CALA		Track Control Arm	S060029
2009.05-2011.03		Front Axle Left Upper Inner	Saloon FWD CALA		Track Control Arm	S060050	
2009.05-2011.03		Front Axle Left Upper Outer	Saloon FWD CALA		Track Control Arm	S060052	
2009.05-2011.03		Front Axle Right Lower Inner	Saloon FWD CALA		Track Control Arm	S060030	
2009.05-2011.03		Front Axle Right Upper Inner	Saloon FWD CALA		Track Control Arm	S060051	
2009.05-2011.03		Front Axle Right Upper Outer	Saloon FWD CALA		Track Control Arm	S060053	
2009.05-2011.03		Front Axle Left & Right Lower Outer	Saloon FWD CALA		Track Control Arm	S060028	
2009.05-2011.03		Rear Axle Left & Right Lower Outer	Saloon FWD CALA		Track Control Arm	S061506	
2009.05-2011.03		Front Axle Left & Right Upper	Saloon FWD CALA		Control Arm Bushing	510136	
2009.05-2011.03		Front Axle Left & Right Lower Inner	Saloon FWD CALA		Control Arm Bushing	510301	
2009.05-2011.03		Front Axle Left & Right Lower Outer	Saloon FWD CALA		Control Arm Bushing	510299	
2009.05-2011.03		Front Axle Left & Right Lower Outer	Saloon FWD CALA		Control Arm Bushing	531954	
2009.05-2011.03		Rear Axle Left & Right Lower Outer	Saloon FWD CALA		Control Arm Bushing	510393	
2009.05-2011.03		Front Axle Left & Right	Saloon FWD CALA		Tie Rod Axle Joint	S030341	
2009.05-2011.03		Front Axle Left & Right	Saloon FWD CALA		Tie Rod End	S070016	
2009.05-2011.03		Front Axle Left & Right	Saloon FWD CALA		Rod/Strut,stabiliser	S050022	
2009.05-2011.03		Rear Axle Left & Right	Saloon FWD CALA		Rod/Strut,stabiliser	S050025	
2009.05-2011.03		Rear Axle Left & Right	Saloon FWD CALA	Chassis no.to:4B-5-050 000	Rod/Strut,stabiliser	S070017	
2009.05-2011.03		Front Axle	Saloon FWD CALA		Stabiliser Bushing	510139	
2009.05-2011.03		Front Axle	Saloon FWD CALA		Stabiliser Bushing	517806	
A6 Allroad Quattro							
3.0 (245 kw)		2014.09-2018.09	Rear Axle Left Upper	Estate 4WD CREC		Track Control Arm	S061397
		2014.09-2018.09	Rear Axle Left Lower Inner	Estate 4WD CREC		Track Control Arm	S061574
		2014.09-2018.09	Rear Axle Right Upper	Estate 4WD CREC		Track Control Arm	S061398
	2014.09-2018.09	Rear Axle Right Lower Inner	Estate 4WD CREC		Track Control Arm	S061575	
	2014.09-2018.09	Front Axle Left & Right Lower Outer	Estate 4WD CREC		Ball Joint	S080987	
	2014.09-2018.09	Front Axle Left & Right Upper	Estate 4WD CREC		Control Arm Bushing	519053	
	2014.09-2018.09	Front Axle Left & Right Lower Inner	Estate 4WD CREC		Control Arm Bushing	531929	
	2014.09-2018.09	Front Axle Left & Right Lower Outer	Estate 4WD CREC		Control Arm Bushing	510299	
	2014.09-2018.09	Front Axle Left & Right Lower Outer	Estate 4WD CREC		Control Arm Bushing	530215	
	2014.09-2018.09	Rear Axle Left & Right Lower Inner	Estate 4WD CREC		Control Arm Bushing	533477	
	2014.09-2018.09	Front Axle Left & Right	Estate 4WD CREC		Tie Rod Axle Joint	S030654	
	2014.09-2018.09	Front Axle Left	Estate 4WD CREC		Tie Rod End	S070024	
	2014.09-2018.09	Front Axle Right	Estate 4WD CREC		Tie Rod End	S070025	
	2014.09-2018.09	Front Axle Left & Right	Estate 4WD CREC	not for country-spec.model:Russia	Rod/Strut,stabiliser	S050473	
	2014.09-2018.09	Front Axle Left & Right	Estate 4WD CREC	Plastic Material	Rod/Strut,stabiliser	S051258	
	2014.09-2018.09	Rear Axle Left & Right	Estate 4WD CREC		Rod/Strut,stabiliser	S050472	
	2014.09-2018.09	Front Axle	Estate 4WD CREC		Stabiliser Bushing	532579	



	 YEAR	FITTING POSITION	BODY STYLE & DRIVE TYPE & ENGINE	REMARKS	PRODUCT	GSP Ref.
AUDI A6 Quattro						
2.0 (180 kw)	2018.08-	Front Axle Left Upper Inner	Saloon 4WD DKNA/DLHA		Track Control Arm	S062934
	2018.08-	Front Axle Left Upper Outer	Saloon 4WD DKNA/DLHA		Track Control Arm	S062932
	2018.08-	Front Axle Right Upper Inner	Saloon 4WD DKNA/DLHA		Track Control Arm	S062935
	2018.08-	Front Axle Right Upper Outer	Saloon 4WD DKNA/DLHA		Track Control Arm	S062933
	2018.08-	Front Axle Left & Right Upper	Saloon 4WD DKNA/DLHA		Control Arm Bushing	533901
	2018.08-	Front Axle Left & Right Lower Outer	Saloon 4WD DKNA/DLHA		Control Arm Bushing	510299
	2018.08-	Front Axle Left	Saloon 4WD DKNA/DLHA		Tie Rod End	S071632
	2018.08-	Front Axle Right	Saloon 4WD DKNA/DLHA		Tie Rod End	S071634
	2018.08-	Front Axle Left & Right	Saloon 4WD DKNA/DLHA		Rod/Strut, stabiliser	S051258
	2018.08-	Rear Axle Left & Right	Saloon 4WD DKNA/DLHA		Rod/Strut, stabiliser	S051432
	2018.08-	Rear Axle Left & Right	Saloon 4WD DKNA/DLHA	Date to:2018.10	Rod/Strut, stabiliser	S051433
2.7 (184 kw)	2001.06-2005.01	Front Axle Left Lower Inner	Saloon 4WD ARE/BES		Track Control Arm	S060055
	2001.06-2005.01	Front Axle Left Upper Outer	Saloon 4WD ARE/BES		Track Control Arm	S060048
	2001.06-2005.01	Front Axle Left Upper Outer	Saloon 4WD ARE/BES	For PR no.:1BV/1BJ	Track Control Arm	S060798
	2001.06-2005.01	Front Axle Right Lower Inner	Saloon 4WD ARE/BES		Track Control Arm	S060056
	2001.06-2005.01	Front Axle Right Upper Inner	Saloon 4WD ARE/BES		Track Control Arm	S060801
	2001.06-2005.01	Front Axle Right Upper Outer	Saloon 4WD ARE/BES		Track Control Arm	S060049
	2001.06-2005.01	Front Axle Right Upper Outer	Saloon 4WD ARE/BES	For PR no.:1BV/1BJ	Track Control Arm	S060799
	2001.06-2005.01	Front Axle Right Upper Outer	Saloon 4WD ARE/BES	<small>Engine Code:PR for PR no.:1B0 1B0 engine Code:BSK2 not for PR no.:1B1 1B1</small>	Track Control Arm	S062531
	2001.06-2005.01	Front Axle Left & Right Lower Outer	Saloon 4WD ARE/BES		Track Control Arm	S060023
	2001.06-2005.01	Front Axle Left & Right Upper	Saloon 4WD ARE/BES		Control Arm Bushing	510136
	2001.06-2005.01	Front Axle Left & Right Lower Inner	Saloon 4WD ARE/BES		Control Arm Bushing	510287
	2001.06-2005.01	Front Axle Left & Right Lower Outer	Saloon 4WD ARE/BES		Control Arm Bushing	510133
	2001.06-2005.01	Front Axle Left & Right Lower Outer	Saloon 4WD ARE/BES		Control Arm Bushing	510134
	2001.06-2005.01	Front Axle	Saloon 4WD ARE/BES		Suspension Repair Kit	S990067SK
	2001.06-2005.01	Front Axle Left & Right	Saloon 4WD ARE/BES		Tie Rod End	S070016
	2001.06-2005.01	Front Axle Left & Right	Saloon 4WD ARE/BES		Tie Rod End	S070038
	2001.06-2005.01	Front Axle Left	Saloon 4WD ARE/BES		Rod/Strut, stabiliser	520008
	2001.06-2005.01	Front Axle Left	Saloon 4WD ARE/BES	Equipment Vari.:exc.Allroad	Rod/Strut, stabiliser	S050034
	2001.06-2005.01	Front Axle Right	Saloon 4WD ARE/BES		Rod/Strut, stabiliser	520010
	2001.06-2005.01	Front Axle Right	Saloon 4WD ARE/BES	Equipment Vari.:exc.Allroad	Rod/Strut, stabiliser	S050033
	2001.06-2005.01	Rear Axle Left & Right	Saloon 4WD ARE/BES		Rod/Strut, stabiliser	S070017
	2001.06-2005.01	Front Axle	Saloon 4WD ARE/BES	Stabiliser Ø:25 mm	Stabiliser Bushing	510138
	2001.06-2005.01	Front Axle	Saloon 4WD ARE/BES		Stabiliser Bushing	510139
	2001.06-2005.01	Front Axle	Saloon 4WD ARE/BES		Stabiliser Bushing	517806
	2001.06-2005.01	Rear Axle	Saloon 4WD ARE/BES		Stabiliser Bushing	517807
	2001.06-2005.01	Front Axle Left	Saloon 4WD ARE/BES		Steering Boot	540043
2.8 (128 kw)	1994.06-1997.12	Front Axle Left Lower	Estate 4WD AAH/AFC		Track Control Arm	S060040
	1994.06-1997.12	Front Axle Right Lower	Estate 4WD AAH/AFC		Track Control Arm	S060041
	1994.06-1997.12	Rear Axle Left Upper	Estate 4WD AAH/AFC		Track Control Arm	S060036
	1994.06-1997.12	Rear Axle Right Upper	Estate 4WD AAH/AFC		Track Control Arm	S060037
	1994.06-1997.12	Front Axle Left & Right Lower	Estate 4WD AAH/AFC	Quantity:2	Control Arm Bushing	510126
	1994.06-1997.12	Front Axle Left & Right Lower	Estate 4WD AAH/AFC		Control Arm Bushing	510127
	1994.06-1997.12	Rear Axle Left & Right	Estate 4WD AAH/AFC		Control Arm Bushing	530206
	1994.06-1997.12	Rear Axle Left & Right Lower	Estate 4WD AAH/AFC		Control Arm Bushing	510132
	1994.06-1997.12	Rear Axle Left & Right Lower	Estate 4WD AAH/AFC		Control Arm Bushing	530207
	1994.06-1997.12	Front Axle Left	Estate 4WD AAH/AFC		Rod Assembly	S100007
	1994.06-1997.12	Front Axle Right	Estate 4WD AAH/AFC		Rod Assembly	S100008
	1994.06-1997.12	Front Axle Left	Estate 4WD AAH/AFC		Tie Rod End	S070022
	1994.06-1997.12	Front Axle Right	Estate 4WD AAH/AFC		Tie Rod End	S070023
	1994.06-1997.12	Front Axle	Estate 4WD AAH/AFC		Stabiliser Bushing	510128
	1994.06-1997.12	Front Axle	Estate 4WD AAH/AFC		Stabiliser Bushing	510139
	1994.06-1997.12	Front Axle	Estate 4WD AAH/AFC		Steering Boot	540021
	1994.06-1997.12	Front Axle	Estate 4WD AAH/AFC		Sleeve, control arm mounting	530196
2.8 (142 kw)	1997.08-2001.09	Front Axle Left Lower Inner	Estate 4WD ACK/ALG/AMX/APR/AQD		Track Control Arm	S060055
	1997.08-2001.09	Front Axle Left Upper Inner	Estate 4WD ACK/ALG/AMX/APR/AQD		Track Control Arm	S062331
	1997.08-2001.09	Front Axle Left Upper Outer	Estate 4WD ACK/ALG/AMX/APR/AQD		Track Control Arm	S060048
	1997.08-2001.09	Front Axle Left Upper Outer	Estate 4WD ACK/ALG/AMX/APR/AQD		Track Control Arm	S060798
	1997.08-2001.09	Front Axle Left Upper Outer	Estate 4WD ACK/ALG/AMX/APR/AQD		Track Control Arm	S062530
	1997.08-2001.09	Front Axle Right Lower Inner	Estate 4WD ACK/ALG/AMX/APR/AQD		Track Control Arm	S060056
	1997.08-2001.09	Front Axle Right Upper Inner	Estate 4WD ACK/ALG/AMX/APR/AQD	for vehicles with sports suspension	Track Control Arm	S060801
	1997.08-2001.09	Front Axle Right Upper Inner	Estate 4WD ACK/ALG/AMX/APR/AQD	<small>Engine code:AMX,APR,ALG,ACK,ADD,Engine code:ATD not for PR no.:1B1</small>	Track Control Arm	S062332
	1997.08-2001.09	Front Axle Right Upper Outer	Estate 4WD ACK/ALG/AMX/APR/AQD		Track Control Arm	S060049
	1997.08-2001.09	Front Axle Right Upper Outer	Estate 4WD ACK/ALG/AMX/APR/AQD		Track Control Arm	S062531



	 YEAR	FITTING POSITION	BODY STYLE & DRIVE TYPE & ENGINE	REMARKS	PRODUCT	GSP Ref.
AUDI						
A6 Quattro						
2.8 (142 kw)	1997.08-2001.09	Front Axle Left & Right Lower Outer	Estate 4WD ACK/ALG/AMX/APR/AQD		Track Control Arm	S060054
	1997.08-2001.09	Front Axle Left & Right Lower Inner	Estate 4WD ACK/ALG/AMX/APR/AQD		Control Arm Bushing	510287
	1997.08-2001.09	Front Axle Left & Right Lower Outer	Estate 4WD ACK/ALG/AMX/APR/AQD		Control Arm Bushing	510133
	1997.08-2001.09	Front Axle Left & Right Lower Outer	Estate 4WD ACK/ALG/AMX/APR/AQD		Control Arm Bushing	510134
	1997.08-2001.09	Front Axle	Estate 4WD ACK/ALG/AMX/APR/AQD		Suspension Repair Kit	S990001SK
	1997.08-2001.09	Front Axle	Estate 4WD ACK/ALG/AMX/APR/AQD	<small>Equipment Var.:exc.Allroad Date from 2001.08 Chassis no from 4B-5-050-000</small>	Suspension Repair Kit	S990067SK
	1997.08-2001.09	Front Axle Left & Right	Estate 4WD ACK/ALG/AMX/APR/AQD		Rod Assembly	S100014
	1997.08-2001.09	Front Axle Left & Right	Estate 4WD ACK/ALG/AMX/APR/AQD	Engine code:ATQ	Tie Rod End	S070016
	1997.08-2001.09	Front Axle Left & Right	Estate 4WD ACK/ALG/AMX/APR/AQD		Tie Rod End	S070038
	1997.08-2001.09	Front Axle Left	Estate 4WD ACK/ALG/AMX/APR/AQD		Rod/Strut,stabiliser	520008
	1997.08-2001.09	Front Axle Left	Estate 4WD ACK/ALG/AMX/APR/AQD	Equipment Var.:exc.Allroad	Rod/Strut,stabiliser	S050034
	1997.08-2001.09	Front Axle Right	Estate 4WD ACK/ALG/AMX/APR/AQD		Rod/Strut,stabiliser	520010
	1997.08-2001.09	Front Axle Right	Estate 4WD ACK/ALG/AMX/APR/AQD	Equipment Var.:exc.Allroad	Rod/Strut,stabiliser	S050033
	1997.08-2001.09	Rear Axle Left & Right	Estate 4WD ACK/ALG/AMX/APR/AQD		Rod/Strut,stabiliser	S070017
	1997.08-2001.09	Front Axle	Estate 4WD ACK/ALG/AMX/APR/AQD		Stabiliser Bushing	510139
	1997.08-2001.09	Front Axle	Estate 4WD ACK/ALG/AMX/APR/AQD		Stabiliser Bushing	517806
	1997.08-2001.09	Rear Axle	Estate 4WD ACK/ALG/AMX/APR/AQD		Stabiliser Bushing	517807
	1997.08-2001.09	Front Axle Left	Estate 4WD ACK/ALG/AMX/APR/AQD		Steering Boot	540043
	1997.08-2001.09	Front Axle Right	Estate 4WD ACK/ALG/AMX/APR/AQD		Steering Rack Bellow Kit	540211S
3.0 (213 kw)	2008.10-2011.08	Front Axle Left Lower Inner	Estate 4WD CAJA		Track Control Arm	S060029
	2008.10-2011.08	Front Axle Left Lower Inner	Saloon 4WD CAJA		Track Control Arm	S060029
	2008.10-2011.08	Front Axle Left Upper Inner	Estate 4WD CAJA		Track Control Arm	S060050
	2008.10-2011.08	Front Axle Left Upper Inner	Saloon 4WD CAJA		Track Control Arm	S060050
	2008.10-2011.08	Front Axle Left Upper Outer	Estate 4WD CAJA		Track Control Arm	S060052
	2008.10-2011.08	Front Axle Left Upper Outer	Saloon 4WD CAJA		Track Control Arm	S060052
	2008.10-2011.08	Front Axle Right Lower Inner	Estate 4WD CAJA		Track Control Arm	S060030
	2008.10-2011.08	Front Axle Right Lower Inner	Saloon 4WD CAJA		Track Control Arm	S060030
	2008.10-2011.08	Front Axle Right Upper Inner	Estate 4WD CAJA		Track Control Arm	S060051
	2008.10-2011.08	Front Axle Right Upper Inner	Saloon 4WD CAJA		Track Control Arm	S060051
	2008.10-2011.08	Front Axle Right Upper Outer	Estate 4WD CAJA		Track Control Arm	S060053
	2008.10-2011.08	Front Axle Right Upper Outer	Saloon 4WD CAJA		Track Control Arm	S060053
	2008.10-2011.08	Front Axle Left & Right Lower Outer	Estate 4WD CAJA		Track Control Arm	S060028
	2008.10-2011.08	Front Axle Left & Right Lower Outer	Saloon 4WD CAJA		Track Control Arm	S060028
	2008.10-2011.08	Rear Axle Left & Right Lower Outer	Estate 4WD CAJA		Track Control Arm	S061506
	2008.10-2011.08	Rear Axle Left & Right Lower Outer	Saloon 4WD CAJA		Track Control Arm	S061506
	2008.10-2011.08	Front Axle Left & Right Upper	Estate 4WD CAJA		Control Arm Bushing	510136
	2008.10-2011.08	Front Axle Left & Right Upper	Saloon 4WD CAJA		Control Arm Bushing	510136
	2008.10-2011.08	Front Axle Left & Right Lower Inner	Estate 4WD CAJA		Control Arm Bushing	510301
	2008.10-2011.08	Front Axle Left & Right Lower Inner	Saloon 4WD CAJA		Control Arm Bushing	510301
	2008.10-2011.08	Front Axle Left & Right Lower Inner	Estate 4WD CAJA		Control Arm Bushing	531929
	2008.10-2011.08	Front Axle Left & Right Lower Inner	Saloon 4WD CAJA		Control Arm Bushing	531929
	2008.10-2011.08	Front Axle Left & Right Lower Outer	Estate 4WD CAJA		Control Arm Bushing	510299
	2008.10-2011.08	Front Axle Left & Right Lower Outer	Saloon 4WD CAJA		Control Arm Bushing	510299
	2008.10-2011.08	Front Axle Left & Right Lower Outer	Estate 4WD CAJA		Control Arm Bushing	531954
	2008.10-2011.08	Front Axle Left & Right Lower Outer	Saloon 4WD CAJA		Control Arm Bushing	531954
	2008.10-2011.08	Rear Axle Left & Right Upper	Estate 4WD CAJA		Control Arm Bushing	517141
	2008.10-2011.08	Rear Axle Left & Right Upper	Saloon 4WD CAJA		Control Arm Bushing	517141
	2008.10-2011.08	Rear Axle Left & Right Lower Outer	Estate 4WD CAJA		Control Arm Bushing	510393
	2008.10-2011.08	Rear Axle Left & Right Lower Outer	Saloon 4WD CAJA		Control Arm Bushing	510393
	2008.10-2011.08	Front Axle	Estate 4WD CAJA		Suspension Repair Kit	S990014SK
	2008.10-2011.08	Front Axle	Saloon 4WD CAJA		Suspension Repair Kit	S990014SK
	2008.10-2011.08	Front Axle Left & Right	Estate 4WD CAJA		Tie Rod Axle Joint	S030341
	2008.10-2011.08	Front Axle Left & Right	Saloon 4WD CAJA		Tie Rod Axle Joint	S030341
	2008.10-2011.08	Front Axle Left & Right	Estate 4WD CAJA		Tie Rod End	S070016
	2008.10-2011.08	Front Axle Left & Right	Saloon 4WD CAJA		Tie Rod End	S070016
	2008.10-2011.08	Front Axle Left & Right	Estate 4WD CAJA		Rod/Strut,stabiliser	S050022
	2008.10-2011.08	Front Axle Left & Right	Saloon 4WD CAJA		Rod/Strut,stabiliser	S050022
	2008.10-2011.08	Rear Axle Left & Right	Estate 4WD CAJA		Rod/Strut,stabiliser	S050025
	2008.10-2011.08	Rear Axle Left & Right	Saloon 4WD CAJA		Rod/Strut,stabiliser	S050025
	2008.10-2011.08	Rear Axle Left & Right	Estate 4WD CAJA	Chassis no.to:4B-5-050 000	Rod/Strut,stabiliser	S070017
	2008.10-2011.08	Rear Axle Left & Right	Saloon 4WD CAJA	Chassis no.to:4B-5-050 000	Rod/Strut,stabiliser	S070017
	2008.10-2011.08	Front Axle	Estate 4WD CAJA	Stabiliser Ø:27 mm	Stabiliser Bushing	510139
	2008.10-2011.08	Front Axle	Saloon 4WD CAJA	Stabiliser Ø:27 mm	Stabiliser Bushing	510139
	2008.10-2011.08	Front Axle	Estate 4WD CAJA		Stabiliser Bushing	517806



	 YEAR	FITTING POSITION	BODY STYLE & DRIVE TYPE & ENGINE	REMARKS	PRODUCT	GSP Ref.
AUDI						
A6 Quattro						
3.0 (213 kw)	2008.10-2011.08	Front Axle	Saloon 4WD CAJA		Stabiliser Bushing	517806
3.0 (220 kw)	2010.11-2012.05	Front Axle Left Lower Outer	Saloon 4WD CGWB	Engine Code:CGWB,Date from:2011.08	Track Control Arm	S060806
	2010.11-2012.05	Front Axle Left Upper Outer	Saloon 4WD CGWB		Track Control Arm	S060802
	2010.11-2012.05	Front Axle Right Lower Outer	Saloon 4WD CGWB	Engine Code:CGWB,Date from:2011.08	Track Control Arm	S060807
	2010.11-2012.05	Front Axle Right Upper Outer	Saloon 4WD CGWB		Track Control Arm	S060803
	2010.11-2012.05	Rear Axle Left Upper	Saloon 4WD CGWB		Track Control Arm	S061397
	2010.11-2012.05	Rear Axle Left Lower Inner	Saloon 4WD CGWB		Track Control Arm	S061574
	2010.11-2012.05	Rear Axle Right Upper	Saloon 4WD CGWB		Track Control Arm	S061398
	2010.11-2012.05	Rear Axle Right Lower Inner	Saloon 4WD CGWB		Track Control Arm	S061575
	2010.11-2012.05	Rear Axle Left & Right Lower Inner	Saloon 4WD CGWB		Track Control Arm	S062964
	2010.11-2012.05	Front Axle Left & Right Lower Outer	Saloon 4WD CGWB	Date to:2011.08	Ball Joint	S080283
	2010.11-2012.05	Front Axle Left & Right Lower Outer	Saloon 4WD CGWB	Date from:2011.08	Ball Joint	S080987
	2010.11-2012.05	Front Axle Left & Right Upper	Saloon 4WD CGWB		Control Arm Bushing	519053
	2010.11-2012.05	Front Axle Left & Right Lower Inner	Saloon 4WD CGWB		Control Arm Bushing	531929
	2010.11-2012.05	Front Axle Left & Right Lower Outer	Saloon 4WD CGWB	Date to:2011.08	Control Arm Bushing	510299
	2010.11-2012.05	Front Axle Left & Right Lower Outer	Saloon 4WD CGWB		Control Arm Bushing	530215
	2010.11-2012.05	Rear Axle Left & Right Lower Inner	Saloon 4WD CGWB		Control Arm Bushing	533477
	2010.11-2012.05	Front Axle Left & Right	Saloon 4WD CGWB		Tie Rod Axle Joint	S030654
	2010.11-2012.05	Front Axle Left	Saloon 4WD CGWB		Tie Rod End	S070024
	2010.11-2012.05	Front Axle Right	Saloon 4WD CGWB		Tie Rod End	S070025
	2010.11-2012.05	Front Axle Left & Right	Saloon 4WD CGWB	Date from:2011.06,for PR no.:1BK/1BS	Rod/Strut,stabiliser	S050473
	2010.11-2012.05	Front Axle Left & Right	Saloon 4WD CGWB	For PR no.:1BA/1BE/1BK/1BR/1BS/1BV	Rod/Strut,stabiliser	S051258
	2010.11-2012.05	Rear Axle Left & Right	Saloon 4WD CGWB		Rod/Strut,stabiliser	S050472
	2010.11-2012.05	Front Axle	Saloon 4WD CGWB		Stabiliser Bushing	510138
	2010.11-2012.05	Front Axle	Saloon 4WD CGWB	for vehicles with heavy duty suspension,for PR no.:1BR	Stabiliser Bushing	532578
	2010.11-2012.05	Front Axle	Saloon 4WD CGWB	for vehicles with electronic suspension control,for PR no.:2MB	Stabiliser Bushing	532579
	2011.05-2014.12	Front Axle Left Lower Outer	Estate 4WD CGWB	Date from:2011.08	Track Control Arm	S060806
	2011.05-2014.12	Front Axle Left Lower Outer	Estate 4WD CGWB	Date from:2011.08	Track Control Arm	S062024
	2011.05-2014.12	Front Axle Right Lower Outer	Estate 4WD CGWB	Date from:2011.08	Track Control Arm	S060807
	2011.05-2014.12	Front Axle Right Lower Outer	Estate 4WD CGWB	Date from:2011.08	Track Control Arm	S062025
	2011.05-2014.12	Rear Axle Left Upper	Estate 4WD CGWB		Track Control Arm	S061397
	2011.05-2014.12	Rear Axle Left Lower Inner	Estate 4WD CGWB		Track Control Arm	S061574
	2011.05-2014.12	Rear Axle Right Upper	Estate 4WD CGWB		Track Control Arm	S061398
	2011.05-2014.12	Rear Axle Right Lower Inner	Estate 4WD CGWB		Track Control Arm	S061575
	2011.05-2014.12	Rear Axle Left & Right Lower Inner	Estate 4WD CGWB		Track Control Arm	S062964
	2011.05-2014.12	Front Axle Left & Right Lower Outer	Estate 4WD CGWB	Date to:2011.08	Ball Joint	S080283
	2011.05-2014.12	Front Axle Left & Right Lower Outer	Estate 4WD CGWB	Date from:2011.08	Ball Joint	S080987
	2011.05-2014.12	Front Axle Left & Right Upper	Estate 4WD CGWB		Control Arm Bushing	519053
	2011.05-2014.12	Front Axle Left & Right Lower Inner	Estate 4WD CGWB		Control Arm Bushing	531929
	2011.05-2014.12	Front Axle Left & Right Lower Outer	Estate 4WD CGWB	Date to:2011.08	Control Arm Bushing	510299
	2011.05-2014.12	Front Axle Left & Right Lower Outer	Estate 4WD CGWB		Control Arm Bushing	530215
	2011.05-2014.12	Rear Axle Left & Right Lower Inner	Estate 4WD CGWB		Control Arm Bushing	533477
	2011.05-2014.12	Front Axle Left & Right	Estate 4WD CGWB		Tie Rod Axle Joint	S030654
2011.05-2014.12	Front Axle Left	Estate 4WD CGWB		Tie Rod End	S070024	
2011.05-2014.12	Front Axle Right	Estate 4WD CGWB		Tie Rod End	S070025	
2011.05-2014.12	Front Axle Left & Right	Estate 4WD CGWB	for PR no.:1BK/1BS	Rod/Strut,stabiliser	S050473	
2011.05-2014.12	Front Axle Left & Right	Estate 4WD CGWB	For PR no.:1BA/1BE/1BK/1BR/1BS/1BV	Rod/Strut,stabiliser	S051258	
2011.05-2014.12	Rear Axle Left & Right	Estate 4WD CGWB		Rod/Strut,stabiliser	S050472	
2011.05-2014.12	Front Axle	Estate 4WD CGWB		Stabiliser Bushing	510138	
2011.05-2014.12	Front Axle	Estate 4WD CGWB	for vehicles with heavy duty suspension,for PR no.:1BR	Stabiliser Bushing	532578	
2011.05-2014.12	Front Axle	Estate 4WD CGWB	for vehicles with electronic suspension control,for PR no.:2MB	Stabiliser Bushing	532579	
3.0 (245 kw)	2014.09-2018.09	Rear Axle Left Upper	Saloon 4WD CREC		Track Control Arm	S061397
	2014.09-2018.09	Rear Axle Left Lower Inner	Saloon 4WD CREC		Track Control Arm	S061574
	2014.09-2018.09	Rear Axle Right Upper	Saloon 4WD CREC		Track Control Arm	S061398
	2014.09-2018.09	Rear Axle Right Lower Inner	Saloon 4WD CREC		Track Control Arm	S061575
	2014.09-2018.09	Rear Axle Left & Right Lower Inner	Saloon 4WD CREC		Track Control Arm	S062964
	2014.09-2018.09	Front Axle Left & Right Lower Outer	Saloon 4WD CREC		Ball Joint	S080987
	2014.09-2018.09	Front Axle Left & Right Upper	Saloon 4WD CREC		Control Arm Bushing	519053
	2014.09-2018.09	Front Axle Left & Right Lower Inner	Saloon 4WD CREC		Control Arm Bushing	531929
	2014.09-2018.09	Front Axle Left & Right Lower Outer	Saloon 4WD CREC		Control Arm Bushing	510299
	2014.09-2018.09	Front Axle Left & Right Lower Outer	Saloon 4WD CREC		Control Arm Bushing	530215
	2014.09-2018.09	Rear Axle Left & Right Lower Inner	Saloon 4WD CREC		Control Arm Bushing	533477
	2014.09-2018.09	Front Axle Left & Right	Saloon 4WD CREC		Tie Rod Axle Joint	S030654
	2014.09-2018.09	Front Axle Left	Saloon 4WD CREC		Tie Rod End	S070024



	 YEAR	FITTING POSITION	BODY STYLE & DRIVE TYPE & ENGINE	REMARKS	PRODUCT	GSP Ref.
AUDI A6 Quattro						
3.0 (245 kw)	2014.09-2018.09	Front Axle Right	Saloon 4WD CREC		Tie Rod End	S070025
	2014.09-2018.09	Front Axle Left & Right	Saloon 4WD CREC	Aluminum Material	Rod/Strut,stabiliser	S050473
	2014.09-2018.09	Front Axle Left & Right	Saloon 4WD CREC	For PR no.:1BA/1BE/1BH/1BR,1BV	Rod/Strut,stabiliser	S051258
	2014.09-2018.09	Rear Axle Left & Right	Saloon 4WD CREC		Rod/Strut,stabiliser	S050472
	2014.09-2018.09	Front Axle	Saloon 4WD CREC		Stabiliser Bushing	510138
	2014.09-2018.09	Front Axle	Saloon 4WD CREC		Stabiliser Bushing	532578
	2014.09-2018.09	Front Axle	Saloon 4WD CREC		Stabiliser Bushing	532579
3.0 (250 kw)	2018.02-	Front Axle Left Upper Inner	Saloon 4WD DLZA		Track Control Arm	S062934
	2018.02-	Front Axle Left Upper Outer	Saloon 4WD DLZA		Track Control Arm	S062932
	2018.02-	Front Axle Right Upper Inner	Saloon 4WD DLZA		Track Control Arm	S062935
	2018.02-	Front Axle Right Upper Outer	Saloon 4WD DLZA		Track Control Arm	S062933
	2018.02-	Front Axle Left & Right Upper	Saloon 4WD DLZA		Control Arm Bushing	533901
	2018.02-	Front Axle Left & Right Lower Outer	Saloon 4WD DLZA		Control Arm Bushing	510299
	2018.02-	Front Axle Left	Saloon 4WD DLZA		Tie Rod End	S071632
	2018.02-	Front Axle Right	Saloon 4WD DLZA		Tie Rod End	S071634
	2018.02-	Front Axle Left & Right	Saloon 4WD DLZA		Rod/Strut,stabiliser	S051258
	2018.02-	Rear Axle Left & Right	Saloon 4WD DLZA	Date from:2019.10;Suspension:Normal Suspension	Rod/Strut,stabiliser	S051432
	2018.02-	Rear Axle Left & Right	Saloon 4WD DLZA	Date to:2018.10	Rod/Strut,stabiliser	S051433
	2018.02-	Front Axle	Saloon 4WD DLZA		Stabiliser Bushing	517806
4.2 (220 kw)	1999.04-2005.01	Front Axle Left Lower Inner	Saloon 4WD ARS/ASG		Track Control Arm	S060055
	1999.04-2005.01	Front Axle Left Upper Inner	Saloon 4WD ARS/ASG		Track Control Arm	S062331
	1999.04-2005.01	Front Axle Left Upper Outer	Saloon 4WD ARS/ASG		Track Control Arm	S060048
	1999.04-2005.01	Front Axle Left Upper Outer	Saloon 4WD ARS/ASG	Engine code:ARSL;For vehicles with sports suspension;For PR no.:180180	Track Control Arm	S060798
	1999.04-2005.01	Front Axle Left Upper Outer	Saloon 4WD ARS/ASG	Engine code:ART;ARS;Engine code:ASG;AWN;For PR no.:180180	Track Control Arm	S062530
	1999.04-2005.01	Front Axle Right Lower Inner	Saloon 4WD ARS/ASG		Track Control Arm	S060056
	1999.04-2005.01	Front Axle Right Upper Inner	Saloon 4WD ARS/ASG	for vehicles with sports suspension	Track Control Arm	S060801
	1999.04-2005.01	Front Axle Right Upper Inner	Saloon 4WD ARS/ASG	Engine code:ARS,ART,ASG;Engine code:AWN;For PR no.:180180	Track Control Arm	S062332
	1999.04-2005.01	Front Axle Right Upper Outer	Saloon 4WD ARS/ASG		Track Control Arm	S060049
	1999.04-2005.01	Front Axle Right Upper Outer	Saloon 4WD ARS/ASG	Engine code:ARSL;For vehicles With Sports Suspension;For PR no.:180180	Track Control Arm	S060799
	1999.04-2005.01	Front Axle Right Upper Outer	Saloon 4WD ARS/ASG	Engine code:ART;ARS;Engine code:ASG;AWN;For PR no.:180180	Track Control Arm	S062531
	1999.04-2005.01	Front Axle Left & Right Lower Outer	Saloon 4WD ARS/ASG		Track Control Arm	S060023
	1999.04-2005.01	Front Axle Left & Right Upper	Saloon 4WD ARS/ASG		Control Arm Bushing	510136
	1999.04-2005.01	Front Axle Left & Right Lower Inner	Saloon 4WD ARS/ASG		Control Arm Bushing	510287
	1999.04-2005.01	Front Axle Left & Right Lower Outer	Saloon 4WD ARS/ASG		Control Arm Bushing	510133
	1999.04-2005.01	Front Axle Left & Right Lower Outer	Saloon 4WD ARS/ASG		Control Arm Bushing	510134
	1999.04-2005.01	Front Axle	Saloon 4WD ARS/ASG		Suspension Repair Kit	S990067SK
	1999.04-2005.01	Front Axle Left & Right	Saloon 4WD ARS/ASG		Rod Assembly	S100014
	1999.04-2005.01	Front Axle Left & Right	Saloon 4WD ARS/ASG		Tie Rod Axle Joint	S030013
	1999.04-2005.01	Front Axle Left & Right	Saloon 4WD ARS/ASG		Tie Rod End	S070016
	1999.04-2005.01	Front Axle Left & Right	Saloon 4WD ARS/ASG	Engine code:ARS,ART,AWN	Tie Rod End	S070038
	1999.04-2005.01	Front Axle Left	Saloon 4WD ARS/ASG		Rod/Strut,stabiliser	520008
	1999.04-2005.01	Front Axle Left	Saloon 4WD ARS/ASG	Equipment Vari.:exc.Allroad	Rod/Strut,stabiliser	S050034
	1999.04-2005.01	Front Axle Right	Saloon 4WD ARS/ASG		Rod/Strut,stabiliser	520010
	1999.04-2005.01	Front Axle Right	Saloon 4WD ARS/ASG	Equipment Vari.:exc.Allroad	Rod/Strut,stabiliser	S050033
	1999.04-2005.01	Rear Axle Left & Right	Saloon 4WD ARS/ASG		Rod/Strut,stabiliser	S070017
	1999.04-2005.01	Front Axle	Saloon 4WD ARS/ASG		Stabiliser Bushing	510139
	1999.04-2005.01	Front Axle	Saloon 4WD ARS/ASG		Stabiliser Bushing	517806
	1999.04-2005.01	Rear Axle	Saloon 4WD ARS/ASG		Stabiliser Bushing	517807
	1999.04-2005.01	Front Axle Left	Saloon 4WD ARS/ASG		Steering Boot	540043
	1999.04-2005.01	Front Axle Right	Saloon 4WD ARS/ASG		Steering Boot	540211
4.2 (246 kw)	2005.03-2006.05	Front Axle Left Lower Inner	Estate 4WD BAT		Track Control Arm	S060029
	2005.03-2006.05	Front Axle Left Upper Inner	Estate 4WD BAT		Track Control Arm	S060050
	2005.03-2006.05	Front Axle Left Upper Outer	Estate 4WD BAT		Track Control Arm	S060052
	2005.03-2006.05	Front Axle Right Lower Inner	Estate 4WD BAT		Track Control Arm	S060030
	2005.03-2006.05	Front Axle Right Upper Inner	Estate 4WD BAT		Track Control Arm	S060051
	2005.03-2006.05	Front Axle Right Upper Outer	Estate 4WD BAT		Track Control Arm	S060053
	2005.03-2006.05	Front Axle Left & Right Lower Outer	Estate 4WD BAT		Track Control Arm	S060028
	2005.03-2006.05	Rear Axle Left & Right Lower Outer	Estate 4WD BAT		Track Control Arm	S061506
	2005.03-2006.05	Front Axle Left & Right Upper	Estate 4WD BAT		Control Arm Bushing	510136
	2005.03-2006.05	Front Axle Left & Right Lower Inner	Estate 4WD BAT		Control Arm Bushing	510301
	2005.03-2006.05	Front Axle Left & Right Lower Outer	Estate 4WD BAT		Control Arm Bushing	510299
	2005.03-2006.05	Front Axle Left & Right Lower Outer	Estate 4WD BAT		Control Arm Bushing	531954
	2005.03-2006.05	Rear Axle Left & Right Lower Outer	Estate 4WD BAT		Control Arm Bushing	510393
	2005.03-2006.05	Rear Axle Left & Right Lower Outer	Estate 4WD BAT		Control Arm Bushing	510394



	 YEAR	FITTING POSITION	BODY STYLE & DRIVE TYPE & ENGINE	REMARKS	PRODUCT	GSP Ref.
AUDI A6 Quattro						
4.2 (246 kw)	2005.03-2006.05	Front Axle	Estate 4WD BAT		Suspension Repair Kit	S990014SK
	2005.03-2006.05	Front Axle Left & Right	Estate 4WD BAT		Tie Rod Axle Joint	S030341
	2005.03-2006.05	Front Axle Left & Right	Estate 4WD BAT		Tie Rod End	S070016
	2005.03-2006.05	Front Axle Left & Right	Estate 4WD BAT		Rod/Strut, stabiliser	S050022
	2005.03-2006.05	Rear Axle Left & Right	Estate 4WD BAT		Rod/Strut, stabiliser	S050025
	2005.03-2006.05	Rear Axle Left & Right	Estate 4WD BAT	Chassis no.to:4B-5-050 000	Rod/Strut, stabiliser	S070017
	2005.03-2006.05	Front Axle	Estate 4WD BAT	Stabiliser Ø:27 mm	Stabiliser Bushing	510139
	2005.03-2006.05	Front Axle	Estate 4WD BAT		Stabiliser Bushing	517806
4.2 (257 kw)	2006.06-2011.08	Front Axle Left Lower Inner	Estate 4WD BVJ		Track Control Arm	S060029
	2006.06-2011.08	Front Axle Left Upper Inner	Estate 4WD BVJ		Track Control Arm	S060050
	2006.06-2011.08	Front Axle Left Upper Outer	Estate 4WD BVJ		Track Control Arm	S060052
	2006.06-2011.08	Front Axle Right Lower Inner	Estate 4WD BVJ		Track Control Arm	S060030
	2006.06-2011.08	Front Axle Right Upper Inner	Estate 4WD BVJ		Track Control Arm	S060051
	2006.06-2011.08	Front Axle Right Upper Outer	Estate 4WD BVJ		Track Control Arm	S060053
	2006.06-2011.08	Front Axle Left & Right Lower Outer	Estate 4WD BVJ		Track Control Arm	S060028
	2006.06-2011.08	Rear Axle Left & Right Lower Outer	Estate 4WD BVJ		Track Control Arm	S061506
	2006.06-2011.08	Front Axle Left & Right Upper	Estate 4WD BVJ		Control Arm Bushing	510136
	2006.06-2011.08	Front Axle Left & Right Lower Inner	Estate 4WD BVJ		Control Arm Bushing	510301
	2006.06-2011.08	Front Axle Left & Right Lower Outer	Estate 4WD BVJ		Control Arm Bushing	510299
	2006.06-2011.08	Front Axle Left & Right Lower Outer	Estate 4WD BVJ		Control Arm Bushing	531954
	2006.06-2011.08	Rear Axle Left & Right Lower Outer	Estate 4WD BVJ		Control Arm Bushing	510393
	2006.06-2011.08	Rear Axle Left & Right Lower Outer	Estate 4WD BVJ		Control Arm Bushing	510394
	2006.06-2011.08	Front Axle	Estate 4WD BVJ		Suspension Repair Kit	S990014SK
	2006.06-2011.08	Front Axle Left & Right	Estate 4WD BVJ		Tie Rod Axle Joint	S030341
	2006.06-2011.08	Front Axle Left & Right	Estate 4WD BVJ		Tie Rod End	S070016
	2006.06-2011.08	Front Axle Left & Right	Estate 4WD BVJ		Rod/Strut, stabiliser	S050022
	2006.06-2011.08	Rear Axle Left & Right	Estate 4WD BVJ		Rod/Strut, stabiliser	S050025
	2006.06-2011.08	Rear Axle Left & Right	Estate 4WD BVJ	Chassis no.to:4B-5-050 000	Rod/Strut, stabiliser	S070017
	2006.06-2011.08	Front Axle	Estate 4WD BVJ	Stabiliser Ø:27 mm	Stabiliser Bushing	510139
	2006.06-2011.08	Front Axle	Estate 4WD BVJ		Stabiliser Bushing	517806
A7 Sportback						
2.0 (185 kw)	2014.09-2018.05	Front Axle Left Upper Inner	Hatchback FWD CYPA	Date from:2015.10	Track Control Arm	S060804
	2014.09-2018.05	Front Axle Left Upper Outer	Hatchback FWD CYPA		Track Control Arm	S060802
	2014.09-2018.05	Front Axle Right Upper Inner	Hatchback FWD CYPA	Date from:2015.10	Track Control Arm	S060805
	2014.09-2018.05	Front Axle Right Upper Outer	Hatchback FWD CYPA		Track Control Arm	S060803
	2014.09-2018.05	Rear Axle Left Upper	Hatchback FWD CYPA		Track Control Arm	S061397
	2014.09-2018.05	Rear Axle Left Lower Inner	Hatchback FWD CYPA		Track Control Arm	S061574
	2014.09-2018.05	Rear Axle Right Upper	Hatchback FWD CYPA		Track Control Arm	S061398
	2014.09-2018.05	Rear Axle Right Lower Inner	Hatchback FWD CYPA		Track Control Arm	S061575
	2014.09-2018.05	Rear Axle Left & Right Lower Inner	Hatchback FWD CYPA		Track Control Arm	S062964
	2014.09-2018.05	Front Axle Left & Right Lower Outer	Hatchback FWD CYPA		Ball Joint	S080987
	2014.09-2018.05	Front Axle Left & Right Upper	Hatchback FWD CYPA		Control Arm Bushing	519053
	2014.09-2018.05	Front Axle Left & Right Lower Inner	Hatchback FWD CYPA		Control Arm Bushing	531929
	2014.09-2018.05	Front Axle Left & Right Lower Outer	Hatchback FWD CYPA		Control Arm Bushing	510299
	2014.09-2018.05	Front Axle Left & Right Lower Outer	Hatchback FWD CYPA		Control Arm Bushing	530215
	2014.09-2018.05	Rear Axle Left & Right Lower Inner	Hatchback FWD CYPA		Control Arm Bushing	533477
	2014.09-2018.05	Front Axle Left & Right	Hatchback FWD CYPA		Tie Rod Axle Joint	S030654
	2014.09-2018.05	Front Axle Left	Hatchback FWD CYPA		Tie Rod End	S070024
	2014.09-2018.05	Front Axle Right	Hatchback FWD CYPA		Tie Rod End	S070025
	2014.09-2018.05	Front Axle Left & Right	Hatchback FWD CYPA	Aluminum Material	Rod/Strut, stabiliser	S050473
	2014.09-2018.05	Front Axle Left & Right	Hatchback FWD CYPA	For PR no.:1BA/1BB/1BE/1BV	Rod/Strut, stabiliser	S051258
	2014.09-2018.05	Rear Axle Left & Right	Hatchback FWD CYPA		Rod/Strut, stabiliser	S050472
	2014.09-2018.05	Front Axle	Hatchback FWD CYPA		Stabiliser Bushing	510138
	2014.09-2018.05	Front Axle	Hatchback FWD CYPA		Stabiliser Bushing	532578
	2014.09-2018.05	Front Axle	Hatchback FWD CYPA		Stabiliser Bushing	532579
A7 Sportback Quattro						
3.0 (220 kw)	2010.07-2012.05	Front Axle Left Lower Outer	Hatchback 4WD CGWB	Date from:2011.08	Track Control Arm	S060806
	2010.07-2012.05	Front Axle Right Lower Outer	Hatchback 4WD CGWB	Date from:2011.08	Track Control Arm	S060807
	2010.07-2012.05	Rear Axle Left Upper	Hatchback 4WD CGWB		Track Control Arm	S061397
	2010.07-2012.05	Rear Axle Left Lower Inner	Hatchback 4WD CGWB		Track Control Arm	S061574
	2010.07-2012.05	Rear Axle Left Lower Outer	Hatchback 4WD CGWB		Track Control Arm	S062748
	2010.07-2012.05	Rear Axle Right Upper	Hatchback 4WD CGWB		Track Control Arm	S061398
	2010.07-2012.05	Rear Axle Right Lower Inner	Hatchback 4WD CGWB		Track Control Arm	S061575
	2010.07-2012.05	Rear Axle Right Lower Outer	Hatchback 4WD CGWB		Track Control Arm	S062749



	 YEAR	FITTING POSITION	BODY STYLE & DRIVE TYPE & ENGINE	REMARKS	PRODUCT	GSP Ref.
AUDI						
A7 Sportback Quattro						
3.0 (220 kw)	2010.07-2012.05	Rear Axle Left & Right Lower Inner	Hatchback 4WD CGWB		Track Control Arm	S062964
	2010.07-2012.05	Front Axle Left & Right Lower Outer	Hatchback 4WD CGWB		Ball Joint	S080283
	2010.07-2012.05	Front Axle Left & Right Lower Outer	Hatchback 4WD CGWB	Date from:2011.08	Ball Joint	S080987
	2010.07-2012.05	Front Axle Left & Right Upper	Hatchback 4WD CGWB		Control Arm Bushing	519053
	2010.07-2012.05	Front Axle Left & Right Lower Inner	Hatchback 4WD CGWB		Control Arm Bushing	531929
	2010.07-2012.05	Front Axle Left & Right Lower Outer	Hatchback 4WD CGWB	Date to:2011.08	Control Arm Bushing	510299
	2010.07-2012.05	Front Axle Left & Right Lower Outer	Hatchback 4WD CGWB		Control Arm Bushing	530215
	2010.07-2012.05	Rear Axle Left & Right Lower Inner	Hatchback 4WD CGWB		Control Arm Bushing	533477
	2010.07-2012.05	Front Axle Left & Right	Hatchback 4WD CGWB		Tie Rod Axle Joint	S030654
	2010.07-2012.05	Front Axle Left	Hatchback 4WD CGWB		Tie Rod End	S070024
	2010.07-2012.05	Front Axle Right	Hatchback 4WD CGWB		Tie Rod End	S070025
	2010.07-2012.05	Front Axle Left & Right	Hatchback 4WD CGWB	Date from:2011.06,for PR no.:1BK/1BS	Rod/Strut,stabiliser	S050473
	2010.07-2012.05	Front Axle Left & Right	Hatchback 4WD CGWB	For PR no.:1BA/1BB/1BE/1BV	Rod/Strut,stabiliser	S051258
	2010.07-2012.05	Rear Axle Left & Right	Hatchback 4WD CGWB		Rod/Strut,stabiliser	S050472
	2010.07-2012.05	Front Axle	Hatchback 4WD CGWB		Stabiliser Bushing	510138
	2010.07-2012.05	Front Axle	Hatchback 4WD CGWB	for vehicles with heavy duty suspension,for PR no.:1BB	Stabiliser Bushing	532578
	2010.07-2012.05	Front Axle	Hatchback 4WD CGWB	Engne code:CGWB,Date from:2011.01,for PR no.:1BB/1BK/1BS/1BV	Stabiliser Bushing	532579
3.0 (245 kw)	2014.05-2018.05	Rear Axle Left Upper	Hatchback 4WD CREC		Track Control Arm	S061397
	2014.05-2018.05	Rear Axle Left Lower Inner	Hatchback 4WD CREC		Track Control Arm	S061574
	2014.05-2018.05	Rear Axle Right Upper	Hatchback 4WD CREC		Track Control Arm	S061398
	2014.05-2018.05	Rear Axle Right Lower Inner	Hatchback 4WD CREC		Track Control Arm	S061575
	2014.05-2018.05	Rear Axle Left & Right Lower Inner	Hatchback 4WD CREC		Track Control Arm	S062964
	2014.05-2018.05	Front Axle Left & Right Lower Outer	Hatchback 4WD CREC		Ball Joint	S080987
	2014.05-2018.05	Front Axle Left & Right Upper	Hatchback 4WD CREC		Control Arm Bushing	519053
	2014.05-2018.05	Front Axle Left & Right Lower Inner	Hatchback 4WD CREC		Control Arm Bushing	531929
	2014.05-2018.05	Front Axle Left & Right Lower Outer	Hatchback 4WD CREC		Control Arm Bushing	510299
	2014.05-2018.05	Front Axle Left & Right Lower Outer	Hatchback 4WD CREC		Control Arm Bushing	530215
	2014.05-2018.05	Rear Axle Left & Right Lower Inner	Hatchback 4WD CREC		Control Arm Bushing	533477
	2014.05-2018.05	Front Axle Left & Right	Hatchback 4WD CREC		Tie Rod Axle Joint	S030654
	2014.05-2018.05	Front Axle Left	Hatchback 4WD CREC		Tie Rod End	S070024
	2014.05-2018.05	Front Axle Right	Hatchback 4WD CREC		Tie Rod End	S070025
	2014.05-2018.05	Front Axle Left & Right	Hatchback 4WD CREC	Date to:2014.10,for PR no.:1BK/1BS	Rod/Strut,stabiliser	S050473
	2014.05-2018.05	Front Axle Left & Right	Hatchback 4WD CREC	For PR no.:1BA/1BB/1BE/1BV	Rod/Strut,stabiliser	S051258
	2014.05-2018.05	Rear Axle Left & Right	Hatchback 4WD CREC		Rod/Strut,stabiliser	S050472
	2014.05-2018.05	Front Axle	Hatchback 4WD CREC		Stabiliser Bushing	510138
	2014.05-2018.05	Front Axle	Hatchback 4WD CREC	for vehicles with heavy duty suspension,for PR no.:1BB	Stabiliser Bushing	532578
	2014.05-2018.05	Front Axle	Hatchback 4WD CREC		Stabiliser Bushing	532579
3.0 (250 kw)	2017.10-	Front Axle Left Upper Inner	Hatchback 4WD DLZA		Track Control Arm	S062934
	2017.10-	Front Axle Left Upper Outer	Hatchback 4WD DLZA		Track Control Arm	S062932
	2017.10-	Front Axle Right Upper Inner	Hatchback 4WD DLZA		Track Control Arm	S062935
	2017.10-	Front Axle Right Upper Outer	Hatchback 4WD DLZA		Track Control Arm	S062933
	2017.10-	Front Axle Left & Right Upper	Hatchback 4WD DLZA		Control Arm Bushing	533901
	2017.10-	Front Axle Left & Right Lower Outer	Hatchback 4WD DLZA		Control Arm Bushing	510299
	2017.10-	Front Axle Left	Hatchback 4WD DLZA		Tie Rod End	S071632
	2017.10-	Front Axle Right	Hatchback 4WD DLZA		Tie Rod End	S071634
	2017.10-	Front Axle Left & Right	Hatchback 4WD DLZA		Rod/Strut,stabiliser	S051258
	2017.10-	Rear Axle Left & Right	Hatchback 4WD DLZA	Date from:2018.11,Suspension:Normal Suspension	Rod/Strut,stabiliser	S051432
	2017.10-	Rear Axle Left & Right	Hatchback 4WD DLZA	Date to:2018.10	Rod/Strut,stabiliser	S051433
	2017.10-	Front Axle	Hatchback 4WD DLZA		Stabiliser Bushing	517806
A8 Quattro						
3.0 (228 kw)	2011.11-2018.01	Front Axle Left Lower Inner	Saloon 4WD CGWD/CREA		Track Control Arm	S062026
	2011.11-2018.01	Front Axle Left Upper Inner	Saloon 4WD CGWD/CREA		Track Control Arm	S062030
	2011.11-2018.01	Front Axle Left Lower Outer	Saloon 4WD CGWD/CREA		Track Control Arm	S062024
	2011.11-2018.01	Front Axle Left Upper Outer	Saloon 4WD CGWD/CREA		Track Control Arm	S062028
	2011.11-2018.01	Front Axle Right Lower Inner	Saloon 4WD CGWD/CREA		Track Control Arm	S062027
	2011.11-2018.01	Front Axle Right Upper Inner	Saloon 4WD CGWD/CREA		Track Control Arm	S062031
	2011.11-2018.01	Front Axle Right Lower Outer	Saloon 4WD CGWD/CREA		Track Control Arm	S062025
	2011.11-2018.01	Front Axle Right Upper Outer	Saloon 4WD CGWD/CREA		Track Control Arm	S062029
	2011.11-2018.01	Rear Axle Left Upper	Saloon 4WD CGWD/CREA		Track Control Arm	S061397
	2011.11-2018.01	Rear Axle Right Upper	Saloon 4WD CGWD/CREA		Track Control Arm	S061398
	2011.11-2018.01	Rear Axle Left & Right Lower Inner	Saloon 4WD CGWD/CREA		Track Control Arm	S062964
	2011.11-2018.01	Front Axle Left & Right Upper	Saloon 4WD CGWD/CREA		Control Arm Bushing	519053
	2011.11-2018.01	Front Axle Left & Right Lower Inner	Saloon 4WD CGWD/CREA		Control Arm Bushing	531929
	2011.11-2018.01	Front Axle Left & Right Lower Outer	Saloon 4WD CGWD/CREA		Control Arm Bushing	510299



	 YEAR	FITTING POSITION	BODY STYLE & DRIVE TYPE & ENGINE	REMARKS	PRODUCT	GSP Ref.	
AUDI A8 Quattro 3.0 (228 kw)	2011.11-2018.01	Front Axle Left & Right Lower Outer	Saloon 4WD CGWD/CREA		Control Arm Bushing	531930	
	2011.11-2018.01	Rear Axle Left & Right Lower Inner	Saloon 4WD CGWD/CREA		Control Arm Bushing	533477	
	2011.11-2018.01	Front Axle Left & Right	Saloon 4WD CGWD/CREA	For Vehicles Without Electric Power Steering, For PR no.:1N31N7	Tie Rod Axle Joint	S030342	
	2011.11-2018.01	Front Axle Left & Right	Saloon 4WD CGWD/CREA		Tie Rod Axle Joint	S030654	
	2011.11-2018.01	Front Axle Left & Right	Saloon 4WD CGWD/CREA	Date to:2014.10	Rod/Strut,stabiliser	S050473	
	2011.11-2018.01	Front Axle Left & Right	Saloon 4WD CGWD/CREA	Plastic Material	Rod/Strut,stabiliser	S051258	
	2011.11-2018.01	Rear Axle Left & Right	Saloon 4WD CGWD/CREA		Rod/Strut,stabiliser	S050472	
	2011.11-2018.01	Front Axle	Saloon 4WD CGWD/CREA	for PR no.:2MA/2MB	Stabiliser Bushing	510139	
	2011.11-2018.01	Front Axle	Saloon 4WD CGWD/CREA		Stabiliser Bushing	517806	
	2011.11-2018.01	Front Axle	Saloon 4WD CGWD/CREA		Stabiliser Bushing	532579	
	2011.11-2018.01	Front Axle	Saloon 4WD CGWD/CREA		Stabiliser Bushing	533395	
	2011.11-2018.01	Rear Axle	Saloon 4WD CGWD/CREA		Stabiliser Bushing	516447	
	2011.11-2018.01	Rear Axle	Saloon 4WD CGWD/CREA		Stabiliser Bushing	530183	
	4.2 (220 kw)	1994.06-1999.12	Front Axle Left Lower Inner	Saloon 4WD ABZ/AKG		Track Control Arm	S060055
1994.06-1999.12		Front Axle Left Upper Inner	Saloon 4WD ABZ/AKG		Track Control Arm	S060021	
1994.06-1999.12		Front Axle Right Lower Inner	Saloon 4WD ABZ/AKG		Track Control Arm	S060056	
1994.06-1999.12		Front Axle Right Upper Inner	Saloon 4WD ABZ/AKG		Track Control Arm	S060022	
1994.06-1999.12		Front Axle Left & Right Upper Inner	Saloon 4WD ABZ/AKG		Track Control Arm	S060042	
1994.06-1999.12		Front Axle Left & Right Lower Outer	Saloon 4WD ABZ/AKG	Engine code:ABZ,Chassis no. from:4D-X-005 501	Track Control Arm	S060023	
1994.06-1999.12		Front Axle Left & Right Lower Outer	Saloon 4WD ABZ/AKG	Engine code:ABZ,Chassis no. from:4D-X-005 501	Track Control Arm	S060054	
1994.06-1999.12		Rear Axle Left & Right	Saloon 4WD ABZ/AKG		Track Control Arm	S050044	
1994.06-1999.12		Front Axle Left & Right Lower Inner	Saloon 4WD ABZ/AKG		Control Arm Bushing	510135	
1994.06-1999.12		Front Axle Left & Right Lower Inner	Saloon 4WD ABZ/AKG		Control Arm Bushing	510287	
1994.06-1999.12		Front Axle Left & Right Lower Outer	Saloon 4WD ABZ/AKG		Control Arm Bushing	510133	
1994.06-1999.12		Front Axle Left & Right Lower Outer	Saloon 4WD ABZ/AKG		Control Arm Bushing	510134	
1994.06-1999.12		Front Axle Left & Right Upper Outer	Saloon 4WD ABZ/AKG		Control Arm Bushing	510137	
1994.06-1999.12		Front Axle Left & Right	Saloon 4WD ABZ/AKG		Rod Assembly	S100014	
1994.06-1999.12		Front Axle Left & Right	Saloon 4WD ABZ/AKG		Tie Rod End	S070038	
1994.06-1999.12		Front Axle Left & Right	Saloon 4WD ABZ/AKG		Rod/Strut,stabiliser	520526	
1994.06-1999.12		Rear Axle Left	Saloon 4WD ABZ/AKG		Rod/Strut,stabiliser	S050023	
1994.06-1999.12		Rear Axle Right	Saloon 4WD ABZ/AKG		Rod/Strut,stabiliser	S050024	
1994.06-1999.12		Rear Axle Left & Right	Saloon 4WD ABZ/AKG		Rod/Strut,stabiliser	S050317	
1994.06-1999.12		Front Axle	Saloon 4WD ABZ/AKG	for vehicles without sports suspension	Stabiliser Bushing	510138	
1994.06-1999.12		Front Axle	Saloon 4WD ABZ/AKG		Stabiliser Bushing	510139	
1994.06-1999.12		Front Axle Left	Saloon 4WD ABZ/AKG		Steering Boot	540043	
4.2 (228 kw)		1998.10-2002.09	Front Axle Left Lower Inner	Saloon 4WD AQF/AUW		Track Control Arm	S060055
		1998.10-2002.09	Front Axle Left Upper Inner	Saloon 4WD AQF/AUW	Engine code:AUW,AQF,Chassis no. to:4D-V-004 000	Track Control Arm	S060021
	1998.10-2002.09	Front Axle Left Upper Inner	Saloon 4WD AQF/AUW	Engine code:AUX	Track Control Arm	S062331	
	1998.10-2002.09	Front Axle Right Lower Inner	Saloon 4WD AQF/AUW		Track Control Arm	S060056	
	1998.10-2002.09	Front Axle Right Upper Inner	Saloon 4WD AQF/AUW	Engine code:AUW,AQF,Chassis no. to:4D-V-004 000	Track Control Arm	S060022	
	1998.10-2002.09	Front Axle Right Upper Inner	Saloon 4WD AQF/AUW	Engine code:AUX	Track Control Arm	S062332	
	1998.10-2002.09	Front Axle Left & Right Upper Inner	Saloon 4WD AQF/AUW		Track Control Arm	S060042	
	1998.10-2002.09	Front Axle Left & Right Lower Outer	Saloon 4WD AQF/AUW		Track Control Arm	S060023	
	1998.10-2002.09	Front Axle Left & Right Lower Outer	Saloon 4WD AQF/AUW	Engine code:AQF,Chassis no. to:4D-X-005 500	Track Control Arm	S060054	
	1998.10-2002.09	Front Axle Left & Right Upper	Saloon 4WD AQF/AUW		Control Arm Bushing	510136	
	1998.10-2002.09	Front Axle Left & Right Lower Inner	Saloon 4WD AQF/AUW		Control Arm Bushing	510135	
	1998.10-2002.09	Front Axle Left & Right Lower Inner	Saloon 4WD AQF/AUW		Control Arm Bushing	510287	
	1998.10-2002.09	Front Axle Left & Right Lower Outer	Saloon 4WD AQF/AUW		Control Arm Bushing	510133	
	1998.10-2002.09	Front Axle Left & Right Lower Outer	Saloon 4WD AQF/AUW		Control Arm Bushing	510134	
	1998.10-2002.09	Front Axle Left & Right Upper Outer	Saloon 4WD AQF/AUW		Control Arm Bushing	510137	
	1998.10-2002.09	Front Axle Left & Right	Saloon 4WD AQF/AUW		Rod Assembly	S100014	
	1998.10-2002.09	Front Axle Left & Right	Saloon 4WD AQF/AUW		Tie Rod Axle Joint	S030013	
	1998.10-2002.09	Front Axle Left & Right	Saloon 4WD AQF/AUW		Tie Rod End	S070038	
	1998.10-2002.09	Front Axle Left & Right	Saloon 4WD AQF/AUW		Rod/Strut,stabiliser	520526	
	1998.10-2002.09	Rear Axle Left	Saloon 4WD AQF/AUW		Rod/Strut,stabiliser	S050023	
	1998.10-2002.09	Rear Axle Right	Saloon 4WD AQF/AUW		Rod/Strut,stabiliser	S050024	
	1998.10-2002.09	Rear Axle Left & Right	Saloon 4WD AQF/AUW		Rod/Strut,stabiliser	S050317	
	1998.10-2002.09	Front Axle	Saloon 4WD AQF/AUW	for vehicles without sports suspension	Stabiliser Bushing	510138	
	1998.10-2002.09	Front Axle	Saloon 4WD AQF/AUW	Engine Code:AUW, AQF,for vehicles with sports suspension	Stabiliser Bushing	510139	
1998.10-2002.09	Front Axle Left	Saloon 4WD AQF/AUW		Steering Boot	540043		
4.2 (246 kw)	2002.11-2006.05	Front Axle Left Upper Inner	Saloon 4WD BFM		Track Control Arm	S060050	
	2002.11-2006.05	Front Axle Left Upper Outer	Saloon 4WD BFM		Track Control Arm	S060052	
	2002.11-2006.05	Front Axle Right Upper Inner	Saloon 4WD BFM		Track Control Arm	S060051	
	2002.11-2006.05	Front Axle Right Upper Outer	Saloon 4WD BFM		Track Control Arm	S060053	



	 YEAR	FITTING POSITION	BODY STYLE & DRIVE TYPE & ENGINE	REMARKS	PRODUCT	GSP Ref.	
AUDI A8 Quattro 4.2 (246 kw)	2002.11-2006.05	Front Axle Left & Right Lower Inner	Saloon 4WD BFM		Track Control Arm	S060031	
	2002.11-2006.05	Front Axle Left & Right Upper	Saloon 4WD BFM		Control Arm Bushing	510136	
	2002.11-2006.05	Front Axle Left & Right Lower Inner	Saloon 4WD BFM		Control Arm Bushing	510287	
	2002.11-2006.05	Front Axle Left & Right Lower Inner	Saloon 4WD BFM		Control Arm Bushing	533478	
	2002.11-2006.05	Front Axle Left & Right Lower Outer	Saloon 4WD BFM		Control Arm Bushing	510299	
	2002.11-2006.05	Front Axle Left & Right Lower Outer	Saloon 4WD BFM		Control Arm Bushing	531954	
	2002.11-2006.05	Front Axle Left & Right	Saloon 4WD BFM		Rod Assembly	S100005	
	2002.11-2006.05	Front Axle Left & Right	Saloon 4WD BFM		Rod/Strut,stabiliser	S050022	
	2002.11-2006.05	Rear Axle Left	Saloon 4WD BFM		Rod/Strut,stabiliser	S050023	
	2002.11-2006.05	Rear Axle Right	Saloon 4WD BFM		Rod/Strut,stabiliser	S050024	
	2002.11-2006.05	Rear Axle Left & Right	Saloon 4WD BFM		Rod/Strut,stabiliser	S050471	
	2002.11-2006.05	Front Axle	Saloon 4WD BFM	Stabiliser Ø:25 mm	Stabiliser Bushing	510138	
	2002.11-2006.05	Front Axle	Saloon 4WD BFM	Stabiliser Ø:27 mm	Stabiliser Bushing	510139	
4.2 (257 kw)	2006.06-2010.07	Front Axle Left Upper Inner	Saloon 4WD BVJ		Track Control Arm	S060050	
	2006.06-2010.07	Front Axle Left Upper Outer	Saloon 4WD BVJ		Track Control Arm	S060052	
	2006.06-2010.07	Front Axle Right Upper Inner	Saloon 4WD BVJ		Track Control Arm	S060051	
	2006.06-2010.07	Front Axle Right Upper Outer	Saloon 4WD BVJ		Track Control Arm	S060053	
	2006.06-2010.07	Front Axle Left & Right Lower Inner	Saloon 4WD BVJ		Track Control Arm	S060031	
	2006.06-2010.07	Front Axle Left & Right Upper	Saloon 4WD BVJ		Control Arm Bushing	510136	
	2006.06-2010.07	Front Axle Left & Right Lower Inner	Saloon 4WD BVJ		Control Arm Bushing	510287	
	2006.06-2010.07	Front Axle Left & Right Lower Inner	Saloon 4WD BVJ		Control Arm Bushing	533478	
	2006.06-2010.07	Front Axle Left & Right Lower Outer	Saloon 4WD BVJ		Control Arm Bushing	510299	
	2006.06-2010.07	Front Axle Left & Right Lower Outer	Saloon 4WD BVJ		Control Arm Bushing	531954	
	2006.06-2010.07	Front Axle Left & Right	Saloon 4WD BVJ		Rod Assembly	S100005	
	2006.06-2010.07	Front Axle Left & Right	Saloon 4WD BVJ		Rod/Strut,stabiliser	S050022	
	2006.06-2010.07	Rear Axle Left	Saloon 4WD BVJ		Rod/Strut,stabiliser	S050023	
	2006.06-2010.07	Rear Axle Right	Saloon 4WD BVJ		Rod/Strut,stabiliser	S050024	
	2006.06-2010.07	Front Axle Left & Right	Saloon 4WD BVJ		Rod/Strut,stabiliser	S050471	
	2006.06-2010.07	Front Axle	Saloon 4WD BVJ	Stabiliser Ø:25 mm	Stabiliser Bushing	510138	
	2006.06-2010.07	Front Axle	Saloon 4WD BVJ	Stabiliser Ø:27 mm	Stabiliser Bushing	510139	
	4.2 (273 kw)	2009.11-2012.06	Front Axle Left Lower Inner	Saloon 4WD CDRA		Track Control Arm	S062026
		2009.11-2012.06	Front Axle Left Upper Inner	Saloon 4WD CDRA		Track Control Arm	S062030
2009.11-2012.06		Front Axle Left Lower Outer	Saloon 4WD CDRA		Track Control Arm	S062024	
2009.11-2012.06		Front Axle Left Upper Outer	Saloon 4WD CDRA		Track Control Arm	S062028	
2009.11-2012.06		Front Axle Right Lower Inner	Saloon 4WD CDRA		Track Control Arm	S062027	
2009.11-2012.06		Front Axle Right Upper Inner	Saloon 4WD CDRA		Track Control Arm	S062031	
2009.11-2012.06		Front Axle Right Lower Outer	Saloon 4WD CDRA		Track Control Arm	S062025	
2009.11-2012.06		Front Axle Right Upper Outer	Saloon 4WD CDRA		Track Control Arm	S062029	
2009.11-2012.06		Rear Axle Left Upper	Saloon 4WD CDRA		Track Control Arm	S061397	
2009.11-2012.06		Rear Axle Left Lower Inner	Saloon 4WD CDRA		Track Control Arm	S061574	
2009.11-2012.06		Rear Axle Right Upper	Saloon 4WD CDRA		Track Control Arm	S061398	
2009.11-2012.06		Rear Axle Right Lower Inner	Saloon 4WD CDRA		Track Control Arm	S061575	
2009.11-2012.06		Rear Axle Left & Right Lower Inner	Saloon 4WD CDRA		Track Control Arm	S062964	
2009.11-2012.06		Front Axle Left & Right Upper	Saloon 4WD CDRA		Control Arm Bushing	519053	
2009.11-2012.06		Front Axle Left & Right Lower Inner	Saloon 4WD CDRA		Control Arm Bushing	531929	
2009.11-2012.06		Front Axle Left & Right Lower Outer	Saloon 4WD CDRA		Control Arm Bushing	510299	
2009.11-2012.06		Front Axle Left & Right Lower Outer	Saloon 4WD CDRA		Control Arm Bushing	531930	
2009.11-2012.06		Rear Axle Left & Right Lower Inner	Saloon 4WD CDRA		Control Arm Bushing	533477	
2009.11-2012.06		Front Axle Left & Right	Saloon 4WD CDRA	For Vehicles Without Electric Power Steering For PR no.:1N31N7	Tie Rod Axle Joint	S030342	
2009.11-2012.06		Front Axle Left & Right	Saloon 4WD CDRA	For PR code Q27 For vehicles with electric power steering	Tie Rod Axle Joint	S030654	
2009.11-2012.06		Front Axle Left & Right	Saloon 4WD CDRA	Date to:2012.06	Rod/Strut,stabiliser	S050473	
2009.11-2012.06		Front Axle Left & Right	Saloon 4WD CDRA	Plastic Material	Rod/Strut,stabiliser	S051258	
2009.11-2012.06		Rear Axle Left & Right	Saloon 4WD CDRA		Rod/Strut,stabiliser	S050472	
2009.11-2012.06		Front Axle	Saloon 4WD CDRA	for PR no.:2MA/2MB	Stabiliser Bushing	510139	
2009.11-2012.06		Front Axle	Saloon 4WD CDRA		Stabiliser Bushing	517806	
2009.11-2012.06		Front Axle	Saloon 4WD CDRA		Stabiliser Bushing	532579	
2009.11-2012.06		Front Axle	Saloon 4WD CDRA	for PR no.:2MA	Stabiliser Bushing	533395	
2009.11-2012.06	Rear Axle	Saloon 4WD CDRA		Stabiliser Bushing	516447		
2009.11-2012.06	Rear Axle	Saloon 4WD CDRA		Stabiliser Bushing	530183		
6.0 (331 kw)	2004.02-2010.07	Front Axle Left Upper Inner	Saloon 4WD BHT/BSB/BTE		Track Control Arm	S060050	
	2004.02-2010.07	Front Axle Left Upper Outer	Saloon 4WD BHT/BSB/BTE		Track Control Arm	S060052	
	2004.02-2010.07	Front Axle Right Upper Inner	Saloon 4WD BHT/BSB/BTE		Track Control Arm	S060051	
	2004.02-2010.07	Front Axle Right Upper Outer	Saloon 4WD BHT/BSB/BTE		Track Control Arm	S060053	
	2004.02-2010.07	Front Axle Left & Right Lower Inner	Saloon 4WD BHT/BSB/BTE		Track Control Arm	S060031	



	 YEAR	FITTING POSITION	BODY STYLE & DRIVE TYPE & ENGINE	REMARKS	PRODUCT	GSP Ref.
AUDI						
A8 Quattro						
6.0 (331 kw)	2004.02-2010.07	Front Axle Left & Right Upper	Saloon 4WD BHT/BSB/BTE		Control Arm Bushing	510136
	2004.02-2010.07	Front Axle Left & Right Lower Inner	Saloon 4WD BHT/BSB/BTE		Control Arm Bushing	510287
	2004.02-2010.07	Front Axle Left & Right Lower Inner	Saloon 4WD BHT/BSB/BTE		Control Arm Bushing	533478
	2004.02-2010.07	Front Axle Left & Right Lower Outer	Saloon 4WD BHT/BSB/BTE		Control Arm Bushing	510299
	2004.02-2010.07	Front Axle Left & Right Lower Outer	Saloon 4WD BHT/BSB/BTE		Control Arm Bushing	531954
	2004.02-2010.07	Front Axle Left & Right	Saloon 4WD BHT/BSB/BTE		Rod Assembly	S100005
	2004.02-2010.07	Front Axle Left & Right	Saloon 4WD BHT/BSB/BTE		Rod/Strut,stabiliser	S050022
	2004.02-2010.07	Rear Axle Left	Saloon 4WD BHT/BSB/BTE		Rod/Strut,stabiliser	S050023
	2004.02-2010.07	Rear Axle Right	Saloon 4WD BHT/BSB/BTE		Rod/Strut,stabiliser	S050024
	2004.02-2010.07	Rear Axle Left & Right	Saloon 4WD BHT/BSB/BTE		Rod/Strut,stabiliser	S050471
	2004.02-2010.07	Front Axle	Saloon 4WD BHT/BSB/BTE	Stabiliser Ø:25 mm	Stabiliser Bushing	510138
	2004.02-2010.07	Front Axle	Saloon 4WD BHT/BSB/BTE	Stabiliser Ø:27 mm	Stabiliser Bushing	510139
6.3 (368 kw)	2011.01-2018.01	Front Axle Left Lower Inner	Saloon 4WD CEJA/CTNA		Track Control Arm	S062026
	2011.01-2018.01	Front Axle Left Upper Inner	Saloon 4WD CEJA/CTNA		Track Control Arm	S062030
	2011.01-2018.01	Front Axle Left Lower Outer	Saloon 4WD CEJA/CTNA		Track Control Arm	S062024
	2011.01-2018.01	Front Axle Left Upper Outer	Saloon 4WD CEJA/CTNA		Track Control Arm	S062028
	2011.01-2018.01	Front Axle Right Lower Inner	Saloon 4WD CEJA/CTNA		Track Control Arm	S062027
	2011.01-2018.01	Front Axle Right Upper Inner	Saloon 4WD CEJA/CTNA		Track Control Arm	S062031
	2011.01-2018.01	Front Axle Right Lower Outer	Saloon 4WD CEJA/CTNA		Track Control Arm	S062025
	2011.01-2018.01	Front Axle Right Upper Outer	Saloon 4WD CEJA/CTNA		Track Control Arm	S062029
	2011.01-2018.01	Rear Axle Left & Right Lower Inner	Saloon 4WD CEJA/CTNA		Track Control Arm	S062964
	2011.01-2018.01	Front Axle Left & Right Upper	Saloon 4WD CEJA/CTNA		Control Arm Bushing	519053
	2011.01-2018.01	Front Axle Left & Right Lower Inner	Saloon 4WD CEJA/CTNA		Control Arm Bushing	531929
	2011.01-2018.01	Front Axle Left & Right Lower Outer	Saloon 4WD CEJA/CTNA		Control Arm Bushing	510299
	2011.01-2018.01	Front Axle Left & Right Lower Outer	Saloon 4WD CEJA/CTNA		Control Arm Bushing	531930
	2011.01-2018.01	Rear Axle Left & Right Lower Inner	Saloon 4WD CEJA/CTNA		Control Arm Bushing	533477
	2011.01-2018.01	Front Axle Left & Right	Saloon 4WD CEJA/CTNA	For Vehicles Without Electric Power Steering,For PR no.:1N31N7	Tie Rod Axle Joint	S030342
	2011.01-2018.01	Front Axle Left & Right	Saloon 4WD CEJA/CTNA	For PR code:Q27,For vehicles with electric power steering	Tie Rod Axle Joint	S030654
	2011.01-2018.01	Front Axle Left & Right	Saloon 4WD CEJA/CTNA	Date to:2014.10	Rod/Strut,stabiliser	S050473
	2011.01-2018.01	Front Axle Left & Right	Saloon 4WD CEJA/CTNA	Plastic Material	Rod/Strut,stabiliser	S051258
	2011.01-2018.01	Rear Axle Left & Right	Saloon 4WD CEJA/CTNA		Rod/Strut,stabiliser	S050472
	2011.01-2018.01	Front Axle	Saloon 4WD CEJA/CTNA	for PR no.:1BK/1BY/2MB	Stabiliser Bushing	510139
	2011.01-2018.01	Front Axle	Saloon 4WD CEJA/CTNA		Stabiliser Bushing	517806
	2011.01-2018.01	Front Axle	Saloon 4WD CEJA/CTNA	for PR no.:2MA	Stabiliser Bushing	533395
	2011.01-2018.01	Rear Axle	Saloon 4WD CEJA/CTNA		Stabiliser Bushing	516447
	2011.01-2018.01	Rear Axle	Saloon 4WD CEJA/CTNA		Stabiliser Bushing	530183
A8/S8						
4.0 (388 kw)	2013.01-2014.04	Front Axle Left & Right	Saloon AWD CGTA		Rod/Strut,stabiliser	S050473
	2013.01-2014.04	Rear Axle Left & Right	Saloon AWD CGTA		Rod/Strut,stabiliser	S050472
	2013.01-2014.04	Front Axle	Saloon AWD CGTA	for PR no.:2MA/2MB	Stabiliser Bushing	510139
	2013.01-2014.04	Front Axle	Saloon AWD CGTA		Stabiliser Bushing	517806
	2013.01-2014.04	Front Axle	Saloon AWD CGTA	for PR no.:1BK/1BY	Stabiliser Bushing	532579
	2013.01-2014.04	Front Axle	Saloon AWD CGTA	for PR no.:2MA	Stabiliser Bushing	533395
	2013.01-2014.04	Rear Axle	Saloon AWD CGTA	for PR no.:2MA/2MB	Stabiliser Bushing	516447
	2013.01-2014.04	Rear Axle	Saloon AWD CGTA	for PR no.:1BK/1BY,for armoured vehicles,for PR no.:F4S	Stabiliser Bushing	530183
	2013.01-2014.04	Front Axle Left	Saloon AWD CGTA	for vehicles with electric power steering	Steering Boot	541218
A8/S8 quattro						
4.2 (224 kw)	1999.09-2002.12	Rear Axle Right	Saloon AWD AUX		Rod/Strut,stabiliser	S050024
	1999.09-2002.12	Rear Axle Left & Right	Saloon AWD AUX		Rod/Strut,stabiliser	S050317
	1999.09-2002.12	Front Axle	Saloon AWD AUX	Stabiliser Ø:25 mm	Stabiliser Bushing	510138
	1999.09-2002.12	Front Axle	Saloon AWD AUX	Stabiliser Ø:27 mm	Stabiliser Bushing	510139
	2002.10-2003.12	Front Axle Left Lower Inner	Saloon AWD AUX	Vehicle Identification Number (VIN) from 4E5004001	Track Control Arm	S060032
	2002.10-2003.12	Front Axle Right Lower Inner	Saloon AWD AUX	Vehicle Identification Number (VIN) from 4E5004001	Track Control Arm	S060033
	2002.10-2003.12	Front Axle Left & Right	Saloon AWD AUX		Rod/Strut,stabiliser	S050022
	2002.10-2003.12	Rear Axle Left	Saloon AWD AUX		Rod/Strut,stabiliser	S050023
	2002.10-2003.12	Rear Axle Right	Saloon AWD AUX		Rod/Strut,stabiliser	S050024
	2002.10-2003.12	Front Axle	Saloon AWD AUX	Stabiliser Ø:25 mm	Stabiliser Bushing	510138
	2002.10-2003.12	Front Axle	Saloon AWD AUX	Stabiliser Ø:27 mm	Stabiliser Bushing	510139
4.2 (231 kw)	2000.01-2002.12	Rear Axle Right	Saloon AWD AKB		Rod/Strut,stabiliser	S050024
	2000.01-2002.12	Rear Axle Left & Right	Saloon AWD AKB		Rod/Strut,stabiliser	S050317
	2000.01-2002.12	Front Axle	Saloon AWD AKB	Stabiliser Ø:25 mm	Stabiliser Bushing	510138
	2000.01-2002.12	Front Axle	Saloon AWD AKB	Stabiliser Ø:27 mm	Stabiliser Bushing	510139
4.2 (268 kw)	2003.09-2004.12	Front Axle Left Lower Inner	Saloon AWD AYS	Vehicle Identification Number (VIN) from 4E5004001	Track Control Arm	S060032
	2003.09-2004.12	Front Axle Right Lower Inner	Saloon AWD AYS	Vehicle Identification Number (VIN) from 4E5004001	Track Control Arm	S060033



	 YEAR	FITTING POSITION	BODY STYLE & DRIVE TYPE & ENGINE	REMARKS	PRODUCT	GSP Ref.
AUDI						
A8/S8 quattro						
4.2 (268 kw)	2003.09-2004.12	Front Axle Left & Right	Saloon AWD AYS		Rod/Strut,stabiliser	S050022
	2003.09-2004.12	Rear Axle Left	Saloon AWD AYS		Rod/Strut,stabiliser	S050023
	2003.09-2004.12	Rear Axle Right	Saloon AWD AYS		Rod/Strut,stabiliser	S050024
	2003.09-2004.12	Front Axle	Saloon AWD AYS	Stabiliser Ø:25 mm	Stabiliser Bushing	510138
	2003.09-2004.12	Front Axle	Saloon AWD AYS	Stabiliser Ø:27 mm	Stabiliser Bushing	510139
Allroad Quattro						
2.7 (184 kw)	2000.05-2005.08	Front Axle Left Lower Inner	Estate 4WD ARE/BES		Track Control Arm	S063082
	2000.05-2005.08	Front Axle Left Upper Inner	Estate 4WD ARE/BES		Track Control Arm	S062331
	2000.05-2005.08	Front Axle Left Upper Outer	Estate 4WD ARE/BES		Track Control Arm	S060048
	2000.05-2005.08	Front Axle Left Upper Outer	Estate 4WD ARE/BES		Track Control Arm	S060798
	2000.05-2005.08	Front Axle Left Upper Outer	Estate 4WD ARE/BES		Track Control Arm	S062530
	2000.05-2005.08	Front Axle Right Lower Inner	Estate 4WD ARE/BES		Track Control Arm	S063083
	2000.05-2005.08	Front Axle Right Upper Inner	Estate 4WD ARE/BES		Track Control Arm	S062332
	2000.05-2005.08	Front Axle Right Upper Outer	Estate 4WD ARE/BES		Track Control Arm	S060049
	2000.05-2005.08	Front Axle Right Upper Outer	Estate 4WD ARE/BES		Track Control Arm	S062531
	2000.05-2005.08	Front Axle Left & Right Lower Outer	Estate 4WD ARE/BES		Track Control Arm	S063084
	2000.05-2005.08	Front Axle Left & Right Lower Inner	Estate 4WD ARE/BES		Control Arm Bushing	510287
	2000.05-2005.08	Front Axle Left & Right Lower Outer	Estate 4WD ARE/BES		Control Arm Bushing	510133
	2000.05-2005.08	Front Axle Left & Right Lower Outer	Estate 4WD ARE/BES		Control Arm Bushing	510134
	2000.05-2005.08	Front Axle Left & Right	Estate 4WD ARE/BES		Tie Rod Axle Joint	S030013
	2000.05-2005.08	Front Axle Left & Right	Estate 4WD ARE/BES	Chassis no.from:4B-2-150 001	Tie Rod End	S070016
	2000.05-2005.08	Front Axle Left & Right	Estate 4WD ARE/BES	Chassis no.to:4B-2-150 000	Tie Rod End	S070038
	2000.05-2005.08	Front Axle Left & Right	Estate 4WD ARE/BES		Rod/Strut,stabiliser	520526
	2000.05-2005.08	Rear Axle Left & Right	Estate 4WD ARE/BES		Rod/Strut,stabiliser	S070017
	2000.05-2005.08	Front Axle	Estate 4WD ARE/BES		Stabiliser Bushing	510139
	2000.05-2005.08	Front Axle	Estate 4WD ARE/BES		Stabiliser Bushing	517806
	2000.05-2005.08	Rear Axle	Estate 4WD ARE/BES		Stabiliser Bushing	517807
	2000.05-2005.08	Front Axle Left	Estate 4WD ARE/BES		Steering Boot	540043
e-tron Quattro						
ET (300 kw)	2018.09-	Front Axle Left Upper Inner	SUV 4WD EASA/EAWA		Track Control Arm	S062934
	2018.09-	Front Axle Left Lower Outer	SUV 4WD EASA/EAWA		Track Control Arm	S062938
	2018.09-	Front Axle Left Upper Outer	SUV 4WD EASA/EAWA		Track Control Arm	S062932
	2018.09-	Front Axle Right Upper Inner	SUV 4WD EASA/EAWA		Track Control Arm	S062935
	2018.09-	Front Axle Right Lower Outer	SUV 4WD EASA/EAWA		Track Control Arm	S062939
	2018.09-	Front Axle Right Upper Outer	SUV 4WD EASA/EAWA		Track Control Arm	S062933
	2018.09-	Front Axle Left & Right Upper	SUV 4WD EASA/EAWA		Control Arm Bushing	533901
	2018.09-	Front Axle Left & Right	SUV 4WD EASA/EAWA		Rod/Strut,stabiliser	S051258
	2018.09-	Rear Axle Left & Right	SUV 4WD EASA/EAWA		Rod/Strut,stabiliser	S051432
e-tron Sportback Quattro						
ET (300 kw)	2019.09-	Front Axle Left Upper Inner	SUV 4WD EASA/EAWA		Track Control Arm	S062934
	2019.09-	Front Axle Left Lower Outer	SUV 4WD EASA/EAWA		Track Control Arm	S062938
	2019.09-	Front Axle Left Upper Outer	SUV 4WD EASA/EAWA		Track Control Arm	S062932
	2019.09-	Front Axle Right Upper Inner	SUV 4WD EASA/EAWA		Track Control Arm	S062935
	2019.09-	Front Axle Right Lower Outer	SUV 4WD EASA/EAWA		Track Control Arm	S062939
	2019.09-	Front Axle Right Upper Outer	SUV 4WD EASA/EAWA		Track Control Arm	S062933
	2019.09-	Front Axle Left & Right Upper	SUV 4WD EASA/EAWA		Control Arm Bushing	533901
	2019.09-	Front Axle Left & Right	SUV 4WD EASA/EAWA		Rod/Strut,stabiliser	S051258
	2019.09-	Rear Axle Left & Right	SUV 4WD EASA/EAWA		Rod/Strut,stabiliser	S051432
Q3						
1.4 (110 kw)	2013.10-2018.10	Front Axle Left & Right Lower	SUV FWD CHPB/CZDA/CZEA		Track Control Arm	S060762
	2013.10-2018.10	Rear Axle Left Centre	SUV FWD CHPB/CZDA/CZEA		Track Control Arm	S063095
	2013.10-2018.10	Rear Axle Left Lower Inner	SUV FWD CHPB/CZDA/CZEA		Track Control Arm	510349
	2013.10-2018.10	Rear Axle Right Centre	SUV FWD CHPB/CZDA/CZEA		Track Control Arm	S063094
	2013.10-2018.10	Rear Axle Right Lower Inner	SUV FWD CHPB/CZDA/CZEA		Track Control Arm	510350
	2013.10-2018.10	Rear Axle Left & Right Lower Outer	SUV FWD CHPB/CZDA/CZEA		Track Control Arm	S061468
	2013.10-2018.10	Front Axle Left Lower	SUV FWD CHPB/CZDA/CZEA		Ball Joint	S080013
	2013.10-2018.10	Front Axle Right Lower	SUV FWD CHPB/CZDA/CZEA		Ball Joint	S080012
	2013.10-2018.10	Front Axle Left & Right Lower	SUV FWD CHPB/CZDA/CZEA		Control Arm Bushing	510353
	2013.10-2018.10	Front Axle Left & Right Lower	SUV FWD CHPB/CZDA/CZEA		Control Arm Bushing	510356
	2013.10-2018.10	Front Axle Left & Right Lower	SUV FWD CHPB/CZDA/CZEA		Control Arm Bushing	510361
	2013.10-2018.10	Rear Axle Left & Right Upper	SUV FWD CHPB/CZDA/CZEA		Control Arm Bushing	516372
	2013.10-2018.10	Rear Axle Left & Right Upper	SUV FWD CHPB/CZDA/CZEA		Control Arm Bushing	516408
	2013.10-2018.10	Rear Axle Left & Right Lower Inner	SUV FWD CHPB/CZDA/CZEA		Control Arm Bushing	510351
	2013.10-2018.10	Rear Axle Left & Right Lower Inner	SUV FWD CHPB/CZDA/CZEA		Control Arm Bushing	510352



	 YEAR	FITTING POSITION	BODY STYLE & DRIVE TYPE & ENGINE	REMARKS	PRODUCT	GSP Ref.
AUDI Q3						
1.4 (110 kw)	2013.10-2018.10	Rear Axle Left & Right Lower Outer	SUV FWD CHPB/CZDA/CZEA		Control Arm Bushing	516370
	2013.10-2018.10	Front Axle Left & Right	SUV FWD CHPB/CZDA/CZEA		Tie Rod Axle Joint	S030009
	2013.10-2018.10	Front Axle Left	SUV FWD CHPB/CZDA/CZEA		Tie Rod End	S070032
	2013.10-2018.10	Front Axle Right	SUV FWD CHPB/CZDA/CZEA		Tie Rod End	S070033
	2013.10-2018.10	Front Axle Left & Right	SUV FWD CHPB/CZDA/CZEA		Rod/Strut,stabiliser	S050040
	2013.10-2018.10	Rear Axle Left & Right	SUV FWD CHPB/CZDA/CZEA		Rod/Strut,stabiliser	S050035
	2013.10-2018.10	Front Axle	SUV FWD CHPB/CZDA/CZEA		Stabiliser Bushing	535187K
	2013.10-2018.10	Rear Axle	SUV FWD CHPB/CZDA/CZEA		Stabiliser Bushing	516447
	2016.02-2018.10	Rear Axle Left Centre	SUV FWD CWLA/CZDA		Track Control Arm	S063095
	2016.02-2018.10	Rear Axle Right Centre	SUV FWD CWLA/CZDA		Track Control Arm	S063094
	2016.02-2018.10	Rear Axle Right Lower Inner	SUV FWD CWLA/CZDA		Track Control Arm	510350
	2016.02-2018.10	Front Axle Left Lower	SUV FWD CWLA/CZDA		Ball Joint	S080013
	2016.02-2018.10	Front Axle Right Lower	SUV FWD CWLA/CZDA		Ball Joint	S080012
	2016.02-2018.10	Rear Axle Left & Right Lower Outer	SUV FWD CWLA/CZDA		Control Arm Bushing	516370
	2016.02-2018.10	Front Axle Left	SUV FWD CWLA/CZDA		Tie Rod End	S070032
	2016.02-2018.10	Front Axle Right	SUV FWD CWLA/CZDA		Tie Rod End	S070033
	2016.02-2018.10	Rear Axle Left & Right	SUV FWD CWLA/CZDA		Rod/Strut,stabiliser	S050035
	2016.02-2018.10	Front Axle	SUV FWD CWLA/CZDA		Stabiliser Bushing	535187K
	2016.02-2018.10	Rear Axle	SUV FWD CWLA/CZDA		Stabiliser Bushing	516447
	2018.11-	Front Axle Left & Right	SUV FWD CZDA		Rod/Strut,stabiliser	S050040
Q3 Quattro						
2.0 (125 kw)	2011.06-2015.04	Front Axle Left & Right Lower	SUV 4WD CCZC		Track Control Arm	S060762
	2011.06-2015.04	Rear Axle Left Centre	SUV 4WD CCZC		Track Control Arm	S063095
	2011.06-2015.04	Rear Axle Left Lower Inner	SUV 4WD CCZC		Track Control Arm	510349
	2011.06-2015.04	Rear Axle Right Centre	SUV 4WD CCZC		Track Control Arm	S063094
	2011.06-2015.04	Rear Axle Right Lower Inner	SUV 4WD CCZC		Track Control Arm	510350
	2011.06-2015.04	Rear Axle Left & Right Lower Outer	SUV 4WD CCZC		Track Control Arm	S061468
	2011.06-2015.04	Front Axle Left Lower	SUV 4WD CCZC		Ball Joint	S080013
	2011.06-2015.04	Front Axle Right Lower	SUV 4WD CCZC		Ball Joint	S080012
	2011.06-2015.04	Front Axle Left & Right Lower	SUV 4WD CCZC		Control Arm Bushing	510353
	2011.06-2015.04	Front Axle Left & Right Lower	SUV 4WD CCZC		Control Arm Bushing	510356
	2011.06-2015.04	Front Axle Left & Right Lower	SUV 4WD CCZC		Control Arm Bushing	510361
	2011.06-2015.04	Rear Axle Left & Right Upper	SUV 4WD CCZC		Control Arm Bushing	516372
	2011.06-2015.04	Rear Axle Left & Right Upper	SUV 4WD CCZC		Control Arm Bushing	516408
	2011.06-2015.04	Rear Axle Left & Right Lower Inner	SUV 4WD CCZC		Control Arm Bushing	510351
	2011.06-2015.04	Rear Axle Left & Right Lower Inner	SUV 4WD CCZC		Control Arm Bushing	510352
	2011.06-2015.04	Rear Axle Left & Right Lower Outer	SUV 4WD CCZC		Control Arm Bushing	516370
	2011.06-2015.04	Front Axle Left & Right	SUV 4WD CCZC		Tie Rod Axle Joint	S030009
	2011.06-2015.04	Front Axle Left	SUV 4WD CCZC		Tie Rod End	S070032
	2011.06-2015.04	Front Axle Right	SUV 4WD CCZC		Tie Rod End	S070033
	2011.06-2015.04	Front Axle Left & Right	SUV 4WD CCZC		Rod/Strut,stabiliser	S050040
	2011.06-2015.04	Rear Axle Left & Right	SUV 4WD CCZC		Rod/Strut,stabiliser	S050035
	2011.06-2015.04	Front Axle	SUV 4WD CCZC		Stabiliser Bushing	535187K
	2011.06-2015.04	Rear Axle	SUV 4WD CCZC		Stabiliser Bushing	516447
2.0 (132 kw)	2015.01-2018.12	Front Axle Left & Right Lower	SUV 4WD CULB		Track Control Arm	S060762
	2015.01-2018.12	Rear Axle Left Centre	SUV 4WD CULB		Track Control Arm	S063095
	2015.01-2018.12	Rear Axle Left Lower Inner	SUV 4WD CULB		Track Control Arm	510349
	2015.01-2018.12	Rear Axle Right Centre	SUV 4WD CULB		Track Control Arm	S063094
	2015.01-2018.12	Rear Axle Right Lower Inner	SUV 4WD CULB		Track Control Arm	510350
	2015.01-2018.12	Rear Axle Left & Right Lower Outer	SUV 4WD CULB		Track Control Arm	S061468
	2015.01-2018.12	Front Axle Left Lower	SUV 4WD CULB		Ball Joint	S080013
	2015.01-2018.12	Front Axle Right Lower	SUV 4WD CULB		Ball Joint	S080012
	2015.01-2018.12	Front Axle Left & Right Lower	SUV 4WD CULB		Control Arm Bushing	510353
	2015.01-2018.12	Front Axle Left & Right Lower	SUV 4WD CULB		Control Arm Bushing	510356
	2015.01-2018.12	Front Axle Left & Right Lower	SUV 4WD CULB		Control Arm Bushing	510361
	2015.01-2018.12	Rear Axle Left & Right Lower Inner	SUV 4WD CULB		Control Arm Bushing	510351
	2015.01-2018.12	Rear Axle Left & Right Lower Inner	SUV 4WD CULB		Control Arm Bushing	510352
	2015.01-2018.12	Rear Axle Left & Right Lower Outer	SUV 4WD CULB		Control Arm Bushing	516370
	2015.01-2018.12	Front Axle Left & Right	SUV 4WD CULB		Tie Rod Axle Joint	S030009
	2015.01-2018.12	Front Axle Left	SUV 4WD CULB		Tie Rod End	S070032
	2015.01-2018.12	Front Axle Right	SUV 4WD CULB		Tie Rod End	S070033
	2015.01-2018.12	Front Axle Left & Right	SUV 4WD CULB		Rod/Strut,stabiliser	S050040
	2015.01-2018.12	Rear Axle Left & Right	SUV 4WD CULB		Rod/Strut,stabiliser	S050035
	2015.01-2018.12	Front Axle	SUV 4WD CULB		Stabiliser Bushing	535187K



	 YEAR	FITTING POSITION	BODY STYLE & DRIVE TYPE & ENGINE	REMARKS	PRODUCT	GSP Ref.
AUDI Q3 Quattro						
2.0 (132 kw)	2015.01-2018.12	Rear Axle	SUV 4WD CULB		Stabiliser Bushing	516447
2.0 (155 kw)	2011.06-2015.04	Front Axle Left & Right Lower	SUV 4WD CPSA		Track Control Arm	S060762
	2011.06-2015.04	Rear Axle Left Centre	SUV 4WD CPSA		Track Control Arm	S063095
	2011.06-2015.04	Rear Axle Left Lower Inner	SUV 4WD CPSA		Track Control Arm	510349
	2011.06-2015.04	Rear Axle Right Centre	SUV 4WD CPSA		Track Control Arm	S063094
	2011.06-2015.04	Rear Axle Right Lower Inner	SUV 4WD CPSA		Track Control Arm	510350
	2011.06-2015.04	Rear Axle Left & Right Lower Outer	SUV 4WD CPSA		Track Control Arm	S061468
	2011.06-2015.04	Front Axle Left Lower	SUV 4WD CPSA		Ball Joint	S080013
	2011.06-2015.04	Front Axle Right Lower	SUV 4WD CPSA		Ball Joint	S080012
	2011.06-2015.04	Front Axle Left & Right Lower	SUV 4WD CPSA		Control Arm Bushing	510353
	2011.06-2015.04	Front Axle Left & Right Lower	SUV 4WD CPSA		Control Arm Bushing	510356
	2011.06-2015.04	Front Axle Left & Right Lower	SUV 4WD CPSA		Control Arm Bushing	510361
	2011.06-2015.04	Rear Axle Left & Right Upper	SUV 4WD CPSA		Control Arm Bushing	516372
	2011.06-2015.04	Rear Axle Left & Right Upper	SUV 4WD CPSA		Control Arm Bushing	516408
	2011.06-2015.04	Rear Axle Left & Right Lower Inner	SUV 4WD CPSA		Control Arm Bushing	510351
	2011.06-2015.04	Rear Axle Left & Right Lower Inner	SUV 4WD CPSA		Control Arm Bushing	510352
	2011.06-2015.04	Rear Axle Left & Right Lower Outer	SUV 4WD CPSA		Control Arm Bushing	516370
	2011.06-2015.04	Front Axle Left & Right	SUV 4WD CPSA		Tie Rod Axle Joint	S030009
	2011.06-2015.04	Front Axle Left	SUV 4WD CPSA		Tie Rod End	S070032
	2011.06-2015.04	Front Axle Right	SUV 4WD CPSA		Tie Rod End	S070033
	2011.06-2015.04	Front Axle Left & Right	SUV 4WD CPSA		Rod/Strut, stabiliser	S050040
	2011.06-2015.04	Rear Axle Left & Right	SUV 4WD CPSA		Rod/Strut, stabiliser	S050035
	2011.06-2015.04	Front Axle	SUV 4WD CPSA		Stabiliser Bushing	535187K
	2011.06-2015.04	Rear Axle	SUV 4WD CPSA		Stabiliser Bushing	516447
2.0 (162 kw)	2014.11-2018.10	Front Axle Left & Right Lower	SUV 4WD CULC		Track Control Arm	S060762
	2014.11-2018.10	Rear Axle Left Centre	SUV 4WD CULC		Track Control Arm	S063095
	2014.11-2018.10	Rear Axle Left Lower Inner	SUV 4WD CULC		Track Control Arm	510349
	2014.11-2018.10	Rear Axle Right Centre	SUV 4WD CULC		Track Control Arm	S063094
	2014.11-2018.10	Rear Axle Right Lower Inner	SUV 4WD CULC		Track Control Arm	510350
	2014.11-2018.10	Rear Axle Left & Right Lower Outer	SUV 4WD CULC		Track Control Arm	S061468
	2014.11-2018.10	Front Axle Left Lower	SUV 4WD CULC		Ball Joint	S080013
	2014.11-2018.10	Front Axle Right Lower	SUV 4WD CULC		Ball Joint	S080012
	2014.11-2018.10	Front Axle Left & Right Lower	SUV 4WD CULC		Control Arm Bushing	510353
	2014.11-2018.10	Front Axle Left & Right Lower	SUV 4WD CULC		Control Arm Bushing	510356
	2014.11-2018.10	Front Axle Left & Right Lower	SUV 4WD CULC		Control Arm Bushing	510361
	2014.11-2018.10	Rear Axle Left & Right Lower Inner	SUV 4WD CULC		Control Arm Bushing	510351
	2014.11-2018.10	Rear Axle Left & Right Lower Inner	SUV 4WD CULC		Control Arm Bushing	510352
	2014.11-2018.10	Rear Axle Left & Right Lower Outer	SUV 4WD CULC		Control Arm Bushing	516370
	2014.11-2018.10	Front Axle Left & Right	SUV 4WD CULC		Tie Rod Axle Joint	S030009
	2014.11-2018.10	Front Axle Left	SUV 4WD CULC		Tie Rod End	S070032
	2014.11-2018.10	Front Axle Right	SUV 4WD CULC		Tie Rod End	S070033
	2014.11-2018.10	Front Axle Left & Right	SUV 4WD CULC		Rod/Strut, stabiliser	S050040
	2014.11-2018.10	Rear Axle Left & Right	SUV 4WD CULC		Rod/Strut, stabiliser	S050035
	2014.11-2018.10	Front Axle	SUV 4WD CULC		Stabiliser Bushing	535187K
	2014.11-2018.10	Rear Axle	SUV 4WD CULC		Stabiliser Bushing	516447
Q5 Quattro						
2.0 (155 kw)	2008.11-2012.09	Front Axle Left Lower Inner	SUV 4WD CAEB/CDNC	Date From-to: 2009.08-2009.11	Track Control Arm	S060038
	2008.11-2012.09	Front Axle Left Lower Inner	SUV 4WD CAEB/CDNC		Track Control Arm	S062261
	2008.11-2012.09	Front Axle Left Upper Inner	SUV 4WD CAEB/CDNC	Date from:2012.08	Track Control Arm	S060804
	2008.11-2012.09	Front Axle Left Lower Outer	SUV 4WD CAEB/CDNC	Date from:2011.08	Track Control Arm	S060806
	2008.11-2012.09	Front Axle Left Upper Outer	SUV 4WD CAEB/CDNC		Track Control Arm	S060802
	2008.11-2012.09	Front Axle Right Lower Inner	SUV 4WD CAEB/CDNC	Date from-to:2009.08-2009.11	Track Control Arm	S060039
	2008.11-2012.09	Front Axle Right Lower Inner	SUV 4WD CAEB/CDNC		Track Control Arm	S062177
	2008.11-2012.09	Front Axle Right Upper Inner	SUV 4WD CAEB/CDNC	Date from:2012.08	Track Control Arm	S060805
	2008.11-2012.09	Front Axle Right Lower Outer	SUV 4WD CAEB/CDNC	Date from:2011.08	Track Control Arm	S060807
	2008.11-2012.09	Front Axle Right Upper Outer	SUV 4WD CAEB/CDNC		Track Control Arm	S060803
	2008.11-2012.09	Rear Axle Left Upper	SUV 4WD CAEB/CDNC		Track Control Arm	S061397
	2008.11-2012.09	Rear Axle Left Lower Inner	SUV 4WD CAEB/CDNC		Track Control Arm	S061574
	2008.11-2012.09	Rear Axle Right Upper	SUV 4WD CAEB/CDNC		Track Control Arm	S061398
	2008.11-2012.09	Rear Axle Right Lower Inner	SUV 4WD CAEB/CDNC		Track Control Arm	S061575
	2008.11-2012.09	Rear Axle Left & Right Lower Inner	SUV 4WD CAEB/CDNC		Track Control Arm	S062964
	2008.11-2012.09	Front Axle Left & Right Lower Outer	SUV 4WD CAEB/CDNC		Ball Joint	S080283
	2008.11-2012.09	Front Axle Left & Right Lower Outer	SUV 4WD CAEB/CDNC	Date from:2011.08	Ball Joint	S080987
	2008.11-2012.09	Front Axle Left & Right Upper	SUV 4WD CAEB/CDNC		Control Arm Bushing	510136



	 YEAR	FITTING POSITION	BODY STYLE & DRIVE TYPE & ENGINE	REMARKS	PRODUCT	GSP Ref.
AUDI Q5 Quattro						
2.0 (155 kw)	2008.11-2012.09	Front Axle Left & Right Upper	SUV 4WD CAEB/CDNC		Control Arm Bushing	517974
	2008.11-2012.09	Front Axle Left & Right Lower Inner	SUV 4WD CAEB/CDNC		Control Arm Bushing	530214
	2008.11-2012.09	Front Axle Left & Right Lower Inner	SUV 4WD CAEB/CDNC		Control Arm Bushing	531929
	2008.11-2012.09	Front Axle Left & Right Lower Inner	SUV 4WD CAEB/CDNC		Control Arm Bushing	531931
	2008.11-2012.09	Front Axle Left & Right Lower Outer	SUV 4WD CAEB/CDNC	Date to:2011.08	Control Arm Bushing	510299
	2008.11-2012.09	Front Axle Left & Right Lower Outer	SUV 4WD CAEB/CDNC		Control Arm Bushing	530215
	2008.11-2012.09	Rear Axle Left & Right Lower Inner	SUV 4WD CAEB/CDNC		Control Arm Bushing	533477
	2008.11-2012.09	Front Axle	SUV 4WD CAEB/CDNC		Suspension Repair Kit	S990011SK
	2008.11-2012.09	Front Axle Left & Right	SUV 4WD CAEB/CDNC	For Vehicles Without Electric Power Steering For PR no.:1N11N231N7	Tie Rod Axle Joint	S030342
	2008.11-2012.09	Front Axle Left & Right	SUV 4WD CAEB/CDNC		Tie Rod Axle Joint	S030654
	2008.11-2012.09	Front Axle Left	SUV 4WD CAEB/CDNC		Tie Rod End	S070024
	2008.11-2012.09	Front Axle Right	SUV 4WD CAEB/CDNC		Tie Rod End	S070025
	2008.11-2012.09	Front Axle Left & Right	SUV 4WD CAEB/CDNC	Aluminum Material	Rod/Strut, stabiliser	S050473
	2008.11-2012.09	Front Axle Left & Right	SUV 4WD CAEB/CDNC	not For PR no.:X4M/X5F	Rod/Strut, stabiliser	S051258
	2008.11-2012.09	Rear Axle Left & Right	SUV 4WD CAEB/CDNC		Rod/Strut, stabiliser	S050472
	2008.11-2012.09	Front Axle	SUV 4WD CAEB/CDNC	for PR no.:0JA,0JB,0JC,0JD,0JE	Stabiliser Bushing	510139
	2008.11-2012.09	Front Axle	SUV 4WD CAEB/CDNC	for PR no.:0JA,0JB,0JC,0JD,0JE	Stabiliser Bushing	533395
2.0 (165 kw)	2012.06-2016.05	Front Axle Left Lower Inner	SUV 4WD CNCD		Track Control Arm	S062261
	2012.06-2016.05	Front Axle Left Upper Inner	SUV 4WD CNCD	Date from:2012.08	Track Control Arm	S060804
	2012.06-2016.05	Front Axle Left Upper Outer	SUV 4WD CNCD		Track Control Arm	S060802
	2012.06-2016.05	Front Axle Right Lower Inner	SUV 4WD CNCD		Track Control Arm	S062177
	2012.06-2016.05	Front Axle Right Upper Inner	SUV 4WD CNCD	Date from:2012.08	Track Control Arm	S060805
	2012.06-2016.05	Front Axle Right Upper Outer	SUV 4WD CNCD		Track Control Arm	S060803
	2012.06-2016.05	Rear Axle Left Upper	SUV 4WD CNCD		Track Control Arm	S061397
	2012.06-2016.05	Rear Axle Right Upper	SUV 4WD CNCD		Track Control Arm	S061398
	2012.06-2016.05	Rear Axle Left & Right Lower Inner	SUV 4WD CNCD		Track Control Arm	S062964
	2012.06-2016.05	Front Axle Left & Right Lower Outer	SUV 4WD CNCD		Ball Joint	S080987
	2012.06-2016.05	Front Axle Left & Right Upper	SUV 4WD CNCD	Inner diameter:10.3,Length:26.3	Control Arm Bushing	510136
	2012.06-2016.05	Front Axle Left & Right Lower Inner	SUV 4WD CNCD		Control Arm Bushing	531929
	2012.06-2016.05	Front Axle Left & Right Lower Inner	SUV 4WD CNCD		Control Arm Bushing	531931
	2012.06-2016.05	Front Axle Left & Right Lower Outer	SUV 4WD CNCD		Control Arm Bushing	510299
	2012.06-2016.05	Front Axle Left & Right Lower Outer	SUV 4WD CNCD		Control Arm Bushing	530215
	2012.06-2016.05	Rear Axle Left & Right Lower Inner	SUV 4WD CNCD		Control Arm Bushing	533477
	2012.06-2016.05	Front Axle Left & Right	SUV 4WD CNCD	For Vehicles Without Electric Power Steering For PR no.:1N11N231N7	Tie Rod Axle Joint	S030342
	2012.06-2016.05	Front Axle Left & Right	SUV 4WD CNCD		Tie Rod Axle Joint	S030654
	2012.06-2016.05	Front Axle Left	SUV 4WD CNCD		Tie Rod End	S070024
	2012.06-2016.05	Front Axle Right	SUV 4WD CNCD		Tie Rod End	S070025
	2012.06-2016.05	Front Axle Left & Right	SUV 4WD CNCD	Aluminum Material	Rod/Strut, stabiliser	S050473
	2012.06-2016.05	Front Axle Left & Right	SUV 4WD CNCD	not For PR no.:X4M/X5F	Rod/Strut, stabiliser	S051258
	2012.06-2016.05	Rear Axle Left & Right	SUV 4WD CNCD		Rod/Strut, stabiliser	S050472
	2012.06-2016.05	Front Axle	SUV 4WD CNCD		Stabiliser Bushing	510139
	2012.06-2016.05	Front Axle	SUV 4WD CNCD	for manufacturer:Giesche/Blasas S-16, not for PR no.:S4M/S5C,030JE	Stabiliser Bushing	533395
2.0 (185 kw)	2016.06-2020.11	Front Axle Left Upper Inner	SUV 4WD DAXB/DAYB		Track Control Arm	S062934
	2016.06-2020.11	Front Axle Left Upper Outer	SUV 4WD DAXB/DAYB		Track Control Arm	S062932
	2016.06-2020.11	Front Axle Right Upper Inner	SUV 4WD DAXB/DAYB		Track Control Arm	S062935
	2016.06-2020.11	Front Axle Right Upper Outer	SUV 4WD DAXB/DAYB		Track Control Arm	S062933
	2016.06-2020.11	Front Axle Left & Right Upper	SUV 4WD DAXB/DAYB		Control Arm Bushing	533901
	2016.06-2020.11	Front Axle Left & Right Lower Outer	SUV 4WD DAXB/DAYB		Control Arm Bushing	510299
	2016.06-2020.11	Front Axle Left	SUV 4WD DAXB/DAYB		Tie Rod End	S071632
	2016.06-2020.11	Front Axle Right	SUV 4WD DAXB/DAYB		Tie Rod End	S071634
	2016.06-2020.11	Front Axle Left & Right	SUV 4WD DAXB/DAYB		Rod/Strut, stabiliser	S050473
	2016.06-2020.11	Front Axle Left & Right	SUV 4WD DAXB/DAYB	Plastic Material	Rod/Strut, stabiliser	S051258
	2016.06-2020.11	Rear Axle Left & Right	SUV 4WD DAXB/DAYB		Rod/Strut, stabiliser	S051433
3.0 (200 kw)	2012.06-2017.12	Front Axle Left Upper Inner	SUV 4WD CTUC/CTVA	Engine code:CTUC,Engine code:CTVA,Date from:2012.08	Track Control Arm	S060804
	2012.06-2017.12	Front Axle Left Upper Outer	SUV 4WD CTUC/CTVA		Track Control Arm	S060802
	2012.06-2017.12	Front Axle Right Upper Inner	SUV 4WD CTUC/CTVA	Engine code:CTUC,Engine code:CTVA,Date from:2012.08	Track Control Arm	S060805
	2012.06-2017.12	Front Axle Right Upper Outer	SUV 4WD CTUC/CTVA		Track Control Arm	S060803
	2012.06-2017.12	Rear Axle Left Upper	SUV 4WD CTUC/CTVA		Track Control Arm	S061397
	2012.06-2017.12	Rear Axle Right Upper	SUV 4WD CTUC/CTVA		Track Control Arm	S061398
	2012.06-2017.12	Rear Axle Left & Right Lower Inner	SUV 4WD CTUC/CTVA		Track Control Arm	S062964
	2012.06-2017.12	Front Axle Left & Right Lower Outer	SUV 4WD CTUC/CTVA		Ball Joint	S080987
	2012.06-2017.12	Front Axle Left & Right Upper	SUV 4WD CTUC/CTVA		Control Arm Bushing	510136
	2012.06-2017.12	Front Axle Left & Right Lower Inner	SUV 4WD CTUC/CTVA		Control Arm Bushing	531929
	2012.06-2017.12	Front Axle Left & Right Lower Inner	SUV 4WD CTUC/CTVA		Control Arm Bushing	531931



	 YEAR	FITTING POSITION	BODY STYLE & DRIVE TYPE & ENGINE	REMARKS	PRODUCT	GSP Ref.
AUDI						
Q7 Quattro						
3.0 (200 kw)	2010.05-2015.08	Rear Axle Right Upper Outer	SUV 4WD CJTC/CJWC		Track Control Arm	S060024
	2010.05-2015.08	Rear Axle Left & Right Upper Inner	SUV 4WD CJTC/CJWC		Track Control Arm	S060808
	2010.05-2015.08	Rear Axle Left & Right Lower Outer	SUV 4WD CJTC/CJWC		Track Control Arm	510395
	2010.05-2015.08	Front Axle Left & Right Lower	SUV 4WD CJTC/CJWC		Control Arm Bushing	516054
	2010.05-2015.08	Front Axle Left & Right Lower	SUV 4WD CJTC/CJWC		Control Arm Bushing	517469
	2010.05-2015.08	Front Axle Left & Right Upper	SUV 4WD CJTC/CJWC		Control Arm Bushing	510362
	2010.05-2015.08	Rear Axle Left & Right Upper Inner	SUV 4WD CJTC/CJWC	for vehicles without ABS	Control Arm Bushing	516063
	2010.05-2015.08	Rear Axle Left & Right Upper Inner	SUV 4WD CJTC/CJWC	for vehicles without ABS	Control Arm Bushing	516109
	2010.05-2015.08	Rear Axle Left & Right Upper Inner	SUV 4WD CJTC/CJWC		Control Arm Bushing	516120
	2010.05-2015.08	Rear Axle Left & Right Outer	SUV 4WD CJTC/CJWC		Control Arm Bushing	516121
	2010.05-2015.08	Front Axle;Rear Axle Left & Right Lower	SUV 4WD CJTC/CJWC		Control Arm Bushing	516090
	2010.05-2015.08	Front Axle Left	SUV 4WD CJTC/CJWC		Rod Assembly	S100263
	2010.05-2015.08	Front Axle Right	SUV 4WD CJTC/CJWC		Rod Assembly	S100264
	2010.05-2015.08	Front Axle Left & Right	SUV 4WD CJTC/CJWC		Tie Rod Axle Joint	S030010
	2010.05-2015.08	Front Axle Left	SUV 4WD CJTC/CJWC		Tie Rod End	S070036
	2010.05-2015.08	Front Axle Right	SUV 4WD CJTC/CJWC		Tie Rod End	S070037
	2010.05-2015.08	Front Axle Left & Right	SUV 4WD CJTC/CJWC		Rod/Strut, stabiliser	S050047
	2010.05-2015.08	Rear Axle Left	SUV 4WD CJTC/CJWC		Rod/Strut, stabiliser	S050049
	2010.05-2015.08	Rear Axle Right	SUV 4WD CJTC/CJWC		Rod/Strut, stabiliser	S050050
	2010.05-2015.08	Front Axle	SUV 4WD CJTC/CJWC		Stabiliser Bushing	530532
	2010.05-2015.08	Rear Axle	SUV 4WD CJTC/CJWC		Stabiliser Bushing	518122
	2010.05-2015.08	Front Axle	SUV 4WD CJTC/CJWC		Steering Boot	540440
	2015.01-2019.12	Front Axle Left Upper Inner	SUV 4WD CRTC		Track Control Arm	S062934
	2015.01-2019.12	Front Axle Left Lower Outer	SUV 4WD CRTC		Track Control Arm	S062938
	2015.01-2019.12	Front Axle Left Upper Outer	SUV 4WD CRTC		Track Control Arm	S062932
	2015.01-2019.12	Front Axle Right Upper Inner	SUV 4WD CRTC		Track Control Arm	S062935
	2015.01-2019.12	Front Axle Right Lower Outer	SUV 4WD CRTC		Track Control Arm	S062939
	2015.01-2019.12	Front Axle Right Upper Outer	SUV 4WD CRTC		Track Control Arm	S062933
	2015.01-2019.12	Front Axle Left & Right Upper	SUV 4WD CRTC		Control Arm Bushing	533901
	2015.01-2019.12	Front Axle Left & Right	SUV 4WD CRTC	Plastic Material	Rod/Strut, stabiliser	S051258
	2015.01-2019.12	Rear Axle Left & Right	SUV 4WD CRTC		Rod/Strut, stabiliser	S051432
3.0 (245 kw)	2010.05-2015.08	Front Axle Left Lower	SUV 4WD CJTB/CJWB/CNAA/CTWA		Track Control Arm	S060043
	2010.05-2015.08	Front Axle Right Lower	SUV 4WD CJTB/CJWB/CNAA/CTWA		Track Control Arm	S060044
	2010.05-2015.08	Front Axle Left & Right Upper	SUV 4WD CJTB/CJWB/CNAA/CTWA		Track Control Arm	S063085
	2010.05-2015.08	Rear Axle Left Lower Inner	SUV 4WD CJTB/CJWB/CNAA/CTWA		Track Control Arm	S062095
	2010.05-2015.08	Rear Axle Left Upper Outer	SUV 4WD CJTB/CJWB/CNAA/CTWA		Track Control Arm	S060045
	2010.05-2015.08	Rear Axle Right Lower Inner	SUV 4WD CJTB/CJWB/CNAA/CTWA		Track Control Arm	S062784
	2010.05-2015.08	Rear Axle Right Upper Outer	SUV 4WD CJTB/CJWB/CNAA/CTWA		Track Control Arm	S060024
	2010.05-2015.08	Rear Axle Left & Right Upper Inner	SUV 4WD CJTB/CJWB/CNAA/CTWA		Track Control Arm	S060808
	2010.05-2015.08	Rear Axle Left & Right Lower Outer	SUV 4WD CJTB/CJWB/CNAA/CTWA		Track Control Arm	510395
	2010.05-2015.08	Front Axle Left & Right Lower	SUV 4WD CJTB/CJWB/CNAA/CTWA		Control Arm Bushing	516054
	2010.05-2015.08	Front Axle Left & Right Lower	SUV 4WD CJTB/CJWB/CNAA/CTWA		Control Arm Bushing	517469
	2010.05-2015.08	Front Axle Left & Right Upper	SUV 4WD CJTB/CJWB/CNAA/CTWA		Control Arm Bushing	510362
	2010.05-2015.08	Rear Axle Left & Right Lower Inner	SUV 4WD CJTB/CJWB/CNAA/CTWA	for vehicles without ABS	Control Arm Bushing	516063
	2010.05-2015.08	Rear Axle Left & Right Upper Inner	SUV 4WD CJTB/CJWB/CNAA/CTWA	for vehicles without ABS	Control Arm Bushing	516109
	2010.05-2015.08	Rear Axle Left & Right Upper Inner	SUV 4WD CJTB/CJWB/CNAA/CTWA		Control Arm Bushing	516120
	2010.05-2015.08	Rear Axle Left & Right Outer	SUV 4WD CJTB/CJWB/CNAA/CTWA		Control Arm Bushing	516121
	2010.05-2015.08	Front Axle;Rear Axle Left & Right Lower	SUV 4WD CJTB/CJWB/CNAA/CTWA		Control Arm Bushing	516090
	2010.05-2015.08	Front Axle Left	SUV 4WD CJTB/CJWB/CNAA/CTWA		Rod Assembly	S100263
	2010.05-2015.08	Front Axle Right	SUV 4WD CJTB/CJWB/CNAA/CTWA		Rod Assembly	S100264
	2010.05-2015.08	Front Axle Left & Right	SUV 4WD CJTB/CJWB/CNAA/CTWA		Tie Rod Axle Joint	S030010
	2010.05-2015.08	Front Axle Left	SUV 4WD CJTB/CJWB/CNAA/CTWA		Tie Rod End	S070036
	2010.05-2015.08	Front Axle Right	SUV 4WD CJTB/CJWB/CNAA/CTWA		Tie Rod End	S070037
	2010.05-2015.08	Front Axle Left & Right	SUV 4WD CJTB/CJWB/CNAA/CTWA		Rod/Strut, stabiliser	S050047
	2010.05-2015.08	Rear Axle Left	SUV 4WD CJTB/CJWB/CNAA/CTWA		Rod/Strut, stabiliser	S050049
	2010.05-2015.08	Rear Axle Right	SUV 4WD CJTB/CJWB/CNAA/CTWA		Rod/Strut, stabiliser	S050050
	2010.05-2015.08	Front Axle	SUV 4WD CJTB/CJWB/CNAA/CTWA		Stabiliser Bushing	530532
	2010.05-2015.08	Rear Axle	SUV 4WD CJTB/CJWB/CNAA/CTWA		Stabiliser Bushing	518122
	2010.05-2015.08	Front Axle	SUV 4WD CJTB/CJWB/CNAA/CTWA		Steering Boot	540440
	2015.01-2019.12	Front Axle Left Upper Inner	SUV 4WD CREC		Track Control Arm	S062934
	2015.01-2019.12	Front Axle Left Lower Outer	SUV 4WD CREC		Track Control Arm	S062938
	2015.01-2019.12	Front Axle Left Upper Outer	SUV 4WD CREC		Track Control Arm	S062932
	2015.01-2019.12	Front Axle Right Upper Inner	SUV 4WD CREC		Track Control Arm	S062935
	2015.01-2019.12	Front Axle Right Lower Outer	SUV 4WD CREC		Track Control Arm	S062939



	 YEAR	FITTING POSITION	BODY STYLE & DRIVE TYPE & ENGINE	REMARKS	PRODUCT	GSP Ref.	
AUDI Q7 Quattro							
3.0 (245 kw)	2015.01-2019.12	Front Axle Right Upper Outer	SUV 4WD CREC		Track Control Arm	S062933	
	2015.01-2019.12	Front Axle Left & Right Upper	SUV 4WD CREC		Control Arm Bushing	533901	
	2015.01-2019.12	Front Axle Left & Right	SUV 4WD CREC		Rod/Strut, stabiliser	S050473	
	2015.01-2019.12	Front Axle Left & Right	SUV 4WD CREC	Plastic Material	Rod/Strut, stabiliser	S051258	
	2015.01-2019.12	Rear Axle Left & Right	SUV 4WD CREC		Rod/Strut, stabiliser	S051432	
3.6 (206 kw)	2006.08-2010.05	Front Axle Left Lower	SUV 4WD BHK		Track Control Arm	S060043	
	2006.08-2010.05	Front Axle Right Lower	SUV 4WD BHK		Track Control Arm	S060044	
	2006.08-2010.05	Front Axle Left & Right Upper	SUV 4WD BHK		Track Control Arm	S060349	
	2006.08-2010.05	Rear Axle Left Lower Inner	SUV 4WD BHK		Track Control Arm	S062095	
	2006.08-2010.05	Rear Axle Left Upper Outer	SUV 4WD BHK		Track Control Arm	S060045	
	2006.08-2010.05	Rear Axle Right Lower Inner	SUV 4WD BHK		Track Control Arm	S062784	
	2006.08-2010.05	Rear Axle Right Upper Outer	SUV 4WD BHK		Track Control Arm	S060024	
	2006.08-2010.05	Rear Axle Left & Right Upper Inner	SUV 4WD BHK		Track Control Arm	S060808	
	2006.08-2010.05	Rear Axle Left & Right Lower Outer	SUV 4WD BHK		Track Control Arm	510395	
	2006.08-2010.05	Front Axle Left & Right Lower	SUV 4WD BHK		Control Arm Bushing	511490	
	2006.08-2010.05	Front Axle Left & Right Lower	SUV 4WD BHK		Control Arm Bushing	516054	
	2006.08-2010.05	Front Axle Left & Right Lower	SUV 4WD BHK		Control Arm Bushing	517469	
	2006.08-2010.05	Front Axle Left & Right Upper	SUV 4WD BHK		Control Arm Bushing	510362	
	2006.08-2010.05	Rear Axle Left & Right Lower Inner	SUV 4WD BHK	for vehicles without ABS, Date from: 2010	Control Arm Bushing	516063	
	2006.08-2010.05	Rear Axle Left & Right Upper Inner	SUV 4WD BHK	for vehicles without ABS, Date from: 2010	Control Arm Bushing	516109	
	2006.08-2010.05	Rear Axle Left & Right Upper Inner	SUV 4WD BHK		Control Arm Bushing	516120	
	2006.08-2010.05	Rear Axle Left & Right Outer	SUV 4WD BHK		Control Arm Bushing	516121	
	2006.08-2010.05	Front Axle, Rear Axle Left & Right Lower	SUV 4WD BHK		Control Arm Bushing	516090	
	2006.08-2010.05	Front Axle	SUV 4WD BHK		Suspension Repair Kit	S990025SK	
	2006.08-2010.05	Front Axle Left	SUV 4WD BHK		Rod Assembly	S100263	
	2006.08-2010.05	Front Axle Right	SUV 4WD BHK		Rod Assembly	S100264	
	2006.08-2010.05	Front Axle Left & Right	SUV 4WD BHK		Tie Rod Axle Joint	S030010	
	2006.08-2010.05	Front Axle Left	SUV 4WD BHK		Tie Rod End	S070036	
	2006.08-2010.05	Front Axle Right	SUV 4WD BHK		Tie Rod End	S070037	
	2006.08-2010.05	Front Axle Left & Right	SUV 4WD BHK		Rod/Strut, stabiliser	S050047	
	2006.08-2010.05	Rear Axle Left	SUV 4WD BHK		Rod/Strut, stabiliser	S050049	
	2006.08-2010.05	Rear Axle Right	SUV 4WD BHK		Rod/Strut, stabiliser	S050050	
	2006.08-2010.05	Front Axle	SUV 4WD BHK		Stabiliser Bushing	530532	
	2006.08-2010.05	Rear Axle	SUV 4WD BHK		Stabiliser Bushing	518122	
	2006.08-2010.05	Front Axle	SUV 4WD BHK		Steering Boot	540440	
	4.2 (257 kw)	2006.03-2010.05	Front Axle Left Lower	SUV 4WD BAR	For PR no. 2D0, Date from: 2010.04 For PR no. 2D4	Track Control Arm	S060043
		2006.03-2010.05	Front Axle Left Lower	SUV 4WD BAR	Date to: 2006.04	Track Control Arm	S060347
2006.03-2010.05		Front Axle Right Lower	SUV 4WD BAR	For PR no. 2D0, Date from: 2010.04 For PR no. 2D4	Track Control Arm	S060044	
2006.03-2010.05		Front Axle Right Lower	SUV 4WD BAR	Date to: 2006.04	Track Control Arm	S060348	
2006.03-2010.05		Front Axle Left & Right Upper	SUV 4WD BAR		Track Control Arm	S060349	
2006.03-2010.05		Rear Axle Left Lower Inner	SUV 4WD BAR		Track Control Arm	S062095	
2006.03-2010.05		Rear Axle Left Upper Outer	SUV 4WD BAR		Track Control Arm	S060045	
2006.03-2010.05		Rear Axle Right Lower Inner	SUV 4WD BAR		Track Control Arm	S062784	
2006.03-2010.05		Rear Axle Right Upper Outer	SUV 4WD BAR		Track Control Arm	S060024	
2006.03-2010.05		Rear Axle Left & Right Upper Inner	SUV 4WD BAR		Track Control Arm	S060808	
2006.03-2010.05		Rear Axle Left & Right Lower Outer	SUV 4WD BAR		Track Control Arm	510395	
2006.03-2010.05		Front Axle Left & Right Lower	SUV 4WD BAR		Control Arm Bushing	511490	
2006.03-2010.05		Front Axle Left & Right Lower	SUV 4WD BAR	Quantity: 1	Control Arm Bushing	516054	
2006.03-2010.05		Front Axle Left & Right Lower	SUV 4WD BAR		Control Arm Bushing	516054	
2006.03-2010.05		Front Axle Left & Right Lower	SUV 4WD BAR	Quantity: 1	Control Arm Bushing	517469	
2006.03-2010.05		Front Axle Left & Right Lower	SUV 4WD BAR		Control Arm Bushing	517469	
2006.03-2010.05		Front Axle Left & Right Upper	SUV 4WD BAR		Control Arm Bushing	510362	
2006.03-2010.05		Rear Axle Left & Right Lower Inner	SUV 4WD BAR	for vehicles without ABS, Date from: 2010	Control Arm Bushing	516063	
2006.03-2010.05		Rear Axle Left & Right Upper Inner	SUV 4WD BAR	for vehicles without ABS, Date from: 2010	Control Arm Bushing	516109	
2006.03-2010.05		Rear Axle Left & Right Upper Inner	SUV 4WD BAR		Control Arm Bushing	516120	
2006.03-2010.05		Rear Axle Left & Right Outer	SUV 4WD BAR		Control Arm Bushing	516121	
2006.03-2010.05		Front Axle, Rear Axle Left & Right Lower	SUV 4WD BAR	Quantity: 1	Control Arm Bushing	516090	
2006.03-2010.05		Front Axle, Rear Axle Left & Right Lower	SUV 4WD BAR		Control Arm Bushing	516090	
2006.03-2010.05		Front Axle	SUV 4WD BAR		Suspension Repair Kit	S990025SK	
2006.03-2010.05		Front Axle Left	SUV 4WD BAR		Rod Assembly	S100263	
2006.03-2010.05		Front Axle Right	SUV 4WD BAR		Rod Assembly	S100264	
2006.03-2010.05		Front Axle Left & Right	SUV 4WD BAR		Tie Rod Axle Joint	S030010	
2006.03-2010.05		Front Axle Left	SUV 4WD BAR		Tie Rod End	S070036	
2006.03-2010.05		Front Axle Right	SUV 4WD BAR		Tie Rod End	S070037	



	 YEAR	FITTING POSITION	BODY STYLE & DRIVE TYPE & ENGINE	REMARKS	PRODUCT	GSP Ref.
AUDI Q7 Quattro						
4.2 (257 kw)	2006.03-2010.05	Front Axle Left & Right	SUV 4WD BAR		Rod/Strut, stabiliser	S050047
	2006.03-2010.05	Rear Axle Left	SUV 4WD BAR		Rod/Strut, stabiliser	S050049
	2006.03-2010.05	Rear Axle Right	SUV 4WD BAR		Rod/Strut, stabiliser	S050050
	2006.03-2010.05	Front Axle	SUV 4WD BAR		Stabiliser Bushing	530532
	2006.03-2010.05	Rear Axle	SUV 4WD BAR		Stabiliser Bushing	518122
	2006.03-2010.05	Front Axle	SUV 4WD BAR		Steering Boot	540440
Q8 Quattro						
3.0 (250 kw)	2018.02-	Front Axle Left Upper Inner	SUV 4WD DCBD		Track Control Arm	S062934
	2018.02-	Front Axle Left Lower Outer	SUV 4WD DCBD		Track Control Arm	S062938
	2018.02-	Front Axle Left Upper Outer	SUV 4WD DCBD		Track Control Arm	S062932
	2018.02-	Front Axle Right Upper Inner	SUV 4WD DCBD		Track Control Arm	S062935
	2018.02-	Front Axle Right Lower Outer	SUV 4WD DCBD		Track Control Arm	S062939
	2018.02-	Front Axle Right Upper Outer	SUV 4WD DCBD		Track Control Arm	S062933
	2018.02-	Front Axle Left & Right Upper	SUV 4WD DCBD		Control Arm Bushing	533901
	2018.02-	Front Axle Left & Right	SUV 4WD DCBD		Rod/Strut, stabiliser	S050473
	2018.02-	Front Axle Left & Right	SUV 4WD DCBD	Plastic Material	Rod/Strut, stabiliser	S051258
	2018.02-	Rear Axle Left & Right	SUV 4WD DCBD		Rod/Strut, stabiliser	S051432
	2020.10-	Rear Axle Left & Right	SUV 4WD DCBE		Rod/Strut, stabiliser	S051432
R8 Quattro						
4.2 (309 kw)	2007.04-2010.09	Front Axle	Coupe 4WD BYH		Stabiliser Bushing	517806
5.2 (386 kw)	2009.04-2015.07	Front Axle	Coupe 4WD BUJ/CTYA		Stabiliser Bushing	517806
R8 Spyder Quattro						
5.2 (386 kw)	2010.02-2015.07	Front Axle	Cabriolet 4WD BUJ/CTYA		Stabiliser Bushing	517806
RS3 Quattro						
2.5 (294 kw)	2017.04-2020.10	Rear Axle Left & Right Lower Inner	Saloon 4WD DAZA/DNWA		Track Control Arm	S062791
	2017.04-2020.10	Rear Axle Left & Right Lower Outer	Saloon 4WD DAZA/DNWA		Track Control Arm	S062899
	2017.04-2020.10	Front Axle Left Lower	Saloon 4WD DAZA/DNWA	Equipment Not 2016-08-08-2017-08-08-2018-08-08-2019-08-08-2020-08-08	Ball Joint	S080013
	2017.04-2020.10	Front Axle Left Lower	Saloon 4WD DAZA/DNWA		Ball Joint	S080258
	2017.04-2020.10	Front Axle Right Lower	Saloon 4WD DAZA/DNWA	Equipment Not 2016-08-08-2017-08-08-2018-08-08-2019-08-08-2020-08-08	Ball Joint	S080012
	2017.04-2020.10	Front Axle Right Lower	Saloon 4WD DAZA/DNWA		Ball Joint	S080259
	2017.04-2020.10	Front Axle Left & Right Lower	Saloon 4WD DAZA/DNWA		Control Arm Bushing	510361
	2017.04-2020.10	Rear Axle Left & Right Centre	Saloon 4WD DAZA/DNWA		Control Arm Bushing	512203
	2017.04-2020.10	Front Axle Left & Right	Saloon 4WD DAZA/DNWA		Tie Rod Axle Joint	S030009
	2017.04-2020.10	Front Axle Left & Right	Saloon 4WD DAZA/DNWA		Rod/Strut, stabiliser	S050040
	2017.04-2020.10	Rear Axle Left & Right	Saloon 4WD DAZA/DNWA		Rod/Strut, stabiliser	S051234
RS3 Sportback Quattro						
2.5 (250 kw)	2011.01-2012.12	Front Axle Left Lower	Hatchback 4WD CEPA		Track Control Arm	S060342
	2011.01-2012.12	Front Axle Left Lower	Hatchback 4WD CEPA		Track Control Arm	S062032
	2011.01-2012.12	Front Axle Left Lower	Hatchback 4WD CEPA		Track Control Arm	S063005
	2011.01-2012.12	Front Axle Right Lower	Hatchback 4WD CEPA		Track Control Arm	S060341
	2011.01-2012.12	Front Axle Right Lower	Hatchback 4WD CEPA		Track Control Arm	S062033
	2011.01-2012.12	Front Axle Right Lower	Hatchback 4WD CEPA		Track Control Arm	S063006
	2011.01-2012.12	Rear Axle Left Centre	Hatchback 4WD CEPA		Track Control Arm	S061407
	2011.01-2012.12	Rear Axle Left Lower Inner	Hatchback 4WD CEPA		Track Control Arm	510349
	2011.01-2012.12	Rear Axle Right Centre	Hatchback 4WD CEPA		Track Control Arm	S061408
	2011.01-2012.12	Rear Axle Right Lower Inner	Hatchback 4WD CEPA		Track Control Arm	510350
	2011.01-2012.12	Rear Axle Left & Right Upper	Hatchback 4WD CEPA		Track Control Arm	510346
	2011.01-2012.12	Rear Axle Left & Right Lower Outer	Hatchback 4WD CEPA		Track Control Arm	S061468
	2011.01-2012.12	Front Axle Left Lower	Hatchback 4WD CEPA		Ball Joint	S080013
	2011.01-2012.12	Front Axle Left Lower	Hatchback 4WD CEPA		Ball Joint	S080258
	2011.01-2012.12	Front Axle Right Lower	Hatchback 4WD CEPA		Ball Joint	S080012
	2011.01-2012.12	Front Axle Right Lower	Hatchback 4WD CEPA		Ball Joint	S080259
	2011.01-2012.12	Front Axle Left Lower	Hatchback 4WD CEPA		Control Arm Bushing	510333
	2011.01-2012.12	Front Axle Left Lower	Hatchback 4WD CEPA		Control Arm Bushing	533862
	2011.01-2012.12	Front Axle Right Lower	Hatchback 4WD CEPA		Control Arm Bushing	510334
	2011.01-2012.12	Front Axle Right Lower	Hatchback 4WD CEPA		Control Arm Bushing	533863
	2011.01-2012.12	Front Axle Left & Right Lower	Hatchback 4WD CEPA		Control Arm Bushing	510361
	2011.01-2012.12	Front Axle Left & Right Lower	Hatchback 4WD CEPA		Control Arm Bushing	535342
	2011.01-2012.12	Rear Axle Left & Right Upper	Hatchback 4WD CEPA		Control Arm Bushing	516372
	2011.01-2012.12	Rear Axle Left & Right Upper	Hatchback 4WD CEPA		Control Arm Bushing	516408
	2011.01-2012.12	Rear Axle Left & Right Lower Inner	Hatchback 4WD CEPA		Control Arm Bushing	510351
	2011.01-2012.12	Rear Axle Left & Right Lower Inner	Hatchback 4WD CEPA		Control Arm Bushing	510352
	2011.01-2012.12	Rear Axle Left & Right Lower Outer	Hatchback 4WD CEPA		Control Arm Bushing	516370
	2011.01-2012.12	Rear Axle	Hatchback 4WD CEPA		Suspension Repair Kit	S990019SK



	 YEAR	FITTING POSITION	BODY STYLE & DRIVE TYPE & ENGINE	REMARKS	PRODUCT	GSP Ref.
AUDI						
RS3 Sportback Quattro						
2.5 (250 kw)	2011.01-2012.12	Front Axle Left & Right	Hatchback 4WD CEPA		Tie Rod Axle Joint	S030009
	2011.01-2012.12	Front Axle Left	Hatchback 4WD CEPA		Tie Rod End	S070032
	2011.01-2012.12	Front Axle Right	Hatchback 4WD CEPA		Tie Rod End	S070033
	2011.01-2012.12	Front Axle Left & Right	Hatchback 4WD CEPA		Rod/Strut, stabiliser	S050040
	2011.01-2012.12	Rear Axle Left & Right	Hatchback 4WD CEPA		Rod/Strut, stabiliser	S050035
	2011.01-2012.12	Rear Axle	Hatchback 4WD CEPA		Stabiliser Bushing	530199
2.5 (270 kw)	2015.02-2016.08	Rear Axle Left & Right Lower Inner	Hatchback 4WD CZGB		Track Control Arm	S062791
	2015.02-2016.08	Rear Axle Left & Right Lower Outer	Hatchback 4WD CZGB		Track Control Arm	S062899
	2015.02-2016.08	Front Axle Left Lower	Hatchback 4WD CZGB		Ball Joint	S080258
	2015.02-2016.08	Front Axle Right Lower	Hatchback 4WD CZGB		Ball Joint	S080259
	2015.02-2016.08	Front Axle Left & Right Lower	Hatchback 4WD CZGB		Control Arm Bushing	510361
	2015.02-2016.08	Rear Axle Left & Right Centre	Hatchback 4WD CZGB		Control Arm Bushing	512203
	2015.02-2016.08	Front Axle Left & Right	Hatchback 4WD CZGB		Tie Rod Axle Joint	S030009
	2015.02-2016.08	Front Axle Left & Right	Hatchback 4WD CZGB		Rod/Strut, stabiliser	S050040
	2015.02-2016.08	Rear Axle Left & Right	Hatchback 4WD CZGB		Rod/Strut, stabiliser	S051234
2.5 (294 kw)	2017.04-2020.10	Rear Axle Left & Right Lower Inner	Hatchback 4WD DAZA/DNWA		Track Control Arm	S062791
	2017.04-2020.10	Rear Axle Left & Right Lower Outer	Hatchback 4WD DAZA/DNWA		Track Control Arm	S062899
	2017.04-2020.10	Front Axle Left Lower	Hatchback 4WD DAZA/DNWA		Ball Joint	S080258
	2017.04-2020.10	Front Axle Right Lower	Hatchback 4WD DAZA/DNWA		Ball Joint	S080259
	2017.04-2020.10	Front Axle Left & Right Lower	Hatchback 4WD DAZA/DNWA		Control Arm Bushing	510361
	2017.04-2020.10	Rear Axle Left & Right Centre	Hatchback 4WD DAZA/DNWA		Control Arm Bushing	512203
	2017.04-2020.10	Front Axle Left & Right	Hatchback 4WD DAZA/DNWA		Tie Rod Axle Joint	S030009
	2017.04-2020.10	Front Axle Left & Right	Hatchback 4WD DAZA/DNWA		Rod/Strut, stabiliser	S050040
	2017.04-2020.10	Rear Axle Left & Right	Hatchback 4WD DAZA/DNWA		Rod/Strut, stabiliser	S051234
RS4 Quattro						
2.9 (331 kw)	2017.09-2019.09	Front Axle Left Lower Inner	Estate 4WD DECA		Track Control Arm	S062926
	2017.09-2019.09	Front Axle Left Upper Inner	Estate 4WD DECA		Track Control Arm	S062930
	2017.09-2019.09	Front Axle Left Lower Outer	Estate 4WD DECA		Track Control Arm	S062924
	2017.09-2019.09	Front Axle Left Upper Outer	Estate 4WD DECA		Track Control Arm	S062928
	2017.09-2019.09	Front Axle Right Lower Inner	Estate 4WD DECA		Track Control Arm	S062927
	2017.09-2019.09	Front Axle Right Upper Inner	Estate 4WD DECA		Track Control Arm	S062931
	2017.09-2019.09	Front Axle Right Lower Outer	Estate 4WD DECA		Track Control Arm	S062925
	2017.09-2019.09	Front Axle Right Upper Outer	Estate 4WD DECA		Track Control Arm	S062929
	2017.09-2019.09	Front Axle Left & Right Lower Outer	Estate 4WD DECA		Ball Joint	S080987
	2017.09-2019.09	Front Axle Left & Right Upper	Estate 4WD DECA		Control Arm Bushing	533522
	2017.09-2019.09	Front Axle Left & Right Lower Inner	Estate 4WD DECA		Control Arm Bushing	531931
	2017.09-2019.09	Front Axle Left & Right Lower Outer	Estate 4WD DECA		Control Arm Bushing	510299
	2017.09-2019.09	Front Axle Left & Right Lower Outer	Estate 4WD DECA		Control Arm Bushing	530215
	2017.09-2019.09	Front Axle Left & Right	Estate 4WD DECA		Tie Rod Axle Joint	S030931
	2017.09-2019.09	Front Axle Left	Estate 4WD DECA		Tie Rod End	S071632
	2017.09-2019.09	Front Axle Right	Estate 4WD DECA		Tie Rod End	S071634
	2017.09-2019.09	Front Axle Left & Right	Estate 4WD DECA		Rod/Strut, stabiliser	S051258
	2017.09-2019.09	Rear Axle Left & Right	Estate 4WD DECA		Rod/Strut, stabiliser	S051433
	2017.09-2019.09	Front Axle	Estate 4WD DECA		Stabiliser Bushing	510138
	2017.09-2019.09	Front Axle	Estate 4WD DECA		Stabiliser Bushing	532579
4.2 (309 kw)	2006.04-2008.08	Front Axle Left Lower Inner	Estate 4WD BNS		Track Control Arm	S060026
	2006.04-2008.08	Front Axle Left Upper Outer	Estate 4WD BNS		Track Control Arm	S060798
	2006.04-2008.08	Front Axle Right Lower Inner	Estate 4WD BNS		Track Control Arm	S060027
	2006.04-2008.08	Front Axle Right Upper Inner	Estate 4WD BNS		Track Control Arm	S060801
	2006.04-2008.08	Front Axle Left & Right Lower Outer	Estate 4WD BNS		Track Control Arm	S060047
	2006.04-2008.08	Rear Axle Left & Right Lower Outer	Estate 4WD BNS		Track Control Arm	S062965
	2006.04-2008.08	Front Axle Left & Right Lower Inner	Estate 4WD BNS		Control Arm Bushing	510301
	2006.04-2008.08	Front Axle Left & Right Lower Outer	Estate 4WD BNS		Control Arm Bushing	510134
	2006.04-2008.08	Rear Axle Left & Right Upper	Estate 4WD BNS		Control Arm Bushing	517141
	2006.04-2008.08	Rear Axle Left & Right Lower Outer	Estate 4WD BNS		Control Arm Bushing	510393
	2006.04-2008.08	Front Axle Left & Right	Estate 4WD BNS		Tie Rod Axle Joint	S030013
	2006.04-2008.08	Front Axle Left & Right	Estate 4WD BNS		Tie Rod End	S070016
	2006.04-2008.08	Front Axle Left	Estate 4WD BNS		Rod/Strut, stabiliser	520523
	2006.04-2008.08	Front Axle Right	Estate 4WD BNS		Rod/Strut, stabiliser	520524
	2006.04-2008.08	Rear Axle Left & Right	Estate 4WD BNS		Rod/Strut, stabiliser	S050042
	2006.04-2008.08	Front Axle	Estate 4WD BNS		Stabiliser Bushing	510138
	2006.04-2008.08	Front Axle	Estate 4WD BNS		Stabiliser Bushing	510139
	2006.04-2008.08	Front Axle	Estate 4WD BNS		Stabiliser Bushing	517806
	2006.04-2008.08	Rear Axle	Estate 4WD BNS		Stabiliser Bushing	517807



	 YEAR	FITTING POSITION	BODY STYLE & DRIVE TYPE & ENGINE	REMARKS	PRODUCT	GSP Ref.
AUDI						
RS4 Quattro						
4.2 (331 kw)	2012.05-2015.08	Front Axle Left Lower Inner	Estate 4WD CFSA	for manufacturer:rear bush Ø65mm	Track Control Arm	S061601
	2012.05-2015.08	Front Axle Left Lower Inner	Estate 4WD CFSA		Track Control Arm	S062261
	2012.05-2015.08	Front Axle Left Upper Inner	Estate 4WD CFSA		Track Control Arm	S060804
	2012.05-2015.08	Front Axle Left Lower Outer	Estate 4WD CFSA		Track Control Arm	S062024
	2012.05-2015.08	Front Axle Left Upper Outer	Estate 4WD CFSA		Track Control Arm	S060802
	2012.05-2015.08	Front Axle Right Lower Inner	Estate 4WD CFSA	for manufacturer:rear bush Ø65mm	Track Control Arm	S061602
	2012.05-2015.08	Front Axle Right Lower Inner	Estate 4WD CFSA		Track Control Arm	S062177
	2012.05-2015.08	Front Axle Right Upper Inner	Estate 4WD CFSA		Track Control Arm	S060805
	2012.05-2015.08	Front Axle Right Lower Outer	Estate 4WD CFSA		Track Control Arm	S062025
	2012.05-2015.08	Front Axle Right Upper Outer	Estate 4WD CFSA		Track Control Arm	S060803
	2012.05-2015.08	Rear Axle Left Upper	Estate 4WD CFSA		Track Control Arm	S061397
	2012.05-2015.08	Rear Axle Left Lower Inner	Estate 4WD CFSA		Track Control Arm	S061574
	2012.05-2015.08	Rear Axle Left Lower Outer	Estate 4WD CFSA		Track Control Arm	S062748
	2012.05-2015.08	Rear Axle Right Upper	Estate 4WD CFSA		Track Control Arm	S061398
	2012.05-2015.08	Rear Axle Right Lower Inner	Estate 4WD CFSA		Track Control Arm	S061575
	2012.05-2015.08	Rear Axle Right Lower Outer	Estate 4WD CFSA		Track Control Arm	S062749
	2012.05-2015.08	Rear Axle Left & Right Lower Inner	Estate 4WD CFSA		Track Control Arm	S062964
	2012.05-2015.08	Front Axle Left & Right Lower Outer	Estate 4WD CFSA		Ball Joint	S080987
	2012.05-2015.08	Front Axle Left & Right Upper	Estate 4WD CFSA		Control Arm Bushing	510136
	2012.05-2015.08	Front Axle Left & Right Lower Inner	Estate 4WD CFSA		Control Arm Bushing	531929
	2012.05-2015.08	Front Axle Left & Right Lower Inner	Estate 4WD CFSA		Control Arm Bushing	531931
	2012.05-2015.08	Front Axle Left & Right Lower Outer	Estate 4WD CFSA		Control Arm Bushing	510299
	2012.05-2015.08	Front Axle Left & Right Lower Outer	Estate 4WD CFSA		Control Arm Bushing	530215
	2012.05-2015.08	Front Axle Left & Right Lower Outer	Estate 4WD CFSA		Control Arm Bushing	530215
	2012.05-2015.08	Rear Axle Left & Right Lower Inner	Estate 4WD CFSA		Control Arm Bushing	533477
	2012.05-2015.08	Front Axle Left & Right	Estate 4WD CFSA		Tie Rod Axle Joint	S030342
	2012.05-2015.08	Front Axle Left	Estate 4WD CFSA		Tie Rod End	S070024
	2012.05-2015.08	Front Axle Right	Estate 4WD CFSA		Tie Rod End	S070025
	2012.05-2015.08	Front Axle Left & Right	Estate 4WD CFSA	Date to:2013.03,For PR no.:2MC	Rod/Strut, stabiliser	S050473
	2012.05-2015.08	Front Axle Left & Right	Estate 4WD CFSA	not For PR no.:X4M/X5F	Rod/Strut, stabiliser	S051258
	2012.05-2015.08	Rear Axle Left & Right	Estate 4WD CFSA		Rod/Strut, stabiliser	S050472
	2012.05-2015.08	Front Axle	Estate 4WD CFSA		Stabiliser Bushing	510138
	2012.05-2015.08	Front Axle	Estate 4WD CFSA	for PR no.:1BA	Stabiliser Bushing	532578
RS5 Quattro						
2.9 (331 kw)	2017.04-	Front Axle Left Upper Inner	Coupe 4WD DECA		Track Control Arm	S062930
	2017.04-	Front Axle Left Lower Outer	Coupe 4WD DECA		Track Control Arm	S062924
	2017.04-	Front Axle Left Upper Outer	Coupe 4WD DECA		Track Control Arm	S062928
	2017.04-	Front Axle Right Upper Inner	Coupe 4WD DECA		Track Control Arm	S062931
	2017.04-	Front Axle Right Lower Outer	Coupe 4WD DECA		Track Control Arm	S062925
	2017.04-	Front Axle Right Upper Outer	Coupe 4WD DECA		Track Control Arm	S062929
	2017.04-	Front Axle Left & Right Lower Outer	Coupe 4WD DECA		Ball Joint	S080987
	2017.04-	Front Axle Left & Right Upper	Coupe 4WD DECA		Control Arm Bushing	533522
	2017.04-	Front Axle Left & Right Lower Inner	Coupe 4WD DECA		Control Arm Bushing	531931
	2017.04-	Front Axle Left & Right Lower Outer	Coupe 4WD DECA		Control Arm Bushing	510299
	2017.04-	Front Axle Left & Right Lower Outer	Coupe 4WD DECA		Control Arm Bushing	530215
	2017.04-	Front Axle Left & Right	Coupe 4WD DECA		Tie Rod Axle Joint	S030931
	2017.04-	Front Axle Left	Coupe 4WD DECA		Tie Rod End	S071632
	2017.04-	Front Axle Right	Coupe 4WD DECA		Tie Rod End	S071634
	2017.04-	Front Axle Left & Right	Coupe 4WD DECA		Rod/Strut, stabiliser	S051258
	2017.04-	Rear Axle Left & Right	Coupe 4WD DECA		Rod/Strut, stabiliser	S051433
	2017.04-	Front Axle	Coupe 4WD DECA	for vehicles with standard suspension,for PR no.:1BM	Stabiliser Bushing	510138
	2017.04-	Front Axle	Coupe 4WD DECA		Stabiliser Bushing	532579
4.2 (331 kw)	2010.03-2017.01	Front Axle Left Lower Inner	Coupe 4WD CFSA		Track Control Arm	S062261
	2010.03-2017.01	Front Axle Left Upper Inner	Coupe 4WD CFSA		Track Control Arm	S060804
	2010.03-2017.01	Front Axle Left Lower Outer	Coupe 4WD CFSA	Date from:2011.08	Track Control Arm	S060806
	2010.03-2017.01	Front Axle Left Upper Outer	Coupe 4WD CFSA		Track Control Arm	S060802
	2010.03-2017.01	Front Axle Right Lower Inner	Coupe 4WD CFSA		Track Control Arm	S062177
	2010.03-2017.01	Front Axle Right Upper Inner	Coupe 4WD CFSA		Track Control Arm	S060805
	2010.03-2017.01	Front Axle Right Lower Outer	Coupe 4WD CFSA	Date from:2011.08	Track Control Arm	S060807
	2010.03-2017.01	Front Axle Right Upper Outer	Coupe 4WD CFSA		Track Control Arm	S060803
	2010.03-2017.01	Rear Axle Left Upper	Coupe 4WD CFSA		Track Control Arm	S061397
	2010.03-2017.01	Rear Axle Left Lower Outer	Coupe 4WD CFSA		Track Control Arm	S062748
	2010.03-2017.01	Rear Axle Right Upper	Coupe 4WD CFSA		Track Control Arm	S061398
	2010.03-2017.01	Rear Axle Right Lower Outer	Coupe 4WD CFSA		Track Control Arm	S062749
	2010.03-2017.01	Rear Axle Left & Right Lower Inner	Coupe 4WD CFSA		Track Control Arm	S062964



	 YEAR	FITTING POSITION	BODY STYLE & DRIVE TYPE & ENGINE	REMARKS	PRODUCT	GSP Ref.
AUDI RS5 Quattro						
4.2 (331 kw)	2010.03-2017.01	Front Axle Left & Right Lower Outer	Coupe 4WD CFSA	Date to:2011.08	Ball Joint	S080283
	2010.03-2017.01	Front Axle Left & Right Lower Outer	Coupe 4WD CFSA	Date from:2011.08	Ball Joint	S080987
	2010.03-2017.01	Front Axle Left & Right Upper	Coupe 4WD CFSA		Control Arm Bushing	510136
	2010.03-2017.01	Front Axle Left & Right Lower Inner	Coupe 4WD CFSA		Control Arm Bushing	531929
	2010.03-2017.01	Front Axle Left & Right Lower Inner	Coupe 4WD CFSA		Control Arm Bushing	531931
	2010.03-2017.01	Front Axle Left & Right Lower Outer	Coupe 4WD CFSA	Date to:2011.08	Control Arm Bushing	510299
	2010.03-2017.01	Front Axle Left & Right Lower Outer	Coupe 4WD CFSA		Control Arm Bushing	530215
	2010.03-2017.01	Rear Axle Left & Right Lower Inner	Coupe 4WD CFSA		Control Arm Bushing	533477
	2010.03-2017.01	Front Axle Left & Right	Coupe 4WD CFSA		Tie Rod Axle Joint	S030342
	2010.03-2017.01	Front Axle Left	Coupe 4WD CFSA		Tie Rod End	S070024
	2010.03-2017.01	Front Axle Right	Coupe 4WD CFSA		Tie Rod End	S070025
	2010.03-2017.01	Front Axle Left & Right	Coupe 4WD CFSA	Date from-to:2011.10-2013.04,For PR no.:2MC	Rod/Strut,stabiliser	S050473
	2010.03-2017.01	Front Axle Left & Right	Coupe 4WD CFSA	For PR no.:2MS	Rod/Strut,stabiliser	S051258
	2010.03-2017.01	Rear Axle Left & Right	Coupe 4WD CFSA		Rod/Strut,stabiliser	S050472
	2010.03-2017.01	Front Axle	Coupe 4WD CFSA	for PR no.:K8R+1BE/1BV	Stabiliser Bushing	510138
	2010.03-2017.01	Front Axle	Coupe 4WD CFSA	Date to:12.2011,For PR no.:K8C/K8R,1BA,1B, Date from:01.2012	Stabiliser Bushing	532578
	2010.03-2017.01	Front Axle	Coupe 4WD CFSA		Stabiliser Bushing	532579
RS6 Quattro						
4.0 (412 kw)	2013.01-2018.09	Front Axle Left Lower Outer	Estate 4WD CRDB/CWUB		Track Control Arm	S062024
	2013.01-2018.09	Front Axle Right Lower Outer	Estate 4WD CRDB/CWUB		Track Control Arm	S062025
	2013.01-2018.09	Rear Axle Left Upper	Estate 4WD CRDB/CWUB		Track Control Arm	S061397
	2013.01-2018.09	Rear Axle Left Lower Inner	Estate 4WD CRDB/CWUB		Track Control Arm	S061574
	2013.01-2018.09	Rear Axle Right Upper	Estate 4WD CRDB/CWUB		Track Control Arm	S061398
	2013.01-2018.09	Rear Axle Right Lower Inner	Estate 4WD CRDB/CWUB		Track Control Arm	S061575
	2013.01-2018.09	Rear Axle Left & Right Lower Inner	Estate 4WD CRDB/CWUB		Track Control Arm	S062964
	2013.01-2018.09	Front Axle Left & Right Lower Outer	Estate 4WD CRDB/CWUB		Ball Joint	S080987
	2013.01-2018.09	Front Axle Left & Right Upper	Estate 4WD CRDB/CWUB		Control Arm Bushing	519053
	2013.01-2018.09	Front Axle Left & Right Lower Inner	Estate 4WD CRDB/CWUB		Control Arm Bushing	531929
	2013.01-2018.09	Front Axle Left & Right Lower Outer	Estate 4WD CRDB/CWUB		Control Arm Bushing	510299
	2013.01-2018.09	Front Axle Left & Right Lower Outer	Estate 4WD CRDB/CWUB		Control Arm Bushing	530215
	2013.01-2018.09	Rear Axle Left & Right Lower Inner	Estate 4WD CRDB/CWUB		Control Arm Bushing	533477
	2013.01-2018.09	Front Axle Left & Right	Estate 4WD CRDB/CWUB		Tie Rod Axle Joint	S030654
	2013.01-2018.09	Front Axle Left	Estate 4WD CRDB/CWUB		Tie Rod End	S070024
	2013.01-2018.09	Front Axle Right	Estate 4WD CRDB/CWUB		Tie Rod End	S070025
	2013.01-2018.09	Front Axle Left & Right	Estate 4WD CRDB/CWUB	Date to:2014.12,Engine Code:CRDB,Date from:2013.11,Engine Code:CRDC	Rod/Strut,stabiliser	S050473
	2013.01-2018.09	Front Axle Left & Right	Estate 4WD CRDB/CWUB	Plastic Material	Rod/Strut,stabiliser	S051258
	2013.01-2018.09	Rear Axle Left & Right	Estate 4WD CRDB/CWUB		Rod/Strut,stabiliser	S050472
	2013.01-2018.09	Front Axle	Estate 4WD CRDB/CWUB		Stabiliser Bushing	510138
	2013.01-2018.09	Front Axle	Estate 4WD CRDB/CWUB		Stabiliser Bushing	532578
	2013.01-2018.09	Front Axle	Estate 4WD CRDB/CWUB		Stabiliser Bushing	532579
4.0 (441 kw)	2019.09-	Front Axle Left Upper Inner	Estate 4WD DJPB		Track Control Arm	S062934
	2019.09-	Front Axle Left Upper Outer	Estate 4WD DJPB		Track Control Arm	S062932
	2019.09-	Front Axle Right Upper Inner	Estate 4WD DJPB		Track Control Arm	S062935
	2019.09-	Front Axle Right Upper Outer	Estate 4WD DJPB		Track Control Arm	S062933
	2019.09-	Front Axle Left & Right Upper	Estate 4WD DJPB		Control Arm Bushing	533901
	2019.09-	Front Axle Left	Estate 4WD DJPB		Tie Rod End	S071632
	2019.09-	Front Axle Right	Estate 4WD DJPB		Tie Rod End	S071634
	2019.09-	Front Axle Left & Right	Estate 4WD DJPB		Rod/Strut,stabiliser	S051258
	2019.09-	Rear Axle Left & Right	Estate 4WD DJPB		Rod/Strut,stabiliser	S051432
5.0 (426 kw)	2008.04-2010.08	Front Axle Left & Right Lower Outer	Estate 4WD BUH		Track Control Arm	S060028
	2008.04-2010.08	Rear Axle Left & Right Lower Outer	Estate 4WD BUH		Track Control Arm	S061506
	2008.04-2010.08	Front Axle Left & Right Lower Outer	Estate 4WD BUH		Control Arm Bushing	510299
	2008.04-2010.08	Front Axle Left & Right Lower Outer	Estate 4WD BUH		Control Arm Bushing	531954
	2008.04-2010.08	Rear Axle Left & Right Upper	Estate 4WD BUH		Control Arm Bushing	517141
	2008.04-2010.08	Rear Axle Left & Right Lower Outer	Estate 4WD BUH		Control Arm Bushing	510393
	2008.04-2010.08	Rear Axle Left & Right Lower Outer	Estate 4WD BUH		Control Arm Bushing	510394
	2008.04-2010.08	Front Axle	Estate 4WD BUH		Suspension Repair Kit	S990014SK
	2008.04-2010.08	Front Axle Left & Right	Estate 4WD BUH		Tie Rod Axle Joint	S030341
	2008.04-2010.08	Front Axle Left & Right	Estate 4WD BUH		Rod/Strut,stabiliser	S050022
	2008.04-2010.08	Rear Axle Left & Right	Estate 4WD BUH		Rod/Strut,stabiliser	S050025
	2008.04-2010.08	Rear Axle Left & Right	Estate 4WD BUH	Chassis no.to:4B-5-050.000	Rod/Strut,stabiliser	S070017
	2008.04-2010.08	Front Axle	Estate 4WD BUH	Stabiliser Ø:27 mm	Stabiliser Bushing	510139
	2008.04-2010.08	Front Axle	Estate 4WD BUH		Stabiliser Bushing	517806
	2008.09-2010.08	Front Axle Left & Right Lower Outer	Saloon 4WD BUH		Track Control Arm	S060028



	 YEAR	FITTING POSITION	BODY STYLE & DRIVE TYPE & ENGINE	REMARKS	PRODUCT	GSP Ref.	
AUDI RS6 Quattro							
5.0 (426 kw)	2008.09-2010.08	Rear Axle Left & Right Lower Outer	Saloon 4WD BUH		Track Control Arm	S061506	
	2008.09-2010.08	Front Axle Left & Right Lower Outer	Saloon 4WD BUH		Control Arm Bushing	510299	
	2008.09-2010.08	Front Axle Left & Right Lower Outer	Saloon 4WD BUH		Control Arm Bushing	531954	
	2008.09-2010.08	Rear Axle Left & Right Upper	Saloon 4WD BUH		Control Arm Bushing	517141	
	2008.09-2010.08	Rear Axle Left & Right Lower Outer	Saloon 4WD BUH		Control Arm Bushing	510393	
	2008.09-2010.08	Rear Axle Left & Right Lower Outer	Saloon 4WD BUH		Control Arm Bushing	510394	
	2008.09-2010.08	Front Axle	Saloon 4WD BUH		Suspension Repair Kit	S990014SK	
	2008.09-2010.08	Front Axle Left & Right	Saloon 4WD BUH		Tie Rod Axle Joint	S030341	
	2008.09-2010.08	Front Axle Left & Right	Saloon 4WD BUH		Rod/Strut, stabiliser	S050022	
	2008.09-2010.08	Rear Axle Left & Right	Saloon 4WD BUH		Rod/Strut, stabiliser	S050025	
	2008.09-2010.08	Rear Axle Left & Right	Saloon 4WD BUH	Chassis no.to:4B-5-050 000	Rod/Strut, stabiliser	S070017	
	2008.09-2010.08	Front Axle	Saloon 4WD BUH	Stabiliser Ø:27 mm	Stabiliser Bushing	510139	
	2008.09-2010.08	Front Axle	Saloon 4WD BUH		Stabiliser Bushing	517806	
	RS7 Sportback Quattro						
4.0 (412 kw)	2013.01-2018.05	Front Axle Left Upper Outer	Hatchback 4WD CRDB/CWUB		Track Control Arm	S060802	
	2013.01-2018.05	Front Axle Right Upper Outer	Hatchback 4WD CRDB/CWUB		Track Control Arm	S060803	
	2013.01-2018.05	Rear Axle Left Upper	Hatchback 4WD CRDB/CWUB		Track Control Arm	S061397	
	2013.01-2018.05	Rear Axle Left Lower Inner	Hatchback 4WD CRDB/CWUB		Track Control Arm	S061574	
	2013.01-2018.05	Rear Axle Right Upper	Hatchback 4WD CRDB/CWUB		Track Control Arm	S061398	
	2013.01-2018.05	Rear Axle Right Lower Inner	Hatchback 4WD CRDB/CWUB		Track Control Arm	S061575	
	2013.01-2018.05	Rear Axle Left & Right Lower Inner	Hatchback 4WD CRDB/CWUB		Track Control Arm	S062964	
	2013.01-2018.05	Front Axle Left & Right Lower Outer	Hatchback 4WD CRDB/CWUB		Ball Joint	S080987	
	2013.01-2018.05	Front Axle Left & Right Upper	Hatchback 4WD CRDB/CWUB		Control Arm Bushing	519053	
	2013.01-2018.05	Front Axle Left & Right Lower Inner	Hatchback 4WD CRDB/CWUB		Control Arm Bushing	531929	
	2013.01-2018.05	Front Axle Left & Right Lower Outer	Hatchback 4WD CRDB/CWUB		Control Arm Bushing	510299	
	2013.01-2018.05	Front Axle Left & Right Lower Outer	Hatchback 4WD CRDB/CWUB		Control Arm Bushing	530215	
	2013.01-2018.05	Rear Axle Left & Right Lower Inner	Hatchback 4WD CRDB/CWUB		Control Arm Bushing	533477	
	2013.01-2018.05	Front Axle Left & Right	Hatchback 4WD CRDB/CWUB		Tie Rod Axle Joint	S030654	
	2013.01-2018.05	Front Axle Left	Hatchback 4WD CRDB/CWUB		Tie Rod End	S070024	
	2013.01-2018.05	Front Axle Right	Hatchback 4WD CRDB/CWUB		Tie Rod End	S070025	
	2013.01-2018.05	Front Axle Left & Right	Hatchback 4WD CRDB/CWUB	Aluminum Material	Rod/Strut, stabiliser	S050473	
	2013.01-2018.05	Front Axle Left & Right	Hatchback 4WD CRDB/CWUB	Plastic Material	Rod/Strut, stabiliser	S051258	
	2013.01-2018.05	Rear Axle Left & Right	Hatchback 4WD CRDB/CWUB		Rod/Strut, stabiliser	S050472	
	2013.01-2018.05	Front Axle	Hatchback 4WD CRDB/CWUB		Stabiliser Bushing	510138	
2013.01-2018.05	Front Axle	Hatchback 4WD CRDB/CWUB		Stabiliser Bushing	532578		
2013.01-2018.05	Front Axle	Hatchback 4WD CRDB/CWUB		Stabiliser Bushing	532579		
RSQ3 Quattro							
2.5 (228 kw)	2013.05-2018.10	Front Axle Left & Right Lower	SUV 4WD CTSA		Track Control Arm	S060762	
	2013.05-2018.10	Rear Axle Left Centre	SUV 4WD CTSA		Track Control Arm	S063095	
	2013.05-2018.10	Rear Axle Left Lower Inner	SUV 4WD CTSA		Track Control Arm	510349	
	2013.05-2018.10	Rear Axle Right Centre	SUV 4WD CTSA		Track Control Arm	S063094	
	2013.05-2018.10	Rear Axle Right Lower Inner	SUV 4WD CTSA		Track Control Arm	510350	
	2013.05-2018.10	Rear Axle Left & Right Lower Outer	SUV 4WD CTSA		Track Control Arm	S061468	
	2013.05-2018.10	Front Axle Left Lower	SUV 4WD CTSA	For PR no.:G09, For PR no.:G09	Ball Joint	S080013	
	2013.05-2018.10	Front Axle Left Lower	SUV 4WD CTSA	For PR no.:G44	Ball Joint	S080258	
	2013.05-2018.10	Front Axle Right Lower	SUV 4WD CTSA	For PR no.:G09	Ball Joint	S080012	
	2013.05-2018.10	Front Axle Right Lower	SUV 4WD CTSA	For PR no.:G44	Ball Joint	S080259	
	2013.05-2018.10	Front Axle Left & Right Lower	SUV 4WD CTSA	Date to 2015, 10 for left-hand drive vehicles for right-hand drive vehicles	Control Arm Bushing	510353	
	2013.05-2018.10	Front Axle Left & Right Lower	SUV 4WD CTSA		Control Arm Bushing	510356	
	2013.05-2018.10	Front Axle Left & Right Lower	SUV 4WD CTSA		Control Arm Bushing	510361	
	2013.05-2018.10	Rear Axle Left & Right Upper	SUV 4WD CTSA		Control Arm Bushing	516372	
	2013.05-2018.10	Rear Axle Left & Right Upper	SUV 4WD CTSA		Control Arm Bushing	516408	
	2013.05-2018.10	Rear Axle Left & Right Lower Inner	SUV 4WD CTSA		Control Arm Bushing	510351	
	2013.05-2018.10	Rear Axle Left & Right Lower Inner	SUV 4WD CTSA		Control Arm Bushing	510352	
	2013.05-2018.10	Rear Axle Left & Right Lower Outer	SUV 4WD CTSA		Control Arm Bushing	516370	
	2013.05-2018.10	Front Axle Left & Right	SUV 4WD CTSA		Tie Rod Axle Joint	S030009	
	2013.05-2018.10	Front Axle Left	SUV 4WD CTSA		Tie Rod End	S070032	
	2013.05-2018.10	Front Axle Right	SUV 4WD CTSA		Tie Rod End	S070033	
	2013.05-2018.10	Front Axle Left & Right	SUV 4WD CTSA		Rod/Strut, stabiliser	S050040	
	2013.05-2018.10	Rear Axle Left & Right	SUV 4WD CTSA		Rod/Strut, stabiliser	S050035	
	2013.05-2018.10	Front Axle	SUV 4WD CTSA		Stabiliser Bushing	535187K	
	2013.05-2018.10	Rear Axle	SUV 4WD CTSA		Stabiliser Bushing	516447	
	2.5 (250 kw)	2013.05-2018.10	Rear Axle Left Centre	SUV 4WD CZGA		Track Control Arm	S063095
		2013.05-2018.10	Rear Axle Left Lower Inner	SUV 4WD CZGA		Track Control Arm	510349



	 YEAR	FITTING POSITION	BODY STYLE & DRIVE TYPE & ENGINE	REMARKS	PRODUCT	GSP Ref.
AUDI RSQ3 Quattro						
2.5 (250 kw)	2013.05-2018.10	Rear Axle Right Centre	SUV 4WD CZGA		Track Control Arm	S063094
	2013.05-2018.10	Rear Axle Right Lower Inner	SUV 4WD CZGA		Track Control Arm	510350
	2013.05-2018.10	Rear Axle Left & Right Lower Outer	SUV 4WD CZGA		Track Control Arm	S061468
	2013.05-2018.10	Front Axle Left Lower	SUV 4WD CZGA	For PR no.:G09	Ball Joint	S080013
	2013.05-2018.10	Front Axle Left Lower	SUV 4WD CZGA	For PR no.:G44	Ball Joint	S080258
	2013.05-2018.10	Front Axle Right Lower	SUV 4WD CZGA	For PR no.:G09	Ball Joint	S080012
	2013.05-2018.10	Front Axle Right Lower	SUV 4WD CZGA	For PR no.:G44	Ball Joint	S080259
	2013.05-2018.10	Front Axle Left & Right Lower	SUV 4WD CZGA		Control Arm Bushing	510356
	2013.05-2018.10	Front Axle Left & Right Lower	SUV 4WD CZGA		Control Arm Bushing	510361
	2013.05-2018.10	Rear Axle Left & Right Upper	SUV 4WD CZGA		Control Arm Bushing	516372
	2013.05-2018.10	Rear Axle Left & Right Upper	SUV 4WD CZGA		Control Arm Bushing	516408
	2013.05-2018.10	Rear Axle Left & Right Lower Inner	SUV 4WD CZGA		Control Arm Bushing	510351
	2013.05-2018.10	Rear Axle Left & Right Lower Inner	SUV 4WD CZGA		Control Arm Bushing	510352
	2013.05-2018.10	Rear Axle Left & Right Lower Outer	SUV 4WD CZGA		Control Arm Bushing	516370
	2013.05-2018.10	Front Axle Left & Right	SUV 4WD CZGA		Tie Rod Axle Joint	S030009
	2013.05-2018.10	Front Axle Left	SUV 4WD CZGA		Tie Rod End	S070032
	2013.05-2018.10	Front Axle Right	SUV 4WD CZGA		Tie Rod End	S070033
	2013.05-2018.10	Front Axle Left & Right	SUV 4WD CZGA		Rod/Strut,stabiliser	S050040
	2013.05-2018.10	Rear Axle Left & Right	SUV 4WD CZGA		Rod/Strut,stabiliser	S050035
	2013.05-2018.10	Front Axle	SUV 4WD CZGA		Stabiliser Bushing	535187K
	2013.05-2018.10	Rear Axle	SUV 4WD CZGA		Stabiliser Bushing	516447
S3 Quattro						
1.8 (165 kw)	2001.08-2003.06	Front Axle Left Lower	Hatchback 4WD BAM		Track Control Arm	S060337
	2001.08-2003.06	Front Axle Right Lower	Hatchback 4WD BAM		Track Control Arm	S060338
	2001.08-2003.06	Front Axle Left & Right Lower	Hatchback 4WD BAM		Ball Joint	S080357
	2001.08-2003.06	Front Axle Left & Right Lower	Hatchback 4WD BAM		Control Arm Bushing	518115
	2001.08-2003.06	Front Axle Left & Right Lower	Hatchback 4WD BAM	Date from:2000.05.From Chassis:8LY117501,	Control Arm Bushing	535313
	2001.08-2003.06	Front Axle Left	Hatchback 4WD BAM		Rod Assembly	S100004
	2001.08-2003.06	Front Axle Right	Hatchback 4WD BAM		Rod Assembly	S100003
	2001.08-2003.06	Front Axle Left & Right	Hatchback 4WD BAM		Tie Rod Axle Joint	S030011
	2001.08-2003.06	Front Axle Left & Right	Hatchback 4WD BAM		Tie Rod Axle Joint	S030425
	2001.08-2003.06	Front Axle Left	Hatchback 4WD BAM		Tie Rod End	S070035
	2001.08-2003.06	Front Axle Right	Hatchback 4WD BAM		Tie Rod End	S070034
	2001.08-2003.06	Front Axle Left	Hatchback 4WD BAM		Rod/Strut,stabiliser	S050043
	2001.08-2003.06	Front Axle Right	Hatchback 4WD BAM		Rod/Strut,stabiliser	S050036
	2001.08-2003.06	Rear Axle Left & Right	Hatchback 4WD BAM	for vehicles with off-road suspension.For PR no.:1JW	Rod/Strut,stabiliser	S050021
	2001.08-2003.06	Rear Axle Left & Right	Hatchback 4WD BAM	for vehicles with sports suspension.For PR no.:1JF	Rod/Strut,stabiliser	S050048
	2001.08-2003.06	Front Axle	Hatchback 4WD BAM	for PR no.:0AN	Stabiliser Bushing	510232
	2001.08-2003.06	Front Axle	Hatchback 4WD BAM	for PR no.:0AN	Stabiliser Bushing	517166
	2001.08-2003.06	Front Axle	Hatchback 4WD BAM		Steering Boot	540328
2.0 (210 kw)	2014.05-2016.08	Front Axle Left Lower	Saloon 4WD CJXF		Track Control Arm	S062137
	2014.05-2016.08	Front Axle Left Lower	Saloon 4WD CJXF	Date to:2016.10	Track Control Arm	S062976
	2014.05-2016.08	Front Axle Right Lower	Saloon 4WD CJXF		Track Control Arm	S062134
	2014.05-2016.08	Front Axle Right Lower	Saloon 4WD CJXF	Date to:2016.05	Track Control Arm	S062977
	2014.05-2016.08	Rear Axle Left & Right Lower Inner	Saloon 4WD CJXF		Track Control Arm	S062791
	2014.05-2016.08	Rear Axle Left & Right Lower Outer	Saloon 4WD CJXF		Track Control Arm	S062899
	2014.05-2016.08	Front Axle Left Lower	Saloon 4WD CJXF		Ball Joint	S080258
	2014.05-2016.08	Front Axle Right Lower	Saloon 4WD CJXF		Ball Joint	S080259
	2014.05-2016.08	Front Axle Left & Right Lower	Saloon 4WD CJXF		Control Arm Bushing	510361
	2014.05-2016.08	Front Axle Left & Right Lower	Saloon 4WD CJXF		Control Arm Bushing	531431
	2014.05-2016.08	Rear Axle Left & Right Centre	Saloon 4WD CJXF		Control Arm Bushing	512203
	2014.05-2016.08	Front Axle	Saloon 4WD CJXF		Suspension Repair Kit	S990061SK
	2014.05-2016.08	Front Axle Left & Right	Saloon 4WD CJXF		Tie Rod Axle Joint	S030009
	2014.05-2016.08	Front Axle Left	Saloon 4WD CJXF		Tie Rod End	S070032
	2014.05-2016.08	Front Axle Right	Saloon 4WD CJXF		Tie Rod End	S070033
	2014.05-2016.08	Front Axle Left & Right	Saloon 4WD CJXF		Rod/Strut,stabiliser	S050040
	2014.05-2016.08	Rear Axle Left & Right	Saloon 4WD CJXF		Rod/Strut,stabiliser	S051234
S3 Sportback Quattro						
2.0 (188 kw)	2008.07-2013.03	Front Axle Left Lower	Hatchback 4WD CDLC		Track Control Arm	S060342
	2008.07-2013.03	Front Axle Left Lower	Hatchback 4WD CDLC		Track Control Arm	S062032
	2008.07-2013.03	Front Axle Left Lower	Hatchback 4WD CDLC	Date from:2011.08	Track Control Arm	S063005
	2008.07-2013.03	Front Axle Right Lower	Hatchback 4WD CDLC		Track Control Arm	S060341
	2008.07-2013.03	Front Axle Right Lower	Hatchback 4WD CDLC		Track Control Arm	S062033
	2008.07-2013.03	Front Axle Right Lower	Hatchback 4WD CDLC	Date from:2011.08	Track Control Arm	S063006



	 YEAR	FITTING POSITION	BODY STYLE & DRIVE TYPE & ENGINE	REMARKS	PRODUCT	GSP Ref.
AUDI						
S3 Sportback Quattro						
2.0 (188 kw)	2008.07-2013.03	Rear Axle Left Centre	Hatchback 4WD CDLC		Track Control Arm	S061407
	2008.07-2013.03	Rear Axle Left Lower Inner	Hatchback 4WD CDLC		Track Control Arm	510349
	2008.07-2013.03	Rear Axle Right Centre	Hatchback 4WD CDLC		Track Control Arm	S061408
	2008.07-2013.03	Rear Axle Right Lower Inner	Hatchback 4WD CDLC		Track Control Arm	510350
	2008.07-2013.03	Rear Axle Left & Right Upper	Hatchback 4WD CDLC		Track Control Arm	510346
	2008.07-2013.03	Rear Axle Left & Right Lower Outer	Hatchback 4WD CDLC		Track Control Arm	S061468
	2008.07-2013.03	Front Axle Left Lower	Hatchback 4WD CDLC	Date from:2009.06;For PR code:12A/12D/12F	Ball Joint	S080013
	2008.07-2013.03	Front Axle Left Lower	Hatchback 4WD CDLC		Ball Joint	S080258
	2008.07-2013.03	Front Axle Right Lower	Hatchback 4WD CDLC	Date from:2009.06;For PR code:12A/12D/12F	Ball Joint	S080012
	2008.07-2013.03	Front Axle Right Lower	Hatchback 4WD CDLC		Ball Joint	S080259
	2008.07-2013.03	Front Axle Left Lower	Hatchback 4WD CDLC		Control Arm Bushing	510333
	2008.07-2013.03	Front Axle Left Lower	Hatchback 4WD CDLC		Control Arm Bushing	533862
	2008.07-2013.03	Front Axle Right Lower	Hatchback 4WD CDLC		Control Arm Bushing	510334
	2008.07-2013.03	Front Axle Right Lower	Hatchback 4WD CDLC		Control Arm Bushing	533863
	2008.07-2013.03	Front Axle Left & Right Lower	Hatchback 4WD CDLC		Control Arm Bushing	510361
	2008.07-2013.03	Front Axle Left & Right Lower	Hatchback 4WD CDLC		Control Arm Bushing	535342
	2008.07-2013.03	Rear Axle Left & Right Upper	Hatchback 4WD CDLC		Control Arm Bushing	516372
	2008.07-2013.03	Rear Axle Left & Right Upper	Hatchback 4WD CDLC		Control Arm Bushing	516408
	2008.07-2013.03	Rear Axle Left & Right Lower Inner	Hatchback 4WD CDLC		Control Arm Bushing	510351
	2008.07-2013.03	Rear Axle Left & Right Lower Inner	Hatchback 4WD CDLC		Control Arm Bushing	510352
	2008.07-2013.03	Rear Axle Left & Right Lower Outer	Hatchback 4WD CDLC		Control Arm Bushing	516370
	2008.07-2013.03	Rear Axle	Hatchback 4WD CDLC		Suspension Repair Kit	S990019SK
	2008.07-2013.03	Front Axle Left & Right	Hatchback 4WD CDLC		Tie Rod Axle Joint	S030009
	2008.07-2013.03	Front Axle Left	Hatchback 4WD CDLC		Tie Rod End	S070032
	2008.07-2013.03	Front Axle Right	Hatchback 4WD CDLC		Tie Rod End	S070033
	2008.07-2013.03	Front Axle Left & Right	Hatchback 4WD CDLC		Rod/Strut,stabiliser	S050040
	2008.07-2013.03	Rear Axle Left & Right	Hatchback 4WD CDLC		Rod/Strut,stabiliser	S050035
	2008.07-2013.03	Rear Axle	Hatchback 4WD CDLC	for PR no.:0BE	Stabiliser Bushing	516447
	2008.07-2013.03	Rear Axle	Hatchback 4WD CDLC		Stabiliser Bushing	530199
2.0 (210 kw)	2014.05-2016.08	Front Axle Left Lower	Hatchback 4WD CJXF		Track Control Arm	S062137
	2014.05-2016.08	Front Axle Left Lower	Hatchback 4WD CJXF		Track Control Arm	S062976
	2014.05-2016.08	Front Axle Right Lower	Hatchback 4WD CJXF		Track Control Arm	S062134
	2014.05-2016.08	Front Axle Right Lower	Hatchback 4WD CJXF	Date to:2016.05	Track Control Arm	S062977
	2014.05-2016.08	Rear Axle Left & Right Lower Inner	Hatchback 4WD CJXF		Track Control Arm	S062791
	2014.05-2016.08	Rear Axle Left & Right Lower Outer	Hatchback 4WD CJXF		Track Control Arm	S062899
	2014.05-2016.08	Front Axle Left Lower	Hatchback 4WD CJXF		Ball Joint	S080258
	2014.05-2016.08	Front Axle Right Lower	Hatchback 4WD CJXF		Ball Joint	S080259
	2014.05-2016.08	Front Axle Left & Right Lower	Hatchback 4WD CJXF		Control Arm Bushing	510361
	2014.05-2016.08	Front Axle Left & Right Lower	Hatchback 4WD CJXF		Control Arm Bushing	531431
	2014.05-2016.08	Rear Axle Left & Right Centre	Hatchback 4WD CJXF		Control Arm Bushing	512203
	2014.05-2016.08	Front Axle	Hatchback 4WD CJXF		Suspension Repair Kit	S990061SK
	2014.05-2016.08	Front Axle Left & Right	Hatchback 4WD CJXF		Tie Rod Axle Joint	S030009
	2014.05-2016.08	Front Axle Left	Hatchback 4WD CJXF		Tie Rod End	S070032
	2014.05-2016.08	Front Axle Right	Hatchback 4WD CJXF		Tie Rod End	S070033
	2014.05-2016.08	Front Axle Left & Right	Hatchback 4WD CJXF		Rod/Strut,stabiliser	S050040
	2014.05-2016.08	Rear Axle Left & Right	Hatchback 4WD CJXF		Rod/Strut,stabiliser	S051234
S4 Quattro						
3.0 (245 kw)	2009.03-2015.12	Front Axle Left Lower Inner	Estate 4WD CAKA/CCBA/CGWC/CGXC/CREC/CTUB	Date to: 2009.10	Track Control Arm	S060038
	2009.03-2015.12	Front Axle Left Lower Inner	Saloon 4WD CAKA/CCBA/CGWC/CGXC/CREC/CTUB	Date to: 2009.10	Track Control Arm	S060038
	2009.03-2015.12	Front Axle Left Lower Inner	Estate 4WD CAKA/CCBA/CGWC/CGXC/CREC/CTUB	Engine code:CCBA,CAKA,Date from:10-2009,11-2010,05,VIN WAU***K	Track Control Arm	S061601
	2009.03-2015.12	Front Axle Left Lower Inner	Saloon 4WD CAKA/CCBA/CGWC/CGXC/CREC/CTUB	Engine code:CCBA,CAKA,Date from:10-2009,11-2010,05,VIN WAU***K	Track Control Arm	S061601
	2009.03-2015.12	Front Axle Left Lower Inner	Estate 4WD CAKA/CCBA/CGWC/CGXC/CREC/CTUB		Track Control Arm	S062261
	2009.03-2015.12	Front Axle Left Lower Inner	Saloon 4WD CAKA/CCBA/CGWC/CGXC/CREC/CTUB		Track Control Arm	S062261
	2009.03-2015.12	Front Axle Left Upper Inner	Estate 4WD CAKA/CCBA/CGWC/CGXC/CREC/CTUB		Track Control Arm	S060804
	2009.03-2015.12	Front Axle Left Upper Inner	Saloon 4WD CAKA/CCBA/CGWC/CGXC/CREC/CTUB		Track Control Arm	S060804
	2009.03-2015.12	Front Axle Left Lower Outer	Estate 4WD CAKA/CCBA/CGWC/CGXC/CREC/CTUB	Engine code:CCBA,CAKA,Date from:10-2009,11-2010,05,VIN WAU***K	Track Control Arm	S060806
	2009.03-2015.12	Front Axle Left Lower Outer	Saloon 4WD CAKA/CCBA/CGWC/CGXC/CREC/CTUB	Engine code:CCBA,CAKA,Date from:10-2009,11-2010,05,VIN WAU***K	Track Control Arm	S060806
	2009.03-2015.12	Front Axle Left Lower Outer	Estate 4WD CAKA/CCBA/CGWC/CGXC/CREC/CTUB		Track Control Arm	S062024
	2009.03-2015.12	Front Axle Left Upper Outer	Estate 4WD CAKA/CCBA/CGWC/CGXC/CREC/CTUB		Track Control Arm	S060802
	2009.03-2015.12	Front Axle Left Upper Outer	Saloon 4WD CAKA/CCBA/CGWC/CGXC/CREC/CTUB		Track Control Arm	S060802
	2009.03-2015.12	Front Axle Right Lower Inner	Estate 4WD CAKA/CCBA/CGWC/CGXC/CREC/CTUB	Date to:2009.10	Track Control Arm	S060039
	2009.03-2015.12	Front Axle Right Lower Inner	Saloon 4WD CAKA/CCBA/CGWC/CGXC/CREC/CTUB	Date to:2009.10	Track Control Arm	S060039
	2009.03-2015.12	Front Axle Right Lower Inner	Estate 4WD CAKA/CCBA/CGWC/CGXC/CREC/CTUB	Engine code:CCBA,CAKA,Date from:10-2009,11-2010,05,VIN WAU***K	Track Control Arm	S061602
	2009.03-2015.12	Front Axle Right Lower Inner	Saloon 4WD CAKA/CCBA/CGWC/CGXC/CREC/CTUB	Engine code:CCBA,CAKA,Date from:10-2009,11-2010,05,VIN WAU***K	Track Control Arm	S061602



	 YEAR	FITTING POSITION	BODY STYLE & DRIVE TYPE & ENGINE	REMARKS	PRODUCT	GSP Ref.
AUDI						
S4 Quattro						
3.0 (245 kw)	2009.03-2015.12	Front Axle Right Lower Inner	Estate 4WD CAKA/CCBA/CGWC/GX/C/CREC/CTUB		Track Control Arm	S062177
	2009.03-2015.12	Front Axle Right Lower Inner	Saloon 4WD CAKA/CCBA/CGWC/GX/C/CREC/CTUB		Track Control Arm	S062177
	2009.03-2015.12	Front Axle Right Upper Inner	Estate 4WD CAKA/CCBA/CGWC/GX/C/CREC/CTUB		Track Control Arm	S060805
	2009.03-2015.12	Front Axle Right Upper Inner	Saloon 4WD CAKA/CCBA/CGWC/GX/C/CREC/CTUB		Track Control Arm	S060805
	2009.03-2015.12	Front Axle Right Lower Outer	Estate 4WD CAKA/CCBA/CGWC/GX/C/CREC/CTUB	Engine code:CCBA,CAKA,Date from:2011.08;Engine code:CGXC,CREC,CGWC,CTUB	Track Control Arm	S060807
	2009.03-2015.12	Front Axle Right Lower Outer	Saloon 4WD CAKA/CCBA/CGWC/GX/C/CREC/CTUB	Engine code:CCBA,CAKA,Date from:2011.08;Engine code:CGXC,CREC,CGWC,CTUB	Track Control Arm	S060807
	2009.03-2015.12	Front Axle Right Lower Outer	Estate 4WD CAKA/CCBA/CGWC/GX/C/CREC/CTUB		Track Control Arm	S062025
	2009.03-2015.12	Front Axle Right Upper Outer	Estate 4WD CAKA/CCBA/CGWC/GX/C/CREC/CTUB		Track Control Arm	S060803
	2009.03-2015.12	Front Axle Right Upper Outer	Saloon 4WD CAKA/CCBA/CGWC/GX/C/CREC/CTUB		Track Control Arm	S060803
	2009.03-2015.12	Rear Axle Left Upper	Estate 4WD CAKA/CCBA/CGWC/GX/C/CREC/CTUB		Track Control Arm	S061397
	2009.03-2015.12	Rear Axle Left Upper	Saloon 4WD CAKA/CCBA/CGWC/GX/C/CREC/CTUB		Track Control Arm	S061397
	2009.03-2015.12	Rear Axle Left Lower Inner	Estate 4WD CAKA/CCBA/CGWC/GX/C/CREC/CTUB		Track Control Arm	S061574
	2009.03-2015.12	Rear Axle Left Lower Inner	Saloon 4WD CAKA/CCBA/CGWC/GX/C/CREC/CTUB		Track Control Arm	S061574
	2009.03-2015.12	Rear Axle Left Lower Outer	Estate 4WD CAKA/CCBA/CGWC/GX/C/CREC/CTUB		Track Control Arm	S062748
	2009.03-2015.12	Rear Axle Left Lower Outer	Saloon 4WD CAKA/CCBA/CGWC/GX/C/CREC/CTUB		Track Control Arm	S062748
	2009.03-2015.12	Rear Axle Right Upper	Estate 4WD CAKA/CCBA/CGWC/GX/C/CREC/CTUB		Track Control Arm	S061398
	2009.03-2015.12	Rear Axle Right Upper	Saloon 4WD CAKA/CCBA/CGWC/GX/C/CREC/CTUB		Track Control Arm	S061398
	2009.03-2015.12	Rear Axle Right Lower Inner	Estate 4WD CAKA/CCBA/CGWC/GX/C/CREC/CTUB		Track Control Arm	S061575
	2009.03-2015.12	Rear Axle Right Lower Inner	Saloon 4WD CAKA/CCBA/CGWC/GX/C/CREC/CTUB		Track Control Arm	S061575
	2009.03-2015.12	Rear Axle Right Lower Outer	Estate 4WD CAKA/CCBA/CGWC/GX/C/CREC/CTUB		Track Control Arm	S062749
	2009.03-2015.12	Rear Axle Right Lower Outer	Saloon 4WD CAKA/CCBA/CGWC/GX/C/CREC/CTUB		Track Control Arm	S062749
	2009.03-2015.12	Rear Axle Left & Right Lower Inner	Estate 4WD CAKA/CCBA/CGWC/GX/C/CREC/CTUB		Track Control Arm	S062964
	2009.03-2015.12	Rear Axle Left & Right Lower Inner	Saloon 4WD CAKA/CCBA/CGWC/GX/C/CREC/CTUB		Track Control Arm	S062964
	2009.03-2015.12	Front Axle Left & Right Lower Outer	Estate 4WD CAKA/CCBA/CGWC/GX/C/CREC/CTUB		Ball Joint	S080283
	2009.03-2015.12	Front Axle Left & Right Lower Outer	Saloon 4WD CAKA/CCBA/CGWC/GX/C/CREC/CTUB		Ball Joint	S080283
	2009.03-2015.12	Front Axle Left & Right Lower Outer	Estate 4WD CAKA/CCBA/CGWC/GX/C/CREC/CTUB	Engine code:CCBA,CAKA,Date from:2011.08;Engine code:CGXC,CREC,CGWC,CTUB	Ball Joint	S080987
	2009.03-2015.12	Front Axle Left & Right Lower Outer	Saloon 4WD CAKA/CCBA/CGWC/GX/C/CREC/CTUB	Engine code:CCBA,CAKA,Date from:2011.08;Engine code:CGXC,CREC,CGWC,CTUB	Ball Joint	S080987
	2009.03-2015.12	Front Axle Left & Right Upper	Estate 4WD CAKA/CCBA/CGWC/GX/C/CREC/CTUB		Control Arm Bushing	510136
	2009.03-2015.12	Front Axle Left & Right Upper	Saloon 4WD CAKA/CCBA/CGWC/GX/C/CREC/CTUB		Control Arm Bushing	510136
	2009.03-2015.12	Front Axle Left & Right Lower Inner	Estate 4WD CAKA/CCBA/CGWC/GX/C/CREC/CTUB		Control Arm Bushing	530214
	2009.03-2015.12	Front Axle Left & Right Lower Inner	Saloon 4WD CAKA/CCBA/CGWC/GX/C/CREC/CTUB		Control Arm Bushing	530214
	2009.03-2015.12	Front Axle Left & Right Lower Inner	Estate 4WD CAKA/CCBA/CGWC/GX/C/CREC/CTUB		Control Arm Bushing	531929
	2009.03-2015.12	Front Axle Left & Right Lower Inner	Saloon 4WD CAKA/CCBA/CGWC/GX/C/CREC/CTUB		Control Arm Bushing	531929
	2009.03-2015.12	Front Axle Left & Right Lower Inner	Estate 4WD CAKA/CCBA/CGWC/GX/C/CREC/CTUB		Control Arm Bushing	531931
	2009.03-2015.12	Front Axle Left & Right Lower Inner	Saloon 4WD CAKA/CCBA/CGWC/GX/C/CREC/CTUB		Control Arm Bushing	531931
	2009.03-2015.12	Front Axle Left & Right Lower Outer	Estate 4WD CAKA/CCBA/CGWC/GX/C/CREC/CTUB	Date to:2011.08	Control Arm Bushing	510299
	2009.03-2015.12	Front Axle Left & Right Lower Outer	Saloon 4WD CAKA/CCBA/CGWC/GX/C/CREC/CTUB	Date to:2011.08	Control Arm Bushing	510299
	2009.03-2015.12	Front Axle Left & Right Lower Outer	Estate 4WD CAKA/CCBA/CGWC/GX/C/CREC/CTUB		Control Arm Bushing	530215
	2009.03-2015.12	Front Axle Left & Right Lower Outer	Saloon 4WD CAKA/CCBA/CGWC/GX/C/CREC/CTUB		Control Arm Bushing	530215
	2009.03-2015.12	Rear Axle Left & Right Lower Inner	Estate 4WD CAKA/CCBA/CGWC/GX/C/CREC/CTUB		Control Arm Bushing	533477
	2009.03-2015.12	Rear Axle Left & Right Lower Inner	Saloon 4WD CAKA/CCBA/CGWC/GX/C/CREC/CTUB		Control Arm Bushing	533477
	2009.03-2015.12	Front Axle Left & Right	Estate 4WD CAKA/CCBA/CGWC/GX/C/CREC/CTUB		Tie Rod Axle Joint	S030342
	2009.03-2015.12	Front Axle Left & Right	Saloon 4WD CAKA/CCBA/CGWC/GX/C/CREC/CTUB		Tie Rod Axle Joint	S030342
	2009.03-2015.12	Front Axle Left	Estate 4WD CAKA/CCBA/CGWC/GX/C/CREC/CTUB		Tie Rod End	S070024
	2009.03-2015.12	Front Axle Left	Saloon 4WD CAKA/CCBA/CGWC/GX/C/CREC/CTUB		Tie Rod End	S070024
	2009.03-2015.12	Front Axle Right	Estate 4WD CAKA/CCBA/CGWC/GX/C/CREC/CTUB		Tie Rod End	S070025
	2009.03-2015.12	Front Axle Right	Saloon 4WD CAKA/CCBA/CGWC/GX/C/CREC/CTUB		Tie Rod End	S070025
	2009.03-2015.12	Front Axle Left & Right	Estate 4WD CAKA/CCBA/CGWC/GX/C/CREC/CTUB	Aluminum Material	Rod/Strut, stabiliser	S050473
	2009.03-2015.12	Front Axle Left & Right	Saloon 4WD CAKA/CCBA/CGWC/GX/C/CREC/CTUB	Aluminum Material	Rod/Strut, stabiliser	S050473
	2009.03-2015.12	Front Axle Left & Right	Estate 4WD CAKA/CCBA/CGWC/GX/C/CREC/CTUB	Engine code:CCBA,CAKA,Engine code:CGXC,CREC,CGWC,CTUB	Rod/Strut, stabiliser	S051258
	2009.03-2015.12	Front Axle Left & Right	Saloon 4WD CAKA/CCBA/CGWC/GX/C/CREC/CTUB	Engine code:CCBA,CAKA,Engine code:CGXC,CREC,CGWC,CTUB	Rod/Strut, stabiliser	S051258
	2009.03-2015.12	Rear Axle Left & Right	Estate 4WD CAKA/CCBA/CGWC/GX/C/CREC/CTUB		Rod/Strut, stabiliser	S050472
	2009.03-2015.12	Rear Axle Left & Right	Saloon 4WD CAKA/CCBA/CGWC/GX/C/CREC/CTUB		Rod/Strut, stabiliser	S050472
	2009.03-2015.12	Front Axle	Estate 4WD CAKA/CCBA/CGWC/GX/C/CREC/CTUB		Stabiliser Bushing	510138
	2009.03-2015.12	Front Axle	Saloon 4WD CAKA/CCBA/CGWC/GX/C/CREC/CTUB		Stabiliser Bushing	510138
	2009.03-2015.12	Front Axle	Estate 4WD CAKA/CCBA/CGWC/GX/C/CREC/CTUB	for PR no.:1BA	Stabiliser Bushing	532578
	2009.03-2015.12	Front Axle	Saloon 4WD CAKA/CCBA/CGWC/GX/C/CREC/CTUB		Stabiliser Bushing	532578
S5 Cabrio Quattro						
3.0 (245 kw)	2009.05-2017.01	Front Axle Left Lower Inner	Cabriolet 4WD CAKA/CCBA/CGWC/GX/C/CREC/CTDA/CTUB	Date to:2009.10;For Engine:code:CAKA/CCBA;For PR code:ABU	Track Control Arm	S060038
	2009.05-2017.01	Front Axle Left Lower Inner	Cabriolet 4WD CAKA/CCBA/CGWC/GX/C/CREC/CTDA/CTUB	Engine code:CCBA,CAKA,Date from:2009.11-2010.05	Track Control Arm	S061601
	2009.05-2017.01	Front Axle Left Lower Inner	Cabriolet 4WD CAKA/CCBA/CGWC/GX/C/CREC/CTDA/CTUB	Engine code:CCBA,CAKA,Date from:2010.05-2011.06	Track Control Arm	S062261
	2009.05-2017.01	Front Axle Left Upper Inner	Cabriolet 4WD CAKA/CCBA/CGWC/GX/C/CREC/CTDA/CTUB	Engine code:CCBA,CAKA,Date from:2011.08;Engine code:CGXC,CREC,CGWC,CTUB	Track Control Arm	S060804
	2009.05-2017.01	Front Axle Left Lower Outer	Cabriolet 4WD CAKA/CCBA/CGWC/GX/C/CREC/CTDA/CTUB	Engine code:CCBA,CAKA,Date from:2011.08;Engine code:CGXC,CREC,CGWC,CTUB	Track Control Arm	S060806
	2009.05-2017.01	Front Axle Left Upper Outer	Cabriolet 4WD CAKA/CCBA/CGWC/GX/C/CREC/CTDA/CTUB		Track Control Arm	S060802



	 YEAR	FITTING POSITION	BODY STYLE & DRIVE TYPE & ENGINE	REMARKS	PRODUCT	GSP Ref.
AUDI S5 Cabrio Quattro 3.0 (245 kw)						
	2009.05-2017.01	Front Axle Right Lower Inner	Cabriolet 4WD CAKA/CBBA/CBWC/CX/C/CREC/CTDA/CTUB	Date to:2009.10 For Enginecode:CAKA/CBBA For PR code:ARJ	Track Control Arm	S060039
	2009.05-2017.01	Front Axle Right Lower Inner	Cabriolet 4WD CAKA/CBBA/CBWC/CX/C/CREC/CTDA/CTUB	Engine code:CBBA,CAKA,Data from:so:2009.11-2010.05	Track Control Arm	S061602
	2009.05-2017.01	Front Axle Right Lower Inner	Cabriolet 4WD CAKA/CBBA/CBWC/CX/C/CREC/CTDA/CTUB	Engine code:CBBA,CAKA,Data from:so:2010.05-2011.06	Track Control Arm	S062177
	2009.05-2017.01	Front Axle Right Upper Inner	Cabriolet 4WD CAKA/CBBA/CBWC/CX/C/CREC/CTDA/CTUB	Engine code:CBBA,CAKA,Data from:so:2009.11-2010.05	Track Control Arm	S060805
	2009.05-2017.01	Front Axle Right Lower Outer	Cabriolet 4WD CAKA/CBBA/CBWC/CX/C/CREC/CTDA/CTUB	Engine code:CBBA,CAKA,Data from:so:2009.11-2010.05	Track Control Arm	S060807
	2009.05-2017.01	Front Axle Right Upper Outer	Cabriolet 4WD CAKA/CBBA/CBWC/CX/C/CREC/CTDA/CTUB	Engine code:CBBA,CAKA,Data from:so:2009.11-2010.05	Track Control Arm	S060803
	2009.05-2017.01	Rear Axle Left Upper	Cabriolet 4WD CAKA/CBBA/CBWC/CX/C/CREC/CTDA/CTUB		Track Control Arm	S061397
	2009.05-2017.01	Rear Axle Left Lower Inner	Cabriolet 4WD CAKA/CBBA/CBWC/CX/C/CREC/CTDA/CTUB		Track Control Arm	S061574
	2009.05-2017.01	Rear Axle Left Lower Outer	Cabriolet 4WD CAKA/CBBA/CBWC/CX/C/CREC/CTDA/CTUB		Track Control Arm	S062748
	2009.05-2017.01	Rear Axle Right Upper	Cabriolet 4WD CAKA/CBBA/CBWC/CX/C/CREC/CTDA/CTUB		Track Control Arm	S061398
	2009.05-2017.01	Rear Axle Right Lower Inner	Cabriolet 4WD CAKA/CBBA/CBWC/CX/C/CREC/CTDA/CTUB		Track Control Arm	S061575
	2009.05-2017.01	Rear Axle Right Lower Outer	Cabriolet 4WD CAKA/CBBA/CBWC/CX/C/CREC/CTDA/CTUB		Track Control Arm	S062749
	2009.05-2017.01	Rear Axle Left & Right Lower Inner	Cabriolet 4WD CAKA/CBBA/CBWC/CX/C/CREC/CTDA/CTUB		Track Control Arm	S062964
	2009.05-2017.01	Front Axle Left & Right Lower Outer	Cabriolet 4WD CAKA/CBBA/CBWC/CX/C/CREC/CTDA/CTUB	For Enginecode:CAKA/CBBA	Ball Joint	S080283
	2009.05-2017.01	Front Axle Left & Right Lower Outer	Cabriolet 4WD CAKA/CBBA/CBWC/CX/C/CREC/CTDA/CTUB	Engine code:CBBA,CAKA,Data from:so:2011.08 Engine code:CBBA,CAKA,Data from:so:2011.08	Ball Joint	S080987
	2009.05-2017.01	Front Axle Left & Right Upper	Cabriolet 4WD CAKA/CBBA/CBWC/CX/C/CREC/CTDA/CTUB		Control Arm Bushing	510136
	2009.05-2017.01	Front Axle Left & Right Upper	Cabriolet 4WD CAKA/CBBA/CBWC/CX/C/CREC/CTDA/CTUB		Control Arm Bushing	517974
	2009.05-2017.01	Front Axle Left & Right Lower Inner	Cabriolet 4WD CAKA/CBBA/CBWC/CX/C/CREC/CTDA/CTUB		Control Arm Bushing	530214
	2009.05-2017.01	Front Axle Left & Right Lower Inner	Cabriolet 4WD CAKA/CBBA/CBWC/CX/C/CREC/CTDA/CTUB	For Enginecode:CAKA	Control Arm Bushing	531929
	2009.05-2017.01	Front Axle Left & Right Lower Inner	Cabriolet 4WD CAKA/CBBA/CBWC/CX/C/CREC/CTDA/CTUB		Control Arm Bushing	531931
	2009.05-2017.01	Front Axle Left & Right Lower Outer	Cabriolet 4WD CAKA/CBBA/CBWC/CX/C/CREC/CTDA/CTUB	Date to:2011.08	Control Arm Bushing	510299
	2009.05-2017.01	Front Axle Left & Right Lower Outer	Cabriolet 4WD CAKA/CBBA/CBWC/CX/C/CREC/CTDA/CTUB		Control Arm Bushing	530215
	2009.05-2017.01	Rear Axle Left & Right Lower Inner	Cabriolet 4WD CAKA/CBBA/CBWC/CX/C/CREC/CTDA/CTUB		Control Arm Bushing	533477
	2009.05-2017.01	Front Axle	Cabriolet 4WD CAKA/CBBA/CBWC/CX/C/CREC/CTDA/CTUB		Suspension Repair Kit	S990011SK
	2009.05-2017.01	Front Axle	Cabriolet 4WD CAKA/CBBA/CBWC/CX/C/CREC/CTDA/CTUB	Date from:so:2009.11-2010.08 not for PR no.:1LA,1LB,1LT,1LY	Suspension Repair Kit	S990027SK
	2009.05-2017.01	Front Axle Left & Right	Cabriolet 4WD CAKA/CBBA/CBWC/CX/C/CREC/CTDA/CTUB		Tie Rod Axle Joint	S030342
	2009.05-2017.01	Front Axle Left	Cabriolet 4WD CAKA/CBBA/CBWC/CX/C/CREC/CTDA/CTUB		Tie Rod End	S070024
	2009.05-2017.01	Front Axle Right	Cabriolet 4WD CAKA/CBBA/CBWC/CX/C/CREC/CTDA/CTUB		Tie Rod End	S070025
	2009.05-2017.01	Front Axle Left & Right	Cabriolet 4WD CAKA/CBBA/CBWC/CX/C/CREC/CTDA/CTUB	Chassis no.from:8T-8-011 201	Rod/Strut, stabiliser	S050473
	2009.05-2017.01	Front Axle Left & Right	Cabriolet 4WD CAKA/CBBA/CBWC/CX/C/CREC/CTDA/CTUB	Engine code:CBBA,CAKA,Engine code:CGXC,CTUB,CTDA,CREC,CGRC	Rod/Strut, stabiliser	S051258
	2009.05-2017.01	Rear Axle Left & Right	Cabriolet 4WD CAKA/CBBA/CBWC/CX/C/CREC/CTDA/CTUB		Rod/Strut, stabiliser	S050472
	2009.05-2017.01	Front Axle	Cabriolet 4WD CAKA/CBBA/CBWC/CX/C/CREC/CTDA/CTUB		Stabiliser Bushing	510138
	2009.05-2017.01	Front Axle	Cabriolet 4WD CAKA/CBBA/CBWC/CX/C/CREC/CTDA/CTUB		Stabiliser Bushing	532578
S5 Quattro 3.0 (245 kw)						
	2011.09-2017.01	Front Axle Left Lower Inner	Coupe 4WD CAKA/CGWC/CGXC/CREC/CTDA/CTUB		Track Control Arm	S062261
	2011.09-2017.01	Front Axle Left Upper Inner	Coupe 4WD CAKA/CGWC/CGXC/CREC/CTDA/CTUB		Track Control Arm	S060804
	2011.09-2017.01	Front Axle Left Upper Outer	Coupe 4WD CAKA/CGWC/CGXC/CREC/CTDA/CTUB		Track Control Arm	S060802
	2011.09-2017.01	Front Axle Right Lower Inner	Coupe 4WD CAKA/CGWC/CGXC/CREC/CTDA/CTUB		Track Control Arm	S062177
	2011.09-2017.01	Front Axle Right Upper Inner	Coupe 4WD CAKA/CGWC/CGXC/CREC/CTDA/CTUB		Track Control Arm	S060805
	2011.09-2017.01	Front Axle Right Lower Outer	Coupe 4WD CAKA/CGWC/CGXC/CREC/CTDA/CTUB		Track Control Arm	S060807
	2011.09-2017.01	Front Axle Right Upper Outer	Coupe 4WD CAKA/CGWC/CGXC/CREC/CTDA/CTUB		Track Control Arm	S060803
	2011.09-2017.01	Rear Axle Left Upper	Coupe 4WD CAKA/CGWC/CGXC/CREC/CTDA/CTUB		Track Control Arm	S061397
	2011.09-2017.01	Rear Axle Left Lower Outer	Coupe 4WD CAKA/CGWC/CGXC/CREC/CTDA/CTUB		Track Control Arm	S062748
	2011.09-2017.01	Rear Axle Right Upper	Coupe 4WD CAKA/CGWC/CGXC/CREC/CTDA/CTUB		Track Control Arm	S061398
	2011.09-2017.01	Rear Axle Right Lower Outer	Coupe 4WD CAKA/CGWC/CGXC/CREC/CTDA/CTUB		Track Control Arm	S062749
	2011.09-2017.01	Rear Axle Left & Right Lower Inner	Coupe 4WD CAKA/CGWC/CGXC/CREC/CTDA/CTUB		Track Control Arm	S062964
	2011.09-2017.01	Front Axle Left & Right Lower Outer	Coupe 4WD CAKA/CGWC/CGXC/CREC/CTDA/CTUB	For Enginecode:CAKA	Ball Joint	S080283
	2011.09-2017.01	Front Axle Left & Right Lower Outer	Coupe 4WD CAKA/CGWC/CGXC/CREC/CTDA/CTUB		Ball Joint	S080987
	2011.09-2017.01	Front Axle Left & Right Upper	Coupe 4WD CAKA/CGWC/CGXC/CREC/CTDA/CTUB		Control Arm Bushing	510136
	2011.09-2017.01	Front Axle Left & Right Lower Inner	Coupe 4WD CAKA/CGWC/CGXC/CREC/CTDA/CTUB	For Enginecode:CAKA	Control Arm Bushing	530214
	2011.09-2017.01	Front Axle Left & Right Lower Inner	Coupe 4WD CAKA/CGWC/CGXC/CREC/CTDA/CTUB		Control Arm Bushing	531929
	2011.09-2017.01	Front Axle Left & Right Lower Inner	Coupe 4WD CAKA/CGWC/CGXC/CREC/CTDA/CTUB		Control Arm Bushing	531931
	2011.09-2017.01	Front Axle Left & Right Lower Outer	Coupe 4WD CAKA/CGWC/CGXC/CREC/CTDA/CTUB		Control Arm Bushing	510299
	2011.09-2017.01	Front Axle Left & Right Lower Outer	Coupe 4WD CAKA/CGWC/CGXC/CREC/CTDA/CTUB		Control Arm Bushing	530215
	2011.09-2017.01	Rear Axle Left & Right Lower Inner	Coupe 4WD CAKA/CGWC/CGXC/CREC/CTDA/CTUB		Control Arm Bushing	533477
	2011.09-2017.01	Front Axle Left & Right	Coupe 4WD CAKA/CGWC/CGXC/CREC/CTDA/CTUB		Tie Rod Axle Joint	S030342
	2011.09-2017.01	Front Axle Left	Coupe 4WD CAKA/CGWC/CGXC/CREC/CTDA/CTUB		Tie Rod End	S070024
	2011.09-2017.01	Front Axle Right	Coupe 4WD CAKA/CGWC/CGXC/CREC/CTDA/CTUB		Tie Rod End	S070025
	2011.09-2017.01	Front Axle Left & Right	Coupe 4WD CAKA/CGWC/CGXC/CREC/CTDA/CTUB	Chassis no.from:8T-8-011 201	Rod/Strut, stabiliser	S050473
	2011.09-2017.01	Front Axle Left & Right	Coupe 4WD CAKA/CGWC/CGXC/CREC/CTDA/CTUB	not For PR no.:X4M/X5F	Rod/Strut, stabiliser	S051258
	2011.09-2017.01	Rear Axle Left & Right	Coupe 4WD CAKA/CGWC/CGXC/CREC/CTDA/CTUB		Rod/Strut, stabiliser	S050472
	2011.09-2017.01	Front Axle	Coupe 4WD CAKA/CGWC/CGXC/CREC/CTDA/CTUB		Stabiliser Bushing	510138
	2011.09-2017.01	Front Axle	Coupe 4WD CAKA/CGWC/CGXC/CREC/CTDA/CTUB	Engine Code:CAKA For PR no.:X4M/X5F Engine Code:CGXC,CTUB,CTDA,CREC,CGRC	Stabiliser Bushing	532578



	 YEAR	FITTING POSITION	BODY STYLE & DRIVE TYPE & ENGINE	REMARKS	PRODUCT	GSP Ref.
AUDI						
S5 Sportback Quattro						
3.0 (245 kw)	2010.01-2017.01	Front Axle Left Lower Inner	Hatchback 4WD CAKA/CGWC/CREC/CTDA	Engine code:CAKA,Date to:2011.06	Track Control Arm	S061601
	2010.01-2017.01	Front Axle Left Lower Inner	Hatchback 4WD CAKA/CGWC/CREC/CTDA	Engine code:CAKA,Date to:2011.06,From:2010.08,PR no.:1L7L5M1U	Track Control Arm	S062261
	2010.01-2017.01	Front Axle Left Upper Inner	Hatchback 4WD CAKA/CGWC/CREC/CTDA		Track Control Arm	S060804
	2010.01-2017.01	Front Axle Left Lower Outer	Hatchback 4WD CAKA/CGWC/CREC/CTDA	Engine code:CAKA,Date from:2011.08,Engine code:CGWC/CTDA/CREC	Track Control Arm	S060806
	2010.01-2017.01	Front Axle Left Upper Outer	Hatchback 4WD CAKA/CGWC/CREC/CTDA		Track Control Arm	S060802
	2010.01-2017.01	Front Axle Right Lower Inner	Hatchback 4WD CAKA/CGWC/CREC/CTDA	Engine code:CAKA,Date to:2011.06	Track Control Arm	S061602
	2010.01-2017.01	Front Axle Right Lower Inner	Hatchback 4WD CAKA/CGWC/CREC/CTDA	Engine code:CAKA,Date to:2011.06,From:2010.08,PR no.:1L7L5M1U	Track Control Arm	S062177
	2010.01-2017.01	Front Axle Right Upper Inner	Hatchback 4WD CAKA/CGWC/CREC/CTDA		Track Control Arm	S060805
	2010.01-2017.01	Front Axle Right Lower Outer	Hatchback 4WD CAKA/CGWC/CREC/CTDA	Engine code:CAKA,Date from:2011.08,Engine code:CGWC/CTDA/CREC	Track Control Arm	S060807
	2010.01-2017.01	Front Axle Right Upper Outer	Hatchback 4WD CAKA/CGWC/CREC/CTDA		Track Control Arm	S060803
	2010.01-2017.01	Rear Axle Left Upper	Hatchback 4WD CAKA/CGWC/CREC/CTDA		Track Control Arm	S061397
	2010.01-2017.01	Rear Axle Left Lower Outer	Hatchback 4WD CAKA/CGWC/CREC/CTDA		Track Control Arm	S062748
	2010.01-2017.01	Rear Axle Right Upper	Hatchback 4WD CAKA/CGWC/CREC/CTDA		Track Control Arm	S061398
	2010.01-2017.01	Rear Axle Right Lower Outer	Hatchback 4WD CAKA/CGWC/CREC/CTDA		Track Control Arm	S062749
	2010.01-2017.01	Rear Axle Left & Right Lower Inner	Hatchback 4WD CAKA/CGWC/CREC/CTDA		Track Control Arm	S062964
	2010.01-2017.01	Front Axle Left & Right Lower Outer	Hatchback 4WD CAKA/CGWC/CREC/CTDA	For Enginecode:CAKA	Ball Joint	S080283
	2010.01-2017.01	Front Axle Left & Right Lower Outer	Hatchback 4WD CAKA/CGWC/CREC/CTDA	Engine code:CAKA,Date from:2011.08,Engine code:CGWC/CTDA/CREC	Ball Joint	S080987
	2010.01-2017.01	Front Axle Left & Right Upper	Hatchback 4WD CAKA/CGWC/CREC/CTDA		Control Arm Bushing	510136
	2010.01-2017.01	Front Axle Left & Right Lower Inner	Hatchback 4WD CAKA/CGWC/CREC/CTDA		Control Arm Bushing	530214
	2010.01-2017.01	Front Axle Left & Right Lower Inner	Hatchback 4WD CAKA/CGWC/CREC/CTDA	For Enginecode:CAKA	Control Arm Bushing	531929
	2010.01-2017.01	Front Axle Left & Right Lower Inner	Hatchback 4WD CAKA/CGWC/CREC/CTDA		Control Arm Bushing	531931
	2010.01-2017.01	Front Axle Left & Right Lower Outer	Hatchback 4WD CAKA/CGWC/CREC/CTDA	Date to:2011.08	Control Arm Bushing	510299
	2010.01-2017.01	Front Axle Left & Right Lower Outer	Hatchback 4WD CAKA/CGWC/CREC/CTDA		Control Arm Bushing	530215
	2010.01-2017.01	Rear Axle Left & Right Lower Inner	Hatchback 4WD CAKA/CGWC/CREC/CTDA		Control Arm Bushing	533477
	2010.01-2017.01	Front Axle Left & Right	Hatchback 4WD CAKA/CGWC/CREC/CTDA		Tie Rod Axle Joint	S030342
	2010.01-2017.01	Front Axle Left	Hatchback 4WD CAKA/CGWC/CREC/CTDA		Tie Rod End	S070024
	2010.01-2017.01	Front Axle Right	Hatchback 4WD CAKA/CGWC/CREC/CTDA		Tie Rod End	S070025
	2010.01-2017.01	Front Axle Left & Right	Hatchback 4WD CAKA/CGWC/CREC/CTDA	Chassis no.from:8T-8-011 201	Rod/Strut,stabiliser	S050473
	2010.01-2017.01	Front Axle Left & Right	Hatchback 4WD CAKA/CGWC/CREC/CTDA	not For PR no.:X4M/X5F	Rod/Strut,stabiliser	S051258
	2010.01-2017.01	Rear Axle Left & Right	Hatchback 4WD CAKA/CGWC/CREC/CTDA		Rod/Strut,stabiliser	S050472
	2010.01-2017.01	Front Axle	Hatchback 4WD CAKA/CGWC/CREC/CTDA		Stabiliser Bushing	510138
	2010.01-2017.01	Front Axle	Hatchback 4WD CAKA/CGWC/CREC/CTDA	Engine code:CAKA,PR no.:18A1988 98,HSR,Engine code:CGWC/CTDA/CREC	Stabiliser Bushing	532578
S6 Quattro						
2.2 (169 kw)	1994.06-1997.07	Front Axle Left Lower	Estate 4WD AAN		Track Control Arm	S060040
	1994.06-1997.07	Front Axle Right Lower	Estate 4WD AAN		Track Control Arm	S060041
	1994.06-1997.07	Rear Axle Left Upper	Estate 4WD AAN		Track Control Arm	S060036
	1994.06-1997.07	Rear Axle Right Upper	Estate 4WD AAN		Track Control Arm	S060037
	1994.06-1997.07	Front Axle Left & Right Lower	Estate 4WD AAN	Quantity:2	Control Arm Bushing	510126
	1994.06-1997.07	Front Axle Left & Right Lower	Estate 4WD AAN		Control Arm Bushing	510127
	1994.06-1997.07	Rear Axle Left & Right	Estate 4WD AAN		Control Arm Bushing	530206
	1994.06-1997.07	Rear Axle Left & Right Lower	Estate 4WD AAN		Control Arm Bushing	510132
	1994.06-1997.07	Rear Axle Left & Right Lower	Estate 4WD AAN		Control Arm Bushing	530207
	1994.06-1997.07	Front Axle Left	Estate 4WD AAN		Tie Rod End	S070022
	1994.06-1997.07	Front Axle Right	Estate 4WD AAN		Tie Rod End	S070023
	1994.06-1997.07	Front Axle	Estate 4WD AAN		Stabiliser Bushing	510128
	1994.06-1997.07	Front Axle	Estate 4WD AAN	Stabiliser Ø:27 mm	Stabiliser Bushing	510139
	1994.06-1997.07	Front Axle	Estate 4WD AAN		Sleeve,control arm mounting	530196
4.2 (213 kw)	1994.09-1997.10	Front Axle Left Lower	Estate 4WD AEC		Track Control Arm	S060040
	1994.09-1997.10	Front Axle Right Lower	Estate 4WD AEC		Track Control Arm	S060041
	1994.09-1997.10	Rear Axle Left Upper	Estate 4WD AEC		Track Control Arm	S060036
	1994.09-1997.10	Rear Axle Right Upper	Estate 4WD AEC		Track Control Arm	S060037
	1994.09-1997.10	Front Axle Left & Right Lower	Estate 4WD AEC	Quantity:2	Control Arm Bushing	510126
	1994.09-1997.10	Front Axle Left & Right Lower	Estate 4WD AEC		Control Arm Bushing	510127
	1994.09-1997.10	Rear Axle Left & Right	Estate 4WD AEC		Control Arm Bushing	530206
	1994.09-1997.10	Rear Axle Left & Right Lower	Estate 4WD AEC		Control Arm Bushing	510132
	1994.09-1997.10	Rear Axle Left & Right Lower	Estate 4WD AEC		Control Arm Bushing	530207
	1994.09-1997.10	Front Axle Left	Estate 4WD AEC		Tie Rod End	S070022
	1994.09-1997.10	Front Axle Right	Estate 4WD AEC		Tie Rod End	S070023
	1994.09-1997.10	Front Axle	Estate 4WD AEC		Stabiliser Bushing	510128
	1994.09-1997.10	Front Axle	Estate 4WD AEC	Stabiliser Ø:27 mm	Stabiliser Bushing	510139
	1994.09-1997.10	Front Axle	Estate 4WD AEC		Sleeve,control arm mounting	530196
5.2 (320 kw)	2006.06-2011.03	Front Axle Left Lower Inner	Saloon 4WD BXA		Track Control Arm	S060029
	2006.06-2011.03	Front Axle Left Upper Inner	Saloon 4WD BXA		Track Control Arm	S060050
	2006.06-2011.03	Front Axle Left Upper Outer	Saloon 4WD BXA		Track Control Arm	S060052



	 YEAR	FITTING POSITION	BODY STYLE & DRIVE TYPE & ENGINE	REMARKS	PRODUCT	GSP Ref.
AUDI S6 Quattro						
5.2 (320 kw)	2006.06-2011.03	Front Axle Right Lower Inner	Saloon 4WD BXA		Track Control Arm	S060030
	2006.06-2011.03	Front Axle Right Upper Inner	Saloon 4WD BXA		Track Control Arm	S060051
	2006.06-2011.03	Front Axle Right Upper Outer	Saloon 4WD BXA		Track Control Arm	S060053
	2006.06-2011.03	Front Axle Left & Right Lower Outer	Saloon 4WD BXA		Track Control Arm	S060028
	2006.06-2011.03	Rear Axle Left & Right Lower Outer	Saloon 4WD BXA		Track Control Arm	S061506
	2006.06-2011.03	Front Axle Left & Right Lower	Saloon 4WD BXA		Control Arm Bushing	510288
	2006.06-2011.03	Front Axle Left & Right Upper	Saloon 4WD BXA		Control Arm Bushing	510136
	2006.06-2011.03	Front Axle Left & Right Lower Inner	Saloon 4WD BXA		Control Arm Bushing	510301
	2006.06-2011.03	Front Axle Left & Right Lower Outer	Saloon 4WD BXA		Control Arm Bushing	510299
	2006.06-2011.03	Front Axle Left & Right Lower Outer	Saloon 4WD BXA		Control Arm Bushing	531954
	2006.06-2011.03	Rear Axle Left & Right Lower Outer	Saloon 4WD BXA		Control Arm Bushing	510393
	2006.06-2011.03	Rear Axle Left & Right Lower Outer	Saloon 4WD BXA		Control Arm Bushing	510394
	2006.06-2011.03	Front Axle	Saloon 4WD BXA		Suspension Repair Kit	S990014SK
	2006.06-2011.03	Front Axle Left & Right	Saloon 4WD BXA		Tie Rod Axle Joint	S030341
	2006.06-2011.03	Front Axle Left & Right	Saloon 4WD BXA		Tie Rod End	S070016
	2006.06-2011.03	Front Axle Left & Right	Saloon 4WD BXA		Rod/Strut, stabiliser	S050022
	2006.06-2011.03	Rear Axle Left & Right	Saloon 4WD BXA		Rod/Strut, stabiliser	S050025
	2006.06-2011.03	Rear Axle Left & Right	Saloon 4WD BXA	Chassis no.to:4B-5-050 000	Rod/Strut, stabiliser	S070017
	2006.06-2011.03	Front Axle	Saloon 4WD BXA	Stabiliser Ø:27 mm	Stabiliser Bushing	510139
	2006.06-2011.03	Front Axle	Saloon 4WD BXA		Stabiliser Bushing	517806
S7 Sportback Quattro						
4.0 (331 kw)	2014.07-2018.05	Rear Axle Left Upper	Hatchback 4WD CTGE		Track Control Arm	S061397
	2014.07-2018.05	Rear Axle Left Lower Inner	Hatchback 4WD CTGE		Track Control Arm	S061574
	2014.07-2018.05	Rear Axle Right Upper	Hatchback 4WD CTGE		Track Control Arm	S061398
	2014.07-2018.05	Rear Axle Right Lower Inner	Hatchback 4WD CTGE		Track Control Arm	S061575
	2014.07-2018.05	Rear Axle Left & Right Lower Inner	Hatchback 4WD CTGE		Track Control Arm	S062964
	2014.07-2018.05	Front Axle Left & Right Lower Outer	Hatchback 4WD CTGE		Ball Joint	S080987
	2014.07-2018.05	Front Axle Left & Right Upper	Hatchback 4WD CTGE		Control Arm Bushing	519053
	2014.07-2018.05	Front Axle Left & Right Lower Inner	Hatchback 4WD CTGE		Control Arm Bushing	531929
	2014.07-2018.05	Front Axle Left & Right Lower Outer	Hatchback 4WD CTGE		Control Arm Bushing	510299
	2014.07-2018.05	Front Axle Left & Right Lower Outer	Hatchback 4WD CTGE		Control Arm Bushing	530215
	2014.07-2018.05	Rear Axle Left & Right Lower Inner	Hatchback 4WD CTGE		Control Arm Bushing	533477
	2014.07-2018.05	Front Axle Left & Right	Hatchback 4WD CTGE		Tie Rod Axle Joint	S030654
	2014.07-2018.05	Front Axle Left	Hatchback 4WD CTGE		Tie Rod End	S070024
	2014.07-2018.05	Front Axle Right	Hatchback 4WD CTGE		Tie Rod End	S070025
	2014.07-2018.05	Front Axle Left & Right	Hatchback 4WD CTGE	Date to:2014.10,for PR no.:1BK/1BS	Rod/Strut, stabiliser	S050473
	2014.07-2018.05	Front Axle Left & Right	Hatchback 4WD CTGE	For PR no.:1BA/1BB/1BE/1BV	Rod/Strut, stabiliser	S051258
	2014.07-2018.05	Rear Axle Left & Right	Hatchback 4WD CTGE		Rod/Strut, stabiliser	S050472
	2014.07-2018.05	Front Axle	Hatchback 4WD CTGE		Stabiliser Bushing	510138
	2014.07-2018.05	Front Axle	Hatchback 4WD CTGE	for vehicles with heavy duty suspension,for PR no.:1BB	Stabiliser Bushing	532578
	2014.07-2018.05	Front Axle	Hatchback 4WD CTGE		Stabiliser Bushing	532579
S8 Plus Quattro						
4.0 (445 kw)	2015.11-2018.01	Front Axle Left Lower Inner	Saloon 4WD DDTA		Track Control Arm	S062026
	2015.11-2018.01	Front Axle Left Upper Inner	Saloon 4WD DDTA		Track Control Arm	S062030
	2015.11-2018.01	Front Axle Left Lower Outer	Saloon 4WD DDTA		Track Control Arm	S062024
	2015.11-2018.01	Front Axle Left Upper Outer	Saloon 4WD DDTA		Track Control Arm	S062028
	2015.11-2018.01	Front Axle Right Lower Inner	Saloon 4WD DDTA		Track Control Arm	S062027
	2015.11-2018.01	Front Axle Right Upper Inner	Saloon 4WD DDTA		Track Control Arm	S062031
	2015.11-2018.01	Front Axle Right Lower Outer	Saloon 4WD DDTA		Track Control Arm	S062025
	2015.11-2018.01	Front Axle Right Upper Outer	Saloon 4WD DDTA		Track Control Arm	S062029
	2015.11-2018.01	Rear Axle Left Upper	Saloon 4WD DDTA		Track Control Arm	S061397
	2015.11-2018.01	Rear Axle Right Upper	Saloon 4WD DDTA		Track Control Arm	S061398
	2015.11-2018.01	Rear Axle Left & Right Lower Inner	Saloon 4WD DDTA		Track Control Arm	S062964
	2015.11-2018.01	Front Axle Left & Right Upper	Saloon 4WD DDTA		Control Arm Bushing	519053
	2015.11-2018.01	Front Axle Left & Right Lower Inner	Saloon 4WD DDTA		Control Arm Bushing	531929
	2015.11-2018.01	Front Axle Left & Right Lower Outer	Saloon 4WD DDTA		Control Arm Bushing	510299
	2015.11-2018.01	Front Axle Left & Right Lower Outer	Saloon 4WD DDTA		Control Arm Bushing	531930
	2015.11-2018.01	Rear Axle Left & Right Lower Inner	Saloon 4WD DDTA		Control Arm Bushing	533477
	2015.11-2018.01	Front Axle Left & Right	Saloon 4WD DDTA	For Vehicles Without Electric Power Steering For PR no.:1N3117	Tie Rod Axle Joint	S030342
	2015.11-2018.01	Front Axle Left & Right	Saloon 4WD DDTA		Tie Rod Axle Joint	S030654
	2015.11-2018.01	Front Axle Left & Right	Saloon 4WD DDTA		Rod/Strut, stabiliser	S050473
	2015.11-2018.01	Front Axle Left & Right	Saloon 4WD DDTA	Plastic Material	Rod/Strut, stabiliser	S051258
	2015.11-2018.01	Rear Axle Left & Right	Saloon 4WD DDTA		Rod/Strut, stabiliser	S050472
	2015.11-2018.01	Front Axle	Saloon 4WD DDTA	for PR no.:2MA/2MB	Stabiliser Bushing	510139



	 YEAR	FITTING POSITION	BODY STYLE & DRIVE TYPE & ENGINE	REMARKS	PRODUCT	GSP Ref.
AUDI						
S8 Plus Quattro						
4.0 (445 kw)	2015.11-2018.01	Front Axle	Saloon 4WD DDTA		Stabiliser Bushing	517806
	2015.11-2018.01	Front Axle	Saloon 4WD DDTA		Stabiliser Bushing	532579
	2015.11-2018.01	Front Axle	Saloon 4WD DDTA	for PR no.:2MA	Stabiliser Bushing	533395
	2015.11-2018.01	Rear Axle	Saloon 4WD DDTA		Stabiliser Bushing	516447
S8 Quattro						
4.2 (250 kw)	1996.09-1998.12	Front Axle Left Lower Inner	Saloon 4WD AHC/AKH		Track Control Arm	S060055
	1996.09-1998.12	Front Axle Right Lower Inner	Saloon 4WD AHC/AKH		Track Control Arm	S060056
	1996.09-1998.12	Front Axle Left & Right Lower Outer	Saloon 4WD AHC/AKH		Track Control Arm	S060054
	1996.09-1998.12	Rear Axle Left & Right	Saloon 4WD AHC/AKH		Track Control Arm	S050044
	1996.09-1998.12	Front Axle Left & Right Lower Inner	Saloon 4WD AHC/AKH		Control Arm Bushing	510287
	1996.09-1998.12	Front Axle Left & Right Lower Outer	Saloon 4WD AHC/AKH		Control Arm Bushing	510133
	1996.09-1998.12	Front Axle Left & Right Lower Outer	Saloon 4WD AHC/AKH		Control Arm Bushing	510134
	1996.09-1998.12	Front Axle Left & Right Upper Outer	Saloon 4WD AHC/AKH		Control Arm Bushing	510137
	1996.09-1998.12	Front Axle Left & Right	Saloon 4WD AHC/AKH		Tie Rod End	S070038
	1996.09-1998.12	Front Axle Left & Right	Saloon 4WD AHC/AKH		Rod/Strut,stabiliser	520526
	1996.09-1998.12	Rear Axle Left	Saloon 4WD AHC/AKH		Rod/Strut,stabiliser	S050023
	1996.09-1998.12	Rear Axle Right	Saloon 4WD AHC/AKH		Rod/Strut,stabiliser	S050024
	1996.09-1998.12	Rear Axle Left & Right	Saloon 4WD AHC/AKH		Rod/Strut,stabiliser	S050317
	1996.09-1998.12	Front Axle	Saloon 4WD AHC/AKH	for vehicles without sports suspension	Stabiliser Bushing	510138
	1996.09-1998.12	Front Axle	Saloon 4WD AHC/AKH		Stabiliser Bushing	510139
	1996.09-1998.12	Front Axle Left	Saloon 4WD AHC/AKH		Steering Boot	540043
5.2 (331 kw)	2006.06-2010.07	Front Axle Left Upper Inner	Saloon 4WD BSM		Track Control Arm	S060050
	2006.06-2010.07	Front Axle Left Upper Outer	Saloon 4WD BSM		Track Control Arm	S060052
	2006.06-2010.07	Front Axle Right Upper Inner	Saloon 4WD BSM		Track Control Arm	S060051
	2006.06-2010.07	Front Axle Right Upper Outer	Saloon 4WD BSM		Track Control Arm	S060053
	2006.06-2010.07	Front Axle Left & Right Lower Inner	Saloon 4WD BSM		Track Control Arm	S060031
	2006.06-2010.07	Front Axle Left & Right Upper	Saloon 4WD BSM		Control Arm Bushing	510136
	2006.06-2010.07	Front Axle Left & Right Lower Inner	Saloon 4WD BSM		Control Arm Bushing	510287
	2006.06-2010.07	Front Axle Left & Right Lower Outer	Saloon 4WD BSM		Control Arm Bushing	510299
	2006.06-2010.07	Front Axle Left & Right Outer	Saloon 4WD BSM		Control Arm Bushing	531954
	2006.06-2010.07	Front Axle Left & Right	Saloon 4WD BSM		Rod Assembly	S100005
	2006.06-2010.07	Front Axle Left & Right	Saloon 4WD BSM		Rod/Strut,stabiliser	S050022
	2006.06-2010.07	Rear Axle Left	Saloon 4WD BSM	For PR no.:F0A/F4F/F5B	Rod/Strut,stabiliser	S050023
	2006.06-2010.07	Rear Axle Left	Saloon 4WD BSM		Rod/Strut,stabiliser	S050023
	2006.06-2010.07	Rear Axle Right	Saloon 4WD BSM	For PR no.:F0A/F4F/F5B	Rod/Strut,stabiliser	S050024
	2006.06-2010.07	Rear Axle Right	Saloon 4WD BSM		Rod/Strut,stabiliser	S050024
	2006.06-2010.07	Rear Axle Left & Right	Saloon 4WD BSM		Rod/Strut,stabiliser	S050471
	2006.06-2010.07	Front Axle	Saloon 4WD BSM	Stabiliser Ø:25 mm	Stabiliser Bushing	510138
	2006.06-2010.07	Front Axle	Saloon 4WD BSM	Stabiliser Ø:27 mm	Stabiliser Bushing	510139
SQ5 Quattro						
3.0 (260 kw)	2013.05-2017.05	Front Axle Left Upper Inner	SUV 4WD CTUD/CTXA		Track Control Arm	S060804
	2013.05-2017.05	Front Axle Left Upper Outer	SUV 4WD CTUD/CTXA		Track Control Arm	S060802
	2013.05-2017.05	Front Axle Right Upper Inner	SUV 4WD CTUD/CTXA		Track Control Arm	S060805
	2013.05-2017.05	Front Axle Right Upper Outer	SUV 4WD CTUD/CTXA		Track Control Arm	S060803
	2013.05-2017.05	Rear Axle Left Upper	SUV 4WD CTUD/CTXA		Track Control Arm	S061397
	2013.05-2017.05	Rear Axle Right Upper	SUV 4WD CTUD/CTXA		Track Control Arm	S061398
	2013.05-2017.05	Rear Axle Left & Right Lower Inner	SUV 4WD CTUD/CTXA		Track Control Arm	S062964
	2013.05-2017.05	Front Axle Left & Right Lower Outer	SUV 4WD CTUD/CTXA		Ball Joint	S080987
	2013.05-2017.05	Front Axle Left & Right Upper	SUV 4WD CTUD/CTXA		Control Arm Bushing	510136
	2013.05-2017.05	Front Axle Left & Right Lower Inner	SUV 4WD CTUD/CTXA		Control Arm Bushing	531931
	2013.05-2017.05	Front Axle Left & Right Lower Outer	SUV 4WD CTUD/CTXA		Control Arm Bushing	510299
	2013.05-2017.05	Front Axle Left & Right Lower Outer	SUV 4WD CTUD/CTXA		Control Arm Bushing	530215
	2013.05-2017.05	Rear Axle Left & Right Lower Inner	SUV 4WD CTUD/CTXA		Control Arm Bushing	533477
	2013.05-2017.05	Front Axle Left & Right	SUV 4WD CTUD/CTXA	For Vehicles Without Electric Power Steering For PR no.:1N11N2107	Tie Rod Axle Joint	S030342
	2013.05-2017.05	Front Axle Left & Right	SUV 4WD CTUD/CTXA		Tie Rod Axle Joint	S030654
	2013.05-2017.05	Front Axle Left	SUV 4WD CTUD/CTXA		Tie Rod End	S070024
	2013.05-2017.05	Front Axle Right	SUV 4WD CTUD/CTXA		Tie Rod End	S070025
	2013.05-2017.05	Front Axle Left & Right	SUV 4WD CTUD/CTXA	Aluminum Material	Rod/Strut,stabiliser	S050473
	2013.05-2017.05	Front Axle Left & Right	SUV 4WD CTUD/CTXA	not For PR no.:X4M/X5F	Rod/Strut,stabiliser	S051258
	2013.05-2017.05	Rear Axle Left & Right	SUV 4WD CTUD/CTXA		Rod/Strut,stabiliser	S050472
	2013.05-2017.05	Front Axle	SUV 4WD CTUD/CTXA		Stabiliser Bushing	510139
	2013.05-2017.05	Front Axle	SUV 4WD CTUD/CTXA	for manufacturer Geac/Thames 5-10 used by PR no.:S24/S25/S26/S27/S28	Stabiliser Bushing	533395
	2016.11-	Front Axle Left Upper Inner	SUV 4WD CWGD		Track Control Arm	S062934
	2016.11-	Front Axle Left Upper Outer	SUV 4WD CWGD		Track Control Arm	S062932



	 YEAR	FITTING POSITION	BODY STYLE & DRIVE TYPE & ENGINE	REMARKS	PRODUCT	GSP Ref.
AUDI SQ5 Quattro						
3.0 (260 kw)	2016.11-	Front Axle Right Upper Inner	SUV 4WD CWGD		Track Control Arm	S062935
	2016.11-	Front Axle Right Upper Outer	SUV 4WD CWGD		Track Control Arm	S062933
	2016.11-	Front Axle Left & Right Upper	SUV 4WD CWGD		Control Arm Bushing	533901
	2016.11-	Front Axle Left & Right Lower Outer	SUV 4WD CWGD		Control Arm Bushing	510299
	2016.11-	Front Axle Left	SUV 4WD CWGD		Tie Rod End	S071632
	2016.11-	Front Axle Right	SUV 4WD CWGD		Tie Rod End	S071634
	2016.11-	Front Axle Left & Right	SUV 4WD CWGD		Rod/Strut,stabiliser	S050473
	2016.11-	Front Axle Left & Right	SUV 4WD CWGD	Plastic Material	Rod/Strut,stabiliser	S051258
	2016.11-	Rear Axle Left & Right	SUV 4WD CWGD		Rod/Strut,stabiliser	S051433
TT						
1.8 (132 kw)	1998.10-2006.06	Front Axle Left Lower	Coupe FWD AJQ/APP/ATC/AUQ		Track Control Arm	S060337
	1998.10-2006.06	Front Axle Right Lower	Coupe FWD AJQ/APP/ATC/AUQ		Track Control Arm	S060338
	1998.10-2006.06	Front Axle Left & Right Lower	Coupe FWD AJQ/APP/ATC/AUQ		Ball Joint	S080357
	1998.10-2006.06	Front Axle Left & Right Lower	Coupe FWD AJQ/APP/ATC/AUQ		Control Arm Bushing	510065
	1998.10-2006.06	Front Axle Left & Right Lower	Coupe FWD AJQ/APP/ATC/AUQ	Engine Code:AJQ,ATC,APP,Chassis no.to:8N-Y-060 000	Control Arm Bushing	510084
	1998.10-2006.06	Front Axle Left & Right Lower	Coupe FWD AJQ/APP/ATC/AUQ		Control Arm Bushing	518115
	1998.10-2006.06	Front Axle Left & Right Lower	Coupe FWD AJQ/APP/ATC/AUQ		Control Arm Bushing	535313
	1998.10-2006.06	Front Axle	Coupe FWD AJQ/APP/ATC/AUQ		Suspension Repair Kit	S990026SK
	1998.10-2006.06	Front Axle Left	Coupe FWD AJQ/APP/ATC/AUQ		Rod Assembly	S100004
	1998.10-2006.06	Front Axle Right	Coupe FWD AJQ/APP/ATC/AUQ		Rod Assembly	S100003
	1998.10-2006.06	Front Axle Left & Right	Coupe FWD AJQ/APP/ATC/AUQ		Tie Rod Axle Joint	S030425
	1998.10-2006.06	Front Axle Left	Coupe FWD AJQ/APP/ATC/AUQ		Tie Rod End	S070035
	1998.10-2006.06	Front Axle Right	Coupe FWD AJQ/APP/ATC/AUQ		Tie Rod End	S070034
	1998.10-2006.06	Front Axle Left	Coupe FWD AJQ/APP/ATC/AUQ		Rod/Strut,stabiliser	S050043
	1998.10-2006.06	Front Axle Right	Coupe FWD AJQ/APP/ATC/AUQ		Rod/Strut,stabiliser	S050036
	1998.10-2006.06	Rear Axle Left & Right	Coupe FWD AJQ/APP/ATC/AUQ	Engine code:ATC,for vehicles with off-board suspension	Rod/Strut,stabiliser	S050021
	1998.10-2006.06	Rear Axle Left & Right	Coupe FWD AJQ/APP/ATC/AUQ	for vehicles without heavy duty suspension	Rod/Strut,stabiliser	S050048
	1998.10-2006.06	Front Axle	Coupe FWD AJQ/APP/ATC/AUQ	Chassis no. from:8N-Y-060 001	Stabiliser Bushing	510066
	1998.10-2006.06	Front Axle	Coupe FWD AJQ/APP/ATC/AUQ	for OE No.1J0 411 305 AA,Stabiliser Ø:19 mm	Stabiliser Bushing	510232
	1998.10-2006.06	Front Axle	Coupe FWD AJQ/APP/ATC/AUQ	for OE No.1J0 411 305 AD,Stabiliser Ø:19 mm	Stabiliser Bushing	517166
	1998.10-2006.06	Front Axle	Coupe FWD AJQ/APP/ATC/AUQ		Stabiliser Bushing Kit	510066S
2.0 (169 kw)	2014.07-	Rear Axle Left & Right Lower Inner	Coupe FWD CHHC		Track Control Arm	S062791
	2014.07-	Rear Axle Left & Right Lower Outer	Coupe FWD CHHC		Track Control Arm	S062899
	2014.07-	Front Axle Left & Right Lower	Coupe FWD CHHC		Control Arm Bushing	510361
	2014.07-	Rear Axle Left & Right Centre	Coupe FWD CHHC		Control Arm Bushing	512203
	2014.07-	Rear Axle Left & Right Lower Inner	Coupe FWD CHHC		Control Arm Bushing	535309
	2014.07-	Front Axle Left & Right	Coupe FWD CHHC		Rod/Strut,stabiliser	S050040
	2014.07-	Rear Axle Left & Right	Coupe FWD CHHC		Rod/Strut,stabiliser	S051234
	2014.11-	Rear Axle Left & Right Lower Inner	Cabriolet FWD CHHC		Track Control Arm	S062791
	2014.11-	Rear Axle Left & Right Lower Outer	Cabriolet FWD CHHC		Track Control Arm	S062899
	2014.11-	Front Axle Left & Right Lower	Cabriolet FWD CHHC		Control Arm Bushing	510361
	2014.11-	Rear Axle Left & Right Centre	Cabriolet FWD CHHC		Control Arm Bushing	512203
	2014.11-	Front Axle Left & Right	Cabriolet FWD CHHC		Rod/Strut,stabiliser	S050040
	2014.11-	Rear Axle Left & Right	Cabriolet FWD CHHC		Rod/Strut,stabiliser	S051234
TT Quattro						
1.8 (165 kw)	1998.10-2006.06	Front Axle Left Lower	Cabriolet 4WD APX/BAM		Track Control Arm	S060337
	1998.10-2006.06	Front Axle Left Lower	Coupe 4WD APX/BAM		Track Control Arm	S060337
	1998.10-2006.06	Front Axle Right Lower	Cabriolet 4WD APX/BAM		Track Control Arm	S060338
	1998.10-2006.06	Front Axle Right Lower	Coupe 4WD APX/BAM		Track Control Arm	S060338
	1998.10-2006.06	Front Axle Left & Right Lower	Cabriolet 4WD APX/BAM		Ball Joint	S080357
	1998.10-2006.06	Front Axle Left & Right Lower	Coupe 4WD APX/BAM		Ball Joint	S080357
	1998.10-2006.06	Front Axle Left & Right Lower	Cabriolet 4WD APX/BAM		Control Arm Bushing	510065
	1998.10-2006.06	Front Axle Left & Right Lower	Coupe 4WD APX/BAM		Control Arm Bushing	510065
	1998.10-2006.06	Front Axle Left & Right Lower	Cabriolet 4WD APX/BAM	Engine Code:APX,Chassis no.to:8N-Y-060 000	Control Arm Bushing	510084
	1998.10-2006.06	Front Axle Left & Right Lower	Coupe 4WD APX/BAM	Engine Code:APX,Chassis no.to:8N-Y-060 000	Control Arm Bushing	510084
	1998.10-2006.06	Front Axle Left & Right Lower	Cabriolet 4WD APX/BAM		Control Arm Bushing	518115
	1998.10-2006.06	Front Axle Left & Right Lower	Coupe 4WD APX/BAM		Control Arm Bushing	518115
	1998.10-2006.06	Front Axle Left & Right Lower	Cabriolet 4WD APX/BAM		Control Arm Bushing	535313
	1998.10-2006.06	Front Axle Left & Right Lower	Coupe 4WD APX/BAM		Control Arm Bushing	535313
	1998.10-2006.06	Front Axle	Cabriolet 4WD APX/BAM		Suspension Repair Kit	S990026SK
	1998.10-2006.06	Front Axle	Coupe 4WD APX/BAM		Suspension Repair Kit	S990026SK
	1998.10-2006.06	Front Axle Left	Cabriolet 4WD APX/BAM		Rod Assembly	S100004
	1998.10-2006.06	Front Axle Left	Coupe 4WD APX/BAM		Rod Assembly	S100004
	1998.10-2006.06	Front Axle Right	Cabriolet 4WD APX/BAM		Rod Assembly	S100003



	 YEAR	FITTING POSITION	BODY STYLE & DRIVE TYPE & ENGINE	REMARKS	PRODUCT	GSP Ref.
AUDI TT Quattro						
1.8 (165 kw)	1998.10-2006.06	Front Axle Right	Coupe 4WD APX/BAM		Rod Assembly	S100003
	1998.10-2006.06	Front Axle Left & Right	Cabriolet 4WD APX/BAM		Tie Rod Axle Joint	S030425
	1998.10-2006.06	Front Axle Left & Right	Coupe 4WD APX/BAM		Tie Rod Axle Joint	S030425
	1998.10-2006.06	Front Axle Left	Cabriolet 4WD APX/BAM		Tie Rod End	S070035
	1998.10-2006.06	Front Axle Left	Coupe 4WD APX/BAM		Tie Rod End	S070035
	1998.10-2006.06	Front Axle Right	Cabriolet 4WD APX/BAM		Tie Rod End	S070034
	1998.10-2006.06	Front Axle Right	Coupe 4WD APX/BAM		Tie Rod End	S070034
	1998.10-2006.06	Front Axle Left	Cabriolet 4WD APX/BAM		Rod/Strut, stabiliser	S050043
	1998.10-2006.06	Front Axle Left	Coupe 4WD APX/BAM		Rod/Strut, stabiliser	S050043
	1998.10-2006.06	Front Axle Right	Cabriolet 4WD APX/BAM		Rod/Strut, stabiliser	S050036
	1998.10-2006.06	Front Axle Right	Coupe 4WD APX/BAM		Rod/Strut, stabiliser	S050036
	1998.10-2006.06	Rear Axle Left & Right	Cabriolet 4WD APX/BAM	for vehicles with off-doad suspension	Rod/Strut, stabiliser	S050021
	1998.10-2006.06	Rear Axle Left & Right	Coupe 4WD APX/BAM	for vehicles with off-doad suspension	Rod/Strut, stabiliser	S050021
	1998.10-2006.06	Rear Axle Left & Right	Cabriolet 4WD APX/BAM	for vehicles without off-road suspension	Rod/Strut, stabiliser	S050048
	1998.10-2006.06	Rear Axle Left & Right	Coupe 4WD APX/BAM	for vehicles without off-road suspension	Rod/Strut, stabiliser	S050048
	1998.10-2006.06	Front Axle	Cabriolet 4WD APX/BAM	Engine Code:BAM,APX,Chassis no.from:0N-V-060 001	Stabiliser Bushing	510066
	1998.10-2006.06	Front Axle	Coupe 4WD APX/BAM	Engine Code:BAM,APX,Chassis no.from:0N-V-060 001	Stabiliser Bushing	510066
	1998.10-2006.06	Front Axle	Cabriolet 4WD APX/BAM	Engine Code:BAM,APX,Stabiliser Ø:19 mm	Stabiliser Bushing	510232
	1998.10-2006.06	Front Axle	Coupe 4WD APX/BAM	Engine code:BAM,APX,Stabiliser Ø:19 mm	Stabiliser Bushing	510232
	1998.10-2006.06	Front Axle	Cabriolet 4WD APX/BAM	Engine Code:BAM,APX,for OE No.1J0-411 305 AD,Stabiliser Ø:19 mm	Stabiliser Bushing	517166
	1998.10-2006.06	Front Axle	Coupe 4WD APX/BAM	Engine Code:BAM,APX,for OE No.1J0-411 305 AD,Stabiliser Ø:19 mm	Stabiliser Bushing	517166
	1998.10-2006.06	Front Axle	Cabriolet 4WD APX/BAM		Stabiliser Bushing Kit	510066S
	1998.10-2006.06	Front Axle	Coupe 4WD APX/BAM		Stabiliser Bushing Kit	510066S
2.0 (147 kw)	2008.06-2010.06	Rear Axle Left Centre	Coupe 4WD CCZA		Track Control Arm	S061407
	2008.06-2010.06	Rear Axle Left Lower Inner	Coupe 4WD CCZA		Track Control Arm	510349
	2008.06-2010.06	Rear Axle Right Centre	Coupe 4WD CCZA		Track Control Arm	S061408
	2008.06-2010.06	Rear Axle Right Lower Inner	Coupe 4WD CCZA		Track Control Arm	510350
	2008.06-2010.06	Rear Axle Left & Right Lower Outer	Coupe 4WD CCZA		Track Control Arm	S061468
	2008.06-2010.06	Front Axle Left & Right Lower	Coupe 4WD CCZA		Control Arm Bushing	510361
	2008.06-2010.06	Front Axle Left & Right Lower	Coupe 4WD CCZA		Control Arm Bushing	533502
	2008.06-2010.06	Front Axle Left & Right Lower	Coupe 4WD CCZA		Control Arm Bushing	535342
	2008.06-2010.06	Rear Axle Left & Right Upper	Coupe 4WD CCZA		Control Arm Bushing	516372
	2008.06-2010.06	Rear Axle Left & Right Upper	Coupe 4WD CCZA		Control Arm Bushing	516408
	2008.06-2010.06	Rear Axle Left & Right Lower Inner	Coupe 4WD CCZA		Control Arm Bushing	510351
	2008.06-2010.06	Rear Axle Left & Right Lower Inner	Coupe 4WD CCZA		Control Arm Bushing	510352
	2008.06-2010.06	Rear Axle Left & Right Lower Outer	Coupe 4WD CCZA		Control Arm Bushing	516370
	2008.06-2010.06	Rear Axle	Coupe 4WD CCZA		Suspension Repair Kit	S990019SK
	2008.06-2010.06	Front Axle Left & Right	Coupe 4WD CCZA		Tie Rod Axle Joint	S030342
	2008.06-2010.06	Front Axle Left & Right	Coupe 4WD CCZA		Rod/Strut, stabiliser	S050040
	2008.06-2010.06	Rear Axle Left & Right	Coupe 4WD CCZA		Rod/Strut, stabiliser	S050035
	2008.06-2010.06	Rear Axle	Coupe 4WD CCZA		Stabiliser Bushing	530199
2.0 (155 kw)	2010.05-2014.06	Rear Axle Left Centre	Coupe 4WD CESA/CETA		Track Control Arm	S061407
	2010.05-2014.06	Rear Axle Left Lower Inner	Coupe 4WD CESA/CETA		Track Control Arm	510349
	2010.05-2014.06	Rear Axle Right Centre	Coupe 4WD CESA/CETA		Track Control Arm	S061408
	2010.05-2014.06	Rear Axle Right Lower Inner	Coupe 4WD CESA/CETA		Track Control Arm	510350
	2010.05-2014.06	Rear Axle Left & Right Lower Outer	Coupe 4WD CESA/CETA		Track Control Arm	S061468
	2010.05-2014.06	Front Axle Left & Right Lower	Coupe 4WD CESA/CETA		Control Arm Bushing	510361
	2010.05-2014.06	Front Axle Left & Right Lower	Coupe 4WD CESA/CETA		Control Arm Bushing	533502
	2010.05-2014.06	Front Axle Left & Right Lower	Coupe 4WD CESA/CETA		Control Arm Bushing	535342
	2010.05-2014.06	Rear Axle Left & Right Upper	Coupe 4WD CESA/CETA		Control Arm Bushing	516372
	2010.05-2014.06	Rear Axle Left & Right Upper	Coupe 4WD CESA/CETA		Control Arm Bushing	516408
	2010.05-2014.06	Rear Axle Left & Right Lower Inner	Coupe 4WD CESA/CETA		Control Arm Bushing	510351
	2010.05-2014.06	Rear Axle Left & Right Lower Inner	Coupe 4WD CESA/CETA		Control Arm Bushing	510352
	2010.05-2014.06	Rear Axle Left & Right Lower Outer	Coupe 4WD CESA/CETA		Control Arm Bushing	516370
	2010.05-2014.06	Front Axle Left & Right	Coupe 4WD CESA/CETA		Tie Rod Axle Joint	S030342
	2010.05-2014.06	Front Axle Left & Right	Coupe 4WD CESA/CETA		Rod/Strut, stabiliser	S050040
	2010.05-2014.06	Rear Axle Left & Right	Coupe 4WD CESA/CETA		Rod/Strut, stabiliser	S050035
	2010.05-2014.06	Rear Axle	Coupe 4WD CESA/CETA		Stabiliser Bushing	530199
TTRS Quattro						
2.5 (250 kw)	2009.07-2014.06	Rear Axle Left Centre	Cabriolet 4WD CEPA		Track Control Arm	S061407
	2009.07-2014.06	Rear Axle Left Centre	Coupe 4WD CEPA		Track Control Arm	S061407
	2009.07-2014.06	Rear Axle Left Lower Inner	Cabriolet 4WD CEPA		Track Control Arm	510349
	2009.07-2014.06	Rear Axle Left Lower Inner	Coupe 4WD CEPA		Track Control Arm	510349
	2009.07-2014.06	Rear Axle Right Centre	Cabriolet 4WD CEPA		Track Control Arm	S061408



	 YEAR	FITTING POSITION	BODY STYLE & DRIVE TYPE & ENGINE	REMARKS	PRODUCT	GSP Ref.
AUDI						
TTRS Quattro						
2.5 (250 kw)	2009.07-2014.06	Rear Axle Right Centre	Coupe 4WD CEPA		Track Control Arm	S061408
	2009.07-2014.06	Rear Axle Left & Right Lower Outer	Cabriolet 4WD CEPA		Track Control Arm	S061468
	2009.07-2014.06	Rear Axle Left & Right Lower Outer	Coupe 4WD CEPA		Track Control Arm	S061468
	2009.07-2014.06	Front Axle Left & Right Lower	Cabriolet 4WD CEPA		Control Arm Bushing	510361
	2009.07-2014.06	Front Axle Left & Right Lower	Coupe 4WD CEPA		Control Arm Bushing	510361
	2009.07-2014.06	Front Axle Left & Right Lower	Cabriolet 4WD CEPA		Control Arm Bushing	533502
	2009.07-2014.06	Front Axle Left & Right Lower	Coupe 4WD CEPA		Control Arm Bushing	533502
	2009.07-2014.06	Front Axle Left & Right Lower	Cabriolet 4WD CEPA		Control Arm Bushing	535342
	2009.07-2014.06	Front Axle Left & Right Lower	Coupe 4WD CEPA		Control Arm Bushing	535342
	2009.07-2014.06	Rear Axle Left & Right Upper	Cabriolet 4WD CEPA		Control Arm Bushing	516372
	2009.07-2014.06	Rear Axle Left & Right Upper	Coupe 4WD CEPA		Control Arm Bushing	516372
	2009.07-2014.06	Rear Axle Left & Right Upper	Cabriolet 4WD CEPA		Control Arm Bushing	516408
	2009.07-2014.06	Rear Axle Left & Right Upper	Coupe 4WD CEPA		Control Arm Bushing	516408
	2009.07-2014.06	Rear Axle Left & Right Lower Inner	Cabriolet 4WD CEPA		Control Arm Bushing	510352
	2009.07-2014.06	Rear Axle Left & Right Lower Inner	Coupe 4WD CEPA		Control Arm Bushing	510352
	2009.07-2014.06	Rear Axle Left & Right Lower Outer	Cabriolet 4WD CEPA		Control Arm Bushing	516370
	2009.07-2014.06	Rear Axle Left & Right Lower Outer	Coupe 4WD CEPA		Control Arm Bushing	516370
	2009.07-2014.06	Front Axle Left & Right	Cabriolet 4WD CEPA		Tie Rod Axle Joint	S030342
	2009.07-2014.06	Front Axle Left & Right	Coupe 4WD CEPA		Tie Rod Axle Joint	S030342
	2009.07-2014.06	Front Axle Left & Right	Cabriolet 4WD CEPA		Rod/Strut, stabiliser	S050040
	2009.07-2014.06	Front Axle Left & Right	Coupe 4WD CEPA		Rod/Strut, stabiliser	S050040
	2009.07-2014.06	Rear Axle Left & Right	Cabriolet 4WD CEPA		Rod/Strut, stabiliser	S050035
	2009.07-2014.06	Rear Axle Left & Right	Coupe 4WD CEPA		Rod/Strut, stabiliser	S050035
	2009.07-2014.06	Rear Axle	Cabriolet 4WD CEPA		Stabiliser Bushing	530183
	2009.07-2014.06	Rear Axle	Coupe 4WD CEPA		Stabiliser Bushing	530183
	2009.07-2014.06	Rear Axle	Cabriolet 4WD CEPA		Stabiliser Bushing	530199
	2009.07-2014.06	Rear Axle	Coupe 4WD CEPA		Stabiliser Bushing	530199
2.5 (294 kw)	2016.05-	Rear Axle Left & Right Lower Outer	Coupe 4WD DAZA/DNWA		Track Control Arm	S062899
	2016.05-	Front Axle Left & Right Lower	Coupe 4WD DAZA/DNWA		Control Arm Bushing	510361
	2016.05-	Rear Axle Left & Right Centre	Coupe 4WD DAZA/DNWA		Control Arm Bushing	512203
	2016.05-	Front Axle Left & Right	Coupe 4WD DAZA/DNWA		Rod/Strut, stabiliser	S050040
	2016.05-	Rear Axle Left & Right	Coupe 4WD DAZA/DNWA		Rod/Strut, stabiliser	S051234
TTS Quattro						
2.0 (200 kw)	2008.05-2014.06	Rear Axle Left Centre	Cabriolet 4WD CDLB		Track Control Arm	S061407
	2008.05-2014.06	Rear Axle Left Centre	Coupe 4WD CDLB		Track Control Arm	S061407
	2008.05-2014.06	Rear Axle Left Lower Inner	Cabriolet 4WD CDLB		Track Control Arm	510349
	2008.05-2014.06	Rear Axle Left Lower Inner	Coupe 4WD CDLB		Track Control Arm	510349
	2008.05-2014.06	Rear Axle Right Centre	Cabriolet 4WD CDLB		Track Control Arm	S061408
	2008.05-2014.06	Rear Axle Right Centre	Coupe 4WD CDLB		Track Control Arm	S061408
	2008.05-2014.06	Rear Axle Right Lower Inner	Cabriolet 4WD CDLB		Track Control Arm	510350
	2008.05-2014.06	Rear Axle Right Lower Inner	Coupe 4WD CDLB		Track Control Arm	510350
	2008.05-2014.06	Rear Axle Left & Right Lower Outer	Cabriolet 4WD CDLB		Track Control Arm	S061468
	2008.05-2014.06	Rear Axle Left & Right Lower Outer	Coupe 4WD CDLB		Track Control Arm	S061468
	2008.05-2014.06	Front Axle Left & Right Lower	Cabriolet 4WD CDLB		Control Arm Bushing	510361
	2008.05-2014.06	Front Axle Left & Right Lower	Coupe 4WD CDLB		Control Arm Bushing	510361
	2008.05-2014.06	Front Axle Left & Right Lower	Cabriolet 4WD CDLB		Control Arm Bushing	533502
	2008.05-2014.06	Front Axle Left & Right Lower	Coupe 4WD CDLB		Control Arm Bushing	533502
	2008.05-2014.06	Front Axle Left & Right Lower	Cabriolet 4WD CDLB		Control Arm Bushing	535342
	2008.05-2014.06	Front Axle Left & Right Lower	Coupe 4WD CDLB		Control Arm Bushing	535342
	2008.05-2014.06	Rear Axle Left & Right Upper	Cabriolet 4WD CDLB		Control Arm Bushing	516372
	2008.05-2014.06	Rear Axle Left & Right Upper	Coupe 4WD CDLB		Control Arm Bushing	516372
	2008.05-2014.06	Rear Axle Left & Right Upper	Cabriolet 4WD CDLB		Control Arm Bushing	516408
	2008.05-2014.06	Rear Axle Left & Right Upper	Coupe 4WD CDLB		Control Arm Bushing	516408
	2008.05-2014.06	Rear Axle Left & Right Lower Inner	Cabriolet 4WD CDLB		Control Arm Bushing	510351
	2008.05-2014.06	Rear Axle Left & Right Lower Inner	Coupe 4WD CDLB		Control Arm Bushing	510351
	2008.05-2014.06	Rear Axle Left & Right Lower Inner	Cabriolet 4WD CDLB		Control Arm Bushing	510352
	2008.05-2014.06	Rear Axle Left & Right Lower Inner	Coupe 4WD CDLB		Control Arm Bushing	510352
	2008.05-2014.06	Rear Axle Left & Right Lower Outer	Cabriolet 4WD CDLB		Control Arm Bushing	516370
	2008.05-2014.06	Rear Axle Left & Right Lower Outer	Coupe 4WD CDLB		Control Arm Bushing	516370
	2008.05-2014.06	Rear Axle	Cabriolet 4WD CDLB		Suspension Repair Kit	S990019SK
	2008.05-2014.06	Rear Axle	Coupe 4WD CDLB		Suspension Repair Kit	S990019SK
	2008.05-2014.06	Front Axle Left & Right	Cabriolet 4WD CDLB		Tie Rod Axle Joint	S030342
	2008.05-2014.06	Front Axle Left & Right	Coupe 4WD CDLB		Tie Rod Axle Joint	S030342
	2008.05-2014.06	Front Axle Left & Right	Cabriolet 4WD CDLB		Rod/Strut, stabiliser	S050040



	 YEAR	FITTING POSITION	BODY STYLE & DRIVE TYPE & ENGINE	REMARKS	PRODUCT	GSP Ref.
AUDI						
TTS Quattro						
2.0 (200 kw)	2008.05-2014.06	Front Axle Left & Right	Coupe 4WD CDLB		Rod/Strut, stabiliser	S050040
	2008.05-2014.06	Rear Axle Left & Right	Cabriolet 4WD CDLB		Rod/Strut, stabiliser	S050035
	2008.05-2014.06	Rear Axle Left & Right	Coupe 4WD CDLB		Rod/Strut, stabiliser	S050035
	2008.05-2014.06	Rear Axle	Cabriolet 4WD CDLB		Stabiliser Bushing	530199
	2008.05-2014.06	Rear Axle	Coupe 4WD CDLB		Stabiliser Bushing	530199
BENTLEY						
Bentayga						
6.0 (447 kw)	2015.10-	Front Axle Left & Right	SUV 4WD DDBB		Rod/Strut, stabiliser	S051258
	2015.10-	Rear Axle Left & Right	SUV 4WD DDBB		Rod/Strut, stabiliser	S051432
Continental GT						
4.0 (373 kw)	2012.01-	Rear Axle Left & Right	Coupe 4WD CMMC/CYCB		Rod/Strut, stabiliser	S050471
	2012.04-	Rear Axle Left & Right	Coupe 4WD CMMC		Rod/Strut, stabiliser	S050471
6.0 (423 kw)	2010.11-2013.12	Rear Axle Left & Right	Coupe 4WD CKHB		Rod/Strut, stabiliser	S050471
	2011.01-	Rear Axle Left & Right	Coupe 4WD CKHB/CVAB		Rod/Strut, stabiliser	S050471
6.0 (467 kw)	2014.05-2016.05	Rear Axle Left & Right	Coupe 4WD CVAC/DBDE		Rod/Strut, stabiliser	S050471
6.0 (472 kw)	2016.05-	Rear Axle Left & Right	Coupe 4WD DBDD		Rod/Strut, stabiliser	S050471
Continental GTC						
6.0 (467 kw)	2014.05-	Rear Axle Right	Cabriolet 4WD CVAC/DBDE		Rod/Strut, stabiliser	S050024
Flying Spur						
4.0 (388 kw)	2016.05-	Front Axle Right Upper Inner	Saloon 4WD CYCA		Track Control Arm	S060051
	2016.05-	Rear Axle Right	Saloon 4WD CYCA		Rod/Strut, stabiliser	S050024
	2016.05-	Rear Axle Left & Right	Saloon 4WD CYCA		Rod/Strut, stabiliser	S050471
6.0 (453 kw)	2013.03-	Rear Axle Right	Saloon 4WD CVAA		Rod/Strut, stabiliser	S050024
	2014.03-	Rear Axle Right	Saloon 4WD CVAA		Rod/Strut, stabiliser	S050024
6.0 (460 kw)	2013.03-	Front Axle Right Upper Inner	Saloon 4WD CVAA/DBDB		Track Control Arm	S060051
	2013.03-	Rear Axle Right	Saloon 4WD CVAA/DBDB		Rod/Strut, stabiliser	S050024
	2013.03-	Rear Axle Left & Right	Saloon 4WD CVAA/DBDB		Rod/Strut, stabiliser	S050471
6.0 (467 kw)	2016.09-	Rear Axle Right	Saloon 4WD DBDE		Rod/Strut, stabiliser	S050024
	2016.09-	Rear Axle Left & Right	Saloon 4WD DBDE		Rod/Strut, stabiliser	S050471
Mulsanne						
6.8 (377 kw)	2009.09-2020.07	Front Axle Left & Right	Saloon RWD CKBB/CZMB		Rod/Strut, stabiliser	S051258
BMW						
116i						
1.6 (100 kw)	2011.07-2015.02	Front Axle Left Lower Inner	Hatchback RWD N13B16A		Track Control Arm	S061616
	2011.07-2015.02	Front Axle Left Lower Outer	Hatchback RWD N13B16A		Track Control Arm	S061614
	2011.07-2015.02	Front Axle Right Lower Inner	Hatchback RWD N13B16A		Track Control Arm	S061617
	2011.07-2015.02	Front Axle Right Lower Outer	Hatchback RWD N13B16A		Track Control Arm	S061615
	2011.07-2015.02	Rear Axle Left Upper Inner	Hatchback RWD N13B16A		Track Control Arm	S061775
	2011.07-2015.02	Rear Axle Right Upper Inner	Hatchback RWD N13B16A		Track Control Arm	S061776
	2011.07-2015.02	Rear Axle Left & Right Lower Inner	Hatchback RWD N13B16A		Track Control Arm	S061773
	2011.07-2015.02	Rear Axle Left & Right Lower Outer	Hatchback RWD N13B16A		Track Control Arm	S061774
	2011.07-2015.02	Front Axle Left & Right Lower Inner	Hatchback RWD N13B16A		Control Arm Bushing	532583
	2011.07-2015.02	Front Axle Left & Right Lower Outer	Hatchback RWD N13B16A		Control Arm Bushing	533483
	2011.07-2015.02	Front Axle Left & Right	Hatchback RWD N13B16A		Tie Rod End	S070824
	2011.07-2015.02	Front Axle Left & Right	Hatchback RWD N13B16A		Tie Rod End	S070866
	2011.07-2015.02	Front Axle Left	Hatchback RWD N13B16A	for vehicles with Adaptive Drive	Rod/Strut, stabiliser	S051259
	2011.07-2015.02	Front Axle Left	Hatchback RWD N13B16A	for vehicles with M-technology	Rod/Strut, stabiliser	S051353
	2011.07-2015.02	Front Axle Right	Hatchback RWD N13B16A		Rod/Strut, stabiliser	S051260
	2011.07-2015.02	Front Axle Left & Right	Hatchback RWD N13B16A	for vehicles without Adaptive Drive	Rod/Strut, stabiliser	S051259
	2011.07-2015.02	Front Axle Left & Right	Hatchback RWD N13B16A	for vehicles with standard suspension	Rod/Strut, stabiliser	S051353
	2011.07-2015.02	Rear Axle Left	Hatchback RWD N13B16A		Rod/Strut, stabiliser	S051261
	2011.07-2015.02	Rear Axle Right	Hatchback RWD N13B16A		Rod/Strut, stabiliser	S051262
	2011.12-2015.02	Front Axle Left Lower Inner	Hatchback RWD N13B16A		Track Control Arm	S061616
	2011.12-2015.02	Front Axle Left Lower Outer	Hatchback RWD N13B16A		Track Control Arm	S061614
	2011.12-2015.02	Front Axle Right Lower Inner	Hatchback RWD N13B16A		Track Control Arm	S061617
	2011.12-2015.02	Front Axle Right Lower Outer	Hatchback RWD N13B16A		Track Control Arm	S061615
	2011.12-2015.02	Rear Axle Left Upper Inner	Hatchback RWD N13B16A		Track Control Arm	S061775
	2011.12-2015.02	Rear Axle Right Upper Inner	Hatchback RWD N13B16A		Track Control Arm	S061776
	2011.12-2015.02	Rear Axle Left & Right Lower Inner	Hatchback RWD N13B16A		Track Control Arm	S061773
	2011.12-2015.02	Rear Axle Left & Right Lower Outer	Hatchback RWD N13B16A		Track Control Arm	S061774
	2011.12-2015.02	Front Axle Left & Right Lower Inner	Hatchback RWD N13B16A		Control Arm Bushing	532583
	2011.12-2015.02	Front Axle Left & Right Lower Outer	Hatchback RWD N13B16A		Control Arm Bushing	533483
	2011.12-2015.02	Front Axle Left	Hatchback RWD N13B16A	for vehicles with Adaptive Drive	Rod/Strut, stabiliser	S051259
	2011.12-2015.02	Front Axle Left	Hatchback RWD N13B16A	for vehicles with M-technology	Rod/Strut, stabiliser	S051353



	 YEAR	FITTING POSITION	BODY STYLE & DRIVE TYPE & ENGINE	REMARKS	PRODUCT	GSP Ref.	
BMW 116i							
1.6 (100 kw)	2011.12-2015.02	Front Axle Right	Hatchback RWD N13B16A		Rod/Strut, stabiliser	S051260	
	2011.12-2015.02	Front Axle Left & Right	Hatchback RWD N13B16A	for vehicles without Adaptive Drive	Rod/Strut, stabiliser	S051259	
	2011.12-2015.02	Front Axle Left & Right	Hatchback RWD N13B16A	for vehicles with standard suspension	Rod/Strut, stabiliser	S051353	
	2011.12-2015.02	Rear Axle Left	Hatchback RWD N13B16A		Rod/Strut, stabiliser	S051261	
	2011.12-2015.02	Rear Axle Right	Hatchback RWD N13B16A		Rod/Strut, stabiliser	S051262	
118i							
1.5 (103 kw)	2019.07-	Rear Axle Left & Right Upper	Hatchback FWD B38A15A		Track Control Arm	S063055	
	2019.07-	Front Axle Left & Right	Hatchback FWD B38A15A		Rod/Strut, stabiliser	S051334	
	2019.07-	Rear Axle Left & Right	Hatchback FWD B38A15A		Rod/Strut, stabiliser	S051243	
1.6 (125 kw)	2011.06-2015.11	Front Axle Left Lower Inner	Hatchback RWD N13B16A		Track Control Arm	S061616	
	2011.06-2015.11	Front Axle Left Lower Outer	Hatchback RWD N13B16A		Track Control Arm	S061614	
	2011.06-2015.11	Front Axle Right Lower Inner	Hatchback RWD N13B16A		Track Control Arm	S061617	
	2011.06-2015.11	Front Axle Right Lower Outer	Hatchback RWD N13B16A		Track Control Arm	S061615	
	2011.06-2015.11	Rear Axle Left Upper Inner	Hatchback RWD N13B16A		Track Control Arm	S061775	
	2011.06-2015.11	Rear Axle Right Upper Inner	Hatchback RWD N13B16A		Track Control Arm	S061776	
	2011.06-2015.11	Rear Axle Left & Right Lower Inner	Hatchback RWD N13B16A		Track Control Arm	S061773	
	2011.06-2015.11	Rear Axle Left & Right Lower Outer	Hatchback RWD N13B16A		Track Control Arm	S061774	
	2011.06-2015.11	Front Axle Left & Right Lower Inner	Hatchback RWD N13B16A		Control Arm Bushing	532583	
	2011.06-2015.11	Front Axle Left & Right Lower Outer	Hatchback RWD N13B16A		Control Arm Bushing	533483	
	2011.06-2015.11	Front Axle Left & Right	Hatchback RWD N13B16A		Tie Rod End	S070824	
	2011.06-2015.11	Front Axle Left & Right	Hatchback RWD N13B16A		Tie Rod End	S070866	
	2011.06-2015.11	Front Axle Left	Hatchback RWD N13B16A	for vehicles with Adaptive Drive	Rod/Strut, stabiliser	S051259	
	2011.06-2015.11	Front Axle Left	Hatchback RWD N13B16A	for vehicles with M-technology	Rod/Strut, stabiliser	S051353	
	2011.06-2015.11	Front Axle Right	Hatchback RWD N13B16A		Rod/Strut, stabiliser	S051260	
	2011.06-2015.11	Front Axle Left & Right	Hatchback RWD N13B16A	for vehicles without Adaptive Drive	Rod/Strut, stabiliser	S051259	
	2011.06-2015.11	Front Axle Left & Right	Hatchback RWD N13B16A	for vehicles with standard suspension	Rod/Strut, stabiliser	S051353	
	2011.06-2015.11	Rear Axle Left	Hatchback RWD N13B16A		Rod/Strut, stabiliser	S051261	
	2011.06-2015.11	Rear Axle Right	Hatchback RWD N13B16A		Rod/Strut, stabiliser	S051262	
	2.0 (100 kw)	2006.10-2012.09	Front Axle Left Lower Inner	Hatchback RWD N46B20B		Track Control Arm	S060087
2006.10-2012.09		Front Axle Left Lower Inner	Hatchback RWD N46B20B		Track Control Arm	S062657	
2006.10-2012.09		Front Axle Left Lower Outer	Hatchback RWD N46B20B		Track Control Arm	S060085	
2006.10-2012.09		Front Axle Right Lower Inner	Hatchback RWD N46B20B		Track Control Arm	S060088	
2006.10-2012.09		Front Axle Right Lower Inner	Hatchback RWD N46B20B		Track Control Arm	S062658	
2006.10-2012.09		Front Axle Right Lower Outer	Hatchback RWD N46B20B		Track Control Arm	S060086	
2006.10-2012.09		Rear Axle Left Centre	Hatchback RWD N46B20B		Track Control Arm	S063116	
2006.10-2012.09		Rear Axle Right Centre	Hatchback RWD N46B20B		Track Control Arm	S063115	
2006.10-2012.09		Rear Axle Left & Right Centre	Hatchback RWD N46B20B		Track Control Arm	S060089	
2006.10-2012.09		Rear Axle Left & Right Upper	Hatchback RWD N46B20B		Track Control Arm	S062839	
2006.10-2012.09		Rear Axle Left & Right Lower Outer	Hatchback RWD N46B20B		Track Control Arm	S060091	
2006.10-2012.09		Front Axle Left & Right Lower Inner	Hatchback RWD N46B20B		Control Arm Bushing	531936	
2006.10-2012.09		Front Axle	Hatchback RWD N46B20B		Suspension Repair Kit	S990004SK	
2006.10-2012.09		Front Axle Left	Hatchback RWD N46B20B		Rod Assembly	S100330	
2006.10-2012.09		Front Axle Left	Hatchback RWD N46B20B		Rod Assembly	S100332	
2006.10-2012.09		Front Axle Right	Hatchback RWD N46B20B		Rod Assembly	S100331	
2006.10-2012.09		Front Axle Right	Hatchback RWD N46B20B		Rod Assembly	S100333	
2006.10-2012.09		Front Axle Left & Right	Hatchback RWD N46B20B		Tie Rod Axle Joint	S030350	
2006.10-2012.09		Front Axle Left & Right	Hatchback RWD N46B20B		Tie Rod Axle Joint	S030847	
2006.10-2012.09		Front Axle Left	Hatchback RWD N46B20B		Tie Rod End	S070045	
2006.10-2012.09		Front Axle Right	Hatchback RWD N46B20B		Tie Rod End	S070046	
2006.10-2012.09		Front Axle Left	Hatchback RWD N46B20B		Rod/Strut, stabiliser	S050068	
2006.10-2012.09		Front Axle Right	Hatchback RWD N46B20B		Rod/Strut, stabiliser	S050069	
2006.10-2012.09		Rear Axle Left & Right	Hatchback RWD N46B20B		Rod/Strut, stabiliser	S050070	
2006.10-2012.09		Front Axle	Hatchback RWD N46B20B		Stabiliser Bushing	519357	
2006.10-2012.09		Rear Axle	Hatchback RWD N46B20B		Stabiliser Bushing	530239	
2006.10-2012.09		Rear Axle	Hatchback RWD N46B20B		Stabiliser Bushing	535302	
2006.10-2012.09		Rear Axle	Hatchback RWD N46B20B		Stabiliser Bushing	535307	
2.0 (105 kw)		2007.03-2012.09	Front Axle Left Lower Inner	Hatchback RWD N43B20A	Date from:2007.03	Track Control Arm	S060087
		2007.03-2012.09	Front Axle Left Lower Inner	Hatchback RWD N43B20A		Track Control Arm	S062657
	2007.03-2012.09	Front Axle Left Lower Outer	Hatchback RWD N43B20A		Track Control Arm	S060085	
	2007.03-2012.09	Front Axle Right Lower Inner	Hatchback RWD N43B20A	Date from:2007.03	Track Control Arm	S060088	
	2007.03-2012.09	Front Axle Right Lower Inner	Hatchback RWD N43B20A		Track Control Arm	S062658	
	2007.03-2012.09	Front Axle Right Lower Outer	Hatchback RWD N43B20A		Track Control Arm	S060086	
	2007.03-2012.09	Rear Axle Left Centre	Hatchback RWD N43B20A		Track Control Arm	S063116	
	2007.03-2012.09	Rear Axle Right Centre	Hatchback RWD N43B20A		Track Control Arm	S063115	



	 YEAR	FITTING POSITION	BODY STYLE & DRIVE TYPE & ENGINE	REMARKS	PRODUCT	GSP Ref.
BMW 118i						
2.0 (105 kw)	2007.03-2012.09	Rear Axle Left & Right Centre	Hatchback RWD N43B20A		Track Control Arm	S060089
	2007.03-2012.09	Rear Axle Left & Right Upper	Hatchback RWD N43B20A		Track Control Arm	S062839
	2007.03-2012.09	Front Axle Left & Right Lower Inner	Hatchback RWD N43B20A		Control Arm Bushing	531936
	2007.03-2012.09	Front Axle	Hatchback RWD N43B20A		Suspension Repair Kit	S990004SK
	2007.03-2012.09	Front Axle Left	Hatchback RWD N43B20A		Rod Assembly	S100330
	2007.03-2012.09	Front Axle Right	Hatchback RWD N43B20A		Rod Assembly	S100331
	2007.03-2012.09	Front Axle Left & Right	Hatchback RWD N43B20A		Tie Rod Axle Joint	S030350
	2007.03-2012.09	Front Axle Left	Hatchback RWD N43B20A		Tie Rod End	S070045
	2007.03-2012.09	Front Axle Right	Hatchback RWD N43B20A		Tie Rod End	S070046
	2007.03-2012.09	Front Axle Left	Hatchback RWD N43B20A		Rod/Strut, stabiliser	S050068
	2007.03-2012.09	Front Axle Right	Hatchback RWD N43B20A		Rod/Strut, stabiliser	S050069
	2007.03-2012.09	Rear Axle Left & Right	Hatchback RWD N43B20A	L:160mm	Rod/Strut, stabiliser	S050070
	2007.03-2012.09	Rear Axle Left & Right	Hatchback RWD N43B20A	L:161mm	Rod/Strut, stabiliser	S051405
	2007.03-2012.09	Front Axle	Hatchback RWD N43B20A		Stabiliser Bushing	519357
	2007.03-2012.09	Rear Axle	Hatchback RWD N43B20A		Stabiliser Bushing	530239
	2007.03-2012.09	Rear Axle	Hatchback RWD N43B20A	Inner Diameter:13mm	Stabiliser Bushing	535302
	2007.03-2012.09	Rear Axle	Hatchback RWD N43B20A	Inner Diameter:11.1mm	Stabiliser Bushing	535307
120i						
2.0 (110 kw)	2004.06-2007.02	Front Axle Left Lower Inner	Hatchback RWD N46B20B/N46B20BD/N46B20C		Track Control Arm	S060087
	2004.06-2007.02	Front Axle Left Lower Inner	Hatchback RWD N46B20B/N46B20BD/N46B20C		Track Control Arm	S062657
	2004.06-2007.02	Front Axle Left Lower Outer	Hatchback RWD N46B20B/N46B20BD/N46B20C		Track Control Arm	S060085
	2004.06-2007.02	Front Axle Right Lower Inner	Hatchback RWD N46B20B/N46B20BD/N46B20C		Track Control Arm	S060088
	2004.06-2007.02	Front Axle Right Lower Inner	Hatchback RWD N46B20B/N46B20BD/N46B20C		Track Control Arm	S062658
	2004.06-2007.02	Front Axle Right Lower Outer	Hatchback RWD N46B20B/N46B20BD/N46B20C		Track Control Arm	S060086
	2004.06-2007.02	Rear Axle Left Centre	Hatchback RWD N46B20B/N46B20BD/N46B20C		Track Control Arm	S063116
	2004.06-2007.02	Rear Axle Right Centre	Hatchback RWD N46B20B/N46B20BD/N46B20C		Track Control Arm	S063115
	2004.06-2007.02	Rear Axle Left & Right Centre	Hatchback RWD N46B20B/N46B20BD/N46B20C		Track Control Arm	S060089
	2004.06-2007.02	Rear Axle Left & Right Upper	Hatchback RWD N46B20B/N46B20BD/N46B20C		Track Control Arm	S062839
	2004.06-2007.02	Rear Axle Left & Right Lower Outer	Hatchback RWD N46B20B/N46B20BD/N46B20C		Track Control Arm	S060091
	2004.06-2007.02	Front Axle Left & Right Lower Inner	Hatchback RWD N46B20B/N46B20BD/N46B20C		Control Arm Bushing	531936
	2004.06-2007.02	Front Axle	Hatchback RWD N46B20B/N46B20BD/N46B20C		Suspension Repair Kit	S990004SK
	2004.06-2007.02	Front Axle Left	Hatchback RWD N46B20B/N46B20BD/N46B20C		Rod Assembly	S100330
	2004.06-2007.02	Front Axle Left	Hatchback RWD N46B20B/N46B20BD/N46B20C		Rod Assembly	S100332
	2004.06-2007.02	Front Axle Right	Hatchback RWD N46B20B/N46B20BD/N46B20C		Rod Assembly	S100331
	2004.06-2007.02	Front Axle Right	Hatchback RWD N46B20B/N46B20BD/N46B20C		Rod Assembly	S100333
	2004.06-2007.02	Front Axle Left & Right	Hatchback RWD N46B20B/N46B20BD/N46B20C		Tie Rod Axle Joint	S030350
	2004.06-2007.02	Front Axle Left & Right	Hatchback RWD N46B20B/N46B20BD/N46B20C		Tie Rod Axle Joint	S030847
	2004.06-2007.02	Front Axle Left	Hatchback RWD N46B20B/N46B20BD/N46B20C		Tie Rod End	S070045
	2004.06-2007.02	Front Axle Right	Hatchback RWD N46B20B/N46B20BD/N46B20C		Tie Rod End	S070046
	2004.06-2007.02	Front Axle Left	Hatchback RWD N46B20B/N46B20BD/N46B20C		Rod/Strut, stabiliser	S050068
	2004.06-2007.02	Front Axle Right	Hatchback RWD N46B20B/N46B20BD/N46B20C		Rod/Strut, stabiliser	S050069
	2004.06-2007.02	Rear Axle Left & Right	Hatchback RWD N46B20B/N46B20BD/N46B20C		Rod/Strut, stabiliser	S050070
	2004.06-2007.02	Front Axle	Hatchback RWD N46B20B/N46B20BD/N46B20C		Stabiliser Bushing	519357
	2004.06-2007.02	Rear Axle	Hatchback RWD N46B20B/N46B20BD/N46B20C		Stabiliser Bushing	530239
	2004.06-2007.02	Rear Axle	Hatchback RWD N46B20B/N46B20BD/N46B20C		Stabiliser Bushing	535302
	2004.06-2007.02	Rear Axle	Hatchback RWD N46B20B/N46B20BD/N46B20C		Stabiliser Bushing	535307
2.0 (115 kw)	2007.03-2011.06	Front Axle Left Lower Inner	Hatchback RWD N46B20B/N46B20C		Track Control Arm	S060087
	2007.03-2011.06	Front Axle Left Lower Inner	Hatchback RWD N46B20B/N46B20C		Track Control Arm	S062657
	2007.03-2011.06	Front Axle Left Lower Outer	Hatchback RWD N46B20B/N46B20C		Track Control Arm	S060085
	2007.03-2011.06	Front Axle Right Lower Inner	Hatchback RWD N46B20B/N46B20C		Track Control Arm	S060088
	2007.03-2011.06	Front Axle Right Lower Inner	Hatchback RWD N46B20B/N46B20C		Track Control Arm	S062658
	2007.03-2011.06	Front Axle Right Lower Outer	Hatchback RWD N46B20B/N46B20C		Track Control Arm	S060086
	2007.03-2011.06	Rear Axle Left Centre	Hatchback RWD N46B20B/N46B20C		Track Control Arm	S063116
	2007.03-2011.06	Rear Axle Right Centre	Hatchback RWD N46B20B/N46B20C		Track Control Arm	S063115
	2007.03-2011.06	Rear Axle Left & Right Centre	Hatchback RWD N46B20B/N46B20C		Track Control Arm	S060089
	2007.03-2011.06	Rear Axle Left & Right Upper	Hatchback RWD N46B20B/N46B20C		Track Control Arm	S062839
	2007.03-2011.06	Rear Axle Left & Right Lower Outer	Hatchback RWD N46B20B/N46B20C		Track Control Arm	S060091
	2007.03-2011.06	Front Axle Left & Right Lower Inner	Hatchback RWD N46B20B/N46B20C		Control Arm Bushing	531936
	2007.03-2011.06	Front Axle	Hatchback RWD N46B20B/N46B20C		Suspension Repair Kit	S990004SK
	2007.03-2011.06	Front Axle Left	Hatchback RWD N46B20B/N46B20C		Rod Assembly	S100330
	2007.03-2011.06	Front Axle Left	Hatchback RWD N46B20B/N46B20C		Rod Assembly	S100332
	2007.03-2011.06	Front Axle Right	Hatchback RWD N46B20B/N46B20C		Rod Assembly	S100331
	2007.03-2011.06	Front Axle Right	Hatchback RWD N46B20B/N46B20C		Rod Assembly	S100333
	2007.03-2011.06	Front Axle Left & Right	Hatchback RWD N46B20B/N46B20C		Tie Rod Axle Joint	S030350



	 YEAR	FITTING POSITION	BODY STYLE & DRIVE TYPE & ENGINE	REMARKS	PRODUCT	GSP Ref.
BMW						
120i						
2.0 (115 kw)	2007.03-2011.06	Front Axle Left & Right	Hatchback RWD N46B20B/N46B20C		Tie Rod Axle Joint	S030847
	2007.03-2011.06	Front Axle Left	Hatchback RWD N46B20B/N46B20C		Tie Rod End	S070045
	2007.03-2011.06	Front Axle Right	Hatchback RWD N46B20B/N46B20C		Tie Rod End	S070046
	2007.03-2011.06	Front Axle Left	Hatchback RWD N46B20B/N46B20C		Rod/Strut, stabiliser	S050068
	2007.03-2011.06	Front Axle Right	Hatchback RWD N46B20B/N46B20C		Rod/Strut, stabiliser	S050069
	2007.03-2011.06	Rear Axle Left & Right	Hatchback RWD N46B20B/N46B20C		Rod/Strut, stabiliser	S050070
	2007.03-2011.06	Front Axle	Hatchback RWD N46B20B/N46B20C		Stabiliser Bushing	519357
	2007.03-2011.06	Rear Axle	Hatchback RWD N46B20B/N46B20C		Stabiliser Bushing	530239
	2007.03-2011.06	Rear Axle	Hatchback RWD N46B20B/N46B20C		Stabiliser Bushing	535302
	2007.03-2011.06	Rear Axle	Hatchback RWD N46B20B/N46B20C		Stabiliser Bushing	535307
	2007.03-2011.12	Front Axle Left Lower Inner	Hatchback RWD N46B20B/N46B20C		Track Control Arm	S060087
	2007.03-2011.12	Front Axle Left Lower Inner	Hatchback RWD N46B20B/N46B20C		Track Control Arm	S062657
	2007.03-2011.12	Front Axle Left Lower Outer	Hatchback RWD N46B20B/N46B20C		Track Control Arm	S060085
	2007.03-2011.12	Front Axle Right Lower Inner	Hatchback RWD N46B20B/N46B20C		Track Control Arm	S060088
	2007.03-2011.12	Front Axle Right Lower Inner	Hatchback RWD N46B20B/N46B20C		Track Control Arm	S062658
	2007.03-2011.12	Front Axle Right Lower Outer	Hatchback RWD N46B20B/N46B20C		Track Control Arm	S060086
	2007.03-2011.12	Rear Axle Left Centre	Hatchback RWD N46B20B/N46B20C		Track Control Arm	S063116
	2007.03-2011.12	Rear Axle Right Centre	Hatchback RWD N46B20B/N46B20C		Track Control Arm	S063115
	2007.03-2011.12	Rear Axle Left & Right Centre	Hatchback RWD N46B20B/N46B20C		Track Control Arm	S060089
	2007.03-2011.12	Rear Axle Left & Right Upper	Hatchback RWD N46B20B/N46B20C		Track Control Arm	S062839
	2007.03-2011.12	Front Axle Left & Right Lower Inner	Hatchback RWD N46B20B/N46B20C		Control Arm Bushing	531936
	2007.03-2011.12	Front Axle	Hatchback RWD N46B20B/N46B20C		Suspension Repair Kit	S990004SK
	2007.03-2011.12	Front Axle Left	Hatchback RWD N46B20B/N46B20C		Rod Assembly	S100330
	2007.03-2011.12	Front Axle Left	Hatchback RWD N46B20B/N46B20C	length:370-390	Rod Assembly	S100330
	2007.03-2011.12	Front Axle Left	Hatchback RWD N46B20B/N46B20C		Rod Assembly	S100332
	2007.03-2011.12	Front Axle Left	Hatchback RWD N46B20B/N46B20C	length:347.5	Rod Assembly	S100332
	2007.03-2011.12	Front Axle Right	Hatchback RWD N46B20B/N46B20C		Rod Assembly	S100331
	2007.03-2011.12	Front Axle Right	Hatchback RWD N46B20B/N46B20C		Rod Assembly	S100333
	2007.03-2011.12	Front Axle Left & Right	Hatchback RWD N46B20B/N46B20C		Rod Assembly	S100333
	2007.03-2011.12	Front Axle Left & Right	Hatchback RWD N46B20B/N46B20C		Tie Rod Axle Joint	S030350
	2007.03-2011.12	Front Axle Left & Right	Hatchback RWD N46B20B/N46B20C		Tie Rod Axle Joint	S030847
	2007.03-2011.12	Front Axle Left	Hatchback RWD N46B20B/N46B20C		Tie Rod End	S070045
	2007.03-2011.12	Front Axle Right	Hatchback RWD N46B20B/N46B20C		Tie Rod End	S070046
	2007.03-2011.12	Front Axle Left	Hatchback RWD N46B20B/N46B20C		Rod/Strut, stabiliser	S050068
	2007.03-2011.12	Front Axle Right	Hatchback RWD N46B20B/N46B20C		Rod/Strut, stabiliser	S050069
	2007.03-2011.12	Rear Axle Left & Right	Hatchback RWD N46B20B/N46B20C	L:160mm	Rod/Strut, stabiliser	S050070
	2007.03-2011.12	Rear Axle Left & Right	Hatchback RWD N46B20B/N46B20C	L:161mm	Rod/Strut, stabiliser	S051405
	2007.03-2011.12	Front Axle	Hatchback RWD N46B20B/N46B20C		Stabiliser Bushing	519357
	2007.03-2011.12	Rear Axle	Hatchback RWD N46B20B/N46B20C		Stabiliser Bushing	530239
	2007.03-2011.12	Rear Axle	Hatchback RWD N46B20B/N46B20C	Inner Diameter:13mm	Stabiliser Bushing	535302
	2007.03-2011.12	Rear Axle	Hatchback RWD N46B20B/N46B20C	Inner Diameter:11.1mm	Stabiliser Bushing	535307
2.0 (135 kw)	2016.07-	Front Axle Left Lower Inner	Hatchback RWD B48B20A		Track Control Arm	S061616
	2016.07-	Front Axle Left Lower Outer	Hatchback RWD B48B20A		Track Control Arm	S061614
	2016.07-	Front Axle Right Lower Inner	Hatchback RWD B48B20A		Track Control Arm	S061617
	2016.07-	Front Axle Right Lower Outer	Hatchback RWD B48B20A		Track Control Arm	S061615
	2016.07-	Rear Axle Left Upper Inner	Hatchback RWD B48B20A		Track Control Arm	S061775
	2016.07-	Rear Axle Right Upper Inner	Hatchback RWD B48B20A		Track Control Arm	S061776
	2016.07-	Rear Axle Left & Right Lower Inner	Hatchback RWD B48B20A		Track Control Arm	S061773
	2016.07-	Rear Axle Left & Right Lower Outer	Hatchback RWD B48B20A		Track Control Arm	S061774
	2016.07-	Front Axle Left & Right Lower Inner	Hatchback RWD B48B20A		Control Arm Bushing	532583
	2016.07-	Front Axle Left & Right Lower Outer	Hatchback RWD B48B20A		Control Arm Bushing	533483
	2016.07-	Front Axle Left	Hatchback RWD B48B20A	for vehicles with Adaptive Drive	Rod/Strut, stabiliser	S051259
	2016.07-	Front Axle Left	Hatchback RWD B48B20A	for vehicles with M-technology	Rod/Strut, stabiliser	S051353
	2016.07-	Front Axle Right	Hatchback RWD B48B20A		Rod/Strut, stabiliser	S051260
	2016.07-	Front Axle Left & Right	Hatchback RWD B48B20A	for vehicles without Adaptive Drive	Rod/Strut, stabiliser	S051259
	2016.07-	Front Axle Left & Right	Hatchback RWD B48B20A	for vehicles with standard suspension	Rod/Strut, stabiliser	S051353
	2016.07-	Rear Axle Left	Hatchback RWD B48B20A		Rod/Strut, stabiliser	S051261
	2016.07-	Rear Axle Right	Hatchback RWD B48B20A		Rod/Strut, stabiliser	S051262
120i Cabrio						
2.0 (115 kw)	2008.03-2013.12	Front Axle Left Lower Inner	Cabriolet RWD N46B20B/N46B20C		Track Control Arm	S060087
	2008.03-2013.12	Front Axle Left Lower Inner	Cabriolet RWD N46B20B/N46B20C		Track Control Arm	S062657
	2008.03-2013.12	Front Axle Left Lower Outer	Cabriolet RWD N46B20B/N46B20C		Track Control Arm	S060085
	2008.03-2013.12	Front Axle Right Lower Inner	Cabriolet RWD N46B20B/N46B20C		Track Control Arm	S060088
	2008.03-2013.12	Front Axle Right Lower Inner	Cabriolet RWD N46B20B/N46B20C		Track Control Arm	S062658
	2008.03-2013.12	Front Axle Right Lower Outer	Cabriolet RWD N46B20B/N46B20C		Track Control Arm	S060086



	 YEAR	FITTING POSITION	BODY STYLE & DRIVE TYPE & ENGINE	REMARKS	PRODUCT	GSP Ref.
BMW						
120i Cabrio						
2.0 (115 kw)	2008.03-2013.12	Rear Axle Left Centre	Cabriolet RWD N46B20B/N46B20C		Track Control Arm	S063116
	2008.03-2013.12	Rear Axle Right Centre	Cabriolet RWD N46B20B/N46B20C		Track Control Arm	S063115
	2008.03-2013.12	Rear Axle Left & Right Centre	Cabriolet RWD N46B20B/N46B20C		Track Control Arm	S060089
	2008.03-2013.12	Rear Axle Left & Right Upper	Cabriolet RWD N46B20B/N46B20C		Track Control Arm	S062839
	2008.03-2013.12	Front Axle Left & Right Lower Inner	Cabriolet RWD N46B20B/N46B20C		Control Arm Bushing	531936
	2008.03-2013.12	Front Axle	Cabriolet RWD N46B20B/N46B20C		Suspension Repair Kit	S990004SK
	2008.03-2013.12	Front Axle Left	Cabriolet RWD N46B20B/N46B20C		Rod Assembly	S100330
	2008.03-2013.12	Front Axle Left	Cabriolet RWD N46B20B/N46B20C		Rod Assembly	S100332
	2008.03-2013.12	Front Axle Right	Cabriolet RWD N46B20B/N46B20C		Rod Assembly	S100331
	2008.03-2013.12	Front Axle Right	Cabriolet RWD N46B20B/N46B20C		Rod Assembly	S100333
	2008.03-2013.12	Front Axle Left & Right	Cabriolet RWD N46B20B/N46B20C		Tie Rod Axle Joint	S030350
	2008.03-2013.12	Front Axle Left & Right	Cabriolet RWD N46B20B/N46B20C		Tie Rod Axle Joint	S030847
	2008.03-2013.12	Front Axle Left	Cabriolet RWD N46B20B/N46B20C		Tie Rod End	S070045
	2008.03-2013.12	Front Axle Right	Cabriolet RWD N46B20B/N46B20C		Tie Rod End	S070046
	2008.03-2013.12	Front Axle Left	Cabriolet RWD N46B20B/N46B20C		Rod/Strut, stabiliser	S050068
	2008.03-2013.12	Front Axle Right	Cabriolet RWD N46B20B/N46B20C		Rod/Strut, stabiliser	S050069
	2008.03-2013.12	Rear Axle Left & Right	Cabriolet RWD N46B20B/N46B20C		Rod/Strut, stabiliser	S050070
	2008.03-2013.12	Front Axle	Cabriolet RWD N46B20B/N46B20C		Stabiliser Bushing	519357
	2008.03-2013.12	Rear Axle	Cabriolet RWD N46B20B/N46B20C		Stabiliser Bushing	530239
	2008.03-2013.12	Rear Axle	Cabriolet RWD N46B20B/N46B20C	Inner Diameter:13mm	Stabiliser Bushing	535302
	2008.03-2013.12	Rear Axle	Cabriolet RWD N46B20B/N46B20C	Inner Diameter:11.1mm	Stabiliser Bushing	535307
125i						
2.0 (160 kw)	2012.03-2017.11	Front Axle Left Lower Inner	Hatchback RWD N20B20A		Track Control Arm	S061616
	2012.03-2017.11	Front Axle Left Lower Outer	Hatchback RWD N20B20A		Track Control Arm	S061614
	2012.03-2017.11	Front Axle Right Lower Inner	Hatchback RWD N20B20A		Track Control Arm	S061617
	2012.03-2017.11	Front Axle Right Lower Outer	Hatchback RWD N20B20A		Track Control Arm	S061615
	2012.03-2017.11	Rear Axle Left Upper Inner	Hatchback RWD N20B20A		Track Control Arm	S061775
	2012.03-2017.11	Rear Axle Right Upper Inner	Hatchback RWD N20B20A		Track Control Arm	S061776
	2012.03-2017.11	Rear Axle Left & Right Lower Inner	Hatchback RWD N20B20A		Track Control Arm	S061773
	2012.03-2017.11	Rear Axle Left & Right Lower Outer	Hatchback RWD N20B20A		Track Control Arm	S061774
	2012.03-2017.11	Front Axle Left & Right Lower Inner	Hatchback RWD N20B20A		Control Arm Bushing	532583
	2012.03-2017.11	Front Axle Left & Right Lower Outer	Hatchback RWD N20B20A		Control Arm Bushing	533483
	2012.03-2017.11	Front Axle Left	Hatchback RWD N20B20A	for vehicles with Adaptive Drive	Rod/Strut, stabiliser	S051259
	2012.03-2017.11	Front Axle Left	Hatchback RWD N20B20A	for vehicles with M-technology	Rod/Strut, stabiliser	S051353
	2012.03-2017.11	Front Axle Right	Hatchback RWD N20B20A		Rod/Strut, stabiliser	S051260
	2012.03-2017.11	Front Axle Left & Right	Hatchback RWD N20B20A	for vehicles without Adaptive Drive	Rod/Strut, stabiliser	S051259
	2012.03-2017.11	Front Axle Left & Right	Hatchback RWD N20B20A	for vehicles with standard suspension	Rod/Strut, stabiliser	S051353
	2012.03-2017.11	Rear Axle Left	Hatchback RWD N20B20A		Rod/Strut, stabiliser	S051261
	2012.03-2017.11	Rear Axle Right	Hatchback RWD N20B20A		Rod/Strut, stabiliser	S051262
	2014.08-	Rear Axle	Hatchback RWD N20B20A		Stabiliser Bushing	535598
	2014.11-2017.11	Front Axle Left Lower Inner	Hatchback RWD N20B20A		Track Control Arm	S061616
	2014.11-2017.11	Front Axle Left Lower Outer	Hatchback RWD N20B20A		Track Control Arm	S061614
	2014.11-2017.11	Front Axle Right Lower Inner	Hatchback RWD N20B20A		Track Control Arm	S061617
	2014.11-2017.11	Front Axle Right Lower Outer	Hatchback RWD N20B20A		Track Control Arm	S061615
	2014.11-2017.11	Rear Axle Left Upper Inner	Hatchback RWD N20B20A		Track Control Arm	S061775
	2014.11-2017.11	Rear Axle Right Upper Inner	Hatchback RWD N20B20A		Track Control Arm	S061776
	2014.11-2017.11	Rear Axle Left & Right Lower Inner	Hatchback RWD N20B20A		Track Control Arm	S061773
	2014.11-2017.11	Rear Axle Left & Right Lower Outer	Hatchback RWD N20B20A		Track Control Arm	S061774
	2014.11-2017.11	Front Axle Left & Right Lower Inner	Hatchback RWD N20B20A		Control Arm Bushing	532583
	2014.11-2017.11	Front Axle Left & Right Lower Outer	Hatchback RWD N20B20A		Control Arm Bushing	533483
	2014.11-2017.11	Front Axle Left	Hatchback RWD N20B20A		Rod Assembly	S100350
	2014.11-2017.11	Front Axle Right	Hatchback RWD N20B20A		Rod Assembly	S100351
	2014.11-2017.11	Front Axle Left & Right	Hatchback RWD N20B20A		Tie Rod Axle Joint	S031029
	2014.11-2017.11	Front Axle Left	Hatchback RWD N20B20A		Tie Rod End	S071700
	2014.11-2017.11	Front Axle Right	Hatchback RWD N20B20A	Length:145mm	Tie Rod End	S071701
	2014.11-2017.11	Front Axle Left	Hatchback RWD N20B20A		Rod/Strut, stabiliser	S051353
	2014.11-2017.11	Front Axle Right	Hatchback RWD N20B20A		Rod/Strut, stabiliser	S051260
	2014.11-2017.11	Front Axle Left & Right	Hatchback RWD N20B20A		Rod/Strut, stabiliser	S051259
	2014.11-2017.11	Front Axle Left & Right	Hatchback RWD N20B20A	for vehicles with standard suspension	Rod/Strut, stabiliser	S051353
	2014.11-2017.11	Rear Axle Left	Hatchback RWD N20B20A		Rod/Strut, stabiliser	S051261
	2014.11-2017.11	Rear Axle Right	Hatchback RWD N20B20A		Rod/Strut, stabiliser	S051262
2.0 (165 kw)	2016.07-2019.06	Front Axle Left Lower Inner	Hatchback RWD B48B20B		Track Control Arm	S061616
	2016.07-2019.06	Front Axle Left Lower Outer	Hatchback RWD B48B20B		Track Control Arm	S061614
	2016.07-2019.06	Front Axle Right Lower Inner	Hatchback RWD B48B20B		Track Control Arm	S061617



	 YEAR	FITTING POSITION	BODY STYLE & DRIVE TYPE & ENGINE	REMARKS	PRODUCT	GSP Ref.
BMW						
125i						
2.0 (165 kw)	2016.07-2019.06	Front Axle Right Lower Outer	Hatchback RWD B48B20B		Track Control Arm	S061615
	2016.07-2019.06	Rear Axle Left Upper Inner	Hatchback RWD B48B20B		Track Control Arm	S061775
	2016.07-2019.06	Rear Axle Right Upper Inner	Hatchback RWD B48B20B		Track Control Arm	S061776
	2016.07-2019.06	Rear Axle Left & Right Lower Inner	Hatchback RWD B48B20B		Track Control Arm	S061773
	2016.07-2019.06	Rear Axle Left & Right Lower Outer	Hatchback RWD B48B20B		Track Control Arm	S061774
	2016.07-2019.06	Front Axle Left & Right Lower Inner	Hatchback RWD B48B20B		Control Arm Bushing	532583
	2016.07-2019.06	Front Axle Left & Right Lower Outer	Hatchback RWD B48B20B		Control Arm Bushing	533483
	2016.07-2019.06	Front Axle Left	Hatchback RWD B48B20B	for vehicles with Adaptive Drive	Rod/Strut, stabiliser	S051259
	2016.07-2019.06	Front Axle Left	Hatchback RWD B48B20B	for vehicles with M-technology	Rod/Strut, stabiliser	S051353
	2016.07-2019.06	Front Axle Right	Hatchback RWD B48B20B		Rod/Strut, stabiliser	S051260
	2016.07-2019.06	Front Axle Left & Right	Hatchback RWD B48B20B	for vehicles without Adaptive Drive	Rod/Strut, stabiliser	S051259
	2016.07-2019.06	Front Axle Left & Right	Hatchback RWD B48B20B	for vehicles with standard suspension	Rod/Strut, stabiliser	S051353
	2016.07-2019.06	Rear Axle Left	Hatchback RWD B48B20B		Rod/Strut, stabiliser	S051261
	2016.07-2019.06	Rear Axle Right	Hatchback RWD B48B20B		Rod/Strut, stabiliser	S051262
130i						
3.0 (195 kw)	2005.09-2007.02	Front Axle Left Lower Inner	Hatchback RWD N52B30A/N52B30BF		Track Control Arm	S060087
	2005.09-2007.02	Front Axle Left Lower Inner	Hatchback RWD N52B30A/N52B30BF		Track Control Arm	S062657
	2005.09-2007.02	Front Axle Left Lower Outer	Hatchback RWD N52B30A/N52B30BF		Track Control Arm	S060085
	2005.09-2007.02	Front Axle Right Lower Inner	Hatchback RWD N52B30A/N52B30BF		Track Control Arm	S060088
	2005.09-2007.02	Front Axle Right Lower Inner	Hatchback RWD N52B30A/N52B30BF		Track Control Arm	S062658
	2005.09-2007.02	Front Axle Right Lower Outer	Hatchback RWD N52B30A/N52B30BF		Track Control Arm	S060086
	2005.09-2007.02	Rear Axle Left Centre	Hatchback RWD N52B30A/N52B30BF		Track Control Arm	S063116
	2005.09-2007.02	Rear Axle Right Centre	Hatchback RWD N52B30A/N52B30BF		Track Control Arm	S063115
	2005.09-2007.02	Rear Axle Left & Right Centre	Hatchback RWD N52B30A/N52B30BF		Track Control Arm	S060089
	2005.09-2007.02	Rear Axle Left & Right Upper	Hatchback RWD N52B30A/N52B30BF		Track Control Arm	S062839
	2005.09-2007.02	Rear Axle Left & Right Lower Outer	Hatchback RWD N52B30A/N52B30BF		Track Control Arm	S060091
	2005.09-2007.02	Front Axle Left & Right Lower Inner	Hatchback RWD N52B30A/N52B30BF		Control Arm Bushing	531936
	2005.09-2007.02	Front Axle	Hatchback RWD N52B30A/N52B30BF		Suspension Repair Kit	S990004SK
	2005.09-2007.02	Front Axle Left	Hatchback RWD N52B30A/N52B30BF		Rod Assembly	S100330
	2005.09-2007.02	Front Axle Left	Hatchback RWD N52B30A/N52B30BF		Rod Assembly	S100332
	2005.09-2007.02	Front Axle Right	Hatchback RWD N52B30A/N52B30BF		Rod Assembly	S100331
	2005.09-2007.02	Front Axle Right	Hatchback RWD N52B30A/N52B30BF		Rod Assembly	S100333
	2005.09-2007.02	Front Axle Left & Right	Hatchback RWD N52B30A/N52B30BF		Tie Rod Axle Joint	S030350
	2005.09-2007.02	Front Axle Left & Right	Hatchback RWD N52B30A/N52B30BF		Tie Rod Axle Joint	S030847
	2005.09-2007.02	Front Axle Left	Hatchback RWD N52B30A/N52B30BF		Tie Rod End	S070045
	2005.09-2007.02	Front Axle Right	Hatchback RWD N52B30A/N52B30BF		Tie Rod End	S070046
	2005.09-2007.02	Front Axle Left	Hatchback RWD N52B30A/N52B30BF		Rod/Strut, stabiliser	S050068
	2005.09-2007.02	Front Axle Right	Hatchback RWD N52B30A/N52B30BF		Rod/Strut, stabiliser	S050069
	2005.09-2007.02	Rear Axle Left & Right	Hatchback RWD N52B30A/N52B30BF		Rod/Strut, stabiliser	S050070
	2005.09-2007.02	Front Axle	Hatchback RWD N52B30A/N52B30BF		Stabiliser Bushing	519357
	2005.09-2007.02	Front Axle	Hatchback RWD N52B30A/N52B30BF		Stabiliser Bushing	530239
	2005.09-2007.02	Rear Axle	Hatchback RWD N52B30A/N52B30BF		Stabiliser Bushing	535302
	2005.09-2007.02	Rear Axle	Hatchback RWD N52B30A/N52B30BF		Stabiliser Bushing	535307
	2007.03-2012.09	Front Axle Left Lower Inner	Hatchback RWD N52B30A/N52B30B/N52B30BF	Date from:2007.03	Track Control Arm	S060087
	2007.03-2012.09	Front Axle Left Lower Inner	Hatchback RWD N52B30A/N52B30B/N52B30BF		Track Control Arm	S062657
	2007.03-2012.09	Front Axle Left Lower Outer	Hatchback RWD N52B30A/N52B30B/N52B30BF		Track Control Arm	S060085
	2007.03-2012.09	Front Axle Right Lower Inner	Hatchback RWD N52B30A/N52B30B/N52B30BF	Date from:2007.03	Track Control Arm	S060088
	2007.03-2012.09	Front Axle Right Lower Inner	Hatchback RWD N52B30A/N52B30B/N52B30BF		Track Control Arm	S062658
	2007.03-2012.09	Front Axle Right Lower Outer	Hatchback RWD N52B30A/N52B30B/N52B30BF		Track Control Arm	S060086
	2007.03-2012.09	Rear Axle Left Centre	Hatchback RWD N52B30A/N52B30B/N52B30BF		Track Control Arm	S063116
	2007.03-2012.09	Rear Axle Right Centre	Hatchback RWD N52B30A/N52B30B/N52B30BF		Track Control Arm	S063115
	2007.03-2012.09	Rear Axle Left & Right Centre	Hatchback RWD N52B30A/N52B30B/N52B30BF		Track Control Arm	S060089
	2007.03-2012.09	Rear Axle Left & Right Upper	Hatchback RWD N52B30A/N52B30B/N52B30BF		Track Control Arm	S062839
	2007.03-2012.09	Front Axle Left & Right Lower Inner	Hatchback RWD N52B30A/N52B30B/N52B30BF		Control Arm Bushing	531936
	2007.03-2012.09	Front Axle	Hatchback RWD N52B30A/N52B30B/N52B30BF		Suspension Repair Kit	S990004SK
	2007.03-2012.09	Front Axle Left	Hatchback RWD N52B30A/N52B30B/N52B30BF		Rod Assembly	S100330
	2007.03-2012.09	Front Axle Right	Hatchback RWD N52B30A/N52B30B/N52B30BF		Rod Assembly	S100331
	2007.03-2012.09	Front Axle Left & Right	Hatchback RWD N52B30A/N52B30B/N52B30BF		Tie Rod Axle Joint	S030350
	2007.03-2012.09	Front Axle Left	Hatchback RWD N52B30A/N52B30B/N52B30BF		Tie Rod End	S070045
	2007.03-2012.09	Front Axle Right	Hatchback RWD N52B30A/N52B30B/N52B30BF		Tie Rod End	S070046
	2007.03-2012.09	Front Axle Left	Hatchback RWD N52B30A/N52B30B/N52B30BF		Rod/Strut, stabiliser	S050068
	2007.03-2012.09	Front Axle Right	Hatchback RWD N52B30A/N52B30B/N52B30BF		Rod/Strut, stabiliser	S050069
	2007.03-2012.09	Rear Axle Left & Right	Hatchback RWD N52B30A/N52B30B/N52B30BF	L:160mm	Rod/Strut, stabiliser	S050070
	2007.03-2012.09	Rear Axle Left & Right	Hatchback RWD N52B30A/N52B30B/N52B30BF	L:161mm	Rod/Strut, stabiliser	S051405



	 YEAR	FITTING POSITION	BODY STYLE & DRIVE TYPE & ENGINE	REMARKS	PRODUCT	GSP Ref.	
BMW 130i							
3.0 (195 kw)	2007.03-2012.09	Front Axle	Hatchback RWD N52B30A/N52B30B/N52B30BF		Stabiliser Bushing	519357	
	2007.03-2012.09	Rear Axle	Hatchback RWD N52B30A/N52B30B/N52B30BF		Stabiliser Bushing	530239	
	2007.03-2012.09	Rear Axle	Hatchback RWD N52B30A/N52B30B/N52B30BF		Stabiliser Bushing	535302	
135i Coupe							
3.0 (225 kw)	2007.09-2013.10	Front Axle Left Lower Inner	Coupe RWD N54B30A/N55B30A	For OE no.31126763699	Track Control Arm	S060087	
	2007.09-2013.10	Front Axle Left Lower Inner	Coupe RWD N54B30A/N55B30A	For OE no.31122405859	Track Control Arm	S062657	
	2007.09-2013.10	Front Axle Left Lower Outer	Coupe RWD N54B30A/N55B30A		Track Control Arm	S060085	
	2007.09-2013.10	Front Axle Right Lower Inner	Coupe RWD N54B30A/N55B30A		Track Control Arm	S060088	
	2007.09-2013.10	Front Axle Right Lower Inner	Coupe RWD N54B30A/N55B30A		Track Control Arm	S062658	
	2007.09-2013.10	Front Axle Right Lower Inner	Coupe RWD N54B30A/N55B30A	For OE no.31102283578	Track Control Arm	S063258	
	2007.09-2013.10	Front Axle Right Lower Outer	Coupe RWD N54B30A/N55B30A		Track Control Arm	S060086	
	2007.09-2013.10	Rear Axle Left Centre	Coupe RWD N54B30A/N55B30A		Track Control Arm	S063116	
	2007.09-2013.10	Rear Axle Right Centre	Coupe RWD N54B30A/N55B30A		Track Control Arm	S063115	
	2007.09-2013.10	Rear Axle Left & Right Centre	Coupe RWD N54B30A/N55B30A		Track Control Arm	S060089	
	2007.09-2013.10	Front Axle Left & Right Lower Inner	Coupe RWD N54B30A/N55B30A		Control Arm Bushing	531936	
	2007.09-2013.10	Front Axle	Coupe RWD N54B30A/N55B30A		Suspension Repair Kit	S990004SK	
	2007.09-2013.10	Front Axle Left	Coupe RWD N54B30A/N55B30A		Rod Assembly	S100330	
	2007.09-2013.10	Front Axle Right	Coupe RWD N54B30A/N55B30A		Rod Assembly	S100331	
	2007.09-2013.10	Front Axle Left & Right	Coupe RWD N54B30A/N55B30A		Tie Rod Axle Joint	S030350	
	2007.09-2013.10	Front Axle Left	Coupe RWD N54B30A/N55B30A		Tie Rod End	S070045	
	2007.09-2013.10	Front Axle Right	Coupe RWD N54B30A/N55B30A		Tie Rod End	S070046	
	2007.09-2013.10	Front Axle Left	Coupe RWD N54B30A/N55B30A		Rod/Strut, stabiliser	S050068	
	2007.09-2013.10	Front Axle Right	Coupe RWD N54B30A/N55B30A		Rod/Strut, stabiliser	S050069	
	2007.09-2013.10	Rear Axle Left & Right	Coupe RWD N54B30A/N55B30A	L:160mm	Rod/Strut, stabiliser	S050070	
	2007.09-2013.10	Rear Axle Left & Right	Coupe RWD N54B30A/N55B30A	L:161mm	Rod/Strut, stabiliser	S051405	
	2007.09-2013.10	Front Axle	Coupe RWD N54B30A/N55B30A		Stabiliser Bushing	519357	
	2007.09-2013.10	Rear Axle	Coupe RWD N54B30A/N55B30A		Stabiliser Bushing	530239	
	2007.09-2013.10	Rear Axle	Coupe RWD N54B30A/N55B30A		Stabiliser Bushing	535307	
	218i Gran Coupe						
	1.5 (103 kw)	2019.11-	Rear Axle Left & Right Upper	Coupe FWD B38A15A		Track Control Arm	S063055
		2019.11-	Front Axle Left & Right	Coupe FWD B38A15A		Tie Rod Axle Joint	S030988
2019.11-		Front Axle Left & Right	Coupe FWD B38A15A		Rod/Strut, stabiliser	S051334	
2019.11-		Rear Axle Left & Right	Coupe FWD B38A15A		Rod/Strut, stabiliser	S051243	
225i Active Tourer							
2.0 (170 kw)	2014.09-	Front Axle Left Lower	MPV FWD B48A20B		Track Control Arm	S062840	
	2014.09-	Front Axle Right Lower	MPV FWD B48A20B		Track Control Arm	S062837	
	2014.09-	Rear Axle Left & Right Lower	MPV FWD B48A20B		Track Control Arm	S062800	
	2014.09-	Rear Axle Left & Right Upper	MPV FWD B48A20B		Track Control Arm	S063055	
	2014.09-	Front Axle Left	MPV FWD B48A20B		Rod Assembly	S100410	
	2014.09-	Front Axle Right	MPV FWD B48A20B		Rod Assembly	S100409	
	2014.09-	Front Axle Left & Right	MPV FWD B48A20B		Tie Rod Axle Joint	S030988	
	2014.09-	Front Axle Left & Right	MPV FWD B48A20B		Rod/Strut, stabiliser	S051334	
2014.09-	Rear Axle Left & Right	MPV FWD B48A20B		Rod/Strut, stabiliser	S051243		
228i xDrive Gran Coupe							
2.0 (170 kw)	2019.11-	Front Axle Left Lower	Coupe AWD B46A20B		Control Arm Bushing	535630	
	2019.11-	Front Axle Right Lower	Coupe AWD B46A20B		Control Arm Bushing	535628	
316i							
1.6 (73 kw)	1991.03-1993.08	Front Axle Left Lower	Saloon RWD M40B164E1		Track Control Arm	S060114	
	1991.03-1993.08	Front Axle Right Lower	Saloon RWD M40B164E1		Track Control Arm	S060113	
	1991.03-1993.08	Rear Axle Left & Right Lower Inner	Saloon RWD M40B164E1		Track Control Arm	S060098	
	1991.03-1993.08	Front Axle Left & Right Lower	Saloon RWD M40B164E1		Ball Joint	S080020	
	1991.03-1993.08	Front Axle Left & Right Lower	Saloon RWD M40B164E1		Ball Joint	S080025	
	1991.03-1993.08	Front Axle Left Lower	Saloon RWD M40B164E1		Control Arm Bushing	518074	
	1991.03-1993.08	Front Axle Right Lower	Saloon RWD M40B164E1		Control Arm Bushing	518073	
	1991.03-1993.08	Front Axle Left & Right Lower	Saloon RWD M40B164E1		Control Arm Bushing	511593	
	1991.03-1993.08	Rear Axle Left & Right Upper	Saloon RWD M40B164E1		Control Arm Bushing	512710	
	1991.03-1993.08	Rear Axle Left & Right Lower Inner	Saloon RWD M40B164E1		Control Arm Bushing	512305	
	1991.03-1993.08	Front Axle Left & Right Lower	Saloon RWD M40B164E1		Control Arm Bushing Kit	530751S	
	1991.03-1993.08	Front Axle Left	Saloon RWD M40B164E1		Rod Assembly	S100029	
	1991.03-1993.08	Front Axle Right	Saloon RWD M40B164E1		Rod Assembly	S100030	
	1991.03-1993.08	Front Axle Left & Right	Saloon RWD M40B164E1		Tie Rod Axle Joint	S030777	
	1991.03-1993.08	Front Axle Left	Saloon RWD M40B164E1		Tie Rod End	S070054	
	1991.03-1993.08	Front Axle Right	Saloon RWD M40B164E1		Tie Rod End	S070055	
	1991.03-1993.08	Front Axle Left & Right	Saloon RWD M40B164E1		Rod/Strut, stabiliser	S050077	



	 YEAR	FITTING POSITION	BODY STYLE & DRIVE TYPE & ENGINE	REMARKS	PRODUCT	GSP Ref.
BMW 316i						
1.6 (73 kw)	1991.03-1993.08	Front Axle Left & Right	Saloon RWD M40B164E1	Date to:1991.10	Rod/Strut,stabiliser	S050078
	1991.03-1993.08	Rear Axle Left & Right	Saloon RWD M40B164E1		Rod/Strut,stabiliser	S050058
	1991.03-1993.08	Front Axle	Saloon RWD M40B164E1		Steering Boot	540041
	1991.03-1993.08	Front Axle	Saloon RWD M40B164E1		Steering Boot	540186
	1991.03-1993.08	Front Axle	Saloon RWD M40B164E1		Steering Rack Bellow Kit	540191S
1.6 (75 kw)	1993.09-1998.05	Front Axle Left Lower	Saloon RWD M43B164E2		Track Control Arm	S060114
	1993.09-1998.05	Front Axle Right Lower	Saloon RWD M43B164E2		Track Control Arm	S060113
	1993.09-1998.05	Rear Axle Left & Right Lower Inner	Saloon RWD M43B164E2		Track Control Arm	S060098
	1993.09-1998.05	Front Axle Left & Right Lower	Saloon RWD M43B164E2		Ball Joint	S080020
	1993.09-1998.05	Front Axle Left & Right Lower	Saloon RWD M43B164E2		Ball Joint	S080025
	1993.09-1998.05	Front Axle Left Lower	Saloon RWD M43B164E2		Control Arm Bushing	518074
	1993.09-1998.05	Front Axle Right Lower	Saloon RWD M43B164E2		Control Arm Bushing	518073
	1993.09-1998.05	Front Axle Left & Right Lower	Saloon RWD M43B164E2		Control Arm Bushing	511593
	1993.09-1998.05	Rear Axle Left & Right Upper	Saloon RWD M43B164E2		Control Arm Bushing	512710
	1993.09-1998.05	Rear Axle Left & Right Lower Inner	Saloon RWD M43B164E2		Control Arm Bushing	512305
	1993.09-1998.05	Front Axle Left & Right Lower	Saloon RWD M43B164E2		Control Arm Bushing Kit	530751S
	1993.09-1998.05	Front Axle Left	Saloon RWD M43B164E2		Rod Assembly	S100029
	1993.09-1998.05	Front Axle Right	Saloon RWD M43B164E2		Rod Assembly	S100030
	1993.09-1998.05	Front Axle Left & Right	Saloon RWD M43B164E2		Tie Rod Axle Joint	S030777
	1993.09-1998.05	Front Axle Left	Saloon RWD M43B164E2		Tie Rod End	S070054
	1993.09-1998.05	Front Axle Right	Saloon RWD M43B164E2		Tie Rod End	S070055
	1993.09-1998.05	Front Axle Left & Right	Saloon RWD M43B164E2		Rod/Strut,stabiliser	S050077
	1993.09-1998.05	Rear Axle Left & Right	Saloon RWD M43B164E2		Rod/Strut,stabiliser	S050058
	1993.09-1998.05	Front Axle	Saloon RWD M43B164E2		Steering Boot	540041
	1993.09-1998.05	Front Axle	Saloon RWD M43B164E2		Steering Boot	540186
	1993.09-1998.05	Front Axle	Saloon RWD M43B164E2		Steering Rack Bellow Kit	540191S
1.6 (100 kw)	2012.07-2016.08	Front Axle Left Lower Inner	Saloon RWD N13B16A	For OE no.31 12 6 852 991	Track Control Arm	S061616
	2012.07-2016.08	Front Axle Left Lower Inner	Saloon RWD N13B16A		Track Control Arm	S063250
	2012.07-2016.08	Front Axle Left Lower Outer	Saloon RWD N13B16A	For OE no.31126851259	Track Control Arm	S061614
	2012.07-2016.08	Front Axle Left Lower Outer	Saloon RWD N13B16A		Track Control Arm	S063254
	2012.07-2016.08	Front Axle Right Lower Inner	Saloon RWD N13B16A		Track Control Arm	S061617
	2012.07-2016.08	Front Axle Right Lower Outer	Saloon RWD N13B16A	For OE no.31126851260	Track Control Arm	S061615
	2012.07-2016.08	Front Axle Right Lower Outer	Saloon RWD N13B16A		Track Control Arm	S063243
	2012.07-2016.08	Rear Axle Left Upper Inner	Saloon RWD N13B16A		Track Control Arm	S061775
	2012.07-2016.08	Rear Axle Right Upper Inner	Saloon RWD N13B16A		Track Control Arm	S061776
	2012.07-2016.08	Rear Axle Left & Right Lower Inner	Saloon RWD N13B16A		Track Control Arm	S061773
	2012.07-2016.08	Rear Axle Left & Right Lower Outer	Saloon RWD N13B16A		Track Control Arm	S061774
	2012.07-2016.08	Front Axle Left & Right Lower Inner	Saloon RWD N13B16A		Control Arm Bushing	532583
	2012.07-2016.08	Front Axle Left & Right Lower Outer	Saloon RWD N13B16A		Control Arm Bushing	533483
	2012.07-2016.08	Front Axle Left	Saloon RWD N13B16A	for vehicles with Adaptive Drive	Rod/Strut,stabiliser	S051259
	2012.07-2016.08	Front Axle Left	Saloon RWD N13B16A	for vehicles with M-Technology for vehicles with electronic suspension control	Rod/Strut,stabiliser	S051353
	2012.07-2016.08	Front Axle Right	Saloon RWD N13B16A		Rod/Strut,stabiliser	S051260
	2012.07-2016.08	Front Axle Left & Right	Saloon RWD N13B16A	for vehicles without Adaptive Drive	Rod/Strut,stabiliser	S051259
	2012.07-2016.08	Front Axle Left & Right	Saloon RWD N13B16A	for vehicles with standard suspension for vehicles without electronic suspension control	Rod/Strut,stabiliser	S051353
	2012.07-2016.08	Rear Axle Left	Saloon RWD N13B16A		Rod/Strut,stabiliser	S051261
	2012.07-2016.08	Rear Axle Right	Saloon RWD N13B16A		Rod/Strut,stabiliser	S051262
316i Touring						
1.6 (75 kw)	1991.09-1994.06	Front Axle Left Lower	Estate RWD M40B164E1		Track Control Arm	S060112
	1991.09-1994.06	Front Axle Right Lower	Estate RWD M40B164E1		Track Control Arm	S060111
	1991.09-1994.06	Front Axle Left & Right Lower	Estate RWD M40B164E1		Ball Joint	S080020
	1991.09-1994.06	Front Axle Right	Estate RWD M40B164E1		Rod Assembly	S100023
	1991.09-1994.06	Front Axle Left & Right	Estate RWD M40B164E1		Rod Assembly	S100022
	1991.09-1994.06	Front Axle Right	Estate RWD M40B164E1		Tie Rod Axle Joint	S030334
	1991.09-1994.06	Front Axle Left & Right	Estate RWD M40B164E1		Tie Rod Axle Joint	S030014
	1991.09-1994.06	Front Axle Left & Right	Estate RWD M40B164E1		Tie Rod End	S070052
	1991.09-1994.06	Front Axle Left & Right	Estate RWD M40B164E1		Rod/Strut,stabiliser	S050077
	1991.09-1994.06	Front Axle	Estate RWD M40B164E1		Steering Boot	540022
	1991.09-1994.06	Front Axle	Estate RWD M40B164E1		Steering Boot	540041
	1991.09-1994.06	Front Axle	Estate RWD M40B164E1		Steering Rack Bellow Kit	540252S
318i						
1.8 (103 kw)	1993.09-1995.12	Front Axle Left Lower	Saloon RWD M42B184S1		Track Control Arm	S060114
	1993.09-1995.12	Front Axle Right Lower	Saloon RWD M42B184S1		Track Control Arm	S060113
	1993.09-1995.12	Rear Axle Left & Right Lower Inner	Saloon RWD M42B184S1		Track Control Arm	S060098
	1993.09-1995.12	Front Axle Left & Right Lower	Saloon RWD M42B184S1		Ball Joint	S080020



	 YEAR	FITTING POSITION	BODY STYLE & DRIVE TYPE & ENGINE	REMARKS	PRODUCT	GSP Ref.
BMW 318i						
1.8 (103 kw)	1993.09-1995.12	Front Axle Left & Right Lower	Saloon RWD M42B184S1		Ball Joint	S080025
	1993.09-1995.12	Front Axle Left Lower	Saloon RWD M42B184S1		Control Arm Bushing	518074
	1993.09-1995.12	Front Axle Right Lower	Saloon RWD M42B184S1		Control Arm Bushing	518073
	1993.09-1995.12	Front Axle Left & Right Lower	Saloon RWD M42B184S1		Control Arm Bushing	511593
	1993.09-1995.12	Rear Axle Left & Right Upper	Saloon RWD M42B184S1		Control Arm Bushing	512710
	1993.09-1995.12	Rear Axle Left & Right Lower Inner	Saloon RWD M42B184S1		Control Arm Bushing	512305
	1993.09-1995.12	Front Axle Left & Right Lower	Saloon RWD M42B184S1		Control Arm Bushing Kit	530751S
	1993.09-1995.12	Front Axle Left	Saloon RWD M42B184S1		Rod Assembly	S100029
	1993.09-1995.12	Front Axle Right	Saloon RWD M42B184S1		Rod Assembly	S100030
	1993.09-1995.12	Front Axle Left & Right	Saloon RWD M42B184S1		Tie Rod Axle Joint	S030777
	1993.09-1995.12	Front Axle Left	Saloon RWD M42B184S1		Tie Rod End	S070054
	1993.09-1995.12	Front Axle Right	Saloon RWD M42B184S1		Tie Rod End	S070055
	1993.09-1995.12	Front Axle Left & Right	Saloon RWD M42B184S1		Rod/Strut, stabiliser	S050077
	1993.09-1995.12	Rear Axle Left & Right	Saloon RWD M42B184S1		Rod/Strut, stabiliser	S050058
	1993.09-1995.12	Front Axle	Saloon RWD M42B184S1		Steering Boot	540041
	1993.09-1995.12	Front Axle	Saloon RWD M42B184S1		Steering Boot	540186
	1993.09-1995.12	Front Axle	Saloon RWD M42B184S1		Steering Rack Bellow Kit	540191S
318i Compact						
1.9 (103 kw)	1996.01-1999.01	Front Axle Left Lower	Hatchback RWD M44B194S1		Track Control Arm	S060114
	1996.01-1999.01	Front Axle Right Lower	Hatchback RWD M44B194S1		Track Control Arm	S060113
	1996.01-1999.01	Front Axle Left & Right Lower	Hatchback RWD M44B194S1		Ball Joint	S080020
	1996.01-1999.01	Front Axle Left & Right Lower	Hatchback RWD M44B194S1		Ball Joint	S080025
	1996.01-1999.01	Front Axle Left Lower	Hatchback RWD M44B194S1		Control Arm Bushing	518074
	1996.01-1999.01	Front Axle Right Lower	Hatchback RWD M44B194S1		Control Arm Bushing	518073
	1996.01-1999.01	Front Axle Left & Right Lower	Hatchback RWD M44B194S1		Control Arm Bushing	511593
	1996.01-1999.01	Front Axle Left & Right Lower	Hatchback RWD M44B194S1		Control Arm Bushing Kit	530751S
	1996.01-1999.01	Front Axle Left	Hatchback RWD M44B194S1		Rod Assembly	S100029
	1996.01-1999.01	Front Axle Right	Hatchback RWD M44B194S1		Rod Assembly	S100030
	1996.01-1999.01	Front Axle Left & Right	Hatchback RWD M44B194S1		Tie Rod Axle Joint	S030777
	1996.01-1999.01	Front Axle Left	Hatchback RWD M44B194S1		Tie Rod End	S070054
	1996.01-1999.01	Front Axle Right	Hatchback RWD M44B194S1		Tie Rod End	S070055
	1996.01-1999.01	Front Axle Left & Right	Hatchback RWD M44B194S1		Rod/Strut, stabiliser	S050077
	1996.01-1999.01	Rear Axle Left & Right	Hatchback RWD M44B194S1		Rod/Strut, stabiliser	520093
	1996.01-1999.01	Front Axle	Hatchback RWD M44B194S1		Steering Boot	540041
	1996.01-1999.01	Front Axle	Hatchback RWD M44B194S1		Steering Boot	540186
	1996.01-1999.01	Front Axle	Hatchback RWD M44B194S1		Steering Rack Bellow Kit	540191S
320i						
2.0 (110 kw)	2004.12-2007.08	Front Axle Left Lower Inner	Saloon RWD N46B20B/N46B20C/N46B20CB		Track Control Arm	S060087
	2004.12-2007.08	Front Axle Left Lower Inner	Saloon RWD N46B20B/N46B20C/N46B20CB		Track Control Arm	S062657
	2004.12-2007.08	Front Axle Left Lower Outer	Saloon RWD N46B20B/N46B20C/N46B20CB		Track Control Arm	S060085
	2004.12-2007.08	Front Axle Right Lower Inner	Saloon RWD N46B20B/N46B20C/N46B20CB		Track Control Arm	S060088
	2004.12-2007.08	Front Axle Right Lower Inner	Saloon RWD N46B20B/N46B20C/N46B20CB		Track Control Arm	S062658
	2004.12-2007.08	Front Axle Right Lower Outer	Saloon RWD N46B20B/N46B20C/N46B20CB		Track Control Arm	S060086
	2004.12-2007.08	Rear Axle Left Centre	Saloon RWD N46B20B/N46B20C/N46B20CB		Track Control Arm	S063116
	2004.12-2007.08	Rear Axle Right Centre	Saloon RWD N46B20B/N46B20C/N46B20CB		Track Control Arm	S063115
	2004.12-2007.08	Rear Axle Left & Right Centre	Saloon RWD N46B20B/N46B20C/N46B20CB		Track Control Arm	S060089
	2004.12-2007.08	Front Axle Left & Right Lower Inner	Saloon RWD N46B20B/N46B20C/N46B20CB		Control Arm Bushing	531936
	2004.12-2007.08	Front Axle	Saloon RWD N46B20B/N46B20C/N46B20CB		Suspension Repair Kit	S990004SK
	2004.12-2007.08	Front Axle Left	Saloon RWD N46B20B/N46B20C/N46B20CB		Rod Assembly	S100330
	2004.12-2007.08	Front Axle Left	Saloon RWD N46B20B/N46B20C/N46B20CB		Rod Assembly	S100332
	2004.12-2007.08	Front Axle Right	Saloon RWD N46B20B/N46B20C/N46B20CB		Rod Assembly	S100331
	2004.12-2007.08	Front Axle Right	Saloon RWD N46B20B/N46B20C/N46B20CB		Rod Assembly	S100333
	2004.12-2007.08	Front Axle Left & Right	Saloon RWD N46B20B/N46B20C/N46B20CB		Tie Rod Axle Joint	S030350
	2004.12-2007.08	Front Axle Left & Right	Saloon RWD N46B20B/N46B20C/N46B20CB		Tie Rod Axle Joint	S030847
	2004.12-2007.08	Front Axle Left	Saloon RWD N46B20B/N46B20C/N46B20CB		Tie Rod End	S070045
	2004.12-2007.08	Front Axle Right	Saloon RWD N46B20B/N46B20C/N46B20CB		Tie Rod End	S070046
	2004.12-2007.08	Front Axle Left	Saloon RWD N46B20B/N46B20C/N46B20CB		Rod/Strut, stabiliser	S050068
	2004.12-2007.08	Front Axle Right	Saloon RWD N46B20B/N46B20C/N46B20CB		Rod/Strut, stabiliser	S050069
	2004.12-2007.08	Rear Axle Left & Right	Saloon RWD N46B20B/N46B20C/N46B20CB	L:160mm	Rod/Strut, stabiliser	S050070
	2004.12-2007.08	Rear Axle Left & Right	Saloon RWD N46B20B/N46B20C/N46B20CB	L:161mm	Rod/Strut, stabiliser	S051405
	2004.12-2007.08	Front Axle	Saloon RWD N46B20B/N46B20C/N46B20CB		Stabiliser Bushing	519357
	2004.12-2007.08	Rear Axle	Saloon RWD N46B20B/N46B20C/N46B20CB		Stabiliser Bushing	535305
2.0 (115 kw)	2007.02-2011.12	Front Axle Left Lower Inner	Saloon RWD N46B20B/N46B20C		Track Control Arm	S060087
	2007.02-2011.12	Front Axle Left Lower Inner	Saloon RWD N46B20B/N46B20C		Track Control Arm	S062657



	 YEAR	FITTING POSITION	BODY STYLE & DRIVE TYPE & ENGINE	REMARKS	PRODUCT	GSP Ref.
BMW						
320i						
2.0 (115 kw)	2007.02-2011.12	Front Axle Left Lower Outer	Saloon RWD N46B20B/N46B20C		Track Control Arm	S060085
	2007.02-2011.12	Front Axle Right Lower Inner	Saloon RWD N46B20B/N46B20C		Track Control Arm	S060088
	2007.02-2011.12	Front Axle Right Lower Inner	Saloon RWD N46B20B/N46B20C		Track Control Arm	S062658
	2007.02-2011.12	Front Axle Right Lower Outer	Saloon RWD N46B20B/N46B20C		Track Control Arm	S060086
	2007.02-2011.12	Rear Axle Left Centre	Saloon RWD N46B20B/N46B20C		Track Control Arm	S063116
	2007.02-2011.12	Rear Axle Right Centre	Saloon RWD N46B20B/N46B20C		Track Control Arm	S063115
	2007.02-2011.12	Rear Axle Left & Right Centre	Saloon RWD N46B20B/N46B20C		Track Control Arm	S060089
	2007.02-2011.12	Front Axle Left & Right Lower Inner	Saloon RWD N46B20B/N46B20C		Control Arm Bushing	531936
	2007.02-2011.12	Front Axle	Saloon RWD N46B20B/N46B20C		Suspension Repair Kit	S990004SK
	2007.02-2011.12	Front Axle Left	Saloon RWD N46B20B/N46B20C		Rod Assembly	S100330
	2007.02-2011.12	Front Axle Left	Saloon RWD N46B20B/N46B20C		Rod Assembly	S100332
	2007.02-2011.12	Front Axle Right	Saloon RWD N46B20B/N46B20C		Rod Assembly	S100331
	2007.02-2011.12	Front Axle Right	Saloon RWD N46B20B/N46B20C		Rod Assembly	S100333
	2007.02-2011.12	Front Axle Left & Right	Saloon RWD N46B20B/N46B20C		Tie Rod Axle Joint	S030350
	2007.02-2011.12	Front Axle Left & Right	Saloon RWD N46B20B/N46B20C		Tie Rod Axle Joint	S030847
	2007.02-2011.12	Front Axle Left	Saloon RWD N46B20B/N46B20C		Tie Rod End	S070045
	2007.02-2011.12	Front Axle Right	Saloon RWD N46B20B/N46B20C		Tie Rod End	S070046
	2007.02-2011.12	Front Axle Left	Saloon RWD N46B20B/N46B20C		Rod/Strut, stabiliser	S050068
	2007.02-2011.12	Front Axle Right	Saloon RWD N46B20B/N46B20C		Rod/Strut, stabiliser	S050069
	2007.02-2011.12	Rear Axle Left & Right	Saloon RWD N46B20B/N46B20C		Rod/Strut, stabiliser	S050070
2007.02-2011.12	Front Axle	Saloon RWD N46B20B/N46B20C		Stabiliser Bushing	519357	
2007.02-2011.12	Rear Axle	Saloon RWD N46B20B/N46B20C		Stabiliser Bushing	535305	
2.0 (135 kw)	2012.03-2018.10	Front Axle Left Lower Inner	Saloon RWD N20B20A/N20B20B	For OE no.31 12 6 852 991	Track Control Arm	S061616
	2012.03-2018.10	Front Axle Left Lower Inner	Saloon RWD N20B20A/N20B20B		Track Control Arm	S063250
	2012.03-2018.10	Front Axle Left Lower Outer	Saloon RWD N20B20A/N20B20B	For OE no.31126851259	Track Control Arm	S061614
	2012.03-2018.10	Front Axle Left Lower Outer	Saloon RWD N20B20A/N20B20B		Track Control Arm	S063254
	2012.03-2018.10	Front Axle Right Lower Inner	Saloon RWD N20B20A/N20B20B		Track Control Arm	S061617
	2012.03-2018.10	Front Axle Right Lower Outer	Saloon RWD N20B20A/N20B20B	For OE no.31126851260	Track Control Arm	S061615
	2012.03-2018.10	Front Axle Right Lower Outer	Saloon RWD N20B20A/N20B20B		Track Control Arm	S063243
	2012.03-2018.10	Rear Axle Left Upper Inner	Saloon RWD N20B20A/N20B20B		Track Control Arm	S061775
	2012.03-2018.10	Rear Axle Right Upper Inner	Saloon RWD N20B20A/N20B20B		Track Control Arm	S061776
	2012.03-2018.10	Rear Axle Left & Right Lower Inner	Saloon RWD N20B20A/N20B20B		Track Control Arm	S061773
	2012.03-2018.10	Rear Axle Left & Right Lower Outer	Saloon RWD N20B20A/N20B20B		Track Control Arm	S061774
	2012.03-2018.10	Front Axle Left & Right Lower Inner	Saloon RWD N20B20A/N20B20B		Control Arm Bushing	532583
	2012.03-2018.10	Front Axle Left & Right Lower Outer	Saloon RWD N20B20A/N20B20B		Control Arm Bushing	533483
	2012.03-2018.10	Front Axle Left	Saloon RWD N20B20A/N20B20B	for vehicles with Adaptive Drive	Rod/Strut, stabiliser	S051259
	2012.03-2018.10	Front Axle Left	Saloon RWD N20B20A/N20B20B	for vehicles with M-Technology for vehicles with electronic suspension control	Rod/Strut, stabiliser	S051353
	2012.03-2018.10	Front Axle Right	Saloon RWD N20B20A/N20B20B		Rod/Strut, stabiliser	S051260
	2012.03-2018.10	Front Axle Left & Right	Saloon RWD N20B20A/N20B20B	for vehicles without Adaptive Drive	Rod/Strut, stabiliser	S051259
	2012.03-2018.10	Front Axle Left & Right	Saloon RWD N20B20A/N20B20B	for vehicles with M-Technology for vehicles with electronic suspension control	Rod/Strut, stabiliser	S051353
	2012.03-2018.10	Rear Axle Left	Saloon RWD N20B20A/N20B20B		Rod/Strut, stabiliser	S051261
	2012.03-2018.10	Rear Axle Right	Saloon RWD N20B20A/N20B20B		Rod/Strut, stabiliser	S051262
2.2 (125 kw)	2000.09-2005.02	Front Axle Left Lower	Saloon RWD M54B226S1	for vehicles with M-Technology	Track Control Arm	S060117
	2000.09-2005.02	Front Axle Left Lower	Saloon RWD M54B226S1	for vehicles with standard suspension	Track Control Arm	S060358
	2000.09-2005.02	Front Axle Left Lower	Saloon RWD M54B226S1	for vehicles with standard suspension	Track Control Arm	S061164
	2000.09-2005.02	Front Axle Right Lower	Saloon RWD M54B226S1	for vehicles with M-Technology	Track Control Arm	S060118
	2000.09-2005.02	Front Axle Right Lower	Saloon RWD M54B226S1	for vehicles with standard suspension	Track Control Arm	S060359
	2000.09-2005.02	Front Axle Right Lower	Saloon RWD M54B226S1	for vehicles with standard suspension	Track Control Arm	S061165
	2000.09-2005.02	Rear Axle Left & Right Lower Inner	Saloon RWD M54B226S1		Track Control Arm	S060098
	2000.09-2005.02	Front Axle Left Lower	Saloon RWD M54B226S1		Control Arm Bushing	517479
	2000.09-2005.02	Front Axle Right Lower	Saloon RWD M54B226S1		Control Arm Bushing	517478
	2000.09-2005.02	Front Axle Left & Right Lower	Saloon RWD M54B226S1		Control Arm Bushing	510605
	2000.09-2005.02	Rear Axle Left & Right Upper	Saloon RWD M54B226S1		Control Arm Bushing	512710
	2000.09-2005.02	Rear Axle Left & Right Lower Inner	Saloon RWD M54B226S1		Control Arm Bushing	512305
	2000.09-2005.02	Front Axle Left & Right Lower	Saloon RWD M54B226S1		Control Arm Bushing Kit	530752S
	2000.09-2005.02	Front Axle Left & Right Lower	Saloon RWD M54B226S1		Control Arm Bushing Kit	531849S
	2000.09-2005.02	Front Axle	Saloon RWD M54B226S1		Suspension Repair Kit	S990031SK
	2000.09-2005.02	Front Axle Left	Saloon RWD M54B226S1		Rod Assembly	S100254
	2000.09-2005.02	Front Axle Right	Saloon RWD M54B226S1		Rod Assembly	S100017
	2000.09-2005.02	Front Axle Left & Right	Saloon RWD M54B226S1		Tie Rod Axle Joint	S030351
	2000.09-2005.02	Front Axle Left	Saloon RWD M54B226S1		Tie Rod End	S070042
	2000.09-2005.02	Front Axle Right	Saloon RWD M54B226S1		Tie Rod End	S070041
	2000.09-2005.02	Front Axle Left & Right	Saloon RWD M54B226S1		Rod/Strut, stabiliser	S050056
	2000.09-2005.02	Rear Axle Left & Right	Saloon RWD M54B226S1		Rod/Strut, stabiliser	S050055



	 YEAR	FITTING POSITION	BODY STYLE & DRIVE TYPE & ENGINE	REMARKS	PRODUCT	GSP Ref.
BMW 320i						
2.2 (125 kw)	2000.09-2005.02	Front Axle	Saloon RWD M54B226S1		Stabiliser Bushing	512757
	2000.09-2005.02	Front Axle	Saloon RWD M54B226S1		Stabiliser Bushing	519360
	2000.09-2005.02	Front Axle	Saloon RWD M54B226S1		Stabiliser Bushing	530971
	2000.09-2005.02	Front Axle	Saloon RWD M54B226S1		Steering Boot	540041
	2000.09-2005.02	Front Axle	Saloon RWD M54B226S1		Steering Boot	540186
	2000.09-2005.02	Front Axle	Saloon RWD M54B226S1	for vehicles with power steering	Steering Rack Bellow Kit	540186S
320i Gran Turismo						
2.0 (135 kw)	2013.03-2017.05	Front Axle Left Lower Inner	Hatchback RWD N20B20A/N20B20B		Track Control Arm	S061616
	2013.03-2017.05	Front Axle Left Lower Outer	Hatchback RWD N20B20A/N20B20B		Track Control Arm	S061614
	2013.03-2017.05	Front Axle Right Lower Inner	Hatchback RWD N20B20A/N20B20B		Track Control Arm	S061617
	2013.03-2017.05	Front Axle Right Lower Outer	Hatchback RWD N20B20A/N20B20B		Track Control Arm	S061615
	2013.03-2017.05	Rear Axle Left Upper Inner	Hatchback RWD N20B20A/N20B20B		Track Control Arm	S061775
	2013.03-2017.05	Rear Axle Right Upper Inner	Hatchback RWD N20B20A/N20B20B		Track Control Arm	S061776
	2013.03-2017.05	Rear Axle Left & Right Lower Inner	Hatchback RWD N20B20A/N20B20B		Track Control Arm	S061773
	2013.03-2017.05	Rear Axle Left & Right Lower Outer	Hatchback RWD N20B20A/N20B20B		Track Control Arm	S061774
	2013.03-2017.05	Front Axle Left & Right Lower Inner	Hatchback RWD N20B20A/N20B20B		Control Arm Bushing	532583
	2013.03-2017.05	Front Axle Left & Right Lower Outer	Hatchback RWD N20B20A/N20B20B		Control Arm Bushing	533483
	2013.03-2017.05	Front Axle Left	Hatchback RWD N20B20A/N20B20B	for vehicles with Adaptive Drive	Rod/Strut, stabiliser	S051259
	2013.03-2017.05	Front Axle Left	Hatchback RWD N20B20A/N20B20B	for vehicles with M-Technology for vehicles with electronic suspension control	Rod/Strut, stabiliser	S051353
	2013.03-2017.05	Front Axle Right	Hatchback RWD N20B20A/N20B20B		Rod/Strut, stabiliser	S051260
	2013.03-2017.05	Front Axle Left & Right	Hatchback RWD N20B20A/N20B20B	for vehicles without Adaptive Drive	Rod/Strut, stabiliser	S051259
	2013.03-2017.05	Front Axle Left & Right	Hatchback RWD N20B20A/N20B20B	for vehicles with standard suspension for vehicles without electronic suspension control	Rod/Strut, stabiliser	S051353
	2013.03-2017.05	Rear Axle Left	Hatchback RWD N20B20A/N20B20B		Rod/Strut, stabiliser	S051261
	2013.03-2017.05	Rear Axle Right	Hatchback RWD N20B20A/N20B20B		Rod/Strut, stabiliser	S051262
320i xDrive						
2.0 (135 kw)	2012.07-2018.10	Front Axle Left Lower Inner	Saloon 4WD N20B20A/N20B20B		Track Control Arm	S063250
	2012.07-2018.10	Front Axle Left Lower Outer	Saloon 4WD N20B20A/N20B20B		Track Control Arm	S063253
	2012.07-2018.10	Front Axle Left Lower Outer	Saloon 4WD N20B20A/N20B20B		Track Control Arm	S063254
	2012.07-2018.10	Front Axle Right Lower Outer	Saloon 4WD N20B20A/N20B20B		Track Control Arm	S063243
	2012.07-2018.10	Front Axle Right Lower Outer	Saloon 4WD N20B20A/N20B20B		Track Control Arm	S063247
	2012.07-2018.10	Rear Axle Left Upper Inner	Saloon 4WD N20B20A/N20B20B		Track Control Arm	S061775
	2012.07-2018.10	Rear Axle Right Upper Inner	Saloon 4WD N20B20A/N20B20B		Track Control Arm	S061776
	2012.07-2018.10	Rear Axle Left & Right Lower Inner	Saloon 4WD N20B20A/N20B20B		Track Control Arm	S061773
	2012.07-2018.10	Rear Axle Left & Right Lower Outer	Saloon 4WD N20B20A/N20B20B		Track Control Arm	S061774
	2012.07-2018.10	Front Axle Left & Right Lower Inner	Saloon 4WD N20B20A/N20B20B		Control Arm Bushing	532583
	2012.07-2018.10	Front Axle Left	Saloon 4WD N20B20A/N20B20B		Rod Assembly	S100350
	2012.07-2018.10	Front Axle Right	Saloon 4WD N20B20A/N20B20B		Rod Assembly	S100351
	2012.07-2018.10	Front Axle Left & Right	Saloon 4WD N20B20A/N20B20B		Tie Rod Axle Joint	S031029
	2012.07-2018.10	Front Axle Left	Saloon 4WD N20B20A/N20B20B		Tie Rod End	S071700
	2012.07-2018.10	Front Axle Right	Saloon 4WD N20B20A/N20B20B		Tie Rod End	S071701
	2012.07-2018.10	Front Axle Left	Saloon 4WD N20B20A/N20B20B		Rod/Strut, stabiliser	S051259
	2012.07-2018.10	Front Axle Left	Saloon 4WD N20B20A/N20B20B	for vehicles with M-Technology for vehicles with electronic suspension control	Rod/Strut, stabiliser	S051353
	2012.07-2018.10	Front Axle Right	Saloon 4WD N20B20A/N20B20B		Rod/Strut, stabiliser	S051260
	2012.07-2018.10	Front Axle Left & Right	Saloon 4WD N20B20A/N20B20B		Rod/Strut, stabiliser	S051353
	2012.07-2018.10	Rear Axle Left	Saloon 4WD N20B20A/N20B20B		Rod/Strut, stabiliser	S051261
	2012.07-2018.10	Rear Axle Right	Saloon 4WD N20B20A/N20B20B		Rod/Strut, stabiliser	S051262
323i						
2.5 (125 kw)	1995.05-1998.11	Front Axle Left Lower	Saloon RWD M52B256S3		Track Control Arm	S060114
	1995.05-1998.11	Front Axle Right Lower	Saloon RWD M52B256S3		Track Control Arm	S060113
	1995.05-1998.11	Rear Axle Left & Right Lower Inner	Saloon RWD M52B256S3		Track Control Arm	S060098
	1995.05-1998.11	Front Axle Left & Right Lower	Saloon RWD M52B256S3		Ball Joint	S080020
	1995.05-1998.11	Front Axle Left & Right Lower	Saloon RWD M52B256S3		Ball Joint	S080025
	1995.05-1998.11	Front Axle Left Lower	Saloon RWD M52B256S3		Control Arm Bushing	518074
	1995.05-1998.11	Front Axle Right Lower	Saloon RWD M52B256S3		Control Arm Bushing	518073
	1995.05-1998.11	Front Axle Left & Right Lower	Saloon RWD M52B256S3		Control Arm Bushing	511593
	1995.05-1998.11	Rear Axle Left & Right Upper	Saloon RWD M52B256S3		Control Arm Bushing	512710
	1995.05-1998.11	Rear Axle Left & Right Lower Inner	Saloon RWD M52B256S3		Control Arm Bushing	512305
	1995.05-1998.11	Front Axle Left & Right Lower	Saloon RWD M52B256S3		Control Arm Bushing Kit	530751S
	1995.05-1998.11	Front Axle Left	Saloon RWD M52B256S3		Rod Assembly	S100029
	1995.05-1998.11	Front Axle Right	Saloon RWD M52B256S3		Rod Assembly	S100030
	1995.05-1998.11	Front Axle Left & Right	Saloon RWD M52B256S3		Tie Rod Axle Joint	S030777
	1995.05-1998.11	Front Axle Left	Saloon RWD M52B256S3		Tie Rod End	S070054
	1995.05-1998.11	Front Axle Right	Saloon RWD M52B256S3		Tie Rod End	S070055
	1995.05-1998.11	Front Axle Left & Right	Saloon RWD M52B256S3		Rod/Strut, stabiliser	S050077



	 YEAR	FITTING POSITION	BODY STYLE & DRIVE TYPE & ENGINE	REMARKS	PRODUCT	GSP Ref.
BMW 323i						
2.5 (125 kw)	1995.05-1998.11	Rear Axle Left & Right	Saloon RWD M52B256S3		Rod/Strut, stabiliser	S050058
	1995.05-1998.11	Front Axle	Saloon RWD M52B256S3		Stabiliser Bushing	512754
	1995.05-1998.11	Rear Axle	Saloon RWD M52B256S3		Stabiliser Bushing	511588
	1995.05-1998.11	Front Axle	Saloon RWD M52B256S3		Steering Boot	540041
	1995.05-1998.11	Front Axle	Saloon RWD M52B256S3		Steering Boot	540186
	1995.05-1998.11	Front Axle	Saloon RWD M52B256S3		Steering Rack Bellow Kit	540191S
	1998.03-2000.09	Front Axle Left Lower	Saloon RWD M52B256S4	for vehicles with M-Technology	Track Control Arm	S060117
	1998.03-2000.09	Front Axle Left Lower	Saloon RWD M52B256S4	for vehicles with standard suspension	Track Control Arm	S060358
	1998.03-2000.09	Front Axle Left Lower	Saloon RWD M52B256S4	for vehicles with standard suspension	Track Control Arm	S061164
	1998.03-2000.09	Front Axle Right Lower	Saloon RWD M52B256S4	for vehicles with M-Technology	Track Control Arm	S060118
	1998.03-2000.09	Front Axle Right Lower	Saloon RWD M52B256S4	for vehicles with standard suspension	Track Control Arm	S060359
	1998.03-2000.09	Front Axle Right Lower	Saloon RWD M52B256S4	for vehicles with standard suspension	Track Control Arm	S061165
	1998.03-2000.09	Rear Axle Left & Right Lower Inner	Saloon RWD M52B256S4		Track Control Arm	S060098
	1998.03-2000.09	Front Axle Left Lower	Saloon RWD M52B256S4		Control Arm Bushing	517479
	1998.03-2000.09	Front Axle Right Lower	Saloon RWD M52B256S4		Control Arm Bushing	517478
	1998.03-2000.09	Front Axle Left & Right Lower	Saloon RWD M52B256S4		Control Arm Bushing	510605
	1998.03-2000.09	Rear Axle Left & Right Upper	Saloon RWD M52B256S4		Control Arm Bushing	512710
	1998.03-2000.09	Rear Axle Left & Right Lower Inner	Saloon RWD M52B256S4		Control Arm Bushing	512305
	1998.03-2000.09	Front Axle Left & Right Lower	Saloon RWD M52B256S4	Date from: 1999.07	Control Arm Bushing Kit	530752S
	1998.03-2000.09	Front Axle Left & Right Lower	Saloon RWD M52B256S4		Control Arm Bushing Kit	531849S
	1998.03-2000.09	Front Axle Left	Saloon RWD M52B256S4		Rod Assembly	S100254
	1998.03-2000.09	Front Axle Right	Saloon RWD M52B256S4		Rod Assembly	S100017
	1998.03-2000.09	Front Axle Left & Right	Saloon RWD M52B256S4		Tie Rod Axle Joint	S030351
	1998.03-2000.09	Front Axle Left	Saloon RWD M52B256S4		Tie Rod End	S070042
	1998.03-2000.09	Front Axle Right	Saloon RWD M52B256S4		Tie Rod End	S070041
	1998.03-2000.09	Front Axle Left & Right	Saloon RWD M52B256S4		Tie Rod End	S070824
	1998.03-2000.09	Front Axle Left & Right	Saloon RWD M52B256S4		Tie Rod End	S070866
	1998.03-2000.09	Front Axle Left & Right	Saloon RWD M52B256S4		Rod/Strut, stabiliser	S050056
	1998.03-2000.09	Rear Axle Left & Right	Saloon RWD M52B256S4		Rod/Strut, stabiliser	S050055
	1998.03-2000.09	Front Axle	Saloon RWD M52B256S4		Stabiliser Bushing	512757
	1998.03-2000.09	Front Axle	Saloon RWD M52B256S4		Stabiliser Bushing	519360
	1998.03-2000.09	Front Axle	Saloon RWD M52B256S4		Stabiliser Bushing	530971
	1998.03-2000.09	Rear Axle	Saloon RWD M52B256S4		Stabiliser Bushing	511588
	1998.03-2000.09	Front Axle	Saloon RWD M52B256S4		Steering Boot	540041
	1998.03-2000.09	Front Axle	Saloon RWD M52B256S4		Steering Boot	540186
	1998.03-2000.09	Front Axle	Saloon RWD M52B256S4	for vehicles with power steering	Steering Rack Bellow Kit	540186S
323i Compact						
2.5 (125 kw)	1997.09-2000.08	Front Axle Left Lower	Hatchback RWD M52B256S3		Track Control Arm	S060114
	1997.09-2000.08	Front Axle Right Lower	Hatchback RWD M52B256S3		Track Control Arm	S060113
	1997.09-2000.08	Rear Axle Left & Right Lower Inner	Hatchback RWD M52B256S3		Track Control Arm	S060098
	1997.09-2000.08	Front Axle Left & Right Lower	Hatchback RWD M52B256S3		Ball Joint	S080020
	1997.09-2000.08	Front Axle Left & Right Lower	Hatchback RWD M52B256S3		Ball Joint	S080025
	1997.09-2000.08	Front Axle Left Lower	Hatchback RWD M52B256S3		Control Arm Bushing	518074
	1997.09-2000.08	Front Axle Right Lower	Hatchback RWD M52B256S3		Control Arm Bushing	518073
	1997.09-2000.08	Front Axle Left & Right Lower	Hatchback RWD M52B256S3		Control Arm Bushing	511593
	1997.09-2000.08	Front Axle Left & Right Lower	Hatchback RWD M52B256S3		Control Arm Bushing Kit	530751S
	1997.09-2000.08	Front Axle Left	Hatchback RWD M52B256S3		Rod Assembly	S100029
	1997.09-2000.08	Front Axle Right	Hatchback RWD M52B256S3		Rod Assembly	S100030
	1997.09-2000.08	Front Axle Left & Right	Hatchback RWD M52B256S3		Tie Rod Axle Joint	S030777
	1997.09-2000.08	Front Axle Left	Hatchback RWD M52B256S3		Tie Rod End	S070054
	1997.09-2000.08	Front Axle Right	Hatchback RWD M52B256S3		Tie Rod End	S070055
	1997.09-2000.08	Front Axle Left & Right	Hatchback RWD M52B256S3		Rod/Strut, stabiliser	S050077
	1997.09-2000.08	Rear Axle Left & Right	Hatchback RWD M52B256S3		Rod/Strut, stabiliser	520093
	1997.09-2000.08	Front Axle	Hatchback RWD M52B256S3		Stabiliser Bushing	512754
	1997.09-2000.08	Front Axle	Hatchback RWD M52B256S3		Steering Boot	540041
	1997.09-2000.08	Front Axle	Hatchback RWD M52B256S3		Steering Boot	540186
	1997.09-2000.08	Front Axle	Hatchback RWD M52B256S3		Steering Rack Bellow Kit	540191S
323i Touring						
2.5 (125 kw)	1995.12-1999.04	Front Axle Left Lower	Estate RWD M52B256S3		Track Control Arm	S060114
	1995.12-1999.04	Front Axle Right Lower	Estate RWD M52B256S3		Track Control Arm	S060113
	1995.12-1999.04	Rear Axle Left & Right Lower Inner	Estate RWD M52B256S3		Track Control Arm	S060098
	1995.12-1999.04	Front Axle Left & Right Lower	Estate RWD M52B256S3		Ball Joint	S080020
	1995.12-1999.04	Front Axle Left & Right Lower	Estate RWD M52B256S3		Ball Joint	S080025
	1995.12-1999.04	Front Axle Left Lower	Estate RWD M52B256S3		Control Arm Bushing	518074

	 YEAR	FITTING POSITION	BODY STYLE & DRIVE TYPE & ENGINE	REMARKS	PRODUCT	GSP Ref.
BMW						
323i Touring						
2.5 (125 kw)	1995.12-1999.04	Front Axle Right Lower	Estate RWD M52B256S3		Control Arm Bushing	518073
	1995.12-1999.04	Front Axle Left & Right Lower	Estate RWD M52B256S3		Control Arm Bushing	511593
	1995.12-1999.04	Rear Axle Left & Right Upper	Estate RWD M52B256S3		Control Arm Bushing	512710
	1995.12-1999.04	Rear Axle Left & Right Lower Inner	Estate RWD M52B256S3		Control Arm Bushing	512305
	1995.12-1999.04	Front Axle Left & Right Lower	Estate RWD M52B256S3		Control Arm Bushing Kit	530751S
	1995.12-1999.04	Front Axle Left	Estate RWD M52B256S3		Rod Assembly	S100029
	1995.12-1999.04	Front Axle Right	Estate RWD M52B256S3		Rod Assembly	S100030
	1995.12-1999.04	Front Axle Left & Right	Estate RWD M52B256S3		Tie Rod Axle Joint	S030777
	1995.12-1999.04	Front Axle Left	Estate RWD M52B256S3		Tie Rod End	S070054
	1995.12-1999.04	Front Axle Right	Estate RWD M52B256S3		Tie Rod End	S070055
	1995.12-1999.04	Front Axle Left & Right	Estate RWD M52B256S3		Rod/Strut, stabiliser	S050077
	1995.12-1999.04	Rear Axle Left & Right	Estate RWD M52B256S3		Rod/Strut, stabiliser	S050058
	1995.12-1999.04	Front Axle	Estate RWD M52B256S3		Stabiliser Bushing	512754
	1995.12-1999.04	Rear Axle	Estate RWD M52B256S3		Stabiliser Bushing	511588
	1995.12-1999.04	Front Axle	Estate RWD M52B256S3		Steering Boot	540041
	1995.12-1999.04	Front Axle	Estate RWD M52B256S3		Steering Boot	540186
	1995.12-1999.04	Front Axle	Estate RWD M52B256S3		Steering Rack Bellow Kit	540191S
	1999.10-2000.12	Front Axle	Estate RWD M52B256S4		Stabiliser Bushing	530971
325i						
2.5 (141 kw)	1990.09-1995.07	Front Axle Left Lower	Saloon RWD M50B256S1/M50B256S2		Track Control Arm	S060114
	1990.09-1995.07	Front Axle Right Lower	Saloon RWD M50B256S1/M50B256S2		Track Control Arm	S060113
	1990.09-1995.07	Rear Axle Left & Right Lower Inner	Saloon RWD M50B256S1/M50B256S2		Track Control Arm	S060098
	1990.09-1995.07	Front Axle Left & Right Lower	Saloon RWD M50B256S1/M50B256S2		Ball Joint	S080020
	1990.09-1995.07	Front Axle Left & Right Lower	Saloon RWD M50B256S1/M50B256S2		Ball Joint	S080025
	1990.09-1995.07	Front Axle Left Lower	Saloon RWD M50B256S1/M50B256S2		Control Arm Bushing	518074
	1990.09-1995.07	Front Axle Right Lower	Saloon RWD M50B256S1/M50B256S2		Control Arm Bushing	518073
	1990.09-1995.07	Front Axle Left & Right Lower	Saloon RWD M50B256S1/M50B256S2		Control Arm Bushing	511593
	1990.09-1995.07	Rear Axle Left & Right Upper	Saloon RWD M50B256S1/M50B256S2		Control Arm Bushing	512710
	1990.09-1995.07	Rear Axle Left & Right Lower Inner	Saloon RWD M50B256S1/M50B256S2		Control Arm Bushing	512305
	1990.09-1995.07	Front Axle Left & Right Lower	Saloon RWD M50B256S1/M50B256S2		Control Arm Bushing Kit	530751S
	1990.09-1995.07	Front Axle Left	Saloon RWD M50B256S1/M50B256S2		Rod Assembly	S100029
	1990.09-1995.07	Front Axle Right	Saloon RWD M50B256S1/M50B256S2		Rod Assembly	S100030
	1990.09-1995.07	Front Axle Left & Right	Saloon RWD M50B256S1/M50B256S2		Tie Rod Axle Joint	S030777
	1990.09-1995.07	Front Axle Left	Saloon RWD M50B256S1/M50B256S2		Tie Rod End	S070054
	1990.09-1995.07	Front Axle Right	Saloon RWD M50B256S1/M50B256S2		Tie Rod End	S070055
	1990.09-1995.07	Front Axle Left & Right	Saloon RWD M50B256S1/M50B256S2		Rod/Strut, stabiliser	S050077
	1990.09-1995.07	Front Axle Left & Right	Saloon RWD M50B256S1/M50B256S2	Date to: 1991.10	Rod/Strut, stabiliser	S050078
	1990.09-1995.07	Rear Axle Left & Right	Saloon RWD M50B256S1/M50B256S2		Rod/Strut, stabiliser	S050058
	1990.09-1995.07	Front Axle	Saloon RWD M50B256S1/M50B256S2		Stabiliser Bushing	512754
	1990.09-1995.07	Rear Axle	Saloon RWD M50B256S1/M50B256S2		Stabiliser Bushing	511588
	1990.09-1995.07	Rear Axle	Saloon RWD M50B256S1/M50B256S2		Stabiliser Bushing	512759
	1990.09-1995.07	Front Axle	Saloon RWD M50B256S1/M50B256S2		Steering Boot	540041
	1990.09-1995.07	Front Axle	Saloon RWD M50B256S1/M50B256S2		Steering Boot	540186
	1990.09-1995.07	Front Axle	Saloon RWD M50B256S1/M50B256S2		Steering Rack Bellow Kit	540191S
	2000.09-2005.02	Front Axle Left Lower	Saloon RWD M54B256S5	for vehicles with M-Technology	Track Control Arm	S060117
	2000.09-2005.02	Front Axle Left Lower	Saloon RWD M54B256S5	for vehicles with standard suspension	Track Control Arm	S060358
	2000.09-2005.02	Front Axle Left Lower	Saloon RWD M54B256S5	for vehicles with standard suspension	Track Control Arm	S061164
	2000.09-2005.02	Front Axle Right Lower	Saloon RWD M54B256S5	for vehicles with M-Technology	Track Control Arm	S060118
	2000.09-2005.02	Front Axle Right Lower	Saloon RWD M54B256S5	for vehicles with standard suspension	Track Control Arm	S060359
	2000.09-2005.02	Front Axle Right Lower	Saloon RWD M54B256S5	for vehicles with standard suspension	Track Control Arm	S061165
	2000.09-2005.02	Rear Axle Left & Right Lower Inner	Saloon RWD M54B256S5		Track Control Arm	S060098
	2000.09-2005.02	Front Axle Left Lower	Saloon RWD M54B256S5		Control Arm Bushing	517479
	2000.09-2005.02	Front Axle Right Lower	Saloon RWD M54B256S5		Control Arm Bushing	517478
	2000.09-2005.02	Front Axle Left & Right Lower	Saloon RWD M54B256S5		Control Arm Bushing	510605
	2000.09-2005.02	Rear Axle Left & Right Upper	Saloon RWD M54B256S5		Control Arm Bushing	512710
	2000.09-2005.02	Rear Axle Left & Right Lower Inner	Saloon RWD M54B256S5		Control Arm Bushing	512305
	2000.09-2005.02	Front Axle Left & Right Lower	Saloon RWD M54B256S5		Control Arm Bushing Kit	530752S
	2000.09-2005.02	Front Axle Left & Right Lower	Saloon RWD M54B256S5		Control Arm Bushing Kit	531849S
	2000.09-2005.02	Front Axle	Saloon RWD M54B256S5		Suspension Repair Kit	S990031SK
	2000.09-2005.02	Front Axle Left	Saloon RWD M54B256S5		Rod Assembly	S100254
	2000.09-2005.02	Front Axle Right	Saloon RWD M54B256S5		Rod Assembly	S100017
	2000.09-2005.02	Front Axle Left & Right	Saloon RWD M54B256S5		Tie Rod Axle Joint	S030351
	2000.09-2005.02	Front Axle Left	Saloon RWD M54B256S5		Tie Rod End	S070042
	2000.09-2005.02	Front Axle Right	Saloon RWD M54B256S5		Tie Rod End	S070041



	 YEAR	FITTING POSITION	BODY STYLE & DRIVE TYPE & ENGINE	REMARKS	PRODUCT	GSP Ref.
BMW 325i						
2.5 (141 kw)	2000.09-2005.02	Front Axle Left & Right	Saloon RWD M54B256S5		Rod/Strut, stabiliser	S050056
	2000.09-2005.02	Rear Axle Left & Right	Saloon RWD M54B256S5		Rod/Strut, stabiliser	S050055
	2000.09-2005.02	Front Axle	Saloon RWD M54B256S5		Stabiliser Bushing	512757
	2000.09-2005.02	Front Axle	Saloon RWD M54B256S5		Stabiliser Bushing	519360
	2000.09-2005.02	Front Axle	Saloon RWD M54B256S5		Stabiliser Bushing	530971
	2000.09-2005.02	Front Axle	Saloon RWD M54B256S5		Steering Boot	540041
	2000.09-2005.02	Front Axle	Saloon RWD M54B256S5		Steering Boot	540186
	2000.09-2005.02	Front Axle	Saloon RWD M54B256S5	for vehicles with power steering	Steering Rack Bellow Kit	540186S
2.5 (160 kw)	2004.12-2011.12	Front Axle Left Lower Inner	Saloon RWD N52B25A/N52B25B/N52B25BF		Track Control Arm	S060087
	2004.12-2011.12	Front Axle Left Lower Inner	Saloon RWD N52B25A/N52B25B/N52B25BF		Track Control Arm	S062657
	2004.12-2011.12	Front Axle Left Lower Outer	Saloon RWD N52B25A/N52B25B/N52B25BF		Track Control Arm	S060085
	2004.12-2011.12	Front Axle Right Lower Inner	Saloon RWD N52B25A/N52B25B/N52B25BF		Track Control Arm	S060088
	2004.12-2011.12	Front Axle Right Lower Inner	Saloon RWD N52B25A/N52B25B/N52B25BF		Track Control Arm	S062658
	2004.12-2011.12	Front Axle Right Lower Outer	Saloon RWD N52B25A/N52B25B/N52B25BF		Track Control Arm	S060086
	2004.12-2011.12	Rear Axle Left Centre	Saloon RWD N52B25A/N52B25B/N52B25BF		Track Control Arm	S063116
	2004.12-2011.12	Rear Axle Right Centre	Saloon RWD N52B25A/N52B25B/N52B25BF		Track Control Arm	S063115
	2004.12-2011.12	Rear Axle Left & Right Centre	Saloon RWD N52B25A/N52B25B/N52B25BF		Track Control Arm	S060089
	2004.12-2011.12	Rear Axle Left & Right Upper	Saloon RWD N52B25A/N52B25B/N52B25BF		Track Control Arm	S062839
	2004.12-2011.12	Front Axle Left & Right Lower Inner	Saloon RWD N52B25A/N52B25B/N52B25BF		Control Arm Bushing	531936
	2004.12-2011.12	Front Axle	Saloon RWD N52B25A/N52B25B/N52B25BF		Suspension Repair Kit	S990004SK
	2004.12-2011.12	Front Axle Left	Saloon RWD N52B25A/N52B25B/N52B25BF		Rod Assembly	S100330
	2004.12-2011.12	Front Axle Right	Saloon RWD N52B25A/N52B25B/N52B25BF		Rod Assembly	S100331
	2004.12-2011.12	Front Axle Left & Right	Saloon RWD N52B25A/N52B25B/N52B25BF		Tie Rod Axle Joint	S030350
	2004.12-2011.12	Front Axle Left	Saloon RWD N52B25A/N52B25B/N52B25BF		Tie Rod End	S070045
	2004.12-2011.12	Front Axle Right	Saloon RWD N52B25A/N52B25B/N52B25BF		Tie Rod End	S070046
	2004.12-2011.12	Front Axle Left	Saloon RWD N52B25A/N52B25B/N52B25BF		Rod/Strut, stabiliser	S050068
	2004.12-2011.12	Front Axle Right	Saloon RWD N52B25A/N52B25B/N52B25BF		Rod/Strut, stabiliser	S050069
	2004.12-2011.12	Rear Axle Left & Right	Saloon RWD N52B25A/N52B25B/N52B25BF	L:160mm	Rod/Strut, stabiliser	S050070
	2004.12-2011.12	Rear Axle Left & Right	Saloon RWD N52B25A/N52B25B/N52B25BF	L:161mm	Rod/Strut, stabiliser	S051405
	2004.12-2011.12	Front Axle	Saloon RWD N52B25A/N52B25B/N52B25BF		Stabiliser Bushing	519357
	2004.12-2011.12	Rear Axle	Saloon RWD N52B25A/N52B25B/N52B25BF	Inner Diameter:13mm	Stabiliser Bushing	535302
	2004.12-2011.12	Rear Axle	Saloon RWD N52B25A/N52B25B/N52B25BF	Inner Diameter:15mm	Stabiliser Bushing	535305
	2004.12-2011.12	Rear Axle	Saloon RWD N52B25A/N52B25B/N52B25BF	Inner Diameter:11.1mm	Stabiliser Bushing	535307
325i Cabrio						
2.5 (141 kw)	1993.03-1995.02	Front Axle Left Lower	Cabriolet RWD M50B256S2		Track Control Arm	S060114
	1993.03-1995.02	Front Axle Right Lower	Cabriolet RWD M50B256S2		Track Control Arm	S060113
	1993.03-1995.02	Rear Axle Left & Right Lower Inner	Cabriolet RWD M50B256S2		Track Control Arm	S060098
	1993.03-1995.02	Front Axle Left & Right Lower	Cabriolet RWD M50B256S2		Ball Joint	S080020
	1993.03-1995.02	Front Axle Left & Right Lower	Cabriolet RWD M50B256S2		Ball Joint	S080025
	1993.03-1995.02	Front Axle Left Lower	Cabriolet RWD M50B256S2		Control Arm Bushing	518074
	1993.03-1995.02	Front Axle Right Lower	Cabriolet RWD M50B256S2		Control Arm Bushing	518073
	1993.03-1995.02	Front Axle Left & Right Lower	Cabriolet RWD M50B256S2		Control Arm Bushing	511593
	1993.03-1995.02	Rear Axle Left & Right Upper	Cabriolet RWD M50B256S2		Control Arm Bushing	512710
	1993.03-1995.02	Rear Axle Left & Right Lower Inner	Cabriolet RWD M50B256S2		Control Arm Bushing	512305
	1993.03-1995.02	Front Axle Left & Right Lower	Cabriolet RWD M50B256S2		Control Arm Bushing Kit	530751S
	1993.03-1995.02	Front Axle Left	Cabriolet RWD M50B256S2		Rod Assembly	S100029
	1993.03-1995.02	Front Axle Right	Cabriolet RWD M50B256S2		Rod Assembly	S100030
	1993.03-1995.02	Front Axle Left & Right	Cabriolet RWD M50B256S2		Tie Rod Axle Joint	S030777
	1993.03-1995.02	Front Axle Left	Cabriolet RWD M50B256S2		Tie Rod End	S070054
	1993.03-1995.02	Front Axle Right	Cabriolet RWD M50B256S2		Tie Rod End	S070055
	1993.03-1995.02	Front Axle Left & Right	Cabriolet RWD M50B256S2		Rod/Strut, stabiliser	S050077
	1993.03-1995.02	Rear Axle Left & Right	Cabriolet RWD M50B256S2		Rod/Strut, stabiliser	S050058
	1993.03-1995.02	Front Axle	Cabriolet RWD M50B256S2		Stabiliser Bushing	512754
	1993.03-1995.02	Rear Axle	Cabriolet RWD M50B256S2		Stabiliser Bushing	511588
	1993.03-1995.02	Rear Axle	Cabriolet RWD M50B256S2		Stabiliser Bushing	512759
	1993.03-1995.02	Front Axle	Cabriolet RWD M50B256S2		Steering Boot	540041
	1993.03-1995.02	Front Axle	Cabriolet RWD M50B256S2		Steering Boot	540186
	1993.03-1995.02	Front Axle	Cabriolet RWD M50B256S2		Steering Rack Bellow Kit	540191S
325i Touring						
2.5 (132 kw)	2002.09-2005.07	Front Axle	Estate RWD M56B25(256S6)		Stabiliser Bushing	530971
2.5 (137 kw)	2000.09-2005.02	Front Axle	Estate RWD M54B25(256S5)	Code:Sport	Stabiliser Bushing	517357
	2000.09-2005.02	Front Axle	Estate RWD M54B25(256S5)		Stabiliser Bushing	530971



	 YEAR	FITTING POSITION	BODY STYLE & DRIVE TYPE & ENGINE	REMARKS	PRODUCT	GSP Ref.
BMW						
325xi Touring						
2.5 (137 kw)	2000.09-2005.02	Front Axle Left & Right Lower	Estate AWD M54B25(256S5)		Control Arm Bushing	535619
	2000.09-2005.02	Front Axle	Estate AWD M54B25(256S5)		Stabiliser Bushing	530971
328i						
2.0 (180 kw)	2011.11-2018.10	Front Axle Left Lower Inner	Saloon RWD N20B20A/N26B20A	For OE no.31 12 6 852 991	Track Control Arm	S061616
	2011.11-2018.10	Front Axle Left Lower Inner	Saloon RWD N20B20A/N26B20A		Track Control Arm	S063250
	2011.11-2018.10	Front Axle Left Lower Outer	Saloon RWD N20B20A/N26B20A	For OE no.31126851259	Track Control Arm	S061614
	2011.11-2018.10	Front Axle Left Lower Outer	Saloon RWD N20B20A/N26B20A		Track Control Arm	S063254
	2011.11-2018.10	Front Axle Right Lower Inner	Saloon RWD N20B20A/N26B20A		Track Control Arm	S061617
	2011.11-2018.10	Front Axle Right Lower Outer	Saloon RWD N20B20A/N26B20A	For OE no.31126851260	Track Control Arm	S061615
	2011.11-2018.10	Front Axle Right Lower Outer	Saloon RWD N20B20A/N26B20A		Track Control Arm	S063243
	2011.11-2018.10	Rear Axle Left Upper Inner	Saloon RWD N20B20A/N26B20A		Track Control Arm	S061775
	2011.11-2018.10	Rear Axle Right Upper Inner	Saloon RWD N20B20A/N26B20A		Track Control Arm	S061776
	2011.11-2018.10	Rear Axle Left & Right Lower Inner	Saloon RWD N20B20A/N26B20A		Track Control Arm	S061773
	2011.11-2018.10	Rear Axle Left & Right Lower Outer	Saloon RWD N20B20A/N26B20A		Track Control Arm	S061774
	2011.11-2018.10	Front Axle Left & Right Lower Inner	Saloon RWD N20B20A/N26B20A		Control Arm Bushing	532583
	2011.11-2018.10	Front Axle Left & Right Lower Outer	Saloon RWD N20B20A/N26B20A		Control Arm Bushing	533483
	2011.11-2018.10	Front Axle Left	Saloon RWD N20B20A/N26B20A	for vehicles with Adaptive Drive	Rod/Strut,stabiliser	S051259
	2011.11-2018.10	Front Axle Left	Saloon RWD N20B20A/N26B20A	for vehicles with M-Technology for vehicles with electronic suspension control	Rod/Strut,stabiliser	S051353
	2011.11-2018.10	Front Axle Right	Saloon RWD N20B20A/N26B20A		Rod/Strut,stabiliser	S051260
	2011.11-2018.10	Front Axle Left & Right	Saloon RWD N20B20A/N26B20A	for vehicles without Adaptive Drive	Rod/Strut,stabiliser	S051259
	2011.11-2018.10	Front Axle Left & Right	Saloon RWD N20B20A/N26B20A	for vehicles with standard suspension for vehicles without electronic suspension control	Rod/Strut,stabiliser	S051353
	2011.11-2018.10	Rear Axle Left	Saloon RWD N20B20A/N26B20A		Rod/Strut,stabiliser	S051261
	2011.11-2018.10	Rear Axle Right	Saloon RWD N20B20A/N26B20A		Rod/Strut,stabiliser	S051262
2.8 (142 kw)	1995.01-1998.04	Front Axle Left Lower	Saloon RWD M52B286S1		Track Control Arm	S060114
	1995.01-1998.04	Front Axle Right Lower	Saloon RWD M52B286S1		Track Control Arm	S060113
	1995.01-1998.04	Rear Axle Left & Right Lower Inner	Saloon RWD M52B286S1		Track Control Arm	S060098
	1995.01-1998.04	Front Axle Left & Right Lower	Saloon RWD M52B286S1		Ball Joint	S080020
	1995.01-1998.04	Front Axle Left & Right Lower	Saloon RWD M52B286S1		Ball Joint	S080025
	1995.01-1998.04	Front Axle Left Lower	Saloon RWD M52B286S1		Control Arm Bushing	518074
	1995.01-1998.04	Front Axle Right Lower	Saloon RWD M52B286S1		Control Arm Bushing	518073
	1995.01-1998.04	Front Axle Left & Right Lower	Saloon RWD M52B286S1		Control Arm Bushing	511593
	1995.01-1998.04	Rear Axle Left & Right Upper	Saloon RWD M52B286S1		Control Arm Bushing	512710
	1995.01-1998.04	Rear Axle Left & Right Lower Inner	Saloon RWD M52B286S1		Control Arm Bushing	512305
	1995.01-1998.04	Front Axle Left & Right Lower	Saloon RWD M52B286S1		Control Arm Bushing Kit	530751S
	1995.01-1998.04	Front Axle Left	Saloon RWD M52B286S1		Rod Assembly	S100029
	1995.01-1998.04	Front Axle Right	Saloon RWD M52B286S1		Rod Assembly	S100030
	1995.01-1998.04	Front Axle Left & Right	Saloon RWD M52B286S1		Tie Rod Axle Joint	S030777
	1995.01-1998.04	Front Axle Left	Saloon RWD M52B286S1		Tie Rod End	S070054
	1995.01-1998.04	Front Axle Right	Saloon RWD M52B286S1		Tie Rod End	S070055
	1995.01-1998.04	Front Axle Left & Right	Saloon RWD M52B286S1		Rod/Strut,stabiliser	S050077
	1995.01-1998.04	Rear Axle Left & Right	Saloon RWD M52B286S1		Rod/Strut,stabiliser	S050058
	1995.01-1998.04	Front Axle	Saloon RWD M52B286S1		Stabiliser Bushing	512754
	1995.01-1998.04	Rear Axle	Saloon RWD M52B286S1		Stabiliser Bushing	511588
	1995.01-1998.04	Front Axle	Saloon RWD M52B286S1		Steering Boot	540041
	1995.01-1998.04	Front Axle	Saloon RWD M52B286S1		Steering Boot	540186
	1995.01-1998.04	Front Axle	Saloon RWD M52B286S1		Steering Rack Bellow Kit	540191S
	1997.12-2000.05	Front Axle Left Lower	Saloon RWD M52B286S2	for vehicles with M-Technology	Track Control Arm	S060117
	1997.12-2000.05	Front Axle Left Lower	Saloon RWD M52B286S2	for vehicles with standard suspension	Track Control Arm	S060358
	1997.12-2000.05	Front Axle Left Lower	Saloon RWD M52B286S2	for vehicles with standard suspension	Track Control Arm	S061164
	1997.12-2000.05	Front Axle Right Lower	Saloon RWD M52B286S2	for vehicles with M-Technology	Track Control Arm	S060118
	1997.12-2000.05	Front Axle Right Lower	Saloon RWD M52B286S2	for vehicles with standard suspension	Track Control Arm	S060359
	1997.12-2000.05	Front Axle Right Lower	Saloon RWD M52B286S2	for vehicles with standard suspension	Track Control Arm	S061165
	1997.12-2000.05	Rear Axle Left & Right Lower Inner	Saloon RWD M52B286S2		Track Control Arm	S060098
	1997.12-2000.05	Front Axle Left Lower	Saloon RWD M52B286S2		Control Arm Bushing	517479
	1997.12-2000.05	Front Axle Right Lower	Saloon RWD M52B286S2		Control Arm Bushing	517478
	1997.12-2000.05	Front Axle Left & Right Lower	Saloon RWD M52B286S2		Control Arm Bushing	510605
	1997.12-2000.05	Rear Axle Left & Right Upper	Saloon RWD M52B286S2		Control Arm Bushing	512710
	1997.12-2000.05	Rear Axle Left & Right Lower Inner	Saloon RWD M52B286S2		Control Arm Bushing	512305
	1997.12-2000.05	Front Axle Left & Right Lower	Saloon RWD M52B286S2	Date from: 1999.07	Control Arm Bushing Kit	530752S
	1997.12-2000.05	Front Axle Left & Right Lower	Saloon RWD M52B286S2		Control Arm Bushing Kit	531849S
	1997.12-2000.05	Front Axle Left	Saloon RWD M52B286S2		Rod Assembly	S100254
	1997.12-2000.05	Front Axle Right	Saloon RWD M52B286S2		Rod Assembly	S100017
	1997.12-2000.05	Front Axle Left & Right	Saloon RWD M52B286S2		Tie Rod Axle Joint	S030351
	1997.12-2000.05	Front Axle Left	Saloon RWD M52B286S2		Tie Rod End	S070042



	 YEAR	FITTING POSITION	BODY STYLE & DRIVE TYPE & ENGINE	REMARKS	PRODUCT	GSP Ref.
BMW 328i						
2.8 (142 kw)	1997.12-2000.05	Front Axle Right	Saloon RWD M52B286S2		Tie Rod End	S070041
	1997.12-2000.05	Front Axle Left & Right	Saloon RWD M52B286S2		Rod/Strut, stabiliser	S050056
	1997.12-2000.05	Rear Axle Left & Right	Saloon RWD M52B286S2		Rod/Strut, stabiliser	S050055
	1997.12-2000.05	Front Axle	Saloon RWD M52B286S2		Stabiliser Bushing	512757
	1997.12-2000.05	Front Axle	Saloon RWD M52B286S2		Stabiliser Bushing	519360
	1997.12-2000.05	Front Axle	Saloon RWD M52B286S2		Stabiliser Bushing	530971
	1997.12-2000.05	Rear Axle	Saloon RWD M52B286S2		Stabiliser Bushing	511588
	1997.12-2000.05	Front Axle	Saloon RWD M52B286S2		Steering Boot	540041
	1997.12-2000.05	Front Axle	Saloon RWD M52B286S2		Steering Boot	540186
	1997.12-2000.05	Front Axle	Saloon RWD M52B286S2	for vehicles with power steering	Steering Rack Bellow Kit	540186S
328i Coupe						
2.8 (142 kw)	1995.01-1999.04	Front Axle Left Lower	Coupe RWD M52B286S1		Track Control Arm	S060114
	1995.01-1999.04	Front Axle Right Lower	Coupe RWD M52B286S1		Track Control Arm	S060113
	1995.01-1999.04	Rear Axle Left & Right Lower Inner	Coupe RWD M52B286S1		Track Control Arm	S060098
	1995.01-1999.04	Front Axle Left & Right Lower	Coupe RWD M52B286S1		Ball Joint	S080020
	1995.01-1999.04	Front Axle Left & Right Lower	Coupe RWD M52B286S1		Ball Joint	S080025
	1995.01-1999.04	Front Axle Left Lower	Coupe RWD M52B286S1		Control Arm Bushing	518074
	1995.01-1999.04	Front Axle Right Lower	Coupe RWD M52B286S1		Control Arm Bushing	518073
	1995.01-1999.04	Front Axle Left & Right Lower	Coupe RWD M52B286S1		Control Arm Bushing	511593
	1995.01-1999.04	Rear Axle Left & Right Upper	Coupe RWD M52B286S1		Control Arm Bushing	512710
	1995.01-1999.04	Rear Axle Left & Right Lower Inner	Coupe RWD M52B286S1		Control Arm Bushing	512305
	1995.01-1999.04	Front Axle Left & Right Lower	Coupe RWD M52B286S1		Control Arm Bushing Kit	530751S
	1995.01-1999.04	Front Axle Left	Coupe RWD M52B286S1		Rod Assembly	S100029
	1995.01-1999.04	Front Axle Right	Coupe RWD M52B286S1		Rod Assembly	S100030
	1995.01-1999.04	Front Axle Left & Right	Coupe RWD M52B286S1		Tie Rod Axle Joint	S030777
	1995.01-1999.04	Front Axle Left	Coupe RWD M52B286S1		Tie Rod End	S070054
	1995.01-1999.04	Front Axle Right	Coupe RWD M52B286S1		Tie Rod End	S070055
	1995.01-1999.04	Front Axle Left & Right	Coupe RWD M52B286S1		Rod/Strut, stabiliser	S050077
	1995.01-1999.04	Rear Axle Left & Right	Coupe RWD M52B286S1		Rod/Strut, stabiliser	S050058
	1995.01-1999.04	Front Axle	Coupe RWD M52B286S1		Stabiliser Bushing	512754
	1995.01-1999.04	Rear Axle	Coupe RWD M52B286S1		Stabiliser Bushing	511588
	1995.01-1999.04	Front Axle	Coupe RWD M52B286S1		Steering Boot	540041
	1995.01-1999.04	Front Axle	Coupe RWD M52B286S1		Steering Boot	540186
	1995.01-1999.04	Front Axle	Coupe RWD M52B286S1		Steering Rack Bellow Kit	540191S
328i Touring						
2.8 (142 kw)	1995.02-1999.04	Front Axle Left Lower	Estate RWD M52B286S1		Track Control Arm	S060114
	1995.02-1999.04	Front Axle Right Lower	Estate RWD M52B286S1		Track Control Arm	S060113
	1995.02-1999.04	Rear Axle Left & Right Lower Inner	Estate RWD M52B286S1		Track Control Arm	S060098
	1995.02-1999.04	Front Axle Left & Right Lower	Estate RWD M52B286S1		Ball Joint	S080020
	1995.02-1999.04	Front Axle Left & Right Lower	Estate RWD M52B286S1		Ball Joint	S080025
	1995.02-1999.04	Front Axle Left Lower	Estate RWD M52B286S1		Control Arm Bushing	518074
	1995.02-1999.04	Front Axle Right Lower	Estate RWD M52B286S1		Control Arm Bushing	518073
	1995.02-1999.04	Front Axle Left & Right Lower	Estate RWD M52B286S1		Control Arm Bushing	511593
	1995.02-1999.04	Rear Axle Left & Right Upper	Estate RWD M52B286S1		Control Arm Bushing	512710
	1995.02-1999.04	Rear Axle Left & Right Lower Inner	Estate RWD M52B286S1		Control Arm Bushing	512305
	1995.02-1999.04	Front Axle Left & Right Lower	Estate RWD M52B286S1		Control Arm Bushing Kit	530751S
	1995.02-1999.04	Front Axle Left	Estate RWD M52B286S1		Rod Assembly	S100029
	1995.02-1999.04	Front Axle Right	Estate RWD M52B286S1		Rod Assembly	S100030
	1995.02-1999.04	Front Axle Left & Right	Estate RWD M52B286S1		Tie Rod Axle Joint	S030777
	1995.02-1999.04	Front Axle Left	Estate RWD M52B286S1		Tie Rod End	S070054
	1995.02-1999.04	Front Axle Right	Estate RWD M52B286S1		Tie Rod End	S070055
	1995.02-1999.04	Front Axle Left & Right	Estate RWD M52B286S1		Rod/Strut, stabiliser	S050077
	1995.02-1999.04	Rear Axle Left & Right	Estate RWD M52B286S1		Rod/Strut, stabiliser	S050058
	1995.02-1999.04	Front Axle	Estate RWD M52B286S1		Stabiliser Bushing	512754
	1995.02-1999.04	Rear Axle	Estate RWD M52B286S1		Stabiliser Bushing	511588
	1995.02-1999.04	Front Axle	Estate RWD M52B286S1		Steering Boot	540041
	1995.02-1999.04	Front Axle	Estate RWD M52B286S1		Steering Boot	540186
	1995.02-1999.04	Front Axle	Estate RWD M52B286S1		Steering Rack Bellow Kit	540191S
328i xDrive						
2.0 (180 kw)	2012.07-2016.08	Front Axle Left Lower Inner	Saloon 4WD N20B20A		Track Control Arm	S063250
	2012.07-2016.08	Front Axle Left Lower Outer	Saloon 4WD N20B20A		Track Control Arm	S063253
	2012.07-2016.08	Front Axle Left Lower Outer	Saloon 4WD N20B20A		Track Control Arm	S063254
	2012.07-2016.08	Front Axle Right Lower Outer	Saloon 4WD N20B20A		Track Control Arm	S063243
	2012.07-2016.08	Front Axle Right Lower Outer	Saloon 4WD N20B20A		Track Control Arm	S063247



	 YEAR	FITTING POSITION	BODY STYLE & DRIVE TYPE & ENGINE	REMARKS	PRODUCT	GSP Ref.
BMW						
328i xDrive						
2.0 (180 kw)	2012.07-2016.08	Rear Axle Left Upper Inner	Saloon 4WD N20B20A		Track Control Arm	S061775
	2012.07-2016.08	Rear Axle Right Upper Inner	Saloon 4WD N20B20A		Track Control Arm	S061776
	2012.07-2016.08	Rear Axle Left & Right Lower Inner	Saloon 4WD N20B20A		Track Control Arm	S061773
	2012.07-2016.08	Rear Axle Left & Right Lower Outer	Saloon 4WD N20B20A		Track Control Arm	S061774
	2012.07-2016.08	Front Axle Left & Right Lower Inner	Saloon 4WD N20B20A		Control Arm Bushing	532583
	2012.07-2016.08	Front Axle Left	Saloon 4WD N20B20A		Rod Assembly	S100350
	2012.07-2016.08	Front Axle Right	Saloon 4WD N20B20A		Rod Assembly	S100351
	2012.07-2016.08	Front Axle Left & Right	Saloon 4WD N20B20A		Tie Rod Axle Joint	S031029
	2012.07-2016.08	Front Axle Left	Saloon 4WD N20B20A		Tie Rod End	S071700
	2012.07-2016.08	Front Axle Right	Saloon 4WD N20B20A		Tie Rod End	S071701
	2012.07-2016.08	Front Axle Left	Saloon 4WD N20B20A		Rod/Strut, stabiliser	S051259
	2012.07-2016.08	Front Axle Left	Saloon 4WD N20B20A	for vehicles with M-Technology for vehicles with electronic suspension control	Rod/Strut, stabiliser	S051353
	2012.07-2016.08	Front Axle Right	Saloon 4WD N20B20A		Rod/Strut, stabiliser	S051260
	2012.07-2016.08	Front Axle Left & Right	Saloon 4WD N20B20A		Rod/Strut, stabiliser	S051353
	2012.07-2016.08	Rear Axle Left	Saloon 4WD N20B20A		Rod/Strut, stabiliser	S051261
	2012.07-2016.08	Rear Axle Right	Saloon 4WD N20B20A		Rod/Strut, stabiliser	S051262
330i						
2.0 (190 kw)	2018.11-	Rear Axle Left	Saloon RWD B48B20B		Rod/Strut, stabiliser	S051261
	2018.11-	Rear Axle Right	Saloon RWD B48B20B		Rod/Strut, stabiliser	S051262
3.0 (170 kw)	2000.06-2005.02	Front Axle Left Lower	Saloon RWD M54B306S3	for vehicles with M-Technology	Track Control Arm	S060117
	2000.06-2005.02	Front Axle Left Lower	Saloon RWD M54B306S3	for vehicles with standard suspension	Track Control Arm	S060358
	2000.06-2005.02	Front Axle Left Lower	Saloon RWD M54B306S3	for vehicles with standard suspension	Track Control Arm	S061164
	2000.06-2005.02	Front Axle Right Lower	Saloon RWD M54B306S3	for vehicles with M-Technology	Track Control Arm	S060118
	2000.06-2005.02	Front Axle Right Lower	Saloon RWD M54B306S3	for vehicles with standard suspension	Track Control Arm	S060359
	2000.06-2005.02	Front Axle Right Lower	Saloon RWD M54B306S3	for vehicles with standard suspension	Track Control Arm	S061165
	2000.06-2005.02	Rear Axle Left & Right Lower Inner	Saloon RWD M54B306S3		Track Control Arm	S060098
	2000.06-2005.02	Front Axle Left Lower	Saloon RWD M54B306S3		Control Arm Bushing	517479
	2000.06-2005.02	Front Axle Right Lower	Saloon RWD M54B306S3		Control Arm Bushing	517478
	2000.06-2005.02	Front Axle Left & Right Lower	Saloon RWD M54B306S3		Control Arm Bushing	510605
	2000.06-2005.02	Rear Axle Left & Right Upper	Saloon RWD M54B306S3		Control Arm Bushing	512710
	2000.06-2005.02	Rear Axle Left & Right Lower Inner	Saloon RWD M54B306S3		Control Arm Bushing	512305
	2000.06-2005.02	Front Axle Left & Right Lower	Saloon RWD M54B306S3		Control Arm Bushing Kit	530752S
	2000.06-2005.02	Front Axle Left & Right Lower	Saloon RWD M54B306S3		Control Arm Bushing Kit	531849S
	2000.06-2005.02	Front Axle	Saloon RWD M54B306S3		Suspension Repair Kit	S990031SK
	2000.06-2005.02	Front Axle Left	Saloon RWD M54B306S3		Rod Assembly	S100254
	2000.06-2005.02	Front Axle Right	Saloon RWD M54B306S3		Rod Assembly	S100017
	2000.06-2005.02	Front Axle Left & Right	Saloon RWD M54B306S3		Tie Rod Axle Joint	S030351
	2000.06-2005.02	Front Axle Left	Saloon RWD M54B306S3		Tie Rod End	S070042
	2000.06-2005.02	Front Axle Right	Saloon RWD M54B306S3		Tie Rod End	S070041
	2000.06-2005.02	Front Axle Left & Right	Saloon RWD M54B306S3		Rod/Strut, stabiliser	S050056
	2000.06-2005.02	Rear Axle Left & Right	Saloon RWD M54B306S3		Rod/Strut, stabiliser	S050055
	2000.06-2005.02	Front Axle	Saloon RWD M54B306S3		Stabiliser Bushing	512757
	2000.06-2005.02	Front Axle	Saloon RWD M54B306S3		Stabiliser Bushing	519360
	2000.06-2005.02	Front Axle	Saloon RWD M54B306S3		Stabiliser Bushing	530971
	2000.06-2005.02	Front Axle	Saloon RWD M54B306S3		Steering Boot	540041
	2000.06-2005.02	Front Axle	Saloon RWD M54B306S3		Steering Boot	540186
	2000.06-2005.02	Front Axle	Saloon RWD M54B306S3	for vehicles with power steering	Steering Rack Bellow Kit	540186S
3.0 (190 kw)	2004.12-2011.10	Front Axle Left Lower Inner	Saloon RWD N52B30A/N52B30BF		Track Control Arm	S060087
	2004.12-2011.10	Front Axle Left Lower Inner	Saloon RWD N52B30A/N52B30BF		Track Control Arm	S062657
	2004.12-2011.10	Front Axle Left Lower Outer	Saloon RWD N52B30A/N52B30BF		Track Control Arm	S060085
	2004.12-2011.10	Front Axle Right Lower Inner	Saloon RWD N52B30A/N52B30BF		Track Control Arm	S060088
	2004.12-2011.10	Front Axle Right Lower Inner	Saloon RWD N52B30A/N52B30BF		Track Control Arm	S062658
	2004.12-2011.10	Front Axle Right Lower Outer	Saloon RWD N52B30A/N52B30BF		Track Control Arm	S060086
	2004.12-2011.10	Rear Axle Left Centre	Saloon RWD N52B30A/N52B30BF		Track Control Arm	S063116
	2004.12-2011.10	Rear Axle Right Centre	Saloon RWD N52B30A/N52B30BF		Track Control Arm	S063115
	2004.12-2011.10	Rear Axle Left & Right Centre	Saloon RWD N52B30A/N52B30BF		Track Control Arm	S060089
	2004.12-2011.10	Rear Axle Left & Right Upper	Saloon RWD N52B30A/N52B30BF		Track Control Arm	S062839
	2004.12-2011.10	Front Axle Left & Right Lower Inner	Saloon RWD N52B30A/N52B30BF		Control Arm Bushing	531936
	2004.12-2011.10	Front Axle	Saloon RWD N52B30A/N52B30BF		Suspension Repair Kit	S990004SK
	2004.12-2011.10	Front Axle Left	Saloon RWD N52B30A/N52B30BF		Rod Assembly	S100330
	2004.12-2011.10	Front Axle Right	Saloon RWD N52B30A/N52B30BF		Rod Assembly	S100331
	2004.12-2011.10	Front Axle Left & Right	Saloon RWD N52B30A/N52B30BF		Tie Rod Axle Joint	S030350
	2004.12-2011.10	Front Axle Left	Saloon RWD N52B30A/N52B30BF		Tie Rod End	S070045
	2004.12-2011.10	Front Axle Right	Saloon RWD N52B30A/N52B30BF		Tie Rod End	S070046



 YEAR	FITTING POSITION	BODY STYLE & DRIVE TYPE & ENGINE	REMARKS	PRODUCT	GSP Ref.	
BMW 330i						
3.0 (190 kw)	2004.12-2011.10	Front Axle Left	Saloon RWD N52B30A/N52B30BF		Rod/Strut, stabiliser S050068	
	2004.12-2011.10	Front Axle Right	Saloon RWD N52B30A/N52B30BF		Rod/Strut, stabiliser S050069	
	2004.12-2011.10	Rear Axle Left & Right	Saloon RWD N52B30A/N52B30BF	L:160mm	Rod/Strut, stabiliser S050070	
	2004.12-2011.10	Rear Axle Left & Right	Saloon RWD N52B30A/N52B30BF	L:161mm	Rod/Strut, stabiliser S051405	
	2004.12-2011.10	Front Axle	Saloon RWD N52B30A/N52B30BF		Stabiliser Bushing 519357	
	2004.12-2011.10	Rear Axle	Saloon RWD N52B30A/N52B30BF	Inner Diameter:13mm	Stabiliser Bushing 535302	
	2004.12-2011.10	Rear Axle	Saloon RWD N52B30A/N52B30BF	Inner Diameter:15mm	Stabiliser Bushing 535305	
330i Cabrio						
3.0 (170 kw)	2000.06-2006.08	Front Axle Left Lower	Cabriolet RWD M54B306S3	for vehicles with M-Technology	Track Control Arm S060117	
	2000.06-2006.08	Front Axle Left Lower	Cabriolet RWD M54B306S3	for vehicles with standard suspension	Track Control Arm S060358	
	2000.06-2006.08	Front Axle Left Lower	Cabriolet RWD M54B306S3	for vehicles with standard suspension	Track Control Arm S061164	
	2000.06-2006.08	Front Axle Right Lower	Cabriolet RWD M54B306S3	for vehicles with M-Technology	Track Control Arm S060118	
	2000.06-2006.08	Front Axle Right Lower	Cabriolet RWD M54B306S3	for vehicles with standard suspension	Track Control Arm S060359	
	2000.06-2006.08	Front Axle Right Lower	Cabriolet RWD M54B306S3	for vehicles with standard suspension	Track Control Arm S061165	
	2000.06-2006.08	Rear Axle Left & Right Lower Inner	Cabriolet RWD M54B306S3		Track Control Arm S060098	
	2000.06-2006.08	Front Axle Left Lower	Cabriolet RWD M54B306S3		Control Arm Bushing 517479	
	2000.06-2006.08	Front Axle Right Lower	Cabriolet RWD M54B306S3		Control Arm Bushing 517478	
	2000.06-2006.08	Front Axle Left & Right Lower	Cabriolet RWD M54B306S3		Control Arm Bushing 510605	
	2000.06-2006.08	Rear Axle Left & Right Upper	Cabriolet RWD M54B306S3		Control Arm Bushing 512710	
	2000.06-2006.08	Rear Axle Left & Right Lower Inner	Cabriolet RWD M54B306S3		Control Arm Bushing 512305	
	2000.06-2006.08	Front Axle Left & Right Lower	Cabriolet RWD M54B306S3		Control Arm Bushing Kit 530752S	
	2000.06-2006.08	Front Axle Left & Right Lower	Cabriolet RWD M54B306S3		Control Arm Bushing Kit 531849S	
	2000.06-2006.08	Front Axle	Cabriolet RWD M54B306S3		Suspension Repair Kit S990031SK	
	2000.06-2006.08	Front Axle Left	Cabriolet RWD M54B306S3		Rod Assembly S100254	
	2000.06-2006.08	Front Axle Right	Cabriolet RWD M54B306S3		Rod Assembly S100017	
	2000.06-2006.08	Front Axle Left & Right	Cabriolet RWD M54B306S3		Tie Rod Axle Joint S030351	
	2000.06-2006.08	Front Axle Left	Cabriolet RWD M54B306S3		Tie Rod End S070042	
	2000.06-2006.08	Front Axle Right	Cabriolet RWD M54B306S3		Tie Rod End S070041	
	2000.06-2006.08	Front Axle Left & Right	Cabriolet RWD M54B306S3		Rod/Strut, stabiliser S050056	
	2000.06-2006.08	Rear Axle Left & Right	Cabriolet RWD M54B306S3		Rod/Strut, stabiliser S050055	
	2000.06-2006.08	Front Axle	Cabriolet RWD M54B306S3		Stabiliser Bushing 512757	
	2000.06-2006.08	Front Axle	Cabriolet RWD M54B306S3		Stabiliser Bushing 519360	
	2000.06-2006.08	Front Axle	Cabriolet RWD M54B306S3		Stabiliser Bushing 530971	
	2000.06-2006.08	Front Axle	Cabriolet RWD M54B306S3		Steering Boot 540041	
	2000.06-2006.08	Front Axle	Cabriolet RWD M54B306S3		Steering Boot 540186	
	2000.06-2006.08	Front Axle	Cabriolet RWD M54B306S3	for vehicles with power steering	Steering Rack Bellow Kit 540186S	
	335i					
	3.0 (225 kw)	2006.09-2011.12	Front Axle Left Lower Inner	Saloon RWD N54B30A/N55B30A		Track Control Arm S060087
2006.09-2011.12		Front Axle Left Lower Inner	Saloon RWD N54B30A/N55B30A		Track Control Arm S062657	
2006.09-2011.12		Front Axle Left Lower Outer	Saloon RWD N54B30A/N55B30A		Track Control Arm S060085	
2006.09-2011.12		Front Axle Right Lower Inner	Saloon RWD N54B30A/N55B30A		Track Control Arm S060088	
2006.09-2011.12		Front Axle Right Lower Inner	Saloon RWD N54B30A/N55B30A		Track Control Arm S062658	
2006.09-2011.12		Front Axle Right Lower Outer	Saloon RWD N54B30A/N55B30A		Track Control Arm S060086	
2006.09-2011.12		Rear Axle Left Centre	Saloon RWD N54B30A/N55B30A		Track Control Arm S063116	
2006.09-2011.12		Rear Axle Right Centre	Saloon RWD N54B30A/N55B30A		Track Control Arm S063115	
2006.09-2011.12		Rear Axle Left & Right Centre	Saloon RWD N54B30A/N55B30A		Track Control Arm S060089	
2006.09-2011.12		Rear Axle Left & Right Upper	Saloon RWD N54B30A/N55B30A		Track Control Arm S062839	
2006.09-2011.12		Front Axle Left & Right Lower Inner	Saloon RWD N54B30A/N55B30A		Control Arm Bushing 531936	
2006.09-2011.12		Front Axle	Saloon RWD N54B30A/N55B30A		Suspension Repair Kit S990004SK	
2006.09-2011.12		Front Axle Left	Saloon RWD N54B30A/N55B30A		Rod Assembly S100330	
2006.09-2011.12		Front Axle Right	Saloon RWD N54B30A/N55B30A		Rod Assembly S100331	
2006.09-2011.12		Front Axle Left & Right	Saloon RWD N54B30A/N55B30A		Tie Rod Axle Joint S030350	
2006.09-2011.12		Front Axle Left	Saloon RWD N54B30A/N55B30A		Tie Rod End S070045	
2006.09-2011.12		Front Axle Right	Saloon RWD N54B30A/N55B30A		Tie Rod End S070046	
2006.09-2011.12		Front Axle Left	Saloon RWD N54B30A/N55B30A		Rod/Strut, stabiliser S050068	
2006.09-2011.12		Front Axle Right	Saloon RWD N54B30A/N55B30A		Rod/Strut, stabiliser S050069	
2006.09-2011.12		Rear Axle Left & Right	Saloon RWD N54B30A/N55B30A	L:160mm	Rod/Strut, stabiliser S050070	
2006.09-2011.12		Rear Axle Left & Right	Saloon RWD N54B30A/N55B30A	L:161mm	Rod/Strut, stabiliser S051405	
2006.09-2011.12		Front Axle	Saloon RWD N54B30A/N55B30A		Stabiliser Bushing 519357	
2006.09-2011.12		Rear Axle	Saloon RWD N54B30A/N55B30A	Inner Diameter:13mm	Stabiliser Bushing 535302	
2006.09-2011.12		Rear Axle	Saloon RWD N54B30A/N55B30A	Inner Diameter:15mm	Stabiliser Bushing 535305	
2006.09-2011.12		Rear Axle	Saloon RWD N54B30A/N55B30A	Inner Diameter:11.1mm	Stabiliser Bushing 535307	



	 YEAR	FITTING POSITION	BODY STYLE & DRIVE TYPE & ENGINE	REMARKS	PRODUCT	GSP Ref.
BMW						
335i Cabrio						
3.0 (225 kw)	2006.12-2013.10	Front Axle Left Lower Inner	Cabriolet RWD N54B30A/N55B30A		Track Control Arm	S060087
	2006.12-2013.10	Front Axle Left Lower Inner	Cabriolet RWD N54B30A/N55B30A		Track Control Arm	S062657
	2006.12-2013.10	Front Axle Left Lower Outer	Cabriolet RWD N54B30A/N55B30A		Track Control Arm	S060085
	2006.12-2013.10	Front Axle Right Lower Inner	Cabriolet RWD N54B30A/N55B30A		Track Control Arm	S060088
	2006.12-2013.10	Front Axle Right Lower Inner	Cabriolet RWD N54B30A/N55B30A		Track Control Arm	S062658
	2006.12-2013.10	Front Axle Right Lower Outer	Cabriolet RWD N54B30A/N55B30A		Track Control Arm	S060086
	2006.12-2013.10	Rear Axle Left Centre	Cabriolet RWD N54B30A/N55B30A		Track Control Arm	S063116
	2006.12-2013.10	Rear Axle Right Centre	Cabriolet RWD N54B30A/N55B30A		Track Control Arm	S063115
	2006.12-2013.10	Rear Axle Left & Right Centre	Cabriolet RWD N54B30A/N55B30A		Track Control Arm	S060089
	2006.12-2013.10	Rear Axle Left & Right Upper	Cabriolet RWD N54B30A/N55B30A		Track Control Arm	S062839
	2006.12-2013.10	Front Axle Left & Right Lower Inner	Cabriolet RWD N54B30A/N55B30A		Control Arm Bushing	531936
	2006.12-2013.10	Front Axle	Cabriolet RWD N54B30A/N55B30A		Suspension Repair Kit	S990004SK
	2006.12-2013.10	Front Axle Left	Cabriolet RWD N54B30A/N55B30A		Rod Assembly	S100330
	2006.12-2013.10	Front Axle Right	Cabriolet RWD N54B30A/N55B30A		Rod Assembly	S100331
	2006.12-2013.10	Front Axle Left & Right	Cabriolet RWD N54B30A/N55B30A		Tie Rod Axle Joint	S030350
	2006.12-2013.10	Front Axle Left	Cabriolet RWD N54B30A/N55B30A		Tie Rod End	S070045
	2006.12-2013.10	Front Axle Right	Cabriolet RWD N54B30A/N55B30A		Tie Rod End	S070046
	2006.12-2013.10	Front Axle Left	Cabriolet RWD N54B30A/N55B30A		Rod/Strut, stabiliser	S050068
	2006.12-2013.10	Front Axle Right	Cabriolet RWD N54B30A/N55B30A		Rod/Strut, stabiliser	S050069
	2006.12-2013.10	Rear Axle Left & Right	Cabriolet RWD N54B30A/N55B30A	L:160mm	Rod/Strut, stabiliser	S050070
	2006.12-2013.10	Rear Axle Left & Right	Cabriolet RWD N54B30A/N55B30A	L:161mm	Rod/Strut, stabiliser	S051405
	2006.12-2013.10	Front Axle	Cabriolet RWD N54B30A/N55B30A		Stabiliser Bushing	519357
	2006.12-2013.10	Rear Axle	Cabriolet RWD N54B30A/N55B30A	Inner Diameter:13mm	Stabiliser Bushing	535302
	2006.12-2013.10	Rear Axle	Cabriolet RWD N54B30A/N55B30A	Inner Diameter:15mm	Stabiliser Bushing	535305
	2006.12-2013.10	Rear Axle	Cabriolet RWD N54B30A/N55B30A	Inner Diameter:11.1mm	Stabiliser Bushing	535307
420i Cabrio						
2.0 (135 kw)	2014.07-2016.02	Front Axle Left Lower Inner	Cabriolet RWD N20B20B		Track Control Arm	S061616
	2014.07-2016.02	Front Axle Left Lower Outer	Cabriolet RWD N20B20B		Track Control Arm	S061614
	2014.07-2016.02	Front Axle Right Lower Inner	Cabriolet RWD N20B20B		Track Control Arm	S061617
	2014.07-2016.02	Front Axle Right Lower Outer	Cabriolet RWD N20B20B		Track Control Arm	S061615
	2014.07-2016.02	Rear Axle Left Upper Inner	Cabriolet RWD N20B20B		Track Control Arm	S061775
	2014.07-2016.02	Rear Axle Right Upper Inner	Cabriolet RWD N20B20B		Track Control Arm	S061776
	2014.07-2016.02	Rear Axle Left & Right Lower Inner	Cabriolet RWD N20B20B		Track Control Arm	S061773
	2014.07-2016.02	Rear Axle Left & Right Lower Outer	Cabriolet RWD N20B20B		Track Control Arm	S061774
	2014.07-2016.02	Front Axle Left & Right Lower Inner	Cabriolet RWD N20B20B		Control Arm Bushing	532583
	2014.07-2016.02	Front Axle Left & Right Lower Outer	Cabriolet RWD N20B20B		Control Arm Bushing	533483
	2014.07-2016.02	Front Axle Left	Cabriolet RWD N20B20B	for vehicles with Adaptive Drive	Rod/Strut, stabiliser	S051259
	2014.07-2016.02	Front Axle Left	Cabriolet RWD N20B20B	for vehicles with M-Technology for vehicles with electronic suspension control	Rod/Strut, stabiliser	S051353
	2014.07-2016.02	Front Axle Right	Cabriolet RWD N20B20B		Rod/Strut, stabiliser	S051260
	2014.07-2016.02	Front Axle Left & Right	Cabriolet RWD N20B20B	for vehicles without Adaptive Drive	Rod/Strut, stabiliser	S051259
	2014.07-2016.02	Front Axle Left & Right	Cabriolet RWD N20B20B	for vehicles with standard suspension for vehicles without electronic suspension control	Rod/Strut, stabiliser	S051353
	2014.07-2016.02	Rear Axle Left	Cabriolet RWD N20B20B		Rod/Strut, stabiliser	S051261
	2014.07-2016.02	Rear Axle Right	Cabriolet RWD N20B20B		Rod/Strut, stabiliser	S051262
428i Cabrio						
2.0 (180 kw)	2013.11-2017.02	Front Axle Left Lower Inner	Cabriolet RWD N20B20A/N26B20A		Track Control Arm	S061616
	2013.11-2017.02	Front Axle Left Lower Outer	Cabriolet RWD N20B20A/N26B20A		Track Control Arm	S061614
	2013.11-2017.02	Front Axle Right Lower Inner	Cabriolet RWD N20B20A/N26B20A		Track Control Arm	S061617
	2013.11-2017.02	Front Axle Right Lower Outer	Cabriolet RWD N20B20A/N26B20A		Track Control Arm	S061615
	2013.11-2017.02	Rear Axle Left Upper Inner	Cabriolet RWD N20B20A/N26B20A		Track Control Arm	S061775
	2013.11-2017.02	Rear Axle Right Upper Inner	Cabriolet RWD N20B20A/N26B20A		Track Control Arm	S061776
	2013.11-2017.02	Rear Axle Left & Right Lower Inner	Cabriolet RWD N20B20A/N26B20A		Track Control Arm	S061773
	2013.11-2017.02	Rear Axle Left & Right Lower Outer	Cabriolet RWD N20B20A/N26B20A		Track Control Arm	S061774
	2013.11-2017.02	Front Axle Left & Right Lower Inner	Cabriolet RWD N20B20A/N26B20A		Control Arm Bushing	532583
	2013.11-2017.02	Front Axle Left & Right Lower Outer	Cabriolet RWD N20B20A/N26B20A		Control Arm Bushing	533483
	2013.11-2017.02	Front Axle Left	Cabriolet RWD N20B20A/N26B20A	for vehicles with Adaptive Drive	Rod/Strut, stabiliser	S051259
	2013.11-2017.02	Front Axle Left	Cabriolet RWD N20B20A/N26B20A	for vehicles with M-Technology for vehicles with electronic suspension control	Rod/Strut, stabiliser	S051353
	2013.11-2017.02	Front Axle Right	Cabriolet RWD N20B20A/N26B20A		Rod/Strut, stabiliser	S051260
	2013.11-2017.02	Front Axle Left & Right	Cabriolet RWD N20B20A/N26B20A	for vehicles without Adaptive Drive	Rod/Strut, stabiliser	S051259
	2013.11-2017.02	Front Axle Left & Right	Cabriolet RWD N20B20A/N26B20A	for vehicles with standard suspension for vehicles without electronic suspension control	Rod/Strut, stabiliser	S051353
	2013.11-2017.02	Rear Axle Left	Cabriolet RWD N20B20A/N26B20A		Rod/Strut, stabiliser	S051261
	2013.11-2017.02	Rear Axle Right	Cabriolet RWD N20B20A/N26B20A		Rod/Strut, stabiliser	S051262
428i Coupe						
2.0 (180 kw)	2013.07-2017.12	Front Axle Left Lower Inner	Coupe RWD N20B20A/N26B20A	For OE no.31 12 6 852 991	Track Control Arm	S061616
	2013.07-2017.12	Front Axle Left Lower Inner	Coupe RWD N20B20A/N26B20A		Track Control Arm	S063250



	 YEAR	FITTING POSITION	BODY STYLE & DRIVE TYPE & ENGINE	REMARKS	PRODUCT	GSP Ref.
BMW						
428i Coupe						
2.0 (180 kw)	2013.07-2017.12	Front Axle Left Lower Outer	Coupe RWD N20B20A/N26B20A	For OE no.31126851259	Track Control Arm	S061614
	2013.07-2017.12	Front Axle Left Lower Outer	Coupe RWD N20B20A/N26B20A		Track Control Arm	S063254
	2013.07-2017.12	Front Axle Right Lower Inner	Coupe RWD N20B20A/N26B20A		Track Control Arm	S061617
	2013.07-2017.12	Front Axle Right Lower Outer	Coupe RWD N20B20A/N26B20A	For OE no.31126851260	Track Control Arm	S061615
	2013.07-2017.12	Front Axle Right Lower Outer	Coupe RWD N20B20A/N26B20A		Track Control Arm	S063243
	2013.07-2017.12	Rear Axle Left Upper Inner	Coupe RWD N20B20A/N26B20A		Track Control Arm	S061775
	2013.07-2017.12	Rear Axle Right Upper Inner	Coupe RWD N20B20A/N26B20A		Track Control Arm	S061776
	2013.07-2017.12	Rear Axle Left & Right Lower Inner	Coupe RWD N20B20A/N26B20A		Track Control Arm	S061773
	2013.07-2017.12	Rear Axle Left & Right Lower Outer	Coupe RWD N20B20A/N26B20A		Track Control Arm	S061774
	2013.07-2017.12	Front Axle Left & Right Lower Inner	Coupe RWD N20B20A/N26B20A		Control Arm Bushing	532583
	2013.07-2017.12	Front Axle Left & Right Lower Outer	Coupe RWD N20B20A/N26B20A		Control Arm Bushing	533483
	2013.07-2017.12	Front Axle Left	Coupe RWD N20B20A/N26B20A	for vehicles with Adaptive Drive	Rod/Strut, stabiliser	S051259
	2013.07-2017.12	Front Axle Left	Coupe RWD N20B20A/N26B20A	for vehicles with M-Technology for vehicles with electronic suspension control	Rod/Strut, stabiliser	S051353
	2013.07-2017.12	Front Axle Right	Coupe RWD N20B20A/N26B20A		Rod/Strut, stabiliser	S051260
	2013.07-2017.12	Front Axle Left & Right	Coupe RWD N20B20A/N26B20A	for vehicles without Adaptive Drive	Rod/Strut, stabiliser	S051259
	2013.07-2017.12	Front Axle Left & Right	Coupe RWD N20B20A/N26B20A	for vehicles with standard suspension for vehicles without electronic suspension control	Rod/Strut, stabiliser	S051353
	2013.07-2017.12	Rear Axle Left	Coupe RWD N20B20A/N26B20A		Rod/Strut, stabiliser	S051261
	2013.07-2017.12	Rear Axle Right	Coupe RWD N20B20A/N26B20A		Rod/Strut, stabiliser	S051262
428i Gran Coupe						
2.0 (180 kw)	2014.03-2016.02	Front Axle Left Lower Inner	Coupe RWD N20B20A		Track Control Arm	S061616
	2014.03-2016.02	Front Axle Left Lower Outer	Coupe RWD N20B20A		Track Control Arm	S061614
	2014.03-2016.02	Front Axle Right Lower Inner	Coupe RWD N20B20A		Track Control Arm	S061617
	2014.03-2016.02	Front Axle Right Lower Outer	Coupe RWD N20B20A		Track Control Arm	S061615
	2014.03-2016.02	Rear Axle Left Upper Inner	Coupe RWD N20B20A		Track Control Arm	S061775
	2014.03-2016.02	Rear Axle Right Upper Inner	Coupe RWD N20B20A		Track Control Arm	S061776
	2014.03-2016.02	Rear Axle Left & Right Lower Inner	Coupe RWD N20B20A		Track Control Arm	S061773
	2014.03-2016.02	Rear Axle Left & Right Lower Outer	Coupe RWD N20B20A		Track Control Arm	S061774
	2014.03-2016.02	Front Axle Left & Right Lower Inner	Coupe RWD N20B20A		Control Arm Bushing	532583
	2014.03-2016.02	Front Axle Left & Right Lower Outer	Coupe RWD N20B20A		Control Arm Bushing	533483
	2014.03-2016.02	Front Axle Left	Coupe RWD N20B20A	for vehicles with Adaptive Drive	Rod/Strut, stabiliser	S051259
	2014.03-2016.02	Front Axle Left	Coupe RWD N20B20A	for vehicles with M-Technology for vehicles with electronic suspension control	Rod/Strut, stabiliser	S051353
	2014.03-2016.02	Front Axle Right	Coupe RWD N20B20A		Rod/Strut, stabiliser	S051260
	2014.03-2016.02	Front Axle Left & Right	Coupe RWD N20B20A	for vehicles without Adaptive Drive	Rod/Strut, stabiliser	S051259
	2014.03-2016.02	Front Axle Left & Right	Coupe RWD N20B20A	for vehicles with standard suspension for vehicles without electronic suspension control	Rod/Strut, stabiliser	S051353
	2014.03-2016.02	Rear Axle Left	Coupe RWD N20B20A		Rod/Strut, stabiliser	S051261
	2014.03-2016.02	Rear Axle Right	Coupe RWD N20B20A		Rod/Strut, stabiliser	S051262
430i Cabrio						
2.0 (185 kw)	2016.03-	Front Axle Left Lower Inner	Cabriolet RWD B48B20B		Track Control Arm	S061616
	2016.03-	Front Axle Left Lower Outer	Cabriolet RWD B48B20B		Track Control Arm	S061614
	2016.03-	Front Axle Right Lower Inner	Cabriolet RWD B48B20B		Track Control Arm	S061617
	2016.03-	Front Axle Right Lower Outer	Cabriolet RWD B48B20B		Track Control Arm	S061615
	2016.03-	Rear Axle Left Upper Inner	Cabriolet RWD B48B20B		Track Control Arm	S061775
	2016.03-	Rear Axle Right Upper Inner	Cabriolet RWD B48B20B		Track Control Arm	S061776
	2016.03-	Rear Axle Left & Right Lower Inner	Cabriolet RWD B48B20B		Track Control Arm	S061773
	2016.03-	Rear Axle Left & Right Lower Outer	Cabriolet RWD B48B20B		Track Control Arm	S061774
	2016.03-	Front Axle Left & Right Lower Inner	Cabriolet RWD B48B20B		Control Arm Bushing	532583
	2016.03-	Front Axle Left & Right Lower Outer	Cabriolet RWD B48B20B		Control Arm Bushing	533483
	2016.03-	Front Axle Left	Cabriolet RWD B48B20B	for vehicles with Adaptive Drive	Rod/Strut, stabiliser	S051259
	2016.03-	Front Axle Left	Cabriolet RWD B48B20B	for vehicles with M-Technology for vehicles with electronic suspension control	Rod/Strut, stabiliser	S051353
	2016.03-	Front Axle Right	Cabriolet RWD B48B20B		Rod/Strut, stabiliser	S051260
	2016.03-	Front Axle Left & Right	Cabriolet RWD B48B20B	for vehicles without Adaptive Drive	Rod/Strut, stabiliser	S051259
	2016.03-	Front Axle Left & Right	Cabriolet RWD B48B20B	for vehicles with standard suspension for vehicles without electronic suspension control	Rod/Strut, stabiliser	S051353
	2016.03-	Rear Axle Left	Cabriolet RWD B48B20B		Rod/Strut, stabiliser	S051261
	2016.03-	Rear Axle Right	Cabriolet RWD B48B20B		Rod/Strut, stabiliser	S051262
430i Gran Coupe						
2.0 (185 kw)	2016.03-	Front Axle Left Lower Inner	Coupe RWD B48B20B		Track Control Arm	S061616
	2016.03-	Front Axle Left Lower Outer	Coupe RWD B48B20B		Track Control Arm	S061614
	2016.03-	Front Axle Right Lower Inner	Coupe RWD B48B20B		Track Control Arm	S061617
	2016.03-	Front Axle Right Lower Outer	Coupe RWD B48B20B		Track Control Arm	S061615
	2016.03-	Rear Axle Left Upper Inner	Coupe RWD B48B20B		Track Control Arm	S061775
	2016.03-	Rear Axle Right Upper Inner	Coupe RWD B48B20B		Track Control Arm	S061776
	2016.03-	Rear Axle Left & Right Lower Inner	Coupe RWD B48B20B		Track Control Arm	S061773
	2016.03-	Rear Axle Left & Right Lower Outer	Coupe RWD B48B20B		Track Control Arm	S061774
	2016.03-	Front Axle Left & Right Lower Inner	Coupe RWD B48B20B		Control Arm Bushing	532583
	2016.03-	Front Axle Left & Right Lower Outer	Coupe RWD B48B20B		Control Arm Bushing	533483



	 YEAR	FITTING POSITION	BODY STYLE & DRIVE TYPE & ENGINE	REMARKS	PRODUCT	GSP Ref.
BMW						
430i Gran Coupe						
2.0 (185 kw)	2016.03-	Front Axle Left & Right Lower Outer	Coupe RWD B48B20B		Control Arm Bushing	533483
	2016.03-	Front Axle Left	Coupe RWD B48B20B	Engine Code B48 B20 B, for vehicles with Adaptive Drive	Rod/Strut, stabiliser	S051259
	2016.03-	Front Axle Left	Coupe RWD B48B20B	for vehicles with M-Technology for vehicles with electronic suspension control	Rod/Strut, stabiliser	S051353
	2016.03-	Front Axle Right	Coupe RWD B48B20B		Rod/Strut, stabiliser	S051260
	2016.03-	Front Axle Left & Right	Coupe RWD B48B20B	for vehicles without Adaptive Drive	Rod/Strut, stabiliser	S051259
	2016.03-	Front Axle Left & Right	Coupe RWD B48B20B	for vehicles with standard suspension for vehicles without electronic suspension control	Rod/Strut, stabiliser	S051353
	2016.03-	Rear Axle Left	Coupe RWD B48B20B		Rod/Strut, stabiliser	S051261
	2016.03-	Rear Axle Right	Coupe RWD B48B20B		Rod/Strut, stabiliser	S051262
435i Coupe						
3.0 (225 kw)	2013.07-2016.02	Front Axle Left Lower Inner	Coupe RWD N55B30A	For OE no.31 12 6 852 991	Track Control Arm	S061616
	2013.07-2016.02	Front Axle Left Lower Inner	Coupe RWD N55B30A		Track Control Arm	S063250
	2013.07-2016.02	Front Axle Left Lower Outer	Coupe RWD N55B30A	For OE no.31126851259	Track Control Arm	S061614
	2013.07-2016.02	Front Axle Left Lower Outer	Coupe RWD N55B30A		Track Control Arm	S063254
	2013.07-2016.02	Front Axle Right Lower Inner	Coupe RWD N55B30A		Track Control Arm	S061617
	2013.07-2016.02	Front Axle Right Lower Outer	Coupe RWD N55B30A	For OE no.31126851260	Track Control Arm	S061615
	2013.07-2016.02	Front Axle Right Lower Outer	Coupe RWD N55B30A		Track Control Arm	S063243
	2013.07-2016.02	Rear Axle Left Upper Inner	Coupe RWD N55B30A		Track Control Arm	S061775
	2013.07-2016.02	Rear Axle Right Upper Inner	Coupe RWD N55B30A		Track Control Arm	S061776
	2013.07-2016.02	Rear Axle Left & Right Lower Inner	Coupe RWD N55B30A		Track Control Arm	S061773
	2013.07-2016.02	Rear Axle Left & Right Lower Outer	Coupe RWD N55B30A		Track Control Arm	S061774
	2013.07-2016.02	Front Axle Left & Right Lower Inner	Coupe RWD N55B30A		Control Arm Bushing	532583
	2013.07-2016.02	Front Axle Left & Right Lower Outer	Coupe RWD N55B30A		Control Arm Bushing	533483
	2013.07-2016.02	Front Axle Right	Coupe RWD N55B30A		Rod Assembly	S100351
	2013.07-2016.02	Front Axle Left & Right	Coupe RWD N55B30A		Tie Rod Axle Joint	S031029
	2013.07-2016.02	Front Axle Left	Coupe RWD N55B30A	Length:145mm	Tie Rod End	S071700
	2013.07-2016.02	Front Axle Right	Coupe RWD N55B30A	Length:145mm	Tie Rod End	S071701
	2013.07-2016.02	Front Axle Left	Coupe RWD N55B30A	for vehicles with Adaptive Drive	Rod/Strut, stabiliser	S051259
	2013.07-2016.02	Front Axle Left	Coupe RWD N55B30A	for vehicles with M-Technology for vehicles with electronic suspension control	Rod/Strut, stabiliser	S051353
	2013.07-2016.02	Front Axle Right	Coupe RWD N55B30A		Rod/Strut, stabiliser	S051260
	2013.07-2016.02	Front Axle Left & Right	Coupe RWD N55B30A	for vehicles without Adaptive Drive	Rod/Strut, stabiliser	S051259
	2013.07-2016.02	Front Axle Left & Right	Coupe RWD N55B30A	for vehicles with standard suspension for vehicles without electronic suspension control	Rod/Strut, stabiliser	S051353
	2013.07-2016.02	Rear Axle Left	Coupe RWD N55B30A		Rod/Strut, stabiliser	S051261
	2013.07-2016.02	Rear Axle Right	Coupe RWD N55B30A		Rod/Strut, stabiliser	S051262
525i						
2.5 (141 kw)	1990.03-1995.08	Front Axle Left Lower	Saloon RWD M50B256S1/M50B256S2		Track Control Arm	S060099
	1990.03-1995.08	Front Axle Left Lower	Saloon RWD M50B256S1/M50B256S2		Track Control Arm	S060116
	1990.03-1995.08	Front Axle Left Upper	Saloon RWD M50B256S1/M50B256S2		Track Control Arm	S100027
	1990.03-1995.08	Front Axle Right Lower	Saloon RWD M50B256S1/M50B256S2		Track Control Arm	S060100
	1990.03-1995.08	Front Axle Right Lower	Saloon RWD M50B256S1/M50B256S2		Track Control Arm	S060115
	1990.03-1995.08	Front Axle Right Upper	Saloon RWD M50B256S1/M50B256S2		Track Control Arm	S100028
	1990.03-1995.08	Front Axle Left & Right Lower	Saloon RWD M50B256S1/M50B256S2		Control Arm Bushing	510608
	1990.03-1995.08	Front Axle Left & Right Upper	Saloon RWD M50B256S1/M50B256S2		Control Arm Bushing	S10595
	1990.03-1995.08	Front Axle Left & Right Lower Inner	Saloon RWD M50B256S1/M50B256S2		Control Arm Bushing	510610
	1990.03-1995.08	Front Axle	Saloon RWD M50B256S1/M50B256S2		Suspension Repair Kit	S990055SK
	1990.03-1995.08	Front Axle Left & Right	Saloon RWD M50B256S1/M50B256S2		Rod Assembly	S100019
	1990.03-1995.08	Front Axle Left & Right Centre	Saloon RWD M50B256S1/M50B256S2	For Left-Hand Drive Vehicles	Rod Assembly	S100026
	1990.03-1995.08	Front Axle Left & Right Centre	Saloon RWD M50B256S1/M50B256S2		Rod Assembly	S100373
	1990.03-1995.08	Front Axle Left & Right	Saloon RWD M50B256S1/M50B256S2		Tie Rod End	S070048
	1990.03-1995.08	Front Axle Left & Right	Saloon RWD M50B256S1/M50B256S2		Tie Rod End	S070049
	1990.03-1995.08	Front Axle Left & Right	Saloon RWD M50B256S1/M50B256S2		Tie Rod End	S070824
	1990.03-1995.08	Front Axle Left & Right	Saloon RWD M50B256S1/M50B256S2		Rod/Strut, stabiliser	S050078
	1990.03-1995.08	Rear Axle Left & Right	Saloon RWD M50B256S1/M50B256S2		Rod/Strut, stabiliser	520093
	1990.03-1995.08	Rear Axle Left & Right	Saloon RWD M50B256S1/M50B256S2		Rod/Strut, stabiliser	S100020
	1990.03-1995.08	Front Axle	Saloon RWD M50B256S1/M50B256S2		Stabiliser Bushing	517356
	1990.03-1995.08	Rear Axle	Saloon RWD M50B256S1/M50B256S2		Stabiliser Bushing	511588
	1990.03-1995.08	Front Axle	Saloon RWD M50B256S1/M50B256S2		Steering Boot	540041
	1990.03-1995.08	Front Axle	Saloon RWD M50B256S1/M50B256S2		Steering Boot	540186
	2000.09-2003.06	Front Axle Left Lower Inner	Saloon RWD M54B256S5		Track Control Arm	S060106
	2000.09-2003.06	Front Axle Left Lower Outer	Saloon RWD M54B256S5		Track Control Arm	S060060
	2000.09-2003.06	Front Axle Right Lower Inner	Saloon RWD M54B256S5		Track Control Arm	S060105
	2000.09-2003.06	Front Axle Right Lower Outer	Saloon RWD M54B256S5		Track Control Arm	S060059
	2000.09-2003.06	Rear Axle Left Upper Outer	Saloon RWD M54B256S5		Track Control Arm	S060058
	2000.09-2003.06	Rear Axle Right Upper Outer	Saloon RWD M54B256S5		Track Control Arm	S060057
	2000.09-2003.06	Rear Axle Left & Right Lower	Saloon RWD M54B256S5		Track Control Arm	S060068



	 YEAR	FITTING POSITION	BODY STYLE & DRIVE TYPE & ENGINE	REMARKS	PRODUCT	GSP Ref.
BMW						
525i						
2.5 (141 kw)	2000.09-2003.06	Rear Axle Left & Right Upper Inner	Saloon RWD M54B256S5	Date to:2001.12	Track Control Arm	S060061
	2000.09-2003.06	Rear Axle Left & Right Upper Inner	Saloon RWD M54B256S5	Date from:2001.12	Track Control Arm	S060082
	2000.09-2003.06	Front Axle Left & Right Lower Inner	Saloon RWD M54B256S5		Control Arm Bushing	510610
	2000.09-2003.06	Front Axle Left & Right Lower Outer	Saloon RWD M54B256S5		Control Arm Bushing	510609
	2000.09-2003.06	Rear Axle Left & Right Lower	Saloon RWD M54B256S5		Control Arm Bushing	517758
	2000.09-2003.06	Rear Axle Left & Right Lower	Saloon RWD M54B256S5		Control Arm Bushing	517765
	2000.09-2003.06	Rear Axle Left & Right Upper Inner	Saloon RWD M54B256S5		Control Arm Bushing	510619
	2000.09-2003.06	Rear Axle Left & Right Upper Inner	Saloon RWD M54B256S5	Date from:2001.12	Control Arm Bushing	517353
	2000.09-2003.06	Rear Axle Left & Right Upper Outer	Saloon RWD M54B256S5		Control Arm Bushing	517802
	2000.09-2003.06	Front Axle Left & Right Lower Outer	Saloon RWD M54B256S5		Control Arm Bushing Kit	510609S
	2000.09-2003.06	Front Axle	Saloon RWD M54B256S5		Suspension Repair Kit	S990002SK
	2000.09-2003.06	Front Axle	Saloon RWD M54B256S5		Suspension Repair Kit	S990030SK
	2000.09-2003.06	Rear Axle	Saloon RWD M54B256S5	Date from:2001.12	Suspension Repair Kit	S990051SK
	2000.09-2003.06	Front Axle Left	Saloon RWD M54B256S5		Rod Assembly	S100033
	2000.09-2003.06	Front Axle Right	Saloon RWD M54B256S5		Rod Assembly	S100032
	2000.09-2003.06	Front Axle Left & Right	Saloon RWD M54B256S5		Tie Rod Axle Joint	S030993
	2000.09-2003.06	Front Axle Left	Saloon RWD M54B256S5		Tie Rod End	S070050
	2000.09-2003.06	Front Axle Right	Saloon RWD M54B256S5		Tie Rod End	S070051
	2000.09-2003.06	Front Axle Left	Saloon RWD M54B256S5		Rod/Strut,stabiliser	S100035
	2000.09-2003.06	Front Axle Right	Saloon RWD M54B256S5		Rod/Strut,stabiliser	S100034
	2000.09-2003.06	Rear Axle Left & Right	Saloon RWD M54B256S5		Rod/Strut,stabiliser	S050057
	2000.09-2003.06	Front Axle	Saloon RWD M54B256S5		Stabiliser Bushing	517781
	2000.09-2003.06	Front Axle	Saloon RWD M54B256S5		Stabiliser Bushing	519361
	2000.09-2003.06	Rear Axle	Saloon RWD M54B256S5		Stabiliser Bushing	512299
	2000.09-2003.06	Front Axle	Saloon RWD M54B256S5		Steering Boot	540041
	2000.09-2003.06	Front Axle	Saloon RWD M54B256S5		Steering Boot	540186
	2003.09-2005.02	Front Axle Left Lower Inner	Saloon RWD M54B256S5		Track Control Arm	S060078
	2003.09-2005.02	Front Axle Left Lower Outer	Saloon RWD M54B256S5		Track Control Arm	S060080
	2003.09-2005.02	Front Axle Right Lower Inner	Saloon RWD M54B256S5		Track Control Arm	S060079
	2003.09-2005.02	Front Axle Right Lower Outer	Saloon RWD M54B256S5		Track Control Arm	S060081
	2003.09-2005.02	Rear Axle Left Upper Outer	Saloon RWD M54B256S5		Track Control Arm	S060058
	2003.09-2005.02	Rear Axle Right Upper Outer	Saloon RWD M54B256S5		Track Control Arm	S060057
	2003.09-2005.02	Rear Axle Left & Right Lower	Saloon RWD M54B256S5		Track Control Arm	S060068
	2003.09-2005.02	Rear Axle Left & Right Upper Inner	Saloon RWD M54B256S5		Track Control Arm	S060082
	2003.09-2005.02	Front Axle Left & Right Lower	Saloon RWD M54B256S5		Control Arm Bushing	510608
	2003.09-2005.02	Front Axle Left & Right Lower Inner	Saloon RWD M54B256S5		Control Arm Bushing	510610
	2003.09-2005.02	Front Axle Left & Right Lower Inner	Saloon RWD M54B256S5		Control Arm Bushing	517838
	2003.09-2005.02	Front Axle Left & Right Lower Outer	Saloon RWD M54B256S5		Control Arm Bushing	517804
	2003.09-2005.02	Rear Axle Left & Right Lower	Saloon RWD M54B256S5		Control Arm Bushing	516310
	2003.09-2005.02	Rear Axle Left & Right Lower	Saloon RWD M54B256S5		Control Arm Bushing	516314
	2003.09-2005.02	Rear Axle Left & Right Upper	Saloon RWD M54B256S5		Control Arm Bushing	510616
	2003.09-2005.02	Rear Axle Left & Right Upper Inner	Saloon RWD M54B256S5		Control Arm Bushing	510619
	2003.09-2005.02	Rear Axle Left & Right Upper Inner	Saloon RWD M54B256S5	Date from:2001.12	Control Arm Bushing	517353
	2003.09-2005.02	Front Axle	Saloon RWD M54B256S5		Suspension Repair Kit	S990018SK
	2003.09-2005.02	Front Axle Left & Right	Saloon RWD M54B256S5		Rod Assembly	S100329
	2003.09-2005.02	Front Axle Left & Right	Saloon RWD M54B256S5		Tie Rod Axle Joint	S030348
	2003.09-2005.02	Front Axle Left & Right	Saloon RWD M54B256S5		Tie Rod End	S070551
	2003.09-2005.02	Front Axle Left	Saloon RWD M54B256S5		Rod/Strut,stabiliser	S050065
	2003.09-2005.02	Front Axle Right	Saloon RWD M54B256S5		Rod/Strut,stabiliser	S050066
	2003.09-2005.02	Rear Axle Left & Right	Saloon RWD M54B256S5	for vehicles without active stabiliser control	Rod/Strut,stabiliser	S050067
	2003.09-2005.02	Rear Axle Left & Right	Saloon RWD M54B256S5	for vehicles with active stabilizer	Rod/Strut,stabiliser	S050760
	2003.09-2005.02	Front Axle	Saloon RWD M54B256S5		Stabiliser Bushing	517997
	2003.09-2005.02	Front Axle	Saloon RWD M54B256S5		Steering Boot	540440
	2003.09-2005.02	Front Axle	Saloon RWD M54B256S5	For OE.no.32106785993	Steering Rack Bellow Kit	540417S
528i						
2.0 (180 kw)	2011.09-2016.10	Front Axle Left Lower Inner	Saloon RWD N20B20A		Track Control Arm	S061168
	2011.09-2016.10	Front Axle Left Lower Outer	Saloon RWD N20B20A		Track Control Arm	S061166
	2011.09-2016.10	Front Axle Right Lower Inner	Saloon RWD N20B20A		Track Control Arm	S061169
	2011.09-2016.10	Front Axle Right Lower Outer	Saloon RWD N20B20A		Track Control Arm	S061167
	2011.09-2016.10	Front Axle Left & Right Upper	Saloon RWD N20B20A		Track Control Arm	S061154
	2011.09-2016.10	Rear Axle Left Upper Inner	Saloon RWD N20B20A		Track Control Arm	S062966
	2011.09-2016.10	Rear Axle Right Upper Inner	Saloon RWD N20B20A		Track Control Arm	S062967
	2011.09-2016.10	Rear Axle Left & Right Lower	Saloon RWD N20B20A		Track Control Arm	S061576
	2011.09-2016.10	Rear Axle Left & Right Upper Outer	Saloon RWD N20B20A		Track Control Arm	S063030



	 YEAR	FITTING POSITION	BODY STYLE & DRIVE TYPE & ENGINE	REMARKS	PRODUCT	GSP Ref.	
BMW 528i							
2.0 (180 kw)	2011.09-2016.10	Front Axle Left & Right Lower Inner	Saloon RWD N20B20A		Control Arm Bushing	531934	
	2011.09-2016.10	Front Axle Left & Right Lower Inner	Saloon RWD N20B20A		Control Arm Bushing	532572	
	2011.09-2016.10	Front Axle Left & Right Lower Outer	Saloon RWD N20B20A		Control Arm Bushing	531935	
	2011.09-2016.10	Front Axle Left & Right	Saloon RWD N20B20A		Tie Rod Axle Joint	S030354	
	2011.09-2016.10	Front Axle Left	Saloon RWD N20B20A		Tie Rod End	S070999	
	2011.09-2016.10	Front Axle Right	Saloon RWD N20B20A		Tie Rod End	S071000	
	2011.09-2016.10	Front Axle Left & Right	Saloon RWD N20B20A		Rod/Strut,stabiliser	S051443	
	2011.09-2016.10	Rear Axle Left & Right	Saloon RWD N20B20A		Rod/Strut,stabiliser	S050761	
2.8 (142 kw)	1995.09-2000.08	Front Axle Left Lower Inner	Saloon RWD M52B286S1/M52B286S2		Track Control Arm	S060106	
	1995.09-2000.08	Front Axle Left Lower Outer	Saloon RWD M52B286S1/M52B286S2		Track Control Arm	S060060	
	1995.09-2000.08	Front Axle Right Lower Inner	Saloon RWD M52B286S1/M52B286S2		Track Control Arm	S060105	
	1995.09-2000.08	Front Axle Right Lower Outer	Saloon RWD M52B286S1/M52B286S2		Track Control Arm	S060059	
	1995.09-2000.08	Rear Axle Left Upper Outer	Saloon RWD M52B286S1/M52B286S2		Track Control Arm	S060058	
	1995.09-2000.08	Rear Axle Right Upper Outer	Saloon RWD M52B286S1/M52B286S2		Track Control Arm	S060057	
	1995.09-2000.08	Rear Axle Left & Right Lower	Saloon RWD M52B286S1/M52B286S2		Track Control Arm	S060068	
	1995.09-2000.08	Rear Axle Left & Right Upper Inner	Saloon RWD M52B286S1/M52B286S2		Track Control Arm	S060061	
	1995.09-2000.08	Front Axle Left & Right Lower Inner	Saloon RWD M52B286S1/M52B286S2		Control Arm Bushing	510610	
	1995.09-2000.08	Front Axle Left & Right Lower Outer	Saloon RWD M52B286S1/M52B286S2		Control Arm Bushing	510609	
	1995.09-2000.08	Rear Axle Left & Right Lower	Saloon RWD M52B286S1/M52B286S2		Control Arm Bushing	517758	
	1995.09-2000.08	Rear Axle Left & Right Lower	Saloon RWD M52B286S1/M52B286S2		Control Arm Bushing	517765	
	1995.09-2000.08	Rear Axle Left & Right Upper Inner	Saloon RWD M52B286S1/M52B286S2		Control Arm Bushing	510619	
	1995.09-2000.08	Rear Axle Left & Right Upper Outer	Saloon RWD M52B286S1/M52B286S2		Control Arm Bushing	517802	
	1995.09-2000.08	Front Axle Left & Right Lower Outer	Saloon RWD M52B286S1/M52B286S2		Control Arm Bushing Kit	510609S	
	1995.09-2000.08	Front Axle	Saloon RWD M52B286S1/M52B286S2		Suspension Repair Kit	S990002SK	
	1995.09-2000.08	Front Axle	Saloon RWD M52B286S1/M52B286S2		Suspension Repair Kit	S990030SK	
	1995.09-2000.08	Front Axle Left	Saloon RWD M52B286S1/M52B286S2		Rod Assembly	S100033	
	1995.09-2000.08	Front Axle Right	Saloon RWD M52B286S1/M52B286S2		Rod Assembly	S100032	
	1995.09-2000.08	Front Axle Left & Right	Saloon RWD M52B286S1/M52B286S2		Tie Rod Axle Joint	S030993	
	1995.09-2000.08	Front Axle Left	Saloon RWD M52B286S1/M52B286S2		Tie Rod End	S070050	
	1995.09-2000.08	Front Axle Right	Saloon RWD M52B286S1/M52B286S2		Tie Rod End	S070051	
	1995.09-2000.08	Front Axle Left	Saloon RWD M52B286S1/M52B286S2		Rod/Strut,stabiliser	S100035	
	1995.09-2000.08	Front Axle Right	Saloon RWD M52B286S1/M52B286S2		Rod/Strut,stabiliser	S100034	
	1995.09-2000.08	Rear Axle Left & Right	Saloon RWD M52B286S1/M52B286S2		Rod/Strut,stabiliser	S050057	
	1995.09-2000.08	Front Axle	Saloon RWD M52B286S1/M52B286S2		Stabiliser Bushing	517781	
	1995.09-2000.08	Front Axle	Saloon RWD M52B286S1/M52B286S2		Stabiliser Bushing	519361	
	1995.09-2000.08	Rear Axle	Saloon RWD M52B286S1/M52B286S2		Stabiliser Bushing	512299	
	1995.09-2000.08	Front Axle	Saloon RWD M52B286S1/M52B286S2		Steering Boot	540041	
	1995.09-2000.08	Front Axle	Saloon RWD M52B286S1/M52B286S2		Steering Boot	540186	
	528i xDrive						
	2.0 (180 kw)	2011.09-2016.10	Front Axle Left & Right Upper	Saloon 4WD N20B20A		Track Control Arm	S061154
		2011.09-2016.10	Rear Axle Left Upper Inner	Saloon 4WD N20B20A		Track Control Arm	S062966
2011.09-2016.10		Rear Axle Right Upper Inner	Saloon 4WD N20B20A		Track Control Arm	S062967	
2011.09-2016.10		Rear Axle Left & Right Lower	Saloon 4WD N20B20A		Track Control Arm	S061576	
2011.09-2016.10		Rear Axle Left & Right Upper Outer	Saloon 4WD N20B20A		Track Control Arm	S063030	
2011.09-2016.10		Front Axle Left & Right Lower Inner	Saloon 4WD N20B20A		Control Arm Bushing	531934	
2011.09-2016.10		Front Axle Left & Right	Saloon 4WD N20B20A		Tie Rod Axle Joint	S030354	
2011.09-2016.10		Front Axle Left	Saloon 4WD N20B20A		Tie Rod End	S070999	
2011.09-2016.10		Front Axle Right	Saloon 4WD N20B20A		Tie Rod End	S071000	
2011.09-2016.10		Front Axle Left & Right	Saloon 4WD N20B20A		Rod/Strut,stabiliser	S051443	
2011.09-2016.10		Rear Axle Left & Right	Saloon 4WD N20B20A		Rod/Strut,stabiliser	S050761	
2011.09-2016.10		Front Axle	Saloon 4WD N20B20A		Steering Boot	540440	
530i							
2.0 (185 kw)		2016.09-2020.06	Front Axle Left & Right Upper	Saloon RWD B46B20B/B48B20B		Track Control Arm	S063260
	2016.09-2020.06	Front Axle Left & Right Lower	Saloon RWD B46B20B/B48B20B		Control Arm Bushing	533513	
	2016.09-2020.06	Front Axle Left & Right Upper	Saloon RWD B46B20B/B48B20B		Control Arm Bushing	535314	
3.0 (170 kw)	2000.09-2003.06	Front Axle Left Lower Inner	Saloon RWD M54B306S3		Track Control Arm	S060106	
	2000.09-2003.06	Front Axle Left Lower Outer	Saloon RWD M54B306S3		Track Control Arm	S060060	
	2000.09-2003.06	Front Axle Right Lower Inner	Saloon RWD M54B306S3		Track Control Arm	S060105	
	2000.09-2003.06	Front Axle Right Lower Outer	Saloon RWD M54B306S3		Track Control Arm	S060059	
	2000.09-2003.06	Rear Axle Left Upper Outer	Saloon RWD M54B306S3		Track Control Arm	S060058	
	2000.09-2003.06	Rear Axle Right Upper Outer	Saloon RWD M54B306S3		Track Control Arm	S060057	
	2000.09-2003.06	Rear Axle Left & Right Lower	Saloon RWD M54B306S3		Track Control Arm	S060068	
	2000.09-2003.06	Rear Axle Left & Right Upper Inner	Saloon RWD M54B306S3	Date to:2001.12	Track Control Arm	S060061	



	 YEAR	FITTING POSITION	BODY STYLE & DRIVE TYPE & ENGINE	REMARKS	PRODUCT	GSP Ref.
BMW						
530i						
3.0 (170 kw)	2000.09-2003.06	Rear Axle Left & Right Upper Inner	Saloon RWD M54B306S3	Date from:2001.12	Track Control Arm	S060082
	2000.09-2003.06	Front Axle Left & Right Lower Inner	Saloon RWD M54B306S3		Control Arm Bushing	510610
	2000.09-2003.06	Front Axle Left & Right Lower Outer	Saloon RWD M54B306S3		Control Arm Bushing	510609
	2000.09-2003.06	Rear Axle Left & Right Lower	Saloon RWD M54B306S3		Control Arm Bushing	517758
	2000.09-2003.06	Rear Axle Left & Right Lower	Saloon RWD M54B306S3		Control Arm Bushing	517765
	2000.09-2003.06	Rear Axle Left & Right Upper Inner	Saloon RWD M54B306S3		Control Arm Bushing	510619
	2000.09-2003.06	Rear Axle Left & Right Upper Inner	Saloon RWD M54B306S3	Date from:2002.01	Control Arm Bushing	517353
	2000.09-2003.06	Rear Axle Left & Right Upper Outer	Saloon RWD M54B306S3		Control Arm Bushing	517802
	2000.09-2003.06	Front Axle Left & Right Lower Outer	Saloon RWD M54B306S3		Control Arm Bushing Kit	510609S
	2000.09-2003.06	Front Axle	Saloon RWD M54B306S3		Suspension Repair Kit	S990002SK
	2000.09-2003.06	Front Axle	Saloon RWD M54B306S3		Suspension Repair Kit	S990030SK
	2000.09-2003.06	Front Axle Left	Saloon RWD M54B306S3		Rod Assembly	S100033
	2000.09-2003.06	Front Axle Right	Saloon RWD M54B306S3		Rod Assembly	S100032
	2000.09-2003.06	Front Axle Left & Right	Saloon RWD M54B306S3		Tie Rod Axle Joint	S030993
	2000.09-2003.06	Front Axle Left	Saloon RWD M54B306S3		Tie Rod End	S070050
	2000.09-2003.06	Front Axle Right	Saloon RWD M54B306S3		Tie Rod End	S070051
	2000.09-2003.06	Front Axle Left	Saloon RWD M54B306S3		Rod/Strut, stabiliser	S100035
	2000.09-2003.06	Front Axle Right	Saloon RWD M54B306S3		Rod/Strut, stabiliser	S100034
	2000.09-2003.06	Rear Axle Left & Right	Saloon RWD M54B306S3		Rod/Strut, stabiliser	S050057
	2000.09-2003.06	Front Axle	Saloon RWD M54B306S3		Stabiliser Bushing	517781
	2000.09-2003.06	Front Axle	Saloon RWD M54B306S3		Stabiliser Bushing	519361
	2000.09-2003.06	Rear Axle	Saloon RWD M54B306S3		Stabiliser Bushing	512299
	2000.09-2003.06	Front Axle	Saloon RWD M54B306S3		Steering Boot	540041
	2000.09-2003.06	Front Axle	Saloon RWD M54B306S3		Steering Boot	540186
	2003.07-2005.03	Front Axle Left Lower Inner	Saloon RWD M54B306S3		Track Control Arm	S060078
	2003.07-2005.03	Front Axle Left Lower Outer	Saloon RWD M54B306S3		Track Control Arm	S060080
	2003.07-2005.03	Front Axle Right Lower Inner	Saloon RWD M54B306S3		Track Control Arm	S060079
	2003.07-2005.03	Front Axle Right Lower Outer	Saloon RWD M54B306S3		Track Control Arm	S060081
	2003.07-2005.03	Rear Axle Left Upper Outer	Saloon RWD M54B306S3		Track Control Arm	S060058
	2003.07-2005.03	Rear Axle Right Upper Outer	Saloon RWD M54B306S3		Track Control Arm	S060057
	2003.07-2005.03	Rear Axle Left & Right Lower	Saloon RWD M54B306S3		Track Control Arm	S060068
	2003.07-2005.03	Rear Axle Left & Right Upper Inner	Saloon RWD M54B306S3		Track Control Arm	S060082
	2003.07-2005.03	Front Axle Left & Right Lower	Saloon RWD M54B306S3		Control Arm Bushing	510608
	2003.07-2005.03	Front Axle Left & Right Lower Inner	Saloon RWD M54B306S3		Control Arm Bushing	510610
	2003.07-2005.03	Front Axle Left & Right Lower Inner	Saloon RWD M54B306S3		Control Arm Bushing	517838
	2003.07-2005.03	Front Axle Left & Right Lower Outer	Saloon RWD M54B306S3		Control Arm Bushing	517804
	2003.07-2005.03	Rear Axle Left & Right Lower	Saloon RWD M54B306S3		Control Arm Bushing	516310
	2003.07-2005.03	Rear Axle Left & Right Lower	Saloon RWD M54B306S3		Control Arm Bushing	516314
	2003.07-2005.03	Rear Axle Left & Right Upper	Saloon RWD M54B306S3	Date from:2005.02	Control Arm Bushing	510616
	2003.07-2005.03	Rear Axle Left & Right Upper Inner	Saloon RWD M54B306S3		Control Arm Bushing	510619
	2003.07-2005.03	Rear Axle Left & Right Upper Inner	Saloon RWD M54B306S3	Date from:2002.01	Control Arm Bushing	517353
	2003.07-2005.03	Front Axle	Saloon RWD M54B306S3		Suspension Repair Kit	S990018SK
	2003.07-2005.03	Front Axle Left & Right	Saloon RWD M54B306S3		Rod Assembly	S100329
	2003.07-2005.03	Front Axle Left & Right	Saloon RWD M54B306S3		Tie Rod Axle Joint	S030348
	2003.07-2005.03	Front Axle Left & Right	Saloon RWD M54B306S3		Tie Rod End	S070551
	2003.07-2005.03	Front Axle Left	Saloon RWD M54B306S3		Rod/Strut, stabiliser	S050065
	2003.07-2005.03	Front Axle Right	Saloon RWD M54B306S3		Rod/Strut, stabiliser	S050066
	2003.07-2005.03	Rear Axle Left & Right	Saloon RWD M54B306S3	for vehicles without active stabiliser control	Rod/Strut, stabiliser	S050067
	2003.07-2005.03	Rear Axle Left & Right	Saloon RWD M54B306S3	for vehicles with active stabilizer	Rod/Strut, stabiliser	S050760
	2003.07-2005.03	Front Axle	Saloon RWD M54B306S3		Stabiliser Bushing	517997
	2003.07-2005.03	Front Axle	Saloon RWD M54B306S3		Steering Boot	540440
	2003.07-2005.03	Front Axle	Saloon RWD M54B306S3	Date from:2003.07	Steering Rack Bellow Kit	540417S
3.0 (187 kw)	2005.03-2010.03	Front Axle Left Lower Inner	Saloon RWD N52B30A		Track Control Arm	S060078
	2005.03-2010.03	Front Axle Left Lower Outer	Saloon RWD N52B30A		Track Control Arm	S060080
	2005.03-2010.03	Front Axle Right Lower Inner	Saloon RWD N52B30A		Track Control Arm	S060079
	2005.03-2010.03	Front Axle Right Lower Outer	Saloon RWD N52B30A		Track Control Arm	S060081
	2005.03-2010.03	Rear Axle Left & Right Lower	Saloon RWD N52B30A	Date to:2009.12	Control Arm Bushing	516310
	2005.03-2010.03	Rear Axle Left & Right Lower	Saloon RWD N52B30A		Control Arm Bushing	516310
	2005.03-2010.03	Rear Axle Left & Right Lower	Saloon RWD N52B30A		Control Arm Bushing	516314
	2005.03-2010.03	Rear Axle Left & Right Upper	Saloon RWD N52B30A		Control Arm Bushing	510616
	2005.03-2010.03	Rear Axle Left & Right Upper Inner	Saloon RWD N52B30A		Control Arm Bushing	517353
	2005.03-2010.03	Front Axle Left & Right	Saloon RWD N52B30A		Tie Rod Axle Joint	S030348
	2005.03-2010.03	Front Axle Left & Right	Saloon RWD N52B30A		Tie Rod End	S070551
	2005.03-2010.03	Front Axle Left	Saloon RWD N52B30A		Rod/Strut, stabiliser	S050065



	 YEAR	FITTING POSITION	BODY STYLE & DRIVE TYPE & ENGINE	REMARKS	PRODUCT	GSP Ref.
BMW 530i						
3.0 (187 kw)	2005.03-2010.03	Front Axle Right	Saloon RWD N52B30A		Rod/Strut, stabiliser	S050066
	2005.03-2010.03	Rear Axle Left & Right	Saloon RWD N52B30A	for vehicles without active stabiliser control	Rod/Strut, stabiliser	S050067
	2005.03-2010.03	Rear Axle Left & Right	Saloon RWD N52B30A	for vehicles with active stabilizer	Rod/Strut, stabiliser	S050760
	2005.03-2010.03	Front Axle	Saloon RWD N52B30A		Stabiliser Bushing	517997
	2005.03-2010.03	Rear Axle	Saloon RWD N52B30A		Stabiliser Bushing	535304
3.0 (190 kw)	2005.03-2007.03	Front Axle Left Lower Inner	Saloon RWD N52B30A/N52B30BF		Track Control Arm	S060078
	2005.03-2007.03	Front Axle Left Lower Outer	Saloon RWD N52B30A/N52B30BF		Track Control Arm	S060080
	2005.03-2007.03	Front Axle Right Lower Inner	Saloon RWD N52B30A/N52B30BF		Track Control Arm	S060079
	2005.03-2007.03	Front Axle Right Lower Outer	Saloon RWD N52B30A/N52B30BF		Track Control Arm	S060081
	2005.03-2007.03	Rear Axle Left Upper Outer	Saloon RWD N52B30A/N52B30BF		Track Control Arm	S060058
	2005.03-2007.03	Rear Axle Right Upper Outer	Saloon RWD N52B30A/N52B30BF		Track Control Arm	S060057
	2005.03-2007.03	Rear Axle Left & Right Lower	Saloon RWD N52B30A/N52B30BF		Track Control Arm	S060068
	2005.03-2007.03	Rear Axle Left & Right Upper Inner	Saloon RWD N52B30A/N52B30BF		Track Control Arm	S060082
	2005.03-2007.03	Front Axle Left & Right Lower	Saloon RWD N52B30A/N52B30BF		Control Arm Bushing	510608
	2005.03-2007.03	Front Axle Left & Right Lower Inner	Saloon RWD N52B30A/N52B30BF		Control Arm Bushing	510610
	2005.03-2007.03	Front Axle Left & Right Lower Inner	Saloon RWD N52B30A/N52B30BF		Control Arm Bushing	517838
	2005.03-2007.03	Front Axle Left & Right Lower Outer	Saloon RWD N52B30A/N52B30BF		Control Arm Bushing	517804
	2005.03-2007.03	Rear Axle Left & Right Lower	Saloon RWD N52B30A/N52B30BF		Control Arm Bushing	516310
	2005.03-2007.03	Rear Axle Left & Right Lower	Saloon RWD N52B30A/N52B30BF		Control Arm Bushing	516314
	2005.03-2007.03	Rear Axle Left & Right Upper	Saloon RWD N52B30A/N52B30BF	Date from:2005.02	Control Arm Bushing	510616
	2005.03-2007.03	Rear Axle Left & Right Upper Inner	Saloon RWD N52B30A/N52B30BF		Control Arm Bushing	510619
	2005.03-2007.03	Rear Axle Left & Right Upper Inner	Saloon RWD N52B30A/N52B30BF	Date from:2002.01	Control Arm Bushing	517353
	2005.03-2007.03	Front Axle	Saloon RWD N52B30A/N52B30BF		Suspension Repair Kit	S990018SK
	2005.03-2007.03	Front Axle Left & Right	Saloon RWD N52B30A/N52B30BF		Rod Assembly	S100329
	2005.03-2007.03	Front Axle Left & Right	Saloon RWD N52B30A/N52B30BF		Tie Rod Axle Joint	S030348
	2005.03-2007.03	Front Axle Left & Right	Saloon RWD N52B30A/N52B30BF		Tie Rod End	S070551
	2005.03-2007.03	Front Axle Left	Saloon RWD N52B30A/N52B30BF		Rod/Strut, stabiliser	S050065
	2005.03-2007.03	Front Axle Right	Saloon RWD N52B30A/N52B30BF		Rod/Strut, stabiliser	S050066
	2005.03-2007.03	Rear Axle Left & Right	Saloon RWD N52B30A/N52B30BF	for vehicles without active stabiliser control	Rod/Strut, stabiliser	S050067
	2005.03-2007.03	Rear Axle Left & Right	Saloon RWD N52B30A/N52B30BF	for vehicles with active stabilizer	Rod/Strut, stabiliser	S050760
	2005.03-2007.03	Front Axle	Saloon RWD N52B30A/N52B30BF		Stabiliser Bushing	517997
	2005.03-2007.03	Rear Axle	Saloon RWD N52B30A/N52B30BF		Stabiliser Bushing	535304
	2005.03-2007.03	Front Axle	Saloon RWD N52B30A/N52B30BF		Steering Boot	540440
2005.03-2007.03	Front Axle	Saloon RWD N52B30A/N52B30BF	For OE.no.32106785993	Steering Rack Bellow Kit	540417S	
535i						
3.0 (225 kw)	2010.01-2016.10	Front Axle Left Lower Inner	Saloon RWD N55B30A		Track Control Arm	S061168
	2010.01-2016.10	Front Axle Left Lower Outer	Saloon RWD N55B30A		Track Control Arm	S061166
	2010.01-2016.10	Front Axle Right Lower Inner	Saloon RWD N55B30A		Track Control Arm	S061169
	2010.01-2016.10	Front Axle Right Lower Outer	Saloon RWD N55B30A		Track Control Arm	S061167
	2010.01-2016.10	Front Axle Left & Right Upper	Saloon RWD N55B30A		Track Control Arm	S061154
	2010.01-2016.10	Rear Axle Left Upper Inner	Saloon RWD N55B30A		Track Control Arm	S062966
	2010.01-2016.10	Rear Axle Right Upper Inner	Saloon RWD N55B30A		Track Control Arm	S062967
	2010.01-2016.10	Rear Axle Left & Right Lower	Saloon RWD N55B30A		Track Control Arm	S061576
	2010.01-2016.10	Rear Axle Left & Right Upper Outer	Saloon RWD N55B30A		Track Control Arm	S063030
	2010.01-2016.10	Front Axle Left & Right Lower Inner	Saloon RWD N55B30A		Control Arm Bushing	531934
	2010.01-2016.10	Front Axle Left & Right Lower Inner	Saloon RWD N55B30A		Control Arm Bushing	532572
	2010.01-2016.10	Front Axle Left & Right Lower Outer	Saloon RWD N55B30A		Control Arm Bushing	531935
	2010.01-2016.10	Front Axle Left & Right	Saloon RWD N55B30A		Tie Rod Axle Joint	S030354
	2010.01-2016.10	Front Axle Left	Saloon RWD N55B30A		Tie Rod End	S070999
	2010.01-2016.10	Front Axle Right	Saloon RWD N55B30A		Tie Rod End	S071000
	2010.01-2016.10	Front Axle Left & Right	Saloon RWD N55B30A		Rod/Strut, stabiliser	S051443
	2010.01-2016.10	Rear Axle Left & Right	Saloon RWD N55B30A	for vehicles without active stabiliser control	Rod/Strut, stabiliser	S050761
	2010.01-2016.10	Rear Axle Left & Right	Saloon RWD N55B30A	for vehicles with adaptive drive	Rod/Strut, stabiliser	S051461
	2010.01-2016.10	Front Axle	Saloon RWD N55B30A		Steering Boot	540440
	535i Gran Turismo					
3.0 (225 kw)	2009.09-2017.02	Front Axle Left Lower Inner	Hatchback RWD N55B30A		Track Control Arm	S061150
	2009.09-2017.02	Front Axle Left Lower Outer	Hatchback RWD N55B30A		Track Control Arm	S061152
	2009.09-2017.02	Front Axle Right Lower Inner	Hatchback RWD N55B30A		Track Control Arm	S061151
	2009.09-2017.02	Front Axle Right Lower Outer	Hatchback RWD N55B30A		Track Control Arm	S061153
	2009.09-2017.02	Front Axle Left & Right Upper	Hatchback RWD N55B30A		Track Control Arm	S061154
	2009.09-2017.02	Rear Axle Left & Right Lower	Hatchback RWD N55B30A		Track Control Arm	S061576
	2009.09-2017.02	Front Axle Left & Right Lower Inner	Hatchback RWD N55B30A		Control Arm Bushing	531934
	2009.09-2017.02	Front Axle Left & Right Lower Inner	Hatchback RWD N55B30A		Control Arm Bushing	532572
	2009.09-2017.02	Front Axle Left & Right Lower Outer	Hatchback RWD N55B30A		Control Arm Bushing	531938



	 YEAR	FITTING POSITION	BODY STYLE & DRIVE TYPE & ENGINE	REMARKS	PRODUCT	GSP Ref.
BMW						
535i Gran Turismo						
3.0 (225 kw)	2009.09-2017.02	Front Axle Left & Right	Hatchback RWD N55B30A		Tie Rod Axle Joint	S030354
	2009.09-2017.02	Front Axle Left	Hatchback RWD N55B30A		Tie Rod End	S070999
	2009.09-2017.02	Front Axle Right	Hatchback RWD N55B30A		Tie Rod End	S071000
	2009.09-2017.02	Front Axle Left & Right	Hatchback RWD N55B30A		Rod/Strut, stabiliser	S051443
	2009.09-2017.02	Front Axle	Hatchback RWD N55B30A		Steering Boot	540440
	2009.09-2017.02	Front Axle	Hatchback RWD N55B30A		Steering Rack Bellow Kit	540417S
535i xDrive Gran Turismo						
3.0 (225 kw)	2010.09-2017.02	Front Axle Left & Right Upper	Hatchback 4WD N55B30A		Track Control Arm	S061154
	2010.09-2017.02	Rear Axle Left & Right Lower	Hatchback 4WD N55B30A		Track Control Arm	S061576
	2010.09-2017.02	Front Axle Left & Right Lower Inner	Hatchback 4WD N55B30A		Control Arm Bushing	531934
	2010.09-2017.02	Front Axle Left & Right Lower Outer	Hatchback 4WD N55B30A		Control Arm Bushing	531938
	2010.09-2017.02	Front Axle Left & Right	Hatchback 4WD N55B30A		Tie Rod Axle Joint	S030354
	2010.09-2017.02	Front Axle Left	Hatchback 4WD N55B30A		Tie Rod End	S070999
	2010.09-2017.02	Front Axle Right	Hatchback 4WD N55B30A		Tie Rod End	S071000
	2010.09-2017.02	Front Axle Left & Right	Hatchback 4WD N55B30A		Rod/Strut, stabiliser	S051443
	2010.09-2017.02	Front Axle	Hatchback 4WD N55B30A		Steering Boot	540440
	2010.09-2017.02	Front Axle	Hatchback 4WD N55B30A		Steering Rack Bellow Kit	540417S
540i						
3.0 (250 kw)	2016.09-2020.06	Front Axle Left & Right Upper	Saloon RWD B58B30A		Track Control Arm	S063260
	2016.09-2020.06	Front Axle Left & Right Lower	Saloon RWD B58B30A		Control Arm Bushing	533513
	2016.09-2020.06	Front Axle Left & Right Upper	Saloon RWD B58B30A		Control Arm Bushing	535314
4.0 (210 kw)	1992.09-1995.12	Front Axle Left Lower	Saloon RWD M60B408S1		Track Control Arm	S060099
	1992.09-1995.12	Front Axle Left Lower	Saloon RWD M60B408S1		Track Control Arm	S060116
	1992.09-1995.12	Front Axle Left Upper	Saloon RWD M60B408S1		Track Control Arm	S100027
	1992.09-1995.12	Front Axle Right Lower	Saloon RWD M60B408S1		Track Control Arm	S060100
	1992.09-1995.12	Front Axle Right Lower	Saloon RWD M60B408S1		Track Control Arm	S060115
	1992.09-1995.12	Front Axle Right Upper	Saloon RWD M60B408S1		Track Control Arm	S100028
	1992.09-1995.12	Front Axle Left & Right Lower	Saloon RWD M60B408S1		Control Arm Bushing	510608
	1992.09-1995.12	Front Axle Left & Right Upper	Saloon RWD M60B408S1		Control Arm Bushing	510595
	1992.09-1995.12	Front Axle Left & Right Lower Inner	Saloon RWD M60B408S1		Control Arm Bushing	510610
	1992.09-1995.12	Front Axle	Saloon RWD M60B408S1		Suspension Repair Kit	S990555SK
	1992.09-1995.12	Front Axle Left & Right	Saloon RWD M60B408S1		Rod Assembly	S100019
	1992.09-1995.12	Front Axle Left & Right Centre	Saloon RWD M60B408S1	For Left-Hand Drive Vehicles	Rod Assembly	S100026
	1992.09-1995.12	Front Axle Left & Right Centre	Saloon RWD M60B408S1		Rod Assembly	S100373
	1992.09-1995.12	Front Axle Left & Right	Saloon RWD M60B408S1		Tie Rod End	S070048
	1992.09-1995.12	Front Axle Left & Right	Saloon RWD M60B408S1		Tie Rod End	S070049
	1992.09-1995.12	Front Axle Left & Right	Saloon RWD M60B408S1		Tie Rod End	S070824
	1992.09-1995.12	Front Axle Left & Right	Saloon RWD M60B408S1		Rod/Strut, stabiliser	S050078
	1992.09-1995.12	Rear Axle Left & Right	Saloon RWD M60B408S1		Rod/Strut, stabiliser	520093
	1992.09-1995.12	Rear Axle Left & Right	Saloon RWD M60B408S1		Rod/Strut, stabiliser	S100020
	1992.09-1995.12	Front Axle	Saloon RWD M60B408S1		Stabiliser Bushing	517356
	1992.09-1995.12	Rear Axle	Saloon RWD M60B408S1		Stabiliser Bushing	511588
	1992.09-1995.12	Front Axle	Saloon RWD M60B408S1		Steering Boot	540041
	1992.09-1995.12	Front Axle	Saloon RWD M60B408S1		Steering Boot	540186
4.0 (220 kw)	2005.09-2007.02	Front Axle Left Lower Inner	Saloon RWD N62B40A		Track Control Arm	S060078
	2005.09-2007.02	Front Axle Right Lower Inner	Saloon RWD N62B40A		Track Control Arm	S060079
	2005.09-2007.02	Rear Axle Left & Right Lower	Saloon RWD N62B40A		Control Arm Bushing	516310
	2005.09-2007.02	Rear Axle Left & Right Lower	Saloon RWD N62B40A		Control Arm Bushing	516314
	2005.09-2007.02	Rear Axle Left & Right Upper	Saloon RWD N62B40A		Control Arm Bushing	510616
	2005.09-2007.02	Rear Axle Left & Right Upper Inner	Saloon RWD N62B40A		Control Arm Bushing	517353
	2005.09-2007.02	Rear Axle	Saloon RWD N62B40A		Stabiliser Bushing	535304
4.4 (210 kw)	1996.03-2003.06	Front Axle Left Lower Inner	Saloon RWD M62B448S1/M62B448S2		Track Control Arm	S060352
	1996.03-2003.06	Front Axle Left Lower Outer	Saloon RWD M62B448S1/M62B448S2		Track Control Arm	S060067
	1996.03-2003.06	Front Axle Right Lower Inner	Saloon RWD M62B448S1/M62B448S2		Track Control Arm	S060353
	1996.03-2003.06	Front Axle Right Lower Outer	Saloon RWD M62B448S1/M62B448S2		Track Control Arm	S060066
	1996.03-2003.06	Rear Axle Left Upper Outer	Saloon RWD M62B448S1/M62B448S2		Track Control Arm	S060058
	1996.03-2003.06	Rear Axle Right Upper Outer	Saloon RWD M62B448S1/M62B448S2		Track Control Arm	S060057
	1996.03-2003.06	Rear Axle Left & Right Lower	Saloon RWD M62B448S1/M62B448S2		Track Control Arm	S060068
	1996.03-2003.06	Rear Axle Left & Right Upper Inner	Saloon RWD M62B448S1/M62B448S2	Date to:2001.12	Track Control Arm	S060061
	1996.03-2003.06	Rear Axle Left & Right Upper Inner	Saloon RWD M62B448S1/M62B448S2	Date from:2001.12	Track Control Arm	S060082
	1996.03-2003.06	Front Axle Left & Right Upper	Saloon RWD M62B448S1/M62B448S2		Control Arm Bushing	510621
	1996.03-2003.06	Front Axle Left & Right Lower Inner	Saloon RWD M62B448S1/M62B448S2		Control Arm Bushing	510610
	1996.03-2003.06	Front Axle Left & Right Lower Inner	Saloon RWD M62B448S1/M62B448S2		Control Arm Bushing	510630
	1996.03-2003.06	Rear Axle Left & Right Lower	Saloon RWD M62B448S1/M62B448S2		Control Arm Bushing	517758



	 YEAR	FITTING POSITION	BODY STYLE & DRIVE TYPE & ENGINE	REMARKS	PRODUCT	GSP Ref.
BMW 540i						
4.4 (210 kw)	1996.03-2003.06	Rear Axle Left & Right Lower	Saloon RWD M62B448S1/M62B448S2		Control Arm Bushing	517765
	1996.03-2003.06	Rear Axle Left & Right Upper Inner	Saloon RWD M62B448S1/M62B448S2		Control Arm Bushing	510619
	1996.03-2003.06	Rear Axle Left & Right Upper Inner	Saloon RWD M62B448S1/M62B448S2	Date from:2002.01	Control Arm Bushing	517353
	1996.03-2003.06	Rear Axle Left & Right Upper Outer	Saloon RWD M62B448S1/M62B448S2		Control Arm Bushing	517802
	1996.03-2003.06	Rear Axle	Saloon RWD M62B448S1/M62B448S2	Date from:2001.12	Suspension Repair Kit	S990051SK
	1996.03-2003.06	Front Axle Left & Right Centre	Saloon RWD M62B448S1/M62B448S2		Rod Assembly	S100290
	1996.03-2003.06	Front Axle Left	Saloon RWD M62B448S1/M62B448S2		Tie Rod End	S070059
	1996.03-2003.06	Front Axle Right	Saloon RWD M62B448S1/M62B448S2		Tie Rod End	S070058
	1996.03-2003.06	Front Axle Left & Right	Saloon RWD M62B448S1/M62B448S2		Rod/Strut, stabiliser	S050054
	1996.03-2003.06	Rear Axle Left & Right	Saloon RWD M62B448S1/M62B448S2		Rod/Strut, stabiliser	S050057
	1996.03-2003.06	Front Axle	Saloon RWD M62B448S1/M62B448S2		Stabiliser Bushing	517781
	1996.03-2003.06	Rear Axle	Saloon RWD M62B448S1/M62B448S2		Stabiliser Bushing	512299
540i Touring						
4.0 (210 kw)	1993.09-1996.07	Front Axle Left Lower	Estate RWD M60B408S1		Track Control Arm	S060116
	1993.09-1996.07	Front Axle Left Upper	Estate RWD M60B408S1		Track Control Arm	S100027
	1993.09-1996.07	Front Axle Right Lower	Estate RWD M60B408S1		Track Control Arm	S060115
	1993.09-1996.07	Front Axle Right Upper	Estate RWD M60B408S1		Track Control Arm	S100028
	1993.09-1996.07	Front Axle Left & Right Lower	Estate RWD M60B408S1		Control Arm Bushing	510608
	1993.09-1996.07	Front Axle Left & Right Upper	Estate RWD M60B408S1		Control Arm Bushing	510595
	1993.09-1996.07	Front Axle Left & Right Lower Inner	Estate RWD M60B408S1		Control Arm Bushing	510610
	1993.09-1996.07	Front Axle	Estate RWD M60B408S1		Suspension Repair Kit	S990055SK
	1993.09-1996.07	Front Axle Left & Right	Estate RWD M60B408S1		Rod Assembly	S100019
	1993.09-1996.07	Front Axle Left & Right Centre	Estate RWD M60B408S1	For Left-Hand Drive Vehicles	Rod Assembly	S100026
	1993.09-1996.07	Front Axle Left & Right Centre	Estate RWD M60B408S1		Rod Assembly	S100373
	1993.09-1996.07	Front Axle Left & Right	Estate RWD M60B408S1		Tie Rod End	S070048
	1993.09-1996.07	Front Axle Left & Right	Estate RWD M60B408S1		Tie Rod End	S070049
	1993.09-1996.07	Front Axle Left & Right	Estate RWD M60B408S1		Tie Rod End	S070824
	1993.09-1996.07	Front Axle Left & Right	Estate RWD M60B408S1		Tie Rod End	S070866
	1993.09-1996.07	Front Axle Left & Right	Estate RWD M60B408S1		Rod/Strut, stabiliser	S050078
	1993.09-1996.07	Rear Axle Left & Right	Estate RWD M60B408S1		Rod/Strut, stabiliser	520093
	1993.09-1996.07	Rear Axle Left & Right	Estate RWD M60B408S1		Rod/Strut, stabiliser	S100020
	1993.09-1996.07	Front Axle	Estate RWD M60B408S1		Stabiliser Bushing	517356
	1993.09-1996.07	Rear Axle	Estate RWD M60B408S1		Stabiliser Bushing	511588
	1993.09-1996.07	Front Axle	Estate RWD M60B408S1		Steering Boot	540041
	1993.09-1996.07	Front Axle	Estate RWD M60B408S1		Steering Boot	540186
4.4 (210 kw)	1997.04-2003.12	Front Axle Left Lower Inner	Estate RWD M62B448S1/M62B448S2		Track Control Arm	S060352
	1997.04-2003.12	Front Axle Left Lower Outer	Estate RWD M62B448S1/M62B448S2		Track Control Arm	S060067
	1997.04-2003.12	Front Axle Right Lower Inner	Estate RWD M62B448S1/M62B448S2		Track Control Arm	S060353
	1997.04-2003.12	Front Axle Right Lower Outer	Estate RWD M62B448S1/M62B448S2		Track Control Arm	S060066
	1997.04-2003.12	Rear Axle Left Upper Outer	Estate RWD M62B448S1/M62B448S2		Track Control Arm	S060058
	1997.04-2003.12	Rear Axle Right Upper Outer	Estate RWD M62B448S1/M62B448S2		Track Control Arm	S060057
	1997.04-2003.12	Rear Axle Left & Right Lower	Estate RWD M62B448S1/M62B448S2		Track Control Arm	S060068
	1997.04-2003.12	Rear Axle Left & Right Upper Inner	Estate RWD M62B448S1/M62B448S2	Date to:2001.12	Track Control Arm	S060061
	1997.04-2003.12	Rear Axle Left & Right Upper Inner	Estate RWD M62B448S1/M62B448S2	Date from:2001.12	Track Control Arm	S060082
	1997.04-2003.12	Front Axle Left & Right Upper	Estate RWD M62B448S1/M62B448S2		Control Arm Bushing	510621
	1997.04-2003.12	Front Axle Left & Right Lower Inner	Estate RWD M62B448S1/M62B448S2		Control Arm Bushing	510630
	1997.04-2003.12	Rear Axle Left & Right Lower	Estate RWD M62B448S1/M62B448S2	Date to:2003.07	Control Arm Bushing	517758
	1997.04-2003.12	Rear Axle Left & Right Lower	Estate RWD M62B448S1/M62B448S2	Date to:2003.07	Control Arm Bushing	517765
	1997.04-2003.12	Rear Axle Left & Right Upper Inner	Estate RWD M62B448S1/M62B448S2	Date from:2002.01	Control Arm Bushing	517353
	1997.04-2003.12	Rear Axle Left & Right Upper Outer	Estate RWD M62B448S1/M62B448S2		Control Arm Bushing	517802
	1997.04-2003.12	Rear Axle	Estate RWD M62B448S1/M62B448S2	Date from:2001.12	Suspension Repair Kit	S990051SK
	1997.04-2003.12	Front Axle Left & Right Centre	Estate RWD M62B448S1/M62B448S2		Rod Assembly	S100290
	1997.04-2003.12	Front Axle Left	Estate RWD M62B448S1/M62B448S2		Tie Rod End	S070059
	1997.04-2003.12	Front Axle Right	Estate RWD M62B448S1/M62B448S2		Tie Rod End	S070058
	1997.04-2003.12	Front Axle Left & Right	Estate RWD M62B448S1/M62B448S2		Rod/Strut, stabiliser	S050054
	1997.04-2003.12	Rear Axle Left & Right	Estate RWD M62B448S1/M62B448S2		Rod/Strut, stabiliser	S050057
	1997.04-2003.12	Front Axle	Estate RWD M62B448S1/M62B448S2		Stabiliser Bushing	517781
545i						
4.4 (245 kw)	2003.09-2005.08	Front Axle Left Lower Inner	Saloon RWD N62B44A		Track Control Arm	S060078
	2003.09-2005.08	Front Axle Left Lower Outer	Saloon RWD N62B44A		Track Control Arm	S060080
	2003.09-2005.08	Front Axle Right Lower Inner	Saloon RWD N62B44A		Track Control Arm	S060079
	2003.09-2005.08	Front Axle Right Lower Outer	Saloon RWD N62B44A		Track Control Arm	S060081
	2003.09-2005.08	Rear Axle Left Upper Outer	Saloon RWD N62B44A		Track Control Arm	S060058
	2003.09-2005.08	Rear Axle Right Upper Outer	Saloon RWD N62B44A		Track Control Arm	S060057



	 YEAR	FITTING POSITION	BODY STYLE & DRIVE TYPE & ENGINE	REMARKS	PRODUCT	GSP Ref.
BMW						
545i						
4.4 (245 kw)	2003.09-2005.08	Rear Axle Left & Right Lower	Saloon RWD N62B44A		Track Control Arm	S060068
	2003.09-2005.08	Rear Axle Left & Right Upper Inner	Saloon RWD N62B44A		Track Control Arm	S060082
	2003.09-2005.08	Front Axle Left & Right Lower Inner	Saloon RWD N62B44A		Control Arm Bushing	510610
	2003.09-2005.08	Front Axle Left & Right Lower Inner	Saloon RWD N62B44A		Control Arm Bushing	517838
	2003.09-2005.08	Front Axle Left & Right Lower Outer	Saloon RWD N62B44A		Control Arm Bushing	517804
	2003.09-2005.08	Rear Axle Left & Right Lower	Saloon RWD N62B44A		Control Arm Bushing	516310
	2003.09-2005.08	Rear Axle Left & Right Lower	Saloon RWD N62B44A		Control Arm Bushing	516314
	2003.09-2005.08	Rear Axle Left & Right Upper	Saloon RWD N62B44A	Date from:2005.02	Control Arm Bushing	510616
	2003.09-2005.08	Rear Axle Left & Right Upper Inner	Saloon RWD N62B44A		Control Arm Bushing	510619
	2003.09-2005.08	Rear Axle Left & Right Upper Inner	Saloon RWD N62B44A		Control Arm Bushing	517353
	2003.09-2005.08	Front Axle	Saloon RWD N62B44A		Suspension Repair Kit	S990018SK
	2003.09-2005.08	Front Axle Left & Right	Saloon RWD N62B44A		Rod Assembly	S100329
	2003.09-2005.08	Front Axle Left & Right	Saloon RWD N62B44A		Tie Rod Axle Joint	S030348
	2003.09-2005.08	Front Axle Left & Right	Saloon RWD N62B44A		Tie Rod End	S070551
	2003.09-2005.08	Front Axle Left	Saloon RWD N62B44A		Rod/Strut, stabiliser	S050065
	2003.09-2005.08	Front Axle Right	Saloon RWD N62B44A		Rod/Strut, stabiliser	S050066
	2003.09-2005.08	Rear Axle Left & Right	Saloon RWD N62B44A	for vehicles without active stabiliser control	Rod/Strut, stabiliser	S050067
	2003.09-2005.08	Rear Axle Left & Right	Saloon RWD N62B44A	for vehicles with active stabilizer	Rod/Strut, stabiliser	S050760
	2003.09-2005.08	Rear Axle	Saloon RWD N62B44A		Stabiliser Bushing	535304
	2003.09-2005.08	Front Axle	Saloon RWD N62B44A		Steering Boot	540440
	2003.09-2005.08	Front Axle	Saloon RWD N62B44A	For OE.no.32106785993	Steering Rack Bellow Kit	540417S
550i						
4.4 (300 kw)	2010.03-2013.06	Front Axle Left Lower Inner	Saloon RWD N63B44A		Track Control Arm	S061168
	2010.03-2013.06	Front Axle Left Lower Outer	Saloon RWD N63B44A		Track Control Arm	S061166
	2010.03-2013.06	Front Axle Right Lower Inner	Saloon RWD N63B44A		Track Control Arm	S061169
	2010.03-2013.06	Front Axle Right Lower Outer	Saloon RWD N63B44A		Track Control Arm	S061167
	2010.03-2013.06	Front Axle Left & Right Upper	Saloon RWD N63B44A		Track Control Arm	S061154
	2010.03-2013.06	Rear Axle Left Upper Inner	Saloon RWD N63B44A		Track Control Arm	S062966
	2010.03-2013.06	Rear Axle Right Upper Inner	Saloon RWD N63B44A		Track Control Arm	S062967
	2010.03-2013.06	Rear Axle Left & Right Lower	Saloon RWD N63B44A		Track Control Arm	S061576
	2010.03-2013.06	Rear Axle Left & Right Upper Outer	Saloon RWD N63B44A		Track Control Arm	S063030
	2010.03-2013.06	Front Axle Left & Right Lower Inner	Saloon RWD N63B44A		Control Arm Bushing	531934
	2010.03-2013.06	Front Axle Left & Right Lower Inner	Saloon RWD N63B44A		Control Arm Bushing	532572
	2010.03-2013.06	Front Axle Left & Right Lower Outer	Saloon RWD N63B44A		Control Arm Bushing	531935
	2010.03-2013.06	Front Axle Left & Right	Saloon RWD N63B44A		Tie Rod Axle Joint	S030354
	2010.03-2013.06	Front Axle Left	Saloon RWD N63B44A		Tie Rod End	S070999
	2010.03-2013.06	Front Axle Right	Saloon RWD N63B44A		Tie Rod End	S071000
	2010.03-2013.06	Front Axle Left & Right	Saloon RWD N63B44A		Rod/Strut, stabiliser	S051443
	2010.03-2013.06	Rear Axle Left & Right	Saloon RWD N63B44A	for vehicles without active stabiliser control	Rod/Strut, stabiliser	S050761
	2010.03-2013.06	Rear Axle Left & Right	Saloon RWD N63B44A	for vehicles with active stabilizer	Rod/Strut, stabiliser	S051461
	2010.03-2013.06	Front Axle	Saloon RWD N63B44A		Steering Boot	540440
4.8 (270 kw)	2005.09-2009.12	Front Axle Left Lower Inner	Saloon RWD N62B48B		Track Control Arm	S060078
	2005.09-2009.12	Front Axle Left Lower Outer	Saloon RWD N62B48B		Track Control Arm	S060080
	2005.09-2009.12	Front Axle Right Lower Inner	Saloon RWD N62B48B		Track Control Arm	S060079
	2005.09-2009.12	Front Axle Right Lower Outer	Saloon RWD N62B48B		Track Control Arm	S060081
	2005.09-2009.12	Rear Axle Left Upper Outer	Saloon RWD N62B48B		Track Control Arm	S060058
	2005.09-2009.12	Rear Axle Right Upper Outer	Saloon RWD N62B48B		Track Control Arm	S060057
	2005.09-2009.12	Rear Axle Left & Right Lower	Saloon RWD N62B48B		Track Control Arm	S060068
	2005.09-2009.12	Rear Axle Left & Right Upper Inner	Saloon RWD N62B48B		Track Control Arm	S060082
	2005.09-2009.12	Front Axle Left & Right Lower	Saloon RWD N62B48B		Control Arm Bushing	510608
	2005.09-2009.12	Front Axle Left & Right Lower Inner	Saloon RWD N62B48B		Control Arm Bushing	510610
	2005.09-2009.12	Front Axle Left & Right Lower Inner	Saloon RWD N62B48B		Control Arm Bushing	517838
	2005.09-2009.12	Front Axle Left & Right Lower Outer	Saloon RWD N62B48B		Control Arm Bushing	517804
	2005.09-2009.12	Rear Axle Left & Right Lower	Saloon RWD N62B48B		Control Arm Bushing	516310
	2005.09-2009.12	Rear Axle Left & Right Lower	Saloon RWD N62B48B		Control Arm Bushing	516314
	2005.09-2009.12	Rear Axle Left & Right Upper	Saloon RWD N62B48B		Control Arm Bushing	510616
	2005.09-2009.12	Rear Axle Left & Right Upper Inner	Saloon RWD N62B48B		Control Arm Bushing	510619
	2005.09-2009.12	Rear Axle Left & Right Upper Inner	Saloon RWD N62B48B		Control Arm Bushing	517353
	2005.09-2009.12	Front Axle	Saloon RWD N62B48B		Suspension Repair Kit	S990018SK
	2005.09-2009.12	Front Axle Left & Right	Saloon RWD N62B48B		Rod Assembly	S100329
	2005.09-2009.12	Front Axle Left & Right	Saloon RWD N62B48B		Tie Rod Axle Joint	S030348
	2005.09-2009.12	Front Axle Left & Right	Saloon RWD N62B48B		Tie Rod End	S070551
	2005.09-2009.12	Front Axle Left	Saloon RWD N62B48B		Rod/Strut, stabiliser	S050065
	2005.09-2009.12	Front Axle Right	Saloon RWD N62B48B		Rod/Strut, stabiliser	S050066



	 YEAR	FITTING POSITION	BODY STYLE & DRIVE TYPE & ENGINE	REMARKS	PRODUCT	GSP Ref.
BMW 550i						
4.8 (270 kw)	2005.09-2009.12	Rear Axle Left & Right	Saloon RWD N62B48B	for vehicles without active stabiliser control	Rod/Strut,stabiliser	S050067
	2005.09-2009.12	Rear Axle Left & Right	Saloon RWD N62B48B	for vehicles with active stabilizer	Rod/Strut,stabiliser	S050760
	2005.09-2009.12	Front Axle	Saloon RWD N62B48B		Stabiliser Bushing	517997
	2005.09-2009.12	Rear Axle	Saloon RWD N62B48B		Stabiliser Bushing	535304
	2005.09-2009.12	Front Axle	Saloon RWD N62B48B		Steering Boot	540440
	2005.09-2009.12	Front Axle	Saloon RWD N62B48B	For OE.no.32106785993	Steering Rack Bellow Kit	540417S
640i Coupe						
3.0 (235 kw)	2011.07-2017.10	Front Axle Left Lower Inner	Coupe RWD N55B30A		Track Control Arm	S061168
	2011.07-2017.10	Front Axle Left Lower Outer	Coupe RWD N55B30A		Track Control Arm	S061166
	2011.07-2017.10	Front Axle Right Lower Inner	Coupe RWD N55B30A		Track Control Arm	S061169
	2011.07-2017.10	Front Axle Right Lower Outer	Coupe RWD N55B30A		Track Control Arm	S061167
	2011.07-2017.10	Front Axle Left & Right Upper	Coupe RWD N55B30A		Track Control Arm	S061154
	2011.07-2017.10	Rear Axle Left Upper Inner	Coupe RWD N55B30A		Track Control Arm	S062966
	2011.07-2017.10	Rear Axle Right Upper Inner	Coupe RWD N55B30A		Track Control Arm	S062967
	2011.07-2017.10	Rear Axle Left & Right Lower	Coupe RWD N55B30A		Track Control Arm	S061576
	2011.07-2017.10	Rear Axle Left & Right Upper Outer	Coupe RWD N55B30A		Track Control Arm	S063030
	2011.07-2017.10	Front Axle Left & Right Lower Inner	Coupe RWD N55B30A		Control Arm Bushing	531934
	2011.07-2017.10	Front Axle Left & Right Lower Inner	Coupe RWD N55B30A		Control Arm Bushing	532572
	2011.07-2017.10	Front Axle Left & Right Lower Outer	Coupe RWD N55B30A		Control Arm Bushing	531935
	2011.07-2017.10	Rear Axle Left & Right Lower	Coupe RWD N55B30A		Control Arm Bushing	516314
	2011.07-2017.10	Front Axle Left & Right	Coupe RWD N55B30A		Tie Rod Axle Joint	S030354
	2011.07-2017.10	Front Axle Left	Coupe RWD N55B30A		Tie Rod End	S070999
	2011.07-2017.10	Front Axle Right	Coupe RWD N55B30A		Tie Rod End	S071000
	2011.07-2017.10	Front Axle Left & Right	Coupe RWD N55B30A		Rod/Strut,stabiliser	S051443
	2011.07-2017.10	Rear Axle Left & Right	Coupe RWD N55B30A	for vehicles with dynamic drive	Rod/Strut,stabiliser	S050761
	2011.07-2017.10	Rear Axle Left & Right	Coupe RWD N55B30A	for vehicles with dynamic drive	Rod/Strut,stabiliser	S051461
	2011.07-2017.10	Front Axle	Coupe RWD N55B30A		Steering Boot	540440
645i Coupe						
4.4 (245 kw)	2003.09-2005.08	Front Axle Left Lower Inner	Coupe RWD N62B44A		Track Control Arm	S060354
	2003.09-2005.08	Front Axle Right Lower Inner	Coupe RWD N62B44A		Track Control Arm	S060355
	2003.09-2005.08	Rear Axle Left Upper Outer	Coupe RWD N62B44A		Track Control Arm	S060058
	2003.09-2005.08	Rear Axle Right Upper Outer	Coupe RWD N62B44A		Track Control Arm	S060057
	2003.09-2005.08	Rear Axle Left & Right Lower	Coupe RWD N62B44A		Track Control Arm	S060068
	2003.09-2005.08	Rear Axle Left & Right Upper Inner	Coupe RWD N62B44A		Track Control Arm	S060082
	2003.09-2005.08	Front Axle Left & Right Lower Inner	Coupe RWD N62B44A		Control Arm Bushing	510610
	2003.09-2005.08	Front Axle Left & Right Lower Outer	Coupe RWD N62B44A		Control Arm Bushing	517804
	2003.09-2005.08	Rear Axle Left & Right Lower	Coupe RWD N62B44A		Control Arm Bushing	516310
	2003.09-2005.08	Rear Axle Left & Right Lower	Coupe RWD N62B44A		Control Arm Bushing	516314
	2003.09-2005.08	Rear Axle Left & Right Upper	Coupe RWD N62B44A		Control Arm Bushing	510616
	2003.09-2005.08	Rear Axle Left & Right Upper Inner	Coupe RWD N62B44A		Control Arm Bushing	517353
	2003.09-2005.08	Front Axle Left & Right	Coupe RWD N62B44A		Rod Assembly	S100329
	2003.09-2005.08	Front Axle Left & Right	Coupe RWD N62B44A		Tie Rod Axle Joint	S030348
	2003.09-2005.08	Front Axle Left & Right	Coupe RWD N62B44A		Tie Rod End	S070551
	2003.09-2005.08	Rear Axle Left & Right	Coupe RWD N62B44A	for vehicles without active stabiliser control	Rod/Strut,stabiliser	S050067
	2003.09-2005.08	Rear Axle Left & Right	Coupe RWD N62B44A	for vehicles with active stabilizer	Rod/Strut,stabiliser	S050760
	2003.09-2005.08	Front Axle	Coupe RWD N62B44A		Steering Boot	540440
	2003.09-2005.08	Front Axle	Coupe RWD N62B44A		Steering Rack Bellow Kit	540417S
650i Coupe						
4.4 (300 kw)	2011.07-2012.06	Front Axle Left Lower Inner	Coupe RWD N63B44A		Track Control Arm	S061168
	2011.07-2012.06	Front Axle Left Lower Outer	Coupe RWD N63B44A		Track Control Arm	S061166
	2011.07-2012.06	Front Axle Right Lower Inner	Coupe RWD N63B44A		Track Control Arm	S061169
	2011.07-2012.06	Front Axle Right Lower Outer	Coupe RWD N63B44A		Track Control Arm	S061167
	2011.07-2012.06	Front Axle Left & Right Upper	Coupe RWD N63B44A		Track Control Arm	S061154
	2011.07-2012.06	Rear Axle Left Upper Inner	Coupe RWD N63B44A		Track Control Arm	S062966
	2011.07-2012.06	Rear Axle Right Upper Inner	Coupe RWD N63B44A		Track Control Arm	S062967
	2011.07-2012.06	Rear Axle Left & Right Lower	Coupe RWD N63B44A		Track Control Arm	S061576
	2011.07-2012.06	Rear Axle Left & Right Upper Outer	Coupe RWD N63B44A		Track Control Arm	S063030
	2011.07-2012.06	Front Axle Left & Right Lower Inner	Coupe RWD N63B44A		Control Arm Bushing	531934
	2011.07-2012.06	Front Axle Left & Right Lower Inner	Coupe RWD N63B44A		Control Arm Bushing	532572
	2011.07-2012.06	Front Axle Left & Right Lower Outer	Coupe RWD N63B44A		Control Arm Bushing	531935
	2011.07-2012.06	Rear Axle Left & Right Lower	Coupe RWD N63B44A		Control Arm Bushing	516314
	2011.07-2012.06	Front Axle Left & Right	Coupe RWD N63B44A		Tie Rod Axle Joint	S030354
	2011.07-2012.06	Front Axle Left	Coupe RWD N63B44A		Tie Rod End	S070999
	2011.07-2012.06	Front Axle Right	Coupe RWD N63B44A		Tie Rod End	S071000



	 YEAR	FITTING POSITION	BODY STYLE & DRIVE TYPE & ENGINE	REMARKS	PRODUCT	GSP Ref.	
BMW 650i Coupe							
4.4 (300 kw)	2011.07-2012.06	Front Axle Left & Right	Coupe RWD N63B44A		Rod/Strut, stabiliser	S051443	
	2011.07-2012.06	Rear Axle Left & Right	Coupe RWD N63B44A	for vehicles with dynamic drive	Rod/Strut, stabiliser	S050761	
	2011.07-2012.06	Rear Axle Left & Right	Coupe RWD N63B44A	for vehicles with dynamic drive	Rod/Strut, stabiliser	S051461	
	2011.07-2012.06	Front Axle	Coupe RWD N63B44A		Steering Boot	540440	
4.4 (330 kw)	2012.07-2017.10	Front Axle Left Lower Inner	Coupe RWD N63B44B		Track Control Arm	S061168	
	2012.07-2017.10	Front Axle Left Lower Outer	Coupe RWD N63B44B		Track Control Arm	S061166	
	2012.07-2017.10	Front Axle Right Lower Inner	Coupe RWD N63B44B		Track Control Arm	S061169	
	2012.07-2017.10	Front Axle Right Lower Outer	Coupe RWD N63B44B		Track Control Arm	S061167	
	2012.07-2017.10	Front Axle Left & Right Upper	Coupe RWD N63B44B		Track Control Arm	S061154	
	2012.07-2017.10	Rear Axle Left Upper Inner	Coupe RWD N63B44B		Track Control Arm	S062966	
	2012.07-2017.10	Rear Axle Right Upper Inner	Coupe RWD N63B44B		Track Control Arm	S062967	
	2012.07-2017.10	Rear Axle Left & Right Lower	Coupe RWD N63B44B		Track Control Arm	S061576	
	2012.07-2017.10	Rear Axle Left & Right Upper Outer	Coupe RWD N63B44B		Track Control Arm	S063030	
	2012.07-2017.10	Front Axle Left & Right Lower Inner	Coupe RWD N63B44B		Control Arm Bushing	531934	
	2012.07-2017.10	Front Axle Left & Right Lower Inner	Coupe RWD N63B44B		Control Arm Bushing	532572	
	2012.07-2017.10	Front Axle Left & Right Lower Outer	Coupe RWD N63B44B		Control Arm Bushing	531935	
	2012.07-2017.10	Rear Axle Left & Right Lower	Coupe RWD N63B44B		Control Arm Bushing	516314	
	2012.07-2017.10	Front Axle Left	Coupe RWD N63B44B		Tie Rod End	S070999	
	2012.07-2017.10	Front Axle Right	Coupe RWD N63B44B		Tie Rod End	S071000	
	2012.07-2017.10	Rear Axle Left & Right	Coupe RWD N63B44B	For OE no.33556777635	Rod/Strut, stabiliser	S050761	
	2012.07-2017.10	Rear Axle Left & Right	Coupe RWD N63B44B	for vehicles with electronic suspension control	Rod/Strut, stabiliser	S051461	
	2012.07-2017.10	Front Axle	Coupe RWD N63B44B		Steering Boot	540440	
	4.8 (270 kw)	2005.09-2010.08	Front Axle Left Lower Inner	Coupe RWD N62B48B		Track Control Arm	S060354
		2005.09-2010.08	Front Axle Right Lower Inner	Coupe RWD N62B48B		Track Control Arm	S060355
2005.09-2010.08		Rear Axle Left Upper Outer	Coupe RWD N62B48B		Track Control Arm	S060058	
2005.09-2010.08		Rear Axle Right Upper Outer	Coupe RWD N62B48B		Track Control Arm	S060057	
2005.09-2010.08		Rear Axle Left & Right Lower	Coupe RWD N62B48B		Track Control Arm	S060068	
2005.09-2010.08		Rear Axle Left & Right Upper Inner	Coupe RWD N62B48B		Track Control Arm	S060082	
2005.09-2010.08		Front Axle Left & Right Lower Inner	Coupe RWD N62B48B		Control Arm Bushing	510610	
2005.09-2010.08		Front Axle Left & Right Lower Outer	Coupe RWD N62B48B		Control Arm Bushing	517804	
2005.09-2010.08		Rear Axle Left & Right Lower	Coupe RWD N62B48B	Date to:2010.07	Control Arm Bushing	516310	
2005.09-2010.08		Rear Axle Left & Right Lower	Coupe RWD N62B48B		Control Arm Bushing	516310	
2005.09-2010.08		Rear Axle Left & Right Lower	Coupe RWD N62B48B		Control Arm Bushing	516314	
2005.09-2010.08		Rear Axle Left & Right Upper	Coupe RWD N62B48B		Control Arm Bushing	510616	
2005.09-2010.08		Rear Axle Left & Right Upper Inner	Coupe RWD N62B48B	Date from-to:2006.07-2006.10	Control Arm Bushing	517353	
2005.09-2010.08		Front Axle Left & Right	Coupe RWD N62B48B		Rod Assembly	S100329	
2005.09-2010.08		Front Axle Left & Right	Coupe RWD N62B48B		Tie Rod Axle Joint	S030348	
2005.09-2010.08		Front Axle Left & Right	Coupe RWD N62B48B		Tie Rod End	S070551	
2005.09-2010.08		Rear Axle Left & Right	Coupe RWD N62B48B	for vehicles without active stabiliser control	Rod/Strut, stabiliser	S050067	
2005.09-2010.08		Rear Axle Left & Right	Coupe RWD N62B48B	for vehicles with active stabilizer	Rod/Strut, stabiliser	S050760	
2005.09-2010.08		Front Axle	Coupe RWD N62B48B		Steering Boot	540440	
2005.09-2010.08		Front Axle	Coupe RWD N62B48B		Steering Rack Bellow Kit	540417S	
650i Gran Coupe							
4.4 (330 kw)	2012.07-2018.10	Front Axle Left Lower Inner	Coupe RWD N63B44B		Track Control Arm	S061168	
	2012.07-2018.10	Front Axle Left Lower Outer	Coupe RWD N63B44B		Track Control Arm	S061166	
	2012.07-2018.10	Front Axle Right Lower Inner	Coupe RWD N63B44B		Track Control Arm	S061169	
	2012.07-2018.10	Front Axle Right Lower Outer	Coupe RWD N63B44B		Track Control Arm	S061167	
	2012.07-2018.10	Front Axle Left & Right Upper	Coupe RWD N63B44B		Track Control Arm	S061154	
	2012.07-2018.10	Rear Axle Left Upper Inner	Coupe RWD N63B44B		Track Control Arm	S062966	
	2012.07-2018.10	Rear Axle Right Upper Inner	Coupe RWD N63B44B		Track Control Arm	S062967	
	2012.07-2018.10	Rear Axle Left & Right Upper Outer	Coupe RWD N63B44B		Track Control Arm	S063030	
	2012.07-2018.10	Front Axle Left & Right Lower Inner	Coupe RWD N63B44B		Control Arm Bushing	531934	
	2012.07-2018.10	Front Axle Left & Right Lower Inner	Coupe RWD N63B44B		Control Arm Bushing	532572	
	2012.07-2018.10	Front Axle Left & Right Lower Outer	Coupe RWD N63B44B		Control Arm Bushing	531935	
	2012.07-2018.10	Rear Axle Left & Right Lower	Coupe RWD N63B44B		Control Arm Bushing	516314	
	2012.07-2018.10	Front Axle Left & Right	Coupe RWD N63B44B		Tie Rod Axle Joint	S030354	
	2012.07-2018.10	Front Axle Left	Coupe RWD N63B44B		Tie Rod End	S070999	
	2012.07-2018.10	Front Axle Right	Coupe RWD N63B44B		Tie Rod End	S071000	
	2012.07-2018.10	Rear Axle Left & Right	Coupe RWD N63B44B	For OE no.33556777635	Rod/Strut, stabiliser	S050761	
	2012.07-2018.10	Rear Axle Left & Right	Coupe RWD N63B44B	for vehicles with electronic suspension control	Rod/Strut, stabiliser	S051461	
	2012.07-2018.10	Front Axle	Coupe RWD N63B44B		Steering Boot	540440	
	650i xDrive Coupe						
	4.4 (300 kw)	2011.09-2015.02	Front Axle Left & Right Upper	Coupe 4WD N63B44A		Track Control Arm	S061154
2011.09-2015.02		Rear Axle Left Upper Inner	Coupe 4WD N63B44A		Track Control Arm	S062966	



	 YEAR	FITTING POSITION	BODY STYLE & DRIVE TYPE & ENGINE	REMARKS	PRODUCT	GSP Ref.
BMW						
650i xDrive Coupe						
4.4 (300 kw)	2011.09-2015.02	Rear Axle Right Upper Inner	Coupe 4WD N63B44A		Track Control Arm	S062967
	2011.09-2015.02	Rear Axle Left & Right Lower	Coupe 4WD N63B44A		Track Control Arm	S061576
	2011.09-2015.02	Rear Axle Left & Right Upper Outer	Coupe 4WD N63B44A		Track Control Arm	S063030
	2011.09-2015.02	Front Axle Left & Right Lower Inner	Coupe 4WD N63B44A		Control Arm Bushing	531934
	2011.09-2015.02	Rear Axle Left & Right Lower	Coupe 4WD N63B44A		Control Arm Bushing	516314
	2011.09-2015.02	Front Axle Left & Right	Coupe 4WD N63B44A		Tie Rod Axle Joint	S030354
	2011.09-2015.02	Front Axle Left	Coupe 4WD N63B44A		Tie Rod End	S070999
	2011.09-2015.02	Front Axle Right	Coupe 4WD N63B44A		Tie Rod End	S071000
	2011.09-2015.02	Front Axle Left & Right	Coupe 4WD N63B44A		Rod/Strut, stabiliser	S051443
	2011.09-2015.02	Rear Axle Left & Right	Coupe 4WD N63B44A	For OE no.33556777635	Rod/Strut, stabiliser	S050761
	2011.09-2015.02	Rear Axle Left & Right	Coupe 4WD N63B44A	for vehicles with electronic suspension control	Rod/Strut, stabiliser	S051461
	2011.09-2015.02	Front Axle	Coupe 4WD N63B44A		Steering Boot	540440
735i						
3.4 (163 kw)	1985.08-1988.04	Front Axle Left & Right	Saloon RWD S38B35B		Tie Rod End	S070742
740i						
4.0 (210 kw)	1992.05-1994.03	Front Axle Left Lower	Saloon RWD M60B408S1		Track Control Arm	S060099
	1992.05-1994.03	Front Axle Left Lower	Saloon RWD M60B408S1		Track Control Arm	S060116
	1992.05-1994.03	Front Axle Left Lower Inner	Saloon RWD M60B408S1		Track Control Arm	S060103
	1992.05-1994.03	Front Axle Right Lower	Saloon RWD M60B408S1		Track Control Arm	S060100
	1992.05-1994.03	Front Axle Right Lower	Saloon RWD M60B408S1		Track Control Arm	S060115
	1992.05-1994.03	Front Axle Right Lower Inner	Saloon RWD M60B408S1		Track Control Arm	S060104
	1992.05-1994.03	Front Axle Left & Right Lower	Saloon RWD M60B408S1		Control Arm Bushing	510608
	1992.05-1994.03	Front Axle Left & Right Upper	Saloon RWD M60B408S1		Control Arm Bushing	510595
	1992.05-1994.03	Front Axle Left & Right Lower Inner	Saloon RWD M60B408S1		Control Arm Bushing	510610
	1992.05-1994.03	Front Axle Left & Right	Saloon RWD M60B408S1		Rod Assembly	S100019
	1992.05-1994.03	Front Axle Left & Right	Saloon RWD M60B408S1	for left-hand drive vehicles	Rod Assembly	S100024
	1992.05-1994.03	Front Axle Left & Right	Saloon RWD M60B408S1		Tie Rod End	S070048
	1992.05-1994.03	Front Axle Left & Right	Saloon RWD M60B408S1		Tie Rod End	S070049
	1992.05-1994.03	Front Axle Left & Right	Saloon RWD M60B408S1		Rod/Strut, stabiliser	S050078
	1992.05-1994.03	Rear Axle Left & Right	Saloon RWD M60B408S1		Rod/Strut, stabiliser	520093
	1992.05-1994.03	Rear Axle Left & Right	Saloon RWD M60B408S1		Rod/Strut, stabiliser	S100020
	1992.05-1994.03	Rear Axle	Saloon RWD M60B408S1		Stabiliser Bushing	511588
	1992.05-1994.03	Rear Axle	Saloon RWD M60B408S1		Stabiliser Bushing	512759
	1994.03-1996.02	Front Axle Left Lower	Saloon RWD M60B408S1		Track Control Arm	S060108
	1994.03-1996.02	Front Axle Left Upper	Saloon RWD M60B408S1		Track Control Arm	S060109
	1994.03-1996.02	Front Axle Right Lower	Saloon RWD M60B408S1		Track Control Arm	S060107
	1994.03-1996.02	Front Axle Right Upper	Saloon RWD M60B408S1		Track Control Arm	S060110
	1994.03-1996.02	Rear Axle Left Upper Outer	Saloon RWD M60B408S1		Track Control Arm	S060073
	1994.03-1996.02	Rear Axle Right Upper Outer	Saloon RWD M60B408S1		Track Control Arm	S060077
	1994.03-1996.02	Rear Axle Left & Right Lower	Saloon RWD M60B408S1		Track Control Arm	S060068
	1994.03-1996.02	Rear Axle Left & Right Upper Inner	Saloon RWD M60B408S1		Track Control Arm	S060061
	1994.03-1996.02	Front Axle Left & Right Upper	Saloon RWD M60B408S1		Control Arm Bushing	510621
	1994.03-1996.02	Front Axle Left & Right Lower Inner	Saloon RWD M60B408S1		Control Arm Bushing	510610
	1994.03-1996.02	Front Axle Left & Right Lower Inner	Saloon RWD M60B408S1		Control Arm Bushing	510630
	1994.03-1996.02	Rear Axle Left & Right Lower	Saloon RWD M60B408S1		Control Arm Bushing	517758
	1994.03-1996.02	Rear Axle Left & Right Lower	Saloon RWD M60B408S1		Control Arm Bushing	517765
	1994.03-1996.02	Rear Axle Left & Right Upper Inner	Saloon RWD M60B408S1		Control Arm Bushing	510619
	1994.03-1996.02	Front Axle Left & Right	Saloon RWD M60B408S1	Engine code M00 B40/408S1/AT For Left-Hand Drive Vehicles	Rod Assembly	S100031
	1994.03-1996.02	Front Axle Left & Right	Saloon RWD M60B408S1		Rod Assembly	S100374
	1994.03-1996.02	Front Axle Left	Saloon RWD M60B408S1		Tie Rod End	S070056
	1994.03-1996.02	Front Axle Right	Saloon RWD M60B408S1		Tie Rod End	S070057
	1994.03-1996.02	Front Axle Left & Right	Saloon RWD M60B408S1		Rod/Strut, stabiliser	S100036
	1994.03-1996.02	Rear Axle Left & Right	Saloon RWD M60B408S1		Rod/Strut, stabiliser	S100037
	1994.03-1996.02	Front Axle	Saloon RWD M60B408S1		Stabiliser Bushing	512298
4.4 (210 kw)	1996.02-2001.07	Front Axle Left Lower	Saloon RWD M62B448S1/M62B448S2		Track Control Arm	S060108
	1996.02-2001.07	Front Axle Left Upper	Saloon RWD M62B448S1/M62B448S2		Track Control Arm	S060109
	1996.02-2001.07	Front Axle Right Lower	Saloon RWD M62B448S1/M62B448S2		Track Control Arm	S060107
	1996.02-2001.07	Front Axle Right Upper	Saloon RWD M62B448S1/M62B448S2		Track Control Arm	S060110
	1996.02-2001.07	Rear Axle Left Upper Outer	Saloon RWD M62B448S1/M62B448S2		Track Control Arm	S060073
	1996.02-2001.07	Rear Axle Right Upper Outer	Saloon RWD M62B448S1/M62B448S2		Track Control Arm	S060077
	1996.02-2001.07	Rear Axle Left & Right Lower	Saloon RWD M62B448S1/M62B448S2		Track Control Arm	S060068
	1996.02-2001.07	Rear Axle Left & Right Upper Inner	Saloon RWD M62B448S1/M62B448S2		Track Control Arm	S060061
	1996.02-2001.07	Front Axle Left & Right Upper	Saloon RWD M62B448S1/M62B448S2		Control Arm Bushing	510621
	1996.02-2001.07	Front Axle Left & Right Lower Inner	Saloon RWD M62B448S1/M62B448S2		Control Arm Bushing	510610



	 YEAR	FITTING POSITION	BODY STYLE & DRIVE TYPE & ENGINE	REMARKS	PRODUCT	GSP Ref.
BMW 740i						
4.4 (210 kw)	1996.02-2001.07	Front Axle Left & Right Lower Inner	Saloon RWD M62B448S1/M62B448S2		Control Arm Bushing	510630
	1996.02-2001.07	Rear Axle Left & Right Lower	Saloon RWD M62B448S1/M62B448S2		Control Arm Bushing	517758
	1996.02-2001.07	Rear Axle Left & Right Lower	Saloon RWD M62B448S1/M62B448S2		Control Arm Bushing	517765
	1996.02-2001.07	Rear Axle Left & Right Upper Inner	Saloon RWD M62B448S1/M62B448S2		Control Arm Bushing	510619
	1996.02-2001.07	Front Axle Left & Right	Saloon RWD M62B448S1/M62B448S2	Engine code:M62 S41 (448S2)AT/For Left-Hand Drive Vehicles	Rod Assembly	S100031
	1996.02-2001.07	Front Axle Left & Right	Saloon RWD M62B448S1/M62B448S2		Rod Assembly	S100374
	1996.02-2001.07	Front Axle Left	Saloon RWD M62B448S1/M62B448S2		Tie Rod End	S070056
	1996.02-2001.07	Front Axle Right	Saloon RWD M62B448S1/M62B448S2		Tie Rod End	S070057
	1996.02-2001.07	Front Axle Left & Right	Saloon RWD M62B448S1/M62B448S2		Rod/Strut, stabiliser	S100036
	1996.02-2001.07	Rear Axle Left & Right	Saloon RWD M62B448S1/M62B448S2		Rod/Strut, stabiliser	S100037
	1996.02-2001.07	Front Axle	Saloon RWD M62B448S1/M62B448S2		Stabiliser Bushing	512298
745i						
4.4 (245 kw)	2001.07-2005.03	Front Axle Left Lower Inner	Saloon RWD N62B44A		Track Control Arm	S060354
	2001.07-2005.03	Front Axle Left Lower Outer	Saloon RWD N62B44A		Track Control Arm	S060356
	2001.07-2005.03	Front Axle Right Lower Inner	Saloon RWD N62B44A		Track Control Arm	S060355
	2001.07-2005.03	Front Axle Right Lower Outer	Saloon RWD N62B44A		Track Control Arm	S060357
	2001.07-2005.03	Rear Axle Left Upper Outer	Saloon RWD N62B44A		Track Control Arm	S060058
	2001.07-2005.03	Rear Axle Right Upper Outer	Saloon RWD N62B44A		Track Control Arm	S060057
	2001.07-2005.03	Rear Axle Left & Right Lower	Saloon RWD N62B44A		Track Control Arm	S060068
	2001.07-2005.03	Rear Axle Left & Right Upper Inner	Saloon RWD N62B44A		Track Control Arm	S060082
	2001.07-2005.03	Front Axle Left & Right Lower Inner	Saloon RWD N62B44A		Control Arm Bushing	510610
	2001.07-2005.03	Front Axle Left & Right Lower Outer	Saloon RWD N62B44A		Control Arm Bushing	510620
	2001.07-2005.03	Rear Axle Left & Right Lower	Saloon RWD N62B44A		Control Arm Bushing	516310
	2001.07-2005.03	Rear Axle Left & Right Lower	Saloon RWD N62B44A		Control Arm Bushing	516314
	2001.07-2005.03	Rear Axle Left & Right Upper	Saloon RWD N62B44A		Control Arm Bushing	510616
	2001.07-2005.03	Rear Axle Left & Right Upper Inner	Saloon RWD N62B44A		Control Arm Bushing	510619
	2001.07-2005.03	Rear Axle Left & Right Upper Inner	Saloon RWD N62B44A		Control Arm Bushing	517353
	2001.07-2005.03	Front Axle Left & Right Lower Inner	Saloon RWD N62B44A		Control Arm Bushing Kit	510620S
	2001.07-2005.03	Front Axle Left & Right	Saloon RWD N62B44A		Rod Assembly	S100334
	2001.07-2005.03	Front Axle Left & Right	Saloon RWD N62B44A		Tie Rod Axle Joint	S030347
	2001.07-2005.03	Front Axle Left & Right	Saloon RWD N62B44A		Tie Rod End	S070551
	2001.07-2005.03	Front Axle Left	Saloon RWD N62B44A		Rod/Strut, stabiliser	S050064
	2001.07-2005.03	Front Axle Right	Saloon RWD N62B44A		Rod/Strut, stabiliser	S050063
	2001.07-2005.03	Rear Axle Left & Right	Saloon RWD N62B44A		Rod/Strut, stabiliser	S050087
	2001.07-2005.03	Front Axle	Saloon RWD N62B44A		Stabiliser Bushing	517997
	2001.07-2005.03	Front Axle	Saloon RWD N62B44A	without Grease Bag	Steering Rack Bellow Kit	540342S
	2002.01-2005.03	Front Axle Left Lower Inner	Saloon RWD N62B44A		Track Control Arm	S060354
	2002.01-2005.03	Front Axle Left Lower Outer	Saloon RWD N62B44A		Track Control Arm	S060356
	2002.01-2005.03	Front Axle Right Lower Inner	Saloon RWD N62B44A		Track Control Arm	S060355
	2002.01-2005.03	Front Axle Right Lower Outer	Saloon RWD N62B44A		Track Control Arm	S060357
	2002.01-2005.03	Rear Axle Left Upper Outer	Saloon RWD N62B44A		Track Control Arm	S060058
	2002.01-2005.03	Rear Axle Right Upper Outer	Saloon RWD N62B44A		Track Control Arm	S060057
	2002.01-2005.03	Rear Axle Left & Right Lower	Saloon RWD N62B44A		Track Control Arm	S060068
	2002.01-2005.03	Rear Axle Left & Right Upper Inner	Saloon RWD N62B44A		Track Control Arm	S060082
	2002.01-2005.03	Front Axle Left & Right Lower Inner	Saloon RWD N62B44A		Control Arm Bushing	510610
	2002.01-2005.03	Front Axle Left & Right Lower Outer	Saloon RWD N62B44A		Control Arm Bushing	510620
	2002.01-2005.03	Rear Axle Left & Right Lower	Saloon RWD N62B44A		Control Arm Bushing	516310
	2002.01-2005.03	Rear Axle Left & Right Lower	Saloon RWD N62B44A		Control Arm Bushing	516314
	2002.01-2005.03	Rear Axle Left & Right Upper	Saloon RWD N62B44A		Control Arm Bushing	510616
	2002.01-2005.03	Rear Axle Left & Right Upper Inner	Saloon RWD N62B44A		Control Arm Bushing	510619
	2002.01-2005.03	Rear Axle Left & Right Upper Inner	Saloon RWD N62B44A		Control Arm Bushing	517353
	2002.01-2005.03	Front Axle Left & Right Lower Inner	Saloon RWD N62B44A		Control Arm Bushing Kit	510620S
	2002.01-2005.03	Front Axle Left & Right	Saloon RWD N62B44A		Rod Assembly	S100334
	2002.01-2005.03	Front Axle Left & Right	Saloon RWD N62B44A		Tie Rod Axle Joint	S030347
	2002.01-2005.03	Front Axle Left & Right	Saloon RWD N62B44A		Tie Rod End	S070551
	2002.01-2005.03	Front Axle Left	Saloon RWD N62B44A		Rod/Strut, stabiliser	S050064
	2002.01-2005.03	Front Axle Right	Saloon RWD N62B44A		Rod/Strut, stabiliser	S050063
	2002.01-2005.03	Rear Axle Left & Right	Saloon RWD N62B44A		Rod/Strut, stabiliser	S050087
	2002.01-2005.03	Front Axle	Saloon RWD N62B44A		Stabiliser Bushing	517997
	2002.01-2005.03	Front Axle	Saloon RWD N62B44A	without Grease Bag	Steering Rack Bellow Kit	540342S
750i						
4.4 (300 kw)	2008.09-2012.06	Front Axle Left Lower Inner	Saloon RWD N63B44A		Track Control Arm	S061150
	2008.09-2012.06	Front Axle Left Lower Outer	Saloon RWD N63B44A		Track Control Arm	S061152
	2008.09-2012.06	Front Axle Right Lower Inner	Saloon RWD N63B44A		Track Control Arm	S061151



	 YEAR	FITTING POSITION	BODY STYLE & DRIVE TYPE & ENGINE	REMARKS	PRODUCT	GSP Ref.
BMW 750i						
4.4 (300 kw)	2008.09-2012.06	Front Axle Right Lower Outer	Saloon RWD N63B44A		Track Control Arm	S061153
	2008.09-2012.06	Front Axle Left & Right Upper	Saloon RWD N63B44A		Track Control Arm	S061154
	2008.09-2012.06	Rear Axle Left Upper Inner	Saloon RWD N63B44A		Track Control Arm	S062750
	2008.09-2012.06	Rear Axle Right Upper Inner	Saloon RWD N63B44A		Track Control Arm	S062751
	2008.09-2012.06	Rear Axle Left & Right Lower	Saloon RWD N63B44A		Track Control Arm	S061576
	2008.09-2012.06	Rear Axle Left & Right Upper Outer	Saloon RWD N63B44A		Track Control Arm	S063030
	2008.09-2012.06	Front Axle Left & Right Lower Inner	Saloon RWD N63B44A		Control Arm Bushing	531934
	2008.09-2012.06	Front Axle Left & Right Lower Inner	Saloon RWD N63B44A		Control Arm Bushing	532572
	2008.09-2012.06	Front Axle Left & Right Lower Outer	Saloon RWD N63B44A		Control Arm Bushing	531938
	2008.09-2012.06	Front Axle Left & Right	Saloon RWD N63B44A		Tie Rod Axle Joint	S030354
	2008.09-2012.06	Front Axle Left	Saloon RWD N63B44A		Tie Rod End	S070999
	2008.09-2012.06	Front Axle Right	Saloon RWD N63B44A		Tie Rod End	S071000
	2008.09-2012.06	Front Axle Left & Right	Saloon RWD N63B44A		Rod/Strut, stabiliser	S051443
	2008.09-2012.06	Rear Axle Left & Right	Saloon RWD N63B44A	for vehicles without active stabiliser control	Rod/Strut, stabiliser	S050761
	2008.09-2012.06	Rear Axle Left & Right	Saloon RWD N63B44A	for vehicles with active stabilizer	Rod/Strut, stabiliser	S051461
	2008.09-2012.06	Front Axle	Saloon RWD N63B44A		Steering Boot	540440
	2008.09-2012.06	Front Axle	Saloon RWD N63B44A		Steering Rack Bellow Kit	540417S
4.4 (330 kw)	2015.11-2019.02	Front Axle Left & Right Upper	Saloon RWD N63B44C		Control Arm Bushing	535314
	2015.11-2019.02	Front Axle Left & Right Lower Inner	Saloon RWD N63B44C		Control Arm Bushing	531934
4.4 (331 kw)	2012.07-2015.06	Rear Axle Left Upper Inner	Saloon RWD N63B44B		Track Control Arm	S062750
	2012.07-2015.06	Rear Axle Right Upper Inner	Saloon RWD N63B44B		Track Control Arm	S062751
	2012.07-2015.06	Rear Axle Left & Right Upper Outer	Saloon RWD N63B44B		Track Control Arm	S063030
	2012.07-2015.06	Front Axle Left & Right Lower Inner	Saloon RWD N63B44B		Control Arm Bushing	531934
	2012.07-2015.06	Front Axle Left & Right	Saloon RWD N63B44B		Rod/Strut, stabiliser	S051443
	2012.07-2015.06	Rear Axle Left & Right	Saloon RWD N63B44B		Rod/Strut, stabiliser	S051461
	2012.07-2015.08	Rear Axle Left Upper Inner	Saloon RWD N63B44B		Track Control Arm	S062750
	2012.07-2015.08	Rear Axle Right Upper Inner	Saloon RWD N63B44B		Track Control Arm	S062751
	2012.07-2015.08	Rear Axle Left & Right Upper Outer	Saloon RWD N63B44B		Track Control Arm	S063030
	2012.07-2015.08	Front Axle Left & Right Lower Inner	Saloon RWD N63B44B		Control Arm Bushing	531934
	2012.07-2015.08	Front Axle Left & Right	Saloon RWD N63B44B		Rod/Strut, stabiliser	S051443
4.8 (270 kw)	2012.07-2015.08	Rear Axle Left & Right	Saloon RWD N63B44B		Rod/Strut, stabiliser	S051461
	2005.03-2008.08	Front Axle Left Lower Inner	Saloon RWD N62B48B		Track Control Arm	S060354
	2005.03-2008.08	Front Axle Left Lower Outer	Saloon RWD N62B48B		Track Control Arm	S060356
	2005.03-2008.08	Front Axle Right Lower Inner	Saloon RWD N62B48B		Track Control Arm	S060355
	2005.03-2008.08	Front Axle Right Lower Outer	Saloon RWD N62B48B		Track Control Arm	S060357
	2005.03-2008.08	Rear Axle Left Upper Outer	Saloon RWD N62B48B		Track Control Arm	S060058
	2005.03-2008.08	Rear Axle Right Upper Outer	Saloon RWD N62B48B		Track Control Arm	S060057
	2005.03-2008.08	Rear Axle Left & Right Lower	Saloon RWD N62B48B		Track Control Arm	S060068
	2005.03-2008.08	Rear Axle Left & Right Upper Inner	Saloon RWD N62B48B		Track Control Arm	S060082
	2005.03-2008.08	Front Axle Left & Right Lower Inner	Saloon RWD N62B48B		Control Arm Bushing	510610
	2005.03-2008.08	Front Axle Left & Right Lower Outer	Saloon RWD N62B48B		Control Arm Bushing	510620
	2005.03-2008.08	Rear Axle Left & Right Lower	Saloon RWD N62B48B		Control Arm Bushing	516310
	2005.03-2008.08	Rear Axle Left & Right Lower	Saloon RWD N62B48B		Control Arm Bushing	516314
	2005.03-2008.08	Rear Axle Left & Right Upper	Saloon RWD N62B48B		Control Arm Bushing	510616
	2005.03-2008.08	Rear Axle Left & Right Upper Inner	Saloon RWD N62B48B		Control Arm Bushing	510619
	2005.03-2008.08	Rear Axle Left & Right Upper Inner	Saloon RWD N62B48B	Date to:2006.09	Control Arm Bushing	517353
	2005.03-2008.08	Front Axle Left & Right Lower Inner	Saloon RWD N62B48B		Control Arm Bushing Kit	510620S
	2005.03-2008.08	Front Axle Left & Right	Saloon RWD N62B48B		Rod Assembly	S100334
	2005.03-2008.08	Front Axle Left & Right	Saloon RWD N62B48B		Tie Rod Axle Joint	S030347
	2005.03-2008.08	Front Axle Left & Right	Saloon RWD N62B48B		Tie Rod End	S070551
2005.03-2008.08	Front Axle Left	Saloon RWD N62B48B		Rod/Strut, stabiliser	S050064	
2005.03-2008.08	Front Axle Right	Saloon RWD N62B48B		Rod/Strut, stabiliser	S050063	
2005.03-2008.08	Rear Axle Left & Right	Saloon RWD N62B48B		Rod/Strut, stabiliser	S050087	
2005.03-2008.08	Front Axle	Saloon RWD N62B48B		Stabiliser Bushing	517997	
2005.03-2008.08	Front Axle	Saloon RWD N62B48B	without Grease Bag	Steering Rack Bellow Kit	540342S	
5.0 (220 kw)	1987.09-1994.12	Front Axle Left Lower	Saloon RWD M70B5012A		Track Control Arm	S060099
	1987.09-1994.12	Front Axle Left Lower	Saloon RWD M70B5012A		Track Control Arm	S060116
	1987.09-1994.12	Front Axle Left Lower Inner	Saloon RWD M70B5012A		Track Control Arm	S060103
	1987.09-1994.12	Front Axle Right Lower	Saloon RWD M70B5012A		Track Control Arm	S060100
	1987.09-1994.12	Front Axle Right Lower	Saloon RWD M70B5012A		Track Control Arm	S060115
	1987.09-1994.12	Front Axle Right Lower Inner	Saloon RWD M70B5012A		Track Control Arm	S060104
	1987.09-1994.12	Front Axle Left & Right Lower	Saloon RWD M70B5012A		Control Arm Bushing	510608
	1987.09-1994.12	Front Axle Left & Right Upper	Saloon RWD M70B5012A		Control Arm Bushing	510595
	1987.09-1994.12	Front Axle Left & Right Lower Inner	Saloon RWD M70B5012A		Control Arm Bushing	510610



	 YEAR	FITTING POSITION	BODY STYLE & DRIVE TYPE & ENGINE	REMARKS	PRODUCT	GSP Ref.
BMW 750i						
5.0 (220 kw)	1987.09-1994.12	Front Axle Left & Right	Saloon RWD M70B5012A		Rod Assembly	S100019
	1987.09-1994.12	Front Axle Left & Right	Saloon RWD M70B5012A	for left-hand drive vehicles	Rod Assembly	S100024
	1987.09-1994.12	Front Axle Left & Right	Saloon RWD M70B5012A		Tie Rod End	S070048
	1987.09-1994.12	Front Axle Left & Right	Saloon RWD M70B5012A		Tie Rod End	S070049
	1987.09-1994.12	Front Axle Left & Right	Saloon RWD M70B5012A		Rod/Strut, stabiliser	S050078
	1987.09-1994.12	Rear Axle Left & Right	Saloon RWD M70B5012A		Rod/Strut, stabiliser	S200093
	1987.09-1994.12	Rear Axle Left & Right	Saloon RWD M70B5012A		Rod/Strut, stabiliser	S100020
	1987.09-1994.12	Rear Axle	Saloon RWD M70B5012A		Stabiliser Bushing	S11588
5.4 (240 kw)	1994.11-2001.07	Front Axle Left Lower	Saloon RWD M73B54121/M73B54122		Track Control Arm	S060108
	1994.11-2001.07	Front Axle Left Upper	Saloon RWD M73B54121/M73B54122		Track Control Arm	S060109
	1994.11-2001.07	Front Axle Right Lower	Saloon RWD M73B54121/M73B54122		Track Control Arm	S060107
	1994.11-2001.07	Front Axle Right Upper	Saloon RWD M73B54121/M73B54122		Track Control Arm	S060110
	1994.11-2001.07	Rear Axle Left Upper Outer	Saloon RWD M73B54121/M73B54122		Track Control Arm	S060073
	1994.11-2001.07	Rear Axle Right Upper Outer	Saloon RWD M73B54121/M73B54122		Track Control Arm	S060077
	1994.11-2001.07	Rear Axle Left & Right Lower	Saloon RWD M73B54121/M73B54122		Track Control Arm	S060068
	1994.11-2001.07	Rear Axle Left & Right Upper Inner	Saloon RWD M73B54121/M73B54122		Track Control Arm	S060061
	1994.11-2001.07	Front Axle Left & Right Upper	Saloon RWD M73B54121/M73B54122		Control Arm Bushing	S10621
	1994.11-2001.07	Front Axle Left & Right Lower Inner	Saloon RWD M73B54121/M73B54122		Control Arm Bushing	S10610
	1994.11-2001.07	Front Axle Left & Right Lower Inner	Saloon RWD M73B54121/M73B54122		Control Arm Bushing	S10630
	1994.11-2001.07	Rear Axle Left & Right Lower	Saloon RWD M73B54121/M73B54122	AT	Control Arm Bushing	S17758
	1994.11-2001.07	Rear Axle Left & Right Lower	Saloon RWD M73B54121/M73B54122	AT	Control Arm Bushing	S17765
	1994.11-2001.07	Rear Axle Left & Right Upper Inner	Saloon RWD M73B54121/M73B54122		Control Arm Bushing	S10619
	1994.11-2001.07	Front Axle Left & Right	Saloon RWD M73B54121/M73B54122	AT, for left-hand drive vehicles	Rod Assembly	S100031
	1994.11-2001.07	Front Axle Left & Right	Saloon RWD M73B54121/M73B54122		Rod Assembly	S100374
	1994.11-2001.07	Front Axle Left	Saloon RWD M73B54121/M73B54122		Tie Rod End	S070056
	1994.11-2001.07	Front Axle Right	Saloon RWD M73B54121/M73B54122		Tie Rod End	S070057
	1994.11-2001.07	Front Axle Left & Right	Saloon RWD M73B54121/M73B54122		Rod/Strut, stabiliser	S100036
	1994.11-2001.07	Rear Axle Left & Right	Saloon RWD M73B54121/M73B54122		Rod/Strut, stabiliser	S100037
1994.11-2001.07	Front Axle	Saloon RWD M73B54121/M73B54122		Stabiliser Bushing	S12298	
750i xDrive						
4.4 (300 kw)	2009.09-2012.06	Front Axle Left & Right Upper	Saloon 4WD N63B44A		Track Control Arm	S061154
	2009.09-2012.06	Rear Axle Left Upper Inner	Saloon 4WD N63B44A		Track Control Arm	S062750
	2009.09-2012.06	Rear Axle Right Upper Inner	Saloon 4WD N63B44A		Track Control Arm	S062751
	2009.09-2012.06	Rear Axle Left & Right Lower	Saloon 4WD N63B44A		Track Control Arm	S061576
	2009.09-2012.06	Rear Axle Left & Right Upper Outer	Saloon 4WD N63B44A		Track Control Arm	S063030
	2009.09-2012.06	Front Axle Left & Right Lower Inner	Saloon 4WD N63B44A		Control Arm Bushing	S31934
	2009.09-2012.06	Front Axle Left & Right Lower Outer	Saloon 4WD N63B44A		Control Arm Bushing	S31938
	2009.09-2012.06	Front Axle Left & Right	Saloon 4WD N63B44A		Tie Rod Axle Joint	S030354
	2009.09-2012.06	Front Axle Left	Saloon 4WD N63B44A		Tie Rod End	S070999
	2009.09-2012.06	Front Axle Right	Saloon 4WD N63B44A		Tie Rod End	S071000
	2009.09-2012.06	Front Axle Left & Right	Saloon 4WD N63B44A		Rod/Strut, stabiliser	S051443
	2009.09-2012.06	Rear Axle Left & Right	Saloon 4WD N63B44A	for vehicles without active stabiliser control	Rod/Strut, stabiliser	S050761
	2009.09-2012.06	Rear Axle Left & Right	Saloon 4WD N63B44A	for vehicles with active stabiliser	Rod/Strut, stabiliser	S051461
	2009.09-2012.06	Front Axle	Saloon 4WD N63B44A		Steering Boot	S40440
2009.09-2012.06	Front Axle	Saloon 4WD N63B44A		Steering Rack Bellow Kit	S40417S	
760i						
6.0 (327 kw)	2003.01-2008.08	Front Axle Left Lower Inner	Saloon RWD N73B60A/N73B60B		Track Control Arm	S060354
	2003.01-2008.08	Front Axle Left Lower Outer	Saloon RWD N73B60A/N73B60B		Track Control Arm	S060356
	2003.01-2008.08	Front Axle Right Lower Inner	Saloon RWD N73B60A/N73B60B		Track Control Arm	S060355
	2003.01-2008.08	Front Axle Right Lower Outer	Saloon RWD N73B60A/N73B60B		Track Control Arm	S060357
	2003.01-2008.08	Rear Axle Left Upper Outer	Saloon RWD N73B60A/N73B60B		Track Control Arm	S060058
	2003.01-2008.08	Rear Axle Right Upper Outer	Saloon RWD N73B60A/N73B60B		Track Control Arm	S060057
	2003.01-2008.08	Rear Axle Left & Right Lower	Saloon RWD N73B60A/N73B60B		Track Control Arm	S060068
	2003.01-2008.08	Rear Axle Left & Right Upper Inner	Saloon RWD N73B60A/N73B60B		Track Control Arm	S060082
	2003.01-2008.08	Front Axle Left & Right Lower Inner	Saloon RWD N73B60A/N73B60B		Control Arm Bushing	S10610
	2003.01-2008.08	Front Axle Left & Right Lower Outer	Saloon RWD N73B60A/N73B60B		Control Arm Bushing	S10620
	2003.01-2008.08	Rear Axle Left & Right Lower	Saloon RWD N73B60A/N73B60B		Control Arm Bushing	S16310
	2003.01-2008.08	Rear Axle Left & Right Lower	Saloon RWD N73B60A/N73B60B		Control Arm Bushing	S16314
	2003.01-2008.08	Rear Axle Left & Right Upper	Saloon RWD N73B60A/N73B60B		Control Arm Bushing	S10616
	2003.01-2008.08	Rear Axle Left & Right Upper Inner	Saloon RWD N73B60A/N73B60B		Control Arm Bushing	S10619
	2003.01-2008.08	Rear Axle Left & Right Upper Inner	Saloon RWD N73B60A/N73B60B	Date to:2006.09	Control Arm Bushing	S17353
	2003.01-2008.08	Front Axle Left & Right Lower Inner	Saloon RWD N73B60A/N73B60B		Control Arm Bushing Kit	S10620S
	2003.01-2008.08	Front Axle Left & Right	Saloon RWD N73B60A/N73B60B		Rod Assembly	S100334
	2003.01-2008.08	Front Axle Left & Right	Saloon RWD N73B60A/N73B60B		Tie Rod Axle Joint	S030347



	 YEAR	FITTING POSITION	BODY STYLE & DRIVE TYPE & ENGINE	REMARKS	PRODUCT	GSP Ref.
BMW 760i						
6.0 (327 kw)	2003.01-2008.08	Front Axle Left & Right	Saloon RWD N73B60A/N73B60B		Tie Rod End	S070551
	2003.01-2008.08	Front Axle Left	Saloon RWD N73B60A/N73B60B		Rod/Strut, stabiliser	S050064
	2003.01-2008.08	Front Axle Right	Saloon RWD N73B60A/N73B60B		Rod/Strut, stabiliser	S050063
	2003.01-2008.08	Front Axle	Saloon RWD N73B60A/N73B60B	without Grease Bag	Steering Rack Bellow Kit	540342S
840i						
4.4 (210 kw)	1996.03-1999.06	Front Axle Left Lower Inner	Coupe RWD M62B448S1		Track Control Arm	S060103
	1996.03-1999.06	Front Axle Right Lower Inner	Coupe RWD M62B448S1		Track Control Arm	S060104
	1996.03-1999.06	Front Axle Left & Right Lower	Coupe RWD M62B448S1		Control Arm Bushing	510608
	1996.03-1999.06	Front Axle Left & Right Upper	Coupe RWD M62B448S1		Control Arm Bushing	510595
	1996.03-1999.06	Front Axle Left & Right Lower Inner	Coupe RWD M62B448S1		Control Arm Bushing	510610
	1996.03-1999.06	Front Axle Left & Right	Coupe RWD M62B448S1		Rod Assembly	S100019
	1996.03-1999.06	Front Axle Left & Right	Coupe RWD M62B448S1		Tie Rod End	S070048
	1996.03-1999.06	Front Axle Left & Right	Coupe RWD M62B448S1		Tie Rod End	S070049
1996.03-1999.06	Front Axle Left & Right	Coupe RWD M62B448S1		Rod/Strut, stabiliser	S050078	
850i						
5.0 (220 kw)	1990.01-1994.08	Front Axle Left Lower Inner	Coupe RWD M70B5012A		Track Control Arm	S060103
	1990.01-1994.08	Front Axle Right Lower Inner	Coupe RWD M70B5012A		Track Control Arm	S060104
	1990.01-1994.08	Front Axle Left & Right Lower	Coupe RWD M70B5012A		Control Arm Bushing	510608
	1990.01-1994.08	Front Axle Left & Right Upper	Coupe RWD M70B5012A		Control Arm Bushing	510595
	1990.01-1994.08	Front Axle Left & Right Lower Inner	Coupe RWD M70B5012A		Control Arm Bushing	510610
	1990.01-1994.08	Front Axle Left & Right	Coupe RWD M70B5012A		Rod Assembly	S100019
	1990.01-1994.08	Front Axle Left & Right	Coupe RWD M70B5012A		Tie Rod End	S070048
	1990.01-1994.08	Front Axle Left & Right	Coupe RWD M70B5012A		Tie Rod End	S070049
	1990.01-1994.08	Front Axle Left & Right	Coupe RWD M70B5012A		Tie Rod End	S070824
	1990.01-1994.08	Front Axle Left & Right	Coupe RWD M70B5012A		Tie Rod End	S070840
	1990.01-1994.08	Front Axle Left & Right	Coupe RWD M70B5012A		Rod/Strut, stabiliser	S050078
5.6 (280 kw)	1993.04-1996.12	Front Axle Left Lower Inner	Coupe RWD S70B56121		Track Control Arm	S060103
	1993.04-1996.12	Front Axle Right Lower Inner	Coupe RWD S70B56121		Track Control Arm	S060104
	1993.04-1996.12	Front Axle Left & Right Lower	Coupe RWD S70B56121		Control Arm Bushing	510608
	1993.04-1996.12	Front Axle Left & Right Upper	Coupe RWD S70B56121		Control Arm Bushing	510595
	1993.04-1996.12	Front Axle Left & Right Lower Inner	Coupe RWD S70B56121		Control Arm Bushing	510610
	1993.04-1996.12	Front Axle Left & Right	Coupe RWD S70B56121		Rod Assembly	S100019
	1993.04-1996.12	Front Axle Left & Right	Coupe RWD S70B56121		Tie Rod End	S070048
	1993.04-1996.12	Front Axle Left & Right	Coupe RWD S70B56121		Tie Rod End	S070049
1993.04-1996.12	Front Axle Left & Right	Coupe RWD S70B56121		Rod/Strut, stabiliser	S050078	
i8						
1.5 (170 kw)	2014.03-2020.06	Rear Axle Left	Coupe 4WD B38K15A		Rod/Strut, stabiliser	S051261
	2014.03-2020.06	Rear Axle Right	Coupe 4WD B38K15A		Rod/Strut, stabiliser	S051262
	2018.03-2020.06	Rear Axle Right	Cabriolet 4WD B38K15A		Rod/Strut, stabiliser	S051262
M Coupe						
3.0 (250 kw)	2011.03-2012.06	Front Axle Right Lower Inner	Coupe RWD N54B30A		Track Control Arm	S063258
	2011.03-2012.06	Rear Axle Left & Right Upper	Coupe RWD N54B30A		Track Control Arm	S062839
	2011.03-2012.06	Front Axle	Coupe RWD N54B30A		Suspension Repair Kit	S990004SK
	2011.03-2012.06	Front Axle Left	Coupe RWD N54B30A		Rod Assembly	S100330
	2011.03-2012.06	Front Axle Right	Coupe RWD N54B30A		Rod Assembly	S100331
	2011.03-2012.06	Front Axle Left & Right	Coupe RWD N54B30A		Tie Rod Axle Joint	S030350
	2011.03-2012.06	Front Axle Left	Coupe RWD N54B30A		Tie Rod End	S070045
	2011.03-2012.06	Front Axle Right	Coupe RWD N54B30A		Tie Rod End	S070046
2011.03-2012.06	Rear Axle Left & Right	Coupe RWD N54B30A		Rod/Strut, stabiliser	S050070	
M135i						
3.0 (235 kw)	2012.07-2015.02	Front Axle Left Lower Inner	Hatchback RWD N55B30A		Track Control Arm	S061616
	2012.07-2015.02	Front Axle Left Lower Outer	Hatchback RWD N55B30A		Track Control Arm	S061614
	2012.07-2015.02	Front Axle Right Lower Inner	Hatchback RWD N55B30A		Track Control Arm	S061617
	2012.07-2015.02	Front Axle Right Lower Outer	Hatchback RWD N55B30A		Track Control Arm	S061615
	2012.07-2015.02	Rear Axle Left Upper Inner	Hatchback RWD N55B30A		Track Control Arm	S061775
	2012.07-2015.02	Rear Axle Right Upper Inner	Hatchback RWD N55B30A		Track Control Arm	S061776
	2012.07-2015.02	Rear Axle Left & Right Lower Inner	Hatchback RWD N55B30A		Track Control Arm	S061773
	2012.07-2015.02	Rear Axle Left & Right Lower Outer	Hatchback RWD N55B30A		Track Control Arm	S061774
	2012.07-2015.02	Front Axle Left & Right Lower Inner	Hatchback RWD N55B30A		Control Arm Bushing	532583
	2012.07-2015.02	Front Axle Left & Right Lower Outer	Hatchback RWD N55B30A		Control Arm Bushing	533483
	2012.07-2015.02	Front Axle Left	Hatchback RWD N55B30A	for vehicles with Adaptive Drive	Rod/Strut, stabiliser	S051259
	2012.07-2015.02	Front Axle Left	Hatchback RWD N55B30A	for vehicles with M-technology	Rod/Strut, stabiliser	S051353
	2012.07-2015.02	Front Axle Right	Hatchback RWD N55B30A		Rod/Strut, stabiliser	S051260
	2012.07-2015.02	Front Axle Left & Right	Hatchback RWD N55B30A	for vehicles without Adaptive Drive	Rod/Strut, stabiliser	S051259



	 YEAR	FITTING POSITION	BODY STYLE & DRIVE TYPE & ENGINE	REMARKS	PRODUCT	GSP Ref.
BMW M135i						
3.0 (235 kw)	2012.07-2015.02	Front Axle Left & Right	Hatchback RWD N55B30A	for vehicles with standard suspension	Rod/Strut, stabiliser	S051353
	2012.07-2015.02	Rear Axle Left	Hatchback RWD N55B30A		Rod/Strut, stabiliser	S051261
	2012.07-2015.02	Rear Axle Right	Hatchback RWD N55B30A		Rod/Strut, stabiliser	S051262
3.0 (240 kw)	2015.03-2016.06	Front Axle Left Lower Inner	Hatchback RWD N55B30A		Track Control Arm	S061616
	2015.03-2016.06	Front Axle Left Lower Outer	Hatchback RWD N55B30A		Track Control Arm	S061614
	2015.03-2016.06	Front Axle Right Lower Inner	Hatchback RWD N55B30A		Track Control Arm	S061617
	2015.03-2016.06	Front Axle Right Lower Outer	Hatchback RWD N55B30A		Track Control Arm	S061615
	2015.03-2016.06	Rear Axle Left Upper Inner	Hatchback RWD N55B30A		Track Control Arm	S061775
	2015.03-2016.06	Rear Axle Right Upper Inner	Hatchback RWD N55B30A		Track Control Arm	S061776
	2015.03-2016.06	Rear Axle Left & Right Lower Inner	Hatchback RWD N55B30A		Track Control Arm	S061773
	2015.03-2016.06	Rear Axle Left & Right Lower Outer	Hatchback RWD N55B30A		Track Control Arm	S061774
	2015.03-2016.06	Front Axle Left & Right Lower Inner	Hatchback RWD N55B30A		Control Arm Bushing	532583
	2015.03-2016.06	Front Axle Left & Right Lower Outer	Hatchback RWD N55B30A		Control Arm Bushing	533483
	2015.03-2016.06	Front Axle Left	Hatchback RWD N55B30A	for vehicles with Adaptive Drive	Rod/Strut, stabiliser	S051259
	2015.03-2016.06	Front Axle Left	Hatchback RWD N55B30A	for vehicles with M-technology	Rod/Strut, stabiliser	S051353
	2015.03-2016.06	Front Axle Right	Hatchback RWD N55B30A		Rod/Strut, stabiliser	S051260
	2015.03-2016.06	Front Axle Left & Right	Hatchback RWD N55B30A	for vehicles without Adaptive Drive	Rod/Strut, stabiliser	S051259
	2015.03-2016.06	Front Axle Left & Right	Hatchback RWD N55B30A	for vehicles with standard suspension	Rod/Strut, stabiliser	S051353
2015.03-2016.06	Rear Axle Left	Hatchback RWD N55B30A		Rod/Strut, stabiliser	S051261	
2015.03-2016.06	Rear Axle Right	Hatchback RWD N55B30A		Rod/Strut, stabiliser	S051262	
M135i xDrive						
2.0 (225 kw)	2019.07-	Rear Axle Left & Right Upper	Hatchback 4WD B48A20E		Track Control Arm	S063055
	2019.07-	Front Axle Left & Right	Hatchback 4WD B48A20E		Rod/Strut, stabiliser	S051334
	2019.07-	Rear Axle Left & Right	Hatchback 4WD B48A20E		Rod/Strut, stabiliser	S051243
M140i						
3.0 (250 kw)	2016.07-2019.06	Front Axle Left Lower Inner	Hatchback RWD B58B30A		Track Control Arm	S061616
	2016.07-2019.06	Front Axle Left Lower Outer	Hatchback RWD B58B30A		Track Control Arm	S061614
	2016.07-2019.06	Front Axle Right Lower Inner	Hatchback RWD B58B30A		Track Control Arm	S061617
	2016.07-2019.06	Front Axle Right Lower Outer	Hatchback RWD B58B30A		Track Control Arm	S061615
	2016.07-2019.06	Rear Axle Left Upper Inner	Hatchback RWD B58B30A		Track Control Arm	S061775
	2016.07-2019.06	Rear Axle Right Upper Inner	Hatchback RWD B58B30A		Track Control Arm	S061776
	2016.07-2019.06	Rear Axle Left & Right Lower Inner	Hatchback RWD B58B30A		Track Control Arm	S061773
	2016.07-2019.06	Rear Axle Left & Right Lower Outer	Hatchback RWD B58B30A		Track Control Arm	S061774
	2016.07-2019.06	Front Axle Left & Right Lower Inner	Hatchback RWD B58B30A		Control Arm Bushing	532583
	2016.07-2019.06	Front Axle Left & Right Lower Outer	Hatchback RWD B58B30A		Control Arm Bushing	533483
	2016.07-2019.06	Front Axle Left	Hatchback RWD B58B30A	for vehicles with Adaptive Drive	Rod/Strut, stabiliser	S051259
	2016.07-2019.06	Front Axle Left	Hatchback RWD B58B30A	for vehicles with M-technology	Rod/Strut, stabiliser	S051353
	2016.07-2019.06	Front Axle Right	Hatchback RWD B58B30A		Rod/Strut, stabiliser	S051260
	2016.07-2019.06	Front Axle Left & Right	Hatchback RWD B58B30A	for vehicles without Adaptive Drive	Rod/Strut, stabiliser	S051259
	2016.07-2019.06	Front Axle Left & Right	Hatchback RWD B58B30A	for vehicles with standard suspension	Rod/Strut, stabiliser	S051353
2016.07-2019.06	Rear Axle Left	Hatchback RWD B58B30A		Rod/Strut, stabiliser	S051261	
2016.07-2019.06	Rear Axle Right	Hatchback RWD B58B30A		Rod/Strut, stabiliser	S051262	
M2 Coupe						
3.0 (272 kw)	2015.11-2018.06	Front Axle Left Lower Inner	Coupe RWD N55B30A		Track Control Arm	S063250
	2015.11-2018.06	Front Axle Left Lower Outer	Coupe RWD N55B30A		Track Control Arm	S063254
	2015.11-2018.06	Front Axle Right Lower Outer	Coupe RWD N55B30A	For OE no.31122284532	Track Control Arm	S063243
3.0 (302 kw)	2018.06-	Front Axle Left Lower Inner	Coupe RWD S55B30A		Track Control Arm	S063250
	2018.06-	Front Axle Left Lower Outer	Coupe RWD S55B30A		Track Control Arm	S063254
	2018.06-	Front Axle Right Lower Outer	Coupe RWD S55B30A	For OE no.31122284532	Track Control Arm	S063243
M235i Coupe						
3.0 (240 kw)	2013.10-	Front Axle Left Lower Inner	Coupe RWD N55B30A		Track Control Arm	S061616
	2013.10-	Front Axle Left Lower Inner	Coupe RWD N55B30A		Track Control Arm	S063250
	2013.10-	Front Axle Left Lower Outer	Coupe RWD N55B30A	For OE no.31126851259	Track Control Arm	S061614
	2013.10-	Front Axle Left Lower Outer	Coupe RWD N55B30A		Track Control Arm	S063254
	2013.10-	Front Axle Right Lower Inner	Coupe RWD N55B30A		Track Control Arm	S061617
	2013.10-	Front Axle Right Lower Outer	Coupe RWD N55B30A	For OE no.31126851260	Track Control Arm	S061615
	2013.10-	Front Axle Right Lower Outer	Coupe RWD N55B30A		Track Control Arm	S063243
	2013.10-	Rear Axle Left Upper Inner	Coupe RWD N55B30A		Track Control Arm	S061775
	2013.10-	Rear Axle Right Upper Inner	Coupe RWD N55B30A		Track Control Arm	S061776
	2013.10-	Rear Axle Left & Right Lower Inner	Coupe RWD N55B30A		Track Control Arm	S061773
	2013.10-	Rear Axle Left & Right Lower Outer	Coupe RWD N55B30A		Track Control Arm	S061774
	2013.10-	Front Axle Left & Right Lower Inner	Coupe RWD N55B30A		Control Arm Bushing	532583
	2013.10-	Front Axle Left & Right Lower Outer	Coupe RWD N55B30A		Control Arm Bushing	533483
	2013.10-	Front Axle Left	Coupe RWD N55B30A	for vehicles with Adaptive Drive	Rod/Strut, stabiliser	S051259



	 YEAR	FITTING POSITION	BODY STYLE & DRIVE TYPE & ENGINE	REMARKS	PRODUCT	GSP Ref.
BMW M235i Coupe						
3.0 (240 kw)	2013.10-	Front Axle Left	Coupe RWD N55B30A	for vehicles with M-technology for vehicles with electronic suspension control	Rod/Strut, stabiliser	S051353
	2013.10-	Front Axle Right	Coupe RWD N55B30A		Rod/Strut, stabiliser	S051260
	2013.10-	Front Axle Left & Right	Coupe RWD N55B30A	for vehicles without Adaptive Drive	Rod/Strut, stabiliser	S051259
	2013.10-	Front Axle Left & Right	Coupe RWD N55B30A	for vehicles with standard suspension for vehicles without electronic suspension control	Rod/Strut, stabiliser	S051353
	2013.10-	Rear Axle Left	Coupe RWD N55B30A		Rod/Strut, stabiliser	S051261
	2013.10-	Rear Axle Right	Coupe RWD N55B30A		Rod/Strut, stabiliser	S051262
M3						
3.0 (317 kw)	2014.03-2015.06	Front Axle Left Lower Inner	Saloon RWD S55B30A		Track Control Arm	S063250
	2014.03-2015.06	Front Axle Left Lower Outer	Saloon RWD S55B30A		Track Control Arm	S063254
	2014.03-2015.06	Front Axle Right Lower Outer	Saloon RWD S55B30A	For OE no.31122284532	Track Control Arm	S063243
	2014.03-2015.06	Rear Axle Left & Right Lower Inner	Saloon RWD S55B30A		Track Control Arm	S061773
	2014.03-2015.06	Front Axle Left & Right Lower Inner	Saloon RWD S55B30A		Control Arm Bushing	532583
3.0 (338 kw)	2018.01-2018.10	Front Axle Left Lower Inner	Saloon RWD S55B30A		Track Control Arm	S063250
	2018.01-2018.10	Front Axle Left Lower Outer	Saloon RWD S55B30A		Track Control Arm	S063254
	2018.01-2018.10	Front Axle Right Lower Outer	Saloon RWD S55B30A	For OE no.31122284532	Track Control Arm	S063243
	2018.01-2018.10	Rear Axle Left Upper Inner	Saloon RWD S55B30A		Track Control Arm	S061775
	2018.01-2018.10	Rear Axle Right Upper Inner	Saloon RWD S55B30A		Track Control Arm	S061776
	2018.01-2018.10	Rear Axle Left & Right Lower Inner	Saloon RWD S55B30A		Track Control Arm	S061773
	2018.01-2018.10	Rear Axle Left & Right Lower Outer	Saloon RWD S55B30A		Track Control Arm	S061774
	2018.01-2018.10	Front Axle Left	Saloon RWD S55B30A		Rod/Strut, stabiliser	S051353
2018.01-2018.10	Front Axle Left & Right	Saloon RWD S55B30A		Rod/Strut, stabiliser	S051353	
4.0 (309 kw)	2007.12-2011.10	Front Axle Right Lower Inner	Saloon RWD S65B40A		Track Control Arm	S063258
	2007.12-2011.10	Rear Axle Left Centre	Saloon RWD S65B40A		Track Control Arm	S063116
	2007.12-2011.10	Rear Axle Right Centre	Saloon RWD S65B40A		Track Control Arm	S063115
	2007.12-2011.10	Rear Axle Left & Right Centre	Saloon RWD S65B40A		Track Control Arm	S060089
	2007.12-2011.10	Rear Axle Left & Right Upper	Saloon RWD S65B40A		Track Control Arm	S062839
	2007.12-2011.10	Front Axle	Saloon RWD S65B40A		Suspension Repair Kit	S990004SK
	2007.12-2011.10	Front Axle Left	Saloon RWD S65B40A		Tie Rod End	S070045
	2007.12-2011.10	Front Axle Right	Saloon RWD S65B40A		Tie Rod End	S070046
	2007.12-2011.10	Rear Axle Left & Right	Saloon RWD S65B40A	L:160mm	Rod/Strut, stabiliser	S050070
	2007.12-2011.10	Rear Axle Left & Right	Saloon RWD S65B40A	L:161mm	Rod/Strut, stabiliser	S051405
2007.12-2011.10	Rear Axle	Saloon RWD S65B40A		Stabiliser Bushing	535305	
M3 Coupe						
3.2 (252 kw)	2000.07-2006.05	Rear Axle Left & Right Lower Inner	Coupe RWD S54B326S4		Track Control Arm	S060098
	2000.07-2006.05	Rear Axle Left & Right Upper	Coupe RWD S54B326S4		Control Arm Bushing	512710
	2000.07-2006.05	Rear Axle Left & Right Lower Inner	Coupe RWD S54B326S4		Control Arm Bushing	512305
	2000.07-2006.05	Front Axle Left & Right Lower	Coupe RWD S54B326S4		Control Arm Bushing Kit	530752S
	2000.07-2006.05	Front Axle Left & Right	Coupe RWD S54B326S4		Rod/Strut, stabiliser	S050056
	2000.07-2006.05	Rear Axle Left & Right	Coupe RWD S54B326S4		Rod/Strut, stabiliser	S051332
	2000.07-2006.05	Front Axle	Coupe RWD S54B326S4		Stabiliser Bushing	519360
	2000.07-2006.05	Front Axle	Coupe RWD S54B326S4		Stabiliser Bushing	530971
	2000.07-2006.05	Front Axle	Coupe RWD S54B326S4		Steering Boot	540041
	2000.07-2006.05	Front Axle	Coupe RWD S54B326S4	for vehicles with power steering	Steering Boot	540186
2000.07-2006.05	Front Axle	Coupe RWD S54B326S4	for vehicles with power steering	Steering Rack Bellow Kit	540186S	
3.2 (265 kw)	2003.05-2003.12	Rear Axle Left & Right Lower Inner	Coupe RWD S54B326S4		Track Control Arm	S060098
	2003.05-2003.12	Rear Axle Left & Right Upper	Coupe RWD S54B326S4		Control Arm Bushing	512710
	2003.05-2003.12	Rear Axle Left & Right Lower Inner	Coupe RWD S54B326S4		Control Arm Bushing	512305
	2003.05-2003.12	Front Axle Left & Right Lower	Coupe RWD S54B326S4		Control Arm Bushing Kit	530752S
	2003.05-2003.12	Front Axle Left & Right	Coupe RWD S54B326S4		Rod/Strut, stabiliser	S050056
	2003.05-2003.12	Rear Axle Left & Right	Coupe RWD S54B326S4		Rod/Strut, stabiliser	S051332
	2003.05-2003.12	Front Axle	Coupe RWD S54B326S4		Stabiliser Bushing	519360
	2003.05-2003.12	Front Axle	Coupe RWD S54B326S4		Stabiliser Bushing	530971
	2003.05-2003.12	Front Axle	Coupe RWD S54B326S4		Steering Boot	540041
	2003.05-2003.12	Front Axle	Coupe RWD S54B326S4		Steering Boot	540186
2003.05-2003.12	Front Axle	Coupe RWD S54B326S4	for vehicles with power steering	Steering Rack Bellow Kit	540186S	
4.0 (309 kw)	2007.06-2013.06	Front Axle Right Lower Inner	Coupe RWD S65B40A		Track Control Arm	S063258
	2007.06-2013.06	Rear Axle Left Centre	Coupe RWD S65B40A		Track Control Arm	S063116
	2007.06-2013.06	Rear Axle Right Centre	Coupe RWD S65B40A		Track Control Arm	S063115
	2007.06-2013.06	Rear Axle Left & Right Centre	Coupe RWD S65B40A		Track Control Arm	S060089
	2007.06-2013.06	Rear Axle Left & Right Upper	Coupe RWD S65B40A		Track Control Arm	S062839
	2007.06-2013.06	Front Axle	Coupe RWD S65B40A		Suspension Repair Kit	S990004SK
	2007.06-2013.06	Front Axle Left	Coupe RWD S65B40A		Tie Rod End	S070045
	2007.06-2013.06	Front Axle Right	Coupe RWD S65B40A		Tie Rod End	S070046
2007.06-2013.06	Rear Axle Left & Right	Coupe RWD S65B40A		Rod/Strut, stabiliser	S050070	



	 YEAR	FITTING POSITION	BODY STYLE & DRIVE TYPE & ENGINE	REMARKS	PRODUCT	GSP Ref.
BMW M3 Coupe						
4.0 (309 kw)	2007.06-2013.06	Rear Axle	Coupe RWD S65B40A		Stabiliser Bushing	535305
M340i xDrive						
3.0 (285 kw)	2019.03-	Rear Axle Left	Saloon 4WD B58B30B		Rod/Strut,stabiliser	S051261
	2019.03-	Rear Axle Right	Saloon 4WD B58B30B		Rod/Strut,stabiliser	S051262
M4 Cabrio						
3.0 (317 kw)	2014.07-	Front Axle Left Lower Inner	Cabriolet RWD S55B30A		Track Control Arm	S063250
	2014.07-	Front Axle Left Lower Outer	Cabriolet RWD S55B30A		Track Control Arm	S063254
	2014.07-	Front Axle Right Lower Outer	Cabriolet RWD S55B30A	For OE no.31122284532	Track Control Arm	S063243
M4 Coupe						
3.0 (317 kw)	2014.01-	Front Axle Left Lower Inner	Coupe RWD S55B30A		Track Control Arm	S063250
	2014.01-	Front Axle Left Lower Outer	Coupe RWD S55B30A		Track Control Arm	S063254
	2014.01-	Front Axle Right Lower Outer	Coupe RWD S55B30A	For OE no.31122284532	Track Control Arm	S063243
	2014.01-	Front Axle Left & Right Lower Inner	Coupe RWD S55B30A		Control Arm Bushing	532583
3.0 (338 kw)	2017.07-2019.06	Front Axle Left Lower Inner	Coupe RWD S55B30A		Track Control Arm	S063250
	2017.07-2019.06	Front Axle Left Lower Outer	Coupe RWD S55B30A		Track Control Arm	S063254
	2017.07-2019.06	Front Axle Right Lower Outer	Coupe RWD S55B30A	For OE no.31122284532	Track Control Arm	S063243
M5						
4.4 (412 kw)	2011.09-2016.10	Front Axle Left & Right Upper	Saloon RWD S63B44B		Track Control Arm	S061154
	2011.09-2016.10	Rear Axle Left Upper Inner	Saloon RWD S63B44B		Track Control Arm	S062966
	2011.09-2016.10	Rear Axle Right Upper Inner	Saloon RWD S63B44B		Track Control Arm	S062967
	2011.09-2016.10	Rear Axle Left & Right Lower	Saloon RWD S63B44B		Track Control Arm	S061576
	2011.09-2016.10	Rear Axle Left & Right Upper Outer	Saloon RWD S63B44B		Track Control Arm	S063030
	2011.09-2016.10	Front Axle Left & Right Lower Inner	Saloon RWD S63B44B		Control Arm Bushing	531934
	2011.09-2016.10	Rear Axle Left & Right Lower	Saloon RWD S63B44B		Control Arm Bushing	516314
	2011.09-2016.10	Front Axle Left & Right	Saloon RWD S63B44B		Tie Rod Axle Joint	S030354
	2011.09-2016.10	Front Axle Left	Saloon RWD S63B44B		Tie Rod End	S070999
	2011.09-2016.10	Front Axle Right	Saloon RWD S63B44B		Tie Rod End	S071000
	2011.09-2016.10	Front Axle Left & Right	Saloon RWD S63B44B		Rod/Strut,stabiliser	S051443
	2011.09-2016.10	Rear Axle Left & Right	Saloon RWD S63B44B		Rod/Strut,stabiliser	S051461
	2011.09-2016.10	Front Axle	Saloon RWD S63B44B		Steering Boot	540440
	2011.09-2016.10	Front Axle	Saloon RWD S63B44B		Steering Rack Bellow Kit	540417S
4.4 (441 kw)	2017.09-	Front Axle Left & Right Upper	Saloon 4WD S63B44B		Control Arm Bushing	535314
4.9 (294 kw)	1998.10-2003.06	Front Axle Left Lower Inner	Saloon RWD S62B508S1		Track Control Arm	S060352
	1998.10-2003.06	Front Axle Left Lower Outer	Saloon RWD S62B508S1		Track Control Arm	S060067
	1998.10-2003.06	Front Axle Right Lower Inner	Saloon RWD S62B508S1		Track Control Arm	S060353
	1998.10-2003.06	Front Axle Right Lower Outer	Saloon RWD S62B508S1		Track Control Arm	S060066
	1998.10-2003.06	Rear Axle Left Upper Outer	Saloon RWD S62B508S1		Track Control Arm	S060058
	1998.10-2003.06	Rear Axle Right Upper Outer	Saloon RWD S62B508S1		Track Control Arm	S060057
	1998.10-2003.06	Rear Axle Left & Right Lower	Saloon RWD S62B508S1		Track Control Arm	S060068
	1998.10-2003.06	Rear Axle Left & Right Upper Inner	Saloon RWD S62B508S1	Date to:2000.07	Track Control Arm	S060061
	1998.10-2003.06	Rear Axle Left & Right Upper Inner	Saloon RWD S62B508S1	Date from:2000.07	Track Control Arm	S060082
	1998.10-2003.06	Front Axle Left & Right Upper	Saloon RWD S62B508S1		Control Arm Bushing	510621
	1998.10-2003.06	Front Axle Left & Right Lower Inner	Saloon RWD S62B508S1		Control Arm Bushing	510610
	1998.10-2003.06	Front Axle Left & Right Lower Inner	Saloon RWD S62B508S1		Control Arm Bushing	510630
	1998.10-2003.06	Rear Axle Left & Right Upper Inner	Saloon RWD S62B508S1		Control Arm Bushing	510619
	1998.10-2003.06	Rear Axle Left & Right Upper Inner	Saloon RWD S62B508S1	Date from:2000.08	Control Arm Bushing	517353
	1998.10-2003.06	Rear Axle Left & Right Upper Outer	Saloon RWD S62B508S1		Control Arm Bushing	517802
	1998.10-2003.06	Rear Axle	Saloon RWD S62B508S1	Date from:2001.12	Suspension Repair Kit	S990051SK
	1998.10-2003.06	Front Axle Left & Right Centre	Saloon RWD S62B508S1		Rod Assembly	S100290
	1998.10-2003.06	Front Axle Left	Saloon RWD S62B508S1		Tie Rod End	S070059
	1998.10-2003.06	Front Axle Right	Saloon RWD S62B508S1		Tie Rod End	S070058
	1998.10-2003.06	Front Axle Left & Right	Saloon RWD S62B508S1		Tie Rod End	S070824
	1998.10-2003.06	Front Axle Left & Right	Saloon RWD S62B508S1		Tie Rod End	S070866
	1998.10-2003.06	Front Axle Left & Right	Saloon RWD S62B508S1		Rod/Strut,stabiliser	S050054
	1998.10-2003.06	Rear Axle Left & Right	Saloon RWD S62B508S1		Rod/Strut,stabiliser	S050057
5.0 (373 kw)	2004.09-2009.12	Front Axle Left Lower Inner	Saloon RWD S85B50A		Track Control Arm	S060078
	2004.09-2009.12	Front Axle Left Lower Outer	Saloon RWD S85B50A		Track Control Arm	S060080
	2004.09-2009.12	Front Axle Right Lower Inner	Saloon RWD S85B50A		Track Control Arm	S060079
	2004.09-2009.12	Front Axle Right Lower Outer	Saloon RWD S85B50A		Track Control Arm	S060081
	2004.09-2009.12	Rear Axle Left Upper Outer	Saloon RWD S85B50A		Track Control Arm	S060058
	2004.09-2009.12	Rear Axle Right Upper Outer	Saloon RWD S85B50A		Track Control Arm	S060057
	2004.09-2009.12	Rear Axle Left & Right Upper Inner	Saloon RWD S85B50A		Track Control Arm	S060082
	2004.09-2009.12	Front Axle Left & Right Lower	Saloon RWD S85B50A		Control Arm Bushing	510608
	2004.09-2009.12	Front Axle Left & Right Lower Inner	Saloon RWD S85B50A		Control Arm Bushing	510610



	 YEAR	FITTING POSITION	BODY STYLE & DRIVE TYPE & ENGINE	REMARKS	PRODUCT	GSP Ref.
BMW M5						
5.0 (373 kw)	2004.09-2009.12	Front Axle Left & Right Lower Inner	Saloon RWD S85B50A		Control Arm Bushing	517838
	2004.09-2009.12	Front Axle Left & Right Lower Outer	Saloon RWD S85B50A		Control Arm Bushing	517804
	2004.09-2009.12	Rear Axle Left & Right Lower	Saloon RWD S85B50A		Control Arm Bushing	516310
	2004.09-2009.12	Rear Axle Left & Right Lower	Saloon RWD S85B50A		Control Arm Bushing	516314
	2004.09-2009.12	Rear Axle Left & Right Upper	Saloon RWD S85B50A		Control Arm Bushing	510616
	2004.09-2009.12	Rear Axle Left & Right Upper Inner	Saloon RWD S85B50A		Control Arm Bushing	510619
	2004.09-2009.12	Rear Axle Left & Right Upper Inner	Saloon RWD S85B50A		Control Arm Bushing	517353
	2004.09-2009.12	Front Axle	Saloon RWD S85B50A		Suspension Repair Kit	S990018SK
	2004.09-2009.12	Front Axle Left & Right	Saloon RWD S85B50A		Rod Assembly	S100329
	2004.09-2009.12	Front Axle Left & Right	Saloon RWD S85B50A		Tie Rod Axle Joint	S030348
	2004.09-2009.12	Front Axle Left & Right	Saloon RWD S85B50A		Tie Rod End	S070551
	2004.09-2009.12	Front Axle Left	Saloon RWD S85B50A		Rod/Strut, stabiliser	S050065
	2004.09-2009.12	Front Axle Right	Saloon RWD S85B50A		Rod/Strut, stabiliser	S050066
	2004.09-2009.12	Rear Axle Left & Right	Saloon RWD S85B50A		Rod/Strut, stabiliser	S050067
	2004.09-2009.12	Front Axle	Saloon RWD S85B50A		Steering Boot	540440
	2004.09-2009.12	Front Axle	Saloon RWD S85B50A	For OE.no.32106785993	Steering Rack Bellow Kit	540417S
M6 Gran Coupe						
4.4 (412 kw)	2013.03-2018.10	Rear Axle Left & Right Lower	Coupe RWD S63B44B		Control Arm Bushing	516314
	2013.03-2018.10	Front Axle Left & Right	Coupe RWD S63B44B		Tie Rod Axle Joint	S030354
	2013.03-2018.10	Front Axle Left	Coupe RWD S63B44B		Tie Rod End	S070999
	2013.03-2018.10	Front Axle Right	Coupe RWD S63B44B		Tie Rod End	S071000
	2013.03-2018.10	Rear Axle Left & Right	Coupe RWD S63B44B		Rod/Strut, stabiliser	S051461
	2013.03-2018.10	Front Axle	Coupe RWD S63B44B		Steering Boot	540440
X1 sDrive 18i						
2.0 (100 kw)	2010.03-2015.06	Front Axle Left Lower Inner	SUV RWD N46B20B		Track Control Arm	S060087
	2010.03-2015.06	Front Axle Left Lower Inner	SUV RWD N46B20B		Track Control Arm	S062657
	2010.03-2015.06	Front Axle Left Lower Outer	SUV RWD N46B20B		Track Control Arm	S060085
	2010.03-2015.06	Front Axle Right Lower Inner	SUV RWD N46B20B		Track Control Arm	S060088
	2010.03-2015.06	Front Axle Right Lower Inner	SUV RWD N46B20B		Track Control Arm	S062658
	2010.03-2015.06	Front Axle Right Lower Outer	SUV RWD N46B20B		Track Control Arm	S060086
	2010.03-2015.06	Rear Axle Left Centre	SUV RWD N46B20B		Track Control Arm	S063116
	2010.03-2015.06	Rear Axle Right Centre	SUV RWD N46B20B		Track Control Arm	S063115
	2010.03-2015.06	Rear Axle Left & Right Centre	SUV RWD N46B20B		Track Control Arm	S060089
	2010.03-2015.06	Front Axle Left & Right Lower Inner	SUV RWD N46B20B		Control Arm Bushing	531936
	2010.03-2015.06	Front Axle	SUV RWD N46B20B		Suspension Repair Kit	S990004SK
	2010.03-2015.06	Front Axle Left	SUV RWD N46B20B		Rod Assembly	S100330
	2010.03-2015.06	Front Axle Left	SUV RWD N46B20B		Rod Assembly	S100332
	2010.03-2015.06	Front Axle Right	SUV RWD N46B20B		Rod Assembly	S100331
	2010.03-2015.06	Front Axle Right	SUV RWD N46B20B		Rod Assembly	S100333
	2010.03-2015.06	Front Axle Left	SUV RWD N46B20B		Tie Rod End	S070045
	2010.03-2015.06	Front Axle Right	SUV RWD N46B20B		Tie Rod End	S070046
	2010.03-2015.06	Front Axle Left	SUV RWD N46B20B		Rod/Strut, stabiliser	S050068
	2010.03-2015.06	Front Axle Right	SUV RWD N46B20B		Rod/Strut, stabiliser	S050069
	2010.03-2015.06	Rear Axle Left	SUV RWD N46B20B		Rod/Strut, stabiliser	S051261
	2010.03-2015.06	Rear Axle Right	SUV RWD N46B20B		Rod/Strut, stabiliser	S051262
	2010.03-2015.06	Rear Axle	SUV RWD N46B20B	Inner Diameter:13mm	Stabiliser Bushing	535302
	2010.03-2015.06	Rear Axle	SUV RWD N46B20B	Inner Diameter:15mm	Stabiliser Bushing	535305
2.0 (110 kw)	2010.03-2015.06	Front Axle Left Lower Inner	SUV RWD N46B20B/N46B20BD		Track Control Arm	S060087
	2010.03-2015.06	Front Axle Left Lower Inner	SUV RWD N46B20B/N46B20BD		Track Control Arm	S062657
	2010.03-2015.06	Front Axle Left Lower Outer	SUV RWD N46B20B/N46B20BD		Track Control Arm	S060085
	2010.03-2015.06	Front Axle Right Lower Inner	SUV RWD N46B20B/N46B20BD		Track Control Arm	S060088
	2010.03-2015.06	Front Axle Right Lower Inner	SUV RWD N46B20B/N46B20BD		Track Control Arm	S062658
	2010.03-2015.06	Front Axle Right Lower Outer	SUV RWD N46B20B/N46B20BD		Track Control Arm	S060086
	2010.03-2015.06	Rear Axle Left Centre	SUV RWD N46B20B/N46B20BD		Track Control Arm	S063116
	2010.03-2015.06	Rear Axle Right Centre	SUV RWD N46B20B/N46B20BD		Track Control Arm	S063115
	2010.03-2015.06	Front Axle Left & Right Lower Inner	SUV RWD N46B20B/N46B20BD		Control Arm Bushing	531936
	2010.03-2015.06	Front Axle	SUV RWD N46B20B/N46B20BD		Suspension Repair Kit	S990004SK
	2010.03-2015.06	Front Axle Left	SUV RWD N46B20B/N46B20BD		Rod Assembly	S100330
	2010.03-2015.06	Front Axle Left	SUV RWD N46B20B/N46B20BD		Rod Assembly	S100332
	2010.03-2015.06	Front Axle Right	SUV RWD N46B20B/N46B20BD		Rod Assembly	S100331
	2010.03-2015.06	Front Axle Right	SUV RWD N46B20B/N46B20BD		Rod Assembly	S100333
	2010.03-2015.06	Front Axle Left & Right	SUV RWD N46B20B/N46B20BD		Tie Rod Axle Joint	S030350
	2010.03-2015.06	Front Axle Left & Right	SUV RWD N46B20B/N46B20BD		Tie Rod Axle Joint	S030847
	2010.03-2015.06	Front Axle Left	SUV RWD N46B20B/N46B20BD		Tie Rod End	S070045



	 YEAR	FITTING POSITION	BODY STYLE & DRIVE TYPE & ENGINE	REMARKS	PRODUCT	GSP Ref.
BMW						
X1 sDrive 18i						
2.0 (110 kw)	2010.03-2015.06	Front Axle Right	SUV RWD N46B20B/N46B20BD		Tie Rod End	S070046
	2010.03-2015.06	Front Axle Left	SUV RWD N46B20B/N46B20BD		Rod/Strut, stabiliser	S050068
	2010.03-2015.06	Front Axle Right	SUV RWD N46B20B/N46B20BD		Rod/Strut, stabiliser	S050069
	2010.03-2015.06	Rear Axle Left	SUV RWD N46B20B/N46B20BD		Rod/Strut, stabiliser	S051261
	2010.03-2015.06	Rear Axle Right	SUV RWD N46B20B/N46B20BD		Rod/Strut, stabiliser	S051262
	2010.03-2015.06	Rear Axle	SUV RWD N46B20B/N46B20BD	Inner Diameter:13mm	Stabiliser Bushing	535302
	2010.03-2015.06	Rear Axle	SUV RWD N46B20B/N46B20BD	Inner Diameter:15mm	Stabiliser Bushing	535305
X1 sDrive 20i						
2.0 (135 kw)	2011.09-2015.06	Front Axle Left Lower Inner	SUV RWD N20B20A		Track Control Arm	S060087
	2011.09-2015.06	Front Axle Left Lower Inner	SUV RWD N20B20A		Track Control Arm	S062657
	2011.09-2015.06	Front Axle Left Lower Outer	SUV RWD N20B20A		Track Control Arm	S060085
	2011.09-2015.06	Front Axle Right Lower Inner	SUV RWD N20B20A		Track Control Arm	S060088
	2011.09-2015.06	Front Axle Right Lower Inner	SUV RWD N20B20A		Track Control Arm	S062658
	2011.09-2015.06	Front Axle Right Lower Outer	SUV RWD N20B20A		Track Control Arm	S060086
	2011.09-2015.06	Rear Axle Left Centre	SUV RWD N20B20A		Track Control Arm	S063116
	2011.09-2015.06	Rear Axle Right Centre	SUV RWD N20B20A		Track Control Arm	S063115
	2011.09-2015.06	Rear Axle Left & Right Centre	SUV RWD N20B20A		Track Control Arm	S060089
	2011.09-2015.06	Front Axle Left & Right Lower Inner	SUV RWD N20B20A		Control Arm Bushing	531936
	2011.09-2015.06	Front Axle	SUV RWD N20B20A		Suspension Repair Kit	S990004SK
	2011.09-2015.06	Front Axle Left	SUV RWD N20B20A		Rod Assembly	S100330
	2011.09-2015.06	Front Axle Right	SUV RWD N20B20A		Rod Assembly	S100331
	2011.09-2015.06	Front Axle Left & Right	SUV RWD N20B20A		Tie Rod Axle Joint	S030350
	2011.09-2015.06	Front Axle Left	SUV RWD N20B20A		Tie Rod End	S070045
	2011.09-2015.06	Front Axle Right	SUV RWD N20B20A		Tie Rod End	S070046
	2011.09-2015.06	Front Axle Left	SUV RWD N20B20A		Rod/Strut, stabiliser	S050068
	2011.09-2015.06	Front Axle Right	SUV RWD N20B20A		Rod/Strut, stabiliser	S050069
	2011.09-2015.06	Rear Axle Left	SUV RWD N20B20A		Rod/Strut, stabiliser	S051261
	2011.09-2015.06	Rear Axle Right	SUV RWD N20B20A		Rod/Strut, stabiliser	S051262
	2011.09-2015.06	Rear Axle	SUV RWD N20B20A	Inner Diameter:13mm	Stabiliser Bushing	535302
	2011.09-2015.06	Rear Axle	SUV RWD N20B20A	Inner Diameter:15mm	Stabiliser Bushing	535305
2.0 (141 kw)	2015.09-	Front Axle Left Lower	SUV FWD B48A20A/B48A20F		Track Control Arm	S062840
	2015.09-	Front Axle Right Lower	SUV FWD B48A20A/B48A20F		Track Control Arm	S062837
	2015.09-	Rear Axle Left & Right Lower	SUV FWD B48A20A/B48A20F		Track Control Arm	S062800
	2015.09-	Rear Axle Left & Right Upper	SUV FWD B48A20A/B48A20F		Track Control Arm	S063055
	2015.09-	Front Axle Left	SUV FWD B48A20A/B48A20F		Rod Assembly	S100410
	2015.09-	Front Axle Right	SUV FWD B48A20A/B48A20F		Rod Assembly	S100409
	2015.09-	Front Axle Left & Right	SUV FWD B48A20A/B48A20F		Tie Rod Axle Joint	S030988
	2015.09-	Front Axle Left & Right	SUV FWD B48A20A/B48A20F		Rod/Strut, stabiliser	S051334
	2015.09-	Rear Axle Left & Right	SUV FWD B48A20A/B48A20F		Rod/Strut, stabiliser	S051243
X1 xDrive 25i						
2.0 (170 kw)	2015.07-	Front Axle Left Lower	SUV 4WD B46A20B/B48A20B		Track Control Arm	S062840
	2015.07-	Front Axle Right Lower	SUV 4WD B46A20B/B48A20B		Track Control Arm	S062837
	2015.07-	Rear Axle Left & Right Lower	SUV 4WD B46A20B/B48A20B		Track Control Arm	S062800
	2015.07-	Rear Axle Left & Right Upper	SUV 4WD B46A20B/B48A20B		Track Control Arm	S063055
	2015.07-	Front Axle Left	SUV 4WD B46A20B/B48A20B		Rod Assembly	S100410
	2015.07-	Front Axle Right	SUV 4WD B46A20B/B48A20B		Rod Assembly	S100409
	2015.07-	Front Axle Left & Right	SUV 4WD B46A20B/B48A20B		Tie Rod Axle Joint	S030988
	2015.07-	Front Axle Left & Right	SUV 4WD B46A20B/B48A20B		Rod/Strut, stabiliser	S051334
	2015.07-	Rear Axle Left & Right	SUV 4WD B46A20B/B48A20B		Rod/Strut, stabiliser	S051243
	2016.03-2018.01	Front Axle Left Lower	Estate AWD B42 S20 A/B48 A20 B		Control Arm Bushing	535630
	2016.03-2018.01	Front Axle Right Lower	Estate AWD B42 S20 A/B48 A20 B		Control Arm Bushing	535628
X1 xDrive 28i						
2.0 (180 kw)	2011.03-2015.06	Front Axle Left Lower Inner	SUV 4WD N20B20A		Track Control Arm	S062311
	2011.03-2015.06	Front Axle Right Lower Inner	SUV 4WD N20B20A		Track Control Arm	S062312
	2011.03-2015.06	Front Axle Left & Right Lower Outer	SUV 4WD N20B20A		Track Control Arm	S061642
	2011.03-2015.06	Rear Axle Left Centre	SUV 4WD N20B20A		Track Control Arm	S063116
	2011.03-2015.06	Rear Axle Right Centre	SUV 4WD N20B20A		Track Control Arm	S063115
	2011.03-2015.06	Rear Axle Left & Right Centre	SUV 4WD N20B20A		Track Control Arm	S060089
	2011.03-2015.06	Front Axle Left & Right Lower Inner	SUV 4WD N20B20A		Control Arm Bushing	531939
	2011.03-2015.06	Front Axle Left	SUV 4WD N20B20A		Rod Assembly	S100345
	2011.03-2015.06	Front Axle Right	SUV 4WD N20B20A		Rod Assembly	S100346
	2011.03-2015.06	Front Axle Left & Right	SUV 4WD N20B20A		Tie Rod Axle Joint	S030655
	2011.03-2015.06	Front Axle Left	SUV 4WD N20B20A		Tie Rod End	S070063
	2011.03-2015.06	Front Axle Right	SUV 4WD N20B20A		Tie Rod End	S070064



	 YEAR	FITTING POSITION	BODY STYLE & DRIVE TYPE & ENGINE	REMARKS	PRODUCT	GSP Ref.	
BMW							
X1 xDrive 28i							
2.0 (180 kw)	2011.03-2015.06	Front Axle Left	SUV 4WD N20B20A		Rod/Strut, stabiliser	S051285	
	2011.03-2015.06	Front Axle Right	SUV 4WD N20B20A		Rod/Strut, stabiliser	S051286	
	2011.03-2015.06	Rear Axle Left	SUV 4WD N20B20A		Rod/Strut, stabiliser	S051261	
	2011.03-2015.06	Rear Axle Right	SUV 4WD N20B20A		Rod/Strut, stabiliser	S051262	
	2011.03-2015.06	Rear Axle	SUV 4WD N20B20A	Inner Diameter:13mm	Stabiliser Bushing	535302	
	2011.03-2015.06	Rear Axle	SUV 4WD N20B20A	Inner Diameter:15mm	Stabiliser Bushing	535305	
	2011.04-2015.06	Rear Axle	SUV 4WD N20B20A	Inner Diameter:13mm	Stabiliser Bushing	535302	
	2011.04-2015.06	Rear Axle	SUV 4WD N20B20A	Inner Diameter:15mm	Stabiliser Bushing	535305	
3.0 (190 kw)	2009.09-2011.08	Front Axle Left Lower Inner	SUV 4WD N52B30A		Track Control Arm	S062311	
	2009.09-2011.08	Front Axle Right Lower Inner	SUV 4WD N52B30A		Track Control Arm	S062312	
	2009.09-2011.08	Front Axle Left & Right Lower Outer	SUV 4WD N52B30A		Track Control Arm	S061642	
	2009.09-2011.08	Rear Axle Left Centre	SUV 4WD N52B30A		Track Control Arm	S063116	
	2009.09-2011.08	Rear Axle Right Centre	SUV 4WD N52B30A		Track Control Arm	S063115	
	2009.09-2011.08	Rear Axle Left & Right Centre	SUV 4WD N52B30A		Track Control Arm	S060089	
	2009.09-2011.08	Front Axle Left & Right Lower Inner	SUV 4WD N52B30A		Control Arm Bushing	531939	
	2009.09-2011.08	Front Axle Left	SUV 4WD N52B30A		Rod Assembly	S100345	
	2009.09-2011.08	Front Axle Right	SUV 4WD N52B30A		Rod Assembly	S100346	
	2009.09-2011.08	Front Axle Left & Right	SUV 4WD N52B30A		Tie Rod Axle Joint	S030655	
	2009.09-2011.08	Front Axle Left	SUV 4WD N52B30A		Tie Rod End	S070063	
	2009.09-2011.08	Front Axle Right	SUV 4WD N52B30A		Tie Rod End	S070064	
	2009.09-2011.08	Front Axle Left	SUV 4WD N52B30A		Rod/Strut, stabiliser	S051285	
	2009.09-2011.08	Front Axle Right	SUV 4WD N52B30A		Rod/Strut, stabiliser	S051286	
	2009.09-2011.08	Rear Axle Left	SUV 4WD N52B30A		Rod/Strut, stabiliser	S051261	
	2009.09-2011.08	Rear Axle Right	SUV 4WD N52B30A		Rod/Strut, stabiliser	S051262	
	2009.09-2011.08	Rear Axle	SUV 4WD N52B30A	Inner Diameter:13mm	Stabiliser Bushing	535302	
	2009.09-2011.08	Rear Axle	SUV 4WD N52B30A	Inner Diameter:15mm	Stabiliser Bushing	535305	
	X2 sDrive 20i						
	2.0 (141 kw)	2017.11-	Front Axle Left Lower	SUV FWD B42S20A/B48A20A		Track Control Arm	S062840
2017.11-		Front Axle Right Lower	SUV FWD B42S20A/B48A20A		Track Control Arm	S062837	
2017.11-		Rear Axle Left & Right Lower	SUV FWD B42S20A/B48A20A		Track Control Arm	S062800	
2017.11-		Rear Axle Left & Right Upper	SUV FWD B42S20A/B48A20A		Track Control Arm	S063055	
2017.11-		Front Axle Left	SUV FWD B42S20A/B48A20A		Rod Assembly	S100410	
2017.11-		Front Axle Right	SUV FWD B42S20A/B48A20A		Rod Assembly	S100409	
2017.11-		Front Axle Left & Right	SUV FWD B42S20A/B48A20A		Tie Rod Axle Joint	S030988	
2017.11-		Front Axle Left & Right	SUV FWD B42S20A/B48A20A		Rod/Strut, stabiliser	S051334	
2017.11-		Rear Axle Left & Right	SUV FWD B42S20A/B48A20A		Rod/Strut, stabiliser	S051243	
X3							
2.5 (141 kw)	2004.03-2006.07	Front Axle Left Lower Inner	SUV 4WD M54B256S5		Track Control Arm	S060092	
	2004.03-2006.07	Front Axle Left Lower Outer	SUV 4WD M54B256S5		Track Control Arm	S060094	
	2004.03-2006.07	Front Axle Right Lower Inner	SUV 4WD M54B256S5		Track Control Arm	S060093	
	2004.03-2006.07	Front Axle Right Lower Outer	SUV 4WD M54B256S5		Track Control Arm	S060095	
	2004.03-2006.07	Rear Axle Left & Right Lower Inner	SUV 4WD M54B256S5		Track Control Arm	S060098	
	2004.03-2006.07	Front Axle Left & Right Lower Outer	SUV 4WD M54B256S5		Ball Joint	S080019	
	2004.03-2006.07	Front Axle Left & Right Lower Outer	SUV 4WD M54B256S5	for OE no.:31 10 3 443 127,31 10 3 443 128	Ball Joint	S080026	
	2004.03-2006.07	Front Axle Left & Right Lower	SUV 4WD M54B256S5		Control Arm Bushing	510608	
	2004.03-2006.07	Front Axle Left & Right Lower Inner	SUV 4WD M54B256S5		Control Arm Bushing	510610	
	2004.03-2006.07	Front Axle Left & Right Lower Outer	SUV 4WD M54B256S5		Control Arm Bushing	510652	
	2004.03-2006.07	Rear Axle Left & Right Upper	SUV 4WD M54B256S5		Control Arm Bushing	512710	
	2004.03-2006.07	Rear Axle Left & Right Lower Inner	SUV 4WD M54B256S5		Control Arm Bushing	512305	
	2004.03-2006.07	Front Axle Left & Right	SUV 4WD M54B256S5		Rod Assembly	S100339	
	2004.03-2006.07	Front Axle Left & Right	SUV 4WD M54B256S5		Tie Rod Axle Joint	S030629	
	2004.03-2006.07	Front Axle Left & Right	SUV 4WD M54B256S5		Tie Rod End	S070061	
	2004.03-2006.07	Front Axle Left	SUV 4WD M54B256S5		Rod/Strut, stabiliser	S050072	
	2004.03-2006.07	Front Axle Right	SUV 4WD M54B256S5		Rod/Strut, stabiliser	S050073	
	2004.03-2006.07	Rear Axle Left & Right	SUV 4WD M54B256S5		Rod/Strut, stabiliser	S050071	
	2004.03-2006.07	Front Axle	SUV 4WD M54B256S5		Stabiliser Bushing	517805	
	2004.03-2006.07	Front Axle	SUV 4WD M54B256S5		Stabiliser Bushing	535306	
	2004.03-2006.07	Rear Axle	SUV 4WD M54B256S5		Stabiliser Bushing	535283	
	2004.03-2006.07	Front Axle	SUV 4WD M54B256S5		Steering Boot	540342	
	2004.03-2006.07	Front Axle	SUV 4WD M54B256S5		Steering Boot	540440	
	2004.03-2006.07	Front Axle	SUV 4WD M54B256S5	without Grease Bag	Steering Rack Bellow Kit	540342S	
	2004.03-2006.07	Front Axle	SUV 4WD M54B256S5	for vehicles with power steering	Steering Rack Bellow Kit	540417S	
	3.0 (170 kw)	2003.09-2006.07	Front Axle Left Lower Inner	SUV 4WD M54B306S3		Track Control Arm	S060092
		2003.09-2006.07	Front Axle Left Lower Outer	SUV 4WD M54B306S3		Track Control Arm	S060094



	 YEAR	FITTING POSITION	BODY STYLE & DRIVE TYPE & ENGINE	REMARKS	PRODUCT	GSP Ref.
BMW X3						
3.0 (170 kw)	2003.09-2006.07	Front Axle Right Lower Inner	SUV 4WD M54B306S3		Track Control Arm	S060093
	2003.09-2006.07	Front Axle Right Lower Outer	SUV 4WD M54B306S3		Track Control Arm	S060095
	2003.09-2006.07	Rear Axle Left & Right Lower Inner	SUV 4WD M54B306S3		Track Control Arm	S060098
	2003.09-2006.07	Front Axle Left & Right Lower Outer	SUV 4WD M54B306S3		Ball Joint	S080019
	2003.09-2006.07	Front Axle Left & Right Lower Outer	SUV 4WD M54B306S3	for OE no.:31 10 3 443 127,31 10 3 443 128	Ball Joint	S080026
	2003.09-2006.07	Front Axle Left & Right Lower	SUV 4WD M54B306S3		Control Arm Bushing	510608
	2003.09-2006.07	Front Axle Left & Right Lower Inner	SUV 4WD M54B306S3		Control Arm Bushing	510610
	2003.09-2006.07	Front Axle Left & Right Lower Outer	SUV 4WD M54B306S3		Control Arm Bushing	510652
	2003.09-2006.07	Rear Axle Left & Right Upper	SUV 4WD M54B306S3		Control Arm Bushing	512710
	2003.09-2006.07	Rear Axle Left & Right Lower Inner	SUV 4WD M54B306S3		Control Arm Bushing	512305
	2003.09-2006.07	Front Axle Left & Right	SUV 4WD M54B306S3		Rod Assembly	S100339
	2003.09-2006.07	Front Axle Left & Right	SUV 4WD M54B306S3		Tie Rod Axle Joint	S030629
	2003.09-2006.07	Front Axle Left & Right	SUV 4WD M54B306S3		Tie Rod End	S070061
	2003.09-2006.07	Front Axle Left	SUV 4WD M54B306S3		Rod/Strut, stabiliser	S050072
	2003.09-2006.07	Front Axle Right	SUV 4WD M54B306S3		Rod/Strut, stabiliser	S050073
	2003.09-2006.07	Rear Axle Left & Right	SUV 4WD M54B306S3		Rod/Strut, stabiliser	S050071
	2003.09-2006.07	Front Axle	SUV 4WD M54B306S3		Stabiliser Bushing	517805
	2003.09-2006.07	Front Axle	SUV 4WD M54B306S3		Stabiliser Bushing	535306
	2003.09-2006.07	Rear Axle	SUV 4WD M54B306S3		Stabiliser Bushing	535283
	2003.09-2006.07	Front Axle	SUV 4WD M54B306S3		Steering Boot	540342
	2003.09-2006.07	Front Axle	SUV 4WD M54B306S3		Steering Boot	540440
	2003.09-2006.07	Front Axle	SUV 4WD M54B306S3	without Grease Bag	Steering Rack Bellow Kit	540342S
	2003.09-2006.07	Front Axle	SUV 4WD M54B306S3	for vehicles with power steering	Steering Rack Bellow Kit	540417S
X3 xDrive 20i						
2.0 (135 kw)	2011.10-2017.08	Front Axle Left Lower Inner	SUV 4WD N20B20A		Track Control Arm	S063129
	2011.10-2017.08	Front Axle Left Lower Outer	SUV 4WD N20B20A		Track Control Arm	S063101
	2011.10-2017.08	Front Axle Right Lower Inner	SUV 4WD N20B20A		Track Control Arm	S063128
	2011.10-2017.08	Front Axle Right Lower Outer	SUV 4WD N20B20A		Track Control Arm	S063100
	2011.10-2017.08	Front Axle Left & Right Lower Outer	SUV 4WD N20B20A		Ball Joint	S081031
	2011.10-2017.08	Front Axle Left & Right Lower Inner	SUV 4WD N20B20A		Control Arm Bushing	532583
	2011.10-2017.08	Front Axle Left & Right Lower Outer	SUV 4WD N20B20A		Control Arm Bushing	532581
	2011.10-2017.08	Front Axle Left & Right	SUV 4WD N20B20A		Tie Rod End	S071665
	2011.10-2017.08	Front Axle Left	SUV 4WD N20B20A		Rod/Strut, stabiliser	S051396
	2011.10-2017.08	Front Axle Right	SUV 4WD N20B20A		Rod/Strut, stabiliser	S051399
X3 xDrive 28i						
2.0 (180 kw)	2012.04-2017.08	Front Axle Left Lower Inner	SUV 4WD N20B20A		Track Control Arm	S063129
	2012.04-2017.08	Front Axle Left Lower Outer	SUV 4WD N20B20A		Track Control Arm	S063101
	2012.04-2017.08	Front Axle Right Lower Inner	SUV 4WD N20B20A		Track Control Arm	S063128
	2012.04-2017.08	Front Axle Right Lower Outer	SUV 4WD N20B20A		Track Control Arm	S063100
	2012.04-2017.08	Front Axle Left & Right Lower Outer	SUV 4WD N20B20A		Ball Joint	S081031
	2012.04-2017.08	Front Axle Left & Right Lower Inner	SUV 4WD N20B20A		Control Arm Bushing	532583
	2012.04-2017.08	Front Axle Left & Right Lower Outer	SUV 4WD N20B20A		Control Arm Bushing	532581
	2012.04-2017.08	Front Axle Left & Right	SUV 4WD N20B20A		Tie Rod End	S071665
	2012.04-2017.08	Front Axle Left	SUV 4WD N20B20A		Rod/Strut, stabiliser	S051396
	2012.04-2017.08	Front Axle Right	SUV 4WD N20B20A		Rod/Strut, stabiliser	S051399
3.0 (190 kw)	2011.01-2012.10	Front Axle Left Lower Inner	SUV 4WD N52B30A/N52B30AF/N52B30BF		Track Control Arm	S063129
	2011.01-2012.10	Front Axle Left Lower Outer	SUV 4WD N52B30A/N52B30AF/N52B30BF		Track Control Arm	S063101
	2011.01-2012.10	Front Axle Right Lower Inner	SUV 4WD N52B30A/N52B30AF/N52B30BF		Track Control Arm	S063128
	2011.01-2012.10	Front Axle Right Lower Outer	SUV 4WD N52B30A/N52B30AF/N52B30BF		Track Control Arm	S063100
	2011.01-2012.10	Front Axle Left & Right Lower Outer	SUV 4WD N52B30A/N52B30AF/N52B30BF		Ball Joint	S081031
	2011.01-2012.10	Front Axle Left & Right Lower Inner	SUV 4WD N52B30A/N52B30AF/N52B30BF		Control Arm Bushing	532583
	2011.01-2012.10	Front Axle Left & Right Lower Outer	SUV 4WD N52B30A/N52B30AF/N52B30BF		Control Arm Bushing	532581
	2011.01-2012.10	Front Axle Left & Right	SUV 4WD N52B30A/N52B30AF/N52B30BF		Tie Rod End	S071665
	2011.01-2012.10	Front Axle Left	SUV 4WD N52B30A/N52B30AF/N52B30BF		Rod/Strut, stabiliser	S051396
	2011.01-2012.10	Front Axle Right	SUV 4WD N52B30A/N52B30AF/N52B30BF		Rod/Strut, stabiliser	S051399
X3 xDrive 30i						
2.0 (185 kw)	2017.08-	Front Axle Left Lower Inner	SUV 4WD B48B20B		Track Control Arm	S063248
	2017.08-	Front Axle Left Lower Outer	SUV 4WD B48B20B		Track Control Arm	S063252
	2017.08-	Front Axle Right Lower Inner	SUV 4WD B48B20B		Track Control Arm	S063246
	2017.08-	Front Axle Right Lower Outer	SUV 4WD B48B20B		Track Control Arm	S063251
3.0 (200 kw)	2008.09-2010.08	Front Axle Left Lower Inner	SUV 4WD N52B30A/N52B30BF		Track Control Arm	S060092
	2008.09-2010.08	Front Axle Left Lower Outer	SUV 4WD N52B30A/N52B30BF		Track Control Arm	S060094
	2008.09-2010.08	Front Axle Right Lower Inner	SUV 4WD N52B30A/N52B30BF		Track Control Arm	S060093
	2008.09-2010.08	Front Axle Right Lower Outer	SUV 4WD N52B30A/N52B30BF		Track Control Arm	S060095



	 YEAR	FITTING POSITION	BODY STYLE & DRIVE TYPE & ENGINE	REMARKS	PRODUCT	GSP Ref.
BMW						
X3 xDrive 30i						
3.0 (200 kw)	2008.09-2010.08	Rear Axle Left & Right Lower Inner	SUV 4WD N52B30A/N52B30BF		Track Control Arm	S060098
	2008.09-2010.08	Front Axle Left & Right Lower Outer	SUV 4WD N52B30A/N52B30BF		Ball Joint	S080026
	2008.09-2010.08	Front Axle Left & Right Lower	SUV 4WD N52B30A/N52B30BF		Control Arm Bushing	510608
	2008.09-2010.08	Front Axle Left & Right Lower Inner	SUV 4WD N52B30A/N52B30BF		Control Arm Bushing	510610
	2008.09-2010.08	Front Axle Left & Right Lower Outer	SUV 4WD N52B30A/N52B30BF		Control Arm Bushing	510652
	2008.09-2010.08	Rear Axle Left & Right Upper	SUV 4WD N52B30A/N52B30BF		Control Arm Bushing	512710
	2008.09-2010.08	Rear Axle Left & Right Lower Inner	SUV 4WD N52B30A/N52B30BF		Control Arm Bushing	512305
	2008.09-2010.08	Front Axle Left & Right	SUV 4WD N52B30A/N52B30BF		Tie Rod Axle Joint	S030629
	2008.09-2010.08	Front Axle Left & Right	SUV 4WD N52B30A/N52B30BF		Tie Rod End	S070061
	2008.09-2010.08	Front Axle Left	SUV 4WD N52B30A/N52B30BF		Rod/Strut, stabiliser	S050072
	2008.09-2010.08	Front Axle Right	SUV 4WD N52B30A/N52B30BF		Rod/Strut, stabiliser	S050073
	2008.09-2010.08	Rear Axle Left & Right	SUV 4WD N52B30A/N52B30BF		Rod/Strut, stabiliser	S050071
	2008.09-2010.08	Front Axle	SUV 4WD N52B30A/N52B30BF		Stabiliser Bushing	517805
	2008.09-2010.08	Front Axle	SUV 4WD N52B30A/N52B30BF		Stabiliser Bushing	535306
	2008.09-2010.08	Rear Axle	SUV 4WD N52B30A/N52B30BF		Stabiliser Bushing	535283
	2008.09-2010.08	Front Axle	SUV 4WD N52B30A/N52B30BF		Steering Boot	540342
	2008.09-2010.08	Front Axle	SUV 4WD N52B30A/N52B30BF		Steering Boot	540440
	2008.09-2010.08	Front Axle	SUV 4WD N52B30A/N52B30BF		Steering Rack Bellow Kit	540417S
X3 xDrive 35i						
3.0 (225 kw)	2010.09-2017.08	Front Axle Left Lower Inner	SUV 4WD N55B30A		Track Control Arm	S063129
	2010.09-2017.08	Front Axle Left Lower Outer	SUV 4WD N55B30A		Track Control Arm	S063101
	2010.09-2017.08	Front Axle Right Lower Inner	SUV 4WD N55B30A		Track Control Arm	S063128
	2010.09-2017.08	Front Axle Right Lower Outer	SUV 4WD N55B30A		Track Control Arm	S063100
	2010.09-2017.08	Front Axle Left & Right Lower Outer	SUV 4WD N55B30A		Ball Joint	S081031
	2010.09-2017.08	Front Axle Left & Right Lower Inner	SUV 4WD N55B30A		Control Arm Bushing	532583
	2010.09-2017.08	Front Axle Left & Right Lower Outer	SUV 4WD N55B30A		Control Arm Bushing	532581
	2010.09-2017.08	Front Axle Left & Right	SUV 4WD N55B30A		Tie Rod End	S071665
	2010.09-2017.08	Front Axle Left	SUV 4WD N55B30A		Rod/Strut, stabiliser	S051396
	2010.09-2017.08	Front Axle Right	SUV 4WD N55B30A		Rod/Strut, stabiliser	S051399
X3 xDrive M40i						
3.0 (265 kw)	2017.08-	Front Axle Left Lower Inner	SUV 4WD B58B30A		Track Control Arm	S063248
	2017.08-	Front Axle Left Lower Outer	SUV 4WD B58B30A		Track Control Arm	S063252
	2017.08-	Front Axle Right Lower Inner	SUV 4WD B58B30A		Track Control Arm	S063246
	2017.08-	Front Axle Right Lower Outer	SUV 4WD B58B30A		Track Control Arm	S063251
3.0 (285 kw)	2019.09-	Front Axle Left Lower Inner	SUV 4WD B58B30B		Track Control Arm	S063248
	2019.09-	Front Axle Left Lower Outer	SUV 4WD B58B30B		Track Control Arm	S063252
	2019.09-	Front Axle Right Lower Inner	SUV 4WD B58B30B		Track Control Arm	S063246
	2019.09-	Front Axle Right Lower Outer	SUV 4WD B58B30B		Track Control Arm	S063251
X4 xDrive 28i						
2.0 (180 kw)	2014.04-2018.03	Front Axle Left Lower Inner	SUV 4WD N20B20A		Track Control Arm	S063129
	2014.04-2018.03	Front Axle Left Lower Outer	SUV 4WD N20B20A		Track Control Arm	S063101
	2014.04-2018.03	Front Axle Right Lower Inner	SUV 4WD N20B20A		Track Control Arm	S063128
	2014.04-2018.03	Front Axle Right Lower Outer	SUV 4WD N20B20A		Track Control Arm	S063100
	2014.04-2018.03	Front Axle Left & Right Lower Outer	SUV 4WD N20B20A		Ball Joint	S081031
	2014.04-2018.03	Front Axle Left & Right Lower Inner	SUV 4WD N20B20A		Control Arm Bushing	532583
	2014.04-2018.03	Front Axle Left & Right Lower Outer	SUV 4WD N20B20A		Control Arm Bushing	532581
	2014.04-2018.03	Front Axle Left & Right	SUV 4WD N20B20A		Tie Rod End	S071665
	2014.04-2018.03	Front Axle Left	SUV 4WD N20B20A		Rod/Strut, stabiliser	S051396
	2014.04-2018.03	Front Axle Right	SUV 4WD N20B20A		Rod/Strut, stabiliser	S051399
X4 xDrive 30i						
2.0 (185 kw)	2018.04-	Front Axle Left Lower Inner	SUV 4WD B48B20B		Track Control Arm	S063248
	2018.04-	Front Axle Left Lower Outer	SUV 4WD B48B20B		Track Control Arm	S063252
	2018.04-	Front Axle Right Lower Inner	SUV 4WD B48B20B		Track Control Arm	S063246
	2018.04-	Front Axle Right Lower Outer	SUV 4WD B48B20B		Track Control Arm	S063251
X4 xDrive 35i						
3.0 (224 kw)	2015.01-2018.03	Rear Axle	SUV AWD N55 B30 A		Stabiliser Bushing	535629
3.0 (225 kw)	2014.04-2018.03	Front Axle Left Lower Inner	SUV 4WD N55B30A		Track Control Arm	S063129
	2014.04-2018.03	Front Axle Left Lower Outer	SUV 4WD N55B30A		Track Control Arm	S063101
	2014.04-2018.03	Front Axle Right Lower Inner	SUV 4WD N55B30A		Track Control Arm	S063128
	2014.04-2018.03	Front Axle Right Lower Outer	SUV 4WD N55B30A		Track Control Arm	S063100
	2014.04-2018.03	Front Axle Left & Right Lower Outer	SUV 4WD N55B30A		Ball Joint	S081031
	2014.04-2018.03	Front Axle Left & Right Lower Inner	SUV 4WD N55B30A		Control Arm Bushing	532583
	2014.04-2018.03	Front Axle Left & Right Lower Outer	SUV 4WD N55B30A		Control Arm Bushing	532581
	2014.04-2018.03	Front Axle Left & Right	SUV 4WD N55B30A		Tie Rod End	S071665



	 YEAR	FITTING POSITION	BODY STYLE & DRIVE TYPE & ENGINE	REMARKS	PRODUCT	GSP Ref.
BMW						
X4 xDrive 35i						
3.0 (225 kw)	2014.04-2018.03	Front Axle Left	SUV 4WD N55B30A		Rod/Strut,stabiliser	S051396
	2014.04-2018.03	Front Axle Right	SUV 4WD N55B30A		Rod/Strut,stabiliser	S051399
X4 xDrive M40i						
3.0 (265 kw)	2018.04-	Front Axle Left Lower Inner	SUV 4WD B58B30A		Track Control Arm	S063248
	2018.04-	Front Axle Left Lower Outer	SUV 4WD B58B30A		Track Control Arm	S063252
	2018.04-	Front Axle Right Lower Inner	SUV 4WD B58B30A		Track Control Arm	S063246
	2018.04-	Front Axle Right Lower Outer	SUV 4WD B58B30A		Track Control Arm	S063251
X5						
3.0 (170 kw)	2000.04-2006.10	Front Axle Left Lower Inner	SUV 4WD M54B306S3		Track Control Arm	S060063
	2000.04-2006.10	Front Axle Left Lower Outer	SUV 4WD M54B306S3		Track Control Arm	S060065
	2000.04-2006.10	Front Axle Right Lower Inner	SUV 4WD M54B306S3		Track Control Arm	S060062
	2000.04-2006.10	Front Axle Right Lower Outer	SUV 4WD M54B306S3		Track Control Arm	S060064
	2000.04-2006.10	Rear Axle Left Upper Outer	SUV 4WD M54B306S3		Track Control Arm	S060075
	2000.04-2006.10	Rear Axle Right Upper Outer	SUV 4WD M54B306S3		Track Control Arm	S060076
	2000.04-2006.10	Rear Axle Left & Right Lower	SUV 4WD M54B306S3		Track Control Arm	S060068
	2000.04-2006.10	Rear Axle Left & Right Upper Inner	SUV 4WD M54B306S3		Track Control Arm	S060074
	2000.04-2006.10	Front Axle Left & Right Lower Outer	SUV 4WD M54B306S3		Ball Joint	S080018
	2000.04-2006.10	Rear Axle Left & Right Upper Outer	SUV 4WD M54B306S3		Ball Joint	S080996
	2000.04-2006.10	Front Axle Left & Right Lower Inner	SUV 4WD M54B306S3		Control Arm Bushing	510608
	2000.04-2006.10	Front Axle Left & Right Lower Inner	SUV 4WD M54B306S3		Control Arm Bushing	510610
	2000.04-2006.10	Front Axle Left & Right Lower Outer	SUV 4WD M54B306S3		Control Arm Bushing	510652
	2000.04-2006.10	Rear Axle Left & Right Lower	SUV 4WD M54B306S3	Date to:2006.09	Control Arm Bushing	516310
	2000.04-2006.10	Rear Axle Left & Right Lower	SUV 4WD M54B306S3		Control Arm Bushing	516310
	2000.04-2006.10	Rear Axle Left & Right Lower	SUV 4WD M54B306S3		Control Arm Bushing	516314
	2000.04-2006.10	Rear Axle Left & Right Upper Inner	SUV 4WD M54B306S3		Control Arm Bushing	517352
	2000.04-2006.10	Rear Axle Left & Right Upper Outer	SUV 4WD M54B306S3		Control Arm Bushing	517802
	2000.04-2006.10	Front Axle	SUV 4WD M54B306S3		Suspension Repair Kit	S990003SK
	2000.04-2006.10	Front Axle	SUV 4WD M54B306S3	Date to:2003.10	Suspension Repair Kit	S990036SK
	2000.04-2006.10	Rear Axle	SUV 4WD M54B306S3		Suspension Repair Kit	S990054SK
	2000.04-2006.10	Front Axle Left & Right	SUV 4WD M54B306S3		Rod Assembly	S100335
	2000.04-2006.10	Front Axle Left & Right	SUV 4WD M54B306S3		Tie Rod Axle Joint	S030629
	2000.04-2006.10	Front Axle Left & Right	SUV 4WD M54B306S3		Tie Rod End	S070060
	2000.04-2006.10	Front Axle Left	SUV 4WD M54B306S3		Rod/Strut,stabiliser	S050060
	2000.04-2006.10	Front Axle Right	SUV 4WD M54B306S3		Rod/Strut,stabiliser	S050061
	2000.04-2006.10	Rear Axle Left & Right	SUV 4WD M54B306S3		Rod/Strut,stabiliser	S050062
	2000.04-2006.10	Front Axle	SUV 4WD M54B306S3		Stabiliser Bushing	510654
	2000.04-2006.10	Rear Axle	SUV 4WD M54B306S3		Stabiliser Bushing	512300
	2000.04-2006.10	Front Axle	SUV 4WD M54B306S3		Steering Boot	540342
	2000.04-2006.10	Front Axle	SUV 4WD M54B306S3	without Grease Bag	Steering Rack Bellow Kit	540342S
4.4 (210 kw)	2000.01-2003.09	Front Axle Left Lower Inner	SUV 4WD M62B448S2		Track Control Arm	S060063
	2000.01-2003.09	Front Axle Left Lower Outer	SUV 4WD M62B448S2		Track Control Arm	S060065
	2000.01-2003.09	Front Axle Right Lower Inner	SUV 4WD M62B448S2		Track Control Arm	S060062
	2000.01-2003.09	Front Axle Right Lower Outer	SUV 4WD M62B448S2		Track Control Arm	S060064
	2000.01-2003.09	Rear Axle Left Upper Outer	SUV 4WD M62B448S2		Track Control Arm	S060075
	2000.01-2003.09	Rear Axle Right Upper Outer	SUV 4WD M62B448S2		Track Control Arm	S060076
	2000.01-2003.09	Rear Axle Left & Right Lower	SUV 4WD M62B448S2		Track Control Arm	S060068
	2000.01-2003.09	Rear Axle Left & Right Upper Inner	SUV 4WD M62B448S2		Track Control Arm	S060074
	2000.01-2003.09	Front Axle Left & Right Lower Outer	SUV 4WD M62B448S2		Ball Joint	S080018
	2000.01-2003.09	Front Axle Left & Right Lower Inner	SUV 4WD M62B448S2		Control Arm Bushing	510608
	2000.01-2003.09	Front Axle Left & Right Lower Inner	SUV 4WD M62B448S2		Control Arm Bushing	510610
	2000.01-2003.09	Front Axle Left & Right Lower Outer	SUV 4WD M62B448S2		Control Arm Bushing	510652
	2000.01-2003.09	Rear Axle Left & Right Lower	SUV 4WD M62B448S2		Control Arm Bushing	516310
	2000.01-2003.09	Rear Axle Left & Right Lower	SUV 4WD M62B448S2		Control Arm Bushing	516314
	2000.01-2003.09	Rear Axle Left & Right Upper Inner	SUV 4WD M62B448S2		Control Arm Bushing	517352
	2000.01-2003.09	Rear Axle Left & Right Upper Outer	SUV 4WD M62B448S2		Control Arm Bushing	517802
	2000.01-2003.09	Front Axle	SUV 4WD M62B448S2		Suspension Repair Kit	S990003SK
	2000.01-2003.09	Front Axle Left & Right	SUV 4WD M62B448S2		Rod Assembly	S100335
	2000.01-2003.09	Front Axle Left & Right	SUV 4WD M62B448S2		Tie Rod Axle Joint	S030629
	2000.01-2003.09	Front Axle Left & Right	SUV 4WD M62B448S2		Tie Rod End	S070060
	2000.01-2003.09	Front Axle Left	SUV 4WD M62B448S2		Rod/Strut,stabiliser	S050060
	2000.01-2003.09	Front Axle Right	SUV 4WD M62B448S2		Rod/Strut,stabiliser	S050061
	2000.01-2003.09	Rear Axle Left & Right	SUV 4WD M62B448S2		Rod/Strut,stabiliser	S050062
	2000.01-2003.09	Front Axle	SUV 4WD M62B448S2		Stabiliser Bushing	510654
	2000.01-2003.09	Rear Axle	SUV 4WD M62B448S2		Stabiliser Bushing	512300

	 YEAR	FITTING POSITION	BODY STYLE & DRIVE TYPE & ENGINE	REMARKS	PRODUCT	GSP Ref.
BMW X5						
4.4 (210 kw)	2000.01-2003.09	Front Axle	SUV 4WD M62B448S2		Steering Boot	540342
	2000.01-2003.09	Front Axle	SUV 4WD M62B448S2	without Grease Bag	Steering Rack Bellow Kit	540342S
4.4 (235 kw)	2003.10-2006.10	Front Axle Left Lower Inner	SUV 4WD N62B44A		Track Control Arm	S060063
	2003.10-2006.10	Front Axle Left Lower Outer	SUV 4WD N62B44A		Track Control Arm	S060065
	2003.10-2006.10	Front Axle Right Lower Inner	SUV 4WD N62B44A		Track Control Arm	S060062
	2003.10-2006.10	Front Axle Right Lower Outer	SUV 4WD N62B44A		Track Control Arm	S060064
	2003.10-2006.10	Rear Axle Left Upper Outer	SUV 4WD N62B44A		Track Control Arm	S060075
	2003.10-2006.10	Rear Axle Right Upper Outer	SUV 4WD N62B44A		Track Control Arm	S060076
	2003.10-2006.10	Rear Axle Left & Right Lower	SUV 4WD N62B44A		Track Control Arm	S060068
	2003.10-2006.10	Rear Axle Left & Right Upper Inner	SUV 4WD N62B44A		Track Control Arm	S060074
	2003.10-2006.10	Front Axle Left & Right Lower Outer	SUV 4WD N62B44A		Ball Joint	S080018
	2003.10-2006.10	Rear Axle Left & Right Upper Outer	SUV 4WD N62B44A		Ball Joint	S080996
	2003.10-2006.10	Front Axle Left & Right Lower Inner	SUV 4WD N62B44A		Control Arm Bushing	510608
	2003.10-2006.10	Front Axle Left & Right Lower Inner	SUV 4WD N62B44A		Control Arm Bushing	510610
	2003.10-2006.10	Front Axle Left & Right Lower Outer	SUV 4WD N62B44A		Control Arm Bushing	510652
	2003.10-2006.10	Rear Axle Left & Right Lower	SUV 4WD N62B44A	Date to:2006.09	Control Arm Bushing	516310
	2003.10-2006.10	Rear Axle Left & Right Lower	SUV 4WD N62B44A		Control Arm Bushing	516310
	2003.10-2006.10	Rear Axle Left & Right Lower	SUV 4WD N62B44A		Control Arm Bushing	516314
	2003.10-2006.10	Rear Axle Left & Right Upper Inner	SUV 4WD N62B44A		Control Arm Bushing	517352
	2003.10-2006.10	Rear Axle Left & Right Upper Outer	SUV 4WD N62B44A		Control Arm Bushing	517802
	2003.10-2006.10	Front Axle	SUV 4WD N62B44A		Suspension Repair Kit	S990003SK
	2003.10-2006.10	Rear Axle	SUV 4WD N62B44A		Suspension Repair Kit	S990054SK
	2003.10-2006.10	Front Axle Left & Right	SUV 4WD N62B44A		Rod Assembly	S100335
	2003.10-2006.10	Front Axle Left & Right	SUV 4WD N62B44A		Tie Rod Axle Joint	S030629
	2003.10-2006.10	Front Axle Left & Right	SUV 4WD N62B44A		Tie Rod End	S070060
	2003.10-2006.10	Front Axle Left	SUV 4WD N62B44A		Rod/Strut, stabiliser	S050060
	2003.10-2006.10	Front Axle Right	SUV 4WD N62B44A		Rod/Strut, stabiliser	S050061
	2003.10-2006.10	Rear Axle Left & Right	SUV 4WD N62B44A		Rod/Strut, stabiliser	S050062
	2003.10-2006.10	Front Axle	SUV 4WD N62B44A		Stabiliser Bushing	510654
	2003.10-2006.10	Rear Axle	SUV 4WD N62B44A		Stabiliser Bushing	512300
	2003.10-2006.10	Front Axle	SUV 4WD N62B44A		Steering Boot	540342
	2003.10-2006.10	Front Axle	SUV 4WD N62B44A	without Grease Bag	Steering Rack Bellow Kit	540342S
4.8 (261 kw)	2006.10-2008.09	Front Axle Left Upper	SUV 4WD N62B48B		Track Control Arm	S061155
	2006.10-2008.09	Front Axle Left Lower Inner	SUV 4WD N62B48B		Track Control Arm	S060122
	2006.10-2008.09	Front Axle Left Lower Outer	SUV 4WD N62B48B		Track Control Arm	S060124
	2006.10-2008.09	Front Axle Right Upper	SUV 4WD N62B48B		Track Control Arm	S061156
	2006.10-2008.09	Front Axle Right Lower Inner	SUV 4WD N62B48B		Track Control Arm	S060123
	2006.10-2008.09	Front Axle Right Lower Outer	SUV 4WD N62B48B		Track Control Arm	S060125
	2006.10-2008.09	Rear Axle Left Upper Outer	SUV 4WD N62B48B		Track Control Arm	S063051
	2006.10-2008.09	Rear Axle Right Upper Outer	SUV 4WD N62B48B		Track Control Arm	S063052
	2006.10-2008.09	Front Axle Left & Right Upper	SUV 4WD N62B48B		Control Arm Bushing	533523
	2006.10-2008.09	Front Axle Left & Right Lower Inner	SUV 4WD N62B48B		Control Arm Bushing	531927
	2006.10-2008.09	Front Axle Left & Right Lower Inner	SUV 4WD N62B48B		Control Arm Bushing	531928
	2006.10-2008.09	Front Axle Left & Right Lower Outer	SUV 4WD N62B48B		Control Arm Bushing	530158
	2006.10-2008.09	Front Axle	SUV 4WD N62B48B		Suspension Repair Kit	S990020SK
	2006.10-2008.09	Front Axle Left & Right	SUV 4WD N62B48B		Tie Rod Axle Joint	S030629
	2006.10-2008.09	Front Axle Left & Right	SUV 4WD N62B48B		Tie Rod End	S070061
	2006.10-2008.09	Front Axle Left	SUV 4WD N62B48B	for vehicles with electronic suspension control	Rod/Strut, stabiliser	S050083
	2006.10-2008.09	Front Axle Left	SUV 4WD N62B48B	for vehicles with electronic suspension control	Rod/Strut, stabiliser	S050085
	2006.10-2008.09	Front Axle Right	SUV 4WD N62B48B	for vehicles with electronic suspension control	Rod/Strut, stabiliser	S050084
	2006.10-2008.09	Front Axle Right	SUV 4WD N62B48B	for vehicles without electronic suspension control	Rod/Strut, stabiliser	S050086
	2006.10-2008.09	Rear Axle Left & Right	SUV 4WD N62B48B		Rod/Strut, stabiliser	S050082
X5 M						
4.4 (423 kw)	2014.12-2018.07	Rear Axle Left Upper Outer	SUV 4WD S63B44B		Track Control Arm	S063051
	2014.12-2018.07	Rear Axle Right Upper Outer	SUV 4WD S63B44B		Track Control Arm	S063052
	2014.12-2018.07	Front Axle Left & Right Lower Inner	SUV 4WD S63B44B		Control Arm Bushing	531927
	2014.12-2018.07	Front Axle Left & Right Lower Outer	SUV 4WD S63B44B		Control Arm Bushing	533902
	2014.12-2018.07	Front Axle Left	SUV 4WD S63B44B		Rod/Strut, stabiliser	S050083
	2014.12-2018.07	Front Axle Right	SUV 4WD S63B44B		Rod/Strut, stabiliser	S050084
	2014.12-2018.07	Rear Axle Left & Right	SUV 4WD S63B44B		Rod/Strut, stabiliser	S050082
X5 xDrive 30d						
3.0 (190 kw)	2013.08-2018.07	Front Axle Left Upper	SUV 4WD N57D30A		Track Control Arm	S061155
	2013.08-2018.07	Front Axle Right Upper	SUV 4WD N57D30A		Track Control Arm	S061156
	2013.08-2018.07	Rear Axle Left Upper Outer	SUV 4WD N57D30A		Track Control Arm	S063051



	 YEAR	FITTING POSITION	BODY STYLE & DRIVE TYPE & ENGINE	REMARKS	PRODUCT	GSP Ref.
BMW						
X5 xDrive 30d						
3.0 (190 kw)	2013.08-2018.07	Rear Axle Right Upper Outer	SUV 4WD N57D30A		Track Control Arm	S063052
	2013.08-2018.07	Front Axle Left & Right Upper	SUV 4WD N57D30A		Control Arm Bushing	533523
	2013.08-2018.07	Front Axle Left & Right Lower Inner	SUV 4WD N57D30A		Control Arm Bushing	531927
	2013.08-2018.07	Front Axle Left & Right Lower Inner	SUV 4WD N57D30A		Control Arm Bushing	533511
	2013.08-2018.07	Front Axle Left & Right Lower Outer	SUV 4WD N57D30A		Control Arm Bushing	530158
	2013.08-2018.07	Front Axle Left & Right Lower Outer	SUV 4WD N57D30A		Control Arm Bushing	533902
	2013.08-2018.07	Front Axle Left	SUV 4WD N57D30A	for vehicles with electronic drive dynamics for vehicles with adaptive drive	Rod/Strut, stabiliser	S050083
	2013.08-2018.07	Front Axle Left	SUV 4WD N57D30A	for vehicles without active stabiliser control	Rod/Strut, stabiliser	S050085
	2013.08-2018.07	Front Axle Right	SUV 4WD N57D30A	for vehicles with adaptive drive	Rod/Strut, stabiliser	S050084
	2013.08-2018.07	Front Axle Right	SUV 4WD N57D30A	for vehicles without active stabiliser control	Rod/Strut, stabiliser	S050086
	2013.08-2018.07	Rear Axle Left & Right	SUV 4WD N57D30A		Rod/Strut, stabiliser	S050082
X5 xDrive 30i						
3.0 (200 kw)	2008.10-2010.03	Front Axle Left Upper	SUV 4WD N52B30A		Track Control Arm	S061155
	2008.10-2010.03	Front Axle Left Lower Outer	SUV 4WD N52B30A		Track Control Arm	S060124
	2008.10-2010.03	Front Axle Right Upper	SUV 4WD N52B30A		Track Control Arm	S061156
	2008.10-2010.03	Front Axle Right Lower Outer	SUV 4WD N52B30A		Track Control Arm	S060125
	2008.10-2010.03	Rear Axle Left Upper Outer	SUV 4WD N52B30A		Track Control Arm	S063051
	2008.10-2010.03	Rear Axle Right Upper Outer	SUV 4WD N52B30A		Track Control Arm	S063052
	2008.10-2010.03	Front Axle Left & Right Upper	SUV 4WD N52B30A		Control Arm Bushing	533523
	2008.10-2010.03	Front Axle Left & Right Lower Inner	SUV 4WD N52B30A		Control Arm Bushing	531927
	2008.10-2010.03	Front Axle Left & Right Lower Inner	SUV 4WD N52B30A		Control Arm Bushing	531928
	2008.10-2010.03	Front Axle Left & Right Lower Outer	SUV 4WD N52B30A		Control Arm Bushing	530158
	2008.10-2010.03	Front Axle	SUV 4WD N52B30A		Suspension Repair Kit	S990020SK
	2008.10-2010.03	Front Axle Left & Right	SUV 4WD N52B30A		Tie Rod End	S070061
	2008.10-2010.03	Front Axle Left	SUV 4WD N52B30A	for vehicles with adaptive drive	Rod/Strut, stabiliser	S050083
	2008.10-2010.03	Front Axle Left	SUV 4WD N52B30A		Rod/Strut, stabiliser	S050085
	2008.10-2010.03	Front Axle Right	SUV 4WD N52B30A	for vehicles with adaptive drive	Rod/Strut, stabiliser	S050084
	2008.10-2010.03	Front Axle Right	SUV 4WD N52B30A		Rod/Strut, stabiliser	S050086
	2008.10-2010.03	Rear Axle Left & Right	SUV 4WD N52B30A		Rod/Strut, stabiliser	S050082
X5 xDrive 35i						
3.0 (225 kw)	2010.04-2013.07	Front Axle Left Upper	SUV 4WD N55B30A		Track Control Arm	S061155
	2010.04-2013.07	Front Axle Left Lower Inner	SUV 4WD N55B30A		Track Control Arm	S060122
	2010.04-2013.07	Front Axle Left Lower Outer	SUV 4WD N55B30A		Track Control Arm	S060124
	2010.04-2013.07	Front Axle Right Upper	SUV 4WD N55B30A		Track Control Arm	S061156
	2010.04-2013.07	Front Axle Right Lower Inner	SUV 4WD N55B30A		Track Control Arm	S060123
	2010.04-2013.07	Front Axle Right Lower Outer	SUV 4WD N55B30A		Track Control Arm	S060125
	2010.04-2013.07	Rear Axle Left Upper Outer	SUV 4WD N55B30A		Track Control Arm	S063051
	2010.04-2013.07	Rear Axle Right Upper Outer	SUV 4WD N55B30A		Track Control Arm	S063052
	2010.04-2013.07	Front Axle Left & Right Upper	SUV 4WD N55B30A		Control Arm Bushing	533523
	2010.04-2013.07	Front Axle Left & Right Lower Inner	SUV 4WD N55B30A		Control Arm Bushing	531927
	2010.04-2013.07	Front Axle Left & Right Lower Inner	SUV 4WD N55B30A		Control Arm Bushing	531928
	2010.04-2013.07	Front Axle Left & Right Lower Outer	SUV 4WD N55B30A		Control Arm Bushing	530158
	2010.04-2013.07	Front Axle	SUV 4WD N55B30A		Suspension Repair Kit	S990020SK
	2010.04-2013.07	Front Axle Left & Right	SUV 4WD N55B30A		Tie Rod Axle Joint	S030629
	2010.04-2013.07	Front Axle Left & Right	SUV 4WD N55B30A		Tie Rod End	S070061
	2010.04-2013.07	Front Axle Left & Right	SUV 4WD N55B30A		Tie Rod End	S070824
	2010.04-2013.07	Front Axle Left	SUV 4WD N55B30A	for vehicles with electronic suspension control	Rod/Strut, stabiliser	S050083
	2010.04-2013.07	Front Axle Left	SUV 4WD N55B30A	for vehicles without electronic suspension control	Rod/Strut, stabiliser	S050085
	2010.04-2013.07	Front Axle Right	SUV 4WD N55B30A	for vehicles with electronic suspension control	Rod/Strut, stabiliser	S050084
	2010.04-2013.07	Front Axle Right	SUV 4WD N55B30A	for vehicles without electronic suspension control	Rod/Strut, stabiliser	S050086
	2010.04-2013.07	Rear Axle Left & Right	SUV 4WD N55B30A		Rod/Strut, stabiliser	S050082
	2013.12-2018.07	Front Axle Left Upper	SUV 4WD N55B30A		Track Control Arm	S061155
	2013.12-2018.07	Front Axle Right Upper	SUV 4WD N55B30A		Track Control Arm	S061156
	2013.12-2018.07	Rear Axle Left Upper Outer	SUV 4WD N55B30A		Track Control Arm	S063051
	2013.12-2018.07	Rear Axle Right Upper Outer	SUV 4WD N55B30A		Track Control Arm	S063052
	2013.12-2018.07	Front Axle Left & Right Upper	SUV 4WD N55B30A		Control Arm Bushing	533523
	2013.12-2018.07	Front Axle Left & Right Lower Inner	SUV 4WD N55B30A		Control Arm Bushing	531927
	2013.12-2018.07	Front Axle Left & Right Lower Inner	SUV 4WD N55B30A		Control Arm Bushing	533511
	2013.12-2018.07	Front Axle Left & Right Lower Outer	SUV 4WD N55B30A		Control Arm Bushing	530158
	2013.12-2018.07	Front Axle Left & Right Lower Outer	SUV 4WD N55B30A		Control Arm Bushing	533902
	2013.12-2018.07	Front Axle Left	SUV 4WD N55B30A	for vehicles with electronic drive dynamics for vehicles with adaptive drive	Rod/Strut, stabiliser	S050083
	2013.12-2018.07	Front Axle Left	SUV 4WD N55B30A	for vehicles without active stabiliser control	Rod/Strut, stabiliser	S050085
	2013.12-2018.07	Front Axle Right	SUV 4WD N55B30A	for vehicles with adaptive drive	Rod/Strut, stabiliser	S050084
	2013.12-2018.07	Front Axle Right	SUV 4WD N55B30A	for vehicles without active stabiliser control	Rod/Strut, stabiliser	S050086

	 YEAR	FITTING POSITION	BODY STYLE & DRIVE TYPE & ENGINE	REMARKS	PRODUCT	GSP Ref.
BMW						
X5 xDrive 35i						
3.0 (225 kw)	2013.12-2018.07	Rear Axle Left & Right	SUV 4WD N55B30A		Rod/Strut, stabiliser	S050082
X5 xDrive 48i						
4.8 (261 kw)	2008.10-2010.03	Front Axle Left Upper	SUV 4WD N62B48B		Track Control Arm	S061155
	2008.10-2010.03	Front Axle Left Lower Inner	SUV 4WD N62B48B		Track Control Arm	S060122
	2008.10-2010.03	Front Axle Left Lower Outer	SUV 4WD N62B48B		Track Control Arm	S060124
	2008.10-2010.03	Front Axle Right Upper	SUV 4WD N62B48B		Track Control Arm	S061156
	2008.10-2010.03	Front Axle Right Lower Inner	SUV 4WD N62B48B		Track Control Arm	S060123
	2008.10-2010.03	Front Axle Right Lower Outer	SUV 4WD N62B48B		Track Control Arm	S060125
	2008.10-2010.03	Rear Axle Left Upper Outer	SUV 4WD N62B48B		Track Control Arm	S063051
	2008.10-2010.03	Rear Axle Right Upper Outer	SUV 4WD N62B48B		Track Control Arm	S063052
	2008.10-2010.03	Front Axle Left & Right Upper	SUV 4WD N62B48B		Control Arm Bushing	533523
	2008.10-2010.03	Front Axle Left & Right Lower Inner	SUV 4WD N62B48B		Control Arm Bushing	531927
	2008.10-2010.03	Front Axle Left & Right Lower Inner	SUV 4WD N62B48B		Control Arm Bushing	531928
	2008.10-2010.03	Front Axle Left & Right Lower Outer	SUV 4WD N62B48B		Control Arm Bushing	530158
	2008.10-2010.03	Front Axle	SUV 4WD N62B48B		Suspension Repair Kit	S990020SK
	2008.10-2010.03	Front Axle Left & Right	SUV 4WD N62B48B		Tie Rod Axle Joint	S030629
	2008.10-2010.03	Front Axle Left & Right	SUV 4WD N62B48B		Tie Rod End	S070061
	2008.10-2010.03	Front Axle Left	SUV 4WD N62B48B	for vehicles with adaptive drive	Rod/Strut, stabiliser	S050083
	2008.10-2010.03	Front Axle Left	SUV 4WD N62B48B	for vehicles without electronic suspension control	Rod/Strut, stabiliser	S050085
	2008.10-2010.03	Front Axle Right	SUV 4WD N62B48B	for vehicles with adaptive drive	Rod/Strut, stabiliser	S050084
	2008.10-2010.03	Front Axle Right	SUV 4WD N62B48B	for vehicles without electronic suspension control	Rod/Strut, stabiliser	S050086
	2008.10-2010.03	Rear Axle Left & Right	SUV 4WD N62B48B		Rod/Strut, stabiliser	S050082
X5 xDrive 50i						
4.4 (300 kw)	2010.04-2013.07	Front Axle Left Upper	SUV 4WD N63B44A		Track Control Arm	S061155
	2010.04-2013.07	Front Axle Left Lower Inner	SUV 4WD N63B44A		Track Control Arm	S060122
	2010.04-2013.07	Front Axle Left Lower Outer	SUV 4WD N63B44A		Track Control Arm	S060124
	2010.04-2013.07	Front Axle Right Upper	SUV 4WD N63B44A		Track Control Arm	S061156
	2010.04-2013.07	Front Axle Right Lower Inner	SUV 4WD N63B44A		Track Control Arm	S060123
	2010.04-2013.07	Front Axle Right Lower Outer	SUV 4WD N63B44A		Track Control Arm	S060125
	2010.04-2013.07	Rear Axle Left Upper Outer	SUV 4WD N63B44A		Track Control Arm	S063051
	2010.04-2013.07	Rear Axle Right Upper Outer	SUV 4WD N63B44A		Track Control Arm	S063052
	2010.04-2013.07	Front Axle Left & Right Upper	SUV 4WD N63B44A		Control Arm Bushing	533523
	2010.04-2013.07	Front Axle Left & Right Lower Inner	SUV 4WD N63B44A		Control Arm Bushing	531927
	2010.04-2013.07	Front Axle Left & Right Lower Inner	SUV 4WD N63B44A		Control Arm Bushing	531928
	2010.04-2013.07	Front Axle Left & Right Lower Outer	SUV 4WD N63B44A		Control Arm Bushing	530158
	2010.04-2013.07	Front Axle	SUV 4WD N63B44A		Suspension Repair Kit	S990020SK
	2010.04-2013.07	Front Axle Left & Right	SUV 4WD N63B44A		Tie Rod Axle Joint	S030629
	2010.04-2013.07	Front Axle Left & Right	SUV 4WD N63B44A		Tie Rod End	S070061
	2010.04-2013.07	Front Axle Left	SUV 4WD N63B44A	for vehicles with electronic suspension control	Rod/Strut, stabiliser	S050083
	2010.04-2013.07	Front Axle Left	SUV 4WD N63B44A	for vehicles without electronic suspension control	Rod/Strut, stabiliser	S050085
	2010.04-2013.07	Front Axle Right	SUV 4WD N63B44A	for vehicles with electronic suspension control	Rod/Strut, stabiliser	S050084
	2010.04-2013.07	Front Axle Right	SUV 4WD N63B44A	for vehicles without electronic suspension control	Rod/Strut, stabiliser	S050086
	2010.04-2013.07	Rear Axle Left & Right	SUV 4WD N63B44A		Rod/Strut, stabiliser	S050082
4.4 (330 kw)	2013.08-2018.07	Front Axle Left Upper	SUV 4WD N63B44B		Track Control Arm	S061155
	2013.08-2018.07	Front Axle Right Upper	SUV 4WD N63B44B		Track Control Arm	S061156
	2013.08-2018.07	Rear Axle Left Upper Outer	SUV 4WD N63B44B		Track Control Arm	S063051
	2013.08-2018.07	Rear Axle Right Upper Outer	SUV 4WD N63B44B		Track Control Arm	S063052
	2013.08-2018.07	Front Axle Left & Right Upper	SUV 4WD N63B44B		Control Arm Bushing	533523
	2013.08-2018.07	Front Axle Left & Right Lower Inner	SUV 4WD N63B44B		Control Arm Bushing	531927
	2013.08-2018.07	Front Axle Left & Right Lower Inner	SUV 4WD N63B44B		Control Arm Bushing	533511
	2013.08-2018.07	Front Axle Left & Right Lower Outer	SUV 4WD N63B44B		Control Arm Bushing	530158
	2013.08-2018.07	Front Axle Left & Right Lower Outer	SUV 4WD N63B44B		Control Arm Bushing	533902
	2013.08-2018.07	Front Axle Left	SUV 4WD N63B44B	for vehicles with adaptive drive	Rod/Strut, stabiliser	S050083
	2013.08-2018.07	Front Axle Left	SUV 4WD N63B44B	for vehicles without active stabiliser control	Rod/Strut, stabiliser	S050085
	2013.08-2018.07	Front Axle Right	SUV 4WD N63B44B	for vehicles with adaptive drive	Rod/Strut, stabiliser	S050084
	2013.08-2018.07	Front Axle Right	SUV 4WD N63B44B	for vehicles without active stabiliser control	Rod/Strut, stabiliser	S050086
	2013.08-2018.07	Rear Axle Left & Right	SUV 4WD N63B44B		Rod/Strut, stabiliser	S050082
X5 xDrive M50d						
3.0 (280 kw)	2013.12-2018.07	Front Axle Left Upper	SUV 4WD N57D30C		Track Control Arm	S061155
	2013.12-2018.07	Front Axle Right Upper	SUV 4WD N57D30C		Track Control Arm	S061156
	2013.12-2018.07	Rear Axle Left Upper Outer	SUV 4WD N57D30C		Track Control Arm	S063051
	2013.12-2018.07	Rear Axle Right Upper Outer	SUV 4WD N57D30C		Track Control Arm	S063052
	2013.12-2018.07	Front Axle Left & Right Upper	SUV 4WD N57D30C		Control Arm Bushing	533523
	2013.12-2018.07	Front Axle Left & Right Lower Inner	SUV 4WD N57D30C		Control Arm Bushing	531927



	 YEAR	FITTING POSITION	BODY STYLE & DRIVE TYPE & ENGINE	REMARKS	PRODUCT	GSP Ref.
BMW						
X5 xDrive M50d						
3.0 (280 kw)	2013.12-2018.07	Front Axle Left & Right Lower Inner	SUV 4WD N57D30C		Control Arm Bushing	533511
	2013.12-2018.07	Front Axle Left & Right Lower Outer	SUV 4WD N57D30C		Control Arm Bushing	533902
	2013.12-2018.07	Front Axle Left	SUV 4WD N57D30C	for vehicles with electronic drive dynamics for vehicles with adaptive drive	Rod/Strut, stabiliser	S050083
	2013.12-2018.07	Front Axle Left	SUV 4WD N57D30C	for vehicles without active stabiliser control	Rod/Strut, stabiliser	S050085
	2013.12-2018.07	Front Axle Right	SUV 4WD N57D30C	for vehicles with electronic drive dynamics for vehicles with adaptive drive	Rod/Strut, stabiliser	S050084
	2013.12-2018.07	Front Axle Right	SUV 4WD N57D30C	for vehicles without active stabiliser control	Rod/Strut, stabiliser	S050086
	2013.12-2018.07	Rear Axle Left & Right	SUV 4WD N57D30C		Rod/Strut, stabiliser	S050082
X6 M						
4.4 (423 kw)	2014.12-2019.07	Rear Axle Left Upper Outer	SUV 4WD S63B44B		Track Control Arm	S063051
	2014.12-2019.07	Rear Axle Right Upper Outer	SUV 4WD S63B44B		Track Control Arm	S063052
	2014.12-2019.07	Front Axle Left & Right Lower Inner	SUV 4WD S63B44B		Control Arm Bushing	531927
	2014.12-2019.07	Front Axle Left & Right Lower Outer	SUV 4WD S63B44B		Control Arm Bushing	533902
	2014.12-2019.07	Front Axle Left	SUV 4WD S63B44B		Rod/Strut, stabiliser	S050083
	2014.12-2019.07	Front Axle Right	SUV 4WD S63B44B		Rod/Strut, stabiliser	S050084
	2014.12-2019.07	Rear Axle Left & Right	SUV 4WD S63B44B		Rod/Strut, stabiliser	S050082
X6 xDrive 35i						
3.0 (225 kw)	2008.01-2014.07	Front Axle Left Upper	SUV 4WD N54B30A/N55B30A		Track Control Arm	S061155
	2008.01-2014.07	Front Axle Left Lower Inner	SUV 4WD N54B30A/N55B30A		Track Control Arm	S060122
	2008.01-2014.07	Front Axle Left Lower Outer	SUV 4WD N54B30A/N55B30A		Track Control Arm	S060124
	2008.01-2014.07	Front Axle Right Upper	SUV 4WD N54B30A/N55B30A		Track Control Arm	S061156
	2008.01-2014.07	Front Axle Right Lower Inner	SUV 4WD N54B30A/N55B30A		Track Control Arm	S060123
	2008.01-2014.07	Front Axle Right Lower Outer	SUV 4WD N54B30A/N55B30A		Track Control Arm	S060125
	2008.01-2014.07	Rear Axle Left Upper Outer	SUV 4WD N54B30A/N55B30A		Track Control Arm	S063051
	2008.01-2014.07	Rear Axle Right Upper Outer	SUV 4WD N54B30A/N55B30A		Track Control Arm	S063052
	2008.01-2014.07	Front Axle Left & Right Upper	SUV 4WD N54B30A/N55B30A		Control Arm Bushing	533523
	2008.01-2014.07	Front Axle Left & Right Lower Inner	SUV 4WD N54B30A/N55B30A		Control Arm Bushing	531927
	2008.01-2014.07	Front Axle Left & Right Lower Outer	SUV 4WD N54B30A/N55B30A		Control Arm Bushing	531928
	2008.01-2014.07	Front Axle Left & Right Lower Outer	SUV 4WD N54B30A/N55B30A		Control Arm Bushing	530158
	2008.01-2014.07	Front Axle	SUV 4WD N54B30A/N55B30A		Suspension Repair Kit	S990020SK
	2008.01-2014.07	Front Axle Left & Right	SUV 4WD N54B30A/N55B30A		Tie Rod Axle Joint	S030629
	2008.01-2014.07	Front Axle Left & Right	SUV 4WD N54B30A/N55B30A		Tie Rod End	S070061
	2008.01-2014.07	Front Axle Left	SUV 4WD N54B30A/N55B30A	for vehicles with electronic suspension control	Rod/Strut, stabiliser	S050083
	2008.01-2014.07	Front Axle Left	SUV 4WD N54B30A/N55B30A	for vehicles without electronic suspension control	Rod/Strut, stabiliser	S050085
	2008.01-2014.07	Front Axle Right	SUV 4WD N54B30A/N55B30A	for vehicles with electronic suspension control	Rod/Strut, stabiliser	S050084
	2008.01-2014.07	Front Axle Right	SUV 4WD N54B30A/N55B30A	for vehicles without electronic suspension control	Rod/Strut, stabiliser	S050086
	2008.01-2014.07	Rear Axle Left & Right	SUV 4WD N54B30A/N55B30A		Rod/Strut, stabiliser	S050082
	2014.08-2019.07	Front Axle Left Upper	SUV 4WD N55B30A		Track Control Arm	S061155
	2014.08-2019.07	Front Axle Right Upper	SUV 4WD N55B30A		Track Control Arm	S061156
	2014.08-2019.07	Rear Axle Left Upper Outer	SUV 4WD N55B30A		Track Control Arm	S063051
	2014.08-2019.07	Rear Axle Right Upper Outer	SUV 4WD N55B30A		Track Control Arm	S063052
	2014.08-2019.07	Front Axle Left & Right Upper	SUV 4WD N55B30A		Control Arm Bushing	533523
	2014.08-2019.07	Front Axle Left & Right Lower Inner	SUV 4WD N55B30A		Control Arm Bushing	531927
	2014.08-2019.07	Front Axle Left & Right Lower Outer	SUV 4WD N55B30A		Control Arm Bushing	533511
	2014.08-2019.07	Front Axle Left & Right Lower Outer	SUV 4WD N55B30A		Control Arm Bushing	530158
	2014.08-2019.07	Front Axle Left & Right Lower Outer	SUV 4WD N55B30A		Control Arm Bushing	533902
	2014.08-2019.07	Front Axle Left	SUV 4WD N55B30A	for vehicles with adaptive drive	Rod/Strut, stabiliser	S050083
	2014.08-2019.07	Front Axle Left	SUV 4WD N55B30A	for vehicles without active stabiliser control	Rod/Strut, stabiliser	S050085
	2014.08-2019.07	Front Axle Right	SUV 4WD N55B30A	for vehicles with adaptive drive	Rod/Strut, stabiliser	S050084
	2014.08-2019.07	Front Axle Right	SUV 4WD N55B30A	for vehicles without active stabiliser control	Rod/Strut, stabiliser	S050086
	2014.08-2019.07	Rear Axle Left & Right	SUV 4WD N55B30A		Rod/Strut, stabiliser	S050082
X6 xDrive 50i						
4.4 (300 kw)	2008.07-2014.07	Front Axle Left Upper	SUV 4WD N63B44A		Track Control Arm	S061155
	2008.07-2014.07	Front Axle Left Lower Inner	SUV 4WD N63B44A		Track Control Arm	S060122
	2008.07-2014.07	Front Axle Left Lower Outer	SUV 4WD N63B44A		Track Control Arm	S060124
	2008.07-2014.07	Front Axle Right Upper	SUV 4WD N63B44A		Track Control Arm	S061156
	2008.07-2014.07	Front Axle Right Lower Inner	SUV 4WD N63B44A		Track Control Arm	S060123
	2008.07-2014.07	Front Axle Right Lower Outer	SUV 4WD N63B44A		Track Control Arm	S060125
	2008.07-2014.07	Rear Axle Left Upper Outer	SUV 4WD N63B44A		Track Control Arm	S063051
	2008.07-2014.07	Rear Axle Right Upper Outer	SUV 4WD N63B44A		Track Control Arm	S063052
	2008.07-2014.07	Front Axle Left & Right Upper	SUV 4WD N63B44A		Control Arm Bushing	533523
	2008.07-2014.07	Front Axle Left & Right Lower Inner	SUV 4WD N63B44A		Control Arm Bushing	531927
	2008.07-2014.07	Front Axle Left & Right Lower Inner	SUV 4WD N63B44A		Control Arm Bushing	531928
	2008.07-2014.07	Front Axle Left & Right Lower Outer	SUV 4WD N63B44A		Control Arm Bushing	530158
	2008.07-2014.07	Front Axle Left & Right	SUV 4WD N63B44A		Tie Rod Axle Joint	S030629

	 YEAR	FITTING POSITION	BODY STYLE & DRIVE TYPE & ENGINE	REMARKS	PRODUCT	GSP Ref.
BMW						
X6 xDrive 50i						
4.4 (300 kw)	2008.07-2014.07	Front Axle Left & Right	SUV 4WD N63B44A		Tie Rod End	S070061
	2008.07-2014.07	Front Axle Left	SUV 4WD N63B44A	for vehicles with electronic suspension control	Rod/Strut, stabiliser	S050083
	2008.07-2014.07	Front Axle Left	SUV 4WD N63B44A	for vehicles without electronic suspension control	Rod/Strut, stabiliser	S050085
	2008.07-2014.07	Front Axle Right	SUV 4WD N63B44A	for vehicles with electronic suspension control	Rod/Strut, stabiliser	S050084
	2008.07-2014.07	Front Axle Right	SUV 4WD N63B44A	for vehicles without electronic suspension control	Rod/Strut, stabiliser	S050086
	2008.07-2014.07	Rear Axle Left & Right	SUV 4WD N63B44A		Rod/Strut, stabiliser	S050082
4.4 (330 kw)	2014.08-2019.07	Front Axle Left Upper	SUV 4WD N63B44B		Track Control Arm	S061155
	2014.08-2019.07	Front Axle Right Upper	SUV 4WD N63B44B		Track Control Arm	S061156
	2014.08-2019.07	Rear Axle Left Upper Outer	SUV 4WD N63B44B		Track Control Arm	S063051
	2014.08-2019.07	Rear Axle Right Upper Outer	SUV 4WD N63B44B		Track Control Arm	S063052
	2014.08-2019.07	Front Axle Left & Right Upper	SUV 4WD N63B44B		Control Arm Bushing	533523
	2014.08-2019.07	Front Axle Left & Right Lower Inner	SUV 4WD N63B44B		Control Arm Bushing	531927
	2014.08-2019.07	Front Axle Left & Right Lower Inner	SUV 4WD N63B44B		Control Arm Bushing	533511
	2014.08-2019.07	Front Axle Left & Right Lower Outer	SUV 4WD N63B44B		Control Arm Bushing	530158
	2014.08-2019.07	Front Axle Left & Right Lower Outer	SUV 4WD N63B44B		Control Arm Bushing	533902
	2014.08-2019.07	Front Axle Left	SUV 4WD N63B44B	for vehicles with adaptive drive	Rod/Strut, stabiliser	S050083
	2014.08-2019.07	Front Axle Left	SUV 4WD N63B44B	for vehicles without active stabiliser control	Rod/Strut, stabiliser	S050085
	2014.08-2019.07	Front Axle Right	SUV 4WD N63B44B	for vehicles with electronic drive dynamics for vehicles with adaptive drive	Rod/Strut, stabiliser	S050084
	2014.08-2019.07	Front Axle Right	SUV 4WD N63B44B	for vehicles without active stabiliser control	Rod/Strut, stabiliser	S050086
	2014.08-2019.07	Rear Axle Left & Right	SUV 4WD N63B44B		Rod/Strut, stabiliser	S050082
Z3 Cabrio						
1.9 (103 kw)	1995.11-1999.03	Front Axle Left Lower	Cabriolet RWD M44B194S1		Track Control Arm	S060114
	1995.11-1999.03	Front Axle Right Lower	Cabriolet RWD M44B194S1		Track Control Arm	S060113
	1995.11-1999.03	Front Axle Left & Right Lower	Cabriolet RWD M44B194S1		Ball Joint	S080020
	1995.11-1999.03	Front Axle Left & Right Lower	Cabriolet RWD M44B194S1		Ball Joint	S080025
	1995.11-1999.03	Front Axle Left Lower	Cabriolet RWD M44B194S1		Control Arm Bushing	518074
	1995.11-1999.03	Front Axle Right Lower	Cabriolet RWD M44B194S1		Control Arm Bushing	518073
	1995.11-1999.03	Front Axle Left & Right Lower	Cabriolet RWD M44B194S1		Control Arm Bushing	511593
	1995.11-1999.03	Front Axle Left & Right Lower	Cabriolet RWD M44B194S1		Control Arm Bushing Kit	530751S
	1995.11-1999.03	Front Axle Left	Cabriolet RWD M44B194S1		Rod Assembly	S100029
	1995.11-1999.03	Front Axle Right	Cabriolet RWD M44B194S1		Rod Assembly	S100030
	1995.11-1999.03	Front Axle Left & Right	Cabriolet RWD M44B194S1		Tie Rod Axle Joint	S030777
	1995.11-1999.03	Front Axle Left	Cabriolet RWD M44B194S1		Tie Rod End	S070054
	1995.11-1999.03	Front Axle Right	Cabriolet RWD M44B194S1		Tie Rod End	S070055
	1995.11-1999.03	Front Axle Left & Right	Cabriolet RWD M44B194S1		Rod/Strut, stabiliser	S050077
	1995.11-1999.03	Rear Axle Left & Right	Cabriolet RWD M44B194S1		Rod/Strut, stabiliser	520093
	1995.11-1999.03	Front Axle	Cabriolet RWD M44B194S1		Steering Boot	540041
	1995.11-1999.03	Front Axle	Cabriolet RWD M44B194S1		Steering Boot	540186
	1995.11-1999.03	Front Axle	Cabriolet RWD M44B194S1		Steering Rack Bellow Kit	540191S
2.8 (142 kw)	1996.11-2000.05	Front Axle Left Lower	Cabriolet RWD M52B286S1		Track Control Arm	S060114
	1996.11-2000.05	Front Axle Right Lower	Cabriolet RWD M52B286S1		Track Control Arm	S060113
	1996.11-2000.05	Front Axle Left & Right Lower	Cabriolet RWD M52B286S1		Ball Joint	S080020
	1996.11-2000.05	Front Axle Left & Right Lower	Cabriolet RWD M52B286S1		Ball Joint	S080025
	1996.11-2000.05	Front Axle Left Lower	Cabriolet RWD M52B286S1		Control Arm Bushing	518074
	1996.11-2000.05	Front Axle Right Lower	Cabriolet RWD M52B286S1		Control Arm Bushing	518073
	1996.11-2000.05	Front Axle Left & Right Lower	Cabriolet RWD M52B286S1		Control Arm Bushing	511593
	1996.11-2000.05	Front Axle Left & Right Lower	Cabriolet RWD M52B286S1		Control Arm Bushing Kit	530751S
	1996.11-2000.05	Front Axle Left	Cabriolet RWD M52B286S1		Rod Assembly	S100029
	1996.11-2000.05	Front Axle Right	Cabriolet RWD M52B286S1		Rod Assembly	S100030
	1996.11-2000.05	Front Axle Left & Right	Cabriolet RWD M52B286S1		Tie Rod Axle Joint	S030777
	1996.11-2000.05	Front Axle Left	Cabriolet RWD M52B286S1		Tie Rod End	S070054
	1996.11-2000.05	Front Axle Right	Cabriolet RWD M52B286S1		Tie Rod End	S070055
	1996.11-2000.05	Front Axle Left & Right	Cabriolet RWD M52B286S1		Rod/Strut, stabiliser	S050077
	1996.11-2000.05	Rear Axle Left & Right	Cabriolet RWD M52B286S1		Rod/Strut, stabiliser	520093
	1996.11-2000.05	Front Axle	Cabriolet RWD M52B286S1		Steering Boot	540041
	1996.11-2000.05	Front Axle	Cabriolet RWD M52B286S1		Steering Boot	540186
	1996.11-2000.05	Front Axle	Cabriolet RWD M52B286S1		Steering Rack Bellow Kit	540191S
3.0 (170 kw)	2000.06-2002.06	Front Axle Left Lower	Cabriolet RWD M54B306S3		Track Control Arm	S060114
	2000.06-2002.06	Front Axle Right Lower	Cabriolet RWD M54B306S3		Track Control Arm	S060113
	2000.06-2002.06	Front Axle Left & Right Lower	Cabriolet RWD M54B306S3		Ball Joint	S080020
	2000.06-2002.06	Front Axle Left & Right Lower	Cabriolet RWD M54B306S3		Ball Joint	S080025
	2000.06-2002.06	Front Axle Left Lower	Cabriolet RWD M54B306S3		Control Arm Bushing	518074
	2000.06-2002.06	Front Axle Right Lower	Cabriolet RWD M54B306S3		Control Arm Bushing	518073
	2000.06-2002.06	Front Axle Left & Right Lower	Cabriolet RWD M54B306S3		Control Arm Bushing	511593



 YEAR	FITTING POSITION	BODY STYLE & DRIVE TYPE & ENGINE	REMARKS	PRODUCT	GSP Ref.
BMW					
Z3 Cabrio					
3.0 (170 kw)	2000.06-2002.06	Front Axle Left & Right Lower	Cabriolet RWD M54B306S3		Control Arm Bushing Kit 530751S
	2000.06-2002.06	Front Axle Left	Cabriolet RWD M54B306S3		Rod Assembly S100029
	2000.06-2002.06	Front Axle Right	Cabriolet RWD M54B306S3		Rod Assembly S100030
	2000.06-2002.06	Front Axle Left & Right	Cabriolet RWD M54B306S3		Tie Rod Axle Joint S030777
	2000.06-2002.06	Front Axle Left	Cabriolet RWD M54B306S3		Tie Rod End S070054
	2000.06-2002.06	Front Axle Right	Cabriolet RWD M54B306S3		Tie Rod End S070055
	2000.06-2002.06	Front Axle Left & Right	Cabriolet RWD M54B306S3		Rod/Strut, stabiliser S050077
	2000.06-2002.06	Rear Axle Left & Right	Cabriolet RWD M54B306S3		Rod/Strut, stabiliser 520093
	2000.06-2002.06	Front Axle	Cabriolet RWD M54B306S3		Stabiliser Bushing 512754
	2000.06-2002.06	Front Axle	Cabriolet RWD M54B306S3		Steering Boot 540041
	2000.06-2002.06	Front Axle	Cabriolet RWD M54B306S3		Steering Boot 540186
	2000.06-2002.06	Front Axle	Cabriolet RWD M54B306S3		Steering Rack Bellow Kit 540191S
Z3 Coupe					
3.2 (236 kw)	1997.04-2001.06	Front Axle Left Lower	Coupe RWD S50B326S1/S50B326S3		Track Control Arm S060114
	1997.04-2001.06	Front Axle Right Lower	Coupe RWD S50B326S1/S50B326S3		Track Control Arm S060113
	1997.04-2001.06	Front Axle Left	Coupe RWD S50B326S1/S50B326S3		Rod Assembly S100029
	1997.04-2001.06	Front Axle Right	Coupe RWD S50B326S1/S50B326S3		Rod Assembly S100030
	1997.04-2001.06	Front Axle Left & Right	Coupe RWD S50B326S1/S50B326S3		Tie Rod Axle Joint S030777
	1997.04-2001.06	Front Axle Left	Coupe RWD S50B326S1/S50B326S3		Tie Rod End S070054
	1997.04-2001.06	Front Axle Right	Coupe RWD S50B326S1/S50B326S3		Tie Rod End S070055
	1997.04-2001.06	Rear Axle Left & Right	Coupe RWD S50B326S1/S50B326S3		Rod/Strut, stabiliser 520093
	1997.04-2001.06	Front Axle	Coupe RWD S50B326S1/S50B326S3		Steering Boot 540041
	1997.04-2001.06	Front Axle	Coupe RWD S50B326S1/S50B326S3		Steering Boot 540186
	1997.04-2001.06	Front Axle	Coupe RWD S50B326S1/S50B326S3		Steering Rack Bellow Kit 540191S
Z4 Cabrio					
3.0 (170 kw)	2002.12-2005.12	Front Axle Left Lower	Cabriolet RWD M54B306S3	for vehicles with standard suspension	Track Control Arm S060358
	2002.12-2005.12	Front Axle Left Lower	Cabriolet RWD M54B306S3	for vehicles with standard suspension	Track Control Arm S061164
	2002.12-2005.12	Front Axle Right Lower	Cabriolet RWD M54B306S3	for vehicles with standard suspension	Track Control Arm S060359
	2002.12-2005.12	Front Axle Right Lower	Cabriolet RWD M54B306S3	for vehicles with standard suspension	Track Control Arm S061165
	2002.12-2005.12	Rear Axle Left & Right Lower Inner	Cabriolet RWD M54B306S3		Track Control Arm S060098
	2002.12-2005.12	Front Axle Left Lower	Cabriolet RWD M54B306S3		Control Arm Bushing 517479
	2002.12-2005.12	Front Axle Right Lower	Cabriolet RWD M54B306S3		Control Arm Bushing 517478
	2002.12-2005.12	Front Axle Left & Right Lower	Cabriolet RWD M54B306S3		Control Arm Bushing 510605
	2002.12-2005.12	Rear Axle Left & Right Upper	Cabriolet RWD M54B306S3		Control Arm Bushing 512710
	2002.12-2005.12	Rear Axle Left & Right Lower Inner	Cabriolet RWD M54B306S3		Control Arm Bushing 512305
	2002.12-2005.12	Front Axle Left & Right Lower	Cabriolet RWD M54B306S3		Control Arm Bushing Kit 530752S
	2002.12-2005.12	Front Axle Left & Right Lower	Cabriolet RWD M54B306S3		Control Arm Bushing Kit 531849S
	2002.12-2005.12	Front Axle	Cabriolet RWD M54B306S3		Suspension Repair Kit S990031SK
	2002.12-2005.12	Front Axle Left	Cabriolet RWD M54B306S3		Rod Assembly S100254
	2002.12-2005.12	Front Axle Right	Cabriolet RWD M54B306S3		Rod Assembly S100017
	2002.12-2005.12	Front Axle Left & Right	Cabriolet RWD M54B306S3		Tie Rod Axle Joint S030351
	2002.12-2005.12	Front Axle Left	Cabriolet RWD M54B306S3		Tie Rod End S070042
	2002.12-2005.12	Front Axle Right	Cabriolet RWD M54B306S3		Tie Rod End S070041
	2002.12-2005.12	Front Axle Left & Right	Cabriolet RWD M54B306S3		Rod/Strut, stabiliser S050056
	2002.12-2005.12	Rear Axle Left & Right	Cabriolet RWD M54B306S3		Rod/Strut, stabiliser S051332
	2002.12-2005.12	Front Axle	Cabriolet RWD M54B306S3		Stabiliser Bushing 519360
	2002.12-2005.12	Front Axle	Cabriolet RWD M54B306S3		Steering Boot 540041
	2002.12-2005.12	Front Axle	Cabriolet RWD M54B306S3	for vehicles with power steering	Steering Rack Bellow Kit 540186S
Z4 Coupe					
3.0 (195 kw)	2006.04-2008.08	Front Axle Left Lower	Coupe RWD N52B30A	for vehicles with standard suspension	Track Control Arm S060358
	2006.04-2008.08	Front Axle Left Lower	Coupe RWD N52B30A	for vehicles with standard suspension	Track Control Arm S061164
	2006.04-2008.08	Front Axle Right Lower	Coupe RWD N52B30A	for vehicles with standard suspension	Track Control Arm S060359
	2006.04-2008.08	Front Axle Right Lower	Coupe RWD N52B30A	for vehicles with standard suspension	Track Control Arm S061165
	2006.04-2008.08	Rear Axle Left & Right Lower Inner	Coupe RWD N52B30A		Track Control Arm S060098
	2006.04-2008.08	Front Axle Left Lower	Coupe RWD N52B30A		Control Arm Bushing 517479
	2006.04-2008.08	Front Axle Right Lower	Coupe RWD N52B30A		Control Arm Bushing 517478
	2006.04-2008.08	Front Axle Left & Right Lower	Coupe RWD N52B30A		Control Arm Bushing 510605
	2006.04-2008.08	Rear Axle Left & Right Upper	Coupe RWD N52B30A		Control Arm Bushing 512710
	2006.04-2008.08	Rear Axle Left & Right Lower Inner	Coupe RWD N52B30A		Control Arm Bushing 512305
	2006.04-2008.08	Front Axle Left & Right Lower	Coupe RWD N52B30A		Control Arm Bushing Kit 530752S
	2006.04-2008.08	Front Axle Left & Right Lower	Coupe RWD N52B30A		Control Arm Bushing Kit 531849S
	2006.04-2008.08	Front Axle	Coupe RWD N52B30A		Suspension Repair Kit S990031SK
	2006.04-2008.08	Front Axle Left	Coupe RWD N52B30A		Rod Assembly S100254
	2006.04-2008.08	Front Axle Right	Coupe RWD N52B30A		Rod Assembly S100017



	 YEAR	FITTING POSITION	BODY STYLE & DRIVE TYPE & ENGINE	REMARKS	PRODUCT	GSP Ref.
BMW						
Z4 Coupe						
3.0 (195 kw)	2006.04-2008.08	Front Axle Left & Right	Coupe RWD N52B30A		Tie Rod Axle Joint	S030351
	2006.04-2008.08	Front Axle Left	Coupe RWD N52B30A		Tie Rod End	S070042
	2006.04-2008.08	Front Axle Right	Coupe RWD N52B30A		Tie Rod End	S070041
	2006.04-2008.08	Front Axle Left & Right	Coupe RWD N52B30A		Rod/Strut, stabiliser	S050056
	2006.04-2008.08	Rear Axle Left & Right	Coupe RWD N52B30A		Rod/Strut, stabiliser	S051332
	2006.04-2008.08	Front Axle	Coupe RWD N52B30A		Stabiliser Bushing	519360
	2006.04-2008.08	Front Axle	Coupe RWD N52B30A	for vehicles with power steering	Steering Rack Bellow Kit	540186S
Z4 M40i Cabrio						
3.0 (250 kw)	2018.11-	Rear Axle Left	Cabriolet RWD B58B30C		Rod/Strut, stabiliser	S051261
	2018.11-	Rear Axle Right	Cabriolet RWD B58B30C		Rod/Strut, stabiliser	S051262
Z4 sDrive 20i Cabrio						
2.0 (135 kw)	2011.09-2016.08	Front Axle Left Lower Inner	Cabriolet RWD N20B20A		Track Control Arm	S062657
	2011.09-2016.08	Front Axle Left Lower Outer	Cabriolet RWD N20B20A		Track Control Arm	S060085
	2011.09-2016.08	Front Axle Right Lower Inner	Cabriolet RWD N20B20A		Track Control Arm	S062658
	2011.09-2016.08	Front Axle Right Lower Outer	Cabriolet RWD N20B20A		Track Control Arm	S060086
	2011.09-2016.08	Rear Axle Left & Right Lower Inner	Cabriolet RWD N20B20A		Track Control Arm	S060098
	2011.09-2016.08	Front Axle Left & Right Lower Inner	Cabriolet RWD N20B20A		Control Arm Bushing	531936
	2011.09-2016.08	Rear Axle Left & Right Upper	Cabriolet RWD N20B20A		Control Arm Bushing	512710
	2011.09-2016.08	Rear Axle Left & Right Lower Inner	Cabriolet RWD N20B20A		Control Arm Bushing	512305
	2011.09-2016.08	Front Axle Left	Cabriolet RWD N20B20A		Rod Assembly	S100330
	2011.09-2016.08	Front Axle Right	Cabriolet RWD N20B20A		Rod Assembly	S100331
	2011.09-2016.08	Front Axle Left & Right	Cabriolet RWD N20B20A		Tie Rod Axle Joint	S030350
	2011.09-2016.08	Front Axle Left	Cabriolet RWD N20B20A		Tie Rod End	S070045
	2011.09-2016.08	Front Axle Right	Cabriolet RWD N20B20A		Tie Rod End	S070046
	2011.09-2016.08	Front Axle Left	Cabriolet RWD N20B20A		Rod/Strut, stabiliser	S050068
	2011.09-2016.08	Front Axle Right	Cabriolet RWD N20B20A		Rod/Strut, stabiliser	S050069
	2011.09-2016.08	Rear Axle Left & Right	Cabriolet RWD N20B20A		Rod/Strut, stabiliser	S051332
Z4 sDrive 23i Cabrio						
2.5 (150 kw)	2009.03-2011.08	Front Axle Left Lower Inner	Cabriolet RWD N52B25A/N52B25BF		Track Control Arm	S062657
	2009.03-2011.08	Front Axle Left Lower Outer	Cabriolet RWD N52B25A/N52B25BF		Track Control Arm	S060085
	2009.03-2011.08	Front Axle Right Lower Inner	Cabriolet RWD N52B25A/N52B25BF		Track Control Arm	S062658
	2009.03-2011.08	Front Axle Right Lower Outer	Cabriolet RWD N52B25A/N52B25BF		Track Control Arm	S060086
	2009.03-2011.08	Rear Axle Left & Right Lower Inner	Cabriolet RWD N52B25A/N52B25BF		Track Control Arm	S060098
	2009.03-2011.08	Front Axle Left & Right Lower Inner	Cabriolet RWD N52B25A/N52B25BF		Control Arm Bushing	531936
	2009.03-2011.08	Rear Axle Left & Right Upper	Cabriolet RWD N52B25A/N52B25BF		Control Arm Bushing	512710
	2009.03-2011.08	Rear Axle Left & Right Lower Inner	Cabriolet RWD N52B25A/N52B25BF		Control Arm Bushing	512305
	2009.03-2011.08	Front Axle Left	Cabriolet RWD N52B25A/N52B25BF		Rod Assembly	S100330
	2009.03-2011.08	Front Axle Right	Cabriolet RWD N52B25A/N52B25BF		Rod Assembly	S100331
	2009.03-2011.08	Front Axle Left & Right	Cabriolet RWD N52B25A/N52B25BF		Tie Rod Axle Joint	S030350
	2009.03-2011.08	Front Axle Left	Cabriolet RWD N52B25A/N52B25BF		Tie Rod End	S070045
	2009.03-2011.08	Front Axle Right	Cabriolet RWD N52B25A/N52B25BF		Tie Rod End	S070046
	2009.03-2011.08	Front Axle Left	Cabriolet RWD N52B25A/N52B25BF		Rod/Strut, stabiliser	S050068
	2009.03-2011.08	Front Axle Right	Cabriolet RWD N52B25A/N52B25BF		Rod/Strut, stabiliser	S050069
	2009.03-2011.08	Rear Axle Left & Right	Cabriolet RWD N52B25A/N52B25BF		Rod/Strut, stabiliser	S051332
	2009.03-2011.08	Front Axle	Cabriolet RWD N52B25A/N52B25BF		Stabiliser Bushing	519357
Z4 sDrive 30i Cabrio						
2.0 (190 kw)	2018.11-	Rear Axle Left	Cabriolet RWD B48B20B		Rod/Strut, stabiliser	S051261
	2018.11-	Rear Axle Right	Cabriolet RWD B48B20B		Rod/Strut, stabiliser	S051262
Z4 sDrive 35i Cabrio						
3.0 (225 kw)	2009.02-2016.08	Front Axle Left Lower Inner	Cabriolet RWD N54B30A		Track Control Arm	S062657
	2009.02-2016.08	Front Axle Left Lower Outer	Cabriolet RWD N54B30A		Track Control Arm	S060085
	2009.02-2016.08	Front Axle Right Lower Inner	Cabriolet RWD N54B30A		Track Control Arm	S062658
	2009.02-2016.08	Front Axle Right Lower Outer	Cabriolet RWD N54B30A		Track Control Arm	S060086
	2009.02-2016.08	Rear Axle Left & Right Lower Inner	Cabriolet RWD N54B30A		Track Control Arm	S060098
	2009.02-2016.08	Front Axle Left & Right Lower Inner	Cabriolet RWD N54B30A		Control Arm Bushing	531936
	2009.02-2016.08	Rear Axle Left & Right Upper	Cabriolet RWD N54B30A		Control Arm Bushing	512710
	2009.02-2016.08	Rear Axle Left & Right Lower Inner	Cabriolet RWD N54B30A		Control Arm Bushing	512305
	2009.02-2016.08	Front Axle Left	Cabriolet RWD N54B30A		Rod Assembly	S100330
	2009.02-2016.08	Front Axle Right	Cabriolet RWD N54B30A		Rod Assembly	S100331
	2009.02-2016.08	Front Axle Left & Right	Cabriolet RWD N54B30A		Tie Rod Axle Joint	S030350
	2009.02-2016.08	Front Axle Left	Cabriolet RWD N54B30A		Tie Rod End	S070045
	2009.02-2016.08	Front Axle Right	Cabriolet RWD N54B30A		Tie Rod End	S070046
	2009.02-2016.08	Front Axle Left	Cabriolet RWD N54B30A		Rod/Strut, stabiliser	S050068
	2009.02-2016.08	Front Axle Right	Cabriolet RWD N54B30A		Rod/Strut, stabiliser	S050069



	 YEAR	FITTING POSITION	BODY STYLE & DRIVE TYPE & ENGINE	REMARKS	PRODUCT	GSP Ref.
BMW Z4 sDrive 35i Cabrio						
3.0 (225 kw)	2009.02-2016.08	Rear Axle Left & Right	Cabriolet RWD N54B30A		Rod/Strut, stabiliser	S051332
	2009.02-2016.08	Front Axle	Cabriolet RWD N54B30A		Stabiliser Bushing	519357
CADILLAC Escalade						
6.2 (301 kw)	2006.10-2013.12	Front Axle Left & Right	SUV RWD L92		Tie Rod End	S070737
SRX						
3.0 (198 kw)	2010.01-2016.12	Front Axle Left & Right Lower	SUV FWD LF1		Control Arm Bushing	531805
	2010.01-2016.12	Front Axle Left & Right	SUV FWD LF1		Rod/Strut, stabiliser	S051276
CHERY A3						
1.6 (88 kw)	2008.09-2010.08	Front Axle Left & Right	Saloon FWD SQR481F		Ball Joint	S081022
	2009.01-2010.08	Front Axle Left & Right	Hatchback FWD SQR481F		Ball Joint	S081022
Chance						
1.6 (88 kw)	2010.01-2012.08	Front Axle Left & Right	Hatchback FWD SQR481F		Ball Joint	S081022
M11						
1.6 (88 kw)	2008.04-	Front Axle Left & Right	Hatchback FWD SQR481F		Ball Joint	S081022
	2008.04-	Front Axle Left & Right	Saloon FWD SQR481F		Ball Joint	S081022
Niche						
1.6 (88 kw)	2010.01-2012.08	Front Axle Left & Right	Saloon FWD SQR481F		Ball Joint	S081022
Tengo						
1.6 (88 kw)	2010.01-	Front Axle Left & Right	Saloon FWD SQR481F		Ball Joint	S081022
	2010.01-	Front Axle Left & Right	Hatchback FWD SQR481F		Ball Joint	S081022
Tiggo						
2.0 (102 kw)	2007.05-	Front Axle Left & Right Lower	SUV FWD SQR484F		Control Arm Bushing	516099
CHEVROLET Caprice						
4.3 (106 kw)	1986.10-1989.09	Front Axle Left & Right Upper	Saloon RWD LB4		Ball Joint	S080823
5.0 (104 kw)	1986.01-1990.12	Front Axle Left & Right Upper	Saloon RWD LV2		Ball Joint	S080823
5.0 (127 kw)	1982.10-1990.09	Front Axle Left & Right Upper	Saloon RWD LG4/LO3		Ball Joint	S080823
Captiva Sport						
3.0 (197 kw)	2012.01-	Front Axle Left & Right Lower	SUV FWD LFW		Ball Joint	S080328
	2012.01-	Front Axle Left & Right Lower	SUV 4WD LFW		Ball Joint	S080328
	2012.01-	Rear Axle Left & Right Lower Inner	SUV FWD LFW		Control Arm Bushing	535123
	2012.01-	Rear Axle Left & Right Lower Inner	SUV 4WD LFW		Control Arm Bushing	535123
Corsa						
1.0 (44 kw)	1994.03-2002.12	Front Axle Left & Right	Saloon FWD C10S/X10E		Tie Rod Axle Joint	S030597
	1994.03-2002.12	Front Axle Left & Right	Saloon FWD C10S/X10E		Tie Rod End	S070747
1.0 (50 kw)	1997.08-2002.07	Front Axle Left & Right	Saloon FWD X10YE		Tie Rod Axle Joint	S030597
	1997.08-2002.07	Front Axle Left & Right	Saloon FWD X10YE		Tie Rod End	S070747
1.6 (68 kw)	1994.08-2002.07	Front Axle Left & Right	Saloon FWD C16N/X16N		Tie Rod Axle Joint	S030597
	1994.08-2002.07	Front Axle Left & Right	Saloon FWD C16N/X16N		Tie Rod End	S070747
	1997.08-2002.07	Front Axle Left & Right	Estate FWD X16N		Tie Rod Axle Joint	S030597
	1997.08-2002.07	Front Axle Left & Right	Estate FWD X16N		Tie Rod End	S070747
1.6 (75 kw)	1997.08-2002.07	Front Axle Left & Right	Saloon FWD L91		Tie Rod Axle Joint	S030597
	1997.08-2002.07	Front Axle Left & Right	Saloon FWD L91		Tie Rod End	S070747
Equinox						
1.5 (127 kw)	2017.07-	Rear Axle Left & Right	SUV FWD LYX		Rod/Strut, stabiliser	S051045
	2017.07-	Rear Axle Left & Right	SUV 4WD LYX		Rod/Strut, stabiliser	S051045
Lumina APV						
3.1 (90 kw)	1988.09-1996.07	Front Axle Left & Right	MPV FWD LG6		Tie Rod End	S071300
Malibu						
2.4 (126 kw)	2008.01-2012.12	Front Axle Left & Right	Saloon FWD LE5		Tie Rod End	S071205
	2008.01-2012.12	Front Axle Left & Right	Saloon FWD LE5		Rod/Strut, stabiliser	S051229
SSR						
6.0 (291 kw)	2005.01-2006.12	Front Axle Left & Right Lower	Cabriolet RWD LS2(364CUV8)		Ball Joint	S080755
	2005.01-2006.12	Front Axle Left & Right Upper	Cabriolet RWD LS2(364CUV8)		Ball Joint	S080576
CHRYSLER 300C						
3.6 (210 kw)	2011.01-	Front Axle Left Upper	Saloon RWD ERB		Track Control Arm	S061705
	2011.01-	Front Axle Right Upper	Saloon RWD ERB		Track Control Arm	S061704
	2011.01-	Front Axle Left & Right Lower Outer	Saloon RWD ERB		Track Control Arm	S063205
	2011.01-	Rear Axle Left & Right Lower	Saloon RWD ERB		Track Control Arm	S062034
	2011.01-	Front Axle Left & Right Lower	Saloon RWD ERB		Ball Joint	S080707
	2011.01-	Front Axle Left & Right	Saloon RWD ERB		Tie Rod Axle Joint	S031004



	 YEAR	FITTING POSITION	BODY STYLE & DRIVE TYPE & ENGINE	REMARKS	PRODUCT	GSP Ref.
CHRYSLER 300C						
3.6 (210 kw)	2011.01-	Front Axle Right	Saloon RWD ERB		Tie Rod End	S071271
	2011.01-	Front Axle Left & Right	Saloon RWD ERB		Rod/Strut,stabiliser	S030851
	2011.09-	Front Axle Left & Right Lower Outer	Saloon 4WD ERB	For OE no:68079723AA	Track Control Arm	S063205
	2011.09-	Front Axle Right	Saloon 4WD ERB		Tie Rod End	S071271
	2011.09-	Front Axle Left & Right	Saloon 4WD ERB		Rod/Strut,stabiliser	S030851
3.6 (218 kw)	2011.01-	Front Axle Left & Right Lower Outer	Saloon RWD ERB		Track Control Arm	S063205
	2011.01-	Front Axle Left & Right Lower	Saloon RWD ERB		Ball Joint	S080707
	2011.01-	Front Axle Left & Right	Saloon RWD ERB		Tie Rod Axle Joint	S031004
	2011.01-	Front Axle Right	Saloon RWD ERB		Tie Rod End	S071271
	2011.01-	Front Axle Left & Right	Saloon RWD ERB		Rod/Strut,stabiliser	S030851
5.7 (250 kw)	2005.04-2010.12	Front Axle Left Lower	Estate 4WD EZB/EZH	Engine code:EZH	Track Control Arm	S061174
	2005.04-2010.12	Front Axle Left Lower	Estate 4WD EZB/EZH		Track Control Arm	S062013
	2005.04-2010.12	Front Axle Left Upper	Estate 4WD EZB/EZH		Track Control Arm	S061705
	2005.04-2010.12	Front Axle Right Lower	Estate 4WD EZB/EZH	Engine code:EZH	Track Control Arm	S061175
	2005.04-2010.12	Front Axle Right Lower	Estate 4WD EZB/EZH		Track Control Arm	S062014
	2005.04-2010.12	Front Axle Right Upper	Estate 4WD EZB/EZH		Track Control Arm	S061704
	2005.04-2010.12	Front Axle Left & Right Lower Inner	Estate 4WD EZB/EZH		Track Control Arm	S061176
	2005.04-2010.12	Rear Axle Left & Right Lower	Estate 4WD EZB/EZH		Track Control Arm	S062034
	2005.04-2010.12	Front Axle Left & Right Lower	Estate 4WD EZB/EZH		Ball Joint	S080707
	2005.04-2010.12	Front Axle Left & Right Lower Inner	Estate 4WD EZB/EZH		Control Arm Bushing	519652
	2005.04-2010.12	Front Axle Left & Right Lower Inner	Estate 4WD EZB/EZH		Control Arm Bushing	519661
	2005.04-2010.12	Rear Axle Left & Right Lower Inner	Estate 4WD EZB/EZH		Control Arm Bushing	530527
	2005.04-2010.12	Rear Axle Left & Right Lower Outer	Estate 4WD EZB/EZH	Inner diameter:12.2mm	Control Arm Bushing	516553
	2005.04-2010.12	Front Axle Left & Right	Estate 4WD EZB/EZH		Tie Rod Axle Joint	S030574
	2005.04-2010.12	Front Axle Right	Estate 4WD EZB/EZH		Tie Rod End	S071271
	2005.04-2010.12	Front Axle Left & Right	Estate 4WD EZB/EZH		Tie Rod End	S071013
	2005.04-2010.12	Front Axle Left & Right	Estate 4WD EZB/EZH		Rod/Strut,stabiliser	S030851
	2005.04-2010.12	Front Axle	Estate 4WD EZB/EZH		Stabiliser Bushing	516814
	2005.04-2010.12	Front Axle	Estate 4WD EZB/EZH		Stabiliser Bushing	516815
	2005.04-2010.12	Front Axle	Estate 4WD EZB/EZH		Steering Rack Bellow Kit	540211K
5.7 (268 kw)	2009.05-2010.12	Front Axle Right	Saloon 4WD EZD/EZH		Tie Rod End	S071271
	2009.05-2010.12	Front Axle Left & Right	Saloon 4WD EZD/EZH		Tie Rod End	S071013
	2009.05-2010.12	Front Axle Left & Right	Saloon 4WD EZD/EZH		Rod/Strut,stabiliser	S030851
6.1 (317 kw)	2005.06-2010.12	Front Axle Left Upper	Estate RWD ESF		Track Control Arm	S061705
	2005.06-2010.12	Front Axle Left Lower Outer	Estate RWD ESF		Track Control Arm	S061184
	2005.06-2010.12	Front Axle Right Upper	Estate RWD ESF		Track Control Arm	S061704
	2005.06-2010.12	Front Axle Right Lower Outer	Estate RWD ESF		Track Control Arm	S061185
	2005.06-2010.12	Front Axle Left & Right Lower Inner	Estate RWD ESF		Track Control Arm	S061176
	2005.06-2010.12	Rear Axle Left & Right Lower	Estate RWD ESF		Track Control Arm	S062034
	2005.06-2010.12	Front Axle Left & Right Lower	Estate RWD ESF		Ball Joint	S080707
	2005.06-2010.12	Front Axle Left & Right	Estate RWD ESF		Control Arm Bushing	535016
	2005.06-2010.12	Front Axle Left & Right Lower Inner	Estate RWD ESF		Control Arm Bushing	519652
	2005.06-2010.12	Front Axle Left & Right Lower Inner	Estate RWD ESF		Control Arm Bushing	519661
	2005.06-2010.12	Rear Axle Left & Right Lower Inner	Estate RWD ESF		Control Arm Bushing	530527
	2005.06-2010.12	Rear Axle Left & Right Lower Outer	Estate RWD ESF	Inner diameter:12.2mm	Control Arm Bushing	516553
	2005.06-2010.12	Front Axle Left & Right	Estate RWD ESF		Tie Rod Axle Joint	S030574
	2005.06-2010.12	Front Axle Right	Estate RWD ESF		Tie Rod End	S071271
	2005.06-2010.12	Front Axle Left & Right	Estate RWD ESF		Tie Rod End	S071013
	2005.06-2010.12	Front Axle Left	Estate RWD ESF		Rod/Strut,stabiliser	S050820
	2005.06-2010.12	Front Axle Right	Estate RWD ESF		Rod/Strut,stabiliser	S050819
	2005.06-2010.12	Front Axle Left & Right	Estate RWD ESF		Rod/Strut,stabiliser	S030851
	2005.06-2010.12	Front Axle	Estate RWD ESF		Stabiliser Bushing	516814
	2005.06-2010.12	Front Axle	Estate RWD ESF		Stabiliser Bushing	516815
2005.06-2010.12	Front Axle	Estate RWD ESF		Steering Rack Bellow Kit	540211K	
300M						
3.5 (185 kw)	1998.09-2004.09	Front Axle Left Lower	Saloon FWD EGG		Track Control Arm	S061457
	1998.09-2004.09	Front Axle Right Lower	Saloon FWD EGG		Track Control Arm	S061655
	1998.09-2004.09	Front Axle Left	Saloon FWD EGG		Tie Rod End	S071134
	1998.09-2004.09	Front Axle Right	Saloon FWD EGG		Tie Rod End	S071133
	1998.09-2004.09	Front Axle Left & Right	Saloon FWD EGG		Tie Rod End	S071009
	1998.09-2004.09	Front Axle Left & Right	Saloon FWD EGG		Rod/Strut,stabiliser	S051063
	1998.09-2004.09	Rear Axle Left & Right	Saloon FWD EGG		Rod/Strut,stabiliser	S050999



	 YEAR	FITTING POSITION	BODY STYLE & DRIVE TYPE & ENGINE	REMARKS	PRODUCT	GSP Ref.
CHRYSLER						
Grand Voyager						
3.6 (208 kw)	2011.01-	Front Axle Left Lower	MPV FWD ERB		Ball Joint	S080874
	2011.01-	Front Axle Left & Right Lower	MPV FWD ERB	Date to:2012	Control Arm Bushing	516175
	2011.01-	Front Axle Left & Right Lower	MPV FWD ERB		Control Arm Bushing	530937
	2011.01-	Rear Axle Left & Right Lower Inner	MPV FWD ERB		Control Arm Bushing	516457
	2011.01-	Front Axle Left & Right	MPV FWD ERB		Tie Rod End	S071010
	2011.01-	Front Axle Left & Right	MPV FWD ERB		Rod/Strut,stabiliser	S050095
	2011.01-	Front Axle Left & Right	MPV FWD ERB	Date to:2015	Rod/Strut,stabiliser	S051229
2011.01-	Front Axle	MPV FWD ERB		Steering Rack Bellow Kit	540211K	
Neon						
1.8 (85 kw)	1994.06-1999.12	Front Axle Left & Right	Saloon FWD EBD		Tie Rod End	S070541
	1994.06-1999.12	Front Axle Left & Right	Saloon FWD EBD		Rod/Strut,stabiliser	511307
2.0 (98 kw)	1994.06-1999.09	Front Axle Left & Right	Saloon FWD ECB		Tie Rod End	S070541
	1994.06-1999.09	Front Axle Left & Right	Saloon FWD ECB		Rod/Strut,stabiliser	511307
	1999.08-2005.09	Front Axle Left & Right Lower	Saloon FWD ECB		Ball Joint	S080030
	1999.08-2005.09	Front Axle Left & Right	Saloon FWD ECB		Tie Rod Axle Joint	S030339
	1999.08-2005.09	Front Axle Left & Right	Saloon FWD ECB		Tie Rod End	S070541
	1999.08-2005.09	Front Axle Left & Right	Saloon FWD ECB	Date to:1999	Rod/Strut,stabiliser	511307
	1999.08-2005.09	Front Axle Left & Right	Saloon FWD ECB		Rod/Strut,stabiliser	S050470
	1999.08-2005.09	Front Axle Left & Right	Saloon FWD ECB		Rod/Strut,stabiliser	S050640
2.0 (112 kw)	1994.10-1998.09	Front Axle Left & Right	Saloon FWD ECC		Tie Rod End	S070541
	1994.10-1998.09	Front Axle Left & Right	Saloon FWD ECC		Rod/Strut,stabiliser	511307
	1999.08-2002.12	Front Axle Left & Right	Saloon FWD ECH		Tie Rod Axle Joint	S030339
	1999.08-2002.12	Front Axle Left & Right	Saloon FWD ECH		Tie Rod End	S070541
	1999.08-2002.12	Front Axle Left & Right	Saloon FWD ECH		Rod/Strut,stabiliser	S050470
	1999.08-2002.12	Front Axle Left & Right	Saloon FWD ECH		Rod/Strut,stabiliser	S050640
PT Cruiser						
2.0 (100 kw)	2003.03-2004.09	Front Axle Left Lower	Estate FWD ECC		Track Control Arm	S060813
	2003.03-2004.09	Front Axle Right Lower	Estate FWD ECC		Track Control Arm	S060814
	2003.03-2004.09	Front Axle Left & Right Lower	Estate FWD ECC		Ball Joint	S080030
	2003.03-2004.09	Front Axle Left & Right Lower	Estate FWD ECC		Control Arm Bushing	511352
	2003.03-2004.09	Front Axle Left & Right	Estate FWD ECC		Tie Rod Axle Joint	S030339
	2003.03-2004.09	Front Axle Left & Right	Estate FWD ECC		Tie Rod End	S070541
	2003.03-2004.09	Front Axle Left & Right	Estate FWD ECC		Rod/Strut,stabiliser	S050470
	2003.03-2004.09	Rear Axle Left & Right	Estate FWD ECC		Rod/Strut,stabiliser	S050818
2.0 (104 kw)	2000.06-2004.09	Front Axle Left Lower	Estate FWD ECC		Track Control Arm	S060813
	2000.06-2004.09	Front Axle Right Lower	Estate FWD ECC		Track Control Arm	S060814
	2000.06-2004.09	Front Axle Left & Right Lower	Estate FWD ECC		Ball Joint	S080030
	2000.06-2004.09	Front Axle Left & Right Lower	Estate FWD ECC		Control Arm Bushing	511352
	2000.06-2004.09	Front Axle Left & Right	Estate FWD ECC		Tie Rod Axle Joint	S030339
	2000.06-2004.09	Front Axle Left & Right	Estate FWD ECC		Tie Rod End	S070541
	2000.06-2004.09	Front Axle Left & Right	Estate FWD ECC		Rod/Strut,stabiliser	S050470
	2000.06-2004.09	Rear Axle Left & Right	Estate FWD ECC		Rod/Strut,stabiliser	S050818
2.4 (110 kw)	2000.06-2010.09	Front Axle Left Lower	Estate FWD EDZ		Track Control Arm	S060813
	2000.06-2010.09	Front Axle Right Lower	Estate FWD EDZ		Track Control Arm	S060814
	2000.06-2010.09	Front Axle Left & Right Lower	Estate FWD EDZ		Ball Joint	S080030
	2000.06-2010.09	Front Axle Left & Right Lower	Estate FWD EDZ		Control Arm Bushing	511352
	2000.06-2010.09	Front Axle Left & Right	Estate FWD EDZ		Tie Rod Axle Joint	S030339
	2000.06-2010.09	Front Axle Left & Right	Estate FWD EDZ		Tie Rod End	S070541
	2000.06-2010.09	Front Axle Left & Right	Estate FWD EDZ		Rod/Strut,stabiliser	S050470
	2000.06-2010.09	Rear Axle Left & Right	Estate FWD EDZ		Rod/Strut,stabiliser	S050818
Sebring						
2.7 (149 kw)	2000.09-2007.06	Front Axle Left Upper	Saloon FWD EER/EES		Track Control Arm	S062062
	2000.09-2007.06	Front Axle Right Upper	Saloon FWD EER/EES		Track Control Arm	S062063
	2000.09-2007.06	Front Axle Left & Right Upper	Saloon FWD EER/EES		Ball Joint	S080625
	2000.09-2007.06	Front Axle Left & Right Lower	Saloon FWD EER/EES	For OE No. 4764453AA	Control Arm Bushing	532353
	2000.09-2007.06	Front Axle Left & Right Lower	Saloon FWD EER/EES	Model year from:2001,Model year to:2006	Control Arm Bushing	532354
	2000.09-2007.06	Front Axle Left & Right Lower	Saloon FWD EER/EES	532355 and 535706 different structure	Control Arm Bushing	532355
	2000.09-2007.06	Front Axle Left & Right	Saloon FWD EER/EES		Tie Rod Axle Joint	S030761
	2000.09-2007.06	Front Axle Left	Saloon FWD EER/EES		Tie Rod End	S071141
	2000.09-2007.06	Front Axle Right	Saloon FWD EER/EES		Tie Rod End	S071140
	2000.09-2007.06	Front Axle Left & Right	Saloon FWD EER/EES		Rod/Strut,stabiliser	S050737
Stratus						
2.0 (96 kw)	1996.04-2001.04	Front Axle Left Lower	Cabriolet FWD ECB		Track Control Arm	S061416
	1996.04-2001.04	Front Axle Left Upper	Cabriolet FWD ECB		Track Control Arm	S062062



	 YEAR	FITTING POSITION	BODY STYLE & DRIVE TYPE & ENGINE	REMARKS	PRODUCT	GSP Ref.	
CHRYSLER							
Stratus							
2.0 (96 kw)	1996.04-2001.04	Front Axle Right Upper	Cabriolet FWD ECB		Track Control Arm	S062063	
	1996.04-2001.04	Front Axle Left & Right Lower	Cabriolet FWD ECB	For OE No. 4764453AA	Control Arm Bushing	532353	
	1996.04-2001.04	Front Axle Left & Right Lower	Cabriolet FWD ECB	Model year from:1997,Model year to:2001	Control Arm Bushing	532354	
	1996.04-2001.04	Front Axle Left	Cabriolet FWD ECB		Tie Rod End	S071141	
	1996.04-2001.04	Front Axle Right	Cabriolet FWD ECB		Tie Rod End	S071140	
2.0 (98 kw)	1995.12-2000.09	Front Axle Left Lower	Saloon FWD ECB		Track Control Arm	S061416	
	1995.12-2000.09	Front Axle Left Upper	Saloon FWD ECB		Track Control Arm	S062062	
	1995.12-2000.09	Front Axle Right Lower	Saloon FWD ECB		Track Control Arm	S061415	
	1995.12-2000.09	Front Axle Right Upper	Saloon FWD ECB		Track Control Arm	S062063	
	1995.12-2000.09	Front Axle Left & Right Upper	Saloon FWD ECB		Ball Joint	S080625	
	1995.12-2000.09	Front Axle Left & Right Lower	Saloon FWD ECB	For OE No. 4764453AA	Control Arm Bushing	532353	
	1995.12-2000.09	Front Axle Left & Right Lower	Saloon FWD ECB	Model year from:1997,Model year to:2001	Control Arm Bushing	532354	
	1995.12-2000.09	Front Axle Left & Right	Saloon FWD ECB		Tie Rod Axle Joint	S030761	
	1995.12-2000.09	Front Axle Left	Saloon FWD ECB		Tie Rod End	S071141	
	1995.12-2000.09	Front Axle Right	Saloon FWD ECB		Tie Rod End	S071140	
	1995.12-2000.09	Front Axle Left & Right	Saloon FWD ECB		Tie Rod End	S070824	
	2.5 (120 kw)	1995.12-2001.04	Front Axle Left Lower	Saloon FWD EEB		Track Control Arm	S061416
		1995.12-2001.04	Front Axle Left Upper	Saloon FWD EEB		Track Control Arm	S062062
1995.12-2001.04		Front Axle Right Lower	Saloon FWD EEB		Track Control Arm	S061415	
1995.12-2001.04		Front Axle Right Upper	Saloon FWD EEB		Track Control Arm	S062063	
1995.12-2001.04		Front Axle Left & Right Upper	Saloon FWD EEB		Ball Joint	S080625	
1995.12-2001.04		Front Axle Left & Right Lower	Saloon FWD EEB	For OE No. 4764453AA	Control Arm Bushing	532353	
1995.12-2001.04		Front Axle Left & Right Lower	Saloon FWD EEB	Model year from:1997,Model year to:2001	Control Arm Bushing	532354	
1995.12-2001.04		Front Axle Left & Right	Saloon FWD EEB		Tie Rod Axle Joint	S030761	
1995.12-2001.04		Front Axle Left	Saloon FWD EEB		Tie Rod End	S071141	
1995.12-2001.04		Front Axle Right	Saloon FWD EEB		Tie Rod End	S071140	
1996.04-2000.09		Front Axle Left Lower	Cabriolet FWD EEB		Track Control Arm	S061416	
1996.04-2000.09		Front Axle Left Upper	Cabriolet FWD EEB		Track Control Arm	S062062	
1996.04-2000.09		Front Axle Right Lower	Cabriolet FWD EEB		Track Control Arm	S061415	
1996.04-2000.09		Front Axle Right Upper	Cabriolet FWD EEB		Track Control Arm	S062063	
1996.04-2000.09		Front Axle Left & Right Upper	Cabriolet FWD EEB		Ball Joint	S080625	
1996.04-2000.09		Front Axle Left & Right Lower	Cabriolet FWD EEB	For OE No. 4764453AA	Control Arm Bushing	532353	
1996.04-2000.09		Front Axle Left & Right Lower	Cabriolet FWD EEB	Model year from:1997,Model year to:2001	Control Arm Bushing	532354	
1996.04-2000.09		Front Axle Left	Cabriolet FWD EEB		Tie Rod End	S071141	
1996.04-2000.09		Front Axle Right	Cabriolet FWD EEB		Tie Rod End	S071140	
Town & Country							
3.8 (148 kw)	2007.06-	Front Axle Left & Right Lower	MPV FWD EGL		Control Arm Bushing	516175	
	2007.06-	Rear Axle Left & Right Lower Inner	MPV FWD EGL		Control Arm Bushing	516457	
	2007.06-	Front Axle Left & Right	MPV FWD EGL		Rod/Strut, stabiliser	S051229	
CITROËN							
AX							
1.4 (74 kw)	1991.06-1992.12	Front Axle Left Lower	Hatchback FWD TU3FJ2		Track Control Arm	S060397	
	1991.06-1992.12	Front Axle Right Lower	Hatchback FWD TU3FJ2		Track Control Arm	S060396	
	1991.06-1992.12	Front Axle Left & Right Lower	Hatchback FWD TU3FJ2		Ball Joint	S080045	
	1991.06-1992.12	Front Axle Left	Hatchback FWD TU3FJ2		Tie Rod End	S070105	
	1991.06-1992.12	Front Axle Right	Hatchback FWD TU3FJ2		Tie Rod End	S070106	
	1991.06-1992.12	Front Axle Left & Right Inner	Hatchback FWD TU3FJ2		Stabiliser Bushing	512499	
	1991.06-1992.12	Front Axle Left & Right Outer	Hatchback FWD TU3FJ2		Stabiliser Bushing	533444	
Berlingo							
1.6 (81 kw)	2005.08-2008.03	Front Axle Left Lower	MPV Van FWD TU5JP4	Org.No.to:7973	Track Control Arm	S060372	
	2005.08-2008.03	Front Axle Left Lower	MPV Van FWD TU5JP4	for vehicles with heavy duty suspension	Track Control Arm	S060376	
	2005.08-2008.03	Front Axle Left Lower	MPV Van FWD TU5JP4	for vehicles with power steering,for vehicles without power steering	Track Control Arm	S063016	
	2005.08-2008.03	Front Axle Right Lower	MPV Van FWD TU5JP4		Track Control Arm	S060373	
	2005.08-2008.03	Front Axle Right Lower	MPV Van FWD TU5JP4		Track Control Arm	S060373B	
	2005.08-2008.03	Front Axle Right Lower	MPV Van FWD TU5JP4	for vehicles with heavy duty suspension	Track Control Arm	S060377	
	2005.08-2008.03	Front Axle Right Lower	MPV Van FWD TU5JP4	04-18 inch for vehicles with power steering,for vehicles without power steering	Track Control Arm	S063017	
	2005.08-2008.03	Front Axle Left & Right Lower	MPV Van FWD TU5JP4	Org.No from 07973,for vehicles with standard suspension	Ball Joint	S080031	
	2005.08-2008.03	Front Axle Left & Right Lower	MPV Van FWD TU5JP4	Org.No.to:07972,for vehicles with standard suspension	Ball Joint	S080033	
	2005.08-2008.03	Front Axle Left & Right Lower	MPV Van FWD TU5JP4		Control Arm Bushing	510689	
	2005.08-2008.03	Front Axle Left & Right Lower	MPV Van FWD TU5JP4		Control Arm Bushing	510690	
	2005.08-2008.03	Front Axle Left & Right Lower	MPV Van FWD TU5JP4		Control Arm Bushing	511908	
	2005.08-2008.03	Front Axle Left & Right	MPV Van FWD TU5JP4		Tie Rod Axle Joint	S030021	
	2005.08-2008.03	Front Axle Left & Right	MPV Van FWD TU5JP4		Tie Rod End	S070104	
	2005.08-2008.03	Front Axle Left & Right	MPV Van FWD TU5JP4		Rod/Strut, stabiliser	S050115	



	 YEAR	FITTING POSITION	BODY STYLE & DRIVE TYPE & ENGINE	REMARKS	PRODUCT	GSP Ref.
CITROËN						
Berlingo						
1.6 (81 kw)	2005.08-2008.03	Front Axle	MPV Van FWD TU5JP4		Stabiliser Bushing	512500
	2005.08-2008.03	Front Axle	MPV Van FWD TU5JP4		Steering Boot	540061
	2005.08-2008.03	Front Axle	MPV Van FWD TU5JP4		Steering Boot	540332
	2005.08-2008.03	Front Axle	MPV Van FWD TU5JP4		Steering Boot	540414
	2005.08-2008.03	Front Axle Left	MPV Van FWD TU5JP4	for vehicles without power steering	Steering Rack Bellow Kit	540061S
	2005.08-2008.03	Front Axle Left	MPV Van FWD TU5JP4	for vehicles with power steering,More information	Steering Rack Bellow Kit	540332S
1.8 (66 kw)	1997.08-2002.10	Front Axle Left Lower	MPV Van FWD XU7JB	Org.No.to:7973	Track Control Arm	S060372
	1997.08-2002.10	Front Axle Left Lower	MPV Van FWD XU7JB		Track Control Arm	S060372B
	1997.08-2002.10	Front Axle Left Lower	MPV Van FWD XU7JB	for vehicles with heavy duty suspension	Track Control Arm	S060376
	1997.08-2002.10	Front Axle Left Lower	MPV Van FWD XU7JB	for vehicles with power steering,for vehicles without power steering	Track Control Arm	S063016
	1997.08-2002.10	Front Axle Right Lower	MPV Van FWD XU7JB		Track Control Arm	S060373
	1997.08-2002.10	Front Axle Right Lower	MPV Van FWD XU7JB		Track Control Arm	S060373B
	1997.08-2002.10	Front Axle Right Lower	MPV Van FWD XU7JB	for vehicles with heavy duty suspension	Track Control Arm	S060377
	1997.08-2002.10	Front Axle Right Lower	MPV Van FWD XU7JB	D4-18 mm,for vehicles with power steering,for vehicles without power steering	Track Control Arm	S063017
	1997.08-2002.10	Front Axle Left & Right Lower	MPV Van FWD XU7JB	Org.No.from:07973,for vehicles with standard suspension	Ball Joint	S080031
	1997.08-2002.10	Front Axle Left & Right Lower	MPV Van FWD XU7JB	Org.No.to:07972,for vehicles with standard suspension	Ball Joint	S080033
	1997.08-2002.10	Front Axle Left & Right Lower	MPV Van FWD XU7JB		Control Arm Bushing	510689
	1997.08-2002.10	Front Axle Left & Right Lower	MPV Van FWD XU7JB		Control Arm Bushing	510690
	1997.08-2002.10	Front Axle Left & Right Lower	MPV Van FWD XU7JB		Control Arm Bushing	511908
	1997.08-2002.10	Front Axle Left & Right	MPV Van FWD XU7JB		Tie Rod Axle Joint	S030021
	1997.08-2002.10	Front Axle Left & Right	MPV Van FWD XU7JB		Tie Rod End	S070104
	1997.08-2002.10	Front Axle Left & Right	MPV Van FWD XU7JB		Rod/Strut,stabiliser	S050115
	1997.08-2002.10	Front Axle	MPV Van FWD XU7JB		Stabiliser Bushing	512500
	1997.08-2002.10	Front Axle	MPV Van FWD XU7JB		Steering Boot	540061
	1997.08-2002.10	Front Axle	MPV Van FWD XU7JB		Steering Boot	540332
	1997.08-2002.10	Front Axle	MPV Van FWD XU7JB		Steering Boot	540414
	1997.08-2002.10	Front Axle Left	MPV Van FWD XU7JB	for vehicles without power steering	Steering Rack Bellow Kit	540061S
	1997.08-2002.10	Front Axle Left	MPV Van FWD XU7JB	for vehicles with power steering,More information	Steering Rack Bellow Kit	540332S
BX						
1.6 (65 kw)	1989.05-1993.02	Front Axle Left & Right Lower	Hatchback FWD BDY/BDZ		Ball Joint	S080048
C2						
1.6 (90 kw)	2004.10-2009.12	Front Axle Left Lower	Hatchback FWD TU5JP4S		Track Control Arm	S060130
	2004.10-2009.12	Front Axle Right Lower	Hatchback FWD TU5JP4S		Track Control Arm	S060129
	2004.10-2009.12	Front Axle Left & Right Lower	Hatchback FWD TU5JP4S		Ball Joint	S080032
	2004.10-2009.12	Front Axle Left & Right Lower	Hatchback FWD TU5JP4S		Control Arm Bushing	511915
	2004.10-2009.12	Front Axle Left & Right Lower	Hatchback FWD TU5JP4S		Control Arm Bushing	511916
	2004.10-2009.12	Front Axle Left & Right Lower	Hatchback FWD TU5JP4S		Control Arm Bushing	513910
	2004.10-2009.12	Front Axle Left & Right	Hatchback FWD TU5JP4S		Tie Rod Axle Joint	S030028
	2004.10-2009.12	Front Axle Left	Hatchback FWD TU5JP4S		Tie Rod End	S070080
	2004.10-2009.12	Front Axle Right	Hatchback FWD TU5JP4S		Tie Rod End	S070079
	2004.10-2009.12	Front Axle Left & Right	Hatchback FWD TU5JP4S		Rod/Strut,stabiliser	S050111
	2004.10-2009.12	Front Axle	Hatchback FWD TU5JP4S		Stabiliser Bushing	533521
C3						
1.4 (54 kw)	2002.02-2009.12	Front Axle Left Lower	Hatchback FWD TU3A/TU3JP		Track Control Arm	S060130
	2002.02-2009.12	Front Axle Right Lower	Hatchback FWD TU3A/TU3JP		Track Control Arm	S060129
	2002.02-2009.12	Front Axle Left & Right Lower	Hatchback FWD TU3A/TU3JP		Ball Joint	S080032
	2002.02-2009.12	Front Axle Left & Right Lower	Hatchback FWD TU3A/TU3JP		Control Arm Bushing	510690
	2002.02-2009.12	Front Axle Left & Right Lower	Hatchback FWD TU3A/TU3JP		Control Arm Bushing	511915
	2002.02-2009.12	Front Axle Left & Right Lower	Hatchback FWD TU3A/TU3JP		Control Arm Bushing	511916
	2002.02-2009.12	Front Axle Left & Right Lower	Hatchback FWD TU3A/TU3JP		Control Arm Bushing	513910
	2002.02-2009.12	Front Axle Left & Right	Hatchback FWD TU3A/TU3JP		Tie Rod Axle Joint	S030028
	2002.02-2009.12	Front Axle Left	Hatchback FWD TU3A/TU3JP		Tie Rod End	S070080
	2002.02-2009.12	Front Axle Right	Hatchback FWD TU3A/TU3JP		Tie Rod End	S070079
	2002.02-2009.12	Front Axle Left & Right	Hatchback FWD TU3A/TU3JP		Rod/Strut,stabiliser	S050111
	2002.02-2009.12	Front Axle	Hatchback FWD TU3A/TU3JP		Stabiliser Bushing	531775
	2002.02-2009.12	Front Axle	Hatchback FWD TU3A/TU3JP		Stabiliser Bushing	533521
1.6 (80 kw)	2002.02-2010.08	Front Axle Left Lower	Hatchback FWD TU5JP4		Track Control Arm	S060130
	2002.02-2010.08	Front Axle Right Lower	Hatchback FWD TU5JP4		Track Control Arm	S060129
	2002.02-2010.08	Front Axle Left & Right Lower	Hatchback FWD TU5JP4		Ball Joint	S080032
	2002.02-2010.08	Front Axle Left & Right Lower	Hatchback FWD TU5JP4		Control Arm Bushing	510690
	2002.02-2010.08	Front Axle Left & Right Lower	Hatchback FWD TU5JP4		Control Arm Bushing	511915
	2002.02-2010.08	Front Axle Left & Right Lower	Hatchback FWD TU5JP4		Control Arm Bushing	511916
	2002.02-2010.08	Front Axle Left & Right Lower	Hatchback FWD TU5JP4		Control Arm Bushing	513910
	2002.02-2010.08	Front Axle Left & Right	Hatchback FWD TU5JP4		Tie Rod Axle Joint	S030028



	 YEAR	FITTING POSITION	BODY STYLE & DRIVE TYPE & ENGINE	REMARKS	PRODUCT	GSP Ref.
CITROËN C3						
1.6 (80 kw)	2002.02-2010.08	Front Axle Left	Hatchback FWD TU5JP4		Tie Rod End	S070080
	2002.02-2010.08	Front Axle Right	Hatchback FWD TU5JP4		Tie Rod End	S070079
	2002.02-2010.08	Front Axle Left & Right	Hatchback FWD TU5JP4		Rod/Strut, stabiliser	S050111
	2002.02-2010.08	Front Axle	Hatchback FWD TU5JP4		Stabiliser Bushing	531775
	2002.02-2010.08	Front Axle	Hatchback FWD TU5JP4		Stabiliser Bushing	533521
1.6 (81 kw)	2002.04-2010.08	Front Axle Left Lower	Hatchback FWD TU5JP4		Track Control Arm	S060130
	2002.04-2010.08	Front Axle Right Lower	Hatchback FWD TU5JP4		Track Control Arm	S060129
	2002.04-2010.08	Front Axle Left & Right Lower	Hatchback FWD TU5JP4		Ball Joint	S080032
	2002.04-2010.08	Front Axle Left & Right Lower	Hatchback FWD TU5JP4		Control Arm Bushing	510690
	2002.04-2010.08	Front Axle Left & Right Lower	Hatchback FWD TU5JP4		Control Arm Bushing	511915
	2002.04-2010.08	Front Axle Left & Right Lower	Hatchback FWD TU5JP4		Control Arm Bushing	511916
	2002.04-2010.08	Front Axle Left & Right Lower	Hatchback FWD TU5JP4		Control Arm Bushing	513910
	2002.04-2010.08	Front Axle Left & Right	Hatchback FWD TU5JP4		Tie Rod Axle Joint	S030028
	2002.04-2010.08	Front Axle Left	Hatchback FWD TU5JP4		Tie Rod End	S070080
	2002.04-2010.08	Front Axle Right	Hatchback FWD TU5JP4		Tie Rod End	S070079
	2002.04-2010.08	Front Axle Left & Right	Hatchback FWD TU5JP4		Tie Rod End	S070866
	2002.04-2010.08	Front Axle Left & Right	Hatchback FWD TU5JP4		Rod/Strut, stabiliser	S050111
	2002.04-2010.08	Front Axle	Hatchback FWD TU5JP4		Stabiliser Bushing	531775
	2002.04-2010.08	Front Axle	Hatchback FWD TU5JP4		Stabiliser Bushing	533521
	1.6 (83 kw)	2005.06-2013.12	Front Axle Left & Right Lower	Hatchback FWD TU5JP4		Control Arm Bushing
2005.06-2013.12		Front Axle Left & Right	Hatchback FWD TU5JP4		Tie Rod End	S070824
2005.06-2013.12		Front Axle Left & Right	Hatchback FWD TU5JP4		Tie Rod End	S070866
2005.06-2013.12		Front Axle	Hatchback FWD TU5JP4		Stabiliser Bushing	533521
C4						
2.0 (103 kw)	2006.10-2007.12	Front Axle Left Lower	Coupe FWD EW10A		Track Control Arm	S060146
	2006.10-2007.12	Front Axle Right Lower	Coupe FWD EW10A		Track Control Arm	S060145
	2006.10-2007.12	Front Axle Left & Right Lower	Coupe FWD EW10A		Ball Joint	S080040
	2006.10-2007.12	Front Axle Left & Right Lower	Coupe FWD EW10A		Control Arm Bushing	510682
	2006.10-2007.12	Front Axle Left & Right Lower	Coupe FWD EW10A		Control Arm Bushing	511919
	2006.10-2007.12	Front Axle Left & Right	Coupe FWD EW10A		Tie Rod Axle Joint	S030022
	2006.10-2007.12	Front Axle Left & Right	Coupe FWD EW10A		Tie Rod End	S070104
	2006.10-2007.12	Front Axle Left & Right	Coupe FWD EW10A		Rod/Strut, stabiliser	S050109
	2006.10-2007.12	Front Axle	Coupe FWD EW10A		Stabiliser Bushing	530846
	2006.10-2007.12	Front Axle	Coupe FWD EW10A		Steering Boot	540190
2006.10-2007.12	Front Axle	Coupe FWD EW10A		Steering Rack Bellow Kit	540190S	
C4 Grand Picasso						
1.6 (121 kw)	2014.07-	Front Axle Left Lower	MPV FWD EP6FDT/EP6FDTM		Track Control Arm	S062835
	2014.07-	Front Axle Left Lower	MPV FWD EP6FDT/EP6FDTM		Track Control Arm	S062841
	2014.07-	Front Axle Right Lower	MPV FWD EP6FDT/EP6FDTM		Track Control Arm	S062836
	2014.07-	Front Axle Right Lower	MPV FWD EP6FDT/EP6FDTM		Track Control Arm	S062843
	2014.07-	Front Axle Left & Right Lower	MPV FWD EP6FDT/EP6FDTM		Ball Joint	S080988
	2014.07-	Front Axle Left & Right Lower	MPV FWD EP6FDT/EP6FDTM	Bushings for S062835	Control Arm Bushing	533520
	2014.07-	Front Axle Left & Right Lower	MPV FWD EP6FDT/EP6FDTM	Bushings for S062835	Control Arm Bushing	535395
	2014.07-	Front Axle Left & Right	MPV FWD EP6FDT/EP6FDTM		Tie Rod Axle Joint	S030709
	2014.07-	Front Axle Left	MPV FWD EP6FDT/EP6FDTM		Tie Rod End	S071654
	2014.07-	Front Axle Right	MPV FWD EP6FDT/EP6FDTM		Tie Rod End	S071639
	2014.07-	Front Axle Left & Right	MPV FWD EP6FDT/EP6FDTM		Rod/Strut, stabiliser	S050109
	2.0 (103 kw)	2007.02-2013.08	Front Axle Left Lower	MPV FWD EW10A		Track Control Arm
2007.02-2013.08		Front Axle Right Lower	MPV FWD EW10A		Track Control Arm	S060145
2007.02-2013.08		Front Axle Left & Right Lower	MPV FWD EW10A		Ball Joint	S080040
2007.02-2013.08		Front Axle Left & Right Lower	MPV FWD EW10A		Control Arm Bushing	510682
2007.02-2013.08		Front Axle Left & Right Lower	MPV FWD EW10A		Control Arm Bushing	511919
2007.02-2013.08		Front Axle Left & Right	MPV FWD EW10A		Tie Rod Axle Joint	S030025
2007.02-2013.08		Front Axle Left	MPV FWD EW10A		Tie Rod End	S070092
2007.02-2013.08		Front Axle Right	MPV FWD EW10A		Tie Rod End	S070093
2007.02-2013.08		Front Axle Left & Right	MPV FWD EW10A		Rod/Strut, stabiliser	S050109
2007.02-2013.08		Front Axle	MPV FWD EW10A		Stabiliser Bushing	530846
2.0 (105 kw)	2008.05-2013.08	Front Axle Left Lower	MPV FWD EW10A		Track Control Arm	S060146
	2008.05-2013.08	Front Axle Right Lower	MPV FWD EW10A		Track Control Arm	S060145
	2008.05-2013.08	Front Axle Left & Right Lower	MPV FWD EW10A		Ball Joint	S080040
	2008.05-2013.08	Front Axle Left & Right Lower	MPV FWD EW10A		Control Arm Bushing	510682
	2008.05-2013.08	Front Axle Left & Right Lower	MPV FWD EW10A		Control Arm Bushing	511919
	2008.05-2013.08	Front Axle Left & Right	MPV FWD EW10A		Tie Rod Axle Joint	S030025
	2008.05-2013.08	Front Axle Left	MPV FWD EW10A		Tie Rod End	S070092



	 YEAR	FITTING POSITION	BODY STYLE & DRIVE TYPE & ENGINE	REMARKS	PRODUCT	GSP Ref.
CITROËN						
C4 Grand Picasso						
2.0 (105 kw)	2008.05-2013.08	Front Axle Right	MPV FWD EW10A		Tie Rod End	S070093
	2008.05-2013.08	Front Axle Left & Right	MPV FWD EW10A		Rod/Strut, stabiliser	S050109
	2008.05-2013.08	Front Axle	MPV FWD EW10A		Stabiliser Bushing	530846
C4 Picasso						
1.6 (121 kw)	2014.07-	Front Axle Left Lower	MPV FWD EP6FDT/EP6FDTM		Track Control Arm	S062835
	2014.07-	Front Axle Left Lower	MPV FWD EP6FDT/EP6FDTM		Track Control Arm	S062841
	2014.07-	Front Axle Right Lower	MPV FWD EP6FDT/EP6FDTM		Track Control Arm	S062836
	2014.07-	Front Axle Right Lower	MPV FWD EP6FDT/EP6FDTM		Track Control Arm	S062843
	2014.07-	Front Axle Left & Right Lower	MPV FWD EP6FDT/EP6FDTM		Ball Joint	S080988
	2014.07-	Front Axle Left & Right Lower	MPV FWD EP6FDT/EP6FDTM	Bushings for S062835	Control Arm Bushing	533520
	2014.07-	Front Axle Left & Right Lower	MPV FWD EP6FDT/EP6FDTM	Bushings for S062835	Control Arm Bushing	535395
	2014.07-	Front Axle Left & Right	MPV FWD EP6FDT/EP6FDTM		Tie Rod Axle Joint	S030709
	2014.07-	Front Axle Left	MPV FWD EP6FDT/EP6FDTM		Tie Rod End	S071654
	2014.07-	Front Axle Right	MPV FWD EP6FDT/EP6FDTM		Tie Rod End	S071639
	2014.07-	Front Axle Left & Right	MPV FWD EP6FDT/EP6FDTM		Rod/Strut, stabiliser	S050109
2.0 (105 kw)	2008.05-2015.12	Front Axle Left & Right	MPV FWD EW10A		Rod/Strut, stabiliser	S050109
C5						
2.0 (100 kw)	2000.10-2004.08	Front Axle Left Lower	Hatchback FWD EW10J4		Track Control Arm	S060132
	2000.10-2004.08	Front Axle Right Lower	Hatchback FWD EW10J4		Track Control Arm	S060131
	2000.10-2004.08	Front Axle Left & Right Lower	Hatchback FWD EW10J4		Ball Joint	S080044
	2000.10-2004.08	Front Axle Left & Right Lower	Hatchback FWD EW10J4		Control Arm Bushing	510731
	2000.10-2004.08	Front Axle Left & Right	Hatchback FWD EW10J4		Tie Rod Axle Joint	S030018
	2000.10-2004.08	Front Axle Left	Hatchback FWD EW10J4		Tie Rod End	S070082
	2000.10-2004.08	Front Axle Right	Hatchback FWD EW10J4		Tie Rod End	S070081
	2000.10-2004.08	Front Axle Left & Right	Hatchback FWD EW10J4	Date from:2004.03,From ORG/OPR: 09950	Rod/Strut, stabiliser	S050107
	2000.10-2004.08	Front Axle Left & Right	Hatchback FWD EW10J4	Date from:2004.03,RPO no.from:09950	Rod/Strut, stabiliser	S051229
	2000.10-2004.08	Front Axle	Hatchback FWD EW10J4		Steering Boot	540205
	2000.10-2004.08	Front Axle	Hatchback FWD EW10J4		Steering Rack Bellow Kit	541149S
2.0 (103 kw)	2004.09-2008.08	Front Axle Left Lower	Hatchback FWD EW10A		Track Control Arm	S060132
	2004.09-2008.08	Front Axle Right Lower	Hatchback FWD EW10A		Track Control Arm	S060131
	2004.09-2008.08	Front Axle Left & Right Lower	Hatchback FWD EW10A		Ball Joint	S080044
	2004.09-2008.08	Front Axle Left & Right Lower	Hatchback FWD EW10A		Control Arm Bushing	510731
	2004.09-2008.08	Front Axle Left & Right	Hatchback FWD EW10A		Tie Rod Axle Joint	S030018
	2004.09-2008.08	Front Axle Left	Hatchback FWD EW10A		Tie Rod End	S070082
	2004.09-2008.08	Front Axle Right	Hatchback FWD EW10A		Tie Rod End	S070081
	2004.09-2008.08	Front Axle Left & Right	Hatchback FWD EW10A		Rod/Strut, stabiliser	S050107
	2004.09-2008.08	Front Axle Left & Right	Hatchback FWD EW10A		Rod/Strut, stabiliser	S051229
	2004.09-2008.08	Front Axle	Hatchback FWD EW10A		Steering Boot	540205
	2004.09-2008.08	Front Axle	Hatchback FWD EW10A		Steering Rack Bellow Kit	541149S
	2008.02-	Rear Axle Left & Right Lower Inner	Saloon FWD EW10A		Track Control Arm	S062950
	2008.02-	Rear Axle Left & Right Lower Outer	Saloon FWD EW10A		Track Control Arm	S062954
	2008.02-	Front Axle Left & Right Lower	Saloon FWD EW10A		Ball Joint	S080042
	2008.02-	Front Axle Left & Right Upper	Saloon FWD EW10A		Ball Joint	S080043
	2008.02-	Front Axle Left & Right Lower	Saloon FWD EW10A		Control Arm Bushing	510724
	2008.02-	Front Axle Left & Right Lower	Saloon FWD EW10A		Control Arm Bushing	517484
	2008.02-	Rear Axle Left & Right Upper	Saloon FWD EW10A		Control Arm Bushing	532978
	2008.02-	Front Axle Left & Right Lower	Saloon FWD EW10A		Control Arm Bushing Kit	532626S
	2008.02-	Front Axle Left & Right	Saloon FWD EW10A		Tie Rod Axle Joint	S030360
	2008.02-	Front Axle Left	Saloon FWD EW10A		Tie Rod End	S070559
	2008.02-	Front Axle Right	Saloon FWD EW10A		Tie Rod End	S070560
	2008.02-	Front Axle Left	Saloon FWD EW10A		Rod/Strut, stabiliser	S050112
	2008.02-	Front Axle Right	Saloon FWD EW10A		Rod/Strut, stabiliser	S050113
	2008.02-	Rear Axle Left & Right	Saloon FWD EW10A		Rod/Strut, stabiliser	S050114
3.0 (152 kw)	2000.10-2004.08	Front Axle Left Lower	Hatchback FWD ES9J4S		Track Control Arm	S060132
	2000.10-2004.08	Front Axle Right Lower	Hatchback FWD ES9J4S		Track Control Arm	S060131
	2000.10-2004.08	Front Axle Left & Right Lower	Hatchback FWD ES9J4S		Ball Joint	S080044
	2000.10-2004.08	Front Axle Left & Right Lower	Hatchback FWD ES9J4S		Control Arm Bushing	510731
	2000.10-2004.08	Front Axle Left & Right	Hatchback FWD ES9J4S		Tie Rod Axle Joint	S030018
	2000.10-2004.08	Front Axle Left	Hatchback FWD ES9J4S		Tie Rod End	S070082
	2000.10-2004.08	Front Axle Right	Hatchback FWD ES9J4S		Tie Rod End	S070081
	2000.10-2004.08	Front Axle Left & Right	Hatchback FWD ES9J4S		Rod/Strut, stabiliser	S050107
	2000.10-2004.08	Front Axle Left & Right	Hatchback FWD ES9J4S	Date from:2004.03,RPO no.from:09950	Rod/Strut, stabiliser	S051229
	2000.10-2004.08	Front Axle	Hatchback FWD ES9J4S		Steering Boot	540205
	2000.10-2004.08	Front Axle	Hatchback FWD ES9J4S		Steering Rack Bellow Kit	541149S



	 YEAR	FITTING POSITION	BODY STYLE & DRIVE TYPE & ENGINE	REMARKS	PRODUCT	GSP Ref.	
CITROËN							
C5							
3.0 (155 kw)	2004.10-2007.04	Front Axle Left Lower	Hatchback FWD ES9A		Track Control Arm	S060132	
	2004.10-2007.04	Front Axle Right Lower	Hatchback FWD ES9A		Track Control Arm	S060131	
	2004.10-2007.04	Front Axle Left & Right Lower	Hatchback FWD ES9A		Ball Joint	S080044	
	2004.10-2007.04	Front Axle Left & Right Lower	Hatchback FWD ES9A		Control Arm Bushing	510731	
	2004.10-2007.04	Front Axle Left & Right	Hatchback FWD ES9A		Tie Rod Axle Joint	S030018	
	2004.10-2007.04	Front Axle Left	Hatchback FWD ES9A		Tie Rod End	S070082	
	2004.10-2007.04	Front Axle Right	Hatchback FWD ES9A		Tie Rod End	S070081	
	2004.10-2007.04	Front Axle Left & Right	Hatchback FWD ES9A		Rod/Strut,stabiliser	S050107	
	2004.10-2007.04	Front Axle	Hatchback FWD ES9A		Steering Rack Bellow Kit	541149S	
C5 Estate/Break							
2.0 (100 kw)	2001.06-2004.09	Front Axle Left Lower	Estate FWD EW10J4		Track Control Arm	S060132	
	2001.06-2004.09	Front Axle Right Lower	Estate FWD EW10J4		Track Control Arm	S060131	
	2001.06-2004.09	Front Axle Left & Right Lower	Estate FWD EW10J4		Ball Joint	S080044	
	2001.06-2004.09	Front Axle Left & Right Lower	Estate FWD EW10J4		Control Arm Bushing	510731	
	2001.06-2004.09	Front Axle Left & Right	Estate FWD EW10J4		Tie Rod Axle Joint	S030018	
	2001.06-2004.09	Front Axle Left	Estate FWD EW10J4		Tie Rod End	S070082	
	2001.06-2004.09	Front Axle Right	Estate FWD EW10J4		Tie Rod End	S070081	
	2001.06-2004.09	Front Axle Left & Right	Estate FWD EW10J4		Rod/Strut,stabiliser	S050107	
	2001.06-2004.09	Front Axle Left & Right	Estate FWD EW10J4	Date from:2004.03.RPO no.from:09950	Rod/Strut,stabiliser	S051229	
	2001.06-2004.09	Front Axle	Estate FWD EW10J4		Steering Boot	540205	
	2001.06-2004.09	Front Axle	Estate FWD EW10J4		Steering Rack Bellow Kit	541149S	
2.0 (103 kw)	2004.09-2008.01	Front Axle Left Lower	Estate FWD EW10A		Track Control Arm	S060132	
	2004.09-2008.01	Front Axle Right Lower	Estate FWD EW10A		Track Control Arm	S060131	
	2004.09-2008.01	Front Axle Left & Right Lower	Estate FWD EW10A		Ball Joint	S080044	
	2004.09-2008.01	Front Axle Left & Right Lower	Estate FWD EW10A		Control Arm Bushing	510731	
	2004.09-2008.01	Front Axle Left & Right	Estate FWD EW10A		Tie Rod Axle Joint	S030018	
	2004.09-2008.01	Front Axle Left	Estate FWD EW10A		Tie Rod End	S070082	
	2004.09-2008.01	Front Axle Right	Estate FWD EW10A		Tie Rod End	S070081	
	2004.09-2008.01	Front Axle Left & Right	Estate FWD EW10A		Rod/Strut,stabiliser	S050107	
	2004.09-2008.01	Front Axle Left & Right	Estate FWD EW10A	Date to:2008.01	Rod/Strut,stabiliser	S051229	
	2004.09-2008.01	Front Axle	Estate FWD EW10A		Steering Boot	540205	
	2004.09-2008.01	Front Axle	Estate FWD EW10A		Steering Rack Bellow Kit	541149S	
	2008.02-	Rear Axle Left & Right Lower Inner	Estate FWD EW10A		Track Control Arm	S062950	
	2008.02-	Rear Axle Left & Right Lower Outer	Estate FWD EW10A		Track Control Arm	S062954	
	2008.02-	Front Axle Left & Right Lower	Estate FWD EW10A		Ball Joint	S080042	
	2008.02-	Front Axle Left & Right Upper	Estate FWD EW10A		Ball Joint	S080043	
	2008.02-	Front Axle Left & Right Lower	Estate FWD EW10A		Control Arm Bushing	510724	
	2008.02-	Front Axle Left & Right Lower	Estate FWD EW10A		Control Arm Bushing	517484	
	2008.02-	Rear Axle Left & Right Upper	Estate FWD EW10A		Control Arm Bushing	532978	
	2008.02-	Front Axle Left & Right Lower	Estate FWD EW10A		Control Arm Bushing Kit	532626S	
	2008.02-	Front Axle Left & Right	Estate FWD EW10A		Tie Rod Axle Joint	S030360	
	2008.02-	Front Axle Left	Estate FWD EW10A		Tie Rod End	S070559	
	2008.02-	Front Axle Right	Estate FWD EW10A		Tie Rod End	S070560	
	2008.02-	Front Axle Left	Estate FWD EW10A		Rod/Strut,stabiliser	S050112	
	2008.02-	Front Axle Right	Estate FWD EW10A		Rod/Strut,stabiliser	S050113	
	2008.02-	Rear Axle Left & Right	Estate FWD EW10A		Rod/Strut,stabiliser	S050114	
	3.0 (155 kw)	2004.10-2007.04	Front Axle Left Lower	Estate FWD ES9A		Track Control Arm	S060132
		2004.10-2007.04	Front Axle Right Lower	Estate FWD ES9A		Track Control Arm	S060131
		2004.10-2007.04	Front Axle Left & Right Lower	Estate FWD ES9A		Ball Joint	S080044
		2004.10-2007.04	Front Axle Left & Right Lower	Estate FWD ES9A		Control Arm Bushing	510731
		2004.10-2007.04	Front Axle Left & Right	Estate FWD ES9A		Tie Rod Axle Joint	S030018
		2004.10-2007.04	Front Axle Left	Estate FWD ES9A		Tie Rod End	S070082
		2004.10-2007.04	Front Axle Right	Estate FWD ES9A		Tie Rod End	S070081
2004.10-2007.04		Front Axle Left & Right	Estate FWD ES9A		Rod/Strut,stabiliser	S050107	
2004.10-2007.04		Front Axle Left & Right	Estate FWD ES9A		Rod/Strut,stabiliser	S051229	
2004.10-2007.04		Front Axle	Estate FWD ES9A		Steering Rack Bellow Kit	541149S	
C6							
3.0 (155 kw)	2005.08-2012.12	Rear Axle Left & Right Lower Inner	Saloon FWD ES9A		Track Control Arm	S062950	
	2005.08-2012.12	Rear Axle Left & Right Lower Outer	Saloon FWD ES9A		Track Control Arm	S062954	
	2005.08-2012.12	Front Axle Left & Right Lower	Saloon FWD ES9A		Ball Joint	S080042	
	2005.08-2012.12	Front Axle Left & Right Upper	Saloon FWD ES9A		Ball Joint	S080043	
	2005.08-2012.12	Front Axle Left & Right Lower	Saloon FWD ES9A		Control Arm Bushing	510724	
	2005.08-2012.12	Front Axle Left & Right Lower	Saloon FWD ES9A		Control Arm Bushing	517484	
	2005.08-2012.12	Rear Axle Left & Right Upper	Saloon FWD ES9A		Control Arm Bushing	532978	



	 YEAR	FITTING POSITION	BODY STYLE & DRIVE TYPE & ENGINE	REMARKS	PRODUCT	GSP Ref.	
CITROËN							
C6							
3.0 (155 kw)	2005.08-2012.12	Front Axle Left & Right	Saloon FWD ES9A		Tie Rod Axle Joint	S030029	
	2005.08-2012.12	Front Axle Left	Saloon FWD ES9A		Tie Rod End	S070594	
	2005.08-2012.12	Front Axle Right	Saloon FWD ES9A		Tie Rod End	S070595	
	2005.08-2012.12	Front Axle Left	Saloon FWD ES9A		Rod/Strut, stabiliser	S050112	
	2005.08-2012.12	Front Axle Right	Saloon FWD ES9A		Rod/Strut, stabiliser	S050113	
	2005.08-2012.12	Rear Axle Left & Right	Saloon FWD ES9A		Rod/Strut, stabiliser	S050114	
C8							
2.0 (100 kw)	2002.04-	Front Axle Left Lower	MPV FWD EW10J4		Track Control Arm	S060378	
	2002.04-	Front Axle Right Lower	MPV FWD EW10J4		Track Control Arm	S060379	
	2002.04-	Front Axle Left & Right	MPV FWD EW10J4		Tie Rod Axle Joint	S030020	
	2002.04-	Front Axle Left & Right	MPV FWD EW10J4		Tie Rod Axle Joint	S030024	
	2002.04-	Front Axle Left & Right	MPV FWD EW10J4		Tie Rod End	S070085	
	2002.04-	Front Axle Left & Right	MPV FWD EW10J4		Rod/Strut, stabiliser	S050099	
	2002.04-	Front Axle	MPV FWD EW10J4		Steering Boot	540207	
	2002.04-	Front Axle	MPV FWD EW10J4		Steering Rack Bellow Kit	540207S	
DS3							
1.6 (120 kw)	2012.01-2015.12	Front Axle Left Lower	Hatchback FWD EP6CDTM/EP6FDTM		Track Control Arm	S060820	
	2012.01-2015.12	Front Axle Right Lower	Hatchback FWD EP6CDTM/EP6FDTM		Track Control Arm	S060819	
	2012.01-2015.12	Front Axle Left & Right Lower	Hatchback FWD EP6CDTM/EP6FDTM		Ball Joint	S081028	
	2012.01-2015.12	Front Axle Left & Right Lower	Hatchback FWD EP6CDTM/EP6FDTM		Control Arm Bushing	535259	
	2012.01-2015.12	Front Axle Left & Right Lower	Hatchback FWD EP6CDTM/EP6FDTM		Control Arm Bushing	535264	
	2012.01-2015.12	Front Axle Left & Right	Hatchback FWD EP6CDTM/EP6FDTM		Tie Rod Axle Joint	S030361	
	2012.01-2015.12	Front Axle Left & Right	Hatchback FWD EP6CDTM/EP6FDTM		Tie Rod Axle Joint	S030936	
	2012.01-2015.12	Front Axle Left	Hatchback FWD EP6CDTM/EP6FDTM		Tie Rod End	S070379	
	2012.01-2015.12	Front Axle Left	Hatchback FWD EP6CDTM/EP6FDTM		Tie Rod End	S070558	
	2012.01-2015.12	Front Axle Left	Hatchback FWD EP6CDTM/EP6FDTM		Tie Rod End	S071657	
	2012.01-2015.12	Front Axle Right	Hatchback FWD EP6CDTM/EP6FDTM		Tie Rod End	S070380	
	2012.01-2015.12	Front Axle Right	Hatchback FWD EP6CDTM/EP6FDTM		Tie Rod End	S070557	
	2012.01-2015.12	Front Axle Right	Hatchback FWD EP6CDTM/EP6FDTM		Tie Rod End	S071656	
	2012.01-2015.12	Front Axle Left	Hatchback FWD EP6CDTM/EP6FDTM		Rod/Strut, stabiliser	S050389	
	2012.01-2015.12	Front Axle Right	Hatchback FWD EP6CDTM/EP6FDTM		Rod/Strut, stabiliser	S050388	
	2012.01-2015.12	Front Axle Left & Right	Hatchback FWD EP6CDTM/EP6FDTM		Rod/Strut, stabiliser	S050111	
	2012.01-2015.12	Front Axle	Hatchback FWD EP6CDTM/EP6FDTM		Stabiliser Bushing	531748	
	2012.01-2015.12	Front Axle	Hatchback FWD EP6CDTM/EP6FDTM		Steering Boot	541034	
	2012.01-2015.12	Front Axle	Hatchback FWD EP6CDTM/EP6FDTM	The main part is 541034	Steering Rack Bellow Kit	541034S	
	DS4						
1.6 (121 kw)	2012.01-2015.07	Front Axle Left Lower	Hatchback FWD EP6CDTM/EP6FDT		Track Control Arm	S060884	
	2012.01-2015.07	Front Axle Right Lower	Hatchback FWD EP6CDTM/EP6FDT		Track Control Arm	S060883	
	2012.01-2015.07	Front Axle Left & Right Lower	Hatchback FWD EP6CDTM/EP6FDT		Ball Joint	S080040	
	2012.01-2015.07	Front Axle Left & Right Lower	Hatchback FWD EP6CDTM/EP6FDT		Control Arm Bushing	510682	
	2012.01-2015.07	Front Axle Left & Right Lower	Hatchback FWD EP6CDTM/EP6FDT		Control Arm Bushing	510735	
	2012.01-2015.07	Front Axle Left & Right Lower	Hatchback FWD EP6CDTM/EP6FDT		Control Arm Bushing	511919	
	2012.01-2015.07	Front Axle Left & Right	Hatchback FWD EP6CDTM/EP6FDT		Tie Rod Axle Joint	S030236	
	2012.01-2015.07	Front Axle Left	Hatchback FWD EP6CDTM/EP6FDT		Tie Rod End	S070107	
	2012.01-2015.07	Front Axle Right	Hatchback FWD EP6CDTM/EP6FDT		Tie Rod End	S070108	
	2012.01-2015.07	Front Axle Left & Right	Hatchback FWD EP6CDTM/EP6FDT		Tie Rod End	S070094	
	2012.01-2015.07	Front Axle Left & Right	Hatchback FWD EP6CDTM/EP6FDT		Rod/Strut, stabiliser	S050109	
	2012.01-2015.07	Front Axle	Hatchback FWD EP6CDTM/EP6FDT		Stabiliser Bushing	530846	
	DS5						
	1.6 (121 kw)	2012.01-2015.07	Front Axle Left & Right Lower	Hatchback FWD EP6CDTM		Ball Joint	S080040
2012.01-2015.07		Front Axle Left & Right Lower	Hatchback FWD EP6CDTM		Control Arm Bushing	510682	
2012.01-2015.07		Front Axle Left & Right Lower	Hatchback FWD EP6CDTM		Control Arm Bushing	510735	
2012.01-2015.07		Front Axle Left & Right	Hatchback FWD EP6CDTM		Tie Rod End	S070094	
2012.01-2015.07		Front Axle Left & Right	Hatchback FWD EP6CDTM		Rod/Strut, stabiliser	S050109	
Evasion							
2.0 (97 kw)	1998.05-2000.04	Front Axle Left Lower	MPV FWD XU10J4R		Track Control Arm	S060143	
	1998.05-2000.04	Front Axle Right Lower	MPV FWD XU10J4R		Track Control Arm	S060144	
	1998.05-2000.04	Front Axle Left & Right	MPV FWD XU10J4R		Tie Rod Axle Joint	S030032	
	1998.05-2000.04	Front Axle Left & Right	MPV FWD XU10J4R		Tie Rod End	S070103	
	1998.05-2000.04	Front Axle Left & Right	MPV FWD XU10J4R		Rod/Strut, stabiliser	S050110	
	1998.05-2000.04	Front Axle	MPV FWD XU10J4R		Steering Boot	540443	
	1998.05-2000.04	Front Axle	MPV FWD XU10J4R		Steering Rack Bellow Kit	540416S	
	1998.05-2000.04	Front Axle	MPV FWD XU10J4R		Steering Rack Bellow Kit	540416S	
2.0 (108 kw)	1994.06-2000.08	Front Axle Left Lower	MPV FWD XU10J2TE		Track Control Arm	S060143	
	1994.06-2000.08	Front Axle Right Lower	MPV FWD XU10J2TE		Track Control Arm	S060144	



	 YEAR	FITTING POSITION	BODY STYLE & DRIVE TYPE & ENGINE	REMARKS	PRODUCT	GSP Ref.	
CITROËN							
Evasion							
2.0 (108 kw)	1994.06-2000.08	Front Axle Left & Right	MPV FWD XU10J2TE		Tie Rod Axle Joint	S030032	
	1994.06-2000.08	Front Axle Left & Right	MPV FWD XU10J2TE		Tie Rod End	S070103	
	1994.06-2000.08	Front Axle Left & Right	MPV FWD XU10J2TE		Rod/Strut,stabiliser	S050110	
	1994.06-2000.08	Front Axle	MPV FWD XU10J2TE		Steering Boot	540443	
	1994.06-2000.08	Front Axle	MPV FWD XU10J2TE		Steering Rack Bellow Kit	540416S	
Jumper							
2.0 (96 kw)	2016.04-2019.09	Front Axle Left Lower	VAN FWD DW10FUD		Track Control Arm	S060135	
	2016.04-2019.09	Front Axle Right Lower	VAN FWD DW10FUD		Track Control Arm	S060136	
	2016.04-2019.09	Front Axle Left & Right	VAN FWD DW10FUD		Tie Rod Axle Joint	S030946	
	2016.04-2019.09	Front Axle Left	VAN FWD DW10FUD		Tie Rod End	S070090	
	2016.04-2019.09	Front Axle Right	VAN FWD DW10FUD		Tie Rod End	S070091	
	2016.04-2019.09	Front Axle Left & Right	VAN FWD DW10FUD		Rod/Strut,stabiliser	S050105	
2.8 (94 kw)	2002.02-2006.06	Front Axle Left Lower	BUS FWD 814043S		Track Control Arm	S060380	
	2002.02-2006.06	Front Axle Left Lower	VAN FWD 814043S		Track Control Arm	S060380	
	2002.02-2006.06	Front Axle Left Lower	BUS FWD 814043S		Track Control Arm	S060383	
	2002.02-2006.06	Front Axle Left Lower	VAN FWD 814043S		Track Control Arm	S060383	
	2002.02-2006.06	Front Axle Right Lower	BUS FWD 814043S		Track Control Arm	S060381	
	2002.02-2006.06	Front Axle Right Lower	VAN FWD 814043S		Track Control Arm	S060381	
	2002.02-2006.06	Front Axle Right Lower	BUS FWD 814043S		Track Control Arm	S060382	
	2002.02-2006.06	Front Axle Right Lower	VAN FWD 814043S		Track Control Arm	S060382	
	2002.02-2006.06	Front Axle Left & Right Lower	BUS FWD 814043S	Equipment Vari.:1.8 T	Ball Joint	S080035	
	2002.02-2006.06	Front Axle Left & Right Lower	VAN FWD 814043S	Equipment Vari.:1.8 T	Ball Joint	S080035	
	2002.02-2006.06	Front Axle Left & Right Lower	BUS FWD 814043S		Ball Joint	S080038	
	2002.02-2006.06	Front Axle Left & Right Lower	VAN FWD 814043S		Ball Joint	S080038	
	2002.02-2006.06	Front Axle Left & Right Lower	BUS FWD 814043S		Control Arm Bushing	510714	
	2002.02-2006.06	Front Axle Left & Right Lower	VAN FWD 814043S		Control Arm Bushing	510714	
	2002.02-2006.06	Front Axle	BUS FWD 814043S		Suspension Repair Kit	S990045SK	
	2002.02-2006.06	Front Axle Left & Right	BUS FWD 814043S		Tie Rod Axle Joint	S030026	
	2002.02-2006.06	Front Axle Left & Right	BUS FWD 814043S	Chassis no.from:17175291	Tie Rod End	S070084	
	2002.02-2006.06	Front Axle Left & Right	VAN FWD 814043S	Chassis no.from:17175291	Tie Rod End	S070084	
	2002.02-2006.06	Front Axle Left & Right	BUS FWD 814043S	Chassis no.to:17175290	Tie Rod End	S070098	
	2002.02-2006.06	Front Axle Left & Right	VAN FWD 814043S	Chassis no.to:17175290	Tie Rod End	S070098	
	2002.02-2006.06	Front Axle Left & Right	BUS FWD 814043S		Rod/Strut,stabiliser	S050100	
	2002.02-2006.06	Front Axle Left & Right	VAN FWD 814043S		Rod/Strut,stabiliser	S050100	
	2002.02-2006.06	Front Axle	BUS FWD 814043S		Steering Boot	540194	
	2002.02-2006.06	Front Axle	VAN FWD 814043S		Steering Boot	540194	
	2002.02-2006.06	Front Axle Left	BUS FWD 814043S		Steering Rack Bellow Kit	540189S	
	2002.02-2006.06	Front Axle Left	VAN FWD 814043S		Steering Rack Bellow Kit	540189S	
	2002.02-2006.06	Front Axle Right	BUS FWD 814043S		Steering Rack Bellow Kit	540194S	
	2002.02-2006.06	Front Axle Right	VAN FWD 814043S		Steering Rack Bellow Kit	540194S	
	Jumper 27						
	2.0 (80 kw)	1994.02-2002.01	Front Axle Left Lower	VAN FWD XU10J2C		Track Control Arm	S060383
		1994.02-2002.01	Front Axle Left Lower	VAN FWD XU10J2C	Payload[kg]:1800	Track Control Arm	S060385
		1994.02-2002.01	Front Axle Right Lower	VAN FWD XU10J2C		Track Control Arm	S060382
		1994.02-2002.01	Front Axle Right Lower	VAN FWD XU10J2C	Payload[kg]:1800	Track Control Arm	S060384
1994.02-2002.01		Front Axle Left & Right Lower	VAN FWD XU10J2C	Date from:2001.02	Ball Joint	S080038	
1994.02-2002.01		Front Axle Left & Right Lower	VAN FWD XU10J2C	Equipment Vari.:1.8 T	Ball Joint	S080039	
1994.02-2002.01		Front Axle Left & Right Lower	VAN FWD XU10J2C	Equipment Vari.:1.0-1.4 T	Ball Joint	S081034	
1994.02-2002.01		Front Axle Left & Right Lower	VAN FWD XU10J2C		Control Arm Bushing	510714	
1994.02-2002.01		Front Axle Left & Right Lower	VAN FWD XU10J2C		Control Arm Bushing Kit	510715S	
1994.02-2002.01		Front Axle Left & Right	VAN FWD XU10J2C		Tie Rod Axle Joint	S030026	
1994.02-2002.01		Front Axle Left & Right	VAN FWD XU10J2C		Tie Rod End	S070098	
1994.02-2002.01		Front Axle Left & Right	VAN FWD XU10J2C		Rod/Strut,stabiliser	S050100	
1994.02-2002.01		Front Axle	VAN FWD XU10J2C		Steering Boot	540189	
1994.02-2002.01		Front Axle	VAN FWD XU10J2C		Steering Boot	540194	
1994.02-2002.01		Front Axle Left	VAN FWD XU10J2C		Steering Rack Bellow Kit	540189S	
1994.02-2002.01		Front Axle Right	VAN FWD XU10J2C	Equipment Vari.:PS EXC. 4X4 DANGEL	Steering Rack Bellow Kit	540194S	
2.8 (64 kw)		1999.01-2002.08	Front Axle Left Lower	VAN FWD 814063		Track Control Arm	S060383
		1999.01-2002.08	Front Axle Left Lower	VAN FWD 814063	Payload[kg]:1800	Track Control Arm	S060385
		1999.01-2002.08	Front Axle Right Lower	VAN FWD 814063		Track Control Arm	S060382
		1999.01-2002.08	Front Axle Right Lower	VAN FWD 814063	Payload[kg]:1800	Track Control Arm	S060384
	1999.01-2002.08	Front Axle Left & Right Lower	VAN FWD 814063		Ball Joint	S080038	
	1999.01-2002.08	Front Axle Left & Right Lower	VAN FWD 814063		Control Arm Bushing	510714	
	1999.01-2002.08	Front Axle Left & Right Lower	VAN FWD 814063		Control Arm Bushing Kit	510715S	



	 YEAR	FITTING POSITION	BODY STYLE & DRIVE TYPE & ENGINE	REMARKS	PRODUCT	GSP Ref.
CITROËN Jumper 27						
2.8 (64 kw)	1999.01-2002.08	Front Axle Left & Right	VAN FWD 814063		Tie Rod Axle Joint	S030026
	1999.01-2002.08	Front Axle Left & Right	VAN FWD 814063		Tie Rod End	S070098
Jumper 31						
2.0 (80 kw)	1994.02-2002.01	Front Axle Left Lower	VAN FWD XU10J2C		Track Control Arm	S060383
	1994.02-2002.01	Front Axle Left Lower	VAN FWD XU10J2C	Payload[kg]:1800	Track Control Arm	S060385
	1994.02-2002.01	Front Axle Right Lower	VAN FWD XU10J2C		Track Control Arm	S060382
	1994.02-2002.01	Front Axle Right Lower	VAN FWD XU10J2C	Payload[kg]:1800	Track Control Arm	S060384
	1994.02-2002.01	Front Axle Left & Right Lower	VAN FWD XU10J2C	Date from:2001.02	Ball Joint	S080038
	1994.02-2002.01	Front Axle Left & Right Lower	VAN FWD XU10J2C	Equipment Vari.:1.8 T	Ball Joint	S080039
	1994.02-2002.01	Front Axle Left & Right Lower	VAN FWD XU10J2C	Equipment Vari.:1.0-1.4 T	Ball Joint	S081034
	1994.02-2002.01	Front Axle Left & Right Lower	VAN FWD XU10J2C		Control Arm Bushing	510714
	1994.02-2002.01	Front Axle Left & Right Lower	VAN FWD XU10J2C		Control Arm Bushing Kit	510715S
	1994.02-2002.01	Front Axle Left & Right	VAN FWD XU10J2C		Tie Rod Axle Joint	S030026
	1994.02-2002.01	Front Axle Left & Right	VAN FWD XU10J2C		Tie Rod End	S070098
	1994.02-2002.01	Front Axle Left & Right	VAN FWD XU10J2C		Rod/Strut,stabiliser	S050100
	1994.02-2002.01	Front Axle	VAN FWD XU10J2C		Steering Boot	540189
	1994.02-2002.01	Front Axle	VAN FWD XU10J2C		Steering Boot	540194
	1994.02-2002.01	Front Axle Left	VAN FWD XU10J2C		Steering Rack Bellow Kit	540189S
	1994.02-2002.01	Front Axle Right	VAN FWD XU10J2C	Equipment Vari.:PS EXC. 4X4 DANGEL	Steering Rack Bellow Kit	540194S
2.8 (64 kw)	1999.01-2002.08	Front Axle Left Lower	VAN FWD 814063		Track Control Arm	S060383
	1999.01-2002.08	Front Axle Left Lower	VAN FWD 814063	Payload[kg]:1800	Track Control Arm	S060385
	1999.01-2002.08	Front Axle Right Lower	VAN FWD 814063		Track Control Arm	S060382
	1999.01-2002.08	Front Axle Right Lower	VAN FWD 814063	Payload[kg]:1800	Track Control Arm	S060384
	1999.01-2002.08	Front Axle Left & Right Lower	VAN FWD 814063		Ball Joint	S080038
	1999.01-2002.08	Front Axle Left & Right Lower	VAN FWD 814063		Control Arm Bushing	510714
	1999.01-2002.08	Front Axle Left & Right Lower	VAN FWD 814063		Control Arm Bushing Kit	510715S
	1999.01-2002.08	Front Axle Left & Right	VAN FWD 814063		Tie Rod Axle Joint	S030026
	1999.01-2002.08	Front Axle Left & Right	VAN FWD 814063		Tie Rod End	S070098
2.8 (94 kw)	2000.10-2002.01	Front Axle Left Lower	VAN 4WD 814043S		Track Control Arm	S060383
	2000.10-2002.01	Front Axle Left Lower	VAN 4WD 814043S	Payload[kg]:1800	Track Control Arm	S060385
	2000.10-2002.01	Front Axle Right Lower	VAN 4WD 814043S		Track Control Arm	S060382
	2000.10-2002.01	Front Axle Right Lower	VAN 4WD 814043S	Payload[kg]:1800	Track Control Arm	S060384
	2000.10-2002.01	Front Axle Left & Right Lower	VAN 4WD 814043S	Date from:2001.02	Ball Joint	S080038
	2000.10-2002.01	Front Axle Left & Right Lower	VAN 4WD 814043S	Equipment Vari.:1.8 T	Ball Joint	S080039
	2000.10-2002.01	Front Axle Left & Right Lower	VAN 4WD 814043S	Equipment Vari.:1.0-1.4 T	Ball Joint	S081034
	2000.10-2002.01	Front Axle Left & Right Lower	VAN 4WD 814043S		Control Arm Bushing	510714
	2000.10-2002.01	Front Axle Left & Right Lower	VAN 4WD 814043S		Control Arm Bushing Kit	510715S
	2000.10-2002.01	Front Axle Left & Right	VAN 4WD 814043S		Tie Rod Axle Joint	S030026
	2000.10-2002.01	Front Axle Left & Right	VAN 4WD 814043S		Tie Rod End	S070098
	2000.10-2002.01	Front Axle Left & Right	VAN 4WD 814043S		Rod/Strut,stabiliser	S050100
	2000.10-2002.01	Front Axle	VAN 4WD 814043S		Steering Boot	540189
	2000.10-2002.01	Front Axle	VAN 4WD 814043S		Steering Boot	540194
	2000.10-2002.01	Front Axle Left	VAN 4WD 814043S	for vehicles with power steering for vehicles with power steering	Steering Rack Bellow Kit	540189S
	2000.10-2002.01	Front Axle Left	VAN 4WD 814043S	for vehicles with power steering for vehicles with power steering	Steering Rack Bellow Kit	540194S
Jumper 35						
2.0 (80 kw)	1994.02-2002.01	Front Axle Left Lower	VAN FWD XU10J2C		Track Control Arm	S060383
	1994.02-2002.01	Front Axle Left Lower	VAN FWD XU10J2C	Payload[kg]:1800	Track Control Arm	S060385
	1994.02-2002.01	Front Axle Right Lower	VAN FWD XU10J2C		Track Control Arm	S060382
	1994.02-2002.01	Front Axle Right Lower	VAN FWD XU10J2C	Payload[kg]:1800	Track Control Arm	S060384
	1994.02-2002.01	Front Axle Left & Right Lower	VAN FWD XU10J2C	Date from:2001.02	Ball Joint	S080038
	1994.02-2002.01	Front Axle Left & Right Lower	VAN FWD XU10J2C	Equipment Vari.:1.8 T	Ball Joint	S080039
	1994.02-2002.01	Front Axle Left & Right Lower	VAN FWD XU10J2C	Equipment Vari.:1.0-1.4 T	Ball Joint	S081034
	1994.02-2002.01	Front Axle Left & Right Lower	VAN FWD XU10J2C		Control Arm Bushing	510714
	1994.02-2002.01	Front Axle Left & Right Lower	VAN FWD XU10J2C		Control Arm Bushing Kit	510715S
	1994.02-2002.01	Front Axle Left & Right	VAN FWD XU10J2C		Tie Rod Axle Joint	S030026
	1994.02-2002.01	Front Axle Left & Right	VAN FWD XU10J2C		Tie Rod End	S070098
	1994.02-2002.01	Front Axle Left & Right	VAN FWD XU10J2C		Rod/Strut,stabiliser	S050100
	1994.02-2002.01	Front Axle	VAN FWD XU10J2C		Steering Boot	540189
	1994.02-2002.01	Front Axle	VAN FWD XU10J2C		Steering Boot	540194
	1994.02-2002.01	Front Axle Left	VAN FWD XU10J2C		Steering Rack Bellow Kit	540189S
	1994.02-2002.01	Front Axle Right	VAN FWD XU10J2C	Equipment Vari.:PS EXC. 4X4 DANGEL	Steering Rack Bellow Kit	540194S
2.8 (64 kw)	1999.01-2002.08	Front Axle Left Lower	VAN FWD 814063		Track Control Arm	S060383
	1999.01-2002.08	Front Axle Left Lower	VAN FWD 814063	Payload[kg]:1800	Track Control Arm	S060385
	1999.01-2002.08	Front Axle Right Lower	VAN FWD 814063		Track Control Arm	S060382



	 YEAR	FITTING POSITION	BODY STYLE & DRIVE TYPE & ENGINE	REMARKS	PRODUCT	GSP Ref.
CITROËN Jumper 35						
2.8 (64 kw)	1999.01-2002.08	Front Axle Right Lower	VAN FWD 814063	Payload[kg]:1800	Track Control Arm	S060384
	1999.01-2002.08	Front Axle Left & Right Lower	VAN FWD 814063		Ball Joint	S080038
	1999.01-2002.08	Front Axle Left & Right Lower	VAN FWD 814063		Control Arm Bushing	510714
	1999.01-2002.08	Front Axle Left & Right Lower	VAN FWD 814063		Control Arm Bushing Kit	510715S
	1999.01-2002.08	Front Axle Left & Right	VAN FWD 814063		Tie Rod Axle Joint	S030026
	1999.01-2002.08	Front Axle Left & Right	VAN FWD 814063		Tie Rod End	S070098
2.8 (94 kw)	2000.09-2002.04	Front Axle Left Lower	BUS 4WD 814043S		Track Control Arm	S060383
	2000.09-2002.04	Front Axle Left Lower	BUS 4WD 814043S	Payload[kg]:1800	Track Control Arm	S060385
	2000.09-2002.04	Front Axle Right Lower	BUS 4WD 814043S		Track Control Arm	S060382
	2000.09-2002.04	Front Axle Right Lower	BUS 4WD 814043S	Payload[kg]:1800	Track Control Arm	S060384
	2000.09-2002.04	Front Axle Left & Right Lower	BUS 4WD 814043S	Date from:2001.02	Ball Joint	S080038
	2000.09-2002.04	Front Axle Left & Right Lower	BUS 4WD 814043S	Equipment Vari.:1.8 T	Ball Joint	S080039
	2000.09-2002.04	Front Axle Left & Right Lower	BUS 4WD 814043S	Equipment Vari.:1.0-1.4 T	Ball Joint	S081034
	2000.09-2002.04	Front Axle Left & Right Lower	BUS 4WD 814043S		Control Arm Bushing	510714
	2000.09-2002.04	Front Axle Left & Right Lower	BUS 4WD 814043S		Control Arm Bushing Kit	510715S
	2000.09-2002.04	Front Axle Left & Right	BUS 4WD 814043S		Tie Rod Axle Joint	S030026
	2000.09-2002.04	Front Axle Left & Right	BUS 4WD 814043S		Tie Rod End	S070098
	2000.09-2002.04	Front Axle Left & Right	BUS 4WD 814043S		Rod/Strut,stabiliser	S050100
	2000.09-2002.04	Front Axle	BUS 4WD 814043S		Steering Boot	540189
	2000.09-2002.04	Front Axle	BUS 4WD 814043S		Steering Boot	540194
	2000.09-2002.04	Front Axle Left	BUS 4WD 814043S	for vehicles with power steering for vehicles with power steering	Steering Rack Bellow Kit	540189S
	2000.09-2002.04	Front Axle Left	BUS 4WD 814043S	for vehicles with power steering for vehicles with power steering	Steering Rack Bellow Kit	540194S
	2000.10-2002.01	Front Axle Left Lower	VAN 4WD 814043S		Track Control Arm	S060383
	2000.10-2002.01	Front Axle Left Lower	VAN 4WD 814043S	Payload[kg]:1800	Track Control Arm	S060385
	2000.10-2002.01	Front Axle Right Lower	VAN 4WD 814043S		Track Control Arm	S060382
	2000.10-2002.01	Front Axle Right Lower	VAN 4WD 814043S	Payload[kg]:1800	Track Control Arm	S060384
	2000.10-2002.01	Front Axle Left & Right Lower	VAN 4WD 814043S	Date from:2001.02	Ball Joint	S080038
	2000.10-2002.01	Front Axle Left & Right Lower	VAN 4WD 814043S	Equipment Vari.:1.8 T	Ball Joint	S080039
	2000.10-2002.01	Front Axle Left & Right Lower	VAN 4WD 814043S	Equipment Vari.:1.0-1.4 T	Ball Joint	S081034
	2000.10-2002.01	Front Axle Left & Right Lower	VAN 4WD 814043S		Control Arm Bushing	510714
	2000.10-2002.01	Front Axle Left & Right Lower	VAN 4WD 814043S		Control Arm Bushing Kit	510715S
	2000.10-2002.01	Front Axle Left & Right	VAN 4WD 814043S		Tie Rod Axle Joint	S030026
	2000.10-2002.01	Front Axle Left & Right	VAN 4WD 814043S		Tie Rod End	S070098
	2000.10-2002.01	Front Axle Left & Right	VAN 4WD 814043S		Rod/Strut,stabiliser	S050100
	2000.10-2002.01	Front Axle	VAN 4WD 814043S		Steering Boot	540189
	2000.10-2002.01	Front Axle	VAN 4WD 814043S		Steering Boot	540194
	2000.10-2002.01	Front Axle Left	VAN 4WD 814043S	for vehicles with power steering for vehicles with power steering	Steering Rack Bellow Kit	540189S
	2000.10-2002.01	Front Axle Left	VAN 4WD 814043S	for vehicles with power steering for vehicles with power steering	Steering Rack Bellow Kit	540194S
Relay						
2.0 (96 kw)	2016.04-	Front Axle Left Lower	VAN FWD DW10FUD		Track Control Arm	S060135
	2016.04-	Front Axle Right Lower	VAN FWD DW10FUD		Track Control Arm	S060136
	2016.04-	Front Axle Left & Right	VAN FWD DW10FUD		Tie Rod Axle Joint	S030946
	2016.04-	Front Axle Left	VAN FWD DW10FUD		Tie Rod End	S070090
	2016.04-	Front Axle Right	VAN FWD DW10FUD		Tie Rod End	S070091
	2016.04-	Front Axle Left & Right	VAN FWD DW10FUD		Rod/Strut,stabiliser	S050105
2.8 (94 kw)	2002.05-2006.06	Front Axle Left Lower	BUS FWD 814043S		Track Control Arm	S060380
	2002.05-2006.06	Front Axle Left Lower	VAN FWD 814043S		Track Control Arm	S060380
	2002.05-2006.06	Front Axle Left Lower	BUS FWD 814043S		Track Control Arm	S060383
	2002.05-2006.06	Front Axle Left Lower	VAN FWD 814043S		Track Control Arm	S060383
	2002.05-2006.06	Front Axle Right Lower	BUS FWD 814043S		Track Control Arm	S060381
	2002.05-2006.06	Front Axle Right Lower	VAN FWD 814043S		Track Control Arm	S060381
	2002.05-2006.06	Front Axle Right Lower	BUS FWD 814043S		Track Control Arm	S060382
	2002.05-2006.06	Front Axle Right Lower	VAN FWD 814043S		Track Control Arm	S060382
	2002.05-2006.06	Front Axle Left & Right Lower	BUS FWD 814043S	Equipment Vari.:1.8 T	Ball Joint	S080035
	2002.05-2006.06	Front Axle Left & Right Lower	VAN FWD 814043S	Equipment Vari.:1.8 T	Ball Joint	S080035
	2002.05-2006.06	Front Axle Left & Right Lower	BUS FWD 814043S		Ball Joint	S080038
	2002.05-2006.06	Front Axle Left & Right Lower	VAN FWD 814043S		Ball Joint	S080038
	2002.05-2006.06	Front Axle Left & Right Lower	BUS FWD 814043S		Control Arm Bushing	510714
	2002.05-2006.06	Front Axle Left & Right Lower	VAN FWD 814043S		Control Arm Bushing	510714
	2002.05-2006.06	Front Axle	BUS FWD 814043S		Suspension Repair Kit	S990045SK
	2002.05-2006.06	Front Axle Left & Right	BUS FWD 814043S		Tie Rod Axle Joint	S030026
	2002.05-2006.06	Front Axle Left & Right	BUS FWD 814043S	Chassis no.from:17175291	Tie Rod End	S070084
	2002.05-2006.06	Front Axle Left & Right	VAN FWD 814043S	Chassis no.from:17175291	Tie Rod End	S070084
	2002.05-2006.06	Front Axle Left & Right	BUS FWD 814043S	Chassis no.to:17175290	Tie Rod End	S070098



	 YEAR	FITTING POSITION	BODY STYLE & DRIVE TYPE & ENGINE	REMARKS	PRODUCT	GSP Ref.
CITROËN						
Relay						
2.8 (94 kw)	2002.05-2006.06	Front Axle Left & Right	VAN FWD 814043S	Chassis no.to:17175290	Tie Rod End	S070098
	2002.05-2006.06	Front Axle Left & Right	BUS FWD 814043S		Rod/Strut,stabiliser	S050100
	2002.05-2006.06	Front Axle Left & Right	VAN FWD 814043S		Rod/Strut,stabiliser	S050100
	2002.05-2006.06	Front Axle	BUS FWD 814043S		Steering Boot	540194
	2002.05-2006.06	Front Axle	VAN FWD 814043S		Steering Boot	540194
	2002.05-2006.06	Front Axle Left	BUS FWD 814043S		Steering Rack Bellow Kit	540189S
	2002.05-2006.06	Front Axle Left	VAN FWD 814043S		Steering Rack Bellow Kit	540189S
	2002.05-2006.06	Front Axle Right	BUS FWD 814043S		Steering Rack Bellow Kit	540194S
	2002.05-2006.06	Front Axle Right	VAN FWD 814043S		Steering Rack Bellow Kit	540194S
Relay 1400						
2.8 (94 kw)	2000.10-2002.04	Front Axle Left Lower	VAN 4WD 814043S		Track Control Arm	S060383
	2000.10-2002.04	Front Axle Left Lower	VAN 4WD 814043S	Payload[kg]:1800	Track Control Arm	S060385
	2000.10-2002.04	Front Axle Right Lower	VAN 4WD 814043S		Track Control Arm	S060382
	2000.10-2002.04	Front Axle Right Lower	VAN 4WD 814043S	Payload[kg]:1800	Track Control Arm	S060384
	2000.10-2002.04	Front Axle Left & Right Lower	VAN 4WD 814043S	Date from:2001.02	Ball Joint	S080038
	2000.10-2002.04	Front Axle Left & Right Lower	VAN 4WD 814043S	Equipment Vari.:1.8 T	Ball Joint	S080039
	2000.10-2002.04	Front Axle Left & Right Lower	VAN 4WD 814043S	Equipment Vari.:1.0-1.4 T	Ball Joint	S081034
	2000.10-2002.04	Front Axle Left & Right Lower	VAN 4WD 814043S		Control Arm Bushing	510714
	2000.10-2002.04	Front Axle Left & Right Lower	VAN 4WD 814043S		Control Arm Bushing Kit	510715S
	2000.10-2002.04	Front Axle Left & Right	VAN 4WD 814043S		Tie Rod Axle Joint	S030026
	2000.10-2002.04	Front Axle Left & Right	VAN 4WD 814043S		Tie Rod End	S070098
	2000.10-2002.04	Front Axle Left & Right	VAN 4WD 814043S		Rod/Strut,stabiliser	S050100
	2000.10-2002.04	Front Axle	VAN 4WD 814043S		Steering Boot	540189
	2000.10-2002.04	Front Axle	VAN 4WD 814043S		Steering Boot	540194
	2000.10-2002.04	Front Axle Left	VAN 4WD 814043S	for vehicles with power steering for vehicles with power steering	Steering Rack Bellow Kit	540189S
	2000.10-2002.04	Front Axle Left	VAN 4WD 814043S	for vehicles with power steering for vehicles with power steering	Steering Rack Bellow Kit	540194S
Relay 1800						
2.8 (94 kw)	2000.09-2002.04	Front Axle Left Lower	BUS 4WD 814043S		Track Control Arm	S060383
	2000.09-2002.04	Front Axle Left Lower	BUS 4WD 814043S	Payload[kg]:1800	Track Control Arm	S060385
	2000.09-2002.04	Front Axle Right Lower	BUS 4WD 814043S		Track Control Arm	S060382
	2000.09-2002.04	Front Axle Right Lower	BUS 4WD 814043S	Payload[kg]:1800	Track Control Arm	S060384
	2000.09-2002.04	Front Axle Left & Right Lower	BUS 4WD 814043S	Date from:2001.02	Ball Joint	S080038
	2000.09-2002.04	Front Axle Left & Right Lower	BUS 4WD 814043S	Equipment Vari.:1.8 T	Ball Joint	S080039
	2000.09-2002.04	Front Axle Left & Right Lower	BUS 4WD 814043S	Equipment Vari.:1.0-1.4 T	Ball Joint	S081034
	2000.09-2002.04	Front Axle Left & Right Lower	BUS 4WD 814043S		Control Arm Bushing	510714
	2000.09-2002.04	Front Axle Left & Right Lower	BUS 4WD 814043S		Control Arm Bushing Kit	510715S
	2000.09-2002.04	Front Axle Left & Right	BUS 4WD 814043S		Tie Rod Axle Joint	S030026
	2000.09-2002.04	Front Axle Left & Right	BUS 4WD 814043S		Tie Rod End	S070098
	2000.09-2002.04	Front Axle Left & Right	BUS 4WD 814043S		Rod/Strut,stabiliser	S050100
	2000.09-2002.04	Front Axle	BUS 4WD 814043S		Steering Boot	540189
	2000.09-2002.04	Front Axle	BUS 4WD 814043S		Steering Boot	540194
	2000.09-2002.04	Front Axle Left	BUS 4WD 814043S	for vehicles with power steering for vehicles with power steering	Steering Rack Bellow Kit	540189S
	2000.09-2002.04	Front Axle Left	BUS 4WD 814043S	for vehicles with power steering for vehicles with power steering	Steering Rack Bellow Kit	540194S
	2000.10-2002.04	Front Axle Left Lower	VAN 4WD 814043S		Track Control Arm	S060383
	2000.10-2002.04	Front Axle Left Lower	VAN 4WD 814043S	Payload[kg]:1800	Track Control Arm	S060385
	2000.10-2002.04	Front Axle Right Lower	VAN 4WD 814043S		Track Control Arm	S060382
	2000.10-2002.04	Front Axle Right Lower	VAN 4WD 814043S	Payload[kg]:1800	Track Control Arm	S060384
	2000.10-2002.04	Front Axle Left & Right Lower	VAN 4WD 814043S	Date from:2001.02	Ball Joint	S080038
	2000.10-2002.04	Front Axle Left & Right Lower	VAN 4WD 814043S	Equipment Vari.:1.8 T	Ball Joint	S080039
	2000.10-2002.04	Front Axle Left & Right Lower	VAN 4WD 814043S	Equipment Vari.:1.0-1.4 T	Ball Joint	S081034
	2000.10-2002.04	Front Axle Left & Right Lower	VAN 4WD 814043S		Control Arm Bushing	510714
	2000.10-2002.04	Front Axle Left & Right Lower	VAN 4WD 814043S		Control Arm Bushing Kit	510715S
	2000.10-2002.04	Front Axle Left & Right	VAN 4WD 814043S		Tie Rod Axle Joint	S030026
	2000.10-2002.04	Front Axle Left & Right	VAN 4WD 814043S		Tie Rod End	S070098
	2000.10-2002.04	Front Axle Left & Right	VAN 4WD 814043S		Rod/Strut,stabiliser	S050100
	2000.10-2002.04	Front Axle	VAN 4WD 814043S		Steering Boot	540189
	2000.10-2002.04	Front Axle	VAN 4WD 814043S		Steering Boot	540194
	2000.10-2002.04	Front Axle Left	VAN 4WD 814043S	for vehicles with power steering for vehicles with power steering	Steering Rack Bellow Kit	540189S
	2000.10-2002.04	Front Axle Left	VAN 4WD 814043S	for vehicles with power steering for vehicles with power steering	Steering Rack Bellow Kit	540194S
Xantia						
1.8 (81 kw)	1995.06-2001.12	Front Axle Left Lower	Hatchback FWD XU7JP4		Track Control Arm	S060127
	1995.06-2001.12	Front Axle Right Lower	Hatchback FWD XU7JP4		Track Control Arm	S060128
	1995.06-2001.12	Front Axle Left & Right Lower	Hatchback FWD XU7JP4		Ball Joint	S080044
	1995.06-2001.12	Front Axle Left & Right Lower	Hatchback FWD XU7JP4		Control Arm Bushing	512257



	 YEAR	FITTING POSITION	BODY STYLE & DRIVE TYPE & ENGINE	REMARKS	PRODUCT	GSP Ref.
CITROËN						
Xantia						
1.8 (81 kw)	1995.06-2001.12	Front Axle Left & Right	Hatchback FWD XU7JP4		Tie Rod Axle Joint	S030033
	1995.06-2001.12	Front Axle Left	Hatchback FWD XU7JP4		Tie Rod End	S070105
	1995.06-2001.12	Front Axle Right	Hatchback FWD XU7JP4		Tie Rod End	S070106
	1995.06-2001.12	Front Axle Left & Right	Hatchback FWD XU7JP4		Rod/Strut, stabiliser	S100043
	1995.06-2001.12	Front Axle	Hatchback FWD XU7JP4	for RPO No. (vehicle manufacturing date) up until 06778	Steering Boot	540346
2.0 (89 kw)	1995.06-2003.04	Front Axle Left Lower	Estate FWD XU10J2C		Track Control Arm	S060127
	1995.06-2003.04	Front Axle Right Lower	Estate FWD XU10J2C		Track Control Arm	S060128
	1995.06-2003.04	Front Axle Left & Right Lower	Estate FWD XU10J2C		Ball Joint	S080044
	1995.06-2003.04	Front Axle Left & Right Lower	Estate FWD XU10J2C		Control Arm Bushing	512257
	1995.06-2003.04	Front Axle Left & Right	Estate FWD XU10J2C		Tie Rod Axle Joint	S030033
	1995.06-2003.04	Front Axle Left	Estate FWD XU10J2C		Tie Rod End	S070105
	1995.06-2003.04	Front Axle Right	Estate FWD XU10J2C		Tie Rod End	S070106
	1995.06-2003.04	Front Axle Left & Right	Estate FWD XU10J2C		Rod/Strut, stabiliser	S100043
	1995.06-2003.04	Front Axle	Estate FWD XU10J2C	for RPO No. (vehicle manufacturing date) up until 06778	Steering Boot	540346
2.0 (110 kw)	1994.06-1998.01	Front Axle Left Lower	Hatchback FWD XU10J4D		Track Control Arm	S060127
	1994.06-1998.01	Front Axle Right Lower	Hatchback FWD XU10J4D		Track Control Arm	S060128
	1994.06-1998.01	Front Axle Left & Right Lower	Hatchback FWD XU10J4D		Ball Joint	S080044
	1994.06-1998.01	Front Axle Left & Right Lower	Hatchback FWD XU10J4D		Control Arm Bushing	512257
	1994.06-1998.01	Front Axle Left & Right	Hatchback FWD XU10J4D		Tie Rod Axle Joint	S030033
	1994.06-1998.01	Front Axle Left	Hatchback FWD XU10J4D		Tie Rod End	S070105
	1994.06-1998.01	Front Axle Right	Hatchback FWD XU10J4D		Tie Rod End	S070106
	1994.06-1998.01	Front Axle Left & Right	Hatchback FWD XU10J4D		Rod/Strut, stabiliser	S100043
1994.06-1998.01	Front Axle	Hatchback FWD XU10J4D	for RPO No. (vehicle manufacturing date) up until 06778	Steering Boot	540346	
XM						
3.0 (140 kw)	1997.05-2000.04	Front Axle Left & Right Lower	Hatchback FWD ES9J4		Ball Joint	S080044
	1997.05-2000.04	Front Axle Left & Right Lower	Hatchback FWD ES9J4		Control Arm Bushing	512284
	1997.05-2000.04	Front Axle Left & Right	Hatchback FWD ES9J4		Tie Rod Axle Joint	S030035
	1997.05-2000.04	Front Axle Left	Hatchback FWD ES9J4		Tie Rod End	S070100
	1997.05-2000.04	Front Axle Left	Hatchback FWD ES9J4		Tie Rod End	S070105
	1997.05-2000.04	Front Axle Right	Hatchback FWD ES9J4		Tie Rod End	S070099
	1997.05-2000.04	Front Axle Right	Hatchback FWD ES9J4		Tie Rod End	S070106
	1997.05-2000.04	Front Axle Left	Hatchback FWD ES9J4		Steering Rack Bellow Kit	541029S
1997.05-2000.04	Front Axle	Hatchback FWD ES9J4		Steering Rack Bellow Kit	540256S	
Xsara						
1.6 (80 kw)	2000.09-2005.03	Front Axle Left Lower	Hatchback FWD TU5JP4	Org.No.to:7973	Track Control Arm	S060372
	2000.09-2005.03	Front Axle Left Lower	Hatchback FWD TU5JP4		Track Control Arm	S060372B
	2000.09-2005.03	Front Axle Left Lower	Hatchback FWD TU5JP4	for vehicles with power steering for vehicles without power steering	Track Control Arm	S063016
	2000.09-2005.03	Front Axle Right Lower	Hatchback FWD TU5JP4		Track Control Arm	S060373
	2000.09-2005.03	Front Axle Right Lower	Hatchback FWD TU5JP4		Track Control Arm	S060373B
	2000.09-2005.03	Front Axle Right Lower	Hatchback FWD TU5JP4	04-10 incl for vehicles with power steering for vehicles without power steering	Track Control Arm	S063017
	2000.09-2005.03	Front Axle Left & Right Lower	Hatchback FWD TU5JP4		Ball Joint	S080031
	2000.09-2005.03	Front Axle Left & Right Lower	Hatchback FWD TU5JP4		Ball Joint	S080033
	2000.09-2005.03	Front Axle Left & Right Lower	Hatchback FWD TU5JP4		Control Arm Bushing	510689
	2000.09-2005.03	Front Axle Left & Right Lower	Hatchback FWD TU5JP4		Control Arm Bushing	510690
	2000.09-2005.03	Front Axle Left & Right	Hatchback FWD TU5JP4		Tie Rod Axle Joint	S030021
	2000.09-2005.03	Front Axle Left & Right	Hatchback FWD TU5JP4		Tie Rod End	S070104
	2000.09-2005.03	Front Axle Left & Right	Hatchback FWD TU5JP4		Rod/Strut, stabiliser	S050115
	2000.09-2005.03	Front Axle	Hatchback FWD TU5JP4		Stabiliser Bushing	512500
	2000.09-2005.03	Front Axle	Hatchback FWD TU5JP4		Stabiliser Bushing	512800
	2000.09-2005.03	Front Axle	Hatchback FWD TU5JP4		Stabiliser Bushing	512801
	2000.09-2005.03	Front Axle	Hatchback FWD TU5JP4		Steering Boot	540061
2000.09-2005.03	Front Axle	Hatchback FWD TU5JP4		Steering Boot	540414	
2000.09-2005.03	Front Axle Left	Hatchback FWD TU5JP4		Steering Rack Bellow Kit	540061S	
1.8 (81 kw)	1997.07-2000.08	Front Axle Left Lower	Hatchback FWD XU7JP4	Org.No.to:7973	Track Control Arm	S060372
	1997.07-2000.08	Front Axle Left Lower	Hatchback FWD XU7JP4		Track Control Arm	S060372B
	1997.07-2000.08	Front Axle Left Lower	Hatchback FWD XU7JP4	for vehicles with power steering for vehicles without power steering	Track Control Arm	S063016
	1997.07-2000.08	Front Axle Right Lower	Hatchback FWD XU7JP4		Track Control Arm	S060373
	1997.07-2000.08	Front Axle Right Lower	Hatchback FWD XU7JP4		Track Control Arm	S060373B
	1997.07-2000.08	Front Axle Right Lower	Hatchback FWD XU7JP4	04-10 incl for vehicles with power steering for vehicles without power steering	Track Control Arm	S063017
	1997.07-2000.08	Front Axle Left & Right Lower	Hatchback FWD XU7JP4	Org.No.from:07967	Ball Joint	S080031
	1997.07-2000.08	Front Axle Left & Right Lower	Hatchback FWD XU7JP4	Org.No.to:07966	Ball Joint	S080033
	1997.07-2000.08	Front Axle Left & Right Lower	Hatchback FWD XU7JP4		Control Arm Bushing	510689
	1997.07-2000.08	Front Axle Left & Right Lower	Hatchback FWD XU7JP4		Control Arm Bushing	510690
	1997.07-2000.08	Front Axle Left & Right	Hatchback FWD XU7JP4		Tie Rod Axle Joint	S030021



	 YEAR	FITTING POSITION	BODY STYLE & DRIVE TYPE & ENGINE	REMARKS	PRODUCT	GSP Ref.
CITROËN						
Xsara						
1.8 (81 kw)	1997.07-2000.08	Front Axle Left & Right	Hatchback FWD XU7JP4		Tie Rod End	S070104
	1997.07-2000.08	Front Axle Left & Right	Hatchback FWD XU7JP4		Rod/Strut, stabiliser	S050115
	1997.07-2000.08	Front Axle	Hatchback FWD XU7JP4		Stabiliser Bushing	512800
	1997.07-2000.08	Front Axle	Hatchback FWD XU7JP4		Stabiliser Bushing	512801
	1997.07-2000.08	Front Axle	Hatchback FWD XU7JP4		Steering Boot	540061
	1997.07-2000.08	Front Axle	Hatchback FWD XU7JP4		Steering Boot	540414
	1997.07-2000.08	Front Axle Left	Hatchback FWD XU7JP4	Fitting Position: Driver side	Steering Rack Bellow Kit	540061S
2.0 (97 kw)	1998.07-2000.08	Front Axle Left Lower	Hatchback FWD XU10J4R	Org.No.to:7973	Track Control Arm	S060372
	1998.07-2000.08	Front Axle Left Lower	Hatchback FWD XU10J4R		Track Control Arm	S060372B
	1998.07-2000.08	Front Axle Left Lower	Hatchback FWD XU10J4R	for vehicles with power steering for vehicles without power steering	Track Control Arm	S063016
	1998.07-2000.08	Front Axle Right Lower	Hatchback FWD XU10J4R		Track Control Arm	S060373
	1998.07-2000.08	Front Axle Right Lower	Hatchback FWD XU10J4R		Track Control Arm	S060373B
	1998.07-2000.08	Front Axle Right Lower	Hatchback FWD XU10J4R	D4-18 mm for vehicles with power steering for vehicles without power steering	Track Control Arm	S063017
	1998.07-2000.08	Front Axle Left & Right Lower	Hatchback FWD XU10J4R	Org.No.from:07967	Ball Joint	S080031
	1998.07-2000.08	Front Axle Left & Right Lower	Hatchback FWD XU10J4R	Org.No.to:07966	Ball Joint	S080033
	1998.07-2000.08	Front Axle Left & Right	Hatchback FWD XU10J4R		Tie Rod Axle Joint	S030021
	1998.07-2000.08	Front Axle Left & Right	Hatchback FWD XU10J4R		Tie Rod End	S070104
	1998.07-2000.08	Front Axle Left & Right	Hatchback FWD XU10J4R		Rod/Strut, stabiliser	S050115
	1998.07-2000.08	Front Axle	Hatchback FWD XU10J4R		Stabiliser Bushing	512800
	1998.07-2000.08	Front Axle	Hatchback FWD XU10J4R		Stabiliser Bushing	512801
	1998.07-2000.08	Front Axle	Hatchback FWD XU10J4R		Steering Boot	540061
	1998.07-2000.08	Front Axle	Hatchback FWD XU10J4R		Steering Boot	540414
	1998.07-2000.08	Front Axle Left	Hatchback FWD XU10J4R		Steering Rack Bellow Kit	540061S
	2.0 (100 kw)	2000.09-2005.03	Front Axle Left Lower	Hatchback FWD EW10J4	Org.No.to:7973	Track Control Arm
2000.09-2005.03		Front Axle Left Lower	Hatchback FWD EW10J4		Track Control Arm	S060372B
2000.09-2005.03		Front Axle Left Lower	Hatchback FWD EW10J4	for vehicles with power steering for vehicles without power steering	Track Control Arm	S063016
2000.09-2005.03		Front Axle Right Lower	Hatchback FWD EW10J4		Track Control Arm	S060373
2000.09-2005.03		Front Axle Right Lower	Hatchback FWD EW10J4		Track Control Arm	S060373B
2000.09-2005.03		Front Axle Right Lower	Hatchback FWD EW10J4	D4-18 mm for vehicles with power steering for vehicles without power steering	Track Control Arm	S063017
2000.09-2005.03		Front Axle Left & Right Lower	Hatchback FWD EW10J4		Ball Joint	S080031
2000.09-2005.03		Front Axle Left & Right Lower	Hatchback FWD EW10J4		Ball Joint	S080033
2000.09-2005.03		Front Axle Left & Right Lower	Hatchback FWD EW10J4		Control Arm Bushing	510689
2000.09-2005.03		Front Axle Left & Right	Hatchback FWD EW10J4		Tie Rod Axle Joint	S030021
2000.09-2005.03		Front Axle Left & Right	Hatchback FWD EW10J4		Tie Rod End	S070104
2000.09-2005.03		Front Axle Left & Right	Hatchback FWD EW10J4		Rod/Strut, stabiliser	S050115
2000.09-2005.03		Front Axle	Hatchback FWD EW10J4		Stabiliser Bushing	512500
2000.09-2005.03		Front Axle	Hatchback FWD EW10J4		Stabiliser Bushing	512800
2000.09-2005.03		Front Axle	Hatchback FWD EW10J4		Stabiliser Bushing	512801
2000.09-2005.03		Front Axle	Hatchback FWD EW10J4		Steering Boot	540061
2000.09-2005.03		Front Axle	Hatchback FWD EW10J4		Steering Boot	540414
2000.09-2005.03	Front Axle Left	Hatchback FWD EW10J4		Steering Rack Bellow Kit	540061S	
Xsara Estate/Break						
1.6 (80 kw)	2000.09-2005.08	Front Axle Left Lower	Estate FWD TU5JP4	Org.No.to:7973	Track Control Arm	S060372
	2000.09-2005.08	Front Axle Left Lower	Estate FWD TU5JP4		Track Control Arm	S060372B
	2000.09-2005.08	Front Axle Left Lower	Estate FWD TU5JP4	for vehicles with power steering for vehicles without power steering	Track Control Arm	S063016
	2000.09-2005.08	Front Axle Right Lower	Estate FWD TU5JP4		Track Control Arm	S060373
	2000.09-2005.08	Front Axle Right Lower	Estate FWD TU5JP4		Track Control Arm	S060373B
	2000.09-2005.08	Front Axle Right Lower	Estate FWD TU5JP4	D4-18 mm for vehicles with power steering for vehicles without power steering	Track Control Arm	S063017
	2000.09-2005.08	Front Axle Left & Right Lower	Estate FWD TU5JP4		Ball Joint	S080031
	2000.09-2005.08	Front Axle Left & Right Lower	Estate FWD TU5JP4	for vehicles with heavy duty suspension	Ball Joint	S080033
	2000.09-2005.08	Front Axle Left & Right Lower	Estate FWD TU5JP4		Control Arm Bushing	510689
	2000.09-2005.08	Front Axle Left & Right Lower	Estate FWD TU5JP4		Control Arm Bushing	510690
	2000.09-2005.08	Front Axle Left & Right	Estate FWD TU5JP4		Tie Rod Axle Joint	S030021
	2000.09-2005.08	Front Axle Left & Right	Estate FWD TU5JP4		Tie Rod End	S070104
	2000.09-2005.08	Front Axle Left & Right	Estate FWD TU5JP4		Rod/Strut, stabiliser	S050115
	2000.09-2005.08	Front Axle	Estate FWD TU5JP4		Stabiliser Bushing	512500
	2000.09-2005.08	Front Axle	Estate FWD TU5JP4		Stabiliser Bushing	512801
	2000.09-2005.08	Front Axle	Estate FWD TU5JP4		Steering Boot	540061
	2000.09-2005.08	Front Axle	Estate FWD TU5JP4		Steering Boot	540414
2000.09-2005.08	Front Axle Left	Estate FWD TU5JP4		Steering Rack Bellow Kit	540061S	
1.8 (81 kw)	1998.05-2000.08	Front Axle Left Lower	Estate FWD XU7JP4	Org.No.to:7973	Track Control Arm	S060372
	1998.05-2000.08	Front Axle Left Lower	Estate FWD XU7JP4	for vehicles with power steering for vehicles without power steering	Track Control Arm	S063016
	1998.05-2000.08	Front Axle Right Lower	Estate FWD XU7JP4		Track Control Arm	S060373
	1998.05-2000.08	Front Axle Right Lower	Estate FWD XU7JP4		Track Control Arm	S060373B



	 YEAR	FITTING POSITION	BODY STYLE & DRIVE TYPE & ENGINE	REMARKS	PRODUCT	GSP Ref.
CITROËN Xsara Estate/Break						
1.8 (81 kw)	1998.05-2000.08	Front Axle Right Lower	Estate FWD XU7JP4	<small>D4-18 mm for vehicles with power steering for vehicles without power steering</small>	Track Control Arm	S063017
	1998.05-2000.08	Front Axle Left & Right Lower	Estate FWD XU7JP4	Org.No.from:07967	Ball Joint	S080031
	1998.05-2000.08	Front Axle Left & Right Lower	Estate FWD XU7JP4	Org.No.to:07966	Ball Joint	S080033
	1998.05-2000.08	Front Axle Left & Right Lower	Estate FWD XU7JP4		Control Arm Bushing	510689
	1998.05-2000.08	Front Axle Left & Right Lower	Estate FWD XU7JP4		Control Arm Bushing	510690
	1998.05-2000.08	Front Axle Left & Right	Estate FWD XU7JP4		Tie Rod Axle Joint	S030021
	1998.05-2000.08	Front Axle Left & Right	Estate FWD XU7JP4		Tie Rod End	S070104
	1998.05-2000.08	Front Axle Left & Right	Estate FWD XU7JP4		Rod/Strut,stabiliser	S050115
	1998.05-2000.08	Front Axle	Estate FWD XU7JP4		Stabiliser Bushing	512801
	1998.05-2000.08	Front Axle	Estate FWD XU7JP4		Steering Boot	540061
	1998.05-2000.08	Front Axle	Estate FWD XU7JP4		Steering Boot	540414
	1998.05-2000.08	Front Axle Left	Estate FWD XU7JP4	Fitting Position: Driver side	Steering Rack Bellow Kit	540061S
2.0 (97 kw)	1998.07-2000.08	Front Axle Left Lower	Estate FWD XU10J4R	Org.No.to:7973	Track Control Arm	S060372
	1998.07-2000.08	Front Axle Left Lower	Estate FWD XU10J4R	<small>for vehicles with power steering for vehicles without power steering</small>	Track Control Arm	S063016
	1998.07-2000.08	Front Axle Right Lower	Estate FWD XU10J4R		Track Control Arm	S060373
	1998.07-2000.08	Front Axle Right Lower	Estate FWD XU10J4R		Track Control Arm	S060373B
	1998.07-2000.08	Front Axle Right Lower	Estate FWD XU10J4R	<small>D4-18 mm for vehicles with power steering for vehicles without power steering</small>	Track Control Arm	S063017
	1998.07-2000.08	Front Axle Left & Right Lower	Estate FWD XU10J4R	Org.No.from:07967	Ball Joint	S080031
	1998.07-2000.08	Front Axle Left & Right Lower	Estate FWD XU10J4R	Org.No.to:07966	Ball Joint	S080033
	1998.07-2000.08	Front Axle Left & Right	Estate FWD XU10J4R		Tie Rod Axle Joint	S030021
	1998.07-2000.08	Front Axle Left & Right	Estate FWD XU10J4R		Tie Rod End	S070104
	1998.07-2000.08	Front Axle Left & Right	Estate FWD XU10J4R		Rod/Strut,stabiliser	S050115
	1998.07-2000.08	Front Axle	Estate FWD XU10J4R		Stabiliser Bushing	512801
	1998.07-2000.08	Front Axle	Estate FWD XU10J4R		Steering Boot	540061
	1998.07-2000.08	Front Axle	Estate FWD XU10J4R		Steering Boot	540414
	1998.07-2000.08	Front Axle Left	Estate FWD XU10J4R		Steering Rack Bellow Kit	540061S
Xsara Picasso						
1.6 (81 kw)	2005.06-2006.09	Front Axle Left Lower	MPV FWD TU5JP4	For OE no.3520A1	Track Control Arm	S060372
	2005.06-2006.09	Front Axle Left Lower	MPV FWD TU5JP4		Track Control Arm	S060372B
	2005.06-2006.09	Front Axle Left Lower	MPV FWD TU5JP4	<small>for vehicles with heavy duty suspension</small>	Track Control Arm	S060376
	2005.06-2006.09	Front Axle Left Lower	MPV FWD TU5JP4	<small>Equipment Vari. EXC:HDI and 2.0 16V/Chassis no.from ORG 00964</small>	Track Control Arm	S063016
	2005.06-2006.09	Front Axle Right Lower	MPV FWD TU5JP4		Track Control Arm	S060373
	2005.06-2006.09	Front Axle Right Lower	MPV FWD TU5JP4		Track Control Arm	S060373B
	2005.06-2006.09	Front Axle Right Lower	MPV FWD TU5JP4	<small>for vehicles with heavy duty suspension</small>	Track Control Arm	S060377
	2005.06-2006.09	Front Axle Right Lower	MPV FWD TU5JP4	<small>Equipment Vari. EXC:HDI and 2.0 16V/Chassis no.from ORG 00964</small>	Track Control Arm	S063017
	2005.06-2006.09	Front Axle Left & Right Lower	MPV FWD TU5JP4		Ball Joint	S080031
	2005.06-2006.09	Front Axle Left & Right Lower	MPV FWD TU5JP4		Control Arm Bushing	510689
	2005.06-2006.09	Front Axle Left & Right Lower	MPV FWD TU5JP4		Control Arm Bushing	510690
	2005.06-2006.09	Front Axle Left & Right Lower	MPV FWD TU5JP4		Control Arm Bushing	511908
	2005.06-2006.09	Front Axle Left & Right	MPV FWD TU5JP4		Tie Rod End	S070104
	2005.06-2006.09	Front Axle Left & Right	MPV FWD TU5JP4		Tie Rod End	S070866
	2005.06-2006.09	Front Axle Left & Right	MPV FWD TU5JP4		Rod/Strut,stabiliser	S050115
	2005.06-2006.09	Front Axle	MPV FWD TU5JP4		Stabiliser Bushing	512500
	2005.06-2006.09	Front Axle	MPV FWD TU5JP4		Steering Boot	540061
	2005.06-2006.09	Front Axle Left	MPV FWD TU5JP4		Steering Rack Bellow Kit	540061S
2.0 (100 kw)	2000.10-2012.06	Front Axle Left Lower	MPV FWD EW10J4		Track Control Arm	S060376
	2000.10-2012.06	Front Axle Right Lower	MPV FWD EW10J4		Track Control Arm	S060377
	2000.10-2012.06	Front Axle Left & Right Lower	MPV FWD EW10J4		Control Arm Bushing	511908
	2000.10-2012.06	Front Axle	MPV FWD EW10J4		Suspension Repair Kit	S990044SK
	2000.10-2012.06	Front Axle Left & Right	MPV FWD EW10J4		Tie Rod Axle Joint	S030019
	2000.10-2012.06	Front Axle Left & Right	MPV FWD EW10J4		Tie Rod End	S070104
	2000.10-2012.06	Front Axle Left & Right	MPV FWD EW10J4		Rod/Strut,stabiliser	S050115
	2000.10-2012.06	Front Axle	MPV FWD EW10J4		Stabiliser Bushing	512500
	2000.10-2012.06	Front Axle	MPV FWD EW10J4	<small>for vehicles with power steering</small>	Steering Boot	540061
	2000.10-2012.06	Front Axle	MPV FWD EW10J4	length:126mm	Steering Boot	540341
	2000.10-2012.06	Front Axle Left	MPV FWD EW10J4	Fitting Position:Driver side	Steering Rack Bellow Kit	540061S
	2000.10-2012.06	Front Axle Right	MPV FWD EW10J4	<small>for vehicles with power steering</small>	Steering Rack Bellow Kit	540341S
ZX						
1.8 (76 kw)	1991.03-1997.10	Front Axle Left Lower	Hatchback FWD XU7JP		Track Control Arm	S060372
	1991.03-1997.10	Front Axle Left Lower	Hatchback FWD XU7JP		Track Control Arm	S060372B
	1991.03-1997.10	Front Axle Right Lower	Hatchback FWD XU7JP		Track Control Arm	S060373
	1991.03-1997.10	Front Axle Left & Right Lower	Hatchback FWD XU7JP		Ball Joint	S080033
	1991.03-1997.10	Front Axle Left & Right Lower	Hatchback FWD XU7JP		Control Arm Bushing	510689
	1991.03-1997.10	Front Axle Left & Right Lower	Hatchback FWD XU7JP		Control Arm Bushing	510690



	 YEAR	FITTING POSITION	BODY STYLE & DRIVE TYPE & ENGINE	REMARKS	PRODUCT	GSP Ref.
CITROËN ZX						
1.8 (76 kw)	1991.03-1997.10	Front Axle Left & Right	Hatchback FWD XU7JP		Tie Rod Axle Joint	S030021
	1991.03-1997.10	Front Axle Left & Right	Hatchback FWD XU7JP		Tie Rod End	S070104
	1991.03-1997.10	Front Axle Left & Right	Hatchback FWD XU7JP		Rod/Strut, stabiliser	S050115
	1991.03-1997.10	Front Axle	Hatchback FWD XU7JP		Stabiliser Bushing	510701
	1991.03-1997.10	Front Axle	Hatchback FWD XU7JP		Steering Boot	540061
	1991.03-1997.10	Front Axle	Hatchback FWD XU7JP		Steering Boot	540332
	1991.03-1997.10	Front Axle	Hatchback FWD XU7JP		Steering Boot	540414
	1991.03-1997.10	Front Axle Left	Hatchback FWD XU7JP	for org. no. 06629 for vehicles without power steering	Steering Rack Bellow Kit	540061S
2.0 (114 kw)	1992.07-1997.10	Front Axle Left Lower	Hatchback FWD RFT(XU10J4/Z)/RFY(XU10J4/Z)		Track Control Arm	S060372
	1992.07-1997.10	Front Axle Right Lower	Hatchback FWD RFT(XU10J4/Z)/RFY(XU10J4/Z)		Track Control Arm	S060373
	1992.07-1997.10	Front Axle Left & Right Lower	Hatchback FWD RFT(XU10J4/Z)/RFY(XU10J4/Z)		Ball Joint	S080033
	1992.07-1997.10	Front Axle Left & Right Lower	Hatchback FWD RFT(XU10J4/Z)/RFY(XU10J4/Z)		Control Arm Bushing	510689
	1992.07-1997.10	Front Axle Left & Right Lower	Hatchback FWD RFT(XU10J4/Z)/RFY(XU10J4/Z)		Control Arm Bushing	510690
	1992.07-1997.10	Front Axle Left & Right	Hatchback FWD RFT(XU10J4/Z)/RFY(XU10J4/Z)		Tie Rod Axle Joint	S030021
	1992.07-1997.10	Front Axle Left & Right	Hatchback FWD RFT(XU10J4/Z)/RFY(XU10J4/Z)		Tie Rod End	S070104
	1992.07-1997.10	Front Axle	Hatchback FWD RFT(XU10J4/Z)/RFY(XU10J4/Z)		Stabiliser Bushing	512500
	1992.07-1997.10	Front Axle	Hatchback FWD RFT(XU10J4/Z)/RFY(XU10J4/Z)		Steering Boot	540061
	1992.07-1997.10	Front Axle	Hatchback FWD RFT(XU10J4/Z)/RFY(XU10J4/Z)		Steering Boot	540332
	1992.07-1997.10	Front Axle	Hatchback FWD RFT(XU10J4/Z)/RFY(XU10J4/Z)		Steering Boot	540414
	1992.07-1997.10	Front Axle Left	Hatchback FWD RFT(XU10J4/Z)/RFY(XU10J4/Z)	for org. no. 06629 for vehicles without power steering	Steering Rack Bellow Kit	540061S
1992.07-1997.10	Front Axle	Hatchback FWD RFT(XU10J4/Z)/RFY(XU10J4/Z)	for vehicles with power steering for vehicles without power steering. More information	Steering Rack Bellow Kit	540332S	
DAEWOO Espero						
2.0 (77 kw)	1995.02-1999.06	Front Axle Left Lower	Saloon FWD C20LE		Track Control Arm	S060404
	1995.02-1999.06	Front Axle Right Lower	Saloon FWD C20LE		Track Control Arm	S060405
	1995.02-1999.06	Front Axle Left & Right Lower	Saloon FWD C20LE		Ball Joint	S080053
	1995.02-1999.06	Front Axle Left & Right Lower	Saloon FWD C20LE		Control Arm Bushing	510843
	1995.02-1999.06	Front Axle Left & Right Lower	Saloon FWD C20LE		Control Arm Bushing	510844
	1995.02-1999.06	Front Axle Left	Saloon FWD C20LE		Tie Rod Axle Joint	S100052
	1995.02-1999.06	Front Axle Right	Saloon FWD C20LE		Tie Rod Axle Joint	S100360
	1995.02-1999.06	Front Axle Left	Saloon FWD C20LE		Tie Rod End	S070116
	1995.02-1999.06	Front Axle Right	Saloon FWD C20LE		Tie Rod End	S070117
	1995.02-1999.06	Front Axle Left & Right	Saloon FWD C20LE		Rod/Strut, stabiliser	510903
	1995.02-1999.06	Front Axle	Saloon FWD C20LE		Stabiliser Bushing	510899
	2.0 (81 kw)	1993.10-1994.09	Front Axle Left Lower	Saloon FWD C20LE		Track Control Arm
1993.10-1994.09		Front Axle Right Lower	Saloon FWD C20LE		Track Control Arm	S060405
1993.10-1994.09		Front Axle Left & Right Lower	Saloon FWD C20LE		Ball Joint	S080053
1993.10-1994.09		Front Axle Left & Right Lower	Saloon FWD C20LE		Control Arm Bushing	510843
1993.10-1994.09		Front Axle Left & Right Lower	Saloon FWD C20LE		Control Arm Bushing	510844
1993.10-1994.09		Front Axle Left	Saloon FWD C20LE		Tie Rod Axle Joint	S100052
1993.10-1994.09		Front Axle Right	Saloon FWD C20LE		Tie Rod Axle Joint	S100360
1993.10-1994.09		Front Axle Left	Saloon FWD C20LE		Tie Rod End	S070116
1993.10-1994.09		Front Axle Right	Saloon FWD C20LE		Tie Rod End	S070117
1993.10-1994.09		Front Axle Left & Right	Saloon FWD C20LE		Rod/Strut, stabiliser	510903
1993.10-1994.09	Front Axle	Saloon FWD C20LE		Stabiliser Bushing	510899	
Kondor (Doninvest)						
2.0 (98 kw)	1997.06-2000.08	Front Axle Left & Right Lower	Saloon FWD X20SED		Ball Joint	S080052
	1997.06-2000.08	Front Axle Left & Right Lower	Saloon FWD X20SED		Control Arm Bushing	515000
	1997.06-2000.08	Front Axle Left & Right Lower	Saloon FWD X20SED		Control Arm Bushing	516001
	1997.06-2000.08	Front Axle Left & Right	Saloon FWD X20SED	for vehicles with power steering	Tie Rod Axle Joint	S030041
	1997.06-2000.08	Front Axle Left & Right	Saloon FWD X20SED		Tie Rod Axle Joint	S030366
	1997.06-2000.08	Front Axle Left & Right	Saloon FWD X20SED		Tie Rod End	S071086
	1997.06-2000.08	Front Axle Left	Saloon FWD X20SED		Rod/Strut, stabiliser	S050117
	1997.06-2000.08	Front Axle Right	Saloon FWD X20SED		Rod/Strut, stabiliser	S050116
	1997.06-2000.08	Rear Axle Left & Right	Saloon FWD X20SED		Rod/Strut, stabiliser	S050256
Lanos						
1.6 (78 kw)	1997.04-2002.12	Front Axle Left Lower	Hatchback FWD L44(98CUL4)		Track Control Arm	S060404
	1997.04-2002.12	Front Axle Right Lower	Hatchback FWD L44(98CUL4)		Track Control Arm	S060405
	1997.04-2002.12	Front Axle Left & Right Lower	Hatchback FWD L44(98CUL4)		Ball Joint	S080053
	1997.04-2002.12	Front Axle Left & Right Lower	Hatchback FWD L44(98CUL4)		Control Arm Bushing	510843
	1997.04-2002.12	Front Axle Left & Right Lower	Hatchback FWD L44(98CUL4)		Control Arm Bushing	510844
	1997.04-2002.12	Front Axle Left	Hatchback FWD L44(98CUL4)		Tie Rod Axle Joint	S100052
	1997.04-2002.12	Front Axle Right	Hatchback FWD L44(98CUL4)		Tie Rod Axle Joint	S100360

	 YEAR	FITTING POSITION	BODY STYLE & DRIVE TYPE & ENGINE	REMARKS	PRODUCT	GSP Ref.
DAEWOO						
Lanos						
1.6 (78 kw)	1997.04-2002.12	Front Axle Left	Hatchback FWD L44(98CUL4)		Tie Rod End	S070116
	1997.04-2002.12	Front Axle Right	Hatchback FWD L44(98CUL4)		Tie Rod End	S070117
	1997.04-2002.12	Front Axle Left & Right	Hatchback FWD L44(98CUL4)		Rod/Strut,stabiliser	510903
	1997.04-2002.12	Front Axle	Hatchback FWD L44(98CUL4)		Stabiliser Bushing	510899
	1997.04-2002.12	Front Axle	Hatchback FWD L44(98CUL4)		Steering Boot	540276
	1997.04-2002.12	Front Axle	Hatchback FWD L44(98CUL4)		Steering Boot	540326
Leganza						
2.0 (98 kw)	1997.06-2002.12	Front Axle Left & Right Lower	Saloon FWD X20SED		Ball Joint	S080052
	1997.06-2002.12	Front Axle Left & Right Lower	Saloon FWD X20SED		Control Arm Bushing	515000
	1997.06-2002.12	Front Axle Left & Right Lower	Saloon FWD X20SED		Control Arm Bushing	516001
	1997.06-2002.12	Front Axle Left & Right	Saloon FWD X20SED	for vehicles with power steering	Tie Rod Axle Joint	S030041
	1997.06-2002.12	Front Axle Left & Right	Saloon FWD X20SED		Tie Rod Axle Joint	S030366
	1997.06-2002.12	Front Axle Left & Right	Saloon FWD X20SED		Tie Rod End	S071086
	1997.06-2002.12	Front Axle Left	Saloon FWD X20SED		Rod/Strut,stabiliser	S050117
	1997.06-2002.12	Front Axle Right	Saloon FWD X20SED		Rod/Strut,stabiliser	S050116
	1997.06-2002.12	Rear Axle Left & Right	Saloon FWD X20SED		Rod/Strut,stabiliser	S050256
Nubira						
2.0 (98 kw)	1997.05-2003.07	Front Axle Left Lower	Estate FWD X20SED	Date to:1999.06	Track Control Arm	S060401
	1997.05-2003.07	Front Axle Left Lower	Saloon FWD X20SED	Date to:1999.06	Track Control Arm	S060401
	1997.05-2003.07	Front Axle Left Lower	Estate FWD X20SED	Date from:1999.07	Track Control Arm	S060403
	1997.05-2003.07	Front Axle Left Lower	Saloon FWD X20SED	Date from:1999.07	Track Control Arm	S060403
	1997.05-2003.07	Front Axle Right Lower	Estate FWD X20SED	Date to:1999.06	Track Control Arm	S060400
	1997.05-2003.07	Front Axle Right Lower	Saloon FWD X20SED	Date to:1999.06	Track Control Arm	S060400
	1997.05-2003.07	Front Axle Right Lower	Estate FWD X20SED	Date from:1999.07	Track Control Arm	S060402
	1997.05-2003.07	Front Axle Right Lower	Saloon FWD X20SED	Date from:1999.07	Track Control Arm	S060402
	1997.05-2003.07	Front Axle Left & Right Lower	Estate FWD X20SED		Ball Joint	S080051
	1997.05-2003.07	Front Axle Left & Right Lower	Saloon FWD X20SED		Ball Joint	S080051
	1997.05-2003.07	Front Axle Left & Right Lower	Estate FWD X20SED		Control Arm Bushing	510886
	1997.05-2003.07	Front Axle Left & Right Lower	Saloon FWD X20SED		Control Arm Bushing	510886
	1997.05-2003.07	Rear Axle Left & Right Lower	Estate FWD X20SED		Control Arm Bushing	510891
	1997.05-2003.07	Rear Axle Left & Right Lower	Saloon FWD X20SED		Control Arm Bushing	510891
	1997.05-2003.07	Rear Axle Left & Right Lower	Estate FWD X20SED		Control Arm Bushing	510892
	1997.05-2003.07	Rear Axle Left & Right Lower	Saloon FWD X20SED		Control Arm Bushing	510892
	1997.05-2003.07	Front Axle Left & Right	Estate FWD X20SED		Tie Rod Axle Joint	S030041
	1997.05-2003.07	Front Axle Left & Right	Saloon FWD X20SED		Tie Rod Axle Joint	S030041
	1997.05-2003.07	Front Axle Left & Right	Estate FWD X20SED		Tie Rod End	S071086
	1997.05-2003.07	Front Axle Left & Right	Saloon FWD X20SED		Tie Rod End	S071086
	1997.05-2003.07	Front Axle Left & Right	Estate FWD X20SED		Rod/Strut,stabiliser	S050088
	1997.05-2003.07	Front Axle Left & Right	Saloon FWD X20SED		Rod/Strut,stabiliser	S050088
	1997.05-2003.07	Front Axle Left & Right	Estate FWD X20SED	Date to:1999.07	Rod/Strut,stabiliser	S100050
	1997.05-2003.07	Front Axle Left & Right	Saloon FWD X20SED	Date to:1999.07	Rod/Strut,stabiliser	S100050
	1997.05-2003.07	Rear Axle Left & Right	Estate FWD X20SED		Rod/Strut,stabiliser	S050119
	1997.05-2003.07	Rear Axle Left & Right	Saloon FWD X20SED		Rod/Strut,stabiliser	S050119
Orion						
2.0 (98 kw)	1998.06-2000.08	Front Axle Left Lower	Estate FWD Z20L	Date to:1999.06	Track Control Arm	S060401
	1998.06-2000.08	Front Axle Left Lower	Estate FWD Z20L	Date from:1999.07	Track Control Arm	S060403
	1998.06-2000.08	Front Axle Right Lower	Estate FWD Z20L	Date to:1999.06	Track Control Arm	S060400
	1998.06-2000.08	Front Axle Right Lower	Estate FWD Z20L	Date from:1999.07	Track Control Arm	S060402
	1998.06-2000.08	Front Axle Left & Right Lower	Estate FWD Z20L		Ball Joint	S080051
	1998.06-2000.08	Front Axle Left & Right Lower	Estate FWD Z20L		Control Arm Bushing	510886
	1998.06-2000.08	Rear Axle Left & Right Lower	Estate FWD Z20L		Control Arm Bushing	510891
	1998.06-2000.08	Rear Axle Left & Right Lower	Estate FWD Z20L		Control Arm Bushing	510892
	1998.06-2000.08	Front Axle Left & Right	Estate FWD Z20L		Tie Rod Axle Joint	S030041
	1998.06-2000.08	Front Axle Left & Right	Estate FWD Z20L		Tie Rod End	S071086
	1998.06-2000.08	Front Axle Left & Right	Estate FWD Z20L		Rod/Strut,stabiliser	S050088
	1998.06-2000.08	Front Axle Left & Right	Estate FWD Z20L	Date to:1999.07	Rod/Strut,stabiliser	S100050
	1998.06-2000.08	Rear Axle Left & Right	Estate FWD Z20L		Rod/Strut,stabiliser	S050119
Sens						
1.6 (78 kw)	2001.04-2005.05	Front Axle Left Lower	Hatchback FWD L44(98CUL4)		Track Control Arm	S060404
	2001.04-2005.05	Front Axle Right Lower	Hatchback FWD L44(98CUL4)		Track Control Arm	S060405
	2001.04-2005.05	Front Axle Left & Right Lower	Hatchback FWD L44(98CUL4)		Ball Joint	S080053
	2001.04-2005.05	Front Axle Left & Right Lower	Hatchback FWD L44(98CUL4)		Control Arm Bushing	510843
	2001.04-2005.05	Front Axle Left & Right Lower	Hatchback FWD L44(98CUL4)		Control Arm Bushing	510844
	2001.04-2005.05	Front Axle Left	Hatchback FWD L44(98CUL4)		Tie Rod Axle Joint	S100052



	 YEAR	FITTING POSITION	BODY STYLE & DRIVE TYPE & ENGINE	REMARKS	PRODUCT	GSP Ref.
DAEWOO						
Sens						
1.6 (78 kw)	2001.04-2005.05	Front Axle Right	Hatchback FWD L44(98CUL4)		Tie Rod Axle Joint	S100360
	2001.04-2005.05	Front Axle Left	Hatchback FWD L44(98CUL4)		Tie Rod End	S070116
	2001.04-2005.05	Front Axle Right	Hatchback FWD L44(98CUL4)		Tie Rod End	S070117
	2001.04-2005.05	Front Axle Left & Right	Hatchback FWD L44(98CUL4)		Rod/Strut, stabiliser	510903
	2001.04-2005.05	Front Axle	Hatchback FWD L44(98CUL4)		Stabiliser Bushing	510899
	2001.04-2005.05	Front Axle	Hatchback FWD L44(98CUL4)		Steering Boot	540276
	2001.04-2005.05	Front Axle	Hatchback FWD L44(98CUL4)		Steering Boot	540326
DAIHATSU						
Applause						
1.6 (77 kw)	1989.06-1997.08	Front Axle Left	Hatchback FWD HDE		Tie Rod End	S070118
	1989.06-1997.08	Front Axle Right	Hatchback FWD HDE		Tie Rod End	S070120
	1989.06-1997.08	Front Axle Right	Hatchback FWD HDE		Tie Rod End	S070122
	1989.06-1997.08	Front Axle Left & Right	Hatchback FWD HDE		Tie Rod End	S070824
	1989.06-1997.08	Front Axle Left & Right	Hatchback FWD HDE		Tie Rod End	S070866
Charade						
1.3 (62 kw)	1993.03-2000.12	Front Axle Left & Right	Hatchback FWD HCE		Tie Rod Axle Joint	S030524
	1993.03-2000.12	Front Axle Left	Hatchback FWD HCE		Tie Rod End	S070118
	1993.03-2000.12	Front Axle Left	Hatchback FWD HCE		Tie Rod End	S071321
	1993.03-2000.12	Front Axle Right	Hatchback FWD HCE		Tie Rod End	S070122
	1993.03-2000.12	Front Axle Right	Hatchback FWD HCE		Tie Rod End	S071322
	1993.03-2000.12	Front Axle Left & Right	Hatchback FWD HCE		Tie Rod End	S070824
1993.03-2000.12	Front Axle Left & Right	Hatchback FWD HCE		Tie Rod End	S070866	
Cuore						
0.8 (31 kw)	1994.08-1999.12	Front Axle Left Lower	Hatchback FWD ED20		Track Control Arm	S061137
	1994.08-1999.12	Front Axle Right Lower	Hatchback FWD ED20		Track Control Arm	S061136
	1994.08-1999.12	Front Axle Left & Right Lower	Hatchback FWD ED20		Control Arm Bushing	514917
	1994.08-1999.12	Front Axle Left	Hatchback FWD ED20		Tie Rod End	S070121
	1994.08-1999.12	Front Axle Right	Hatchback FWD ED20		Tie Rod End	S070120
0.8 (32 kw)	1995.01-1998.08	Front Axle Left Lower	Hatchback FWD ED20		Track Control Arm	S061137
	1995.01-1998.08	Front Axle Right Lower	Hatchback FWD ED20		Track Control Arm	S061136
	1995.01-1998.08	Front Axle Left & Right Lower	Hatchback FWD ED20		Control Arm Bushing	514917
	1995.01-1998.08	Front Axle Left	Hatchback FWD ED20		Tie Rod End	S070121
	1995.01-1998.08	Front Axle Right	Hatchback FWD ED20		Tie Rod End	S070120
Feroza						
1.6 (63 kw)	1988.10-1993.08	Front Axle Left	Terrain cab wagon closed 4WD HDC		Tie Rod End	S070639
	1988.10-1993.08	Front Axle Right	Terrain cab wagon closed 4WD HDC		Tie Rod End	S070724
Gran Move						
1.5 (66 kw)	1996.08-1999.02	Front Axle Left	MPV FWD HEEG		Tie Rod End	S070118
	1996.08-1999.02	Front Axle Right	MPV FWD HEEG		Tie Rod End	S070122
Mira						
0.8 (32 kw)	1990.10-1995.10	Front Axle Left	Hatchback FWD ED10		Tie Rod End	S070121
	1990.10-1995.10	Front Axle Right	Hatchback FWD ED10		Tie Rod End	S070120
Pyzar						
1.5 (66 kw)	1997.01-1998.12	Front Axle Left	MPV FWD HEEG		Tie Rod End	S070118
	1997.01-1998.12	Front Axle Right	MPV FWD HEEG		Tie Rod End	S070122
Sportrak						
1.6 (63 kw)	1988.10-1995.12	Front Axle Left	Terrain cab wagon closed 4WD HDC		Tie Rod End	S070639
	1988.10-1995.12	Front Axle Right	Terrain cab wagon closed 4WD HDC		Tie Rod End	S070724
Terios						
1.3 (61 kw)	1997.03-2000.09	Front Axle Left Lower	Terrain cab wagon closed 4WD HCEJ		Track Control Arm	S061110
	1997.03-2000.09	Front Axle Right Lower	Terrain cab wagon closed 4WD HCEJ		Track Control Arm	S061111
	1997.03-2000.09	Front Axle Left & Right Lower	Terrain cab wagon closed 4WD HCEJ		Control Arm Bushing	513542
	1997.03-2000.09	Front Axle Left & Right Lower	Terrain cab wagon closed 4WD HCEJ		Control Arm Bushing	514056
	1997.03-2000.09	Front Axle Left & Right Lower	Terrain cab wagon closed 4WD HCEJ		Control Arm Bushing	517842
	1997.03-2000.09	Rear Axle Left & Right Centre	Terrain cab wagon closed 4WD HCEJ		Control Arm Bushing	517449
	1997.03-2000.09	Front Axle Left & Right	Terrain cab wagon closed 4WD HCEJ		Tie Rod Axle Joint	S031020
	1997.03-2000.09	Front Axle Left & Right	Terrain cab wagon closed 4WD HCEJ		Tie Rod End	S070119
	1997.03-2000.09	Front Axle Left & Right	Terrain cab wagon closed 4WD HCEJ		Rod/Strut, stabiliser	516867
	1997.03-2000.09	Front Axle	Terrain cab wagon closed 4WD HCEJ		Stabiliser Bushing	516801
DODGE						
Caravan						
2.4 (112 kw)	2001.01-2007.12	Front Axle Left Lower	MPV FWD EDZ		Track Control Arm	S061867
	2001.01-2007.12	Front Axle Right Lower	MPV FWD EDZ		Track Control Arm	S061908
	2001.01-2007.12	Front Axle Left & Right	MPV FWD EDZ		Tie Rod End	S070548



	 YEAR	FITTING POSITION	BODY STYLE & DRIVE TYPE & ENGINE	REMARKS	PRODUCT	GSP Ref.
DODGE Caravan						
2.4 (112 kw)	2001.01-2007.12	Front Axle Left & Right	MPV FWD EDZ		Rod/Strut,stabiliser	S051229
	2001.01-2007.12	Rear Axle Left & Right	MPV FWD EDZ		Rod/Strut,stabiliser	S050096
Challenger						
5.7 (277 kw)	2008.09-2014.12	Front Axle Left & Right Lower Outer	Coupe RWD EZC/EZH		Track Control Arm	S063205
	2008.09-2014.12	Front Axle Left & Right	Coupe RWD EZC/EZH		Control Arm Bushing	535016
	2008.09-2014.12	Front Axle Left & Right Lower Inner	Coupe RWD EZC/EZH		Control Arm Bushing	519652
	2008.09-2014.12	Front Axle Left & Right Lower Inner	Coupe RWD EZC/EZH		Control Arm Bushing	519661
	2008.09-2014.12	Rear Axle Left & Right Lower Inner	Coupe RWD EZC/EZH		Control Arm Bushing	530527
	2008.09-2014.12	Rear Axle Left & Right Lower Outer	Coupe RWD EZC/EZH	AT,Model year from:2008,Model year to:2015	Control Arm Bushing	516553
	2008.09-2014.12	Front Axle Left & Right	Coupe RWD EZC/EZH		Tie Rod End	S071013
	2008.09-2014.12	Front Axle Left	Coupe RWD EZC/EZH		Rod/Strut,stabiliser	S050820
	2008.09-2014.12	Front Axle Right	Coupe RWD EZC/EZH		Rod/Strut,stabiliser	S050819
	2008.09-2014.12	Front Axle	Coupe RWD EZC/EZH		Steering Rack Bellow Kit	540211K
6.1 (313 kw)	2008.01-	Front Axle Left & Right Lower Outer	Coupe RWD ESF		Track Control Arm	S063205
Durango						
3.6 (216 kw)	2011.01-	Rear Axle Left & Right Lower	SUV 4WD ERB		Ball Joint	S080674
	2011.01-	Front Axle Left & Right Lower	SUV 4WD ERB		Control Arm Bushing	517766
	2011.01-	Rear Axle Left & Right Upper	SUV 4WD ERB		Control Arm Bushing	532971
	2011.01-	Front Axle Left	SUV 4WD ERB		Rod/Strut,stabiliser	S051344
	2011.01-	Front Axle Right	SUV 4WD ERB		Rod/Strut,stabiliser	S051343
	2011.01-	Rear Axle Left & Right	SUV 4WD ERB		Rod/Strut,stabiliser	S051317
Grand Caravan						
3.8 (122 kw)	1995.10-2000.06	Front Axle Left & Right	MPV FWD EGH	Date to:1996	Rod/Strut,stabiliser	511307
	1995.10-2000.06	Front Axle Left & Right	MPV FWD EGH	Date to:1996	Rod/Strut,stabiliser	S051229
Journey						
2.7 (136 kw)	2008.06-	Front Axle Left & Right Lower	MPV FWD EER		Ball Joint	S080640
	2008.06-	Front Axle Left & Right Lower	MPV FWD EER	Date to:2014	Control Arm Bushing	516175
	2008.06-	Front Axle Left & Right Lower	MPV FWD EER		Control Arm Bushing	532427
	2008.06-	Front Axle Left & Right	MPV FWD EER		Tie Rod Axle Joint	S030948
	2008.06-	Front Axle Left & Right	MPV FWD EER		Tie Rod End	S071136
	2008.06-	Front Axle Left & Right	MPV FWD EER	Date to:2015	Rod/Strut,stabiliser	S050592
	2008.06-	Front Axle Left & Right	MPV FWD EER		Rod/Strut,stabiliser	S050704
3.6 (206 kw)	2011.01-	Front Axle Left & Right Lower	MPV FWD ERB		Ball Joint	S080640
	2011.01-	Front Axle Left & Right Lower	MPV FWD ERB		Control Arm Bushing	516175
	2011.01-	Front Axle Left & Right	MPV FWD ERB		Tie Rod Axle Joint	S030948
	2011.01-	Front Axle Left & Right	MPV FWD ERB		Tie Rod End	S071136
	2011.01-	Front Axle Left & Right	MPV FWD ERB		Rod/Strut,stabiliser	S050592
	2011.01-	Front Axle Left & Right	MPV FWD ERB		Rod/Strut,stabiliser	S050704
	2011.03-	Front Axle Left & Right Lower	MPV 4WD ERB		Ball Joint	S080640
	2011.03-	Front Axle Left & Right Lower	MPV 4WD ERB		Control Arm Bushing	516175
	2011.03-	Front Axle Left & Right	MPV 4WD ERB		Tie Rod Axle Joint	S030948
	2011.03-	Front Axle Left & Right	MPV 4WD ERB		Tie Rod End	S071136
	2011.03-	Front Axle Left & Right	MPV 4WD ERB	Date to:2015	Rod/Strut,stabiliser	S050592
	2011.03-	Front Axle Left & Right	MPV 4WD ERB		Rod/Strut,stabiliser	S050704
Nitro						
3.7 (151 kw)	2006.10-2012.04	Front Axle Left & Right Lower	SUV 4WD EKG		Ball Joint	S080639
	2006.10-2012.04	Front Axle Left & Right Lower	SUV 4WD EKG		Control Arm Bushing	511367
	2006.10-2012.04	Front Axle Left & Right	SUV 4WD EKG		Tie Rod Axle Joint	S030786
	2006.10-2012.04	Front Axle Left & Right	SUV 4WD EKG		Tie Rod Axle Joint	S030821
	2006.10-2012.04	Front Axle Left	SUV 4WD EKG		Tie Rod End	S071011
	2006.10-2012.04	Front Axle Right	SUV 4WD EKG		Tie Rod End	S071012
	2006.10-2012.04	Front Axle Left & Right	SUV 4WD EKG		Rod/Strut,stabiliser	S050885
DS DS5						
1.6 (121 kw)	2015.07-2018.12	Front Axle Left & Right Lower	Hatchback FWD EP6FDT		Ball Joint	S080040
	2015.07-2018.12	Front Axle Left & Right Lower	Hatchback FWD EP6FDT		Control Arm Bushing	510735
	2015.07-2018.12	Front Axle Left & Right	Hatchback FWD EP6FDT		Tie Rod End	S070094
	2015.07-2018.12	Front Axle Left & Right	Hatchback FWD EP6FDT		Rod/Strut,stabiliser	S050109
FERRARI 550 Maranello						
5.5 (357 kw)	1996.04-2001.12	Front Axle Left & Right	Coupe RWD F131B46		Tie Rod End	S070866



	 YEAR	FITTING POSITION	BODY STYLE & DRIVE TYPE & ENGINE	REMARKS	PRODUCT	GSP Ref.
FIAT						
147						
1.3 (45 kw)	1980.07-1984.08	Front Axle Left & Right Lower	Hatchback FWD 127 A2.011		Track Control Arm	S061002
	1980.07-1984.08	Front Axle Left & Right	Hatchback FWD 127 A2.011		Tie Rod End	S070738
500						
1.4 (74 kw)	2007.07-	Front Axle Left Lower	Hatchback FWD 169A3000		Track Control Arm	S060169
	2007.07-	Front Axle Right Lower	Hatchback FWD 169A3000		Track Control Arm	S060170
	2007.07-	Front Axle Left & Right	Hatchback FWD 169A3000		Tie Rod Axle Joint	S030369
	2007.07-	Front Axle Left	Hatchback FWD 169A3000		Tie Rod End	S070130
	2007.07-	Front Axle Right	Hatchback FWD 169A3000		Tie Rod End	S070131
	2007.07-	Front Axle Left & Right	Hatchback FWD 169A3000		Rod/Strut, stabiliser	S050126
Albea						
1.2 (59 kw)	2002.01-2011.12	Front Axle Left & Right Lower	Saloon FWD 188A5000	Date from:2002.01	Ball Joint	S080055
	2002.01-2011.12	Front Axle Left & Right Lower	Saloon FWD 188A5000	Date from:2002.10	Ball Joint	S080056
Coupe						
2.0 (102 kw)	1994.02-1996.08	Front Axle Left Lower	Coupe FWD 836A3000/836A3011		Track Control Arm	S060019
	1994.02-1996.08	Front Axle Right Lower	Coupe FWD 836A3000/836A3011		Track Control Arm	S060020
	1994.02-1996.08	Front Axle Left	Coupe FWD 836A3000/836A3011		Tie Rod End	S070010
	1994.02-1996.08	Front Axle Right	Coupe FWD 836A3000/836A3011		Tie Rod End	S070011
	1994.02-1996.08	Front Axle Left & Right	Coupe FWD 836A3000/836A3011		Rod/Strut, stabiliser	S050016
Croma						
2.4 (147 kw)	2005.06-2011.12	Front Axle Left Lower	Estate FWD 939A3000		Track Control Arm	S060179
	2005.06-2011.12	Front Axle Right Lower	Estate FWD 939A3000		Track Control Arm	S060180
	2005.06-2011.12	Rear Axle Left & Right Upper	Estate FWD 939A3000		Track Control Arm	S060181
	2005.06-2011.12	Rear Axle Left & Right Lower Inner	Estate FWD 939A3000		Track Control Arm	S063152
	2005.06-2011.12	Front Axle Left & Right Lower	Estate FWD 939A3000		Control Arm Bushing	510925
	2005.06-2011.12	Front Axle Left & Right Lower	Estate FWD 939A3000		Control Arm Bushing	510926
	2005.06-2011.12	Rear Axle Left & Right Upper	Estate FWD 939A3000		Control Arm Bushing	517262
	2005.06-2011.12	Front Axle Left & Right Lower	Estate FWD 939A3000		Control Arm Bushing Kit	510925S
	2005.06-2011.12	Front Axle Left	Estate FWD 939A3000		Tie Rod End	S070140
	2005.06-2011.12	Front Axle Right	Estate FWD 939A3000		Tie Rod End	S070141
	2005.06-2011.12	Front Axle Left & Right	Estate FWD 939A3000		Rod/Strut, stabiliser	S050131
	2005.06-2011.12	Rear Axle Left & Right	Estate FWD 939A3000		Rod/Strut, stabiliser	S050534
	2005.06-2011.12	Front Axle	Estate FWD 939A3000		Stabiliser Bushing	517182
	2005.06-2011.12	Front Axle	Estate FWD 939A3000		Stabiliser Bushing	517351
	2005.06-2011.12	Rear Axle	Estate FWD 939A3000		Stabiliser Bushing	517779
Ducato 10						
2.5 (62 kw)	1994.06-1999.12	Front Axle Left Lower	VAN FWD 814067		Track Control Arm	S060383
	1994.06-1999.12	Front Axle Left Lower	VAN FWD 814067	Payload[kg]:1800	Track Control Arm	S060385
	1994.06-1999.12	Front Axle Right Lower	VAN FWD 814067		Track Control Arm	S060382
	1994.06-1999.12	Front Axle Right Lower	VAN FWD 814067	Payload[kg]:1800	Track Control Arm	S060384
	1994.06-1999.12	Front Axle Left & Right Lower	VAN FWD 814067	For OE no.1331640080	Ball Joint	S080038
	1994.06-1999.12	Front Axle Left & Right Lower	VAN FWD 814067		Ball Joint	S080039
	1994.06-1999.12	Front Axle Left & Right Lower	VAN FWD 814067		Ball Joint	S081034
	1994.06-1999.12	Front Axle Left & Right Lower	VAN FWD 814067		Control Arm Bushing	510714
	1994.06-1999.12	Front Axle Left & Right Lower	VAN FWD 814067		Control Arm Bushing Kit	510715S
	1994.06-1999.12	Front Axle Left & Right	VAN FWD 814067		Tie Rod Axle Joint	S030026
	1994.06-1999.12	Front Axle Left & Right	VAN FWD 814067		Tie Rod End	S070098
	1994.06-1999.12	Front Axle Left & Right	VAN FWD 814067		Rod/Strut, stabiliser	S050100
	1994.06-1999.12	Front Axle	VAN FWD 814067		Steering Boot	540189
	1994.06-1999.12	Front Axle	VAN FWD 814067		Steering Boot	540194
	1994.06-1999.12	Front Axle Left	VAN FWD 814067		Steering Rack Bellow Kit	540189S
	1994.06-1999.12	Front Axle Right	VAN FWD 814067		Steering Rack Bellow Kit	540194S
2.8 (64 kw)	1998.05-2001.09	Front Axle Left Lower	VAN FWD 814063		Track Control Arm	S060383
	1998.05-2001.09	Front Axle Left Lower	VAN FWD 814063	Payload[kg]:1800	Track Control Arm	S060385
	1998.05-2001.09	Front Axle Right Lower	VAN FWD 814063		Track Control Arm	S060382
	1998.05-2001.09	Front Axle Right Lower	VAN FWD 814063	Payload[kg]:1800	Track Control Arm	S060384
	1998.05-2001.09	Front Axle Left & Right Lower	VAN FWD 814063	For OE no.1331640080	Ball Joint	S080038
	1998.05-2001.09	Front Axle Left & Right Lower	VAN FWD 814063		Ball Joint	S080039
	1998.05-2001.09	Front Axle Left & Right Lower	VAN FWD 814063		Ball Joint	S081034
	1998.05-2001.09	Front Axle Left & Right Lower	VAN FWD 814063		Control Arm Bushing	510714
	1998.05-2001.09	Front Axle Left & Right	VAN FWD 814063		Tie Rod Axle Joint	S030026
	1998.05-2001.09	Front Axle Left & Right	VAN FWD 814063		Tie Rod End	S070098
	1998.05-2001.09	Front Axle Left & Right	VAN FWD 814063		Rod/Strut, stabiliser	S050100
	1998.05-2001.09	Front Axle	VAN FWD 814063		Steering Boot	540189
	1998.05-2001.09	Front Axle	VAN FWD 814063		Steering Boot	540194



	 YEAR	FITTING POSITION	BODY STYLE & DRIVE TYPE & ENGINE	REMARKS	PRODUCT	GSP Ref.	
FIAT Ducato 10							
2.8 (64 kw)	1998.05-2001.09	Front Axle Left	VAN FWD 814063		Steering Rack Bellow Kit	540189S	
	1998.05-2001.09	Front Axle Right	VAN FWD 814063		Steering Rack Bellow Kit	540194S	
2.8 (90 kw)	1998.05-2001.09	Front Axle Left Lower	BUS FWD 814043		Track Control Arm	S060135	
	1998.05-2001.09	Front Axle Left Lower	VAN FWD 814043		Track Control Arm	S060383	
	1998.05-2001.09	Front Axle Left Lower	BUS FWD 814043		Track Control Arm	S060383	
	1998.05-2001.09	Front Axle Left Lower	VAN FWD 814043	Payload[kg]:1800	Track Control Arm	S060385	
	1998.05-2001.09	Front Axle Left Lower	BUS FWD 814043	Payload[kg]:1800	Track Control Arm	S060385	
	1998.05-2001.09	Front Axle Right Lower	BUS FWD 814043		Track Control Arm	S060136	
	1998.05-2001.09	Front Axle Right Lower	VAN FWD 814043		Track Control Arm	S060382	
	1998.05-2001.09	Front Axle Right Lower	BUS FWD 814043		Track Control Arm	S060382	
	1998.05-2001.09	Front Axle Right Lower	VAN FWD 814043	Payload[kg]:1800	Track Control Arm	S060384	
	1998.05-2001.09	Front Axle Right Lower	BUS FWD 814043	Payload[kg]:1800	Track Control Arm	S060384	
	1998.05-2001.09	Front Axle Left & Right Lower	VAN FWD 814043	For OE no.1331640080	Ball Joint	S080038	
	1998.05-2001.09	Front Axle Left & Right Lower	BUS FWD 814043	For OE no.1331640080	Ball Joint	S080038	
	1998.05-2001.09	Front Axle Left & Right Lower	VAN FWD 814043		Ball Joint	S080039	
	1998.05-2001.09	Front Axle Left & Right Lower	BUS FWD 814043		Ball Joint	S080039	
	1998.05-2001.09	Front Axle Left & Right Lower	VAN FWD 814043		Ball Joint	S081034	
	1998.05-2001.09	Front Axle Left & Right Lower	BUS FWD 814043		Ball Joint	S081034	
	1998.05-2001.09	Front Axle Left & Right Lower	VAN FWD 814043		Control Arm Bushing	510714	
	1998.05-2001.09	Front Axle Left & Right Lower	BUS FWD 814043		Control Arm Bushing	510714	
	1998.05-2001.09	Front Axle Left & Right	VAN FWD 814043		Tie Rod Axle Joint	S030026	
	1998.05-2001.09	Front Axle Left & Right	BUS FWD 814043		Tie Rod Axle Joint	S030026	
	1998.05-2001.09	Front Axle Left & Right	VAN FWD 814043		Tie Rod End	S070098	
	1998.05-2001.09	Front Axle Left & Right	BUS FWD 814043		Tie Rod End	S070098	
	1998.05-2001.09	Front Axle Left & Right	VAN FWD 814043		Rod/Strut,stabiliser	S050100	
	1998.05-2001.09	Front Axle Left & Right	BUS FWD 814043		Rod/Strut,stabiliser	S050100	
	1998.05-2001.09	Front Axle	VAN FWD 814043		Steering Boot	540189	
	1998.05-2001.09	Front Axle	BUS FWD 814043		Steering Boot	540189	
	1998.05-2001.09	Front Axle	VAN FWD 814043		Steering Boot	540194	
	1998.05-2001.09	Front Axle	BUS FWD 814043		Steering Boot	540194	
	1998.05-2001.09	Front Axle Left	VAN FWD 814043		Steering Rack Bellow Kit	540189S	
	1998.05-2001.09	Front Axle Left	BUS FWD 814043		Steering Rack Bellow Kit	540189S	
	1998.05-2001.09	Front Axle Right	VAN FWD 814043		Steering Rack Bellow Kit	540194S	
	1998.05-2001.09	Front Axle Right	BUS FWD 814043		Steering Rack Bellow Kit	540194S	
	Ducato 14						
2.5 (62 kw)	1994.06-1998.04	Front Axle Left Lower	VAN FWD 814067		Track Control Arm	S060383	
	1994.06-1998.04	Front Axle Left Lower	VAN FWD 814067	Payload[kg]:1800	Track Control Arm	S060385	
	1994.06-1998.04	Front Axle Right Lower	VAN FWD 814067		Track Control Arm	S060382	
	1994.06-1998.04	Front Axle Right Lower	VAN FWD 814067	Payload[kg]:1800	Track Control Arm	S060384	
	1994.06-1998.04	Front Axle Left & Right Lower	VAN FWD 814067	For OE no.1331640080	Ball Joint	S080038	
	1994.06-1998.04	Front Axle Left & Right Lower	VAN FWD 814067		Ball Joint	S080039	
	1994.06-1998.04	Front Axle Left & Right Lower	VAN FWD 814067		Ball Joint	S081034	
	1994.06-1998.04	Front Axle Left & Right Lower	VAN FWD 814067		Control Arm Bushing	510714	
	1994.06-1998.04	Front Axle Left & Right Lower	VAN FWD 814067		Control Arm Bushing Kit	510715S	
	1994.06-1998.04	Front Axle Left & Right	VAN FWD 814067		Tie Rod Axle Joint	S030026	
	1994.06-1998.04	Front Axle Left & Right	VAN FWD 814067		Tie Rod End	S070098	
	1994.06-1998.04	Front Axle Left & Right	VAN FWD 814067		Rod/Strut,stabiliser	S050100	
	1994.06-1998.04	Front Axle	VAN FWD 814067		Steering Boot	540189	
	1994.06-1998.04	Front Axle	VAN FWD 814067		Steering Boot	540194	
	1994.06-1998.04	Front Axle Left	VAN FWD 814067		Steering Rack Bellow Kit	540189S	
	1994.06-1998.04	Front Axle Right	VAN FWD 814067		Steering Rack Bellow Kit	540194S	
	2.8 (64 kw)	1998.05-2001.09	Front Axle Left Lower	VAN FWD 814063		Track Control Arm	S060383
		1998.05-2001.09	Front Axle Left Lower	VAN FWD 814063	Payload[kg]:1800	Track Control Arm	S060385
		1998.05-2001.09	Front Axle Right Lower	VAN FWD 814063		Track Control Arm	S060382
		1998.05-2001.09	Front Axle Right Lower	VAN FWD 814063	Payload[kg]:1800	Track Control Arm	S060384
1998.05-2001.09		Front Axle Left & Right Lower	VAN FWD 814063	For OE no.1331640080	Ball Joint	S080038	
1998.05-2001.09		Front Axle Left & Right Lower	VAN FWD 814063		Ball Joint	S080039	
1998.05-2001.09		Front Axle Left & Right Lower	VAN FWD 814063		Ball Joint	S081034	
1998.05-2001.09		Front Axle Left & Right Lower	VAN FWD 814063		Control Arm Bushing	510714	
1998.05-2001.09		Front Axle Left & Right	VAN FWD 814063		Tie Rod Axle Joint	S030026	
1998.05-2001.09		Front Axle Left & Right	VAN FWD 814063		Tie Rod End	S070098	
1998.05-2001.09		Front Axle Left & Right	VAN FWD 814063		Rod/Strut,stabiliser	S050100	
1998.05-2001.09		Front Axle	VAN FWD 814063		Steering Boot	540189	
1998.05-2001.09		Front Axle	VAN FWD 814063		Steering Boot	540194	



	 YEAR	FITTING POSITION	BODY STYLE & DRIVE TYPE & ENGINE	REMARKS	PRODUCT	GSP Ref.
FIAT Ducato 14						
2.8 (64 kw)	1998.05-2001.09	Front Axle Left	VAN FWD 814063		Steering Rack Bellow Kit	540189S
	1998.05-2001.09	Front Axle Right	VAN FWD 814063		Steering Rack Bellow Kit	540194S
2.8 (90 kw)	1998.05-2001.09	Front Axle Left Lower	VAN FWD 814043		Track Control Arm	S060383
	1998.05-2001.09	Front Axle Left Lower	VAN FWD 814043	Payload[kg]:1800	Track Control Arm	S060385
	1998.05-2001.09	Front Axle Right Lower	VAN FWD 814043		Track Control Arm	S060382
	1998.05-2001.09	Front Axle Right Lower	VAN FWD 814043	Payload[kg]:1800	Track Control Arm	S060384
	1998.05-2001.09	Front Axle Left & Right Lower	VAN FWD 814043	For OE no.1331640080	Ball Joint	S080038
	1998.05-2001.09	Front Axle Left & Right Lower	VAN FWD 814043		Ball Joint	S080039
	1998.05-2001.09	Front Axle Left & Right Lower	VAN FWD 814043		Ball Joint	S081034
	1998.05-2001.09	Front Axle Left & Right Lower	VAN FWD 814043		Control Arm Bushing	510714
	1998.05-2001.09	Front Axle Left & Right	VAN FWD 814043		Tie Rod Axle Joint	S030026
	1998.05-2001.09	Front Axle Left & Right	VAN FWD 814043		Tie Rod End	S070098
	1998.05-2001.09	Front Axle Left & Right	VAN FWD 814043		Rod/Strut, stabiliser	S050100
	1998.05-2001.09	Front Axle	VAN FWD 814043		Steering Boot	540189
	1998.05-2001.09	Front Axle	VAN FWD 814043		Steering Boot	540194
	1998.05-2001.09	Front Axle Left	VAN FWD 814043		Steering Rack Bellow Kit	540189S
	1998.05-2001.09	Front Axle Right	VAN FWD 814043		Steering Rack Bellow Kit	540194S
Ducato 18						
2.5 (62 kw)	1994.06-1999.12	Front Axle Left Lower	VAN FWD 814067		Track Control Arm	S060383
	1994.06-1999.12	Front Axle Left Lower	VAN FWD 814067	Payload[kg]:1800	Track Control Arm	S060385
	1994.06-1999.12	Front Axle Right Lower	VAN FWD 814067		Track Control Arm	S060382
	1994.06-1999.12	Front Axle Right Lower	VAN FWD 814067	Payload[kg]:1800	Track Control Arm	S060384
	1994.06-1999.12	Front Axle Left & Right Lower	VAN FWD 814067	For OE no.1331640080	Ball Joint	S080038
	1994.06-1999.12	Front Axle Left & Right Lower	VAN FWD 814067		Ball Joint	S080039
	1994.06-1999.12	Front Axle Left & Right Lower	VAN FWD 814067		Ball Joint	S081034
	1994.06-1999.12	Front Axle Left & Right Lower	VAN FWD 814067		Control Arm Bushing	510714
	1994.06-1999.12	Front Axle Left & Right Lower	VAN FWD 814067		Control Arm Bushing Kit	510715S
	1994.06-1999.12	Front Axle Left & Right	VAN FWD 814067		Tie Rod Axle Joint	S030026
	1994.06-1999.12	Front Axle Left & Right	VAN FWD 814067		Tie Rod End	S070098
	1994.06-1999.12	Front Axle Left & Right	VAN FWD 814067		Rod/Strut, stabiliser	S050100
	1994.06-1999.12	Front Axle	VAN FWD 814067		Steering Boot	540189
	1994.06-1999.12	Front Axle	VAN FWD 814067		Steering Boot	540194
	1994.06-1999.12	Front Axle Left	VAN FWD 814067		Steering Rack Bellow Kit	540189S
1994.06-1999.12	Front Axle Right	VAN FWD 814067		Steering Rack Bellow Kit	540194S	
2.8 (64 kw)	1998.05-2001.09	Front Axle Left Lower	VAN FWD 814063		Track Control Arm	S060383
	1998.05-2001.09	Front Axle Left Lower	VAN FWD 814063	Payload[kg]:1800	Track Control Arm	S060385
	1998.05-2001.09	Front Axle Right Lower	VAN FWD 814063		Track Control Arm	S060382
	1998.05-2001.09	Front Axle Right Lower	VAN FWD 814063	Payload[kg]:1800	Track Control Arm	S060384
	1998.05-2001.09	Front Axle Left & Right Lower	VAN FWD 814063	For OE no.1331640080	Ball Joint	S080038
	1998.05-2001.09	Front Axle Left & Right Lower	VAN FWD 814063		Ball Joint	S080039
	1998.05-2001.09	Front Axle Left & Right Lower	VAN FWD 814063		Ball Joint	S081034
	1998.05-2001.09	Front Axle Left & Right Lower	VAN FWD 814063		Control Arm Bushing	510714
	1998.05-2001.09	Front Axle Left & Right	VAN FWD 814063		Tie Rod Axle Joint	S030026
	1998.05-2001.09	Front Axle Left & Right	VAN FWD 814063		Tie Rod End	S070098
	1998.05-2001.09	Front Axle Left & Right	VAN FWD 814063		Rod/Strut, stabiliser	S050100
	1998.05-2001.09	Front Axle	VAN FWD 814063		Steering Boot	540189
	1998.05-2001.09	Front Axle	VAN FWD 814063		Steering Boot	540194
	1998.05-2001.09	Front Axle Left	VAN FWD 814063		Steering Rack Bellow Kit	540189S
	1998.05-2001.09	Front Axle Right	VAN FWD 814063		Steering Rack Bellow Kit	540194S
2.8 (90 kw)	1998.05-2001.09	Front Axle Left Lower	BUS FWD 814043		Track Control Arm	S060135
	1998.05-2001.09	Front Axle Left Lower	BUS FWD 814043		Track Control Arm	S060383
	1998.05-2001.09	Front Axle Left Lower	VAN FWD 814043		Track Control Arm	S060383
	1998.05-2001.09	Front Axle Left Lower	BUS FWD 814043	Payload[kg]:1800	Track Control Arm	S060385
	1998.05-2001.09	Front Axle Left Lower	VAN FWD 814043	Payload[kg]:1800	Track Control Arm	S060385
	1998.05-2001.09	Front Axle Right Lower	BUS FWD 814043		Track Control Arm	S060136
	1998.05-2001.09	Front Axle Right Lower	BUS FWD 814043		Track Control Arm	S060382
	1998.05-2001.09	Front Axle Right Lower	VAN FWD 814043		Track Control Arm	S060382
	1998.05-2001.09	Front Axle Right Lower	BUS FWD 814043	Payload[kg]:1800	Track Control Arm	S060384
	1998.05-2001.09	Front Axle Right Lower	VAN FWD 814043	Payload[kg]:1800	Track Control Arm	S060384
	1998.05-2001.09	Front Axle Left & Right Lower	BUS FWD 814043	For OE no.1331640080	Ball Joint	S080038
	1998.05-2001.09	Front Axle Left & Right Lower	VAN FWD 814043	For OE no.1331640080	Ball Joint	S080038
	1998.05-2001.09	Front Axle Left & Right Lower	BUS FWD 814043		Ball Joint	S080039
	1998.05-2001.09	Front Axle Left & Right Lower	VAN FWD 814043		Ball Joint	S080039
	1998.05-2001.09	Front Axle Left & Right Lower	BUS FWD 814043		Ball Joint	S081034



	 YEAR	FITTING POSITION	BODY STYLE & DRIVE TYPE & ENGINE	REMARKS	PRODUCT	GSP Ref.
FIAT Ducato 18 2.8 (90 kw)	1998.05-2001.09	Front Axle Left & Right Lower	VAN FWD 814043		Ball Joint	S081034
	1998.05-2001.09	Front Axle Left & Right Lower	BUS FWD 814043		Control Arm Bushing	510714
	1998.05-2001.09	Front Axle Left & Right Lower	VAN FWD 814043		Control Arm Bushing	510714
	1998.05-2001.09	Front Axle Left & Right	BUS FWD 814043		Tie Rod Axle Joint	S030026
	1998.05-2001.09	Front Axle Left & Right	VAN FWD 814043		Tie Rod Axle Joint	S030026
	1998.05-2001.09	Front Axle Left & Right	BUS FWD 814043		Tie Rod End	S070098
	1998.05-2001.09	Front Axle Left & Right	VAN FWD 814043		Tie Rod End	S070098
	1998.05-2001.09	Front Axle Left & Right	BUS FWD 814043		Rod/Strut, stabiliser	S050100
	1998.05-2001.09	Front Axle Left & Right	VAN FWD 814043		Rod/Strut, stabiliser	S050100
	1998.05-2001.09	Front Axle	BUS FWD 814043		Steering Boot	540189
	1998.05-2001.09	Front Axle	VAN FWD 814043		Steering Boot	540189
	1998.05-2001.09	Front Axle	BUS FWD 814043		Steering Boot	540194
	1998.05-2001.09	Front Axle	VAN FWD 814043		Steering Boot	540194
	1998.05-2001.09	Front Axle Left	BUS FWD 814043		Steering Rack Bellow Kit	540189S
	1998.05-2001.09	Front Axle Left	VAN FWD 814043		Steering Rack Bellow Kit	540189S
	1998.05-2001.09	Front Axle Right	BUS FWD 814043		Steering Rack Bellow Kit	540194S
	1998.05-2001.09	Front Axle Right	VAN FWD 814043		Steering Rack Bellow Kit	540194S
Ducato 28 2.3 (96 kw)	2014.03-	Front Axle Left Lower	VAN FWD F1AE3481D		Track Control Arm	S060135
	2014.03-	Front Axle Right Lower	VAN FWD F1AE3481D		Track Control Arm	S060136
	2014.03-	Front Axle Left & Right Lower	VAN FWD F1AE3481D		Ball Joint	S080037
	2014.03-	Front Axle Left & Right Lower	VAN FWD F1AE3481D		Control Arm Bushing	517366
	2014.03-	Front Axle Left & Right Lower	VAN FWD F1AE3481D		Control Arm Bushing	517367
	2014.03-	Front Axle Left & Right	VAN FWD F1AE3481D		Tie Rod Axle Joint	S030946
	2014.03-	Front Axle Left	VAN FWD F1AE3481D		Tie Rod End	S070090
	2014.03-	Front Axle Right	VAN FWD F1AE3481D		Tie Rod End	S070091
	2014.03-	Front Axle Left & Right	VAN FWD F1AE3481D		Rod/Strut, stabiliser	S050105
	2014.03-	Rear Axle Left & Right	VAN FWD F1AE3481D		Rod/Strut, stabiliser	S050106
Ducato 30 2.3 (96 kw)	2007.01-	Front Axle Left Lower	BUS FWD F1AE0481N/F1AE3481D/F1AGL411D		Track Control Arm	S060135
	2007.01-	Front Axle Right Lower	BUS FWD F1AE0481N/F1AE3481D/F1AGL411D		Track Control Arm	S060136
	2007.01-	Front Axle Left & Right Lower	BUS FWD F1AE0481N/F1AE3481D/F1AGL411D		Ball Joint	S080037
	2007.01-	Front Axle Left & Right Lower	BUS FWD F1AE0481N/F1AE3481D/F1AGL411D		Control Arm Bushing	517366
	2007.01-	Front Axle Left & Right Lower	BUS FWD F1AE0481N/F1AE3481D/F1AGL411D		Control Arm Bushing	517367
	2007.01-	Front Axle Left & Right	BUS FWD F1AE0481N/F1AE3481D/F1AGL411D		Tie Rod Axle Joint	S030946
	2007.01-	Front Axle Left	BUS FWD F1AE0481N/F1AE3481D/F1AGL411D		Tie Rod End	S070090
	2007.01-	Front Axle Right	BUS FWD F1AE0481N/F1AE3481D/F1AGL411D		Tie Rod End	S070091
	2007.01-	Front Axle Left & Right	BUS FWD F1AE0481N/F1AE3481D/F1AGL411D		Rod/Strut, stabiliser	S050105
	2007.01-	Rear Axle Left & Right	BUS FWD F1AE0481N/F1AE3481D/F1AGL411D		Rod/Strut, stabiliser	S050106
	2009.12-	Front Axle Left Lower	VAN FWD F1AE0481N/F1AE3481D/F1AGL411D		Track Control Arm	S060135
	2009.12-	Front Axle Right Lower	VAN FWD F1AE0481N/F1AE3481D/F1AGL411D		Track Control Arm	S060136
	2009.12-	Front Axle Left & Right Lower	VAN FWD F1AE0481N/F1AE3481D/F1AGL411D		Ball Joint	S080037
	2009.12-	Front Axle Left & Right Lower	VAN FWD F1AE0481N/F1AE3481D/F1AGL411D		Control Arm Bushing	517366
	2009.12-	Front Axle Left & Right Lower	VAN FWD F1AE0481N/F1AE3481D/F1AGL411D		Control Arm Bushing	517367
	2009.12-	Front Axle Left & Right	VAN FWD F1AE0481N/F1AE3481D/F1AGL411D		Tie Rod Axle Joint	S030946
	2009.12-	Front Axle Left	VAN FWD F1AE0481N/F1AE3481D/F1AGL411D		Tie Rod End	S070090
	2009.12-	Front Axle Right	VAN FWD F1AE0481N/F1AE3481D/F1AGL411D		Tie Rod End	S070091
	2009.12-	Front Axle Left & Right	VAN FWD F1AE0481N/F1AE3481D/F1AGL411D		Rod/Strut, stabiliser	S050105
	2009.12-	Rear Axle Left & Right	VAN FWD F1AE0481N/F1AE3481D/F1AGL411D		Rod/Strut, stabiliser	S050106
	2011.06-	Front Axle Left Lower	Platform/Chassis FWD F1AE3481D/F1AGL411D		Track Control Arm	S060135
	2011.06-	Front Axle Right Lower	Platform/Chassis FWD F1AE3481D/F1AGL411D		Track Control Arm	S060136
	2011.06-	Front Axle Left & Right Lower	Platform/Chassis FWD F1AE3481D/F1AGL411D		Ball Joint	S080037
	2011.06-	Front Axle Left & Right Lower	Platform/Chassis FWD F1AE3481D/F1AGL411D		Control Arm Bushing	517366
	2011.06-	Front Axle Left & Right Lower	Platform/Chassis FWD F1AE3481D/F1AGL411D		Control Arm Bushing	517367
	2011.06-	Front Axle Left & Right	Platform/Chassis FWD F1AE3481D/F1AGL411D		Tie Rod Axle Joint	S030946
	2011.06-	Front Axle Left	Platform/Chassis FWD F1AE3481D/F1AGL411D		Tie Rod End	S070090
	2011.06-	Front Axle Right	Platform/Chassis FWD F1AE3481D/F1AGL411D		Tie Rod End	S070091
	2011.06-	Front Axle Left & Right	Platform/Chassis FWD F1AE3481D/F1AGL411D		Rod/Strut, stabiliser	S050105
	2011.06-	Rear Axle Left & Right	Platform/Chassis FWD F1AE3481D/F1AGL411D		Rod/Strut, stabiliser	S050106
Ducato 33 2.3 (96 kw)	2007.01-	Front Axle Left Lower	BUS FWD F1AE0481N/F1AE3481D/F1AGL411D		Track Control Arm	S060135
	2007.01-	Front Axle Left Lower	Platform/Chassis FWD F1AE0481N/F1AE3481D/F1AGL411D		Track Control Arm	S060135
	2007.01-	Front Axle Left Lower	VAN FWD F1AE0481N/F1AE3481D/F1AGL411D		Track Control Arm	S060135
	2007.01-	Front Axle Right Lower	BUS FWD F1AE0481N/F1AE3481D/F1AGL411D		Track Control Arm	S060136



	 YEAR	FITTING POSITION	BODY STYLE & DRIVE TYPE & ENGINE	REMARKS	PRODUCT	GSP Ref.
FIAT Ducato 33						
2.3 (96 kw)	2007.01-	Front Axle Right Lower	Platform/Chassis FWD F1AE0481N/F1AE3481D/F1AGL411D		Track Control Arm	S060136
	2007.01-	Front Axle Right Lower	VAN FWD F1AE0481N/F1AE3481D/F1AGL411D		Track Control Arm	S060136
	2007.01-	Front Axle Left & Right Lower	BUS FWD F1AE0481N/F1AE3481D/F1AGL411D		Ball Joint	S080037
	2007.01-	Front Axle Left & Right Lower	Platform/Chassis FWD F1AE0481N/F1AE3481D/F1AGL411D		Ball Joint	S080037
	2007.01-	Front Axle Left & Right Lower	VAN FWD F1AE0481N/F1AE3481D/F1AGL411D		Ball Joint	S080037
	2007.01-	Front Axle Left & Right Lower	BUS FWD F1AE0481N/F1AE3481D/F1AGL411D		Control Arm Bushing	517366
	2007.01-	Front Axle Left & Right Lower	Platform/Chassis FWD F1AE0481N/F1AE3481D/F1AGL411D		Control Arm Bushing	517366
	2007.01-	Front Axle Left & Right Lower	VAN FWD F1AE0481N/F1AE3481D/F1AGL411D		Control Arm Bushing	517366
	2007.01-	Front Axle Left & Right Lower	BUS FWD F1AE0481N/F1AE3481D/F1AGL411D		Control Arm Bushing	517367
	2007.01-	Front Axle Left & Right Lower	Platform/Chassis FWD F1AE0481N/F1AE3481D/F1AGL411D		Control Arm Bushing	517367
	2007.01-	Front Axle Left & Right Lower	VAN FWD F1AE0481N/F1AE3481D/F1AGL411D		Control Arm Bushing	517367
	2007.01-	Front Axle Left & Right	BUS FWD F1AE0481N/F1AE3481D/F1AGL411D		Tie Rod Axle Joint	S030946
	2007.01-	Front Axle Left & Right	Platform/Chassis FWD F1AE0481N/F1AE3481D/F1AGL411D		Tie Rod Axle Joint	S030946
	2007.01-	Front Axle Left & Right	VAN FWD F1AE0481N/F1AE3481D/F1AGL411D		Tie Rod Axle Joint	S030946
	2007.01-	Front Axle Left	BUS FWD F1AE0481N/F1AE3481D/F1AGL411D		Tie Rod End	S070090
	2007.01-	Front Axle Left	Platform/Chassis FWD F1AE0481N/F1AE3481D/F1AGL411D		Tie Rod End	S070090
	2007.01-	Front Axle Left	VAN FWD F1AE0481N/F1AE3481D/F1AGL411D		Tie Rod End	S070090
	2007.01-	Front Axle Right	BUS FWD F1AE0481N/F1AE3481D/F1AGL411D		Tie Rod End	S070091
	2007.01-	Front Axle Right	Platform/Chassis FWD F1AE0481N/F1AE3481D/F1AGL411D		Tie Rod End	S070091
	2007.01-	Front Axle Right	VAN FWD F1AE0481N/F1AE3481D/F1AGL411D		Tie Rod End	S070091
	2007.01-	Front Axle Left & Right	BUS FWD F1AE0481N/F1AE3481D/F1AGL411D		Rod/Strut, stabiliser	S050105
	2007.01-	Front Axle Left & Right	Platform/Chassis FWD F1AE0481N/F1AE3481D/F1AGL411D		Rod/Strut, stabiliser	S050105
	2007.01-	Front Axle Left & Right	VAN FWD F1AE0481N/F1AE3481D/F1AGL411D		Rod/Strut, stabiliser	S050105
	2007.01-	Rear Axle Left & Right	BUS FWD F1AE0481N/F1AE3481D/F1AGL411D		Rod/Strut, stabiliser	S050106
	2007.01-	Rear Axle Left & Right	Platform/Chassis FWD F1AE0481N/F1AE3481D/F1AGL411D		Rod/Strut, stabiliser	S050106
	2007.01-	Rear Axle Left & Right	VAN FWD F1AE0481N/F1AE3481D/F1AGL411D		Rod/Strut, stabiliser	S050106
Ducato 35						
2.3 (96 kw)	2007.01-	Front Axle Left Lower	VAN FWD F1AE0481N/F1AE3481D/F1AGL411D		Track Control Arm	S060135
	2007.01-	Front Axle Right Lower	VAN FWD F1AE0481N/F1AE3481D/F1AGL411D		Track Control Arm	S060136
	2007.01-	Front Axle Left & Right Lower	VAN FWD F1AE0481N/F1AE3481D/F1AGL411D		Ball Joint	S080037
	2007.01-	Front Axle Left & Right Lower	VAN FWD F1AE0481N/F1AE3481D/F1AGL411D		Control Arm Bushing	517366
	2007.01-	Front Axle Left & Right Lower	VAN FWD F1AE0481N/F1AE3481D/F1AGL411D		Control Arm Bushing	517367
	2007.01-	Front Axle Left & Right	VAN FWD F1AE0481N/F1AE3481D/F1AGL411D		Tie Rod Axle Joint	S030946
	2007.01-	Front Axle Left	VAN FWD F1AE0481N/F1AE3481D/F1AGL411D		Tie Rod End	S070090
	2007.01-	Front Axle Right	VAN FWD F1AE0481N/F1AE3481D/F1AGL411D		Tie Rod End	S070091
	2007.01-	Front Axle Left & Right	VAN FWD F1AE0481N/F1AE3481D/F1AGL411D		Rod/Strut, stabiliser	S050105
	2007.01-	Rear Axle Left & Right	VAN FWD F1AE0481N/F1AE3481D/F1AGL411D		Rod/Strut, stabiliser	S050106
	2009.12-	Front Axle Left Lower	Platform/Chassis FWD F1AE0481N/F1AE3481D/F1AGL411D		Track Control Arm	S060135
	2009.12-	Front Axle Right Lower	Platform/Chassis FWD F1AE0481N/F1AE3481D/F1AGL411D		Track Control Arm	S060136
	2009.12-	Front Axle Left & Right Lower	Platform/Chassis FWD F1AE0481N/F1AE3481D/F1AGL411D		Ball Joint	S080037
	2009.12-	Front Axle Left & Right Lower	Platform/Chassis FWD F1AE0481N/F1AE3481D/F1AGL411D		Control Arm Bushing	517366
	2009.12-	Front Axle Left & Right Lower	Platform/Chassis FWD F1AE0481N/F1AE3481D/F1AGL411D		Control Arm Bushing	517367
	2009.12-	Front Axle Left & Right	Platform/Chassis FWD F1AE0481N/F1AE3481D/F1AGL411D		Tie Rod Axle Joint	S030946
	2009.12-	Front Axle Left	Platform/Chassis FWD F1AE0481N/F1AE3481D/F1AGL411D		Tie Rod End	S070090
	2009.12-	Front Axle Right	Platform/Chassis FWD F1AE0481N/F1AE3481D/F1AGL411D		Tie Rod End	S070091
	2009.12-	Front Axle Left & Right	Platform/Chassis FWD F1AE0481N/F1AE3481D/F1AGL411D		Rod/Strut, stabiliser	S050105
	2009.12-	Rear Axle Left & Right	Platform/Chassis FWD F1AE0481N/F1AE3481D/F1AGL411D		Rod/Strut, stabiliser	S050106
	2011.06-	Front Axle Left Lower	BUS FWD F1AE3481D/F1AGL411D		Track Control Arm	S060135
	2011.06-	Front Axle Right Lower	BUS FWD F1AE3481D/F1AGL411D		Track Control Arm	S060136
	2011.06-	Front Axle Left & Right Lower	BUS FWD F1AE3481D/F1AGL411D		Ball Joint	S080037
	2011.06-	Front Axle Left & Right Lower	BUS FWD F1AE3481D/F1AGL411D		Control Arm Bushing	517366
	2011.06-	Front Axle Left & Right Lower	BUS FWD F1AE3481D/F1AGL411D		Control Arm Bushing	517367
	2011.06-	Front Axle Left & Right	BUS FWD F1AE3481D/F1AGL411D		Tie Rod Axle Joint	S030946
	2011.06-	Front Axle Left	BUS FWD F1AE3481D/F1AGL411D		Tie Rod End	S070090
	2011.06-	Front Axle Right	BUS FWD F1AE3481D/F1AGL411D		Tie Rod End	S070091
	2011.06-	Front Axle Left & Right	BUS FWD F1AE3481D/F1AGL411D		Rod/Strut, stabiliser	S050105
	2011.06-	Rear Axle Left & Right	BUS FWD F1AE3481D/F1AGL411D		Rod/Strut, stabiliser	S050106
Ducato 40						
2.3 (96 kw)	2006.08-	Front Axle Left Lower	Platform/Chassis FWD F1AE0481N/F1AE3481D/F1AGL411D		Track Control Arm	S060135
	2006.08-	Front Axle Left Lower	VAN FWD F1AE0481N/F1AE3481D/F1AGL411D		Track Control Arm	S060135
	2006.08-	Front Axle Right Lower	Platform/Chassis FWD F1AE0481N/F1AE3481D/F1AGL411D		Track Control Arm	S060136
	2006.08-	Front Axle Right Lower	VAN FWD F1AE0481N/F1AE3481D/F1AGL411D		Track Control Arm	S060136
	2006.08-	Front Axle Left & Right Lower	Platform/Chassis FWD F1AE0481N/F1AE3481D/F1AGL411D		Ball Joint	S080037
	2006.08-	Front Axle Left & Right Lower	VAN FWD F1AE0481N/F1AE3481D/F1AGL411D		Ball Joint	S080037



	 YEAR	FITTING POSITION	BODY STYLE & DRIVE TYPE & ENGINE	REMARKS	PRODUCT	GSP Ref.
FIAT Ducato 40						
2.3 (96 kw)	2006.08-	Front Axle Left & Right Lower	Platform/Chassis FWD F1AE0481NF1AE3481DF1AGL411D		Control Arm Bushing	517366
	2006.08-	Front Axle Left & Right Lower	VAN FWD F1AE0481NF1AE3481DF1AGL411D		Control Arm Bushing	517366
	2006.08-	Front Axle Left & Right Lower	Platform/Chassis FWD F1AE0481NF1AE3481DF1AGL411D		Control Arm Bushing	517367
	2006.08-	Front Axle Left & Right Lower	VAN FWD F1AE0481NF1AE3481DF1AGL411D		Control Arm Bushing	517367
	2006.08-	Front Axle Left & Right	Platform/Chassis FWD F1AE0481NF1AE3481DF1AGL411D		Tie Rod Axle Joint	S030946
	2006.08-	Front Axle Left & Right	VAN FWD F1AE0481NF1AE3481DF1AGL411D		Tie Rod Axle Joint	S030946
	2006.08-	Front Axle Left	Platform/Chassis FWD F1AE0481NF1AE3481DF1AGL411D		Tie Rod End	S070090
	2006.08-	Front Axle Left	VAN FWD F1AE0481NF1AE3481DF1AGL411D		Tie Rod End	S070090
	2006.08-	Front Axle Right	Platform/Chassis FWD F1AE0481NF1AE3481DF1AGL411D		Tie Rod End	S070091
	2006.08-	Front Axle Right	VAN FWD F1AE0481NF1AE3481DF1AGL411D		Tie Rod End	S070091
	2006.08-	Front Axle Left & Right	Platform/Chassis FWD F1AE0481NF1AE3481DF1AGL411D		Rod/Strut, stabiliser	S050105
	2006.08-	Front Axle Left & Right	VAN FWD F1AE0481NF1AE3481DF1AGL411D		Rod/Strut, stabiliser	S050105
	2006.08-	Rear Axle Left & Right	Platform/Chassis FWD F1AE0481NF1AE3481DF1AGL411D		Rod/Strut, stabiliser	S050106
	2006.08-	Rear Axle Left & Right	VAN FWD F1AE0481NF1AE3481DF1AGL411D		Rod/Strut, stabiliser	S050106
Elba						
1.3 (43 kw)	1986.04-1993.12	Front Axle Left & Right	Estate FWD 127 A2.011		Tie Rod End	S070750
1.5 (49 kw)	1992.01-1996.12	Front Axle Left & Right Lower	Estate FWD 149 C1.000		Track Control Arm	S060158
	1992.01-1996.12	Front Axle Left & Right	Estate FWD 149 C1.000		Tie Rod End	S070750
1.5 (52 kw)	1986.04-1992.10	Front Axle Left & Right	Estate FWD 149 C1.000		Tie Rod End	S070750
Freemont						
2.4 (127 kw)	2011.08-2016.12	Front Axle Left & Right	MPV FWD B		Tie Rod Axle Joint	S030948
Marea						
1.6 (78 kw)	2005.06-2007.12	Front Axle Left & Right	Saloon FWD 182 B6.000		Tie Rod End	S070824
	2005.06-2007.12	Front Axle Left & Right	Saloon FWD 182 B6.000		Tie Rod End	S070866
Palio						
1.0 (45 kw)	1996.06-2003.10	Front Axle Left Lower	Hatchback FWD 178A1000		Track Control Arm	S060408
	1996.06-2003.10	Front Axle Left Lower	Hatchback FWD 178A1000		Track Control Arm	S060419
	1996.06-2003.10	Front Axle Left Lower	Hatchback FWD 178A1000	Engine code:178 A1.000,Date from:2002.01	Track Control Arm	S060420
	1996.06-2003.10	Front Axle Right Lower	Hatchback FWD 178A1000		Track Control Arm	S060409
	1996.06-2003.10	Front Axle Right Lower	Hatchback FWD 178A1000	Engine code:178 A1.000,Date from:2002.01	Track Control Arm	S060417
	1996.06-2003.10	Front Axle Right Lower	Hatchback FWD 178A1000		Track Control Arm	S060418
	1996.06-2003.10	Front Axle Left & Right Lower	Hatchback FWD 178A1000		Ball Joint	S080054
	1996.06-2003.10	Front Axle Left & Right Lower	Hatchback FWD 178A1000	Date from:2002.01	Ball Joint	S080055
	1996.06-2003.10	Front Axle Left & Right Lower	Hatchback FWD 178A1000	Engine code:178 A1.000,Date to:2002.09,Engine code:178 A3.011	Ball Joint	S080056
	1996.06-2003.10	Front Axle Left Lower	Hatchback FWD 178A1000		Control Arm Bushing	530993
	1996.06-2003.10	Front Axle Left Lower	Hatchback FWD 178A1000		Control Arm Bushing	530999
	1996.06-2003.10	Front Axle Right Lower	Hatchback FWD 178A1000		Control Arm Bushing	530998
	1996.06-2003.10	Front Axle Right Lower	Hatchback FWD 178A1000		Control Arm Bushing	531650
	1996.06-2003.10	Front Axle Left & Right Lower	Hatchback FWD 178A1000		Control Arm Bushing	511456
	1996.06-2003.10	Front Axle Left & Right	Hatchback FWD 178A1000	Engine code:178 A1.000,Date from:1999.09-2002.01	Tie Rod Axle Joint	S030052
	1996.06-2003.10	Front Axle Left & Right	Hatchback FWD 178A1000		Tie Rod Axle Joint	S030057
	1996.06-2003.10	Front Axle Left & Right	Hatchback FWD 178A1000		Tie Rod Axle Joint	S030064
	1996.06-2003.10	Front Axle Left & Right	Hatchback FWD 178A1000	Engine code:178 A1.000,Date from:2002.01	Tie Rod Axle Joint	S030065
	1996.06-2003.10	Front Axle Left & Right	Hatchback FWD 178A1000		Tie Rod Axle Joint	S030538
	1996.06-2003.10	Front Axle Left	Hatchback FWD 178A1000		Tie Rod End	S070123
	1996.06-2003.10	Front Axle Right	Hatchback FWD 178A1000		Tie Rod End	S070124
	1996.06-2003.10	Front Axle Left & Right Inner	Hatchback FWD 178A1000		Stabiliser Bushing	519335
	1996.06-2003.10	Front Axle	Hatchback FWD 178A1000		Stabiliser Bushing	540432
1.2 (59 kw)	2000.03-2012.01	Front Axle Left & Right Lower	Hatchback FWD 178 D6.011	Date from:2002.01	Ball Joint	S080055
	2000.03-2012.01	Front Axle Left & Right Lower	Hatchback FWD 178 D6.011		Ball Joint	S080056
	2000.03-2012.01	Front Axle Left Lower	Hatchback FWD 178 D6.011		Control Arm Bushing	530993
	2000.03-2012.01	Front Axle Left	Hatchback FWD 178 D6.011		Tie Rod End	S070123
	2000.03-2012.01	Front Axle Right	Hatchback FWD 178 D6.011		Tie Rod End	S070124
Palio Weekend						
1.0 (45 kw)	1998.07-2003.10	Front Axle Left & Right Lower	Estate FWD 178A3011		Ball Joint	S080055
Premio						
1.5 (49 kw)	1985.03-1996.12	Front Axle Left & Right	Saloon FWD 146 D1.011		Tie Rod End	S070750
1.6 (60 kw)	1993.08-1996.12	Front Axle Left & Right	Saloon FWD 146 B7.011/160 A2.011		Tie Rod End	S070750
Punto						
1.4 (112 kw)	2008.09-2012.12	Front Axle Left Lower	Hatchback FWD 198A1000		Track Control Arm	S060333
	2008.09-2012.12	Front Axle Right Lower	Hatchback FWD 198A1000		Track Control Arm	S060332
	2008.09-2012.12	Front Axle Left & Right Lower	Hatchback FWD 198A1000		Ball Joint	S080005
	2008.09-2012.12	Front Axle Left & Right Lower	Hatchback FWD 198A1000		Control Arm Bushing	530268
	2008.09-2012.12	Front Axle Left & Right	Hatchback FWD 198A1000		Tie Rod Axle Joint	S030006



	 YEAR	FITTING POSITION	BODY STYLE & DRIVE TYPE & ENGINE	REMARKS	PRODUCT	GSP Ref.
FIAT						
Punto						
1.4 (112 kw)	2008.09-2012.12	Front Axle Left	Hatchback FWD 198A1000		Tie Rod End	S070012
	2008.09-2012.12	Front Axle Right	Hatchback FWD 198A1000		Tie Rod End	S070013
	2008.09-2012.12	Front Axle Left & Right	Hatchback FWD 198A1000		Rod/Strut, stabiliser	S050017
	2008.09-2012.12	Front Axle	Hatchback FWD 198A1000		Steering Boot	540439
	2008.09-2012.12	Front Axle	Hatchback FWD 198A1000		Steering Rack Bellow Kit	540415S
Siena						
1.2 (59 kw)	2001.09-2011.12	Front Axle Left & Right Lower	Saloon FWD 188A5000	Date from:2002.01	Ball Joint	S080055
	2001.09-2011.12	Front Axle Left & Right Lower	Saloon FWD 188A5000	Date from:2002.10	Ball Joint	S080056
1.4 (60 kw)	2004.06-2012.10	Front Axle Left & Right	Saloon FWD 178F3011		Tie Rod End	S070824
	2004.06-2012.10	Front Axle Left & Right	Saloon FWD 178F3011		Tie Rod End	S070866
1.8 (81 kw)	2004.06-2010.12	Front Axle Left & Right Lower	Saloon FWD 93313090		Ball Joint	S080055
	2004.06-2010.12	Front Axle Left & Right	Saloon FWD 93313090		Tie Rod End	S070824
	2004.06-2010.12	Front Axle Left & Right	Saloon FWD 93313090		Tie Rod End	S070866
Siena/Albea						
1.3 (52 kw)	2004.03-2005.05	Front Axle Left & Right Lower	Saloon FWD 178 E9.011		Ball Joint	S080055
	2004.03-2005.05	Front Axle Left & Right	Saloon FWD 178 E9.011		Tie Rod End	S070824
	2004.03-2005.05	Front Axle Left & Right	Saloon FWD 178 E9.011		Tie Rod End	S070866
Strada Pick Up						
1.8 (81 kw)	2004.06-2006.04	Front Axle Left & Right Lower	Pick up FWD 93313090		Ball Joint	S080055
	2004.06-2006.04	Front Axle Left & Right	Pick up FWD 93313090		Tie Rod End	S070824
	2004.06-2006.04	Front Axle Left & Right	Pick up FWD 93313090		Tie Rod End	S070866
Tipo						
2.0 (80 kw)	1990.06-1992.03	Front Axle Left & Right	Hatchback FWD 159A5046	for vehicles with power steering	Tie Rod Axle Joint	S030050
	1990.06-1992.03	Front Axle Left & Right	Hatchback FWD 159A5046	for vehicles without power steering	Tie Rod Axle Joint	S030059
	1990.06-1992.03	Front Axle Left	Hatchback FWD 159A5046		Tie Rod End	S070010
	1990.06-1992.03	Front Axle Right	Hatchback FWD 159A5046		Tie Rod End	S070011
	1990.06-1992.03	Front Axle Left & Right	Hatchback FWD 159A5046		Rod/Strut, stabiliser	S050016
Uno						
1.0 (41 kw)	1993.05-2000.08	Front Axle Left & Right	Hatchback FWD 146C8000		Tie Rod End	S070133
1.4 (87 kw)	1989.12-1996.12	Front Axle Left Lower	Hatchback FWD 146A8000		Track Control Arm	S060422
	1989.12-1996.12	Front Axle Right Lower	Hatchback FWD 146A8000		Track Control Arm	S060423
	1989.12-1996.12	Front Axle Left & Right Lower	Hatchback FWD 146A8000		Ball Joint	S080441
	1989.12-1996.12	Front Axle Left & Right Upper	Hatchback FWD 146A8000		Ball Joint	S080301
	1989.12-1996.12	Front Axle Left & Right	Hatchback FWD 146A8000	for vehicles without power steering	Tie Rod Axle Joint	S030059
	1989.12-1996.12	Front Axle Left & Right	Hatchback FWD 146A8000		Tie Rod Axle Joint	S030063
	1989.12-1996.12	Front Axle Left & Right	Hatchback FWD 146A8000	Date to:1991.12	Tie Rod End	S070126
	1989.12-1996.12	Front Axle Left & Right	Hatchback FWD 146A8000		Tie Rod End	S070133
	1989.12-1996.12	Front Axle	Hatchback FWD 146A8000		Stabiliser Bushing	531006
	1989.12-1996.12	Front Axle	Hatchback FWD 146A8000		Stabiliser Bushing	532033
	1.6 (66 kw)	1993.05-1995.12	Front Axle Left Lower	Hatchback FWD 159 A3.048		Track Control Arm
1993.05-1995.12		Front Axle Right Lower	Hatchback FWD 159 A3.048		Track Control Arm	S060423
1993.05-1995.12		Front Axle Left & Right Lower	Hatchback FWD 159 A3.048		Ball Joint	S080441
1993.05-1995.12		Front Axle Left & Right Upper	Hatchback FWD 159 A3.048		Ball Joint	S080301
1993.05-1995.12		Front Axle Left & Right	Hatchback FWD 159 A3.048	for vehicles without power steering	Tie Rod Axle Joint	S030059
1993.05-1995.12		Front Axle Left & Right	Hatchback FWD 159 A3.048		Tie Rod Axle Joint	S030063
1993.05-1995.12		Front Axle Left & Right	Hatchback FWD 159 A3.048		Tie Rod End	S070133
1993.05-1995.12		Front Axle	Hatchback FWD 159 A3.048		Stabiliser Bushing	532033
FORD						
Escort						
1.8 (85 kw)	1995.01-2000.04	Front Axle Left Lower	Estate FWD RKC		Track Control Arm	S060460
	1995.01-2000.04	Front Axle Right Lower	Estate FWD RKC		Track Control Arm	S060459
	1995.01-2000.04	Front Axle Left & Right Lower	Estate FWD RKC		Ball Joint	S080062
	1995.01-2000.04	Front Axle Left & Right Lower	Estate FWD RKC		Control Arm Bushing	511375
	1995.01-2000.04	Front Axle Left & Right Lower	Estate FWD RKC		Control Arm Bushing	511376
	1995.01-2000.04	Front Axle Left & Right	Estate FWD RKC	For Vehicles With Power Steering/For Vehicles Without Power Steering	Tie Rod Axle Joint	S030071
	1995.01-2000.04	Front Axle Left & Right	Estate FWD RKC	For Vehicles With Power Steering	Tie Rod Axle Joint	S030072
	1995.01-2000.04	Front Axle Left	Estate FWD RKC		Tie Rod End	S070166
	1995.01-2000.04	Front Axle Right	Estate FWD RKC		Tie Rod End	S070165
	1995.01-2000.04	Front Axle Left & Right	Estate FWD RKC		Rod/Strut, stabiliser	S050132
	1995.01-2000.04	Front Axle	Estate FWD RKC		Steering Boot	540184
	1995.01-2000.04	Front Axle	Estate FWD RKC		Steering Boot	540344
	1995.01-2000.04	Front Axle	Estate FWD RKC	for vehicles with power steering	Steering Rack Bellow Kit	540184S
	1995.01-2000.04	Front Axle	Estate FWD RKC	for vehicles with power steering	Steering Rack Bellow Kit	540187S
	1995.01-2000.04	Front Axle	Estate FWD RKC	for vehicles without power steering	Steering Rack Bellow Kit	540344S



	 YEAR	FITTING POSITION	BODY STYLE & DRIVE TYPE & ENGINE	REMARKS	PRODUCT	GSP Ref.
FORD Escort						
1.8 (85 kw)	1995.01-2002.10	Front Axle Left Lower	Hatchback FWD RKC		Track Control Arm	S060460
	1995.01-2002.10	Front Axle Right Lower	Hatchback FWD RKC		Track Control Arm	S060459
	1995.01-2002.10	Front Axle Left & Right Lower	Hatchback FWD RKC		Ball Joint	S080062
	1995.01-2002.10	Front Axle Left & Right Lower	Hatchback FWD RKC		Control Arm Bushing	511375
	1995.01-2002.10	Front Axle Left & Right Lower	Hatchback FWD RKC		Control Arm Bushing	511376
	1995.01-2002.10	Front Axle Left & Right	Hatchback FWD RKC	For Vehicles With Power Steering/For Vehicles Without Power Steering	Tie Rod Axle Joint	S030071
	1995.01-2002.10	Front Axle Left & Right	Hatchback FWD RKC	For Vehicles With Power Steering	Tie Rod Axle Joint	S030072
	1995.01-2002.10	Front Axle Left	Hatchback FWD RKC		Tie Rod End	S070166
	1995.01-2002.10	Front Axle Right	Hatchback FWD RKC		Tie Rod End	S070165
	1995.01-2002.10	Front Axle Left & Right	Hatchback FWD RKC		Rod/Strut, stabiliser	S050132
	1995.01-2002.10	Front Axle	Hatchback FWD RKC		Steering Boot	540184
	1995.01-2002.10	Front Axle	Hatchback FWD RKC		Steering Boot	540344
	1995.01-2002.10	Front Axle	Hatchback FWD RKC	for vehicles with power steering	Steering Rack Bellow Kit	540184S
	1995.01-2002.10	Front Axle	Hatchback FWD RKC	for vehicles with power steering	Steering Rack Bellow Kit	540187S
	1995.01-2002.10	Front Axle	Hatchback FWD RKC	for vehicles without power steering	Steering Rack Bellow Kit	540344S
Fiesta						
1.0 (38 kw)	1996.04-1999.08	Front Axle Left Lower	Hatchback FWD ZH10JRB	for vehicles without power steering	Track Control Arm	S060467
	1996.04-1999.08	Front Axle Left Lower	Hatchback FWD ZH10JRB	for vehicles with power steering	Track Control Arm	S060470
	1996.04-1999.08	Front Axle Right Lower	Hatchback FWD ZH10JRB	for vehicles without power steering	Track Control Arm	S060466
	1996.04-1999.08	Front Axle Right Lower	Hatchback FWD ZH10JRB	for vehicles with power steering	Track Control Arm	S060471
	1996.04-1999.08	Front Axle Left & Right Lower	Hatchback FWD ZH10JRB		Ball Joint	S080057
	1996.04-1999.08	Front Axle Left & Right Lower	Hatchback FWD ZH10JRB		Ball Joint	S080065
	1996.04-1999.08	Front Axle Left & Right Lower	Hatchback FWD ZH10JRB		Control Arm Bushing	511399
	1996.04-1999.08	Front Axle Left & Right Lower	Hatchback FWD ZH10JRB		Control Arm Bushing	517179
	1996.04-1999.08	Front Axle Left & Right	Hatchback FWD ZH10JRB		Tie Rod Axle Joint	S030089
	1996.04-1999.08	Front Axle Left	Hatchback FWD ZH10JRB		Tie Rod End	S070171
	1996.04-1999.08	Front Axle Right	Hatchback FWD ZH10JRB		Tie Rod End	S070172
	1996.04-1999.08	Front Axle Left & Right	Hatchback FWD ZH10JRB		Rod/Strut, stabiliser	S050132
	1996.04-1999.08	Front Axle	Hatchback FWD ZH10JRB		Steering Boot	540344
1.0 (48 kw)	1999.09-2006.06	Front Axle Left Lower	Hatchback FWD C4E	for vehicles without power steering	Track Control Arm	S060467
	1999.09-2006.06	Front Axle Left Lower	Hatchback FWD C4E	for vehicles with power steering	Track Control Arm	S060470
	1999.09-2006.06	Front Axle Right Lower	Hatchback FWD C4E	for vehicles without power steering	Track Control Arm	S060466
	1999.09-2006.06	Front Axle Right Lower	Hatchback FWD C4E	for vehicles with power steering	Track Control Arm	S060471
	1999.09-2006.06	Front Axle Left & Right Lower	Hatchback FWD C4E		Ball Joint	S080065
	1999.09-2006.06	Front Axle Left & Right Lower	Hatchback FWD C4E		Control Arm Bushing	511399
	1999.09-2006.06	Front Axle Left & Right Lower	Hatchback FWD C4E		Control Arm Bushing	517179
	1999.09-2006.06	Front Axle Left & Right	Hatchback FWD C4E		Tie Rod Axle Joint	S030089
	1999.09-2006.06	Front Axle Left	Hatchback FWD C4E		Tie Rod End	S070171
	1999.09-2006.06	Front Axle Right	Hatchback FWD C4E		Tie Rod End	S070172
	1999.09-2006.06	Front Axle Left & Right	Hatchback FWD C4E		Rod/Strut, stabiliser	S050132
	1999.09-2006.06	Front Axle	Hatchback FWD C4E		Steering Boot	540344
1.0 (92 kw)	2012.10-	Front Axle Left Lower	Hatchback FWD M1JE/M1JH		Track Control Arm	S062830
	2012.10-	Front Axle Right Lower	Hatchback FWD M1JE/M1JH		Track Control Arm	S060475
	2012.10-	Front Axle Left & Right Lower	Hatchback FWD M1JE/M1JH		Ball Joint	S080709
	2012.10-	Front Axle Left & Right Lower	Hatchback FWD M1JE/M1JH	Date from-to:2012.11-2019.08	Control Arm Bushing	516515
	2012.10-	Front Axle Left & Right Lower	Hatchback FWD M1JE/M1JH	Date from-to:2012.11-2019.08	Control Arm Bushing	516516
	2012.10-	Front Axle Left & Right Lower	Hatchback FWD M1JE/M1JH		Control Arm Bushing	516516
	2012.10-	Front Axle Left & Right Lower	Hatchback FWD M1JE/M1JH		Control Arm Bushing	530247
	2012.10-	Front Axle Left & Right	Hatchback FWD M1JE/M1JH		Tie Rod Axle Joint	S030093
	2012.10-	Front Axle Left	Hatchback FWD M1JE/M1JH		Tie Rod End	S070177
	2012.10-	Front Axle Right	Hatchback FWD M1JE/M1JH		Tie Rod End	S070178
	2012.10-	Front Axle Left & Right	Hatchback FWD M1JE/M1JH		Rod/Strut, stabiliser	S050491
	2012.10-	Front Axle Left & Right	Hatchback FWD M1JE/M1JH	Aluminum Material	Rod/Strut, stabiliser	S051237
	2012.10-	Front Axle Left & Right	Hatchback FWD M1JE/M1JH		Rod/Strut, stabiliser	S051237
	2012.10-	Front Axle	Hatchback FWD M1JE/M1JH		Steering Boot	540439
	2012.10-	Front Axle	Hatchback FWD M1JE/M1JH		Steering Rack Bellow Kit	540415S
1.3 (44 kw)	1989.03-1997.01	Front Axle Left Lower	Hatchback FWD J6B/JBC	Date from: 1994.01, for vehicles with power steering	Track Control Arm	S060439
	1989.03-1997.01	Front Axle Left Lower	Hatchback FWD J6B/JBC	for vehicles without power steering, Date to: 1994.01	Track Control Arm	S060461
	1989.03-1997.01	Front Axle Left Lower	Hatchback FWD J6B/JBC	for vehicles without power steering	Track Control Arm	S060461
	1989.03-1997.01	Front Axle Left Lower	Hatchback FWD J6B/JBC	Date from: 1994.01, for vehicles without power steering	Track Control Arm	S060823
	1989.03-1997.01	Front Axle Right Lower	Hatchback FWD J6B/JBC	Date from: 1994.01, for vehicles with power steering	Track Control Arm	S060440
	1989.03-1997.01	Front Axle Right Lower	Hatchback FWD J6B/JBC	for vehicles without power steering, Date to: 1994.01	Track Control Arm	S060462
	1989.03-1997.01	Front Axle Right Lower	Hatchback FWD J6B/JBC	for vehicles without power steering	Track Control Arm	S060462
	1989.03-1997.01	Front Axle Left & Right Lower	Hatchback FWD J6B/JBC	Date from: 1994.01	Ball Joint	S080057



	 YEAR	FITTING POSITION	BODY STYLE & DRIVE TYPE & ENGINE	REMARKS	PRODUCT	GSP Ref.
FORD Fiesta						
1.3 (44 kw)	1989.03-1997.01	Front Axle Left & Right Lower	Hatchback FWD J6B/JBC	Date to:1993.12	Ball Joint	S080062
	1989.03-1997.01	Front Axle Left & Right Lower	Hatchback FWD J6B/JBC		Ball Joint	S080062
	1989.03-1997.01	Front Axle Left & Right Lower	Hatchback FWD J6B/JBC	Date to:1994.01	Ball Joint	S080062
	1989.03-1997.01	Front Axle Left & Right Lower	Hatchback FWD J6B/JBC	Date to:1993.12;for vehicles without power steering	Ball Joint	S080065
	1989.03-1997.01	Front Axle Left & Right Lower	Hatchback FWD J6B/JBC		Ball Joint	S080065
	1989.03-1997.01	Front Axle Left & Right Lower	Hatchback FWD J6B/JBC	Date from:1994.01	Ball Joint	S080065
	1989.03-1997.01	Front Axle Left & Right Lower	Hatchback FWD J6B/JBC		Control Arm Bushing	511375
	1989.03-1997.01	Front Axle Left & Right Lower	Hatchback FWD J6B/JBC		Control Arm Bushing	511376
	1989.03-1997.01	Front Axle Left & Right	Hatchback FWD J6B/JBC		Tie Rod Axle Joint	S030073
	1989.03-1997.01	Front Axle Left & Right	Hatchback FWD J6B/JBC	Date to:1994.01;for vehicles without power steering	Tie Rod End	S070142
	1989.03-1997.01	Front Axle Left & Right	Hatchback FWD J6B/JBC		Tie Rod End	S070142
	1989.03-1997.01	Front Axle Left & Right	Hatchback FWD J6B/JBC	for vehicles without power steering	Tie Rod End	S070142
	1989.03-1997.01	Front Axle Left & Right	Hatchback FWD J6B/JBC	Date from:1994.02	Tie Rod End	S070170
	1989.03-1997.01	Front Axle Left & Right	Hatchback FWD J6B/JBC		Rod/Strut,stablisiser	S050132
	1989.03-1997.01	Front Axle	Hatchback FWD J6B/JBC		Steering Boot	540184
	1995.06-2002.04	Front Axle Left Lower	Hatchback FWD J4C/J4J/J4L/J4Q/J4R/J4T	for vehicles without power steering	Track Control Arm	S060467
	1995.06-2002.04	Front Axle Left Lower	Hatchback FWD J4C/J4J/J4L/J4Q/J4R/J4T	for vehicles with power steering	Track Control Arm	S060470
	1995.06-2002.04	Front Axle Right Lower	Hatchback FWD J4C/J4J/J4L/J4Q/J4R/J4T	for vehicles without power steering	Track Control Arm	S060466
	1995.06-2002.04	Front Axle Right Lower	Hatchback FWD J4C/J4J/J4L/J4Q/J4R/J4T	for vehicles with power steering	Track Control Arm	S060471
	1995.06-2002.04	Front Axle Left & Right Lower	Hatchback FWD J4C/J4J/J4L/J4Q/J4R/J4T	Date from:1996.01	Ball Joint	S080057
	1995.06-2002.04	Front Axle Left & Right Lower	Hatchback FWD J4C/J4J/J4L/J4Q/J4R/J4T		Ball Joint	S080065
	1995.06-2002.04	Front Axle Left & Right Lower	Hatchback FWD J4C/J4J/J4L/J4Q/J4R/J4T		Control Arm Bushing	511399
	1995.06-2002.04	Front Axle Left & Right Lower	Hatchback FWD J4C/J4J/J4L/J4Q/J4R/J4T		Control Arm Bushing	517179
	1995.06-2002.04	Front Axle Left & Right	Hatchback FWD J4C/J4J/J4L/J4Q/J4R/J4T		Tie Rod Axle Joint	S030089
	1995.06-2002.04	Front Axle Left	Hatchback FWD J4C/J4J/J4L/J4Q/J4R/J4T		Tie Rod End	S070171
	1995.06-2002.04	Front Axle Right	Hatchback FWD J4C/J4J/J4L/J4Q/J4R/J4T		Tie Rod End	S070172
	1995.06-2002.04	Front Axle Left & Right	Hatchback FWD J4C/J4J/J4L/J4Q/J4R/J4T		Rod/Strut,stablisiser	S050132
	1995.06-2002.04	Front Axle	Hatchback FWD J4C/J4J/J4L/J4Q/J4R/J4T		Steering Boot	540184
	1995.06-2002.04	Front Axle	Hatchback FWD J4C/J4J/J4L/J4Q/J4R/J4T		Steering Boot	540344
	1995.06-2002.04	Front Axle	Hatchback FWD J4C/J4J/J4L/J4Q/J4R/J4T	for vehicles with power steering	Steering Rack Bellow Kit	540184S
	1995.06-2002.04	Front Axle	Hatchback FWD J4C/J4J/J4L/J4Q/J4R/J4T	for vehicles with power steering	Steering Rack Bellow Kit	540187S
	1995.06-2002.04	Front Axle	Hatchback FWD J4C/J4J/J4L/J4Q/J4R/J4T	for vehicles without power steering	Steering Rack Bellow Kit	540344S
1.4 (66 kw)	1996.01-2002.04	Front Axle Left Lower	Hatchback FWD FHA/FHE	for vehicles without power steering	Track Control Arm	S060467
	1996.01-2002.04	Front Axle Left Lower	Hatchback FWD FHA/FHE	for vehicles with power steering	Track Control Arm	S060470
	1996.01-2002.04	Front Axle Right Lower	Hatchback FWD FHA/FHE	for vehicles without power steering	Track Control Arm	S060466
	1996.01-2002.04	Front Axle Right Lower	Hatchback FWD FHA/FHE	for vehicles with power steering	Track Control Arm	S060471
	1996.01-2002.04	Front Axle Left & Right Lower	Hatchback FWD FHA/FHE		Ball Joint	S080057
	1996.01-2002.04	Front Axle Left & Right Lower	Hatchback FWD FHA/FHE		Ball Joint	S080065
	1996.01-2002.04	Front Axle Left & Right Lower	Hatchback FWD FHA/FHE		Control Arm Bushing	511399
	1996.01-2002.04	Front Axle Left & Right Lower	Hatchback FWD FHA/FHE		Control Arm Bushing	517179
	1996.01-2002.04	Front Axle Left & Right	Hatchback FWD FHA/FHE		Tie Rod Axle Joint	S030089
	1996.01-2002.04	Front Axle Left	Hatchback FWD FHA/FHE		Tie Rod End	S070171
	1996.01-2002.04	Front Axle Right	Hatchback FWD FHA/FHE		Tie Rod End	S070172
	1996.01-2002.04	Front Axle Left & Right	Hatchback FWD FHA/FHE		Tie Rod End	S070866
	1996.01-2002.04	Front Axle Left & Right	Hatchback FWD FHA/FHE		Rod/Strut,stablisiser	S050132
	1996.01-2002.04	Front Axle	Hatchback FWD FHA/FHE		Steering Boot	540184
	1996.01-2002.04	Front Axle	Hatchback FWD FHA/FHE		Steering Boot	540344
	1996.01-2002.04	Front Axle	Hatchback FWD FHA/FHE	for vehicles with power steering	Steering Rack Bellow Kit	540184S
	1996.01-2002.04	Front Axle	Hatchback FWD FHA/FHE	for vehicles with power steering	Steering Rack Bellow Kit	540187S
	1996.01-2002.04	Front Axle	Hatchback FWD FHA/FHE	for vehicles without power steering	Steering Rack Bellow Kit	540344S
1.5 (82 kw)	2013.05-	Front Axle Left & Right	Hatchback FWD C154CSG		Rod/Strut,stablisiser	S051237
Focus						
1.6 (85 kw)	2010.01-2013.09	Front Axle Left & Right	Saloon FWD C16HDEX		Tie Rod Axle Joint	S031081
1.8 (85 kw)	1998.08-2004.11	Front Axle Left Lower	Hatchback FWD EY0B/EY0C/EY0D/EY0E/EY0F/EY0G/EY0H/EY0I/EY0J	Date from-to:1999.05-2002.11	Track Control Arm	S060442
	1998.08-2004.11	Front Axle Left Lower	Hatchback FWD EY0B/EY0C/EY0D/EY0E/EY0F/EY0G/EY0H/EY0I/EY0J		Track Control Arm	S060986
	1998.08-2004.11	Front Axle Right Lower	Hatchback FWD EY0B/EY0C/EY0D/EY0E/EY0F/EY0G/EY0H/EY0I/EY0J		Track Control Arm	S060441
	1998.08-2004.11	Front Axle Right Lower	Hatchback FWD EY0B/EY0C/EY0D/EY0E/EY0F/EY0G/EY0H/EY0I/EY0J		Track Control Arm	S060985
	1998.08-2004.11	Rear Axle Left Centre	Hatchback FWD EY0B/EY0C/EY0D/EY0E/EY0F/EY0G/EY0H/EY0I/EY0J		Track Control Arm	S062060
	1998.08-2004.11	Rear Axle Right Centre	Hatchback FWD EY0B/EY0C/EY0D/EY0E/EY0F/EY0G/EY0H/EY0I/EY0J		Track Control Arm	S062061
	1998.08-2004.11	Rear Axle Left & Right Upper	Hatchback FWD EY0B/EY0C/EY0D/EY0E/EY0F/EY0G/EY0H/EY0I/EY0J		Track Control Arm	S060182
	1998.08-2004.11	Rear Axle Left & Right Lower Inner	Hatchback FWD EY0B/EY0C/EY0D/EY0E/EY0F/EY0G/EY0H/EY0I/EY0J		Track Control Arm	S060183
	1998.08-2004.11	Rear Axle Left & Right Lower Outer	Hatchback FWD EY0B/EY0C/EY0D/EY0E/EY0F/EY0G/EY0H/EY0I/EY0J		Track Control Arm	S060193
	1998.08-2004.11	Front Axle Left & Right Lower	Hatchback FWD EY0B/EY0C/EY0D/EY0E/EY0F/EY0G/EY0H/EY0I/EY0J		Ball Joint	S080620
	1998.08-2004.11	Front Axle Left & Right Lower	Hatchback FWD EY0B/EY0C/EY0D/EY0E/EY0F/EY0G/EY0H/EY0I/EY0J		Control Arm Bushing	511416

	 YEAR	FITTING POSITION	BODY STYLE & DRIVE TYPE & ENGINE	REMARKS	PRODUCT	GSP Ref.
FORD Focus						
1.8 (85 kw)	1998.08-2004.11	Front Axle Left & Right Lower	Hatchback FWD EYDB/EYDC/EYDD/EYDE/EYDF/EYDGEYDJEYJYL		Control Arm Bushing	511417
	1998.08-2004.11	Front Axle Left & Right Lower	Hatchback FWD EYDB/EYDC/EYDD/EYDE/EYDF/EYDGEYDJEYJYL		Control Arm Bushing	514710
	1998.08-2004.11	Rear Axle Left & Right Centre	Hatchback FWD EYDB/EYDC/EYDD/EYDE/EYDF/EYDGEYDJEYJYL		Control Arm Bushing	511374
	1998.08-2004.11	Rear Axle Left & Right Upper	Hatchback FWD EYDB/EYDC/EYDD/EYDE/EYDF/EYDGEYDJEYJYL	Date to:2002.08	Control Arm Bushing	514889
	1998.08-2004.11	Rear Axle Left & Right Upper	Hatchback FWD EYDB/EYDC/EYDD/EYDE/EYDF/EYDGEYDJEYJYL		Control Arm Bushing	514889
	1998.08-2004.11	Rear Axle Left & Right Lower Inner	Hatchback FWD EYDB/EYDC/EYDD/EYDE/EYDF/EYDGEYDJEYJYL		Control Arm Bushing	514904
	1998.08-2004.11	Rear Axle	Hatchback FWD EYDB/EYDC/EYDD/EYDE/EYDF/EYDGEYDJEYJYL		Suspension Repair Kit	S990012SK
	1998.08-2004.11	Front Axle Left & Right	Hatchback FWD EYDB/EYDC/EYDD/EYDE/EYDF/EYDGEYDJEYJYL		Tie Rod Axle Joint	S030075
	1998.08-2004.11	Front Axle Left	Hatchback FWD EYDB/EYDC/EYDD/EYDE/EYDF/EYDGEYDJEYJYL		Tie Rod End	S070148
	1998.08-2004.11	Front Axle Left	Hatchback FWD EYDB/EYDC/EYDD/EYDE/EYDF/EYDGEYDJEYJYL		Tie Rod End	S071218
	1998.08-2004.11	Front Axle Right	Hatchback FWD EYDB/EYDC/EYDD/EYDE/EYDF/EYDGEYDJEYJYL		Tie Rod End	S070147
	1998.08-2004.11	Front Axle Right	Hatchback FWD EYDB/EYDC/EYDD/EYDE/EYDF/EYDGEYDJEYJYL		Tie Rod End	S071219
	1998.08-2004.11	Front Axle Left & Right	Hatchback FWD EYDB/EYDC/EYDD/EYDE/EYDF/EYDGEYDJEYJYL		Rod/Strut, stabiliser	S050132
	1998.08-2004.11	Front Axle Left & Right	Hatchback FWD EYDB/EYDC/EYDD/EYDE/EYDF/EYDGEYDJEYJYL		Rod/Strut, stabiliser	S051076
	1998.08-2004.11	Rear Axle Left & Right	Hatchback FWD EYDB/EYDC/EYDD/EYDE/EYDF/EYDGEYDJEYJYL	Date from:2001.07	Rod/Strut, stabiliser	S050133
	1998.08-2004.11	Front Axle	Hatchback FWD EYDB/EYDC/EYDD/EYDE/EYDF/EYDGEYDJEYJYL		Stabiliser Bushing	517177
	1998.08-2004.11	Rear Axle	Hatchback FWD EYDB/EYDC/EYDD/EYDE/EYDF/EYDGEYDJEYJYL		Stabiliser Bushing	517178
	1998.08-2004.11	Front Axle	Hatchback FWD EYDB/EYDC/EYDD/EYDE/EYDF/EYDGEYDJEYJYL		Steering Rack Bellow Kit	540187S
	1998.08-2004.11	-	Hatchback FWD EYDB/EYDC/EYDD/EYDE/EYDF/EYDGEYDJEYJYL		Steering Bushing	514977
	1998.08-2005.03	Front Axle Left Lower	Saloon FWD EYDB/EYDC/EYDD/EYDE/EYDF/EYDGEYDJEYJYL		Track Control Arm	S060442
	1998.08-2005.03	Front Axle Left Lower	Saloon FWD EYDB/EYDC/EYDD/EYDE/EYDF/EYDGEYDJEYJYL		Track Control Arm	S060986
	1998.08-2005.03	Front Axle Right Lower	Saloon FWD EYDB/EYDC/EYDD/EYDE/EYDF/EYDGEYDJEYJYL		Track Control Arm	S060441
	1998.08-2005.03	Front Axle Right Lower	Saloon FWD EYDB/EYDC/EYDD/EYDE/EYDF/EYDGEYDJEYJYL		Track Control Arm	S060985
	1998.08-2005.03	Rear Axle Left Centre	Saloon FWD EYDB/EYDC/EYDD/EYDE/EYDF/EYDGEYDJEYJYL		Track Control Arm	S062060
	1998.08-2005.03	Rear Axle Right Centre	Saloon FWD EYDB/EYDC/EYDD/EYDE/EYDF/EYDGEYDJEYJYL		Track Control Arm	S062061
	1998.08-2005.03	Rear Axle Left & Right Upper	Saloon FWD EYDB/EYDC/EYDD/EYDE/EYDF/EYDGEYDJEYJYL		Track Control Arm	S060182
	1998.08-2005.03	Rear Axle Left & Right Lower Inner	Saloon FWD EYDB/EYDC/EYDD/EYDE/EYDF/EYDGEYDJEYJYL		Track Control Arm	S060183
	1998.08-2005.03	Rear Axle Left & Right Lower Outer	Saloon FWD EYDB/EYDC/EYDD/EYDE/EYDF/EYDGEYDJEYJYL		Track Control Arm	S060193
	1998.08-2005.03	Front Axle Left & Right Lower	Saloon FWD EYDB/EYDC/EYDD/EYDE/EYDF/EYDGEYDJEYJYL		Ball Joint	S080620
	1998.08-2005.03	Front Axle Left & Right Lower	Saloon FWD EYDB/EYDC/EYDD/EYDE/EYDF/EYDGEYDJEYJYL		Control Arm Bushing	511416
	1998.08-2005.03	Front Axle Left & Right Lower	Saloon FWD EYDB/EYDC/EYDD/EYDE/EYDF/EYDGEYDJEYJYL		Control Arm Bushing	511417
	1998.08-2005.03	Front Axle Left & Right Lower	Saloon FWD EYDB/EYDC/EYDD/EYDE/EYDF/EYDGEYDJEYJYL		Control Arm Bushing	514710
	1998.08-2005.03	Rear Axle Left & Right Centre	Saloon FWD EYDB/EYDC/EYDD/EYDE/EYDF/EYDGEYDJEYJYL		Control Arm Bushing	511374
	1998.08-2005.03	Rear Axle Left & Right Upper	Saloon FWD EYDB/EYDC/EYDD/EYDE/EYDF/EYDGEYDJEYJYL	Date to:2002.08	Control Arm Bushing	514889
	1998.08-2005.03	Rear Axle Left & Right Upper	Saloon FWD EYDB/EYDC/EYDD/EYDE/EYDF/EYDGEYDJEYJYL		Control Arm Bushing	514889
	1998.08-2005.03	Rear Axle Left & Right Lower Inner	Saloon FWD EYDB/EYDC/EYDD/EYDE/EYDF/EYDGEYDJEYJYL		Control Arm Bushing	514904
	1998.08-2005.03	Rear Axle Left & Right Lower Outer	Saloon FWD EYDB/EYDC/EYDD/EYDE/EYDF/EYDGEYDJEYJYL		Control Arm Bushing	514949
	1998.08-2005.03	Rear Axle Left & Right Lower Outer	Saloon FWD EYDB/EYDC/EYDD/EYDE/EYDF/EYDGEYDJEYJYL		Control Arm Bushing	514957
	1998.08-2005.03	Rear Axle	Saloon FWD EYDB/EYDC/EYDD/EYDE/EYDF/EYDGEYDJEYJYL		Suspension Repair Kit	S990012SK
	1998.08-2005.03	Front Axle Left & Right	Saloon FWD EYDB/EYDC/EYDD/EYDE/EYDF/EYDGEYDJEYJYL		Tie Rod Axle Joint	S030075
	1998.08-2005.03	Front Axle Left	Saloon FWD EYDB/EYDC/EYDD/EYDE/EYDF/EYDGEYDJEYJYL		Tie Rod End	S070148
	1998.08-2005.03	Front Axle Left	Saloon FWD EYDB/EYDC/EYDD/EYDE/EYDF/EYDGEYDJEYJYL		Tie Rod End	S071218
	1998.08-2005.03	Front Axle Right	Saloon FWD EYDB/EYDC/EYDD/EYDE/EYDF/EYDGEYDJEYJYL		Tie Rod End	S070147
	1998.08-2005.03	Front Axle Right	Saloon FWD EYDB/EYDC/EYDD/EYDE/EYDF/EYDGEYDJEYJYL		Tie Rod End	S071219
	1998.08-2005.03	Front Axle Left & Right	Saloon FWD EYDB/EYDC/EYDD/EYDE/EYDF/EYDGEYDJEYJYL		Rod/Strut, stabiliser	S050132
	1998.08-2005.03	Front Axle Left & Right	Saloon FWD EYDB/EYDC/EYDD/EYDE/EYDF/EYDGEYDJEYJYL		Rod/Strut, stabiliser	S051076
	1998.08-2005.03	Rear Axle Left & Right	Saloon FWD EYDB/EYDC/EYDD/EYDE/EYDF/EYDGEYDJEYJYL	Date from:2001.07	Rod/Strut, stabiliser	S050133
	1998.08-2005.03	Front Axle	Saloon FWD EYDB/EYDC/EYDD/EYDE/EYDF/EYDGEYDJEYJYL		Stabiliser Bushing	517177
	1998.08-2005.03	Rear Axle	Saloon FWD EYDB/EYDC/EYDD/EYDE/EYDF/EYDGEYDJEYJYL		Stabiliser Bushing	517178
	1998.08-2005.03	Front Axle	Saloon FWD EYDB/EYDC/EYDD/EYDE/EYDF/EYDGEYDJEYJYL		Steering Rack Bellow Kit	540187S
	1998.08-2005.03	-	Saloon FWD EYDB/EYDC/EYDD/EYDE/EYDF/EYDGEYDJEYJYL		Steering Bushing	514977
2.0 (96 kw)	1998.08-2004.07	Front Axle Left Lower	Hatchback FWD EDDB/EDDC/EDDD/EDDF	Date to:2002.11	Track Control Arm	S060442
	1998.08-2004.07	Front Axle Left Lower	Hatchback FWD EDDB/EDDC/EDDD/EDDF		Track Control Arm	S060986
	1998.08-2004.07	Front Axle Right Lower	Hatchback FWD EDDB/EDDC/EDDD/EDDF		Track Control Arm	S060441
	1998.08-2004.07	Front Axle Right Lower	Hatchback FWD EDDB/EDDC/EDDD/EDDF		Track Control Arm	S060985
	1998.08-2004.07	Rear Axle Left Centre	Hatchback FWD EDDB/EDDC/EDDD/EDDF		Track Control Arm	S062060
	1998.08-2004.07	Rear Axle Right Centre	Hatchback FWD EDDB/EDDC/EDDD/EDDF		Track Control Arm	S062061
	1998.08-2004.07	Rear Axle Left & Right Upper	Hatchback FWD EDDB/EDDC/EDDD/EDDF		Track Control Arm	S060182
	1998.08-2004.07	Rear Axle Left & Right Lower Inner	Hatchback FWD EDDB/EDDC/EDDD/EDDF		Track Control Arm	S060183
	1998.08-2004.07	Rear Axle Left & Right Lower Outer	Hatchback FWD EDDB/EDDC/EDDD/EDDF		Track Control Arm	S060193
	1998.08-2004.07	Front Axle Left & Right Lower	Hatchback FWD EDDB/EDDC/EDDD/EDDF		Ball Joint	S080620
	1998.08-2004.07	Front Axle Left & Right Lower	Hatchback FWD EDDB/EDDC/EDDD/EDDF		Control Arm Bushing	511416
	1998.08-2004.07	Front Axle Left & Right Lower	Hatchback FWD EDDB/EDDC/EDDD/EDDF		Control Arm Bushing	511417
	1998.08-2004.07	Front Axle Left & Right Lower	Hatchback FWD EDDB/EDDC/EDDD/EDDF		Control Arm Bushing	514710

	 YEAR	FITTING POSITION	BODY STYLE & DRIVE TYPE & ENGINE	REMARKS	PRODUCT	GSP Ref.
FORD Focus						
2.0 (96 kw)	1998.08-2004.07	Rear Axle Left & Right Centre	Hatchback FWD EDDB/EDDC/EDDD/EDDF		Control Arm Bushing	511374
	1998.08-2004.07	Rear Axle Left & Right Upper	Hatchback FWD EDDB/EDDC/EDDD/EDDF	Date to:2002.08	Control Arm Bushing	514889
	1998.08-2004.07	Rear Axle Left & Right Upper	Hatchback FWD EDDB/EDDC/EDDD/EDDF		Control Arm Bushing	514889
	1998.08-2004.07	Rear Axle Left & Right Lower Inner	Hatchback FWD EDDB/EDDC/EDDD/EDDF		Control Arm Bushing	514904
	1998.08-2004.07	Rear Axle	Hatchback FWD EDDB/EDDC/EDDD/EDDF		Suspension Repair Kit	S990012SK
	1998.08-2004.07	Front Axle Left & Right	Hatchback FWD EDDB/EDDC/EDDD/EDDF		Tie Rod Axle Joint	S030075
	1998.08-2004.07	Front Axle Left	Hatchback FWD EDDB/EDDC/EDDD/EDDF		Tie Rod End	S070148
	1998.08-2004.07	Front Axle Left	Hatchback FWD EDDB/EDDC/EDDD/EDDF		Tie Rod End	S071218
	1998.08-2004.07	Front Axle Right	Hatchback FWD EDDB/EDDC/EDDD/EDDF		Tie Rod End	S070147
	1998.08-2004.07	Front Axle Right	Hatchback FWD EDDB/EDDC/EDDD/EDDF		Tie Rod End	S071219
	1998.08-2004.07	Front Axle Left & Right	Hatchback FWD EDDB/EDDC/EDDD/EDDF		Rod/Strut, stabiliser	S050132
	1998.08-2004.07	Front Axle Left & Right	Hatchback FWD EDDB/EDDC/EDDD/EDDF		Rod/Strut, stabiliser	S051076
	1998.08-2004.07	Rear Axle Left & Right	Hatchback FWD EDDB/EDDC/EDDD/EDDF	Date from:2001.07	Rod/Strut, stabiliser	S050133
	1998.08-2004.07	Front Axle	Hatchback FWD EDDB/EDDC/EDDD/EDDF		Stabiliser Bushing	517177
	1998.08-2004.07	Rear Axle	Hatchback FWD EDDB/EDDC/EDDD/EDDF		Stabiliser Bushing	517178
	1998.08-2004.07	Front Axle	Hatchback FWD EDDB/EDDC/EDDD/EDDF		Steering Rack Bellow Kit	540187S
	1998.08-2004.07	-	Hatchback FWD EDDB/EDDC/EDDD/EDDF		Steering Bushing	514977
	1999.02-2006.07	Front Axle Left Lower	Saloon FWD EDDB/EDDC/EDDD/EDDF		Track Control Arm	S060442
	1999.02-2006.07	Front Axle Left Lower	Saloon FWD EDDB/EDDC/EDDD/EDDF		Track Control Arm	S060986
	1999.02-2006.07	Front Axle Right Lower	Saloon FWD EDDB/EDDC/EDDD/EDDF		Track Control Arm	S060441
	1999.02-2006.07	Front Axle Right Lower	Saloon FWD EDDB/EDDC/EDDD/EDDF		Track Control Arm	S060985
	1999.02-2006.07	Rear Axle Left Centre	Saloon FWD EDDB/EDDC/EDDD/EDDF		Track Control Arm	S062060
	1999.02-2006.07	Rear Axle Right Centre	Saloon FWD EDDB/EDDC/EDDD/EDDF		Track Control Arm	S062061
	1999.02-2006.07	Rear Axle Left & Right Upper	Saloon FWD EDDB/EDDC/EDDD/EDDF		Track Control Arm	S060182
	1999.02-2006.07	Rear Axle Left & Right Lower Inner	Saloon FWD EDDB/EDDC/EDDD/EDDF		Track Control Arm	S060183
	1999.02-2006.07	Rear Axle Left & Right Lower Outer	Saloon FWD EDDB/EDDC/EDDD/EDDF		Track Control Arm	S060193
	1999.02-2006.07	Front Axle Left & Right Lower	Saloon FWD EDDB/EDDC/EDDD/EDDF		Ball Joint	S080620
	1999.02-2006.07	Front Axle Left & Right Lower	Saloon FWD EDDB/EDDC/EDDD/EDDF		Control Arm Bushing	511416
	1999.02-2006.07	Front Axle Left & Right Lower	Saloon FWD EDDB/EDDC/EDDD/EDDF		Control Arm Bushing	511417
	1999.02-2006.07	Front Axle Left & Right Lower	Saloon FWD EDDB/EDDC/EDDD/EDDF		Control Arm Bushing	514710
	1999.02-2006.07	Rear Axle Left & Right Centre	Saloon FWD EDDB/EDDC/EDDD/EDDF		Control Arm Bushing	511374
	1999.02-2006.07	Rear Axle Left & Right Upper	Saloon FWD EDDB/EDDC/EDDD/EDDF	Date to:2002.08	Control Arm Bushing	514889
	1999.02-2006.07	Rear Axle Left & Right Upper	Saloon FWD EDDB/EDDC/EDDD/EDDF		Control Arm Bushing	514889
	1999.02-2006.07	Rear Axle Left & Right Lower Inner	Saloon FWD EDDB/EDDC/EDDD/EDDF		Control Arm Bushing	514904
	1999.02-2006.07	Rear Axle Left & Right Lower Outer	Saloon FWD EDDB/EDDC/EDDD/EDDF		Control Arm Bushing	514949
	1999.02-2006.07	Rear Axle Left & Right Lower Outer	Saloon FWD EDDB/EDDC/EDDD/EDDF		Control Arm Bushing	514957
	1999.02-2006.07	Rear Axle	Saloon FWD EDDB/EDDC/EDDD/EDDF		Suspension Repair Kit	S990012SK
	1999.02-2006.07	Front Axle Left & Right	Saloon FWD EDDB/EDDC/EDDD/EDDF		Tie Rod Axle Joint	S030075
	1999.02-2006.07	Front Axle Left	Saloon FWD EDDB/EDDC/EDDD/EDDF		Tie Rod End	S070148
	1999.02-2006.07	Front Axle Left	Saloon FWD EDDB/EDDC/EDDD/EDDF		Tie Rod End	S071218
	1999.02-2006.07	Front Axle Right	Saloon FWD EDDB/EDDC/EDDD/EDDF		Tie Rod End	S070147
	1999.02-2006.07	Front Axle Right	Saloon FWD EDDB/EDDC/EDDD/EDDF		Tie Rod End	S071219
	1999.02-2006.07	Front Axle Left & Right	Saloon FWD EDDB/EDDC/EDDD/EDDF		Rod/Strut, stabiliser	S050132
	1999.02-2006.07	Front Axle Left & Right	Saloon FWD EDDB/EDDC/EDDD/EDDF		Rod/Strut, stabiliser	S051076
	1999.02-2006.07	Rear Axle Left & Right	Saloon FWD EDDB/EDDC/EDDD/EDDF	Date from:2001.07	Rod/Strut, stabiliser	S050133
	1999.02-2006.07	Front Axle	Saloon FWD EDDB/EDDC/EDDD/EDDF		Stabiliser Bushing	517177
	1999.02-2006.07	Rear Axle	Saloon FWD EDDB/EDDC/EDDD/EDDF		Stabiliser Bushing	517178
	1999.02-2006.07	Front Axle	Saloon FWD EDDB/EDDC/EDDD/EDDF		Steering Rack Bellow Kit	540187S
	1999.02-2006.07	-	Saloon FWD EDDB/EDDC/EDDD/EDDF		Steering Bushing	514977
2.0 (104 kw)	2005.06-2012.09	Rear Axle Left & Right Upper Outer	Saloon FWD SYDA		Track Control Arm	S062054
2.0 (107 kw)	2004.11-2012.09	Front Axle Left Lower	Hatchback FWD AODA/AODB/AODE	without bolt	Track Control Arm	S060478
	2004.11-2012.09	Front Axle Left Lower	Hatchback FWD AODA/AODB/AODE	Date from:2006.02, not for code:ST	Track Control Arm	S060921
	2004.11-2012.09	Front Axle Right Lower	Hatchback FWD AODA/AODB/AODE		Track Control Arm	S060479
	2004.11-2012.09	Front Axle Right Lower	Hatchback FWD AODA/AODB/AODE	Date from:2006.02, not for code:ST	Track Control Arm	S060922
	2004.11-2012.09	Rear Axle Left & Right Upper	Hatchback FWD AODA/AODB/AODE		Track Control Arm	S060182
	2004.11-2012.09	Rear Axle Left & Right Lower Inner	Hatchback FWD AODA/AODB/AODE		Track Control Arm	S060183
	2004.11-2012.09	Rear Axle Left & Right Lower Outer	Hatchback FWD AODA/AODB/AODE	for vehicles with sports suspension	Track Control Arm	S061286
	2004.11-2012.09	Front Axle Left & Right Lower	Hatchback FWD AODA/AODB/AODE		Ball Joint	S080069
	2004.11-2012.09	Front Axle Left & Right Lower	Hatchback FWD AODA/AODB/AODE		Ball Joint	S080070
	2004.11-2012.09	Front Axle Left & Right Lower	Hatchback FWD AODA/AODB/AODE	Date from-to:2007-2011,	Control Arm Bushing	514447
	2004.11-2012.09	Front Axle Left & Right Lower	Hatchback FWD AODA/AODB/AODE		Control Arm Bushing	516436
	2004.11-2012.09	Front Axle Left & Right Lower	Hatchback FWD AODA/AODB/AODE	Date from-to:2007-2011	Control Arm Bushing	516567
	2004.11-2012.09	Front Axle Left & Right Lower	Hatchback FWD AODA/AODB/AODE		Control Arm Bushing	517914
	2004.11-2012.09	Rear Axle Left & Right Centre	Hatchback FWD AODA/AODB/AODE		Control Arm Bushing	511374



	 YEAR	FITTING POSITION	BODY STYLE & DRIVE TYPE & ENGINE	REMARKS	PRODUCT	GSP Ref.
FORD Focus						
2.0 (107 kw)	2004.11-2012.09	Rear Axle Left & Right Upper	Hatchback FWD AODA/AODB/AODE		Control Arm Bushing	514889
	2004.11-2012.09	Rear Axle Left & Right Lower Inner	Hatchback FWD AODA/AODB/AODE		Control Arm Bushing	514904
	2004.11-2012.09	Rear Axle Left & Right Lower Outer	Hatchback FWD AODA/AODB/AODE	Date from-to:2007.2011	Control Arm Bushing	514949
	2004.11-2012.09	Rear Axle Left & Right Lower Outer	Hatchback FWD AODA/AODB/AODE	Date from-to:2007-2011	Control Arm Bushing	514957
	2004.11-2012.09	Rear Axle	Hatchback FWD AODA/AODB/AODE		Suspension Repair Kit	S990012SK
	2004.11-2012.09	Rear Axle	Hatchback FWD AODA/AODB/AODE		Suspension Repair Kit	S990037SK
	2004.11-2012.09	Front Axle Left & Right	Hatchback FWD AODA/AODB/AODE	L:306mm	Tie Rod Axle Joint	S030091
	2004.11-2012.09	Front Axle Left & Right	Hatchback FWD AODA/AODB/AODE		Tie Rod Axle Joint	S031081
	2004.11-2012.09	Front Axle Left	Hatchback FWD AODA/AODB/AODE		Tie Rod End	S070157
	2004.11-2012.09	Front Axle Left	Hatchback FWD AODA/AODB/AODE		Tie Rod End	S071290
	2004.11-2012.09	Front Axle Right	Hatchback FWD AODA/AODB/AODE		Tie Rod End	S070158
	2004.11-2012.09	Front Axle Right	Hatchback FWD AODA/AODB/AODE		Tie Rod End	S071291
	2004.11-2012.09	Front Axle Left & Right	Hatchback FWD AODA/AODB/AODE		Rod/Strut, stabiliser	S050146
	2004.11-2012.09	Rear Axle Left & Right	Hatchback FWD AODA/AODB/AODE		Rod/Strut, stabiliser	520378
	2004.11-2012.09	Rear Axle Left & Right	Hatchback FWD AODA/AODB/AODE		Rod/Strut, stabiliser	S050145
	2004.11-2012.09	Front Axle	Hatchback FWD AODA/AODB/AODE		Stabiliser Bushing	514031
	2004.11-2012.09	Rear Axle	Hatchback FWD AODA/AODB/AODE		Stabiliser Bushing	514033
	2005.04-2012.09	Front Axle Left Lower	Saloon FWD AODA/AODB/AODE/SYDA	Engine code:AODA,SYDA,AODB	Track Control Arm	S060478
	2005.04-2012.09	Front Axle Left Lower	Saloon FWD AODA/AODB/AODE/SYDA	Engine code:AODA,SYDA,AODB,Date from:2008.02,ref no:ST-Digite code:005	Track Control Arm	S060921
	2005.04-2012.09	Front Axle Right Lower	Saloon FWD AODA/AODB/AODE/SYDA	Engine code:AODA,SYDA,AODB	Track Control Arm	S060479
	2005.04-2012.09	Front Axle Right Lower	Saloon FWD AODA/AODB/AODE/SYDA	Engine code:AODA,SYDA,AODB,Date from:2008.02,ref no:ST-Digite code:005	Track Control Arm	S060922
	2005.04-2012.09	Rear Axle Left & Right Upper	Saloon FWD AODA/AODB/AODE/SYDA		Track Control Arm	S060182
	2005.04-2012.09	Rear Axle Left & Right Lower Inner	Saloon FWD AODA/AODB/AODE/SYDA		Track Control Arm	S060183
	2005.04-2012.09	Rear Axle Left & Right Lower Outer	Saloon FWD AODA/AODB/AODE/SYDA		Track Control Arm	S061286
	2005.04-2012.09	Front Axle Left & Right Lower	Saloon FWD AODA/AODB/AODE/SYDA		Ball Joint	S080069
	2005.04-2012.09	Front Axle Left & Right Lower	Saloon FWD AODA/AODB/AODE/SYDA		Ball Joint	S080070
	2005.04-2012.09	Front Axle Left & Right Lower	Saloon FWD AODA/AODB/AODE/SYDA	Date from:2007	Control Arm Bushing	514447
	2005.04-2012.09	Front Axle Left & Right Lower	Saloon FWD AODA/AODB/AODE/SYDA		Control Arm Bushing	516436
	2005.04-2012.09	Front Axle Left & Right Lower	Saloon FWD AODA/AODB/AODE/SYDA	Date from:2007	Control Arm Bushing	516567
	2005.04-2012.09	Front Axle Left & Right Lower	Saloon FWD AODA/AODB/AODE/SYDA		Control Arm Bushing	517914
	2005.04-2012.09	Rear Axle Left & Right Centre	Saloon FWD AODA/AODB/AODE/SYDA		Control Arm Bushing	511374
	2005.04-2012.09	Rear Axle Left & Right Upper	Saloon FWD AODA/AODB/AODE/SYDA	Date from:2007	Control Arm Bushing	514889
	2005.04-2012.09	Rear Axle Left & Right Upper	Saloon FWD AODA/AODB/AODE/SYDA		Control Arm Bushing	514889
	2005.04-2012.09	Rear Axle Left & Right Lower Inner	Saloon FWD AODA/AODB/AODE/SYDA		Control Arm Bushing	514904
	2005.04-2012.09	Rear Axle Left & Right Lower Outer	Saloon FWD AODA/AODB/AODE/SYDA	Date from:2007	Control Arm Bushing	514949
	2005.04-2012.09	Rear Axle Left & Right Lower Outer	Saloon FWD AODA/AODB/AODE/SYDA	Date from:2007	Control Arm Bushing	514957
	2005.04-2012.09	Rear Axle	Saloon FWD AODA/AODB/AODE/SYDA		Suspension Repair Kit	S990012SK
	2005.04-2012.09	Rear Axle	Saloon FWD AODA/AODB/AODE/SYDA		Suspension Repair Kit	S990037SK
	2005.04-2012.09	Front Axle Left & Right	Saloon FWD AODA/AODB/AODE/SYDA	L:306mm	Tie Rod Axle Joint	S030091
	2005.04-2012.09	Front Axle Left & Right	Saloon FWD AODA/AODB/AODE/SYDA		Tie Rod Axle Joint	S031081
	2005.04-2012.09	Front Axle Left	Saloon FWD AODA/AODB/AODE/SYDA		Tie Rod End	S070157
	2005.04-2012.09	Front Axle Left	Saloon FWD AODA/AODB/AODE/SYDA		Tie Rod End	S071290
	2005.04-2012.09	Front Axle Right	Saloon FWD AODA/AODB/AODE/SYDA		Tie Rod End	S070158
	2005.04-2012.09	Front Axle Right	Saloon FWD AODA/AODB/AODE/SYDA		Tie Rod End	S071291
	2005.04-2012.09	Front Axle Left & Right	Saloon FWD AODA/AODB/AODE/SYDA		Rod/Strut, stabiliser	S050146
	2005.04-2012.09	Rear Axle Left & Right	Saloon FWD AODA/AODB/AODE/SYDA		Rod/Strut, stabiliser	520378
	2005.04-2012.09	Rear Axle Left & Right	Saloon FWD AODA/AODB/AODE/SYDA	Engine code:AODA,SYDA,AODB	Rod/Strut, stabiliser	S050145
	2005.04-2012.09	Front Axle	Saloon FWD AODA/AODB/AODE/SYDA		Stabiliser Bushing	514031
	2005.04-2012.09	Rear Axle	Saloon FWD AODA/AODB/AODE/SYDA		Stabiliser Bushing	514033
	2005.04-2012.09	Rear Axle	Saloon FWD AODA/AODB/AODE/SYDA		Stabiliser Bushing	530508
KA						
1.0 (48 kw)	1999.09-2008.09	Front Axle Left & Right Lower	Hatchback FWD ZH10JRY		Ball Joint	S080057
	1999.09-2008.09	Front Axle	Hatchback FWD ZH10JRY		Suspension Repair Kit	S990022SK
1.3 (44 kw)	1996.09-2008.11	Front Axle Left Lower	Hatchback FWD BAA/J4D/J4K/J4M/J4N/J4P/J4S		Track Control Arm	S060439
	1996.09-2008.11	Front Axle Right Lower	Hatchback FWD BAA/J4D/J4K/J4M/J4N/J4P/J4S		Track Control Arm	S060440
	1996.09-2008.11	Front Axle Left & Right Lower	Hatchback FWD BAA/J4D/J4K/J4M/J4N/J4P/J4S		Ball Joint	S080057
	1996.09-2008.11	Front Axle Left & Right Lower	Hatchback FWD BAA/J4D/J4K/J4M/J4N/J4P/J4S		Ball Joint	S080065
	1996.09-2008.11	Front Axle Left & Right Lower	Hatchback FWD BAA/J4D/J4K/J4M/J4N/J4P/J4S		Control Arm Bushing	511375
	1996.09-2008.11	Front Axle Left & Right Lower	Hatchback FWD BAA/J4D/J4K/J4M/J4N/J4P/J4S		Control Arm Bushing	511376
	1996.09-2008.11	Front Axle	Hatchback FWD BAA/J4D/J4K/J4M/J4N/J4P/J4S		Suspension Repair Kit	S990022SK
	1996.09-2008.11	Front Axle Left & Right	Hatchback FWD BAA/J4D/J4K/J4M/J4N/J4P/J4S		Tie Rod Axle Joint	S030073
	1996.09-2008.11	Front Axle Left & Right	Hatchback FWD BAA/J4D/J4K/J4M/J4N/J4P/J4S		Tie Rod End	S070170
	1996.09-2008.11	Front Axle Left & Right	Hatchback FWD BAA/J4D/J4K/J4M/J4N/J4P/J4S		Tie Rod End	S070866
	1996.09-2008.11	Front Axle Left & Right	Hatchback FWD BAA/J4D/J4K/J4M/J4N/J4P/J4S		Rod/Strut, stabiliser	S050132



	 YEAR	FITTING POSITION	BODY STYLE & DRIVE TYPE & ENGINE	REMARKS	PRODUCT	GSP Ref.
FORD KA						
1.3 (44 kw)	1996.09-2008.11	Front Axle Left & Right	Hatchback FWD BAA/J4D/J4K/J4M/J4N/J4P/J4S		Rod/Strut,stabiliser	S051076
	1996.09-2008.11	Front Axle	Hatchback FWD BAA/J4D/J4K/J4M/J4N/J4P/J4S		Steering Boot	540184
	1996.09-2008.11	Front Axle	Hatchback FWD BAA/J4D/J4K/J4M/J4N/J4P/J4S		Steering Boot	540344
	1996.09-2008.11	Front Axle	Hatchback FWD BAA/J4D/J4K/J4M/J4N/J4P/J4S	for vehicles with power steering	Steering Rack Bellow Kit	540184S
	1996.09-2008.11	Front Axle	Hatchback FWD BAA/J4D/J4K/J4M/J4N/J4P/J4S	for vehicles with power steering	Steering Rack Bellow Kit	540187S
	1996.09-2008.11	Front Axle	Hatchback FWD BAA/J4D/J4K/J4M/J4N/J4P/J4S	for vehicles without power steering	Steering Rack Bellow Kit	540344S
1.6 (70 kw)	2000.09-2008.11	Front Axle Left & Right Lower	Hatchback FWD CDB/CDC		Ball Joint	S080057
	2000.09-2008.11	Front Axle Left & Right Lower	Hatchback FWD CDB/CDC		Ball Joint	S080065
	2000.09-2008.11	Front Axle Left & Right Lower	Hatchback FWD CDB/CDC		Control Arm Bushing	511375
	2000.09-2008.11	Front Axle Left & Right Lower	Hatchback FWD CDB/CDC		Control Arm Bushing	511376
	2000.09-2008.11	Front Axle Left & Right	Hatchback FWD CDB/CDC		Tie Rod Axle Joint	S030073
	2000.09-2008.11	Front Axle Left & Right	Hatchback FWD CDB/CDC		Tie Rod End	S070170
	2000.09-2008.11	Front Axle Left & Right	Hatchback FWD CDB/CDC		Rod/Strut,stabiliser	S050132
	2000.09-2008.11	Front Axle Left & Right	Hatchback FWD CDB/CDC		Rod/Strut,stabiliser	S051076
	2000.09-2008.11	Front Axle	Hatchback FWD CDB/CDC		Steering Boot	540344
	2000.09-2008.11	Front Axle	Hatchback FWD CDB/CDC	for vehicles with power steering	Steering Rack Bellow Kit	540344S
Mondeo						
1.8 (85 kw)	1993.01-1996.08	Front Axle Left Lower	Saloon FWD RKA		Track Control Arm	S060468
	1993.01-1996.08	Front Axle Right Lower	Saloon FWD RKA		Track Control Arm	S060469
	1993.01-1996.08	Rear Axle Left & Right Lower Outer	Saloon FWD RKA		Track Control Arm	S062959
	1993.01-1996.08	Front Axle Left & Right Lower	Saloon FWD RKA		Ball Joint	S080061
	1993.01-1996.08	Front Axle Left & Right Lower	Saloon FWD RKA		Control Arm Bushing	511378
	1993.01-1996.08	Front Axle Left & Right Lower	Saloon FWD RKA		Control Arm Bushing	511379
	1993.01-1996.08	Front Axle Left & Right Lower	Saloon FWD RKA		Control Arm Bushing	511398
	1993.01-1996.08	Rear Axle Left & Right	Saloon FWD RKA		Control Arm Bushing	530244
	1993.01-1996.08	Rear Axle Left & Right	Saloon FWD RKA		Control Arm Bushing	530248
	1993.01-1996.08	Rear Axle Left & Right Upper	Saloon FWD RKA		Control Arm Bushing	514889
	1993.01-1996.08	Front Axle Left & Right	Saloon FWD RKA	Rim Size:14 Inch	Tie Rod Axle Joint	S030087
	1993.01-1996.08	Front Axle Left & Right	Saloon FWD RKA	Rim Size:15 Inch	Tie Rod Axle Joint	S030088
	1993.01-1996.08	Front Axle Left	Saloon FWD RKA		Tie Rod End	S070169
	1993.01-1996.08	Front Axle Right	Saloon FWD RKA		Tie Rod End	S070168
	1993.01-1996.08	Front Axle Left & Right	Saloon FWD RKA		Rod/Strut,stabiliser	S050484
	1993.01-1996.08	Rear Axle Left & Right	Saloon FWD RKA		Rod/Strut,stabiliser	511382
	1993.01-1996.08	Rear Axle Left & Right	Saloon FWD RKA		Rod/Strut,stabiliser	511383
	1993.01-1996.08	Front Axle	Saloon FWD RKA		Stabiliser Bushing	511664
	1993.01-1996.08	Rear Axle	Saloon FWD RKA		Stabiliser Bushing	511658
	1993.01-1996.08	Rear Axle	Saloon FWD RKA		Stabiliser Bushing	511659
	1993.01-1996.08	Front Axle	Saloon FWD RKA	for vehicles with power steering	Steering Rack Bellow Kit	540246S
2.0 (96 kw)	1996.09-2000.11	Front Axle Left Lower	Hatchback FWD NGA/NGB/NGC/NGD		Track Control Arm	S060468
	1996.09-2000.11	Front Axle Left Lower	Saloon FWD NGA/NGB/NGC/NGD		Track Control Arm	S060468
	1996.09-2000.11	Front Axle Right Lower	Hatchback FWD NGA/NGB/NGC/NGD		Track Control Arm	S060469
	1996.09-2000.11	Front Axle Right Lower	Saloon FWD NGA/NGB/NGC/NGD		Track Control Arm	S060469
	1996.09-2000.11	Rear Axle Left & Right Lower Outer	Hatchback FWD NGA/NGB/NGC/NGD		Track Control Arm	S062959
	1996.09-2000.11	Rear Axle Left & Right Lower Outer	Saloon FWD NGA/NGB/NGC/NGD		Track Control Arm	S062959
	1996.09-2000.11	Front Axle Left & Right Lower	Hatchback FWD NGA/NGB/NGC/NGD		Ball Joint	S080061
	1996.09-2000.11	Front Axle Left & Right Lower	Saloon FWD NGA/NGB/NGC/NGD		Ball Joint	S080061
	1996.09-2000.11	Front Axle Left & Right Lower	Hatchback FWD NGA/NGB/NGC/NGD		Control Arm Bushing	511378
	1996.09-2000.11	Front Axle Left & Right Lower	Saloon FWD NGA/NGB/NGC/NGD		Control Arm Bushing	511378
	1996.09-2000.11	Front Axle Left & Right Lower	Hatchback FWD NGA/NGB/NGC/NGD		Control Arm Bushing	511379
	1996.09-2000.11	Front Axle Left & Right Lower	Saloon FWD NGA/NGB/NGC/NGD		Control Arm Bushing	511379
	1996.09-2000.11	Front Axle Left & Right Lower	Hatchback FWD NGA/NGB/NGC/NGD		Control Arm Bushing	511398
	1996.09-2000.11	Front Axle Left & Right Lower	Saloon FWD NGA/NGB/NGC/NGD		Control Arm Bushing	511398
	1996.09-2000.11	Front Axle Left & Right Lower	Hatchback FWD NGA/NGB/NGC/NGD		Control Arm Bushing	517795
	1996.09-2000.11	Front Axle Left & Right Lower	Saloon FWD NGA/NGB/NGC/NGD		Control Arm Bushing	517795
	1996.09-2000.11	Rear Axle Left & Right	Hatchback FWD NGA/NGB/NGC/NGD		Control Arm Bushing	530244
	1996.09-2000.11	Rear Axle Left & Right	Saloon FWD NGA/NGB/NGC/NGD		Control Arm Bushing	530244
	1996.09-2000.11	Rear Axle Left & Right	Hatchback FWD NGA/NGB/NGC/NGD		Control Arm Bushing	530248
	1996.09-2000.11	Rear Axle Left & Right	Saloon FWD NGA/NGB/NGC/NGD		Control Arm Bushing	530248
	1996.09-2000.11	Rear Axle Left & Right Upper	Hatchback FWD NGA/NGB/NGC/NGD		Control Arm Bushing	514889
	1996.09-2000.11	Rear Axle Left & Right Upper	Saloon FWD NGA/NGB/NGC/NGD		Control Arm Bushing	514889
	1996.09-2000.11	Front Axle Left & Right	Hatchback FWD NGA/NGB/NGC/NGD		Tie Rod Axle Joint	S030088
	1996.09-2000.11	Front Axle Left & Right	Saloon FWD NGA/NGB/NGC/NGD		Tie Rod Axle Joint	S030088
	1996.09-2000.11	Front Axle Left	Hatchback FWD NGA/NGB/NGC/NGD		Tie Rod End	S070173
	1996.09-2000.11	Front Axle Left	Saloon FWD NGA/NGB/NGC/NGD		Tie Rod End	S070173



	 YEAR	FITTING POSITION	BODY STYLE & DRIVE TYPE & ENGINE	REMARKS	PRODUCT	GSP Ref.
FORD						
Mondeo						
2.0 (96 kw)	1996.09-2000.11	Front Axle Right	Hatchback FWD NGA/NGB/NGC/NGD		Tie Rod End	S070174
	1996.09-2000.11	Front Axle Right	Saloon FWD NGA/NGB/NGC/NGD		Tie Rod End	S070174
	1996.09-2000.11	Front Axle Left & Right	Hatchback FWD NGA/NGB/NGC/NGD		Tie Rod End	S070866
	1996.09-2000.11	Front Axle Left & Right	Hatchback FWD NGA/NGB/NGC/NGD		Rod/Strut, stabiliser	S050484
	1996.09-2000.11	Front Axle Left & Right	Saloon FWD NGA/NGB/NGC/NGD		Rod/Strut, stabiliser	S050484
	1996.09-2000.11	Rear Axle Left & Right	Hatchback FWD NGA/NGB/NGC/NGD		Rod/Strut, stabiliser	S11382
	1996.09-2000.11	Rear Axle Left & Right	Saloon FWD NGA/NGB/NGC/NGD		Rod/Strut, stabiliser	S11382
	1996.09-2000.11	Rear Axle Left & Right	Hatchback FWD NGA/NGB/NGC/NGD	Date from: 1998.07	Rod/Strut, stabiliser	S050490
	1996.09-2000.11	Rear Axle Left & Right	Saloon FWD NGA/NGB/NGC/NGD	Date from: 1998.07	Rod/Strut, stabiliser	S050490
	1996.09-2000.11	Front Axle	Hatchback FWD NGA/NGB/NGC/NGD		Stabiliser Bushing	511664
	1996.09-2000.11	Front Axle	Saloon FWD NGA/NGB/NGC/NGD		Stabiliser Bushing	511664
	1996.09-2000.11	Rear Axle	Hatchback FWD NGA/NGB/NGC/NGD		Stabiliser Bushing	511658
	1996.09-2000.11	Rear Axle	Saloon FWD NGA/NGB/NGC/NGD		Stabiliser Bushing	511658
	1996.09-2000.11	Rear Axle	Hatchback FWD NGA/NGB/NGC/NGD		Stabiliser Bushing	511659
	1996.09-2000.11	Rear Axle	Saloon FWD NGA/NGB/NGC/NGD		Stabiliser Bushing	511659
	1996.09-2000.11	Front Axle	Hatchback FWD NGA/NGB/NGC/NGD	for vehicles with power steering	Steering Rack Bellow Kit	540246S
	1996.09-2000.11	Front Axle	Saloon FWD NGA/NGB/NGC/NGD	for vehicles with power steering	Steering Rack Bellow Kit	540246S
2.0 (100 kw)	1993.01-1996.08	Front Axle Left Lower	Saloon FWD NGA		Track Control Arm	S060468
	1993.01-1996.08	Front Axle Right Lower	Saloon FWD NGA		Track Control Arm	S060469
	1993.01-1996.08	Rear Axle Left & Right Lower Outer	Saloon FWD NGA		Track Control Arm	S062959
	1993.01-1996.08	Front Axle Left & Right Lower	Saloon FWD NGA		Ball Joint	S080061
	1993.01-1996.08	Front Axle Left & Right Lower	Saloon FWD NGA		Control Arm Bushing	511378
	1993.01-1996.08	Front Axle Left & Right Lower	Saloon FWD NGA		Control Arm Bushing	511379
	1993.01-1996.08	Front Axle Left & Right Lower	Saloon FWD NGA		Control Arm Bushing	511398
	1993.01-1996.08	Rear Axle Left & Right	Saloon FWD NGA		Control Arm Bushing	530244
	1993.01-1996.08	Rear Axle Left & Right	Saloon FWD NGA		Control Arm Bushing	530248
	1993.01-1996.08	Rear Axle Left & Right Upper	Saloon FWD NGA		Control Arm Bushing	514889
	1993.01-1996.08	Front Axle Left & Right	Saloon FWD NGA	Rim Size: 14 Inch	Tie Rod Axle Joint	S030087
	1993.01-1996.08	Front Axle Left & Right	Saloon FWD NGA	Rim Size: 15 Inch	Tie Rod Axle Joint	S030088
	1993.01-1996.08	Front Axle Left	Saloon FWD NGA		Tie Rod End	S070169
	1993.01-1996.08	Front Axle Right	Saloon FWD NGA		Tie Rod End	S070168
	1993.01-1996.08	Front Axle Left & Right	Saloon FWD NGA		Rod/Strut, stabiliser	S050484
	1993.01-1996.08	Rear Axle Left & Right	Saloon FWD NGA		Rod/Strut, stabiliser	S11382
	1993.01-1996.08	Rear Axle Left & Right	Saloon FWD NGA		Rod/Strut, stabiliser	S11383
	1993.01-1996.08	Front Axle	Saloon FWD NGA		Stabiliser Bushing	511664
	1993.01-1996.08	Rear Axle	Saloon FWD NGA		Stabiliser Bushing	511658
	1993.01-1996.08	Rear Axle	Saloon FWD NGA		Stabiliser Bushing	511659
	1993.01-1996.08	Front Axle	Saloon FWD NGA	for vehicles with power steering	Steering Rack Bellow Kit	540246S
2.0 (103 kw)	2014.10-	Front Axle Left & Right	Saloon FWD UACA		Tie Rod Axle Joint	S030976
	2014.10-	Front Axle Left	Saloon FWD UACA		Tie Rod End	S071734
	2014.10-	Front Axle Left & Right	Saloon FWD UACA		Rod/Strut, stabiliser	S051331
	2014.10-	Rear Axle Left & Right	Saloon FWD UACA		Rod/Strut, stabiliser	S051498
2.0 (107 kw)	2000.10-2007.09	Front Axle Left Lower	Saloon FWD C/JBA/C/JBB		Track Control Arm	S060447
	2000.10-2007.09	Front Axle Right Lower	Saloon FWD C/JBA/C/JBB		Track Control Arm	S060448
	2000.10-2007.09	Rear Axle Left & Right Lower Centre	Saloon FWD C/JBA/C/JBB		Track Control Arm	S062955
	2000.10-2007.09	Rear Axle Left & Right Lower Inner	Saloon FWD C/JBA/C/JBB		Track Control Arm	S062956
	2000.10-2007.09	Rear Axle Left & Right Lower Outer	Saloon FWD C/JBA/C/JBB		Track Control Arm	S062951
	2000.10-2007.09	Front Axle Left & Right Lower	Saloon FWD C/JBA/C/JBB		Ball Joint	S080292
	2000.10-2007.09	Front Axle Left & Right Lower	Saloon FWD C/JBA/C/JBB		Control Arm Bushing	516463
	2000.10-2007.09	Front Axle Left & Right Lower	Saloon FWD C/JBA/C/JBB		Control Arm Bushing	517347
	2000.10-2007.09	Rear Axle Left & Right Upper	Saloon FWD C/JBA/C/JBB		Control Arm Bushing	514889
	2000.10-2007.09	Rear Axle Left & Right Lower Centre	Saloon FWD C/JBA/C/JBB		Control Arm Bushing	516458
	2000.10-2007.09	Rear Axle Left & Right Lower Inner	Saloon FWD C/JBA/C/JBB		Control Arm Bushing	516457
	2000.10-2007.09	Front Axle	Saloon FWD C/JBA/C/JBB		Suspension Repair Kit	S990042SK
	2000.10-2007.09	Front Axle Left & Right	Saloon FWD C/JBA/C/JBB		Tie Rod Axle Joint	S030074
	2000.10-2007.09	Front Axle Left & Right	Saloon FWD C/JBA/C/JBB		Tie Rod End	S070145
	2000.10-2007.09	Front Axle Left & Right	Saloon FWD C/JBA/C/JBB		Rod/Strut, stabiliser	S050135
	2000.10-2007.09	Front Axle Left & Right	Saloon FWD C/JBA/C/JBB	Date from: 2002.10	Rod/Strut, stabiliser	S050144
	2000.10-2007.09	Rear Axle Left & Right	Saloon FWD C/JBA/C/JBB		Rod/Strut, stabiliser	S050134
	2000.10-2007.09	Front Axle	Saloon FWD C/JBA/C/JBB		Stabiliser Bushing	517348
	2000.10-2007.09	Rear Axle	Saloon FWD C/JBA/C/JBB		Stabiliser Bushing	511663
	2000.10-2007.09	Front Axle	Saloon FWD C/JBA/C/JBB		Steering Boot	540198
	2000.10-2007.09	Front Axle	Saloon FWD C/JBA/C/JBB	For OE no. 4119193	Steering Rack Bellow Kit	540198S



	 YEAR	FITTING POSITION	BODY STYLE & DRIVE TYPE & ENGINE	REMARKS	PRODUCT	GSP Ref.	
FORD							
Mondeo							
2.0 (176 kw)	2014.09-	Front Axle Left & Right	Saloon FWD R9CB/R9CF/R9CH		Tie Rod Axle Joint	S030976	
	2014.09-	Front Axle Left	Saloon FWD R9CB/R9CF/R9CH		Tie Rod End	S071734	
	2014.09-	Front Axle Right	Saloon FWD R9CB/R9CF/R9CH		Tie Rod End	S071738	
	2014.09-	Front Axle Left & Right	Saloon FWD R9CB/R9CF/R9CH		Rod/Strut, stabiliser	S051331	
	2014.09-	Rear Axle Left & Right	Saloon FWD R9CB/R9CF/R9CH		Rod/Strut, stabiliser	S051498	
2.5 (125 kw)	1996.09-2000.09	Front Axle Left Lower	Saloon FWD SEA		Track Control Arm	S060468	
	1996.09-2000.09	Front Axle Right Lower	Saloon FWD SEA		Track Control Arm	S060469	
	1996.09-2000.09	Rear Axle Left & Right Lower Outer	Saloon FWD SEA		Track Control Arm	S062959	
	1996.09-2000.09	Front Axle Left & Right Lower	Saloon FWD SEA		Ball Joint	S080061	
	1996.09-2000.09	Front Axle Left & Right Lower	Saloon FWD SEA		Control Arm Bushing	511379	
	1996.09-2000.09	Front Axle Left & Right Lower	Saloon FWD SEA		Control Arm Bushing	517795	
	1996.09-2000.09	Rear Axle Left & Right	Saloon FWD SEA		Control Arm Bushing	530244	
	1996.09-2000.09	Rear Axle Left & Right	Saloon FWD SEA		Control Arm Bushing	530248	
	1996.09-2000.09	Rear Axle Left & Right Upper	Saloon FWD SEA		Control Arm Bushing	514889	
	1996.09-2000.09	Front Axle Left & Right	Saloon FWD SEA		Tie Rod Axle Joint	S030088	
	1996.09-2000.09	Front Axle Left	Saloon FWD SEA		Tie Rod End	S070173	
	1996.09-2000.09	Front Axle Right	Saloon FWD SEA		Tie Rod End	S070174	
	1996.09-2000.09	Front Axle Left & Right	Saloon FWD SEA		Rod/Strut, stabiliser	S050484	
	1996.09-2000.09	Rear Axle Left & Right	Saloon FWD SEA		Rod/Strut, stabiliser	511382	
	1996.09-2000.09	Rear Axle Left & Right	Saloon FWD SEA	Date from: 1998.07	Rod/Strut, stabiliser	S050490	
	1996.09-2000.09	Front Axle	Saloon FWD SEA		Stabiliser Bushing	511664	
	1996.09-2000.09	Rear Axle	Saloon FWD SEA		Stabiliser Bushing	511658	
	1996.09-2000.09	Rear Axle	Saloon FWD SEA		Stabiliser Bushing	511659	
	1996.09-2000.09	Front Axle	Saloon FWD SEA	for vehicles with power steering	Steering Rack Bellow Kit	540246S	
	Mondeo Estate/Wagon						
1.8 (85 kw)	1993.02-1996.08	Front Axle Left Lower	Estate FWD RKA		Track Control Arm	S060468	
	1993.02-1996.08	Front Axle Right Lower	Estate FWD RKA		Track Control Arm	S060469	
	1993.02-1996.08	Rear Axle Left & Right Lower	Estate FWD RKA		Track Control Arm	S061664	
	1993.02-1996.08	Rear Axle Left & Right Upper	Estate FWD RKA		Track Control Arm	S061663	
	1993.02-1996.08	Front Axle Left & Right Lower	Estate FWD RKA		Ball Joint	S080061	
	1993.02-1996.08	Front Axle Left & Right Lower	Estate FWD RKA		Control Arm Bushing	511378	
	1993.02-1996.08	Front Axle Left & Right Lower	Estate FWD RKA		Control Arm Bushing	511379	
	1993.02-1996.08	Front Axle Left & Right Lower	Estate FWD RKA		Control Arm Bushing	511398	
	1993.02-1996.08	Rear Axle Left & Right	Estate FWD RKA		Control Arm Bushing	530244	
	1993.02-1996.08	Rear Axle Left & Right	Estate FWD RKA		Control Arm Bushing	530248	
	1993.02-1996.08	Rear Axle Left & Right Upper	Estate FWD RKA		Control Arm Bushing	514889	
	1993.02-1996.08	Front Axle Left & Right	Estate FWD RKA	Rim Size: 14 Inch	Tie Rod Axle Joint	S030087	
	1993.02-1996.08	Front Axle Left & Right	Estate FWD RKA	Rim Size: 15 Inch	Tie Rod Axle Joint	S030088	
	1993.02-1996.08	Front Axle Left	Estate FWD RKA		Tie Rod End	S070169	
	1993.02-1996.08	Front Axle Right	Estate FWD RKA		Tie Rod End	S070168	
	1993.02-1996.08	Front Axle Left & Right	Estate FWD RKA		Rod/Strut, stabiliser	S050484	
	1993.02-1996.08	Rear Axle Left & Right	Estate FWD RKA		Rod/Strut, stabiliser	511382	
	1993.02-1996.08	Rear Axle Left & Right	Estate FWD RKA		Rod/Strut, stabiliser	511383	
	1993.02-1996.08	Front Axle	Estate FWD RKA		Stabiliser Bushing	511664	
	1993.02-1996.08	Rear Axle	Estate FWD RKA		Stabiliser Bushing	511658	
	1993.02-1996.08	Rear Axle	Estate FWD RKA		Stabiliser Bushing	511659	
	1993.02-1996.08	Front Axle	Estate FWD RKA	for vehicles with power steering	Steering Rack Bellow Kit	540246S	
	2.0 (96 kw)	1996.09-2000.11	Front Axle Left Lower	Estate FWD NGA/NGB/NGC/NGD		Track Control Arm	S060468
		1996.09-2000.11	Front Axle Right Lower	Estate FWD NGA/NGB/NGC/NGD		Track Control Arm	S060469
1996.09-2000.11		Rear Axle Left & Right Lower	Estate FWD NGA/NGB/NGC/NGD		Track Control Arm	S061664	
1996.09-2000.11		Rear Axle Left & Right Upper	Estate FWD NGA/NGB/NGC/NGD		Track Control Arm	S061663	
1996.09-2000.11		Front Axle Left & Right Lower	Estate FWD NGA/NGB/NGC/NGD		Ball Joint	S080061	
1996.09-2000.11		Front Axle Left & Right Lower	Estate FWD NGA/NGB/NGC/NGD		Control Arm Bushing	511378	
1996.09-2000.11		Front Axle Left & Right Lower	Estate FWD NGA/NGB/NGC/NGD		Control Arm Bushing	511379	
1996.09-2000.11		Front Axle Left & Right Lower	Estate FWD NGA/NGB/NGC/NGD		Control Arm Bushing	511398	
1996.09-2000.11		Front Axle Left & Right Lower	Estate FWD NGA/NGB/NGC/NGD		Control Arm Bushing	517795	
1996.09-2000.11		Rear Axle Left & Right	Estate FWD NGA/NGB/NGC/NGD		Control Arm Bushing	530244	
1996.09-2000.11		Rear Axle Left & Right	Estate FWD NGA/NGB/NGC/NGD		Control Arm Bushing	530248	
1996.09-2000.11		Rear Axle Left & Right Upper	Estate FWD NGA/NGB/NGC/NGD		Control Arm Bushing	514889	
1996.09-2000.11		Front Axle Left & Right	Estate FWD NGA/NGB/NGC/NGD		Tie Rod Axle Joint	S030088	
1996.09-2000.11		Front Axle Left	Estate FWD NGA/NGB/NGC/NGD		Tie Rod End	S070173	
1996.09-2000.11		Front Axle Right	Estate FWD NGA/NGB/NGC/NGD		Tie Rod End	S070174	
1996.09-2000.11		Front Axle Left & Right	Estate FWD NGA/NGB/NGC/NGD		Rod/Strut, stabiliser	S050484	
1996.09-2000.11		Rear Axle Left & Right	Estate FWD NGA/NGB/NGC/NGD		Rod/Strut, stabiliser	511382	



	 YEAR	FITTING POSITION	BODY STYLE & DRIVE TYPE & ENGINE	REMARKS	PRODUCT	GSP Ref.	
FORD							
Mondeo Estate/Wagon							
2.0 (96 kw)	1996.09-2000.11	Rear Axle Left & Right	Estate FWD NGA/NGB/NGC/NGD	Date from:1998.07	Rod/Strut,stabiliser	S050490	
	1996.09-2000.11	Front Axle	Estate FWD NGA/NGB/NGC/NGD		Stabiliser Bushing	511664	
	1996.09-2000.11	Rear Axle	Estate FWD NGA/NGB/NGC/NGD		Stabiliser Bushing	511658	
	1996.09-2000.11	Rear Axle	Estate FWD NGA/NGB/NGC/NGD		Stabiliser Bushing	511659	
	1996.09-2000.11	Front Axle	Estate FWD NGA/NGB/NGC/NGD	for vehicles with power steering	Steering Rack Bellow Kit	540246S	
2.0 (100 kw)	1993.02-1996.08	Front Axle Left Lower	Estate FWD NGA		Track Control Arm	S060468	
	1993.02-1996.08	Front Axle Right Lower	Estate FWD NGA		Track Control Arm	S060469	
	1993.02-1996.08	Rear Axle Left & Right Lower	Estate FWD NGA		Track Control Arm	S061664	
	1993.02-1996.08	Rear Axle Left & Right Upper	Estate FWD NGA		Track Control Arm	S061663	
	1993.02-1996.08	Front Axle Left & Right Lower	Estate FWD NGA		Ball Joint	S080061	
	1993.02-1996.08	Front Axle Left & Right Lower	Estate FWD NGA		Control Arm Bushing	511378	
	1993.02-1996.08	Front Axle Left & Right Lower	Estate FWD NGA		Control Arm Bushing	511379	
	1993.02-1996.08	Front Axle Left & Right Lower	Estate FWD NGA		Control Arm Bushing	511398	
	1993.02-1996.08	Rear Axle Left & Right	Estate FWD NGA		Control Arm Bushing	530244	
	1993.02-1996.08	Rear Axle Left & Right	Estate FWD NGA		Control Arm Bushing	530248	
	1993.02-1996.08	Rear Axle Left & Right Upper	Estate FWD NGA		Control Arm Bushing	514889	
	1993.02-1996.08	Front Axle Left & Right	Estate FWD NGA	Rim Size:14 Inch	Tie Rod Axle Joint	S030087	
	1993.02-1996.08	Front Axle Left & Right	Estate FWD NGA	Rim Size:15 Inch	Tie Rod Axle Joint	S030088	
	1993.02-1996.08	Front Axle Left	Estate FWD NGA		Tie Rod End	S070169	
	1993.02-1996.08	Front Axle Right	Estate FWD NGA		Tie Rod End	S070168	
	1993.02-1996.08	Front Axle Left & Right	Estate FWD NGA		Rod/Strut,stabiliser	S050484	
	1993.02-1996.08	Rear Axle Left & Right	Estate FWD NGA		Rod/Strut,stabiliser	511382	
	1993.02-1996.08	Rear Axle Left & Right	Estate FWD NGA		Rod/Strut,stabiliser	511383	
	1993.02-1996.08	Front Axle	Estate FWD NGA		Stabiliser Bushing	511664	
	1993.02-1996.08	Rear Axle	Estate FWD NGA		Stabiliser Bushing	511658	
	1993.02-1996.08	Rear Axle	Estate FWD NGA		Stabiliser Bushing	511659	
	1993.02-1996.08	Front Axle	Estate FWD NGA	for vehicles with power steering	Steering Rack Bellow Kit	540246S	
	Transit 300						
	2.2 (92 kw)	2011.09-2014.12	Front Axle Left Lower	VAN RWD CYRA		Track Control Arm	S060456
2011.09-2014.12		Front Axle Right Lower	VAN RWD CYRA		Track Control Arm	S060455	
2011.09-2014.12		Front Axle Left & Right Lower	VAN RWD CYRA	for vehicles without increased axle load	Ball Joint	S080058	
2011.09-2014.12		Front Axle Left & Right Lower	VAN RWD CYRA	for vehicles with increased axle load	Ball Joint	S080298	
2011.09-2014.12		Front Axle Left & Right Lower	VAN RWD CYRA		Control Arm Bushing	511673	
2011.09-2014.12		Front Axle Left & Right Lower	VAN RWD CYRA		Control Arm Bushing	511675	
2011.09-2014.12		Front Axle Left	VAN RWD CYRA		Tie Rod Axle Joint	S030080	
2011.09-2014.12		Front Axle Right	VAN RWD CYRA		Tie Rod Axle Joint	S030079	
2011.09-2014.12		Front Axle Left & Right	VAN RWD CYRA		Tie Rod End	S070146	
2011.09-2014.12		Front Axle Left & Right	VAN RWD CYRA		Rod/Strut,stabiliser	S050154	
2011.09-2014.12		Rear Axle Left & Right	VAN RWD CYRA		Rod/Strut,stabiliser	S050150	
2011.09-2014.12		Front Axle	VAN RWD CYRA		Stabiliser Bushing	517345	
2011.09-2014.12		Rear Axle	VAN RWD CYRA		Stabiliser Bushing	517800	
2.4 (85 kw)		2006.04-2014.08	Front Axle Left Lower	VAN RWD JXFA/JXFC		Track Control Arm	S060456
	2006.04-2014.08	Front Axle Right Lower	VAN RWD JXFA/JXFC		Track Control Arm	S060455	
	2006.04-2014.08	Front Axle Left & Right Lower	VAN RWD JXFA/JXFC	for vehicles without increased axle load	Ball Joint	S080058	
	2006.04-2014.08	Front Axle Left & Right Lower	VAN RWD JXFA/JXFC	for vehicles with increased axle load	Ball Joint	S080298	
	2006.04-2014.08	Front Axle Left & Right Lower	VAN RWD JXFA/JXFC		Control Arm Bushing	511673	
	2006.04-2014.08	Front Axle Left & Right Lower	VAN RWD JXFA/JXFC		Control Arm Bushing	511675	
	2006.04-2014.08	Front Axle Left	VAN RWD JXFA/JXFC		Tie Rod Axle Joint	S030080	
	2006.04-2014.08	Front Axle Right	VAN RWD JXFA/JXFC		Tie Rod Axle Joint	S030079	
	2006.04-2014.08	Front Axle Left & Right	VAN RWD JXFA/JXFC		Tie Rod End	S070146	
	2006.04-2014.08	Front Axle Left & Right	VAN RWD JXFA/JXFC		Rod/Strut,stabiliser	S050154	
	2006.04-2014.08	Rear Axle Left & Right	VAN RWD JXFA/JXFC		Rod/Strut,stabiliser	S050150	
	2006.04-2014.08	Front Axle	VAN RWD JXFA/JXFC		Stabiliser Bushing	517345	
	2006.04-2014.08	Rear Axle	VAN RWD JXFA/JXFC		Stabiliser Bushing	517800	
	Transit 330						
2.2 (92 kw)	2011.09-2014.12	Front Axle Left Lower	BUS RWD CYRA		Track Control Arm	S060456	
	2011.09-2014.12	Front Axle Left Lower	VAN RWD CYRA		Track Control Arm	S060456	
	2011.09-2014.12	Front Axle Right Lower	BUS RWD CYRA		Track Control Arm	S060455	
	2011.09-2014.12	Front Axle Right Lower	VAN RWD CYRA		Track Control Arm	S060455	
	2011.09-2014.12	Front Axle Left & Right Lower	BUS RWD CYRA	for vehicles without increased axle load	Ball Joint	S080058	
	2011.09-2014.12	Front Axle Left & Right Lower	VAN RWD CYRA	for vehicles without increased axle load	Ball Joint	S080058	
	2011.09-2014.12	Front Axle Left & Right Lower	BUS RWD CYRA	for vehicles with increased axle load	Ball Joint	S080298	
	2011.09-2014.12	Front Axle Left & Right Lower	VAN RWD CYRA	for vehicles with increased axle load	Ball Joint	S080298	
	2011.09-2014.12	Front Axle Left & Right Lower	BUS RWD CYRA		Control Arm Bushing	511673	
	2011.09-2014.12	Front Axle Left & Right Lower	BUS RWD CYRA		Control Arm Bushing	511673	



	 YEAR	FITTING POSITION	BODY STYLE & DRIVE TYPE & ENGINE	REMARKS	PRODUCT	GSP Ref.
FORD Transit 330 2.2 (92 kw)	2011.09-2014.12	Front Axle Left & Right Lower	VAN RWD CYRA		Control Arm Bushing	511673
	2011.09-2014.12	Front Axle Left & Right Lower	BUS RWD CYRA		Control Arm Bushing	511675
	2011.09-2014.12	Front Axle Left & Right Lower	VAN RWD CYRA		Control Arm Bushing	511675
	2011.09-2014.12	Front Axle Left	BUS RWD CYRA		Tie Rod Axle Joint	S030080
	2011.09-2014.12	Front Axle Left	VAN RWD CYRA		Tie Rod Axle Joint	S030080
	2011.09-2014.12	Front Axle Right	BUS RWD CYRA		Tie Rod Axle Joint	S030079
	2011.09-2014.12	Front Axle Right	VAN RWD CYRA		Tie Rod Axle Joint	S030079
	2011.09-2014.12	Front Axle Left & Right	BUS RWD CYRA		Tie Rod End	S070146
	2011.09-2014.12	Front Axle Left & Right	VAN RWD CYRA		Tie Rod End	S070146
	2011.09-2014.12	Front Axle Left & Right	BUS RWD CYRA		Rod/Strut, stabiliser	S050154
	2011.09-2014.12	Front Axle Left & Right	VAN RWD CYRA		Rod/Strut, stabiliser	S050154
	2011.09-2014.12	Rear Axle Left & Right	BUS RWD CYRA		Rod/Strut, stabiliser	S050150
	2011.09-2014.12	Rear Axle Left & Right	VAN RWD CYRA		Rod/Strut, stabiliser	S050150
	2011.09-2014.12	Front Axle	BUS RWD CYRA		Stabiliser Bushing	517345
	2011.09-2014.12	Front Axle	VAN RWD CYRA		Stabiliser Bushing	517345
	2011.09-2014.12	Front Axle	BUS RWD CYRA		Stabiliser Bushing	517800
	2011.09-2014.12	Rear Axle	VAN RWD CYRA		Stabiliser Bushing	517800
	2011.10-2014.08	Front Axle Left Lower	Platform/Chassis RWD CYRA		Track Control Arm	S060456
	2011.10-2014.08	Front Axle Right Lower	Platform/Chassis RWD CYRA		Track Control Arm	S060455
	2011.10-2014.08	Front Axle Left & Right Lower	Platform/Chassis RWD CYRA	for vehicles without increased axle load	Ball Joint	S080058
	2011.10-2014.08	Front Axle Left & Right Lower	Platform/Chassis RWD CYRA	for vehicles with increased axle load	Ball Joint	S080298
	2011.10-2014.08	Front Axle Left & Right Lower	Platform/Chassis RWD CYRA		Control Arm Bushing	511673
	2011.10-2014.08	Front Axle Left & Right Lower	Platform/Chassis RWD CYRA		Control Arm Bushing	511675
	2011.10-2014.08	Front Axle Left	Platform/Chassis RWD CYRA		Tie Rod Axle Joint	S030080
	2011.10-2014.08	Front Axle Right	Platform/Chassis RWD CYRA		Tie Rod Axle Joint	S030079
2011.10-2014.08	Front Axle Left & Right	Platform/Chassis RWD CYRA		Tie Rod End	S070146	
2011.10-2014.08	Front Axle Left & Right	Platform/Chassis RWD CYRA		Rod/Strut, stabiliser	S050154	
2011.10-2014.08	Rear Axle Left & Right	Platform/Chassis RWD CYRA		Rod/Strut, stabiliser	S050150	
2011.10-2014.08	Front Axle	Platform/Chassis RWD CYRA		Stabiliser Bushing	517345	
2011.10-2014.08	Front Axle	Platform/Chassis RWD CYRA		Stabiliser Bushing	517800	
2.4 (85 kw)	2006.04-2014.08	Front Axle Left Lower	BUS RWD JXFA/JXFC		Track Control Arm	S060456
	2006.04-2014.08	Front Axle Left Lower	Platform/Chassis RWD JXFA/JXFC		Track Control Arm	S060456
	2006.04-2014.08	Front Axle Left Lower	VAN RWD JXFA/JXFC		Track Control Arm	S060456
	2006.04-2014.08	Front Axle Right Lower	BUS RWD JXFA/JXFC		Track Control Arm	S060455
	2006.04-2014.08	Front Axle Right Lower	Platform/Chassis RWD JXFA/JXFC		Track Control Arm	S060455
	2006.04-2014.08	Front Axle Right Lower	VAN RWD JXFA/JXFC		Track Control Arm	S060455
	2006.04-2014.08	Front Axle Left & Right Lower	BUS RWD JXFA/JXFC	Engine code: JXFA for vehicles without increased axle load	Ball Joint	S080058
	2006.04-2014.08	Front Axle Left & Right Lower	Platform/Chassis RWD JXFA/JXFC	Engine code: JXFA for vehicles without increased axle load	Ball Joint	S080058
	2006.04-2014.08	Front Axle Left & Right Lower	VAN RWD JXFA/JXFC	for vehicles without increased axle load	Ball Joint	S080058
	2006.04-2014.08	Front Axle Left & Right Lower	BUS RWD JXFA/JXFC	Engine code: JXFA for vehicles with increased axle load	Ball Joint	S080298
	2006.04-2014.08	Front Axle Left & Right Lower	Platform/Chassis RWD JXFA/JXFC	Engine code: JXFA for vehicles with increased axle load	Ball Joint	S080298
	2006.04-2014.08	Front Axle Left & Right Lower	VAN RWD JXFA/JXFC	for vehicles with increased axle load	Ball Joint	S080298
	2006.04-2014.08	Front Axle Left & Right Lower	BUS RWD JXFA/JXFC		Control Arm Bushing	511673
	2006.04-2014.08	Front Axle Left & Right Lower	Platform/Chassis RWD JXFA/JXFC		Control Arm Bushing	511673
	2006.04-2014.08	Front Axle Left & Right Lower	VAN RWD JXFA/JXFC		Control Arm Bushing	511673
	2006.04-2014.08	Front Axle Left & Right Lower	BUS RWD JXFA/JXFC		Control Arm Bushing	511675
	2006.04-2014.08	Front Axle Left & Right Lower	Platform/Chassis RWD JXFA/JXFC		Control Arm Bushing	511675
	2006.04-2014.08	Front Axle Left & Right Lower	VAN RWD JXFA/JXFC		Control Arm Bushing	511675
	2006.04-2014.08	Front Axle Left	BUS RWD JXFA/JXFC		Tie Rod Axle Joint	S030080
	2006.04-2014.08	Front Axle Left	Platform/Chassis RWD JXFA/JXFC		Tie Rod Axle Joint	S030080
	2006.04-2014.08	Front Axle Left	VAN RWD JXFA/JXFC		Tie Rod Axle Joint	S030080
	2006.04-2014.08	Front Axle Right	BUS RWD JXFA/JXFC		Tie Rod Axle Joint	S030079
	2006.04-2014.08	Front Axle Right	Platform/Chassis RWD JXFA/JXFC		Tie Rod Axle Joint	S030079
	2006.04-2014.08	Front Axle Right	VAN RWD JXFA/JXFC		Tie Rod Axle Joint	S030079
	2006.04-2014.08	Front Axle Left & Right	BUS RWD JXFA/JXFC		Tie Rod End	S070146
	2006.04-2014.08	Front Axle Left & Right	Platform/Chassis RWD JXFA/JXFC		Tie Rod End	S070146
	2006.04-2014.08	Front Axle Left & Right	VAN RWD JXFA/JXFC		Tie Rod End	S070146
	2006.04-2014.08	Front Axle Left & Right	BUS RWD JXFA/JXFC		Rod/Strut, stabiliser	S050154
	2006.04-2014.08	Front Axle Left & Right	Platform/Chassis RWD JXFA/JXFC		Rod/Strut, stabiliser	S050154
	2006.04-2014.08	Front Axle Left & Right	VAN RWD JXFA/JXFC		Rod/Strut, stabiliser	S050154
	2006.04-2014.08	Rear Axle Left & Right	BUS RWD JXFA/JXFC		Rod/Strut, stabiliser	S050150
	2006.04-2014.08	Rear Axle Left & Right	Platform/Chassis RWD JXFA/JXFC		Rod/Strut, stabiliser	S050150
	2006.04-2014.08	Rear Axle Left & Right	VAN RWD JXFA/JXFC		Rod/Strut, stabiliser	S050150
2006.04-2014.08	Front Axle	BUS RWD JXFA/JXFC		Stabiliser Bushing	517345	



	 YEAR	FITTING POSITION	BODY STYLE & DRIVE TYPE & ENGINE	REMARKS	PRODUCT	GSP Ref.
FORD						
Transit 330						
2.4 (85 kw)	2006.04-2014.08	Front Axle	Platform/Chassis RWD JXFA/JXFC		Stabiliser Bushing	517345
	2006.04-2014.08	Front Axle	VAN RWD JXFA/JXFC		Stabiliser Bushing	517345
	2006.04-2014.08	Front Axle	BUS RWD JXFA/JXFC		Stabiliser Bushing	517800
	2006.04-2014.08	Front Axle	Platform/Chassis RWD JXFA/JXFC		Stabiliser Bushing	517800
	2006.04-2014.08	Rear Axle	VAN RWD JXFA/JXFC		Stabiliser Bushing	517800
Transit 350						
2.2 (92 kw)	2011.09-2014.12	Front Axle Left Lower	BUS RWD CYRA		Track Control Arm	S060456
	2011.09-2014.12	Front Axle Left Lower	VAN RWD CYRA		Track Control Arm	S060456
	2011.09-2014.12	Front Axle Right Lower	BUS RWD CYRA		Track Control Arm	S060455
	2011.09-2014.12	Front Axle Right Lower	VAN RWD CYRA		Track Control Arm	S060455
	2011.09-2014.12	Front Axle Left & Right Lower	BUS RWD CYRA	for vehicles without increased axle load	Ball Joint	S080058
	2011.09-2014.12	Front Axle Left & Right Lower	VAN RWD CYRA	for vehicles without increased axle load	Ball Joint	S080058
	2011.09-2014.12	Front Axle Left & Right Lower	BUS RWD CYRA	for vehicles with increased axle load	Ball Joint	S080298
	2011.09-2014.12	Front Axle Left & Right Lower	VAN RWD CYRA	for vehicles with increased axle load	Ball Joint	S080298
	2011.09-2014.12	Front Axle Left & Right Lower	BUS RWD CYRA		Control Arm Bushing	511673
	2011.09-2014.12	Front Axle Left & Right Lower	VAN RWD CYRA		Control Arm Bushing	511673
	2011.09-2014.12	Front Axle Left & Right Lower	BUS RWD CYRA		Control Arm Bushing	511675
	2011.09-2014.12	Front Axle Left & Right Lower	VAN RWD CYRA		Control Arm Bushing	511675
	2011.09-2014.12	Front Axle Left	BUS RWD CYRA		Tie Rod Axle Joint	S030080
	2011.09-2014.12	Front Axle Left	VAN RWD CYRA		Tie Rod Axle Joint	S030080
	2011.09-2014.12	Front Axle Right	BUS RWD CYRA		Tie Rod Axle Joint	S030079
	2011.09-2014.12	Front Axle Right	VAN RWD CYRA		Tie Rod Axle Joint	S030079
	2011.09-2014.12	Front Axle Left & Right	BUS RWD CYRA		Tie Rod End	S070146
	2011.09-2014.12	Front Axle Left & Right	VAN RWD CYRA		Tie Rod End	S070146
	2011.09-2014.12	Front Axle Left & Right	BUS RWD CYRA		Rod/Strut, stabiliser	S050154
	2011.09-2014.12	Front Axle Left & Right	VAN RWD CYRA		Rod/Strut, stabiliser	S050154
	2011.09-2014.12	Rear Axle Left & Right	BUS RWD CYRA		Rod/Strut, stabiliser	S050150
	2011.09-2014.12	Rear Axle Left & Right	VAN RWD CYRA		Rod/Strut, stabiliser	S050150
	2011.09-2014.12	Front Axle	BUS RWD CYRA		Stabiliser Bushing	517345
	2011.09-2014.12	Front Axle	VAN RWD CYRA		Stabiliser Bushing	517345
	2011.09-2014.12	Front Axle	BUS RWD CYRA		Stabiliser Bushing	517800
	2011.09-2014.12	Rear Axle	VAN RWD CYRA		Stabiliser Bushing	517800
	2011.10-2014.08	Front Axle Left Lower	Platform/Chassis RWD CYRA		Track Control Arm	S060456
	2011.10-2014.08	Front Axle Right Lower	Platform/Chassis RWD CYRA		Track Control Arm	S060455
	2011.10-2014.08	Front Axle Left & Right Lower	Platform/Chassis RWD CYRA	for vehicles without increased axle load	Ball Joint	S080058
	2011.10-2014.08	Front Axle Left & Right Lower	Platform/Chassis RWD CYRA	for vehicles with increased axle load	Ball Joint	S080298
	2011.10-2014.08	Front Axle Left & Right Lower	Platform/Chassis RWD CYRA		Control Arm Bushing	511673
	2011.10-2014.08	Front Axle Left & Right Lower	Platform/Chassis RWD CYRA		Control Arm Bushing	511675
	2011.10-2014.08	Front Axle Left	Platform/Chassis RWD CYRA		Tie Rod Axle Joint	S030080
	2011.10-2014.08	Front Axle Right	Platform/Chassis RWD CYRA		Tie Rod Axle Joint	S030079
	2011.10-2014.08	Front Axle Left & Right	Platform/Chassis RWD CYRA		Tie Rod End	S070146
	2011.10-2014.08	Front Axle Left & Right	Platform/Chassis RWD CYRA		Rod/Strut, stabiliser	S050154
	2011.10-2014.08	Rear Axle Left & Right	Platform/Chassis RWD CYRA		Rod/Strut, stabiliser	S050150
	2011.10-2014.08	Front Axle	Platform/Chassis RWD CYRA		Stabiliser Bushing	517345
	2011.10-2014.08	Front Axle	Platform/Chassis RWD CYRA		Stabiliser Bushing	517800
2.4 (85 kw)	2006.04-2014.08	Front Axle Left Lower	BUS RWD JXFA/JXFC		Track Control Arm	S060456
	2006.04-2014.08	Front Axle Left Lower	Platform/Chassis RWD JXFA/JXFC		Track Control Arm	S060456
	2006.04-2014.08	Front Axle Left Lower	VAN RWD JXFA/JXFC		Track Control Arm	S060456
	2006.04-2014.08	Front Axle Right Lower	BUS RWD JXFA/JXFC		Track Control Arm	S060455
	2006.04-2014.08	Front Axle Right Lower	Platform/Chassis RWD JXFA/JXFC		Track Control Arm	S060455
	2006.04-2014.08	Front Axle Right Lower	VAN RWD JXFA/JXFC		Track Control Arm	S060455
	2006.04-2014.08	Front Axle Left & Right Lower	BUS RWD JXFA/JXFC	Engine code: JXFA, for vehicles without increased axle load	Ball Joint	S080058
	2006.04-2014.08	Front Axle Left & Right Lower	Platform/Chassis RWD JXFA/JXFC	Engine code: JXFA, for vehicles without increased axle load	Ball Joint	S080058
	2006.04-2014.08	Front Axle Left & Right Lower	VAN RWD JXFA/JXFC	for vehicles without increased axle load	Ball Joint	S080058
	2006.04-2014.08	Front Axle Left & Right Lower	BUS RWD JXFA/JXFC	Engine code: JXFA, for vehicles with increased axle load	Ball Joint	S080298
	2006.04-2014.08	Front Axle Left & Right Lower	Platform/Chassis RWD JXFA/JXFC	Engine code: JXFA, for vehicles with increased axle load	Ball Joint	S080298
	2006.04-2014.08	Front Axle Left & Right Lower	VAN RWD JXFA/JXFC	for vehicles with increased axle load	Ball Joint	S080298
	2006.04-2014.08	Front Axle Left & Right Lower	BUS RWD JXFA/JXFC		Control Arm Bushing	511673
	2006.04-2014.08	Front Axle Left & Right Lower	Platform/Chassis RWD JXFA/JXFC		Control Arm Bushing	511673
	2006.04-2014.08	Front Axle Left & Right Lower	VAN RWD JXFA/JXFC		Control Arm Bushing	511673
	2006.04-2014.08	Front Axle Left & Right Lower	BUS RWD JXFA/JXFC		Control Arm Bushing	511675
	2006.04-2014.08	Front Axle Left & Right Lower	Platform/Chassis RWD JXFA/JXFC		Control Arm Bushing	511675
	2006.04-2014.08	Front Axle Left & Right Lower	VAN RWD JXFA/JXFC		Control Arm Bushing	511675
	2006.04-2014.08	Front Axle Left	BUS RWD JXFA/JXFC		Tie Rod Axle Joint	S030080



	 YEAR	FITTING POSITION	BODY STYLE & DRIVE TYPE & ENGINE	REMARKS	PRODUCT	GSP Ref.
FORD						
Transit 350						
2.4 (85 kw)	2006.04-2014.08	Front Axle Left	Platform/Chassis RWD JXFA/JXFC		Tie Rod Axle Joint	S030080
	2006.04-2014.08	Front Axle Left	VAN RWD JXFA/JXFC		Tie Rod Axle Joint	S030080
	2006.04-2014.08	Front Axle Right	BUS RWD JXFA/JXFC		Tie Rod Axle Joint	S030079
	2006.04-2014.08	Front Axle Right	Platform/Chassis RWD JXFA/JXFC		Tie Rod Axle Joint	S030079
	2006.04-2014.08	Front Axle Right	VAN RWD JXFA/JXFC		Tie Rod Axle Joint	S030079
	2006.04-2014.08	Front Axle Left & Right	BUS RWD JXFA/JXFC		Tie Rod End	S070146
	2006.04-2014.08	Front Axle Left & Right	Platform/Chassis RWD JXFA/JXFC		Tie Rod End	S070146
	2006.04-2014.08	Front Axle Left & Right	VAN RWD JXFA/JXFC		Tie Rod End	S070146
	2006.04-2014.08	Front Axle Left & Right	BUS RWD JXFA/JXFC		Rod/Strut, stabiliser	S050154
	2006.04-2014.08	Front Axle Left & Right	Platform/Chassis RWD JXFA/JXFC		Rod/Strut, stabiliser	S050154
	2006.04-2014.08	Front Axle Left & Right	VAN RWD JXFA/JXFC		Rod/Strut, stabiliser	S050154
	2006.04-2014.08	Rear Axle Left & Right	BUS RWD JXFA/JXFC		Rod/Strut, stabiliser	S050150
	2006.04-2014.08	Rear Axle Left & Right	Platform/Chassis RWD JXFA/JXFC		Rod/Strut, stabiliser	S050150
	2006.04-2014.08	Rear Axle Left & Right	VAN RWD JXFA/JXFC		Rod/Strut, stabiliser	S050150
	2006.04-2014.08	Front Axle	BUS RWD JXFA/JXFC		Stabiliser Bushing	517345
	2006.04-2014.08	Front Axle	Platform/Chassis RWD JXFA/JXFC		Stabiliser Bushing	517345
	2006.04-2014.08	Front Axle	VAN RWD JXFA/JXFC		Stabiliser Bushing	517345
	2006.04-2014.08	Front Axle	BUS RWD JXFA/JXFC		Stabiliser Bushing	517800
	2006.04-2014.08	Front Axle	Platform/Chassis RWD JXFA/JXFC		Stabiliser Bushing	517800
	2006.04-2014.08	Rear Axle	VAN RWD JXFA/JXFC		Stabiliser Bushing	517800
Transit 370						
2.4 (85 kw)	2006.04-2014.08	Front Axle Left Lower	BUS RWD JXFA/JXFC		Track Control Arm	S060456
	2006.04-2014.08	Front Axle Right Lower	BUS RWD JXFA/JXFC		Track Control Arm	S060455
	2006.04-2014.08	Front Axle Left & Right Lower	BUS RWD JXFA/JXFC	Engine code: JXFA for vehicles without increased axle load	Ball Joint	S080058
	2006.04-2014.08	Front Axle Left & Right Lower	BUS RWD JXFA/JXFC	Engine code: JXFA for vehicles with increased axle load	Ball Joint	S080298
	2006.04-2014.08	Front Axle Left & Right Lower	BUS RWD JXFA/JXFC		Control Arm Bushing	511673
	2006.04-2014.08	Front Axle Left & Right Lower	BUS RWD JXFA/JXFC		Control Arm Bushing	511675
	2006.04-2014.08	Front Axle Left	BUS RWD JXFA/JXFC		Tie Rod Axle Joint	S030080
	2006.04-2014.08	Front Axle Right	BUS RWD JXFA/JXFC		Tie Rod Axle Joint	S030079
	2006.04-2014.08	Front Axle Left & Right	BUS RWD JXFA/JXFC		Tie Rod End	S070146
	2006.04-2014.08	Front Axle Left & Right	BUS RWD JXFA/JXFC		Rod/Strut, stabiliser	S050154
	2006.04-2014.08	Rear Axle Left & Right	BUS RWD JXFA/JXFC		Rod/Strut, stabiliser	S050150
	2006.04-2014.08	Front Axle	BUS RWD JXFA/JXFC		Stabiliser Bushing	517345
	2006.04-2014.08	Front Axle	BUS RWD JXFA/JXFC		Stabiliser Bushing	517800
Transit 430						
2.4 (85 kw)	2006.04-2014.08	Front Axle Left Lower	BUS RWD JXFA/JXFC		Track Control Arm	S060456
	2006.04-2014.08	Front Axle Left Lower	Platform/Chassis RWD JXFA/JXFC		Track Control Arm	S060456
	2006.04-2014.08	Front Axle Left Lower	VAN RWD JXFA/JXFC		Track Control Arm	S060456
	2006.04-2014.08	Front Axle Right Lower	BUS RWD JXFA/JXFC		Track Control Arm	S060455
	2006.04-2014.08	Front Axle Right Lower	Platform/Chassis RWD JXFA/JXFC		Track Control Arm	S060455
	2006.04-2014.08	Front Axle Right Lower	VAN RWD JXFA/JXFC		Track Control Arm	S060455
	2006.04-2014.08	Front Axle Left & Right Lower	BUS RWD JXFA/JXFC	Engine code: JXFA for vehicles without increased axle load	Ball Joint	S080058
	2006.04-2014.08	Front Axle Left & Right Lower	Platform/Chassis RWD JXFA/JXFC	Engine code: JXFA for vehicles without increased axle load	Ball Joint	S080058
	2006.04-2014.08	Front Axle Left & Right Lower	VAN RWD JXFA/JXFC	for vehicles without increased axle load	Ball Joint	S080058
	2006.04-2014.08	Front Axle Left & Right Lower	BUS RWD JXFA/JXFC	Engine code: JXFA for vehicles with increased axle load	Ball Joint	S080298
	2006.04-2014.08	Front Axle Left & Right Lower	Platform/Chassis RWD JXFA/JXFC	Engine code: JXFA for vehicles with increased axle load	Ball Joint	S080298
	2006.04-2014.08	Front Axle Left & Right Lower	VAN RWD JXFA/JXFC	for vehicles with increased axle load	Ball Joint	S080298
	2006.04-2014.08	Front Axle Left & Right Lower	BUS RWD JXFA/JXFC		Control Arm Bushing	511673
	2006.04-2014.08	Front Axle Left & Right Lower	Platform/Chassis RWD JXFA/JXFC		Control Arm Bushing	511673
	2006.04-2014.08	Front Axle Left & Right Lower	VAN RWD JXFA/JXFC		Control Arm Bushing	511673
	2006.04-2014.08	Front Axle Left & Right Lower	BUS RWD JXFA/JXFC		Control Arm Bushing	511675
	2006.04-2014.08	Front Axle Left & Right Lower	Platform/Chassis RWD JXFA/JXFC		Control Arm Bushing	511675
	2006.04-2014.08	Front Axle Left & Right Lower	VAN RWD JXFA/JXFC		Control Arm Bushing	511675
	2006.04-2014.08	Front Axle Left	BUS RWD JXFA/JXFC		Tie Rod Axle Joint	S030080
	2006.04-2014.08	Front Axle Left	Platform/Chassis RWD JXFA/JXFC		Tie Rod Axle Joint	S030080
	2006.04-2014.08	Front Axle Left	VAN RWD JXFA/JXFC		Tie Rod Axle Joint	S030080
	2006.04-2014.08	Front Axle Right	BUS RWD JXFA/JXFC		Tie Rod Axle Joint	S030079
	2006.04-2014.08	Front Axle Right	Platform/Chassis RWD JXFA/JXFC		Tie Rod Axle Joint	S030079
	2006.04-2014.08	Front Axle Right	VAN RWD JXFA/JXFC		Tie Rod Axle Joint	S030079
	2006.04-2014.08	Front Axle Left & Right	BUS RWD JXFA/JXFC		Tie Rod End	S070146
	2006.04-2014.08	Front Axle Left & Right	Platform/Chassis RWD JXFA/JXFC		Tie Rod End	S070146
	2006.04-2014.08	Front Axle Left & Right	VAN RWD JXFA/JXFC		Tie Rod End	S070146
	2006.04-2014.08	Front Axle Left & Right	BUS RWD JXFA/JXFC		Rod/Strut, stabiliser	S050154
	2006.04-2014.08	Front Axle Left & Right	Platform/Chassis RWD JXFA/JXFC		Rod/Strut, stabiliser	S050154



	 YEAR	FITTING POSITION	BODY STYLE & DRIVE TYPE & ENGINE	REMARKS	PRODUCT	GSP Ref.
FORD						
Transit 430						
2.4 (85 kw)	2006.04-2014.08	Front Axle Left & Right	VAN RWD JXFA/JXFC		Rod/Strut, stabiliser	S050154
	2006.04-2014.08	Rear Axle Left & Right	BUS RWD JXFA/JXFC		Rod/Strut, stabiliser	S050150
	2006.04-2014.08	Rear Axle Left & Right	Platform/Chassis RWD JXFA/JXFC		Rod/Strut, stabiliser	S050150
	2006.04-2014.08	Rear Axle Left & Right	VAN RWD JXFA/JXFC		Rod/Strut, stabiliser	S050150
	2006.04-2014.08	Front Axle	BUS RWD JXFA/JXFC		Stabiliser Bushing	517345
	2006.04-2014.08	Front Axle	Platform/Chassis RWD JXFA/JXFC		Stabiliser Bushing	517345
	2006.04-2014.08	Front Axle	VAN RWD JXFA/JXFC		Stabiliser Bushing	517345
	2006.04-2014.08	Front Axle	BUS RWD JXFA/JXFC		Stabiliser Bushing	517800
	2006.04-2014.08	Front Axle	Platform/Chassis RWD JXFA/JXFC		Stabiliser Bushing	517800
	2006.04-2014.08	Rear Axle	VAN RWD JXFA/JXFC		Stabiliser Bushing	517800
Transit 460						
2.2 (92 kw)	2011.09-2014.12	Front Axle Left Lower	VAN RWD CYRA		Track Control Arm	S060456
	2011.09-2014.12	Front Axle Right Lower	VAN RWD CYRA		Track Control Arm	S060455
	2011.09-2014.12	Front Axle Left & Right Lower	VAN RWD CYRA	for vehicles without increased axle load	Ball Joint	S080058
	2011.09-2014.12	Front Axle Left & Right Lower	VAN RWD CYRA	for vehicles with increased axle load	Ball Joint	S080298
	2011.09-2014.12	Front Axle Left & Right Lower	VAN RWD CYRA		Control Arm Bushing	511673
	2011.09-2014.12	Front Axle Left & Right Lower	VAN RWD CYRA		Control Arm Bushing	511675
	2011.09-2014.12	Front Axle Left	VAN RWD CYRA		Tie Rod Axle Joint	S030080
	2011.09-2014.12	Front Axle Right	VAN RWD CYRA		Tie Rod Axle Joint	S030079
	2011.09-2014.12	Front Axle Left & Right	VAN RWD CYRA		Tie Rod End	S070146
	2011.09-2014.12	Front Axle Left & Right	VAN RWD CYRA		Rod/Strut, stabiliser	S050154
	2011.09-2014.12	Rear Axle Left & Right	VAN RWD CYRA		Rod/Strut, stabiliser	S050150
	2011.09-2014.12	Front Axle	VAN RWD CYRA		Stabiliser Bushing	517345
	2011.09-2014.12	Rear Axle	VAN RWD CYRA		Stabiliser Bushing	517800
	2011.10-2014.08	Front Axle Left Lower	Platform/Chassis RWD CYRA		Track Control Arm	S060456
	2011.10-2014.08	Front Axle Right Lower	Platform/Chassis RWD CYRA		Track Control Arm	S060455
	2011.10-2014.08	Front Axle Left & Right Lower	Platform/Chassis RWD CYRA	for vehicles without increased axle load	Ball Joint	S080058
	2011.10-2014.08	Front Axle Left & Right Lower	Platform/Chassis RWD CYRA	for vehicles with increased axle load	Ball Joint	S080298
	2011.10-2014.08	Front Axle Left & Right Lower	Platform/Chassis RWD CYRA		Control Arm Bushing	511673
	2011.10-2014.08	Front Axle Left & Right Lower	Platform/Chassis RWD CYRA		Control Arm Bushing	511675
	2011.10-2014.08	Front Axle Left	Platform/Chassis RWD CYRA		Tie Rod Axle Joint	S030080
	2011.10-2014.08	Front Axle Right	Platform/Chassis RWD CYRA		Tie Rod Axle Joint	S030079
	2011.10-2014.08	Front Axle Left & Right	Platform/Chassis RWD CYRA		Tie Rod End	S070146
	2011.10-2014.08	Front Axle Left & Right	Platform/Chassis RWD CYRA		Rod/Strut, stabiliser	S050154
	2011.10-2014.08	Rear Axle Left & Right	Platform/Chassis RWD CYRA		Rod/Strut, stabiliser	S050150
	2011.10-2014.08	Front Axle	Platform/Chassis RWD CYRA		Stabiliser Bushing	517345
	2011.10-2014.08	Front Axle	Platform/Chassis RWD CYRA		Stabiliser Bushing	517800
2.4 (85 kw)	2006.04-2014.08	Front Axle Left Lower	VAN RWD JXFA/JXFC		Track Control Arm	S060456
	2006.04-2014.08	Front Axle Right Lower	VAN RWD JXFA/JXFC		Track Control Arm	S060455
	2006.04-2014.08	Front Axle Left & Right Lower	VAN RWD JXFA/JXFC	for vehicles without increased axle load	Ball Joint	S080058
	2006.04-2014.08	Front Axle Left & Right Lower	VAN RWD JXFA/JXFC	for vehicles with increased axle load	Ball Joint	S080298
	2006.04-2014.08	Front Axle Left & Right Lower	VAN RWD JXFA/JXFC		Control Arm Bushing	511673
	2006.04-2014.08	Front Axle Left & Right Lower	VAN RWD JXFA/JXFC		Control Arm Bushing	511675
	2006.04-2014.08	Front Axle Left	VAN RWD JXFA/JXFC		Tie Rod Axle Joint	S030080
	2006.04-2014.08	Front Axle Right	VAN RWD JXFA/JXFC		Tie Rod Axle Joint	S030079
	2006.04-2014.08	Front Axle Left & Right	VAN RWD JXFA/JXFC		Tie Rod End	S070146
	2006.04-2014.08	Front Axle Left & Right	VAN RWD JXFA/JXFC		Rod/Strut, stabiliser	S050154
	2006.04-2014.08	Rear Axle Left & Right	VAN RWD JXFA/JXFC		Rod/Strut, stabiliser	S050150
	2006.04-2014.08	Front Axle	VAN RWD JXFA/JXFC		Stabiliser Bushing	517345
	2006.04-2014.08	Rear Axle	VAN RWD JXFA/JXFC		Stabiliser Bushing	517800
FORD ASIA & OCEANIA						
Fiesta						
1.0 (92 kw)	2013.09-	Front Axle Left Lower	Hatchback FWD M1JE/M1JH		Track Control Arm	S062830
	2013.09-	Front Axle Right Lower	Hatchback FWD M1JE/M1JH		Track Control Arm	S060475
	2013.09-	Front Axle Left & Right Lower	Hatchback FWD M1JE/M1JH		Ball Joint	S080709
	2013.09-	Front Axle Left & Right Lower	Hatchback FWD M1JE/M1JH		Control Arm Bushing	516515
	2013.09-	Front Axle Left & Right Lower	Hatchback FWD M1JE/M1JH		Control Arm Bushing	516516
	2013.09-	Front Axle Left & Right Lower	Hatchback FWD M1JE/M1JH		Control Arm Bushing	530247
	2013.09-	Front Axle Left & Right	Hatchback FWD M1JE/M1JH		Tie Rod Axle Joint	S030093
	2013.09-	Front Axle Left	Hatchback FWD M1JE/M1JH		Tie Rod End	S070177
	2013.09-	Front Axle Right	Hatchback FWD M1JE/M1JH		Tie Rod End	S070178
	2013.09-	Front Axle Left & Right	Hatchback FWD M1JE/M1JH		Rod/Strut, stabiliser	S050491
	2013.09-	Front Axle Left & Right	Hatchback FWD M1JE/M1JH		Rod/Strut, stabiliser	S051237
	2013.09-	Front Axle	Hatchback FWD M1JE/M1JH		Steering Boot	540439



	 YEAR	FITTING POSITION	BODY STYLE & DRIVE TYPE & ENGINE	REMARKS	PRODUCT	GSP Ref.
FORD ASIA & OCEANIA						
Fiesta						
1.0 (92 kw)	2013.09-	Front Axle	Hatchback FWD M1JE/M1JH		Steering Rack Bellow Kit	540415S
Mustang						
5.0 (307 kw)	2011.01-2014.06	Front Axle Left & Right	Coupe RWD C50SDEM		Tie Rod Axle Joint	S030776
Ranger						
2.2 (110 kw)	2011.11-	Front Axle Left Upper	Pick up 4WD GBVAJQJ/P4AT		Track Control Arm	S062115
	2011.11-	Front Axle Left Upper	Pick up 4WD GBVAJQJ/P4AT		Track Control Arm	S062144
	2011.11-	Front Axle Right Upper	Pick up 4WD GBVAJQJ/P4AT		Track Control Arm	S062116
	2011.11-	Front Axle Right Upper	Pick up 4WD GBVAJQJ/P4AT		Track Control Arm	S062145
	2011.11-	Front Axle Left & Right Lower	Pick up 4WD GBVAJQJ/P4AT		Control Arm Bushing	531687
	2011.11-	Front Axle Left & Right Upper	Pick up 4WD GBVAJQJ/P4AT		Control Arm Bushing	531686
	2011.11-	Front Axle Left	Pick up 4WD GBVAJQJ/P4AT		Tie Rod End	S071298
	2011.11-	Front Axle Left	Pick up 4WD GBVAJQJ/P4AT		Tie Rod End	S071567
	2011.11-	Front Axle Right	Pick up 4WD GBVAJQJ/P4AT		Tie Rod End	S071299
	2011.11-	Front Axle Right	Pick up 4WD GBVAJQJ/P4AT		Tie Rod End	S071568
	2011.11-	Front Axle Left	Pick up 4WD GBVAJQJ/P4AT		Rod/Strut,stabiliser	S050717
	2011.11-	Front Axle Right	Pick up 4WD GBVAJQJ/P4AT		Rod/Strut,stabiliser	S050718
	2011.11-	Front Axle Left & Right	Pick up 4WD GBVAJQJ/P4AT		Rod/Strut,stabiliser	S051330
	2011.11-	Front Axle	Pick up 4WD GBVAJQJ/P4AT		Stabiliser Bushing	535009
3.2 (147 kw)	2011.11-	Front Axle Left Upper	Pick up 4WD P5AT		Track Control Arm	S062115
	2011.11-	Front Axle Left Upper	Pick up 4WD P5AT		Track Control Arm	S062144
	2011.11-	Front Axle Right Upper	Pick up 4WD P5AT		Track Control Arm	S062116
	2011.11-	Front Axle Right Upper	Pick up 4WD P5AT		Track Control Arm	S062145
	2011.11-	Front Axle Left & Right Lower	Pick up 4WD P5AT		Control Arm Bushing	531687
	2011.11-	Front Axle Left & Right Upper	Pick up 4WD P5AT		Control Arm Bushing	531686
	2011.11-	Front Axle Left & Right	Pick up 4WD P5AT		Tie Rod Axle Joint	S030727
	2011.11-	Front Axle Left	Pick up 4WD P5AT		Tie Rod End	S071298
	2011.11-	Front Axle Left	Pick up 4WD P5AT		Tie Rod End	S071567
	2011.11-	Front Axle Right	Pick up 4WD P5AT		Tie Rod End	S071299
	2011.11-	Front Axle Right	Pick up 4WD P5AT		Tie Rod End	S071568
	2011.11-	Front Axle Left	Pick up 4WD P5AT		Rod/Strut,stabiliser	S050717
	2011.11-	Front Axle Right	Pick up 4WD P5AT		Rod/Strut,stabiliser	S050718
	2011.11-	Front Axle Left & Right	Pick up 4WD P5AT		Rod/Strut,stabiliser	S051330
	2011.11-	Front Axle	Pick up 4WD P5AT		Stabiliser Bushing	535009
FORD USA						
Edge						
3.5 (198 kw)	2006.08-2014.12	Rear Axle Left & Right	SUV 4WD T35PDED		Track Control Arm	S063201
	2006.08-2014.12	Front Axle Left & Right	SUV 4WD T35PDED		Tie Rod Axle Joint	S030794
	2006.08-2014.12	Front Axle Left	SUV 4WD T35PDED		Tie Rod End	S071839
	2006.08-2014.12	Front Axle Right	SUV 4WD T35PDED		Tie Rod End	S071840
	2006.08-2014.12	Front Axle Left & Right	SUV 4WD T35PDED		Rod/Strut,stabiliser	S051048
3.5 (209 kw)	2015.01-	Rear Axle Left Upper	SUV 4WD C35PDED		Track Control Arm	S063204
	2015.01-	Rear Axle Right Upper	SUV 4WD C35PDED		Track Control Arm	S063203
	2015.01-	Rear Axle Left & Right	SUV 4WD C35PDED		Rod/Strut,stabiliser	S051498
3.5 (213 kw)	2010.01-2014.12	Rear Axle Left & Right	SUV FWD T35PDED		Track Control Arm	S063201
	2010.01-2014.12	Front Axle Left	SUV FWD T35PDED		Tie Rod End	S071839
	2010.01-2014.12	Front Axle Right	SUV FWD T35PDED		Tie Rod End	S071840
	2010.01-2015.12	Rear Axle Left & Right	SUV 4WD T35PDED		Track Control Arm	S063201
	2010.01-2015.12	Front Axle Left & Right	SUV 4WD T35PDED		Tie Rod Axle Joint	S030794
	2010.01-2015.12	Front Axle Left	SUV 4WD T35PDED		Tie Rod End	S071839
	2010.01-2015.12	Front Axle Right	SUV 4WD T35PDED		Tie Rod End	S071840
	2010.01-2015.12	Front Axle Left & Right	SUV 4WD T35PDED		Rod/Strut,stabiliser	S051048
Explorer						
4.0 (152 kw)	1996.09-2002.08	Front Axle Left Upper	SUV RWD 99XS		Track Control Arm	S061461
	1996.09-2002.08	Front Axle Right Upper	SUV RWD 99XS		Track Control Arm	S060480
	1996.09-2002.08	Front Axle Right Upper	SUV RWD 99XS		Track Control Arm	S061462
	1996.09-2002.08	Front Axle Left & Right Lower	SUV RWD 99XS		Ball Joint	S080071
	1996.09-2002.08	Front Axle Left & Right Lower	SUV RWD 99XS		Ball Joint	S080931
	1996.09-2002.08	Front Axle Left & Right	SUV RWD 99XS		Tie Rod Axle Joint	S030096
	1996.09-2002.08	Front Axle Left & Right	SUV RWD 99XS		Tie Rod End	S070186
	1996.09-2002.08	Front Axle Left & Right	SUV RWD 99XS		Tie Rod End	S071261
	1996.09-2002.08	Front Axle Left & Right	SUV RWD 99XS		Rod/Strut,stabiliser	S050469
	1996.09-2002.08	Rear Axle Left & Right	SUV RWD 99XS		Rod/Strut,stabiliser	S050937
	1996.10-2001.12	Front Axle Left Upper	SUV 4WD 99XS		Track Control Arm	S061461
	1996.10-2001.12	Front Axle Right Upper	SUV 4WD 99XS		Track Control Arm	S060480



	 YEAR	FITTING POSITION	BODY STYLE & DRIVE TYPE & ENGINE	REMARKS	PRODUCT	GSP Ref.
FORD USA Explorer						
4.0 (152 kw)	1996.10-2001.12	Front Axle Right Upper	SUV 4WD 99XS		Track Control Arm	S061462
	1996.10-2001.12	Rear Axle Left & Right Lower	SUV 4WD 99XS		Track Control Arm	S061286
	1996.10-2001.12	Front Axle Left & Right Lower	SUV 4WD 99XS		Ball Joint	S080071
	1996.10-2001.12	Front Axle Left & Right Lower	SUV 4WD 99XS		Ball Joint	S080931
	1996.10-2001.12	Front Axle Left & Right	SUV 4WD 99XS		Tie Rod Axle Joint	S030096
	1996.10-2001.12	Front Axle Left & Right	SUV 4WD 99XS		Tie Rod End	S070186
	1996.10-2001.12	Front Axle Left & Right	SUV 4WD 99XS		Tie Rod End	S071261
	1996.10-2001.12	Front Axle Left & Right	SUV 4WD 99XS		Rod/Strut,stabiliser	S050469
	1996.10-2001.12	Rear Axle Left & Right	SUV 4WD 99XS		Rod/Strut,stabiliser	S050937
4.0 (157 kw)	2001.09-2006.04	Front Axle Left Upper	SUV 4WD 99EA		Track Control Arm	S061461
	2001.09-2006.04	Front Axle Right Upper	SUV 4WD 99EA		Track Control Arm	S061462
	2001.09-2006.04	Front Axle Left & Right Upper	SUV 4WD 99EA		Ball Joint	S080729
	2001.09-2006.04	Front Axle Left & Right	SUV 4WD 99EA		Tie Rod Axle Joint	S030533
	2001.09-2006.04	Front Axle Left & Right	SUV 4WD 99EA		Tie Rod End	S071137
	2006.05-2011.05	Front Axle Left & Right Lower	SUV RWD 99EA		Ball Joint	S080708
F-150 Extended Cab						
3.7 (225 kw)	2013.09-	Front Axle Left & Right Lower	Pick up AWD 99M	Date to:2013.10	Ball Joint	S081068
	2013.09-	Front Axle Left & Right Lower	Pick up AWD 99M		Control Arm Bushing	535494
F-150 Standard Cab						
4.6 (185 kw)	2008.09-2010.12	Front Axle Left & Right Lower	Pick up AWD 999		Ball Joint	S081068
	2008.09-2010.12	Front Axle Left & Right Lower	Pick up AWD 999		Control Arm Bushing	535494
F150						
5.4 (280 kw)	2001.05-2003.11	Front Axle Left Upper	Pick up RWD 9931		Track Control Arm	S062090
	2001.05-2003.11	Front Axle Right Upper	Pick up RWD 9931		Track Control Arm	S061504
	2001.05-2003.11	Front Axle Left & Right Lower	Pick up RWD 9931		Ball Joint	S080931
	2001.05-2003.11	Front Axle Left	Pick up RWD 9931		Tie Rod End	S070801
	2001.05-2003.11	Front Axle Right	Pick up RWD 9931		Tie Rod End	S070802
6.2 (306 kw)	2010.09-2014.11	Front Axle Left & Right	Pick up RWD T62RSEM		Rod/Strut,stabiliser	S051492
Mustang						
2.3 (231 kw)	2014.12-	Front Axle Left & Right	Coupe RWD C23HD0D		Rod/Strut,stabiliser	S051471
	2014.12-	Rear Axle Left & Right	Coupe RWD C23HD0D		Rod/Strut,stabiliser	S051498
4.0 (157 kw)	2004.12-2010.12	Front Axle Left & Right	Coupe RWD C40VSEX		Tie Rod Axle Joint	S030776
5.0 (307 kw)	2010.09-2014.08	Front Axle Left & Right	Coupe RWD 99F		Tie Rod Axle Joint	S030776
Ranger						
2.2 (92 kw)	2011.04-	Front Axle Left Upper	Pick up 4WD GBVAJQW	for vehicles with heavy duty suspension	Track Control Arm	S062115
	2011.04-	Front Axle Left Upper	Pick up 4WD GBVAJQW	Equipment Vart..ride height pack	Track Control Arm	S062144
	2011.04-	Front Axle Right Upper	Pick up 4WD GBVAJQW	for vehicles with heavy duty suspension	Track Control Arm	S062116
	2011.04-	Front Axle Right Upper	Pick up 4WD GBVAJQW	Equipment Vart..ride height pack	Track Control Arm	S062145
	2011.04-	Front Axle Left & Right Lower	Pick up 4WD GBVAJQW		Control Arm Bushing	531687
	2011.04-	Front Axle Left & Right Upper	Pick up 4WD GBVAJQW		Control Arm Bushing	531686
	2011.04-	Front Axle Left	Pick up 4WD GBVAJQW	Manufacturer Restriction:Reinforced susp.	Tie Rod End	S071298
	2011.04-	Front Axle Left	Pick up 4WD GBVAJQW	for vehicles with hydraulic power steering	Tie Rod End	S071567
	2011.04-	Front Axle Right	Pick up 4WD GBVAJQW	Manufacturer Restriction:Reinforced susp.	Tie Rod End	S071299
	2011.04-	Front Axle Right	Pick up 4WD GBVAJQW	for vehicles with hydraulic power steering	Tie Rod End	S071568
	2011.04-	Front Axle Left	Pick up 4WD GBVAJQW		Rod/Strut,stabiliser	S050717
	2011.04-	Front Axle Right	Pick up 4WD GBVAJQW		Rod/Strut,stabiliser	S050718
	2011.04-	Front Axle Left & Right	Pick up 4WD GBVAJQW		Rod/Strut,stabiliser	S051330
	2011.04-	Front Axle	Pick up 4WD GBVAJQW		Stabiliser Bushing	535009
2.2 (110 kw)	2011.04-	Front Axle Left Upper	Pick up 4WD GBVAJQJ	for vehicles with heavy duty suspension	Track Control Arm	S062115
	2011.04-	Front Axle Left Upper	Pick up 4WD GBVAJQJ		Track Control Arm	S062115
	2011.04-	Front Axle Left Upper	Pick up 4WD GBVAJQJ	Equipment Vart..ride height pack	Track Control Arm	S062144
	2011.04-	Front Axle Left Upper	Pick up 4WD GBVAJQJ		Track Control Arm	S062144
	2011.04-	Front Axle Right Upper	Pick up 4WD GBVAJQJ	for vehicles with heavy duty suspension	Track Control Arm	S062116
	2011.04-	Front Axle Right Upper	Pick up 4WD GBVAJQJ		Track Control Arm	S062116
	2011.04-	Front Axle Right Upper	Pick up 4WD GBVAJQJ	Equipment Vart..ride height pack	Track Control Arm	S062145
	2011.04-	Front Axle Right Upper	Pick up 4WD GBVAJQJ		Track Control Arm	S062145
	2011.04-	Front Axle Left & Right Lower	Pick up 4WD GBVAJQJ		Control Arm Bushing	531687
	2011.04-	Front Axle Left & Right Upper	Pick up 4WD GBVAJQJ		Control Arm Bushing	531686
	2011.04-	Front Axle Left	Pick up 4WD GBVAJQJ	Manufacturer Restriction:Reinforced susp.	Tie Rod End	S071298
	2011.04-	Front Axle Left	Pick up 4WD GBVAJQJ		Tie Rod End	S071298
	2011.04-	Front Axle Left	Pick up 4WD GBVAJQJ	for vehicles with hydraulic power steering	Tie Rod End	S071567
	2011.04-	Front Axle Left	Pick up 4WD GBVAJQJ		Tie Rod End	S071567
	2011.04-	Front Axle Right	Pick up 4WD GBVAJQJ	Manufacturer Restriction:Reinforced susp.	Tie Rod End	S071299
	2011.04-	Front Axle Right	Pick up 4WD GBVAJQJ		Tie Rod End	S071299



	 YEAR	FITTING POSITION	BODY STYLE & DRIVE TYPE & ENGINE	REMARKS	PRODUCT	GSP Ref.
FORD USA Ranger						
2.2 (110 kw)	2011.04-	Front Axle Right	Pick up 4WD GBVAJQJ	for vehicles with hydraulic power steering	Tie Rod End	S071568
	2011.04-	Front Axle Right	Pick up 4WD GBVAJQJ		Tie Rod End	S071568
	2011.04-	Front Axle Left	Pick up 4WD GBVAJQJ		Rod/Strut, stabiliser	S050717
	2011.04-	Front Axle Right	Pick up 4WD GBVAJQJ		Rod/Strut, stabiliser	S050718
	2011.04-	Front Axle Left & Right	Pick up 4WD GBVAJQJ		Rod/Strut, stabiliser	S051330
	2011.04-	Front Axle	Pick up 4WD GBVAJQJ		Stabiliser Bushing	S35009
2.2 (118 kw)	2015.05-	Front Axle Left Upper	Pick up 4WD GBVAJQJ/T22DD0P	for vehicles with heavy duty suspension	Track Control Arm	S062115
	2015.05-	Front Axle Left Upper	Pick up RWD T22DD0P	for vehicles with heavy duty suspension	Track Control Arm	S062115
	2015.05-	Front Axle Left Upper	Pick up 4WD GBVAJQJ/T22DD0P	Equipment Vart.:ride height pack	Track Control Arm	S062144
	2015.05-	Front Axle Left Upper	Pick up RWD T22DD0P	Equipment Vart.:ride height pack	Track Control Arm	S062144
	2015.05-	Front Axle Right Upper	Pick up 4WD GBVAJQJ/T22DD0P	for vehicles with heavy duty suspension	Track Control Arm	S062116
	2015.05-	Front Axle Right Upper	Pick up RWD T22DD0P	for vehicles with heavy duty suspension	Track Control Arm	S062116
	2015.05-	Front Axle Right Upper	Pick up 4WD GBVAJQJ/T22DD0P	Equipment Vart.:ride height pack	Track Control Arm	S062145
	2015.05-	Front Axle Right Upper	Pick up RWD T22DD0P	Equipment Vart.:ride height pack	Track Control Arm	S062145
	2015.05-	Front Axle Left & Right Lower	Pick up 4WD GBVAJQJ/T22DD0P		Control Arm Bushing	S31687
	2015.05-	Front Axle Left & Right Lower	Pick up RWD T22DD0P		Control Arm Bushing	S31687
	2015.05-	Front Axle Left & Right Upper	Pick up 4WD GBVAJQJ/T22DD0P		Control Arm Bushing	S31686
	2015.05-	Front Axle Left & Right Upper	Pick up RWD T22DD0P		Control Arm Bushing	S31686
	2015.05-	Front Axle Left	Pick up 4WD GBVAJQJ/T22DD0P	Manufacturer Restriction:Reinforced susp.	Tie Rod End	S071298
	2015.05-	Front Axle Left	Pick up RWD T22DD0P	Manufacturer Restriction:Reinforced susp.	Tie Rod End	S071298
	2015.05-	Front Axle Left	Pick up 4WD GBVAJQJ/T22DD0P	for vehicles with hydraulic power steering	Tie Rod End	S071567
	2015.05-	Front Axle Left	Pick up RWD T22DD0P		Tie Rod End	S071567
	2015.05-	Front Axle Right	Pick up 4WD GBVAJQJ/T22DD0P	Manufacturer Restriction:Reinforced susp.	Tie Rod End	S071299
	2015.05-	Front Axle Right	Pick up RWD T22DD0P	Manufacturer Restriction:Reinforced susp.	Tie Rod End	S071299
	2015.05-	Front Axle Right	Pick up 4WD GBVAJQJ/T22DD0P	for vehicles with hydraulic power steering	Tie Rod End	S071568
	2015.05-	Front Axle Right	Pick up RWD T22DD0P		Tie Rod End	S071568
	2015.05-	Front Axle Left	Pick up 4WD GBVAJQJ/T22DD0P		Rod/Strut, stabiliser	S050717
	2015.05-	Front Axle Right	Pick up 4WD GBVAJQJ/T22DD0P		Rod/Strut, stabiliser	S050718
	2015.05-	Front Axle Left & Right	Pick up 4WD GBVAJQJ/T22DD0P		Rod/Strut, stabiliser	S051330
	2015.05-	Front Axle	Pick up 4WD GBVAJQJ/T22DD0P		Stabiliser Bushing	S35009
	2015.05-	Front Axle	Pick up RWD T22DD0P		Stabiliser Bushing	S35009
	3.2 (147 kw)	2011.04-	Front Axle Left Upper	Pick up 4WD SA2R/SA2S/SA2W/SAFA	for vehicles with heavy duty suspension	Track Control Arm
2011.04-		Front Axle Left Upper	Pick up 4WD SA2R/SA2S/SA2W/SAFA		Track Control Arm	S062115
2011.04-		Front Axle Left Upper	Pick up 4WD SA2R/SA2S/SA2W/SAFA	Equipment Vart.:ride height pack	Track Control Arm	S062144
2011.04-		Front Axle Left Upper	Pick up 4WD SA2R/SA2S/SA2W/SAFA		Track Control Arm	S062144
2011.04-		Front Axle Right Upper	Pick up 4WD SA2R/SA2S/SA2W/SAFA	for vehicles with heavy duty suspension	Track Control Arm	S062116
2011.04-		Front Axle Right Upper	Pick up 4WD SA2R/SA2S/SA2W/SAFA		Track Control Arm	S062116
2011.04-		Front Axle Right Upper	Pick up 4WD SA2R/SA2S/SA2W/SAFA	Equipment Vart.:ride height pack	Track Control Arm	S062145
2011.04-		Front Axle Right Upper	Pick up 4WD SA2R/SA2S/SA2W/SAFA		Track Control Arm	S062145
2011.04-		Front Axle Left & Right Lower	Pick up 4WD SA2R/SA2S/SA2W/SAFA		Control Arm Bushing	S31687
2011.04-		Front Axle Left & Right Upper	Pick up 4WD SA2R/SA2S/SA2W/SAFA		Control Arm Bushing	S31686
2011.04-		Front Axle Left & Right	Pick up 4WD SA2R/SA2S/SA2W/SAFA		Tie Rod Axle Joint	S030727
2011.04-		Front Axle Left	Pick up 4WD SA2R/SA2S/SA2W/SAFA	Manufacturer Restriction:Reinforced susp.	Tie Rod End	S071298
2011.04-		Front Axle Left	Pick up 4WD SA2R/SA2S/SA2W/SAFA		Tie Rod End	S071298
2011.04-		Front Axle Left	Pick up 4WD SA2R/SA2S/SA2W/SAFA		Tie Rod End	S071567
2011.04-		Front Axle Right	Pick up 4WD SA2R/SA2S/SA2W/SAFA	Manufacturer Restriction:Reinforced susp.	Tie Rod End	S071299
2011.04-		Front Axle Right	Pick up 4WD SA2R/SA2S/SA2W/SAFA		Tie Rod End	S071299
2011.04-		Front Axle Right	Pick up 4WD SA2R/SA2S/SA2W/SAFA		Tie Rod End	S071568
2011.04-		Front Axle Left	Pick up 4WD SA2R/SA2S/SA2W/SAFA		Rod/Strut, stabiliser	S050717
2011.04-		Front Axle Right	Pick up 4WD SA2R/SA2S/SA2W/SAFA		Rod/Strut, stabiliser	S050718
2011.04-		Front Axle Left & Right	Pick up 4WD SA2R/SA2S/SA2W/SAFA		Rod/Strut, stabiliser	S051330
2011.04-	Front Axle	Pick up 4WD SA2R/SA2S/SA2W/SAFA		Stabiliser Bushing	S35009	
Taurus						
3.0 (149 kw)	1996.01-1999.12	Front Axle Left & Right Lower	Saloon FWD 99SSF1		Ball Joint	S080518
	1996.01-1999.12	Front Axle Left & Right	Saloon FWD 99SSF1		Tie Rod Axle Joint	S030744
HONDA Accord						
2.0 (115 kw)	2008.06-2015.06	Front Axle Left Lower	Saloon FWD R20A3		Track Control Arm	S061231
	2008.06-2015.06	Front Axle Left Upper	Saloon FWD R20A3		Track Control Arm	S061526
	2008.06-2015.06	Front Axle Right Lower	Saloon FWD R20A3		Track Control Arm	S061232
	2008.06-2015.06	Front Axle Right Upper	Saloon FWD R20A3		Track Control Arm	S061527
	2008.06-2015.06	Rear Axle Left Upper	Saloon FWD R20A3		Track Control Arm	S061848
	2008.06-2015.06	Rear Axle Right Upper	Saloon FWD R20A3		Track Control Arm	S061849
	2008.06-2015.06	Front Axle Left & Right Lower	Saloon FWD R20A3		Ball Joint	S080473



	 YEAR	FITTING POSITION	BODY STYLE & DRIVE TYPE & ENGINE	REMARKS	PRODUCT	GSP Ref.
HONDA						
Accord						
2.0 (115 kw)	2008.06-2015.06	Front Axle Left & Right Upper	Saloon FWD R20A3		Ball Joint	S080416
	2008.06-2015.06	Front Axle Left & Right Lower	Saloon FWD R20A3		Control Arm Bushing	512892
	2008.06-2015.06	Front Axle Left & Right Lower	Saloon FWD R20A3		Control Arm Bushing	516452
	2008.06-2015.06	Front Axle Left & Right Upper	Saloon FWD R20A3		Control Arm Bushing	513248
	2008.06-2015.06	Rear Axle Left & Right Centre	Saloon FWD R20A3		Control Arm Bushing	535104
	2008.06-2015.06	Rear Axle Left & Right Lower	Saloon FWD R20A3		Control Arm Bushing	535106
	2008.06-2015.06	Rear Axle Left & Right Lower	Saloon FWD R20A3		Control Arm Bushing	535107
	2008.06-2015.06	Rear Axle Left & Right Upper	Saloon FWD R20A3		Control Arm Bushing	533527
	2008.06-2015.06	Rear Axle Left & Right Lower Inner	Saloon FWD R20A3		Control Arm Bushing	535105
	2008.06-2015.06	Rear Axle Left & Right Lower Outer	Saloon FWD R20A3		Control Arm Bushing	535108
	2008.06-2015.06	Front Axle Left & Right	Saloon FWD R20A3		Tie Rod Axle Joint	S030647
	2008.06-2015.06	Front Axle Left & Right	Saloon FWD R20A3		Tie Rod Axle Joint	S030785
	2008.06-2015.06	Front Axle Left	Saloon FWD R20A3		Tie Rod End	S070201
	2008.06-2015.06	Front Axle Left	Saloon FWD R20A3		Tie Rod End	S070822
	2008.06-2015.06	Front Axle Right	Saloon FWD R20A3		Tie Rod End	S070202
	2008.06-2015.06	Front Axle Right	Saloon FWD R20A3		Tie Rod End	S070821
	2008.06-2015.06	Front Axle Left	Saloon FWD R20A3		Rod/Strut, stabiliser	S050655
	2008.06-2015.06	Front Axle Right	Saloon FWD R20A3		Rod/Strut, stabiliser	S050180
	2008.06-2015.06	Rear Axle Left	Saloon FWD R20A3		Rod/Strut, stabiliser	S050657
	2008.06-2015.06	Rear Axle Right	Saloon FWD R20A3		Rod/Strut, stabiliser	S050658
	2008.06-2015.06	Front Axle Left	Saloon FWD R20A3		Stabiliser Bushing	517301
	2008.06-2015.06	Front Axle Right	Saloon FWD R20A3		Stabiliser Bushing	517300
	2008.06-2015.06	Front Axle	Saloon FWD R20A3		Stabiliser Bushing	535008
	2008.06-2015.06	Rear Axle	Saloon FWD R20A3		Stabiliser Bushing	517303
2.2 (110 kw)	1996.01-1998.09	Front Axle Left Lower	Saloon FWD F22Z2		Track Control Arm	S060501
	1996.01-1998.09	Front Axle Left Upper	Saloon FWD F22Z2		Track Control Arm	S060484
	1996.01-1998.09	Front Axle Right Lower	Saloon FWD F22Z2		Track Control Arm	S060502
	1996.01-1998.09	Front Axle Right Upper	Saloon FWD F22Z2		Track Control Arm	S060483
	1996.01-1998.09	Rear Axle Left Lower	Saloon FWD F22Z2		Track Control Arm	S061854
	1996.01-1998.09	Rear Axle Left Upper	Saloon FWD F22Z2		Track Control Arm	S060197
	1996.01-1998.09	Rear Axle Right Lower	Saloon FWD F22Z2		Track Control Arm	S061855
	1996.01-1998.09	Rear Axle Right Upper	Saloon FWD F22Z2		Track Control Arm	S060198
	1996.01-1998.09	Front Axle Left & Right Lower	Saloon FWD F22Z2		Ball Joint	S080080
	1996.01-1998.09	Rear Axle Left & Right Lower	Saloon FWD F22Z2		Control Arm Bushing	514900
	1996.01-1998.09	Rear Axle Left & Right Upper	Saloon FWD F22Z2		Control Arm Bushing	512896
	1996.01-1998.09	Front Axle Left & Right	Saloon FWD F22Z2		Tie Rod Axle Joint	S030098
	1996.01-1998.09	Front Axle Left	Saloon FWD F22Z2		Tie Rod End	S070206
	1996.01-1998.09	Front Axle Right	Saloon FWD F22Z2		Tie Rod End	S070207
	1996.01-1998.09	Front Axle Left & Right	Saloon FWD F22Z2		Tie Rod End	S070840
	1996.01-1998.09	Front Axle Left & Right	Saloon FWD F22Z2		Rod/Strut, stabiliser	517584
	1996.01-1998.09	Front Axle	Saloon FWD F22Z2		Stabiliser Bushing	513256
	1996.01-1998.09	Front Axle	Saloon FWD F22Z2	AT for model year 2000, AT for right-hand drive vehicles for model year 2000	Steering Rack Bellow Kit	540211K
2.3 (112 kw)	1997.06-2003.03	Front Axle Left & Right Upper	Saloon FWD F23Z5		Control Arm Bushing	517817
	1997.06-2003.03	Front Axle Left & Right Upper	Saloon FWD F23Z5	SMT,4AT,Date from-to:1998-2002	Control Arm Bushing	535115
	1997.06-2003.03	Rear Axle Left & Right Lower	Saloon FWD F23Z5		Control Arm Bushing	514944
	1997.06-2003.03	Front Axle	Saloon FWD F23Z5		Stabiliser Bushing	512890
2.3 (113 kw)	2000.11-2002.12	Front Axle Left Lower	Saloon FWD F23Z5		Track Control Arm	S060499
	2000.11-2002.12	Front Axle Left Upper	Saloon FWD F23Z5		Track Control Arm	S060489
	2000.11-2002.12	Front Axle Right Lower	Saloon FWD F23Z5		Track Control Arm	S060500
	2000.11-2002.12	Front Axle Right Upper	Saloon FWD F23Z5		Track Control Arm	S060490
	2000.11-2002.12	Front Axle Left & Right Lower	Saloon FWD F23Z5		Ball Joint	S080080
	2000.11-2002.12	Front Axle Left & Right Upper	Saloon FWD F23Z5		Ball Joint	S080416
	2000.11-2002.12	Front Axle Left & Right	Saloon FWD F23Z5		Control Arm Bushing	517547
	2000.11-2002.12	Front Axle Left & Right Lower	Saloon FWD F23Z5		Control Arm Bushing	516418
	2000.11-2002.12	Front Axle Left & Right Upper	Saloon FWD F23Z5		Control Arm Bushing	517817
	2000.11-2002.12	Front Axle Left & Right Upper	Saloon FWD F23Z5		Control Arm Bushing	535115
	2000.11-2002.12	Rear Axle Left & Right Centre	Saloon FWD F23Z5		Control Arm Bushing	516138
	2000.11-2002.12	Rear Axle Left & Right Lower	Saloon FWD F23Z5	Date to:2002.12	Control Arm Bushing	514944
	2000.11-2002.12	Rear Axle Left & Right Lower	Saloon FWD F23Z5	Date to:2002.12	Control Arm Bushing	516115
	2000.11-2002.12	Rear Axle Left & Right Lower	Saloon FWD F23Z5	Date to:2002.12	Control Arm Bushing	516122
	2000.11-2002.12	Rear Axle Left & Right Lower Outer	Saloon FWD F23Z5		Control Arm Bushing	516595
	2000.11-2002.12	Front Axle Left	Saloon FWD F23Z5		Tie Rod End	S070206
	2000.11-2002.12	Front Axle Right	Saloon FWD F23Z5		Tie Rod End	S070207
	2000.11-2002.12	Front Axle Left	Saloon FWD F23Z5		Rod/Strut, stabiliser	S050174



	 YEAR	FITTING POSITION	BODY STYLE & DRIVE TYPE & ENGINE	REMARKS	PRODUCT	GSP Ref.
HONDA						
Accord						
2.3 (113 kw)	2000.11-2002.12	Front Axle Right	Saloon FWD F23Z5		Rod/Strut, stabiliser	S050175
	2000.11-2002.12	Rear Axle Left	Saloon FWD F23Z5		Rod/Strut, stabiliser	S050166
	2000.11-2002.12	Rear Axle Right	Saloon FWD F23Z5		Rod/Strut, stabiliser	S050165
	2000.11-2002.12	Front Axle	Saloon FWD F23Z5		Stabiliser Bushing	512881
	2000.11-2002.12	Rear Axle	Saloon FWD F23Z5		Stabiliser Bushing	517832
	2000.11-2002.12	Front Axle	Saloon FWD F23Z5		Steering Boot	540045
	2000.11-2002.12	Front Axle	Saloon FWD F23Z5	Date to:2002.12	Steering Rack Bellow Kit	540045S
	2000.11-2002.12	Front Axle	Saloon FWD F23Z5	Date to:2002.12,5MT	Steering Rack Bellow Kit	540211K
2.3 (116 kw)	1994.01-1995.12	Front Axle Left Upper	Saloon FWD H23A3		Track Control Arm	S060484
	1994.01-1995.12	Front Axle Right Upper	Saloon FWD H23A3		Track Control Arm	S060483
	1994.01-1995.12	Rear Axle Left Upper	Saloon FWD H23A3		Track Control Arm	S060197
	1994.01-1995.12	Rear Axle Right Upper	Saloon FWD H23A3		Track Control Arm	S060198
	1994.01-1995.12	Front Axle Left & Right Lower	Saloon FWD H23A3		Ball Joint	S080080
	1994.01-1995.12	Rear Axle Left & Right Lower	Saloon FWD H23A3		Control Arm Bushing	514900
	1994.01-1995.12	Rear Axle Left & Right Upper	Saloon FWD H23A3		Control Arm Bushing	512896
	1994.01-1995.12	Front Axle Left & Right	Saloon FWD H23A3		Tie Rod Axle Joint	S030098
	1994.01-1995.12	Front Axle Left	Saloon FWD H23A3		Tie Rod End	S070206
	1994.01-1995.12	Front Axle Right	Saloon FWD H23A3		Tie Rod End	S070207
	1994.01-1995.12	Front Axle Left & Right	Saloon FWD H23A3		Rod/Strut, stabiliser	517584
	1994.01-1995.12	Front Axle	Saloon FWD H23A3		Stabiliser Bushing	513256
	1994.01-1995.12	Front Axle	Saloon FWD H23A3	with breather valve	Steering Rack Bellow Kit	540217S
2.4 (118 kw)	2003.01-2006.03	Front Axle Left & Right Upper	Saloon FWD K24A4		Control Arm Bushing	513248
	2003.01-2006.03	Rear Axle Left & Right Centre	Saloon FWD K24A4		Control Arm Bushing	516138
	2003.01-2006.03	Rear Axle Left & Right Lower	Saloon FWD K24A4	5AT,5MT,Date from:2003	Control Arm Bushing	514944
	2003.01-2006.03	Rear Axle Left & Right Lower	Saloon FWD K24A4	5AT,6MT,5MT	Control Arm Bushing	516115
	2003.01-2006.03	Front Axle Left & Right	Saloon FWD K24A4		Tie Rod Axle Joint	S030884
3.0 (177 kw)	2002.09-2008.05	Front Axle Left & Right Upper	Saloon FWD J30A4		Control Arm Bushing	513248
	2002.09-2008.05	Rear Axle Left & Right Centre	Saloon FWD J30A4		Control Arm Bushing	516138
	2002.09-2008.05	Rear Axle Left & Right Lower	Saloon FWD J30A4	AT,Date to:2003.12	Control Arm Bushing	514944
	2002.09-2008.05	Rear Axle Left & Right Lower	Saloon FWD J30A4	AT	Control Arm Bushing	516115
3.5 (202 kw)	2008.06-2012.09	Front Axle Left & Right Upper	Saloon FWD J35Z2/J35Z3		Control Arm Bushing	513248
	2008.06-2012.09	Rear Axle Left & Right Upper	Saloon FWD J35Z2/J35Z3		Control Arm Bushing	533527
	2008.06-2012.09	Rear Axle Left & Right Lower Inner	Saloon FWD J35Z2/J35Z3		Control Arm Bushing	535105
	2008.06-2012.09	Rear Axle Left & Right Lower Outer	Saloon FWD J35Z2/J35Z3		Control Arm Bushing	535108
	2008.06-2012.09	Front Axle	Saloon FWD J35Z2/J35Z3		Stabiliser Bushing	535008
Accord Aerodeck						
2.2 (103 kw)	1991.10-1993.10	Rear Axle Left Upper	Estate FWD F22A6		Track Control Arm	S060197
	1991.10-1993.10	Rear Axle Right Upper	Estate FWD F22A6		Track Control Arm	S060198
	1991.10-1993.10	Rear Axle Left & Right Lower Outer	Estate FWD F22A6	Date from:1993.01	Control Arm Bushing	516557
	1991.10-1993.10	Rear Axle Left & Right Lower Outer	Estate FWD F22A6	Chassis no.from:1100001,1200000,AT	Control Arm Bushing	516594
	1991.10-1993.10	Front Axle Left & Right	Estate FWD F22A6		Rod/Strut, stabiliser	517584
Accord VIII/Inspire						
2.0 (114 kw)	2008.07-2012.09	Front Axle Left & Right Upper	Saloon FWD R20A3		Control Arm Bushing	513248
	2008.07-2012.09	Rear Axle Left & Right Upper	Saloon FWD R20A3		Control Arm Bushing	533527
	2008.07-2012.09	Rear Axle Left & Right Lower Inner	Saloon FWD R20A3		Control Arm Bushing	535105
	2008.07-2012.09	Rear Axle Left & Right Lower Outer	Saloon FWD R20A3		Control Arm Bushing	535108
	2008.07-2012.09	Front Axle	Saloon FWD R20A3		Stabiliser Bushing	535008
City						
1.5 (85 kw)	2014.09-	Front Axle Left & Right Lower	Saloon FWD L15A7	for model year:2019	Ball Joint	S063543
Civic						
1.5 (74 kw)	1991.10-1996.01	Front Axle Left Upper	Saloon FWD D15B2		Track Control Arm	S060481
	1991.10-1996.01	Front Axle Right Upper	Saloon FWD D15B2		Track Control Arm	S060482
	1991.10-1996.01	Front Axle Left & Right Lower	Saloon FWD D15B2		Ball Joint	S080073
	1991.10-1996.01	Front Axle Left & Right Lower	Saloon FWD D15B2		Control Arm Bushing	511111
	1991.10-1996.01	Front Axle Left & Right Lower	Saloon FWD D15B2		Control Arm Bushing	511118
	1991.10-1996.01	Rear Axle Left & Right	Saloon FWD D15B2		Control Arm Bushing	511113
	1991.10-1996.01	Rear Axle Left & Right Lower	Saloon FWD D15B2		Control Arm Bushing	514956
	1991.10-1996.01	Rear Axle Left & Right Lower	Saloon FWD D15B2		Control Arm Bushing	516141
	1991.10-1996.01	Rear Axle Left & Right Lower	Saloon FWD D15B2		Control Arm Bushing	530789
	1991.10-1996.01	Front Axle Left & Right	Saloon FWD D15B2		Tie Rod Axle Joint	S030097
	1991.10-1996.01	Front Axle Left	Saloon FWD D15B2		Tie Rod End	S070188
	1991.10-1996.01	Front Axle Right	Saloon FWD D15B2		Tie Rod End	S070189
	1991.10-1996.01	Front Axle Left & Right	Saloon FWD D15B2		Rod/Strut, stabiliser	S050161



	 YEAR	FITTING POSITION	BODY STYLE & DRIVE TYPE & ENGINE	REMARKS	PRODUCT	GSP Ref.
HONDA Civic						
1.5 (127 kw)	2016.06-	Front Axle Left & Right Lower	Saloon FWD L15BB	Vehicle Production Country:USA	Ball Joint	S081046
	2016.06-	Front Axle Left & Right Lower	Saloon FWD L15BB		Ball Joint	S081051
1.6 (78 kw)	1996.06-2000.12	Rear Axle Left & Right Lower Inner	Saloon FWD D16Y8		Track Control Arm	511739
	1996.06-2000.12	Front Axle Left & Right Lower	Saloon FWD D16Y8	MT,Date from:1997.01	Control Arm Bushing	516245
	1996.06-2000.12	Front Axle Left & Right Lower	Saloon FWD D16Y8	MT,Date from:1997.01	Control Arm Bushing	516579
	1996.06-2000.12	Rear Axle Left & Right Lower	Saloon FWD D16Y8		Control Arm Bushing	516031
	1996.06-2000.12	Rear Axle Left & Right Lower	Saloon FWD D16Y8		Control Arm Bushing Kit	516025S
	1996.06-2000.12	Rear Axle Left & Right Upper	Saloon FWD D16Y8		Control Arm Bushing Kit	514909S
1.6 (79 kw)	1995.11-1996.12	Front Axle Left & Right Upper	Hatchback FWD D16Y2		Control Arm Bushing	516589
	1995.11-1996.12	Front Axle Left & Right	Hatchback FWD D16Y2		Rod/Strut,stabiliser	517583
	1995.11-1996.12	Front Axle Left & Right	Hatchback FWD D16Y2		Rod/Strut,stabiliser	S050162
1.6 (92 kw)	1991.10-1995.11	Front Axle Left Lower	Hatchback FWD D16Z6/D16Z7		Track Control Arm	S060515
	1991.10-1995.11	Front Axle Left Upper	Hatchback FWD D16Z6/D16Z7		Track Control Arm	S060481
	1991.10-1995.11	Front Axle Right Lower	Hatchback FWD D16Z6/D16Z7		Track Control Arm	S060514
	1991.10-1995.11	Front Axle Right Upper	Hatchback FWD D16Z6/D16Z7		Track Control Arm	S060482
	1991.10-1995.11	Rear Axle Left Upper	Hatchback FWD D16Z6/D16Z7		Track Control Arm	S060495
	1991.10-1995.11	Rear Axle Right Upper	Hatchback FWD D16Z6/D16Z7		Track Control Arm	S060496
	1991.10-1995.11	Front Axle Left & Right Lower	Hatchback FWD D16Z6/D16Z7		Ball Joint	S080073
	1991.10-1995.11	Front Axle Left & Right Lower	Hatchback FWD D16Z6/D16Z7		Control Arm Bushing	511111
	1991.10-1995.11	Front Axle Left & Right Lower	Hatchback FWD D16Z6/D16Z7		Control Arm Bushing	511118
	1991.10-1995.11	Front Axle Left & Right Lower	Hatchback FWD D16Z6/D16Z7	Date from:1994.11	Control Arm Bushing	517835
	1991.10-1995.11	Front Axle Left & Right Upper	Hatchback FWD D16Z6/D16Z7		Control Arm Bushing	516589
	1991.10-1995.11	Rear Axle Left & Right	Hatchback FWD D16Z6/D16Z7		Control Arm Bushing	511113
	1991.10-1995.11	Rear Axle Left & Right Lower	Hatchback FWD D16Z6/D16Z7		Control Arm Bushing	514845
	1991.10-1995.11	Rear Axle Left & Right Lower	Hatchback FWD D16Z6/D16Z7		Control Arm Bushing	514956
	1991.10-1995.11	Rear Axle Left & Right Lower	Hatchback FWD D16Z6/D16Z7		Control Arm Bushing	516141
	1991.10-1995.11	Rear Axle Left & Right Lower	Hatchback FWD D16Z6/D16Z7		Control Arm Bushing	530789
	1991.10-1995.11	Rear Axle Left & Right Lower Inner	Hatchback FWD D16Z6/D16Z7		Control Arm Bushing	517592
	1991.10-1995.11	Rear Axle Left & Right Lower	Hatchback FWD D16Z6/D16Z7		Control Arm Bushing Kit	516025S
	1991.10-1995.11	Rear Axle Left & Right Upper	Hatchback FWD D16Z6/D16Z7		Control Arm Bushing Kit	514909S
	1991.10-1995.11	Front Axle Left & Right	Hatchback FWD D16Z6/D16Z7		Tie Rod Axle Joint	S030097
	1991.10-1995.11	Front Axle Left	Hatchback FWD D16Z6/D16Z7		Tie Rod End	S070188
	1991.10-1995.11	Front Axle Right	Hatchback FWD D16Z6/D16Z7		Tie Rod End	S070189
	1991.10-1995.11	Front Axle Left & Right	Hatchback FWD D16Z6/D16Z7		Rod/Strut,stabiliser	517583
	1991.10-1995.11	Front Axle Left & Right	Hatchback FWD D16Z6/D16Z7		Rod/Strut,stabiliser	520398
	1991.10-1995.11	Front Axle Left & Right	Hatchback FWD D16Z6/D16Z7		Rod/Strut,stabiliser	S050161
	1991.10-1995.11	Front Axle Left & Right	Hatchback FWD D16Z6/D16Z7		Rod/Strut,stabiliser	S050162
	1991.10-1995.11	Rear Axle Left & Right	Hatchback FWD D16Z6/D16Z7		Rod/Strut,stabiliser	514249
	1991.10-1995.11	Front Axle	Hatchback FWD D16Z6/D16Z7		Stabiliser Bushing	516445
	1991.10-1995.11	Rear Axle	Hatchback FWD D16Z6/D16Z7		Stabiliser Bushing	517667
	1991.10-1995.11	Front Axle	Hatchback FWD D16Z6/D16Z7		Steering Boot	540008
	1991.10-1995.11	Front Axle	Hatchback FWD D16Z6/D16Z7		Steering Boot	540040
	1991.10-1995.11	Front Axle Left	Hatchback FWD D16Z6/D16Z7		Steering Rack Bellow Kit	540012S
	1991.10-1995.11	Front Axle	Hatchback FWD D16Z6/D16Z7		Steering Rack Bellow Kit	540211K
	1991.10-1995.11	Front Axle	Hatchback FWD D16Z6/D16Z7	with breather valve	Steering Rack Bellow Kit	540217S
	1992.01-1995.12	Front Axle Left Lower	Saloon FWD D16Z6/D16Z7		Track Control Arm	S060515
	1992.01-1995.12	Front Axle Left Upper	Saloon FWD D16Z6/D16Z7		Track Control Arm	S060481
	1992.01-1995.12	Front Axle Right Lower	Saloon FWD D16Z6/D16Z7		Track Control Arm	S060514
	1992.01-1995.12	Front Axle Right Upper	Saloon FWD D16Z6/D16Z7		Track Control Arm	S060482
	1992.01-1995.12	Rear Axle Left Upper	Saloon FWD D16Z6/D16Z7		Track Control Arm	S060495
	1992.01-1995.12	Rear Axle Right Upper	Saloon FWD D16Z6/D16Z7		Track Control Arm	S060496
	1992.01-1995.12	Front Axle Left & Right Lower	Saloon FWD D16Z6/D16Z7		Ball Joint	S080073
	1992.01-1995.12	Front Axle Left & Right Lower	Saloon FWD D16Z6/D16Z7		Control Arm Bushing	511111
	1992.01-1995.12	Front Axle Left & Right Lower	Saloon FWD D16Z6/D16Z7		Control Arm Bushing	511118
	1992.01-1995.12	Front Axle Left & Right Upper	Saloon FWD D16Z6/D16Z7		Control Arm Bushing	516589
	1992.01-1995.12	Rear Axle Left & Right	Saloon FWD D16Z6/D16Z7		Control Arm Bushing	511113
	1992.01-1995.12	Rear Axle Left & Right Centre	Saloon FWD D16Z6/D16Z7		Control Arm Bushing	517591
	1992.01-1995.12	Rear Axle Left & Right Lower	Saloon FWD D16Z6/D16Z7		Control Arm Bushing	514845
	1992.01-1995.12	Rear Axle Left & Right Lower	Saloon FWD D16Z6/D16Z7		Control Arm Bushing	514956
	1992.01-1995.12	Rear Axle Left & Right Lower	Saloon FWD D16Z6/D16Z7		Control Arm Bushing	516141
	1992.01-1995.12	Rear Axle Left & Right Lower	Saloon FWD D16Z6/D16Z7		Control Arm Bushing	530789
	1992.01-1995.12	Rear Axle Left & Right Upper	Saloon FWD D16Z6/D16Z7	Quantity:1	Control Arm Bushing	516576
	1992.01-1995.12	Rear Axle Left & Right Upper	Saloon FWD D16Z6/D16Z7	Quantity:1	Control Arm Bushing	517340
	1992.01-1995.12	Rear Axle Left & Right Lower Inner	Saloon FWD D16Z6/D16Z7		Control Arm Bushing	517592



	 YEAR	FITTING POSITION	BODY STYLE & DRIVE TYPE & ENGINE	REMARKS	PRODUCT	GSP Ref.
HONDA Civic						
1.6 (92 kw)	1992.01-1995.12	Rear Axle Left & Right Lower	Saloon FWD D16Z6/D16Z7		Control Arm Bushing Kit	516025S
	1992.01-1995.12	Rear Axle Left & Right Upper	Saloon FWD D16Z6/D16Z7		Control Arm Bushing Kit	514909S
	1992.01-1995.12	Front Axle Left & Right	Saloon FWD D16Z6/D16Z7		Tie Rod Axle Joint	S030097
	1992.01-1995.12	Front Axle Left	Saloon FWD D16Z6/D16Z7		Tie Rod End	S070188
	1992.01-1995.12	Front Axle Right	Saloon FWD D16Z6/D16Z7		Tie Rod End	S070189
	1992.01-1995.12	Front Axle Left & Right	Saloon FWD D16Z6/D16Z7		Rod/Strut,stabiliser	517583
	1992.01-1995.12	Front Axle Left & Right	Saloon FWD D16Z6/D16Z7		Rod/Strut,stabiliser	520398
	1992.01-1995.12	Front Axle Left & Right	Saloon FWD D16Z6/D16Z7		Rod/Strut,stabiliser	S050161
	1992.01-1995.12	Front Axle Left & Right	Saloon FWD D16Z6/D16Z7		Rod/Strut,stabiliser	S050162
	1992.01-1995.12	Rear Axle Left & Right	Saloon FWD D16Z6/D16Z7		Rod/Strut,stabiliser	514249
	1992.01-1995.12	Front Axle	Saloon FWD D16Z6/D16Z7		Stabiliser Bushing	516445
	1992.01-1995.12	Front Axle	Saloon FWD D16Z6/D16Z7		Stabiliser Bushing	517543
	1992.01-1995.12	Rear Axle	Saloon FWD D16Z6/D16Z7		Stabiliser Bushing	513239
	1992.01-1995.12	Rear Axle	Saloon FWD D16Z6/D16Z7		Stabiliser Bushing	517667
	1992.01-1995.12	Front Axle	Saloon FWD D16Z6/D16Z7		Steering Boot	540008
	1992.01-1995.12	Front Axle	Saloon FWD D16Z6/D16Z7		Steering Boot	540040
	1992.01-1995.12	Front Axle Left	Saloon FWD D16Z6/D16Z7		Steering Rack Bellow Kit	540012S
	1992.01-1995.12	Front Axle	Saloon FWD D16Z6/D16Z7		Steering Rack Bellow Kit	540211K
	1992.01-1995.12	Front Axle	Saloon FWD D16Z6/D16Z7	with breather valve	Steering Rack Bellow Kit	540230S
1.6 (118 kw)	1992.01-1995.10	Front Axle Left Lower	Hatchback FWD B16A2		Track Control Arm	S060515
	1992.01-1995.10	Front Axle Left Upper	Hatchback FWD B16A2		Track Control Arm	S060481
	1992.01-1995.10	Front Axle Right Lower	Hatchback FWD B16A2		Track Control Arm	S060514
	1992.01-1995.10	Front Axle Right Upper	Hatchback FWD B16A2		Track Control Arm	S060482
	1992.01-1995.10	Rear Axle Left Upper	Hatchback FWD B16A2		Track Control Arm	S060495
	1992.01-1995.10	Rear Axle Right Upper	Hatchback FWD B16A2		Track Control Arm	S060496
	1992.01-1995.10	Front Axle Left & Right Lower	Hatchback FWD B16A2		Ball Joint	S080073
	1992.01-1995.10	Front Axle Left & Right Lower	Hatchback FWD B16A2		Control Arm Bushing	511111
	1992.01-1995.10	Front Axle Left & Right Lower	Hatchback FWD B16A2		Control Arm Bushing	511118
	1992.01-1995.10	Front Axle Left & Right Lower	Hatchback FWD B16A2	Date from: 1994.11	Control Arm Bushing	517835
	1992.01-1995.10	Front Axle Left & Right Upper	Hatchback FWD B16A2		Control Arm Bushing	516589
	1992.01-1995.10	Rear Axle Left & Right	Hatchback FWD B16A2		Control Arm Bushing	511113
	1992.01-1995.10	Rear Axle Left & Right Lower	Hatchback FWD B16A2		Control Arm Bushing	514845
	1992.01-1995.10	Rear Axle Left & Right Lower	Hatchback FWD B16A2		Control Arm Bushing	514956
	1992.01-1995.10	Rear Axle Left & Right Lower	Hatchback FWD B16A2		Control Arm Bushing	516141
	1992.01-1995.10	Rear Axle Left & Right Lower	Hatchback FWD B16A2		Control Arm Bushing	530789
	1992.01-1995.10	Rear Axle Left & Right Upper	Hatchback FWD B16A2	Quantity:1	Control Arm Bushing	516576
	1992.01-1995.10	Rear Axle Left & Right Upper	Hatchback FWD B16A2	Quantity:1	Control Arm Bushing	517340
	1992.01-1995.10	Rear Axle Left & Right Lower Inner	Hatchback FWD B16A2		Control Arm Bushing	517592
	1992.01-1995.10	Rear Axle Left & Right Lower	Hatchback FWD B16A2		Control Arm Bushing Kit	516025S
	1992.01-1995.10	Rear Axle Left & Right Upper	Hatchback FWD B16A2		Control Arm Bushing Kit	514909S
	1992.01-1995.10	Front Axle Left & Right	Hatchback FWD B16A2		Tie Rod Axle Joint	S030097
	1992.01-1995.10	Front Axle Left	Hatchback FWD B16A2		Tie Rod End	S070188
	1992.01-1995.10	Front Axle Right	Hatchback FWD B16A2		Tie Rod End	S070189
	1992.01-1995.10	Front Axle Left & Right	Hatchback FWD B16A2		Rod/Strut,stabiliser	517583
	1992.01-1995.10	Front Axle Left & Right	Hatchback FWD B16A2		Rod/Strut,stabiliser	520398
	1992.01-1995.10	Front Axle Left & Right	Hatchback FWD B16A2		Rod/Strut,stabiliser	S050161
	1992.01-1995.10	Front Axle Left & Right	Hatchback FWD B16A2		Rod/Strut,stabiliser	S050162
	1992.01-1995.10	Rear Axle Left & Right	Hatchback FWD B16A2		Rod/Strut,stabiliser	514249
	1992.01-1995.10	Front Axle	Hatchback FWD B16A2		Stabiliser Bushing	516445
	1992.01-1995.10	Front Axle	Hatchback FWD B16A2		Stabiliser Bushing	517543
	1992.01-1995.10	Rear Axle	Hatchback FWD B16A2		Stabiliser Bushing	513238
	1992.01-1995.10	Rear Axle	Hatchback FWD B16A2		Stabiliser Bushing	517667
	1992.01-1995.10	Front Axle	Hatchback FWD B16A2		Steering Boot	540008
	1992.01-1995.10	Front Axle	Hatchback FWD B16A2		Steering Boot	540040
	1992.01-1995.10	Front Axle Left	Hatchback FWD B16A2		Steering Rack Bellow Kit	540012S
	1992.01-1995.10	Front Axle	Hatchback FWD B16A2		Steering Rack Bellow Kit	540211K
	1992.01-1995.10	Front Axle	Hatchback FWD B16A2	with breather valve	Steering Rack Bellow Kit	540217S
	1995.11-2001.02	Front Axle Left Lower	Hatchback FWD B16A2		Track Control Arm	S060492
	1995.11-2001.02	Front Axle Left Upper	Hatchback FWD B16A2		Track Control Arm	S060493
	1995.11-2001.02	Front Axle Right Lower	Hatchback FWD B16A2		Track Control Arm	S060491
	1995.11-2001.02	Front Axle Right Upper	Hatchback FWD B16A2		Track Control Arm	S060494
	1995.11-2001.02	Rear Axle Left Upper	Hatchback FWD B16A2		Track Control Arm	S060495
	1995.11-2001.02	Rear Axle Right Upper	Hatchback FWD B16A2		Track Control Arm	S060496
	1995.11-2001.02	Rear Axle Left & Right Lower Inner	Hatchback FWD B16A2		Track Control Arm	511739



	 YEAR	FITTING POSITION	BODY STYLE & DRIVE TYPE & ENGINE	REMARKS	PRODUCT	GSP Ref.
HONDA Civic						
1.6 (118 kw)	1995.11-2001.02	Rear Axle Left & Right Lower Outer	Hatchback FWD B16A2		Track Control Arm	S061425
	1995.11-2001.02	Front Axle Left & Right Lower	Hatchback FWD B16A2		Ball Joint	S080073
	1995.11-2001.02	Front Axle Left & Right Lower	Hatchback FWD B16A2	Quantity:2	Control Arm Bushing	511117
	1995.11-2001.02	Front Axle Left & Right Lower	Hatchback FWD B16A2		Control Arm Bushing	511117
	1995.11-2001.02	Front Axle Left & Right Lower	Hatchback FWD B16A2	MT,Date from-to:1996.01-2000.12	Control Arm Bushing	516245
	1995.11-2001.02	Front Axle Left & Right Lower	Hatchback FWD B16A2		Control Arm Bushing	516245
	1995.11-2001.02	Front Axle Left & Right Lower	Hatchback FWD B16A2	MT,Date from-to:1996.01-2000.12	Control Arm Bushing	516579
	1995.11-2001.02	Front Axle Left & Right Lower	Hatchback FWD B16A2		Control Arm Bushing	517337
	1995.11-2001.02	Front Axle Left & Right Upper	Hatchback FWD B16A2		Control Arm Bushing	516592
	1995.11-2001.02	Rear Axle Left & Right	Hatchback FWD B16A2		Control Arm Bushing	511113
	1995.11-2001.02	Rear Axle Left & Right Centre	Hatchback FWD B16A2		Control Arm Bushing	517591
	1995.11-2001.02	Rear Axle Left & Right Lower	Hatchback FWD B16A2	For OE no.1.52370S04G80,Quantity:2	Control Arm Bushing	514845
	1995.11-2001.02	Rear Axle Left & Right Lower	Hatchback FWD B16A2	MT,Date from-to:1996.01-2000.12	Control Arm Bushing	516031
	1995.11-2001.02	Rear Axle Left & Right Lower	Hatchback FWD B16A2	for OE No.52370S04G80,Quantity:2	Control Arm Bushing	516031
	1995.11-2001.02	Rear Axle Left & Right Upper	Hatchback FWD B16A2	Quantity:1	Control Arm Bushing	516576
	1995.11-2001.02	Rear Axle Left & Right Upper	Hatchback FWD B16A2		Control Arm Bushing	516576
	1995.11-2001.02	Rear Axle Left & Right Upper	Hatchback FWD B16A2		Control Arm Bushing	532648
	1995.11-2001.02	Rear Axle Left & Right Lower	Hatchback FWD B16A2		Control Arm Bushing Kit	516025S
	1995.11-2001.02	Rear Axle Left & Right Upper	Hatchback FWD B16A2	MT,MT,Date from-to:1996.01-2000.12	Control Arm Bushing Kit	514909S
	1995.11-2001.02	Rear Axle Left & Right Upper	Hatchback FWD B16A2		Control Arm Bushing Kit	514909S
	1995.11-2001.02	Front Axle Left & Right	Hatchback FWD B16A2		Tie Rod Axle Joint	S030478
	1995.11-2001.02	Front Axle Left	Hatchback FWD B16A2		Tie Rod End	S070188
	1995.11-2001.02	Front Axle Right	Hatchback FWD B16A2		Tie Rod End	S070189
	1995.11-2001.02	Front Axle Left & Right	Hatchback FWD B16A2	For OE no.51320S04003	Rod/Strut, stabiliser	S050162
	1995.11-2001.02	Front Axle Left & Right	Hatchback FWD B16A2		Rod/Strut, stabiliser	S050162
	1995.11-2001.02	Rear Axle Left	Hatchback FWD B16A2		Rod/Strut, stabiliser	S050163
	1995.11-2001.02	Rear Axle Right	Hatchback FWD B16A2		Rod/Strut, stabiliser	S050164
	1995.11-2001.02	Front Axle	Hatchback FWD B16A2		Stabiliser Bushing	511720
	1995.11-2001.02	Rear Axle	Hatchback FWD B16A2		Stabiliser Bushing	517667
	1995.11-2001.02	Front Axle	Hatchback FWD B16A2		Steering Boot	540008
	1995.11-2001.02	Front Axle	Hatchback FWD B16A2		Steering Boot	540040
1.7 (85 kw)	2001.03-2006.04	Rear Axle Left & Right Upper	Saloon FWD D17A6/D17Z4		Track Control Arm	S063046
	2001.03-2006.04	Front Axle Left & Right	Saloon FWD D17A6/D17Z4		Tie Rod End	S070190
	2001.03-2006.04	Front Axle Left	Saloon FWD D17A6/D17Z4		Rod/Strut, stabiliser	S050167
	2001.03-2006.04	Front Axle Right	Saloon FWD D17A6/D17Z4		Rod/Strut, stabiliser	S050168
	2001.03-2006.04	Rear Axle Left	Saloon FWD D17A6/D17Z4		Rod/Strut, stabiliser	S050181
	2001.03-2006.04	Rear Axle Right	Saloon FWD D17A6/D17Z4		Rod/Strut, stabiliser	S050182
	2001.03-2006.04	Rear Axle	Saloon FWD D17A6/D17Z4		Stabiliser Bushing	517302
1.7 (96 kw)	2000.12-2006.04	Rear Axle Left & Right Upper	Saloon FWD D17A2/D17A5		Track Control Arm	S063046
	2000.12-2006.04	Rear Axle Left & Right Upper	Saloon FWD D17A2/D17A5	CVT AT,5MT,Date from-to:2001-2002	Control Arm Bushing	516573
	2000.12-2006.04	Rear Axle Left & Right Upper	Saloon FWD D17A2/D17A5		Control Arm Bushing	516573
	2000.12-2006.04	Rear Axle Left & Right Lower	Saloon FWD D17A2/D17A5	CVT AT,5MT	Control Arm Bushing Kit	516411S
	2000.12-2006.04	Rear Axle Left & Right Lower	Saloon FWD D17A2/D17A5		Control Arm Bushing Kit	516411S
1.8 (103 kw)	2005.09-2013.05	Front Axle Left Lower	Saloon FWD R18A1/R18A2		Track Control Arm	S061120
	2005.09-2013.05	Front Axle Right Lower	Saloon FWD R18A1/R18A2		Track Control Arm	S061121
	2005.09-2013.05	Rear Axle Left Upper	Saloon FWD R18A1/R18A2		Track Control Arm	S062974
	2005.09-2013.05	Rear Axle Right Upper	Saloon FWD R18A1/R18A2		Track Control Arm	S062973
	2005.09-2013.05	Front Axle Left Lower	Saloon FWD R18A1/R18A2	Engine code:R18A1	Ball Joint	S080075
	2005.09-2013.05	Front Axle Right Lower	Saloon FWD R18A1/R18A2	Engine code:R18A1	Ball Joint	S080076
	2005.09-2013.05	Front Axle Left & Right Lower	Saloon FWD R18A1/R18A2		Control Arm Bushing	513656
	2005.09-2013.05	Front Axle Left & Right Lower	Saloon FWD R18A1/R18A2		Control Arm Bushing	517365
	2005.09-2013.05	Front Axle Left & Right Lower	Saloon FWD R18A1/R18A2		Control Arm Bushing	530621
	2005.09-2013.05	Rear Axle Left & Right Upper	Saloon FWD R18A1/R18A2	Date from-to:2006.01-2011.12	Control Arm Bushing	516255
	2005.09-2013.05	Rear Axle Left & Right Upper	Saloon FWD R18A1/R18A2	Date from-to:2006.01-2011.12	Control Arm Bushing	516269
	2005.09-2013.05	Rear Axle Left & Right Upper	Saloon FWD R18A1/R18A2		Control Arm Bushing	517231
	2005.09-2013.05	Rear Axle Left & Right Lower Inner	Saloon FWD R18A1/R18A2		Control Arm Bushing Kit	516273S
	2005.09-2013.05	Rear Axle Left & Right Lower Outer	Saloon FWD R18A1/R18A2		Control Arm Bushing Kit	516265S
	2005.09-2013.05	Front Axle Left & Right	Saloon FWD R18A1/R18A2	For vehicles with electric power steering	Tie Rod Axle Joint	S030683
	2005.09-2013.05	Front Axle Left & Right	Saloon FWD R18A1/R18A2	For vehicles with hydraulic power steering	Tie Rod Axle Joint	S030843
	2005.09-2013.05	Front Axle Left	Saloon FWD R18A1/R18A2		Tie Rod End	S070771
	2005.09-2013.05	Front Axle Right	Saloon FWD R18A1/R18A2		Tie Rod End	S070770
	2005.09-2013.05	Front Axle Left	Saloon FWD R18A1/R18A2		Rod/Strut, stabiliser	S050159
	2005.09-2013.05	Front Axle Right	Saloon FWD R18A1/R18A2		Rod/Strut, stabiliser	S050160
	2005.09-2013.05	Front Axle Left & Right	Saloon FWD R18A1/R18A2		Rod/Strut, stabiliser	S050183



	 YEAR	FITTING POSITION	BODY STYLE & DRIVE TYPE & ENGINE	REMARKS	PRODUCT	GSP Ref.
HONDA Civic						
1.8 (103 kw)	2005.09-2013.05	Rear Axle Left	Saloon FWD R18A1/R18A2		Rod/Strut,stabiliser	S050184
	2005.09-2013.05	Rear Axle Right	Saloon FWD R18A1/R18A2		Rod/Strut,stabiliser	S050185
	2005.09-2013.05	Front Axle	Saloon FWD R18A1/R18A2	Engine Code:R18A1	Stabiliser Bushing	512883
	2005.09-2013.05	Rear Axle	Saloon FWD R18A1/R18A2		Stabiliser Bushing	513647
	2005.09-2013.05	Front Axle	Saloon FWD R18A1/R18A2		Steering Rack Bellow Kit	540211K
	2006.11-2013.05	Front Axle Left Lower	Saloon FWD R18A1		Track Control Arm	S061120
	2006.11-2013.05	Front Axle Right Lower	Saloon FWD R18A1		Track Control Arm	S061121
	2006.11-2013.05	Rear Axle Left Upper	Saloon FWD R18A1		Track Control Arm	S062974
	2006.11-2013.05	Rear Axle Right Upper	Saloon FWD R18A1		Track Control Arm	S062973
	2006.11-2013.05	Front Axle Left Lower	Saloon FWD R18A1		Ball Joint	S080075
	2006.11-2013.05	Front Axle Right Lower	Saloon FWD R18A1		Ball Joint	S080076
	2006.11-2013.05	Rear Axle Left & Right Upper	Saloon FWD R18A1	Date to:2011.12	Control Arm Bushing	516255
	2006.11-2013.05	Rear Axle Left & Right Upper	Saloon FWD R18A1	Date to:2011.12	Control Arm Bushing	516269
	2006.11-2013.05	Rear Axle Left & Right Lower Inner	Saloon FWD R18A1		Control Arm Bushing Kit	516273S
	2006.11-2013.05	Front Axle Left & Right	Saloon FWD R18A1		Tie Rod Axle Joint	S030683
	2006.11-2013.05	Front Axle Left	Saloon FWD R18A1		Rod/Strut,stabiliser	S050159
	2006.11-2013.05	Front Axle Right	Saloon FWD R18A1		Rod/Strut,stabiliser	S050160
	2006.11-2013.05	Rear Axle Left	Saloon FWD R18A1		Rod/Strut,stabiliser	S050184
	2006.11-2013.05	Rear Axle Right	Saloon FWD R18A1		Rod/Strut,stabiliser	S050185
Civic Coupe						
1.6 (92 kw)	1996.03-2000.12	Front Axle Left Lower	Coupe FWD D16Y8		Track Control Arm	S060492
	1996.03-2000.12	Front Axle Left Upper	Coupe FWD D16Y8		Track Control Arm	S060493
	1996.03-2000.12	Front Axle Right Lower	Coupe FWD D16Y8		Track Control Arm	S060491
	1996.03-2000.12	Front Axle Right Upper	Coupe FWD D16Y8		Track Control Arm	S060494
	1996.03-2000.12	Rear Axle Left Upper	Coupe FWD D16Y8		Track Control Arm	S060495
	1996.03-2000.12	Rear Axle Right Upper	Coupe FWD D16Y8		Track Control Arm	S060496
	1996.03-2000.12	Rear Axle Left & Right Lower Inner	Coupe FWD D16Y8		Track Control Arm	511739
	1996.03-2000.12	Rear Axle Left & Right Lower Outer	Coupe FWD D16Y8		Track Control Arm	S061425
	1996.03-2000.12	Front Axle Left & Right Lower	Coupe FWD D16Y8		Ball Joint	S080073
	1996.03-2000.12	Front Axle Left & Right Lower	Coupe FWD D16Y8		Control Arm Bushing	517337
	1996.03-2000.12	Front Axle Left & Right Upper	Coupe FWD D16Y8		Control Arm Bushing	516592
	1996.03-2000.12	Rear Axle Left & Right	Coupe FWD D16Y8		Control Arm Bushing	511113
	1996.03-2000.12	Rear Axle Left & Right Centre	Coupe FWD D16Y8		Control Arm Bushing	517591
	1996.03-2000.12	Rear Axle Left & Right Lower	Coupe FWD D16Y8		Control Arm Bushing	516031
	1996.03-2000.12	Rear Axle Left & Right Upper	Coupe FWD D16Y8		Control Arm Bushing	516576
	1996.03-2000.12	Rear Axle Left & Right Lower	Coupe FWD D16Y8		Control Arm Bushing Kit	516025S
	1996.03-2000.12	Rear Axle Left & Right Upper	Coupe FWD D16Y8		Control Arm Bushing Kit	514909S
	1996.03-2000.12	Front Axle Left & Right	Coupe FWD D16Y8		Tie Rod Axle Joint	S030478
	1996.03-2000.12	Front Axle Left	Coupe FWD D16Y8		Tie Rod End	S070188
	1996.03-2000.12	Front Axle Right	Coupe FWD D16Y8		Tie Rod End	S070189
	1996.03-2000.12	Front Axle Left & Right	Coupe FWD D16Y8		Rod/Strut,stabiliser	517583
	1996.03-2000.12	Front Axle Left & Right	Coupe FWD D16Y8		Rod/Strut,stabiliser	520398
	1996.03-2000.12	Front Axle Left & Right	Coupe FWD D16Y8		Rod/Strut,stabiliser	S050161
	1996.03-2000.12	Front Axle Left & Right	Coupe FWD D16Y8		Rod/Strut,stabiliser	S050162
	1996.03-2000.12	Rear Axle Left	Coupe FWD D16Y8		Rod/Strut,stabiliser	S050163
	1996.03-2000.12	Rear Axle Right	Coupe FWD D16Y8		Rod/Strut,stabiliser	S050164
	1996.03-2000.12	Front Axle	Coupe FWD D16Y8		Stabiliser Bushing	512884
	1996.03-2000.12	Front Axle	Coupe FWD D16Y8		Steering Boot	540008
	1996.03-2000.12	Front Axle	Coupe FWD D16Y8		Steering Boot	540040
	1996.03-2000.12	Front Axle	Coupe FWD D16Y8	with breather valve	Steering Rack Bellow Kit	540230S
CR-V						
2.0 (108 kw)	1999.01-2002.02	Front Axle Left Lower	SUV 4WD B20Z1/B20Z3		Track Control Arm	S060505
	1999.01-2002.02	Front Axle Left Upper	SUV 4WD B20Z1/B20Z3		Track Control Arm	S060503
	1999.01-2002.02	Front Axle Right Lower	SUV 4WD B20Z1/B20Z3		Track Control Arm	S060506
	1999.01-2002.02	Front Axle Right Upper	SUV 4WD B20Z1/B20Z3		Track Control Arm	S060504
	1999.01-2002.02	Rear Axle Left Upper	SUV 4WD B20Z1/B20Z3		Track Control Arm	S060495
	1999.01-2002.02	Rear Axle Right Upper	SUV 4WD B20Z1/B20Z3		Track Control Arm	S060496
	1999.01-2002.02	Rear Axle Left & Right Lower Inner	SUV 4WD B20Z1/B20Z3		Track Control Arm	511739
	1999.01-2002.02	Front Axle Left & Right Lower	SUV 4WD B20Z1/B20Z3		Ball Joint	S080073
	1999.01-2002.02	Front Axle Left & Right Lower	SUV 4WD B20Z1/B20Z3		Control Arm Bushing	511117
	1999.01-2002.02	Front Axle Left & Right Lower	SUV 4WD B20Z1/B20Z3	Date to:2001.12	Control Arm Bushing	516245
	1999.01-2002.02	Front Axle Left & Right Lower	SUV 4WD B20Z1/B20Z3	Date to:2001.12	Control Arm Bushing	516579
	1999.01-2002.02	Front Axle Left & Right Upper	SUV 4WD B20Z1/B20Z3	Date to:2001.12	Control Arm Bushing	516583
	1999.01-2002.02	Front Axle Left & Right Upper	SUV 4WD B20Z1/B20Z3		Control Arm Bushing	516592



	 YEAR	FITTING POSITION	BODY STYLE & DRIVE TYPE & ENGINE	REMARKS	PRODUCT	GSP Ref.
HONDA						
CR-V						
2.0 (108 kw)	1999.01-2002.02	Rear Axle Left & Right	SUV 4WD B20Z1/B20Z3		Control Arm Bushing	511113
	1999.01-2002.02	Rear Axle Left & Right Centre	SUV 4WD B20Z1/B20Z3		Control Arm Bushing	517591
	1999.01-2002.02	Rear Axle Left & Right Lower	SUV 4WD B20Z1/B20Z3		Control Arm Bushing	516591
	1999.01-2002.02	Rear Axle Left & Right Upper	SUV 4WD B20Z1/B20Z3		Control Arm Bushing	516576
	1999.01-2002.02	Rear Axle Left & Right Upper	SUV 4WD B20Z1/B20Z3		Control Arm Bushing	532648
	1999.01-2002.02	Rear Axle Left & Right Lower	SUV 4WD B20Z1/B20Z3		Control Arm Bushing Kit	516025S
	1999.01-2002.02	Rear Axle Left & Right Upper	SUV 4WD B20Z1/B20Z3		Control Arm Bushing Kit	514909S
	1999.01-2002.02	Front Axle Left	SUV 4WD B20Z1/B20Z3		Tie Rod End	S070188
	1999.01-2002.02	Front Axle Right	SUV 4WD B20Z1/B20Z3		Tie Rod End	S070189
	1999.01-2002.02	Front Axle Left & Right	SUV 4WD B20Z1/B20Z3		Rod/Strut, stabiliser	S050162
	1999.01-2002.02	Rear Axle Left	SUV 4WD B20Z1/B20Z3		Rod/Strut, stabiliser	S050169
	1999.01-2002.02	Rear Axle Right	SUV 4WD B20Z1/B20Z3		Rod/Strut, stabiliser	S050176
	1999.01-2002.02	Front Axle	SUV 4WD B20Z1/B20Z3		Stabiliser Bushing	511720
	1999.01-2002.02	Rear Axle	SUV 4WD B20Z1/B20Z3		Stabiliser Bushing	517785
	1999.01-2002.02	Front Axle	SUV 4WD B20Z1/B20Z3		Steering Boot	540008
	1999.01-2002.02	Front Axle	SUV 4WD B20Z1/B20Z3		Steering Boot	540009
	1999.01-2002.02	Front Axle	SUV 4WD B20Z1/B20Z3		Steering Boot	540040
	1999.01-2002.02	Front Axle	SUV 4WD B20Z1/B20Z3		Steering Boot	540421
	1999.01-2002.02	Front Axle Right	SUV 4WD B20Z1/B20Z3		Steering Rack Bellow Kit	540449S
	1999.01-2002.02	Front Axle	SUV 4WD B20Z1/B20Z3	For OE no.4820453A00	Steering Rack Bellow Kit	540217S
	1999.01-2002.02	Front Axle	SUV 4WD B20Z1/B20Z3	For OE no.53534SV4003	Steering Rack Bellow Kit	540230S
2.0 (110 kw)	2001.09-2007.03	Front Axle Left Lower	SUV 4WD K20A4		Track Control Arm	S060508
	2001.09-2007.03	Front Axle Right Lower	SUV 4WD K20A4		Track Control Arm	S060509
	2001.09-2007.03	Front Axle Left & Right Lower	SUV 4WD K20A4		Ball Joint	S080474
	2001.09-2007.03	Front Axle Left & Right Lower	SUV 4WD K20A4		Ball Joint	S080703
	2001.09-2007.03	Front Axle Left & Right Lower	SUV 4WD K20A4		Control Arm Bushing	511727
	2001.09-2007.03	Front Axle Left & Right Lower	SUV 4WD K20A4		Control Arm Bushing	511728
	2001.09-2007.03	Rear Axle Left & Right Lower	SUV 4WD K20A4		Control Arm Bushing	511725
	2001.09-2007.03	Rear Axle Left & Right Upper	SUV 4WD K20A4		Control Arm Bushing	511726
	2001.09-2007.03	Rear Axle Left & Right Lower	SUV 4WD K20A4		Control Arm Bushing Kit	516411S
	2001.09-2007.03	Front Axle Left & Right	SUV 4WD K20A4		Tie Rod Axle Joint	S030110
	2001.09-2007.03	Front Axle Left & Right	SUV 4WD K20A4		Tie Rod End	S070190
	2001.09-2007.03	Front Axle Left & Right	SUV 4WD K20A4		Tie Rod End	S070824
	2001.09-2007.03	Front Axle Left & Right	SUV 4WD K20A4		Tie Rod End	S070866
	2001.09-2007.03	Front Axle Left	SUV 4WD K20A4		Rod/Strut, stabiliser	S050167
	2001.09-2007.03	Front Axle Right	SUV 4WD K20A4		Rod/Strut, stabiliser	S050168
	2001.09-2007.03	Rear Axle Left	SUV 4WD K20A4		Rod/Strut, stabiliser	S050177
	2001.09-2007.03	Rear Axle Right	SUV 4WD K20A4		Rod/Strut, stabiliser	S050178
	2001.09-2007.03	Front Axle	SUV 4WD K20A4		Stabiliser Bushing	512887
	2001.09-2007.03	Rear Axle	SUV 4WD K20A4		Stabiliser Bushing	512886
	2001.09-2007.03	Rear Axle	SUV 4WD K20A4		Stabiliser Bushing	517832
	2001.09-2007.03	Front Axle	SUV 4WD K20A4		Steering Boot	540421
	2001.09-2007.03	Front Axle Right	SUV 4WD K20A4		Steering Rack Bellow Kit	540449S
	2001.09-2007.03	Front Axle	SUV 4WD K20A4	SAT Date from:2002 Date to:2004 AAT Date from:to:2003-2006	Steering Rack Bellow Kit	540211K
	2006.10-2012.06	Front Axle Left Lower	SUV 4WD R20A2		Track Control Arm	S060512
	2006.10-2012.06	Front Axle Right Lower	SUV 4WD R20A2		Track Control Arm	S060513
	2006.10-2012.06	Front Axle Left & Right Lower	SUV 4WD R20A2		Ball Joint	S080465
	2006.10-2012.06	Front Axle Left Lower	SUV 4WD R20A2		Control Arm Bushing	532436
	2006.10-2012.06	Front Axle Right Lower	SUV 4WD R20A2		Control Arm Bushing	532435
	2006.10-2012.06	Front Axle Left & Right Lower	SUV 4WD R20A2	Date to:2000.12	Control Arm Bushing	516438
	2006.10-2012.06	Front Axle Left & Right Lower	SUV 4WD R20A2	Date to:2011.12	Control Arm Bushing	516439
	2006.10-2012.06	Front Axle Left & Right Lower	SUV 4WD R20A2		Control Arm Bushing	530731
	2006.10-2012.06	Front Axle Left & Right Lower	SUV 4WD R20A2		Control Arm Bushing	532412
	2006.10-2012.06	Rear Axle Left & Right Upper	SUV 4WD R20A2		Control Arm Bushing	511726
	2006.10-2012.06	Rear Axle Left & Right Upper	SUV 4WD R20A2		Control Arm Bushing Kit	516464S
	2006.10-2012.06	Front Axle Left & Right	SUV 4WD R20A2		Tie Rod Axle Joint	S030372
	2006.10-2012.06	Front Axle Left & Right	SUV 4WD R20A2		Tie Rod End	S070772
	2006.10-2012.06	Front Axle Left & Right	SUV 4WD R20A2		Rod/Strut, stabiliser	S050186
	2006.10-2012.06	Rear Axle Left	SUV 4WD R20A2		Rod/Strut, stabiliser	S050187
	2006.10-2012.06	Rear Axle Right	SUV 4WD R20A2		Rod/Strut, stabiliser	S050188
	2006.10-2012.06	Front Axle	SUV 4WD R20A2		Stabiliser Bushing	513242
	2006.10-2012.06	Rear Axle	SUV 4WD R20A2		Stabiliser Bushing	513646
	2007.01-2012.06	Front Axle Left & Right Lower	SUV FWD R20A2		Ball Joint	S080465
	2007.01-2012.06	Front Axle Left Lower	SUV FWD R20A2		Control Arm Bushing	532436



	 YEAR	FITTING POSITION	BODY STYLE & DRIVE TYPE & ENGINE	REMARKS	PRODUCT	GSP Ref.	
HONDA							
CR-V							
2.0 (110 kw)	2007.01-2012.06	Front Axle Right Lower	SUV FWD R20A2		Control Arm Bushing	532435	
	2007.01-2012.06	Front Axle Left & Right Lower	SUV FWD R20A2	Date to:2000.12	Control Arm Bushing	516438	
	2007.01-2012.06	Front Axle Left & Right Lower	SUV FWD R20A2	Date to:2011.12	Control Arm Bushing	516439	
	2007.01-2012.06	Rear Axle Left & Right Upper	SUV FWD R20A2		Control Arm Bushing	511726	
	2007.01-2012.06	Rear Axle Left & Right Upper	SUV FWD R20A2		Control Arm Bushing Kit	516464S	
	2007.01-2012.06	Front Axle Left & Right	SUV FWD R20A2		Tie Rod Axle Joint	S030372	
	2007.01-2012.06	Front Axle Left & Right	SUV FWD R20A2		Tie Rod Axle	S070772	
	2007.01-2012.06	Front Axle Left & Right	SUV FWD R20A2		Rod/Strut,stabiliser	S050186	
	2007.01-2012.06	Rear Axle Left	SUV FWD R20A2		Rod/Strut,stabiliser	S050187	
	2007.01-2012.06	Rear Axle Right	SUV FWD R20A2		Rod/Strut,stabiliser	S050188	
	2007.01-2012.06	Front Axle	SUV FWD R20A2		Stabiliser Bushing	513242	
2.0 (114 kw)	2012.10-	Front Axle Left Lower	SUV 4WD R20A9		Track Control Arm	S062979	
	2012.10-	Front Axle Left Lower	SUV FWD R20A9		Track Control Arm	S062979	
	2012.10-	Front Axle Right Lower	SUV 4WD R20A9		Track Control Arm	S062980	
	2012.10-	Front Axle Right Lower	SUV FWD R20A9		Track Control Arm	S062980	
	2012.10-	Front Axle Left & Right Lower	SUV 4WD R20A9		Ball Joint	S080465	
	2012.10-	Front Axle Left & Right Lower	SUV FWD R20A9		Ball Joint	S080465	
	2012.10-	Front Axle Left Lower	SUV 4WD R20A9		Control Arm Bushing	535219	
	2012.10-	Front Axle Left Lower	SUV FWD R20A9		Control Arm Bushing	535219	
	2012.10-	Front Axle Right Lower	SUV 4WD R20A9		Control Arm Bushing	535221	
	2012.10-	Front Axle Right Lower	SUV FWD R20A9		Control Arm Bushing	535221	
	2012.10-	Rear Axle Left & Right Upper	SUV 4WD R20A9		Control Arm Bushing	511726	
	2012.10-	Rear Axle Left & Right Upper	SUV FWD R20A9		Control Arm Bushing	511726	
	2012.10-	Front Axle Left & Right	SUV 4WD R20A9		Tie Rod Axle Joint	S030602	
	2012.10-	Front Axle Left & Right	SUV FWD R20A9		Tie Rod Axle Joint	S030602	
	2012.10-	Front Axle Left	SUV 4WD R20A9		Tie Rod End	S071283	
	2012.10-	Front Axle Left	SUV FWD R20A9		Tie Rod End	S071283	
	2012.10-	Front Axle Right	SUV 4WD R20A9		Tie Rod End	S071284	
	2012.10-	Front Axle Right	SUV FWD R20A9		Tie Rod End	S071284	
	2012.10-	Front Axle Left & Right	SUV 4WD R20A9		Rod/Strut,stabiliser	S050186	
	2012.10-	Front Axle Left & Right	SUV FWD R20A9		Rod/Strut,stabiliser	S050186	
	2012.10-	Rear Axle Left	SUV 4WD R20A9		Rod/Strut,stabiliser	S050187	
	2012.10-	Rear Axle Left	SUV FWD R20A9		Rod/Strut,stabiliser	S050187	
	2012.10-	Rear Axle Right	SUV 4WD R20A9		Rod/Strut,stabiliser	S050188	
	2012.10-	Rear Axle Right	SUV FWD R20A9		Rod/Strut,stabiliser	S050188	
	2013.01-	Front Axle Left Lower	SUV FWD R20A1		Control Arm Bushing	535219	
	2013.01-	Front Axle Right Lower	SUV FWD R20A1		Control Arm Bushing	535221	
	CRX						
	1.6 (118 kw)	1992.06-1998.04	Front Axle Left Lower	Targa FWD B16A2		Track Control Arm	S060515
		1992.06-1998.04	Front Axle Left Upper	Targa FWD B16A2		Track Control Arm	S060481
1992.06-1998.04		Front Axle Right Lower	Targa FWD B16A2		Track Control Arm	S060514	
1992.06-1998.04		Front Axle Right Upper	Targa FWD B16A2		Track Control Arm	S060482	
1992.06-1998.04		Rear Axle Left Upper	Targa FWD B16A2		Track Control Arm	S060495	
1992.06-1998.04		Rear Axle Right Upper	Targa FWD B16A2		Track Control Arm	S060496	
1992.06-1998.04		Front Axle Left & Right Lower	Targa FWD B16A2		Control Arm Bushing	511111	
1992.06-1998.04		Front Axle Left & Right Lower	Targa FWD B16A2		Control Arm Bushing	511118	
1992.06-1998.04		Front Axle Left & Right Upper	Targa FWD B16A2		Control Arm Bushing	516589	
1992.06-1998.04		Rear Axle Left & Right	Targa FWD B16A2		Control Arm Bushing	511113	
1992.06-1998.04		Rear Axle Left & Right Lower	Targa FWD B16A2		Control Arm Bushing	514845	
1992.06-1998.04		Rear Axle Left & Right Lower	Targa FWD B16A2		Control Arm Bushing	514956	
1992.06-1998.04		Rear Axle Left & Right Lower	Targa FWD B16A2		Control Arm Bushing	516141	
1992.06-1998.04		Rear Axle Left & Right Lower	Targa FWD B16A2		Control Arm Bushing	530789	
1992.06-1998.04		Rear Axle Left & Right Upper	Targa FWD B16A2		Control Arm Bushing	516576	
1992.06-1998.04		Rear Axle Left & Right Lower Inner	Targa FWD B16A2		Control Arm Bushing	517592	
1992.06-1998.04		Rear Axle Left & Right Lower	Targa FWD B16A2		Control Arm Bushing Kit	516025S	
1992.06-1998.04		Rear Axle Left & Right Upper	Targa FWD B16A2		Control Arm Bushing Kit	514909S	
1992.06-1998.04		Front Axle Left & Right	Targa FWD B16A2		Tie Rod Axle Joint	S030097	
1992.06-1998.04		Front Axle Left	Targa FWD B16A2		Tie Rod End	S070188	
1992.06-1998.04		Front Axle Right	Targa FWD B16A2		Tie Rod End	S070189	
1992.06-1998.04		Front Axle Left & Right	Targa FWD B16A2		Rod/Strut,stabiliser	517583	
1992.06-1998.04		Front Axle Left & Right	Targa FWD B16A2		Rod/Strut,stabiliser	520398	
1992.06-1998.04		Front Axle Left & Right	Targa FWD B16A2		Rod/Strut,stabiliser	S050161	
1992.06-1998.04		Rear Axle Left & Right	Targa FWD B16A2		Rod/Strut,stabiliser	514249	
1992.06-1998.04		Front Axle	Targa FWD B16A2		Stabiliser Bushing	516445	



	 YEAR	FITTING POSITION	BODY STYLE & DRIVE TYPE & ENGINE	REMARKS	PRODUCT	GSP Ref.
HONDA						
CRX						
1.6 (118 kw)	1992.06-1998.04	Front Axle	Targa FWD B16A2		Stabiliser Bushing	517543
	1992.06-1998.04	Rear Axle	Targa FWD B16A2		Stabiliser Bushing	513238
	1992.06-1998.04	Rear Axle	Targa FWD B16A2		Stabiliser Bushing	513239
	1992.06-1998.04	Front Axle	Targa FWD B16A2		Steering Boot	540008
	1992.06-1998.04	Front Axle	Targa FWD B16A2		Steering Boot	540040
Fit						
1.3 (59 kw)	2003.04-2008.10	Front Axle Left & Right Lower	Hatchback FWD L13A1	ball joint swing angle≥38°	Ball Joint	S080078
	2003.04-2008.10	Front Axle Left & Right Lower	Hatchback FWD L13A1		Control Arm Bushing	516248
	2003.04-2008.10	Front Axle Left & Right Lower	Hatchback FWD L13A1		Control Arm Bushing	516249
	2003.04-2008.10	Front Axle Left & Right Lower	Hatchback FWD L13A1		Control Arm Bushing	516604
	2003.04-2008.10	Front Axle Left	Hatchback FWD L13A1		Tie Rod Axle Joint	S030480
	2003.04-2008.10	Front Axle Right	Hatchback FWD L13A1		Tie Rod Axle Joint	S030481
1.4 (59 kw)	2007.10-2012.12	Front Axle Left & Right Lower	Hatchback FWD L13A3	for right-hand drive vehicles	Ball Joint	S063543
	2007.10-2012.12	Front Axle	Hatchback FWD L13A3		Steering Bushing	535505
1.5 (77 kw)	2005.02-2008.10	Front Axle Left & Right Lower	Hatchback FWD L15A/L15A1	Date from-to:2005-2007	Ball Joint	S063543
	2005.02-2008.10	Front Axle	Hatchback FWD L15A/L15A1		Steering Bushing	535505
1.5 (85 kw)	2014.04-	Front Axle Left	Hatchback FWD L15Z3		Tie Rod End	S071771
	2014.04-	Front Axle Right	Hatchback FWD L15Z3		Tie Rod End	S071772
Odyssey						
2.2 (104 kw)	1994.10-1997.12	Front Axle Left	MPV FWD F22B6		Tie Rod End	S070206
	1994.10-1997.12	Front Axle Right	MPV FWD F22B6		Tie Rod End	S070207
Prelude						
2.3 (118 kw)	1991.10-1996.09	Front Axle Left Upper	Coupe FWD H23A2		Track Control Arm	S061124
	1991.10-1996.09	Front Axle Right Upper	Coupe FWD H23A2		Track Control Arm	S061125
	1991.10-1996.09	Front Axle Left & Right Lower	Coupe FWD H23A2		Ball Joint	S080074
	1991.10-1996.09	Front Axle Left & Right Lower	Coupe FWD H23A2		Control Arm Bushing	513255
	1991.10-1996.09	Front Axle Left & Right Lower	Coupe FWD H23A2		Control Arm Bushing	516587
	1991.10-1996.09	Front Axle Left	Coupe FWD H23A2		Tie Rod End	S070196
	1991.10-1996.09	Front Axle Right	Coupe FWD H23A2		Tie Rod End	S070197
	1991.10-1996.09	Front Axle Left & Right	Coupe FWD H23A2		Rod/Strut,stabiliser	S050753
	1991.10-1996.09	Rear Axle Left & Right	Coupe FWD H23A2		Rod/Strut,stabiliser	S050724
	1991.10-1996.09	Front Axle	Coupe FWD H23A2		Stabiliser Bushing	512889
	1991.10-1996.09	Front Axle	Coupe FWD H23A2		Steering Boot	540156
	1991.10-1996.09	Front Axle	Coupe FWD H23A2		Steering Rack Bellow Kit	540217S
	1991.10-1996.09	-	Coupe FWD H23A2		Steering Bushing	517549
HUMMER						
H3						
3.5 (162 kw)	2005.04-2010.12	Front Axle Left & Right	Terrain cab wagon closed 4WD L52		Rod/Strut,stabiliser	S051047
3.7 (180 kw)	2006.09-2010.08	Front Axle Left & Right	Terrain cab wagon closed 4WD LLR		Rod/Strut,stabiliser	S051047
5.3 (224 kw)	2008.01-2010.12	Front Axle Left & Right	Terrain cab wagon closed 4WD LH8(325CUV8)		Rod/Strut,stabiliser	S051047
HYUNDAI						
Amica						
1.0 (40 kw)	1999.09-2000.08	Front Axle Left Lower	Hatchback FWD G4HC		Track Control Arm	S060520
	1999.09-2000.08	Front Axle Right Lower	Hatchback FWD G4HC		Track Control Arm	S060521
	1999.09-2000.08	Front Axle Left & Right Lower	Hatchback FWD G4HC		Ball Joint	S080086
	1999.09-2000.08	Front Axle Left Lower	Hatchback FWD G4HC		Control Arm Bushing	511527
	1999.09-2000.08	Front Axle Right Lower	Hatchback FWD G4HC		Control Arm Bushing	511528
	1999.09-2000.08	Front Axle Left & Right Lower	Hatchback FWD G4HC		Control Arm Bushing	510948
	1999.09-2000.08	Front Axle Left & Right	Hatchback FWD G4HC		Tie Rod Axle Joint	S030111
	1999.09-2000.08	Front Axle Left & Right	Hatchback FWD G4HC		Tie Rod End	S070211
	1999.09-2000.08	Front Axle Left & Right	Hatchback FWD G4HC		Tie Rod End	S070321
	1999.09-2000.08	Front Axle Left & Right	Hatchback FWD G4HC		Tie Rod End	S070695
	1999.09-2000.08	Front Axle Left & Right	Hatchback FWD G4HC		Rod/Strut,stabiliser	S050497
	1999.09-2000.08	Front Axle	Hatchback FWD G4HC		Steering Boot	540101
	Atos					
1.0 (40 kw)	1998.02-2002.03	Front Axle Left Lower	Hatchback FWD G4HC		Track Control Arm	S060520
	1998.02-2002.03	Front Axle Right Lower	Hatchback FWD G4HC		Track Control Arm	S060521
	1998.02-2002.03	Front Axle Left & Right Lower	Hatchback FWD G4HC		Ball Joint	S080086
	1998.02-2002.03	Front Axle Left Lower	Hatchback FWD G4HC		Control Arm Bushing	511527
	1998.02-2002.03	Front Axle Right Lower	Hatchback FWD G4HC		Control Arm Bushing	511528
	1998.02-2002.03	Front Axle Left & Right Lower	Hatchback FWD G4HC		Control Arm Bushing	510948
	1998.02-2002.03	Front Axle Left & Right	Hatchback FWD G4HC		Tie Rod Axle Joint	S030111
	1998.02-2002.03	Front Axle Left & Right	Hatchback FWD G4HC		Tie Rod End	S070211
	1998.02-2002.03	Front Axle Left & Right	Hatchback FWD G4HC		Tie Rod End	S070321
	1998.02-2002.03	Front Axle Left & Right	Hatchback FWD G4HC		Tie Rod End	S070321



	 YEAR	FITTING POSITION	BODY STYLE & DRIVE TYPE & ENGINE	REMARKS	PRODUCT	GSP Ref.
HYUNDAI						
Atos						
1.0 (40 kw)	1998.02-2002.03	Front Axle Left & Right	Hatchback FWD G4HC		Tie Rod End	S070695
	1998.02-2002.03	Front Axle Left & Right	Hatchback FWD G4HC		Rod/Strut, stabiliser	S050497
	1998.02-2002.03	Front Axle	Hatchback FWD G4HC		Steering Boot	540101
1.0 (43 kw)	2001.03-2003.07	Front Axle Left Lower	Hatchback FWD G4HC		Track Control Arm	S060520
	2001.03-2003.07	Front Axle Right Lower	Hatchback FWD G4HC		Track Control Arm	S060521
	2001.03-2003.07	Front Axle Left & Right Lower	Hatchback FWD G4HC		Ball Joint	S080086
	2001.03-2003.07	Front Axle Left Lower	Hatchback FWD G4HC		Control Arm Bushing	511527
	2001.03-2003.07	Front Axle Right Lower	Hatchback FWD G4HC		Control Arm Bushing	511528
	2001.03-2003.07	Front Axle Left & Right Lower	Hatchback FWD G4HC		Control Arm Bushing	510948
	2001.03-2003.07	Front Axle Left & Right	Hatchback FWD G4HC		Tie Rod Axle Joint	S030111
	2001.03-2003.07	Front Axle Left & Right	Hatchback FWD G4HC		Tie Rod End	S070211
	2001.03-2003.07	Front Axle Left & Right	Hatchback FWD G4HC		Tie Rod End	S070321
	2001.03-2003.07	Front Axle Left & Right	Hatchback FWD G4HC		Tie Rod End	S070695
	2001.03-2003.07	Front Axle Left & Right	Hatchback FWD G4HC		Rod/Strut, stabiliser	S050497
	2001.03-2003.07	Front Axle	Hatchback FWD G4HC		Steering Boot	540101
Atos Prime						
1.0 (40 kw)	1999.09-2002.07	Front Axle Left Lower	Hatchback FWD G4HC		Track Control Arm	S060520
	1999.09-2002.07	Front Axle Right Lower	Hatchback FWD G4HC		Track Control Arm	S060521
	1999.09-2002.07	Front Axle Left & Right Lower	Hatchback FWD G4HC		Ball Joint	S080086
	1999.09-2002.07	Front Axle Left Lower	Hatchback FWD G4HC		Control Arm Bushing	511527
	1999.09-2002.07	Front Axle Right Lower	Hatchback FWD G4HC		Control Arm Bushing	511528
	1999.09-2002.07	Front Axle Left & Right Lower	Hatchback FWD G4HC		Control Arm Bushing	510948
	1999.09-2002.07	Front Axle Left & Right	Hatchback FWD G4HC		Tie Rod Axle Joint	S030111
	1999.09-2002.07	Front Axle Left & Right	Hatchback FWD G4HC		Tie Rod End	S070211
	1999.09-2002.07	Front Axle Left & Right	Hatchback FWD G4HC		Tie Rod End	S070321
	1999.09-2002.07	Front Axle Left & Right	Hatchback FWD G4HC		Tie Rod End	S070695
	1999.09-2002.07	Front Axle Left & Right	Hatchback FWD G4HC		Rod/Strut, stabiliser	S050497
	1999.09-2002.07	Front Axle	Hatchback FWD G4HC		Steering Boot	540101
1.0 (43 kw)	2001.03-2003.12	Front Axle Left Lower	Hatchback FWD G4HC		Track Control Arm	S060520
	2001.03-2003.12	Front Axle Right Lower	Hatchback FWD G4HC		Track Control Arm	S060521
	2001.03-2003.12	Front Axle Left & Right Lower	Hatchback FWD G4HC		Ball Joint	S080086
	2001.03-2003.12	Front Axle Left Lower	Hatchback FWD G4HC		Control Arm Bushing	511527
	2001.03-2003.12	Front Axle Right Lower	Hatchback FWD G4HC		Control Arm Bushing	511528
	2001.03-2003.12	Front Axle Left & Right Lower	Hatchback FWD G4HC		Control Arm Bushing	510948
	2001.03-2003.12	Front Axle Left & Right	Hatchback FWD G4HC		Tie Rod Axle Joint	S030111
	2001.03-2003.12	Front Axle Left & Right	Hatchback FWD G4HC		Tie Rod End	S070211
	2001.03-2003.12	Front Axle Left & Right	Hatchback FWD G4HC		Tie Rod End	S070321
	2001.03-2003.12	Front Axle Left & Right	Hatchback FWD G4HC		Tie Rod End	S070695
	2001.03-2003.12	Front Axle Left & Right	Hatchback FWD G4HC		Rod/Strut, stabiliser	S050497
	2001.03-2003.12	Front Axle	Hatchback FWD G4HC		Steering Boot	540101
Azera						
3.0 (184 kw)	2011.03-	Rear Axle Left & Right Upper Inner	Saloon FWD G6DE		Track Control Arm	S063091
	2011.03-	Front Axle Left & Right Lower	Saloon FWD G6DE		Control Arm Bushing	535472
	2011.03-	Rear Axle Left & Right Upper	Saloon FWD G6DE		Control Arm Bushing	535465
	2011.03-	Rear Axle Left & Right Lower Inner	Saloon FWD G6DE		Control Arm Bushing	514904
	2011.03-	Rear Axle Left & Right Lower Outer	Saloon FWD G6DE		Control Arm Bushing	516361
	2011.03-	Front Axle Left & Right	Saloon FWD G6DE		Tie Rod Axle Joint	S030578
	2011.03-	Front Axle Left	Saloon FWD G6DE		Tie Rod End	S070766
	2011.03-	Front Axle Right	Saloon FWD G6DE		Tie Rod End	S070767
	2011.03-	Front Axle Left	Saloon FWD G6DE		Rod/Strut, stabiliser	S051320
	2011.03-	Front Axle Right	Saloon FWD G6DE		Rod/Strut, stabiliser	S051324
	2011.03-	Front Axle Left & Right	Saloon FWD G6DE	AT, Date from: 2012.04	Rod/Strut, stabiliser	S050592
	Coupe					
2.0 (101 kw)	1996.05-2002.04	Front Axle Left & Right Lower	Coupe FWD G4DF		Control Arm Bushing	530602
	1996.05-2002.04	Front Axle Left & Right	Coupe FWD G4DF		Tie Rod Axle Joint	S030116
	1996.05-2002.04	Front Axle Left & Right	Coupe FWD G4DF		Tie Rod End	S070209
	1996.05-2002.04	Front Axle Left & Right	Coupe FWD G4DF		Rod/Strut, stabiliser	S050192
	1996.05-2002.04	Rear Axle Left & Right	Coupe FWD G4DF		Rod/Strut, stabiliser	S050224
Creta						
1.6 (96 kw)	2017.01-2021.01	Front Axle Left	SUV FWD F4FA		Tie Rod End	S071817
	2017.01-2021.01	Front Axle Right	SUV FWD F4FA		Tie Rod End	S071818
Elantra						
1.6 (84 kw)	1990.12-1995.05	Front Axle Left & Right Lower	Saloon FWD G4CR		Ball Joint	S080082
	1990.12-1995.05	Front Axle Left & Right Lower	Saloon FWD G4CR		Control Arm Bushing	510956



	 YEAR	FITTING POSITION	BODY STYLE & DRIVE TYPE & ENGINE	REMARKS	PRODUCT	GSP Ref.	
HYUNDAI							
Elantra							
1.6 (84 kw)	1990.12-1995.05	Front Axle Left & Right	Saloon FWD G4CR	Date from:1993.06	Tie Rod Axle Joint	S030112	
	1990.12-1995.05	Front Axle Left & Right	Saloon FWD G4CR	Date from-to:1992.05-1993.05	Tie Rod Axle Joint	S030620	
	1990.12-1995.05	Front Axle Left & Right	Saloon FWD G4CR	Date to:1992.03	Tie Rod Axle Joint	S070213	
	1990.12-1995.05	Front Axle Left & Right	Saloon FWD G4CR	Date from:1992.05	Tie Rod End	S070209	
	1990.12-1995.05	Front Axle Left & Right	Saloon FWD G4CR	for vehicles with power steering,Date to:1992.04	Tie Rod End	S070321	
	1990.12-1995.05	Front Axle Left & Right	Saloon FWD G4CR		Tie Rod End	S070695	
	1990.12-1995.05	Front Axle Left & Right	Saloon FWD G4CR		Rod/Strut,stabiliser	S050225	
	1990.12-1995.05	Front Axle	Saloon FWD G4CR		Steering Boot	540101	
1990.12-1995.05	Front Axle	Saloon FWD G4CR	Date from-to:1992.04-1995.07	Steering Rack Bellow Kit	540235S		
1.8 (110 kw)	2011.01-2016.12	Front Axle Left Lower	Saloon FWD G4NB		Track Control Arm	S061257	
	2011.01-2016.12	Front Axle Right Lower	Saloon FWD G4NB		Track Control Arm	S061258	
	2011.01-2016.12	Front Axle Left & Right Lower	Saloon FWD G4NB		Control Arm Bushing	530529	
	2011.01-2016.12	Front Axle Left & Right Lower	Saloon FWD G4NB		Control Arm Bushing	533876	
	2011.01-2016.12	Front Axle Left & Right	Saloon FWD G4NB		Tie Rod Axle Joint	S030514	
	2011.01-2016.12	Front Axle Left	Saloon FWD G4NB		Tie Rod End	S070937	
	2011.01-2016.12	Front Axle Right	Saloon FWD G4NB		Tie Rod End	S070938	
	2011.01-2016.12	Front Axle Left & Right	Saloon FWD G4NB		Rod/Strut,stabiliser	S050622	
2.0 (105 kw)	2000.06-2006.08	Front Axle Left Lower	Hatchback FWD G4GC		Track Control Arm	S060526	
	2000.06-2006.08	Front Axle Right Lower	Hatchback FWD G4GC		Track Control Arm	S060527	
	2000.06-2006.08	Rear Axle Left & Right Lower Inner	Hatchback FWD G4GC		Track Control Arm	S062191	
	2000.06-2006.08	Front Axle Left & Right Lower	Hatchback FWD G4GC		Ball Joint	S080098	
	2000.06-2006.08	Front Axle Left & Right Lower	Hatchback FWD G4GC		Control Arm Bushing	510964	
	2000.06-2006.08	Front Axle Left & Right Lower	Hatchback FWD G4GC		Control Arm Bushing	514291	
	2000.06-2006.08	Front Axle Left & Right Lower	Hatchback FWD G4GC		Control Arm Bushing	514847	
	2000.06-2006.08	Rear Axle Left & Right Centre	Hatchback FWD G4GC		Control Arm Bushing	516373	
	2000.06-2006.08	Rear Axle Left & Right Upper	Hatchback FWD G4GC		Control Arm Bushing	516030	
	2000.06-2006.08	Rear Axle Left & Right Lower Inner	Hatchback FWD G4GC		Control Arm Bushing	514904	
	2000.06-2006.08	Front Axle Left & Right	Hatchback FWD G4GC		Tie Rod Axle Joint	S030123	
	2000.06-2006.08	Front Axle Left & Right	Hatchback FWD G4GC		Tie Rod End	S070209	
	2000.06-2006.08	Front Axle Left & Right	Hatchback FWD G4GC		Rod/Strut,stabiliser	S050203	
	2000.06-2006.08	Rear Axle Left & Right	Hatchback FWD G4GC		Rod/Strut,stabiliser	S050224	
	2000.06-2006.08	Front Axle	Hatchback FWD G4GC		Stabiliser Bushing	513681	
	2000.06-2006.08	Rear Axle	Hatchback FWD G4GC		Stabiliser Bushing	513682	
	2000.06-2006.08	Front Axle	Hatchback FWD G4GC		Steering Boot	540326	
	2000.06-2006.08	Front Axle	Hatchback FWD G4GC	For OE No.577402D000	Steering Rack Bellow Kit	540326S	
	2003.08-2006.09	Front Axle Left Lower	Saloon FWD G4GC		Track Control Arm	S060526	
	2003.08-2006.09	Front Axle Right Lower	Saloon FWD G4GC		Track Control Arm	S060527	
	2003.08-2006.09	Rear Axle Left & Right Lower Inner	Saloon FWD G4GC		Track Control Arm	S062191	
	2003.08-2006.09	Front Axle Left & Right Lower	Saloon FWD G4GC		Ball Joint	S080098	
	2003.08-2006.09	Front Axle Left & Right Lower	Saloon FWD G4GC		Control Arm Bushing	510964	
	2003.08-2006.09	Front Axle Left & Right Lower	Saloon FWD G4GC		Control Arm Bushing	514291	
	2003.08-2006.09	Rear Axle Left & Right Centre	Saloon FWD G4GC		Control Arm Bushing	516373	
	2003.08-2006.09	Rear Axle Left & Right Upper	Saloon FWD G4GC		Control Arm Bushing	516030	
	2003.08-2006.09	Rear Axle Left & Right Lower Inner	Saloon FWD G4GC		Control Arm Bushing	514904	
	2003.08-2006.09	Front Axle Left & Right	Saloon FWD G4GC		Tie Rod Axle Joint	S030123	
	2003.08-2006.09	Front Axle Left & Right	Saloon FWD G4GC		Tie Rod End	S070209	
	2003.08-2006.09	Front Axle Left & Right	Saloon FWD G4GC		Rod/Strut,stabiliser	S050203	
	2003.08-2006.09	Rear Axle Left & Right	Saloon FWD G4GC		Rod/Strut,stabiliser	S050224	
	2003.08-2006.09	Rear Axle	Saloon FWD G4GC		Stabiliser Bushing	513682	
	2003.08-2006.09	Front Axle	Saloon FWD G4GC		Steering Boot	540326	
	2003.08-2006.09	Front Axle	Saloon FWD G4GC	For OE No.577402D000	Steering Rack Bellow Kit	540326S	
	Equus						
	4.6 (269 kw)	2009.03-	Front Axle	Saloon RWD G8BA	Date from:2011.07,Date to:2013.05	Stabiliser Bushing	517821
		2009.03-	Rear Axle	Saloon RWD G8BA		Stabiliser Bushing	535176
	Excel						
	1.5 (62 kw)	1989.04-1994.08	Front Axle Left Lower	Saloon FWD G4DJ		Track Control Arm	S061954
		1989.04-1994.08	Front Axle Right Lower	Saloon FWD G4DJ		Track Control Arm	S061955
1989.04-1994.08		Front Axle Left & Right Lower	Saloon FWD G4DJ		Ball Joint	S080082	
1989.04-1994.08		Front Axle Left & Right	Saloon FWD G4DJ	for vehicles with power steering	Tie Rod Axle Joint	S030117	
1989.04-1994.08		Front Axle Left & Right	Saloon FWD G4DJ	for vehicles with power steering	Tie Rod Axle Joint	S070213	
1989.04-1994.08		Front Axle Right	Saloon FWD G4DJ		Tie Rod End	S071686	
1989.04-1994.08		Front Axle Left & Right	Saloon FWD G4DJ		Tie Rod End	S070230	
1989.04-1994.08		Front Axle	Saloon FWD G4DJ		Steering Boot	540101	



	 YEAR	FITTING POSITION	BODY STYLE & DRIVE TYPE & ENGINE	REMARKS	PRODUCT	GSP Ref.
HYUNDAI Galloper						
2.5 (65 kw)	1997.11-2003.06	Front Axle Left & Right Upper	Terrain cab wagon closed 4WD D4BA		Ball Joint	S080398
	1997.11-2003.06	Front Axle Left & Right Upper	Terrain cab wagon closed 4WD D4BA		Ball Joint	S080510
	1997.11-2003.06	Front Axle Left & Right Lower	Terrain cab wagon closed 4WD D4BA		Control Arm Bushing	511257
	1997.11-2003.06	Rear Axle Left & Right Lower Outer	Terrain cab wagon closed 4WD D4BA		Control Arm Bushing	511260
	1997.11-2003.06	Front Axle Left & Right Outer	Terrain cab wagon closed 4WD D4BA		Tie Rod End	S070232
	1997.11-2003.06	Front Axle	Terrain cab wagon closed 4WD D4BA		Stabiliser Bushing	S13327
	3.0 (118 kw)	1997.11-2001.09	Front Axle Left & Right Upper	Terrain cab wagon closed 4WD G6AT		Ball Joint
1997.11-2001.09		Front Axle Left & Right Lower	Terrain cab wagon closed 4WD G6AT		Control Arm Bushing	511257
1997.11-2001.09		Rear Axle Left & Right Lower Outer	Terrain cab wagon closed 4WD G6AT		Control Arm Bushing	511260
1997.11-2001.09		Front Axle Left & Right Outer	Terrain cab wagon closed 4WD G6AT		Tie Rod End	S070232
Genesis						
3.8 (213 kw)	2008.06-2014.12	Front Axle Left & Right Lower	Saloon RWD G6DA		Control Arm Bushing	530682
Grace						
2.5 (59 kw)	1998.06-2003.10	Front Axle Left Lower	VAN RWD D4BF		Track Control Arm	S061253
	1998.06-2003.10	Front Axle Left Upper	VAN RWD D4BF		Track Control Arm	S060536
	1998.06-2003.10	Front Axle Right Lower	VAN RWD D4BF		Track Control Arm	S061254
	1998.06-2003.10	Front Axle Right Upper	VAN RWD D4BF		Track Control Arm	S060537
	1998.06-2003.10	Front Axle Left & Right Lower	VAN RWD D4BF		Ball Joint	S080097
	1998.06-2003.10	Front Axle Left & Right Upper	VAN RWD D4BF		Ball Joint	S080084
	1998.06-2003.10	Front Axle Left & Right Upper	VAN RWD D4BF		Ball Joint	S080147
	1998.06-2003.10	Front Axle Left & Right Lower	VAN RWD D4BF		Control Arm Bushing	514893
	1998.06-2003.10	Rear Axle Left & Right Centre	VAN RWD D4BF		Control Arm Bushing	516539
	1998.06-2003.10	Front Axle Left & Right	VAN RWD D4BF		Tie Rod Axle Joint	S030528
	1998.06-2003.10	Front Axle Left & Right	VAN RWD D4BF	Date from: 1998.09	Tie Rod Axle Joint	S030620
	1998.06-2003.10	Front Axle Left & Right	VAN RWD D4BF		Tie Rod End	S070210
	1998.06-2003.10	Front Axle Left & Right	VAN RWD D4BF		Rod/Strut, stabiliser	S051287
Grand Santa Fe						
3.3 (199 kw)	2013.01-	Rear Axle Left & Right Lower Inner	SUV 4WD G6DF	For Mdl Year: 2015	Track Control Arm	S062190
	2013.01-	Front Axle Left & Right Lower	SUV 4WD G6DF		Control Arm Bushing	517305
	2013.01-	Front Axle Left & Right Lower	SUV 4WD G6DF		Control Arm Bushing	535472
	2013.01-	Rear Axle Left & Right Upper	SUV 4WD G6DF	AT	Control Arm Bushing	516269
	2013.01-	Rear Axle Left & Right Upper	SUV 4WD G6DF		Control Arm Bushing	516269
	2013.01-	Rear Axle Left & Right Lower Outer	SUV 4WD G6DF	AT	Control Arm Bushing	516232
	2013.01-	Rear Axle Left & Right Lower Outer	SUV 4WD G6DF		Control Arm Bushing	516361
	2013.01-	Front Axle Left & Right	SUV 4WD G6DF	Equipment Vart.:WITHOUT AIRCANAL	Tie Rod Axle Joint	S030985
	2013.01-	Front Axle Left & Right	SUV 4WD G6DF	Equipment Vart.:WITH AIRCANAL	Tie Rod Axle Joint	S030989
	2013.01-	Front Axle Left & Right	SUV 4WD G6DF		Tie Rod Axle Joint	S030997
	2013.01-	Front Axle Left	SUV 4WD G6DF		Tie Rod End	S071706
	2013.01-	Front Axle Right	SUV 4WD G6DF		Tie Rod End	S071707
	2013.01-	Rear Axle Left	SUV 4WD G6DF		Rod/Strut, stabiliser	S051265
	2013.01-	Rear Axle Right	SUV 4WD G6DF		Rod/Strut, stabiliser	S051266
Grandeur						
3.0 (192 kw)	2016.11-	Front Axle Left & Right	Saloon FWD G6DL		Tie Rod Axle Joint	S031000
	2016.11-	Rear Axle Left	Saloon FWD G6DL		Rod/Strut, stabiliser	S051473
	2016.11-	Rear Axle Right	Saloon FWD G6DL		Rod/Strut, stabiliser	S051472
H1						
2.5 (103 kw)	2002.12-2007.08	Front Axle Left Lower	BUS RWD D4CB		Track Control Arm	S060204
	2002.12-2007.08	Front Axle Left Lower	BUS RWD D4CB		Track Control Arm	S061112
	2002.12-2007.08	Front Axle Left Upper	BUS RWD D4CB		Track Control Arm	S061256
	2002.12-2007.08	Front Axle Right Lower	BUS RWD D4CB		Track Control Arm	S060205
	2002.12-2007.08	Front Axle Right Lower	BUS RWD D4CB		Track Control Arm	S061113
	2002.12-2007.08	Front Axle Right Upper	BUS RWD D4CB		Track Control Arm	S061255
	2002.12-2007.08	Front Axle Left & Right Lower	BUS RWD D4CB		Ball Joint	S080085
	2002.12-2007.08	Front Axle Left & Right Lower	BUS RWD D4CB		Ball Joint	S080455
	2002.12-2007.08	Front Axle Left & Right Upper	BUS RWD D4CB		Ball Joint	S080084
	2002.12-2007.08	Front Axle Left & Right Upper	BUS RWD D4CB		Ball Joint	S080147
	2002.12-2007.08	Front Axle Left & Right Lower	BUS RWD D4CB		Control Arm Bushing	514893
	2002.12-2007.08	Front Axle Left & Right Lower	BUS RWD D4CB		Control Arm Bushing	516494
	2002.12-2007.08	Rear Axle Left & Right Centre	BUS RWD D4CB		Control Arm Bushing	516343
	2002.12-2007.08	Rear Axle Left & Right Centre	BUS RWD D4CB		Control Arm Bushing	516539
	2002.12-2007.08	Rear Axle Left & Right Lower	BUS RWD D4CB		Control Arm Bushing	516344
	2002.12-2007.08	Rear Axle Left & Right Lower	BUS RWD D4CB		Control Arm Bushing	535466
	2002.12-2007.08	Rear Axle Left & Right Upper	BUS RWD D4CB		Control Arm Bushing	516118
	2002.12-2007.08	Rear Axle Left & Right Upper	BUS RWD D4CB	Date from: 2007.09	Control Arm Bushing	516329



	 YEAR	FITTING POSITION	BODY STYLE & DRIVE TYPE & ENGINE	REMARKS	PRODUCT	GSP Ref.
HYUNDAI H1						
2.5 (103 kw)	2002.12-2007.08	Rear Axle Left & Right Upper	BUS RWD D4CB		Control Arm Bushing	516329
	2002.12-2007.08	Rear Axle Left & Right Lower Outer	BUS RWD D4CB	Date from:2007.04	Control Arm Bushing	516343
	2002.12-2007.08	Rear Axle Left & Right Lower Outer	BUS RWD D4CB	Date from:2007.04	Control Arm Bushing	516344
	2002.12-2007.08	Front Axle Left	BUS RWD D4CB		Tie Rod Axle Joint	S030677
	2002.12-2007.08	Front Axle Right	BUS RWD D4CB		Tie Rod Axle Joint	S030678
	2002.12-2007.08	Front Axle Left	BUS RWD D4CB		Tie Rod End	S071024
	2002.12-2007.08	Front Axle Right	BUS RWD D4CB		Tie Rod End	S071025
	2002.12-2007.08	Front Axle Left & Right	BUS RWD D4CB		Tie Rod End	S070734
	2002.12-2007.08	Front Axle Left & Right	BUS RWD D4CB		Rod/Strut,stabiliser	S050209
	2002.12-2007.08	Rear Axle Left & Right	BUS RWD D4CB		Rod/Strut,stabiliser	S050210
	2002.12-2007.08	Front Axle	BUS RWD D4CB		Stabiliser Bushing	517821
2.6 (63 kw)	1997.10-2006.12	Front Axle Left & Right Upper	BUS RWD D4BB		Ball Joint	S080084
	1997.10-2006.12	Rear Axle Left & Right Centre	BUS RWD D4BB		Control Arm Bushing	516539
	1997.10-2006.12	Rear Axle Left & Right Lower	BUS RWD D4BB		Control Arm Bushing	535466
	1997.10-2006.12	Front Axle Left & Right	BUS RWD D4BB		Tie Rod Axle Joint	S030620
	1997.10-2006.12	Rear Axle Left & Right	BUS RWD D4BB		Rod/Strut,stabiliser	S050210
H100						
2.5 (57 kw)	1994.07-1998.05	Front Axle Left Lower	BUS RWD D4BA	Date to:1997.01	Track Control Arm	S060207
	1994.07-1998.05	Front Axle Left Lower	BUS RWD D4BA	For OE no.MB349943	Track Control Arm	S062645
	1994.07-1998.05	Front Axle Left Upper	BUS RWD D4BA		Track Control Arm	S060536
	1994.07-1998.05	Front Axle Right Lower	BUS RWD D4BA	Date to:1997.01	Track Control Arm	S060206
	1994.07-1998.05	Front Axle Right Lower	BUS RWD D4BA		Track Control Arm	S062646
	1994.07-1998.05	Front Axle Right Upper	BUS RWD D4BA		Track Control Arm	S060537
	1994.07-1998.05	Front Axle Left & Right Upper	BUS RWD D4BA		Track Control Arm	S062774
	1994.07-1998.05	Front Axle Left & Right Lower	BUS RWD D4BA		Ball Joint	S080097
	1994.07-1998.05	Front Axle Left & Right Upper	BUS RWD D4BA		Ball Joint	S080084
	1994.07-1998.05	Front Axle Left & Right Upper	BUS RWD D4BA		Ball Joint	S080147
	1994.07-1998.05	Front Axle Left & Right Lower	BUS RWD D4BA		Control Arm Bushing	514893
	1994.07-1998.05	Front Axle Left & Right	BUS RWD D4BA		Tie Rod Axle Joint	S030620
	1994.07-1998.05	Front Axle Left & Right	BUS RWD D4BA		Tie Rod End	S070210
	1994.07-1998.05	Front Axle Left & Right	BUS RWD D4BA		Rod/Strut,stabiliser	S051287
	1994.07-2000.03	Front Axle Left Upper	VAN RWD D4BA		Track Control Arm	S060536
	1994.07-2000.03	Front Axle Right Upper	VAN RWD D4BA		Track Control Arm	S060537
	1994.07-2000.03	Front Axle Left & Right Lower	VAN RWD D4BA		Ball Joint	S080097
	1994.07-2000.03	Front Axle Left & Right Upper	VAN RWD D4BA		Ball Joint	S080147
	1994.07-2000.03	Front Axle Left & Right Lower	VAN RWD D4BA		Control Arm Bushing	514893
	1994.07-2000.03	Front Axle Left & Right Lower	VAN RWD D4BA	Quantity:2	Control Arm Bushing	516494
	1994.07-2000.03	Front Axle Left & Right	VAN RWD D4BA		Tie Rod Axle Joint	S030620
	1994.07-2000.03	Front Axle Left & Right	VAN RWD D4BA		Tie Rod End	S070210
	1994.07-2000.03	Front Axle Left & Right	VAN RWD D4BA		Rod/Strut,stabiliser	S051287
2.5 (59 kw)	1998.06-2003.10	Front Axle Left Lower	VAN RWD D4BF		Track Control Arm	S061253
	1998.06-2003.10	Front Axle Left Upper	VAN RWD D4BF		Track Control Arm	S060536
	1998.06-2003.10	Front Axle Right Lower	VAN RWD D4BF		Track Control Arm	S061254
	1998.06-2003.10	Front Axle Right Upper	VAN RWD D4BF		Track Control Arm	S060537
	1998.06-2003.10	Front Axle Left & Right Lower	VAN RWD D4BF		Ball Joint	S080097
	1998.06-2003.10	Front Axle Left & Right Upper	VAN RWD D4BF		Ball Joint	S080084
	1998.06-2003.10	Front Axle Left & Right Upper	VAN RWD D4BF		Ball Joint	S080147
	1998.06-2003.10	Front Axle Left & Right Lower	VAN RWD D4BF		Control Arm Bushing	514893
	1998.06-2003.10	Rear Axle Left & Right Centre	VAN RWD D4BF		Control Arm Bushing	516539
	1998.06-2003.10	Front Axle Left & Right	VAN RWD D4BF		Tie Rod Axle Joint	S030528
	1998.06-2003.10	Front Axle Left & Right	VAN RWD D4BF	Date from:1998.09	Tie Rod Axle Joint	S030620
	1998.06-2003.10	Front Axle Left & Right	VAN RWD D4BF		Tie Rod End	S070210
	1998.06-2003.10	Front Axle Left & Right	VAN RWD D4BF		Rod/Strut,stabiliser	S051287
H150						
2.5 (57 kw)	1994.12-2000.03	Front Axle Left Upper	VAN RWD D4BA		Track Control Arm	S060536
	1994.12-2000.03	Front Axle Right Upper	VAN RWD D4BA		Track Control Arm	S060537
	1994.12-2000.03	Front Axle Left & Right Lower	VAN RWD D4BA		Ball Joint	S080097
	1994.12-2000.03	Front Axle Left & Right Upper	VAN RWD D4BA		Ball Joint	S080147
	1994.12-2000.03	Front Axle Left & Right Lower	VAN RWD D4BA		Control Arm Bushing	514893
	1994.12-2000.03	Front Axle Left & Right Lower	VAN RWD D4BA	Quantity:2	Control Arm Bushing	516494
	1994.12-2000.03	Front Axle Left & Right	VAN RWD D4BA		Tie Rod Axle Joint	S030620
	1994.12-2000.03	Front Axle Left & Right	VAN RWD D4BA		Tie Rod End	S070210
	1994.12-2000.03	Front Axle Left & Right	VAN RWD D4BA		Rod/Strut,stabiliser	S051287



	 YEAR	FITTING POSITION	BODY STYLE & DRIVE TYPE & ENGINE	REMARKS	PRODUCT	GSP Ref.	
HYUNDAI H200							
2.4 (101 kw)	2003.02-2004.04	Front Axle Left & Right Lower	BUS RWD G4JS		Ball Joint	S080085	
	2003.02-2004.04	Front Axle Left & Right Lower	BUS RWD G4JS		Control Arm Bushing	516494	
	2003.02-2004.04	Rear Axle Left & Right Centre	BUS RWD G4JS		Control Arm Bushing	516539	
	2003.02-2004.04	Rear Axle Left & Right Lower	BUS RWD G4JS		Control Arm Bushing	535466	
	2003.02-2004.04	Rear Axle Left & Right Upper	BUS RWD G4JS		Control Arm Bushing	516118	
	2003.02-2004.04	Front Axle Left & Right	BUS RWD G4JS		Tie Rod Axle Joint	S030620	
	2003.02-2004.04	Front Axle Left & Right	BUS RWD G4JS		Rod/Strut,stabiliser	S050209	
2.5 (103 kw)	2002.12-2007.09	Rear Axle Left & Right	BUS RWD G4JS		Rod/Strut,stabiliser	S050210	
	2002.12-2007.09	Front Axle Left Lower	BUS RWD D4CB		Track Control Arm	S060204	
	2002.12-2007.09	Front Axle Left Lower	BUS RWD D4CB		Track Control Arm	S061112	
	2002.12-2007.09	Front Axle Left Upper	BUS RWD D4CB		Track Control Arm	S061256	
	2002.12-2007.09	Front Axle Right Lower	BUS RWD D4CB		Track Control Arm	S060205	
	2002.12-2007.09	Front Axle Right Lower	BUS RWD D4CB		Track Control Arm	S061113	
	2002.12-2007.09	Front Axle Right Upper	BUS RWD D4CB		Track Control Arm	S061255	
	2002.12-2007.09	Front Axle Left & Right Lower	BUS RWD D4CB		Ball Joint	S080085	
	2002.12-2007.09	Front Axle Left & Right Lower	BUS RWD D4CB		Ball Joint	S080455	
	2002.12-2007.09	Front Axle Left & Right Upper	BUS RWD D4CB		Ball Joint	S080084	
	2002.12-2007.09	Front Axle Left & Right Upper	BUS RWD D4CB		Ball Joint	S080147	
	2002.12-2007.09	Front Axle Left & Right Lower	BUS RWD D4CB		Control Arm Bushing	514893	
	2002.12-2007.09	Front Axle Left & Right Lower	BUS RWD D4CB		Control Arm Bushing	516494	
	2002.12-2007.09	Rear Axle Left & Right Centre	BUS RWD D4CB		Control Arm Bushing	516343	
	2002.12-2007.09	Rear Axle Left & Right Centre	BUS RWD D4CB		Control Arm Bushing	516539	
	2002.12-2007.09	Rear Axle Left & Right Lower	BUS RWD D4CB		Control Arm Bushing	516344	
	2002.12-2007.09	Rear Axle Left & Right Lower	BUS RWD D4CB		Control Arm Bushing	535466	
	2002.12-2007.09	Rear Axle Left & Right Upper	BUS RWD D4CB		Control Arm Bushing	516118	
	2002.12-2007.09	Rear Axle Left & Right Upper	BUS RWD D4CB	Date from:2007.09	Control Arm Bushing	516329	
	2002.12-2007.09	Rear Axle Left & Right Upper	BUS RWD D4CB		Control Arm Bushing	516329	
	2002.12-2007.09	Rear Axle Left & Right Lower Outer	BUS RWD D4CB	Date from:2007.04	Control Arm Bushing	516343	
	2002.12-2007.09	Rear Axle Left & Right Lower Outer	BUS RWD D4CB	Date from:2007.04	Control Arm Bushing	516344	
	2002.12-2007.09	Front Axle Left	BUS RWD D4CB		Tie Rod Axle Joint	S030677	
	2002.12-2007.09	Front Axle Right	BUS RWD D4CB		Tie Rod Axle Joint	S030678	
	2002.12-2007.09	Front Axle Left	BUS RWD D4CB		Tie Rod End	S071024	
	2002.12-2007.09	Front Axle Right	BUS RWD D4CB		Tie Rod End	S071025	
	2002.12-2007.09	Front Axle Left & Right	BUS RWD D4CB		Tie Rod End	S070734	
	2002.12-2007.09	Front Axle Left & Right	BUS RWD D4CB		Rod/Strut,stabiliser	S050209	
	2002.12-2007.09	Rear Axle Left & Right	BUS RWD D4CB		Rod/Strut,stabiliser	S050210	
	2002.12-2007.09	Front Axle	BUS RWD D4CB		Stabiliser Bushing	517821	
	i30						
	1.6 (94 kw)	2012.09-2014.12	Front Axle Left Lower	Hatchback FWD F4FC		Track Control Arm	S061275
		2012.09-2014.12	Front Axle Right Lower	Hatchback FWD F4FC		Track Control Arm	S061276
2012.09-2014.12		Rear Axle Left & Right Upper	Hatchback FWD F4FC		Track Control Arm	S062952	
2012.09-2014.12		Rear Axle Left & Right Lower Inner	Hatchback FWD F4FC		Track Control Arm	S062191	
2012.09-2014.12		Front Axle Left & Right Lower	Hatchback FWD F4FC		Ball Joint	S080500	
2012.09-2014.12		Rear Axle Left & Right Centre	Hatchback FWD F4FC		Control Arm Bushing	516373	
2012.09-2014.12		Rear Axle Left & Right Upper	Hatchback FWD F4FC		Control Arm Bushing	535465	
2012.09-2014.12		Rear Axle Left & Right Lower Inner	Hatchback FWD F4FC		Control Arm Bushing	514904	
2012.09-2014.12		Rear Axle Left & Right Lower Outer	Hatchback FWD F4FC		Control Arm Bushing	535464	
2012.09-2014.12		Front Axle	Hatchback FWD F4FC		Stabiliser Bushing	535186	
1.8 (110 kw)		2012.01-	Front Axle Left Lower	Hatchback FWD G4NB		Track Control Arm	S061275
	2012.01-	Front Axle Right Lower	Hatchback FWD G4NB		Track Control Arm	S061276	
	2012.01-	Rear Axle Left & Right Upper	Hatchback FWD G4NB		Track Control Arm	S062952	
	2012.01-	Front Axle Left & Right Lower	Hatchback FWD G4NB		Ball Joint	S080500	
	2012.01-	Front Axle	Hatchback FWD G4NB		Stabiliser Bushing	535186	
2.0 (105 kw)	2007.06-2012.12	Front Axle Left Lower	Hatchback FWD G4GC		Track Control Arm	S060542	
	2007.06-2012.12	Front Axle Right Lower	Hatchback FWD G4GC		Track Control Arm	S060543	
	2007.06-2012.12	Rear Axle Left & Right Upper	Hatchback FWD G4GC		Track Control Arm	S062222	
	2007.06-2012.12	Rear Axle Left & Right Lower Inner	Hatchback FWD G4GC		Track Control Arm	S062191	
	2007.06-2012.12	Rear Axle Left & Right Lower Outer	Hatchback FWD G4GC		Track Control Arm	S063182	
	2007.06-2012.12	Front Axle Left & Right Lower	Hatchback FWD G4GC	VIN:KMH;Date to:2009.03;VIN:TMA	Ball Joint	S080096	
	2007.06-2012.12	Front Axle Left & Right Lower	Hatchback FWD G4GC	Date from:2009.08	Ball Joint	S080690	
	2007.06-2012.12	Rear Axle Left Centre	Hatchback FWD G4GC		Control Arm Bushing	530812	
	2007.06-2012.12	Rear Axle Right Centre	Hatchback FWD G4GC		Control Arm Bushing	530813	
	2007.06-2012.12	Rear Axle Left & Right Centre	Hatchback FWD G4GC		Control Arm Bushing	516373	
	2007.06-2012.12	Rear Axle Left & Right Lower Inner	Hatchback FWD G4GC		Control Arm Bushing	514904	



	 YEAR	FITTING POSITION	BODY STYLE & DRIVE TYPE & ENGINE	REMARKS	PRODUCT	GSP Ref.
HYUNDAI						
i30						
2.0 (105 kw)	2007.06-2012.12	Rear Axle Left & Right Lower Outer	Hatchback FWD G4GC		Control Arm Bushing	516361
	2007.06-2012.12	Front Axle	Hatchback FWD G4GC		Suspension Repair Kit	S990047SK
	2007.06-2012.12	Front Axle Left & Right	Hatchback FWD G4GC		Tie Rod Axle Joint	S030130
	2007.06-2012.12	Front Axle Left	Hatchback FWD G4GC		Tie Rod End	S070225
	2007.06-2012.12	Front Axle Right	Hatchback FWD G4GC		Tie Rod End	S070226
	2007.06-2012.12	Front Axle Left & Right	Hatchback FWD G4GC		Rod/Strut,stabiliser	S050222
	2007.06-2012.12	Rear Axle Left & Right	Hatchback FWD G4GC	Date to:2010.07,VIN:KMH;VIN:TMA	Rod/Strut,stabiliser	S050223
	2007.06-2012.12	Rear Axle Left & Right	Hatchback FWD G4GC	Date from:2010.07,VIN:KMH	Rod/Strut,stabiliser	S050831
	2007.06-2012.12	Front Axle	Hatchback FWD G4GC		Stabiliser Bushing	517312
	2007.06-2012.12	Rear Axle	Hatchback FWD G4GC		Stabiliser Bushing	517822
	2007.06-2012.12	Front Axle	Hatchback FWD G4GC		Steering Boot	540291
i30 CW						
2.0 (105 kw)	2008.02-2012.06	Front Axle Left Lower	Estate FWD G4GC		Track Control Arm	S060542
	2008.02-2012.06	Front Axle Right Lower	Estate FWD G4GC		Track Control Arm	S060543
	2008.02-2012.06	Rear Axle Left & Right Upper	Estate FWD G4GC		Track Control Arm	S062222
	2008.02-2012.06	Rear Axle Left & Right Lower Inner	Estate FWD G4GC		Track Control Arm	S062191
	2008.02-2012.06	Rear Axle Left & Right Lower Outer	Estate FWD G4GC		Track Control Arm	S063182
	2008.02-2012.06	Front Axle Left & Right Lower	Estate FWD G4GC	VIN:KMH;Date to:2009.03,VIN:TMA	Ball Joint	S080096
	2008.02-2012.06	Front Axle Left & Right Lower	Estate FWD G4GC	Date from:2009.08	Ball Joint	S080690
	2008.02-2012.06	Front Axle Left & Right Lower	Estate FWD G4GC		Control Arm Bushing	530529
	2008.02-2012.06	Rear Axle Left & Right Centre	Estate FWD G4GC		Control Arm Bushing	516373
	2008.02-2012.06	Rear Axle Left & Right Lower Inner	Estate FWD G4GC		Control Arm Bushing	514904
	2008.02-2012.06	Rear Axle Left & Right Lower Outer	Estate FWD G4GC		Control Arm Bushing	516361
	2008.02-2012.06	Front Axle	Estate FWD G4GC		Suspension Repair Kit	S990047SK
	2008.02-2012.06	Front Axle Left & Right	Estate FWD G4GC		Tie Rod Axle Joint	S030130
	2008.02-2012.06	Front Axle Left	Estate FWD G4GC		Tie Rod End	S070225
	2008.02-2012.06	Front Axle Right	Estate FWD G4GC		Tie Rod End	S070226
	2008.02-2012.06	Front Axle Left & Right	Estate FWD G4GC		Rod/Strut,stabiliser	S050222
	2008.02-2012.06	Rear Axle Left & Right	Estate FWD G4GC	Date to:2010.07,VIN:KMH;VIN:TMA	Rod/Strut,stabiliser	S050223
	2008.02-2012.06	Rear Axle Left & Right	Estate FWD G4GC	Date from:2010.07,VIN:KMH	Rod/Strut,stabiliser	S050831
	2008.02-2012.06	Front Axle	Estate FWD G4GC		Stabiliser Bushing	517312
ix55						
3.8 (191 kw)	2008.09-2012.11	Front Axle Left Lower	SUV 4WD G6DA		Track Control Arm	S061805
	2008.09-2012.11	Front Axle Right Lower	SUV 4WD G6DA		Track Control Arm	S061806
	2008.09-2012.11	Front Axle Left & Right Lower	SUV 4WD G6DA		Ball Joint	S080455
	2008.09-2012.11	Rear Axle Left & Right Upper	SUV 4WD G6DA		Control Arm Bushing	516171
	2008.09-2012.11	Rear Axle Left & Right Lower Inner	SUV 4WD G6DA	AT,Date to:2013.04	Control Arm Bushing	516145
	2008.09-2012.11	Rear Axle Left & Right Lower Outer	SUV 4WD G6DA		Control Arm Bushing	516172
	2008.09-2012.11	Front Axle Left & Right	SUV 4WD G6DA		Tie Rod Axle Joint	S030717
	2008.09-2012.11	Front Axle Left	SUV 4WD G6DA		Tie Rod End	S070223
	2008.09-2012.11	Front Axle Right	SUV 4WD G6DA		Tie Rod End	S070224
	2008.09-2012.11	Front Axle Left	SUV 4WD G6DA		Rod/Strut,stabiliser	S050216
	2008.09-2012.11	Front Axle Right	SUV 4WD G6DA		Rod/Strut,stabiliser	S050217
	2008.09-2012.11	Rear Axle Left & Right	SUV 4WD G6DA		Rod/Strut,stabiliser	S050218
Lantra						
1.6 (84 kw)	1990.12-1995.05	Front Axle Left & Right Lower	Saloon FWD G4CR		Ball Joint	S080082
	1990.12-1995.05	Front Axle Left & Right Lower	Saloon FWD G4CR		Control Arm Bushing	510956
	1990.12-1995.05	Front Axle Left & Right	Saloon FWD G4CR	Date from:1993.06	Tie Rod Axle Joint	S030112
	1990.12-1995.05	Front Axle Left & Right	Saloon FWD G4CR	Date from-to:1992.05-1993.05	Tie Rod Axle Joint	S030620
	1990.12-1995.05	Front Axle Left & Right	Saloon FWD G4CR	Date to:1992.03	Tie Rod Axle Joint	S070213
	1990.12-1995.05	Front Axle Left & Right	Saloon FWD G4CR	Date from:1992.05	Tie Rod End	S070209
	1990.12-1995.05	Front Axle Left & Right	Saloon FWD G4CR	for vehicles with power steering,Date to:1992.04	Tie Rod End	S070321
	1990.12-1995.05	Front Axle Left & Right	Saloon FWD G4CR		Tie Rod End	S070695
	1990.12-1995.05	Front Axle Left & Right	Saloon FWD G4CR		Rod/Strut,stabiliser	S050225
	1990.12-1995.05	Front Axle	Saloon FWD G4CR		Steering Boot	540101
	1990.12-1995.05	Front Axle	Saloon FWD G4CR	Date from-to:1992.04-1995.07	Steering Rack Bellow Kit	540235S
Pony						
1.5 (62 kw)	1989.09-1994.08	Front Axle Left Lower	Saloon FWD G4DJ		Track Control Arm	S061954
	1989.09-1994.08	Front Axle Right Lower	Saloon FWD G4DJ		Track Control Arm	S061955
	1989.09-1994.08	Front Axle Left & Right Lower	Saloon FWD G4DJ		Ball Joint	S080082
	1989.09-1994.08	Front Axle Left & Right	Saloon FWD G4DJ	for vehicles with power steering	Tie Rod Axle Joint	S030117
	1989.09-1994.08	Front Axle Left & Right	Saloon FWD G4DJ	for vehicles without power steering	Tie Rod Axle Joint	S070213
	1989.09-1994.08	Front Axle Right	Saloon FWD G4DJ		Tie Rod End	S071686
	1989.09-1994.08	Front Axle Left & Right	Saloon FWD G4DJ		Tie Rod End	S070230

	 YEAR	FITTING POSITION	BODY STYLE & DRIVE TYPE & ENGINE	REMARKS	PRODUCT	GSP Ref.
HYUNDAI Pony						
1.5 (62 kw)	1989.09-1994.08	Front Axle	Saloon FWD G4DJ		Steering Boot	540101
Santa Fe						
2.4 (128 kw)	2009.01-2013.05	Front Axle Left Lower	SUV FWD G4KE		Track Control Arm	S061251
	2009.01-2013.05	Front Axle Right Lower	SUV FWD G4KE		Track Control Arm	S061252
	2009.01-2013.05	Rear Axle Left Upper	SUV FWD G4KE		Track Control Arm	S063170
	2009.01-2013.05	Rear Axle Right Upper	SUV FWD G4KE		Track Control Arm	S063169
	2009.01-2013.05	Rear Axle Left & Right Lower Inner	SUV FWD G4KE		Track Control Arm	S063209
	2009.01-2013.05	Front Axle Left & Right Lower	SUV FWD G4KE		Control Arm Bushing	516150
	2009.01-2013.05	Front Axle Left & Right Lower	SUV FWD G4KE		Control Arm Bushing	516254
	2009.01-2013.05	Rear Axle Left & Right Upper	SUV FWD G4KE		Control Arm Bushing	516171
	2009.01-2013.05	Rear Axle Left & Right Lower Inner	SUV FWD G4KE	Date to:2012.08	Control Arm Bushing	516145
	2009.01-2013.05	Rear Axle Left & Right Lower Outer	SUV FWD G4KE		Control Arm Bushing	516172
	2009.01-2013.05	Front Axle	SUV FWD G4KE		Suspension Repair Kit	S990065SK
	2009.01-2013.05	Front Axle Left & Right	SUV FWD G4KE		Tie Rod Axle Joint	S030121
	2009.01-2013.05	Front Axle Left & Right	SUV FWD G4KE		Tie Rod Axle Joint	S030578
	2009.01-2013.05	Front Axle Left	SUV FWD G4KE		Tie Rod End	S070223
	2009.01-2013.05	Front Axle Right	SUV FWD G4KE		Tie Rod End	S070224
	2009.01-2013.05	Front Axle Left	SUV FWD G4KE		Rod/Strut,stabiliser	S050216
	2009.01-2013.05	Front Axle Right	SUV FWD G4KE		Rod/Strut,stabiliser	S050217
	2009.01-2013.05	Rear Axle Left & Right	SUV FWD G4KE		Rod/Strut,stabiliser	S050218
	2009.01-2013.05	Front Axle	SUV FWD G4KE	Date to:2012.08	Stabiliser Bushing	517821
	2009.01-2013.05	Rear Axle	SUV FWD G4KE		Stabiliser Bushing	517319
	2009.01-2013.05	Front Axle	SUV FWD G4KE		Steering Boot	540420
2.4 (130 kw)	2009.09-2012.12	Rear Axle Left Upper	SUV AWD G4KE		Track Control Arm	S063170
	2009.09-2012.12	Rear Axle Right Upper	SUV AWD G4KE		Track Control Arm	S063169
2.7 (127 kw)	2000.08-2006.03	Front Axle Left Lower	SUV 4WD G6BA		Track Control Arm	S060516
	2000.08-2006.03	Front Axle Right Lower	SUV 4WD G6BA		Track Control Arm	S060517
	2000.08-2006.03	Rear Axle Left Upper	SUV 4WD G6BA		Track Control Arm	S063121
	2000.08-2006.03	Rear Axle Left Lower Inner	SUV 4WD G6BA		Track Control Arm	S063234
	2000.08-2006.03	Rear Axle Left Lower Outer	SUV 4WD G6BA		Track Control Arm	S063178
	2000.08-2006.03	Rear Axle Right Upper	SUV 4WD G6BA		Track Control Arm	S063122
	2000.08-2006.03	Rear Axle Right Lower Inner	SUV 4WD G6BA		Track Control Arm	S063233
	2000.08-2006.03	Rear Axle Right Lower Outer	SUV 4WD G6BA		Track Control Arm	S063179
	2000.08-2006.03	Front Axle Left & Right Lower	SUV 4WD G6BA		Ball Joint	S080090
	2000.08-2006.03	Front Axle Left & Right Lower	SUV 4WD G6BA		Control Arm Bushing	514292
	2000.08-2006.03	Front Axle Left & Right Lower	SUV 4WD G6BA		Control Arm Bushing	514886
	2000.08-2006.03	Rear Axle Left & Right Upper	SUV 4WD G6BA	Date to:2006.02	Control Arm Bushing	514916
	2000.08-2006.03	Rear Axle Left & Right Upper	SUV 4WD G6BA		Control Arm Bushing	514916
	2000.08-2006.03	Rear Axle Left & Right Upper	SUV 4WD G6BA	Date to:2006.02	Control Arm Bushing	514996
	2000.08-2006.03	Front Axle Left & Right	SUV 4WD G6BA		Tie Rod Axle Joint	S030124
	2000.08-2006.03	Front Axle Left & Right	SUV 4WD G6BA		Tie Rod End	S070209
	2000.08-2006.03	Front Axle Left	SUV 4WD G6BA		Rod/Strut,stabiliser	S050199
	2000.08-2006.03	Front Axle Right	SUV 4WD G6BA		Rod/Strut,stabiliser	S050200
	2000.08-2006.03	Rear Axle Left	SUV 4WD G6BA		Rod/Strut,stabiliser	S050211
	2000.08-2006.03	Rear Axle Right	SUV 4WD G6BA		Rod/Strut,stabiliser	S050212
	2000.08-2006.03	Front Axle	SUV 4WD G6BA		Stabiliser Bushing	516780
	2000.08-2006.03	Rear Axle	SUV 4WD G6BA		Stabiliser Bushing	516779
	2000.08-2006.03	Front Axle	SUV 4WD G6BA		Steering Boot	540420
2.7 (147 kw)	2007.01-2011.12	Rear Axle Left Upper	SUV 4WD G6EA		Track Control Arm	S063170
	2007.01-2011.12	Rear Axle Right Upper	SUV 4WD G6EA		Track Control Arm	S063169
	2007.01-2011.12	Front Axle Left & Right Lower	SUV 4WD G6EA		Control Arm Bushing	516254
	2007.01-2011.12	Rear Axle Left & Right Upper	SUV 4WD G6EA		Control Arm Bushing	516171
	2007.01-2011.12	Rear Axle Left & Right Lower Inner	SUV 4WD G6EA	Date to:2010.12	Control Arm Bushing	516145
	2007.01-2011.12	Front Axle	SUV 4WD G6EA		Steering Boot	540420
3.3 (199 kw)	2013.08-	Rear Axle Left & Right Lower Inner	SUV 4WD G6DF		Track Control Arm	S062190
	2013.08-	Front Axle Left & Right Lower	SUV 4WD G6DF		Ball Joint	S080500
	2013.08-	Front Axle Left & Right Lower	SUV 4WD G6DF		Control Arm Bushing	517305
	2013.08-	Front Axle Left & Right Lower	SUV 4WD G6DF		Control Arm Bushing	535472
	2013.08-	Rear Axle Left & Right Upper	SUV 4WD G6DF		Control Arm Bushing	516269
	2013.08-	Rear Axle Left & Right Lower Outer	SUV 4WD G6DF		Control Arm Bushing	516232
	2013.08-	Rear Axle Left & Right Lower Outer	SUV 4WD G6DF		Control Arm Bushing	516361
	2013.08-	Front Axle Left & Right	SUV 4WD G6DF	Equipment Vari.:WITHOUT AIRCANAL	Tie Rod Axle Joint	S030985
	2013.08-	Front Axle Left & Right	SUV 4WD G6DF	Equipment Vari.:WITH AIRCANAL	Tie Rod Axle Joint	S030989
	2013.08-	Front Axle Left & Right	SUV 4WD G6DF		Tie Rod Axle Joint	S030997



	 YEAR	FITTING POSITION	BODY STYLE & DRIVE TYPE & ENGINE	REMARKS	PRODUCT	GSP Ref.
HYUNDAI						
Santa Fe						
3.3 (199 kw)	2013.08-	Front Axle Left	SUV 4WD G6DF		Tie Rod End	S071706
	2013.08-	Front Axle Right	SUV 4WD G6DF		Tie Rod End	S071707
	2013.08-	Rear Axle Left	SUV 4WD G6DF		Rod/Strut,stabiliser	S051265
	2013.08-	Rear Axle Right	SUV 4WD G6DF		Rod/Strut,stabiliser	S051266
	2013.08-	Front Axle	SUV 4WD G6DF		Stabiliser Bushing	535186
3.5 (210 kw)	2010.07-2013.05	Rear Axle Left Upper	SUV 4WD G6DC		Track Control Arm	S063170
	2010.07-2013.05	Rear Axle Right Upper	SUV 4WD G6DC		Track Control Arm	S063169
	2010.07-2013.05	Front Axle Left & Right Lower	SUV 4WD G6DC		Control Arm Bushing	516254
	2010.07-2013.05	Rear Axle Left & Right Upper	SUV 4WD G6DC		Control Arm Bushing	516171
	2010.07-2013.05	Rear Axle Left & Right Lower Inner	SUV 4WD G6DC	AT,Date to:2012.08	Control Arm Bushing	516145
Satellite						
2.5 (103 kw)	2002.12-2007.09	Front Axle Left Lower	BUS RWD D4CB		Track Control Arm	S060204
	2002.12-2007.09	Front Axle Left Lower	BUS RWD D4CB		Track Control Arm	S061112
	2002.12-2007.09	Front Axle Left Upper	BUS RWD D4CB		Track Control Arm	S061256
	2002.12-2007.09	Front Axle Right Lower	BUS RWD D4CB		Track Control Arm	S060205
	2002.12-2007.09	Front Axle Right Lower	BUS RWD D4CB		Track Control Arm	S061113
	2002.12-2007.09	Front Axle Right Upper	BUS RWD D4CB		Track Control Arm	S061255
	2002.12-2007.09	Front Axle Left & Right Lower	BUS RWD D4CB		Ball Joint	S080085
	2002.12-2007.09	Front Axle Left & Right Lower	BUS RWD D4CB		Ball Joint	S080455
	2002.12-2007.09	Front Axle Left & Right Upper	BUS RWD D4CB		Ball Joint	S080084
	2002.12-2007.09	Front Axle Left & Right Upper	BUS RWD D4CB		Ball Joint	S080147
	2002.12-2007.09	Front Axle Left & Right Lower	BUS RWD D4CB		Control Arm Bushing	514893
	2002.12-2007.09	Front Axle Left & Right Lower	BUS RWD D4CB		Control Arm Bushing	516494
	2002.12-2007.09	Rear Axle Left & Right Centre	BUS RWD D4CB		Control Arm Bushing	516343
	2002.12-2007.09	Rear Axle Left & Right Centre	BUS RWD D4CB		Control Arm Bushing	516539
	2002.12-2007.09	Rear Axle Left & Right Lower	BUS RWD D4CB		Control Arm Bushing	516344
	2002.12-2007.09	Rear Axle Left & Right Lower	BUS RWD D4CB		Control Arm Bushing	535466
	2002.12-2007.09	Rear Axle Left & Right Upper	BUS RWD D4CB		Control Arm Bushing	516118
	2002.12-2007.09	Rear Axle Left & Right Upper	BUS RWD D4CB	Date from:2007.09	Control Arm Bushing	516329
	2002.12-2007.09	Rear Axle Left & Right Upper	BUS RWD D4CB		Control Arm Bushing	516329
	2002.12-2007.09	Rear Axle Left & Right Lower Outer	BUS RWD D4CB	Date from:2007.04	Control Arm Bushing	516343
	2002.12-2007.09	Rear Axle Left & Right Lower Outer	BUS RWD D4CB	Date from:2007.04	Control Arm Bushing	516344
	2002.12-2007.09	Front Axle Left	BUS RWD D4CB		Tie Rod Axle Joint	S030677
	2002.12-2007.09	Front Axle Right	BUS RWD D4CB		Tie Rod Axle Joint	S030678
	2002.12-2007.09	Front Axle Left	BUS RWD D4CB		Tie Rod End	S071024
	2002.12-2007.09	Front Axle Right	BUS RWD D4CB		Tie Rod End	S071025
	2002.12-2007.09	Front Axle Left & Right	BUS RWD D4CB		Tie Rod End	S070734
	2002.12-2007.09	Front Axle Left & Right	BUS RWD D4CB		Rod/Strut,stabiliser	S050209
	2002.12-2007.09	Rear Axle Left & Right	BUS RWD D4CB		Rod/Strut,stabiliser	S050210
	2002.12-2007.09	Front Axle	BUS RWD D4CB		Stabiliser Bushing	517821
Sonata						
2.0 (77 kw)	1993.06-1996.06	Front Axle Left & Right Lower	Saloon FWD G4CP		Ball Joint	S080083
	1993.06-1996.06	Rear Axle Left & Right Upper	Saloon FWD G4CP		Control Arm Bushing	516012
	1993.06-1996.06	Front Axle Left & Right	Saloon FWD G4CP		Tie Rod Axle Joint	S030118
	1993.06-1996.06	Front Axle Left & Right	Saloon FWD G4CP		Rod/Strut,stabiliser	S050203
2.0 (96 kw)	2001.04-2005.04	Front Axle Left Upper	Saloon FWD G4JP		Track Control Arm	S060538
	2001.04-2005.04	Front Axle Right Upper	Saloon FWD G4JP		Track Control Arm	S060539
	2001.04-2005.04	Rear Axle Left Upper	Saloon FWD G4JP		Track Control Arm	S061530
	2001.04-2005.04	Rear Axle Right Upper	Saloon FWD G4JP		Track Control Arm	S061531
	2001.04-2005.04	Rear Axle Left & Right Lower	Saloon FWD G4JP	For OE no.5521038000	Track Control Arm	S061695
	2001.04-2005.04	Rear Axle Left & Right Lower	Saloon FWD G4JP	For OE no.5527038000	Track Control Arm	S063066
	2001.04-2005.04	Rear Axle Left & Right Lower Outer	Saloon FWD G4JP		Track Control Arm	S063090
	2001.04-2005.04	Front Axle Left & Right Lower	Saloon FWD G4JP		Ball Joint	S080091
	2001.04-2005.04	Front Axle Left & Right Upper	Saloon FWD G4JP		Ball Joint	S080470
	2001.04-2005.04	Rear Axle Left & Right	Saloon FWD G4JP		Ball Joint	S080098
	2001.04-2005.04	Front Axle Left & Right Lower	Saloon FWD G4JP	Quantity:2	Control Arm Bushing	514314
	2001.04-2005.04	Front Axle Left & Right Lower	Saloon FWD G4JP		Control Arm Bushing	516004
	2001.04-2005.04	Front Axle Left & Right Lower	Saloon FWD G4JP		Control Arm Bushing	516081
	2001.04-2005.04	Front Axle Left & Right Lower	Saloon FWD G4JP	Date from:2004.08	Control Arm Bushing	530682
	2001.04-2005.04	Front Axle Left & Right Upper	Saloon FWD G4JP		Control Arm Bushing	516019
	2001.04-2005.04	Rear Axle Left & Right Lower	Saloon FWD G4JP	for article no. :SCA-3139 for article no. :SCA-3041	Control Arm Bushing	513686
	2001.04-2005.04	Rear Axle Left & Right Lower	Saloon FWD G4JP	Quantity:1	Control Arm Bushing	514980
	2001.04-2005.04	Rear Axle Left & Right Upper	Saloon FWD G4JP	Quantity:2, Type:AT WHEEL CARRIER	Control Arm Bushing	513689
	2001.04-2005.04	Rear Axle Left & Right Upper	Saloon FWD G4JP		Control Arm Bushing	514994



	 YEAR	FITTING POSITION	BODY STYLE & DRIVE TYPE & ENGINE	REMARKS	PRODUCT	GSP Ref.
HYUNDAI Sonata						
2.0 (96 kw)	2001.04-2005.04	Rear Axle Left & Right Upper	Saloon FWD G4JP		Control Arm Bushing	516012
	2001.04-2005.04	Rear Axle Left & Right Upper	Saloon FWD G4JP	Date from:2004.08	Control Arm Bushing	516171
	2001.04-2005.04	Rear Axle Left & Right Upper	Saloon FWD G4JP		Control Arm Bushing	519697
	2001.04-2005.04	Front Axle Left & Right	Saloon FWD G4JP		Tie Rod Axle Joint	S030119
	2001.04-2005.04	Front Axle Left	Saloon FWD G4JP		Tie Rod End	S070215
	2001.04-2005.04	Front Axle Right	Saloon FWD G4JP		Tie Rod End	S070216
	2001.04-2005.04	Front Axle Left & Right	Saloon FWD G4JP		Tie Rod End	S070862
	2001.04-2005.04	Front Axle Left & Right	Saloon FWD G4JP		Rod/Strut,stabiliser	S050204
	2001.04-2005.04	Rear Axle Left & Right	Saloon FWD G4JP		Rod/Strut,stabiliser	S050581
	2001.04-2005.04	Front Axle	Saloon FWD G4JP		Stabiliser Bushing	513683
2.4 (131 kw)	2010.11-2014.12	Front Axle Left & Right Lower	Saloon FWD G4KC		Ball Joint	S080500
	2010.11-2014.12	Front Axle Left & Right Lower	Saloon FWD G4KC	Date to:2013.06	Control Arm Bushing	530682
	2010.11-2014.12	Front Axle Left & Right Lower	Saloon FWD G4KC		Control Arm Bushing	535472
	2010.11-2014.12	Rear Axle Left & Right Upper	Saloon FWD G4KC	Date to:2013.06	Control Arm Bushing	516012
	2010.11-2014.12	Rear Axle Left & Right Upper	Saloon FWD G4KC	Date to:2013.06	Control Arm Bushing	516171
	2010.11-2014.12	Rear Axle Left & Right Upper	Saloon FWD G4KC		Control Arm Bushing	535465
	2010.11-2014.12	Front Axle Left & Right	Saloon FWD G4KC	Date from-to:2011.11-2015.01	Rod/Strut,stabiliser	S050592
2.5 (118 kw)	1998.06-2001.12	Front Axle Left Lower	Saloon FWD G6BV		Track Control Arm	S060540
	1998.06-2001.12	Front Axle Left Upper	Saloon FWD G6BV		Track Control Arm	S060538
	1998.06-2001.12	Front Axle Right Lower	Saloon FWD G6BV		Track Control Arm	S060541
	1998.06-2001.12	Front Axle Right Upper	Saloon FWD G6BV		Track Control Arm	S060539
	1998.06-2001.12	Rear Axle Left Upper	Saloon FWD G6BV		Track Control Arm	S061530
	1998.06-2001.12	Rear Axle Right Upper	Saloon FWD G6BV		Track Control Arm	S061531
	1998.06-2001.12	Rear Axle Left & Right Lower	Saloon FWD G6BV		Track Control Arm	S061695
	1998.06-2001.12	Rear Axle Left & Right Lower Outer	Saloon FWD G6BV		Track Control Arm	S063090
	1998.06-2001.12	Front Axle Left & Right Lower	Saloon FWD G6BV		Ball Joint	S080091
	1998.06-2001.12	Front Axle Left & Right Upper	Saloon FWD G6BV		Ball Joint	S080470
	1998.06-2001.12	Rear Axle Left & Right	Saloon FWD G6BV		Ball Joint	S080098
	1998.06-2001.12	Front Axle Left & Right Lower	Saloon FWD G6BV	Quantity:2	Control Arm Bushing	514314
	1998.06-2001.12	Front Axle Left & Right Lower	Saloon FWD G6BV	Date to:1999.11	Control Arm Bushing	514847
	1998.06-2001.12	Front Axle Left & Right Lower	Saloon FWD G6BV		Control Arm Bushing	516004
	1998.06-2001.12	Front Axle Left & Right Lower	Saloon FWD G6BV		Control Arm Bushing	516081
	1998.06-2001.12	Front Axle Left & Right Upper	Saloon FWD G6BV		Control Arm Bushing	516019
	1998.06-2001.12	Rear Axle Left & Right Lower	Saloon FWD G6BV	for article no.:SCA-3139;for article no.:SCA-3041	Control Arm Bushing	513686
	1998.06-2001.12	Rear Axle Left & Right Lower	Saloon FWD G6BV	Quantity:1	Control Arm Bushing	514980
	1998.06-2001.12	Rear Axle Left & Right Upper	Saloon FWD G6BV	Quantity:4,Type:AT WHEEL CARRIER	Control Arm Bushing	513689
	1998.06-2001.12	Rear Axle Left & Right Upper	Saloon FWD G6BV		Control Arm Bushing	514994
	1998.06-2001.12	Rear Axle Left & Right Upper	Saloon FWD G6BV	Date to:2001.06	Control Arm Bushing	516012
	1998.06-2001.12	Front Axle Left & Right	Saloon FWD G6BV		Tie Rod Axle Joint	S030119
	1998.06-2001.12	Front Axle Left	Saloon FWD G6BV		Tie Rod End	S070215
	1998.06-2001.12	Front Axle Right	Saloon FWD G6BV		Tie Rod End	S070216
	1998.06-2001.12	Front Axle Left & Right	Saloon FWD G6BV		Rod/Strut,stabiliser	S050204
	1998.06-2001.12	Rear Axle Left & Right	Saloon FWD G6BV		Rod/Strut,stabiliser	S050205
	1998.06-2001.12	Front Axle	Saloon FWD G6BV		Stabiliser Bushing	513683
2.7 (132 kw)	2001.10-2003.12	Rear Axle Left & Right Lower	Saloon FWD G6BAY		Track Control Arm	S061695
	2001.10-2003.12	Front Axle Left & Right Lower	Saloon FWD G6BAY		Ball Joint	S080091
	2001.10-2003.12	Front Axle Left & Right Upper	Saloon FWD G6BAY		Ball Joint	S080470
	2001.10-2003.12	Rear Axle Left & Right Upper	Saloon FWD G6BAY		Control Arm Bushing	516012
	2001.10-2003.12	Front Axle Left & Right	Saloon FWD G6BAY		Rod/Strut,stabiliser	S050204
	2001.10-2003.12	Rear Axle Left & Right	Saloon FWD G6BAY		Rod/Strut,stabiliser	S050581
3.3 (173 kw)	2005.05-2010.12	Front Axle Left Lower	Saloon FWD G6DB		Track Control Arm	S061107
	2005.05-2010.12	Front Axle Left Upper	Saloon FWD G6DB		Track Control Arm	S061050
	2005.05-2010.12	Front Axle Right Lower	Saloon FWD G6DB		Track Control Arm	S061108
	2005.05-2010.12	Front Axle Right Upper	Saloon FWD G6DB		Track Control Arm	S061051
	2005.05-2010.12	Rear Axle Left Upper Outer	Saloon FWD G6DB		Track Control Arm	S063239
	2005.05-2010.12	Rear Axle Right Upper Outer	Saloon FWD G6DB		Track Control Arm	S063242
	2005.05-2010.12	Front Axle Left & Right Lower	Saloon FWD G6DB		Ball Joint	S080093
	2005.05-2010.12	Front Axle Left & Right Upper	Saloon FWD G6DB		Ball Joint	S080470
	2005.05-2010.12	Front Axle Left & Right Lower	Saloon FWD G6DB	For OE no.1:545003K000,Quantity:1	Control Arm Bushing	516348
	2005.05-2010.12	Front Axle Left & Right Lower	Saloon FWD G6DB	AT	Control Arm Bushing	530682
	2005.05-2010.12	Front Axle Left & Right Lower	Saloon FWD G6DB	Date from-to:2007.05-2008.01	Control Arm Bushing	530682
	2005.05-2010.12	Front Axle Left & Right Upper	Saloon FWD G6DB		Control Arm Bushing	516338
	2005.05-2010.12	Rear Axle Left & Right Upper	Saloon FWD G6DB	AT	Control Arm Bushing	516012
	2005.05-2010.12	Rear Axle Left & Right Upper	Saloon FWD G6DB	AT	Control Arm Bushing	516171



	 YEAR	FITTING POSITION	BODY STYLE & DRIVE TYPE & ENGINE	REMARKS	PRODUCT	GSP Ref.
HYUNDAI						
Sonata						
3.3 (173 kw)	2005.05-2010.12	Rear Axle Left & Right Lower Outer	Saloon FWD G6DB		Control Arm Bushing	516166
	2005.05-2010.12	Front Axle Left & Right	Saloon FWD G6DB		Tie Rod Axle Joint	S030544
	2005.05-2010.12	Front Axle Left	Saloon FWD G6DB		Tie Rod End	S070219
	2005.05-2010.12	Front Axle Right	Saloon FWD G6DB		Tie Rod End	S070220
	2005.05-2010.12	Front Axle Left & Right	Saloon FWD G6DB		Rod/Strut,stabiliser	S050215
	2005.05-2010.12	Rear Axle Left & Right	Saloon FWD G6DB		Rod/Strut,stabiliser	S050653
	2005.05-2010.12	Front Axle	Saloon FWD G6DB	Date to:2010.02	Stabiliser Bushing	517821
Sonica						
2.0 (96 kw)	2001.06-2005.04	Front Axle Left Upper	Saloon FWD G4JP		Track Control Arm	S060538
	2001.06-2005.04	Front Axle Right Upper	Saloon FWD G4JP		Track Control Arm	S060539
	2001.06-2005.04	Rear Axle Left Upper	Saloon FWD G4JP		Track Control Arm	S061530
	2001.06-2005.04	Rear Axle Right Upper	Saloon FWD G4JP		Track Control Arm	S061531
	2001.06-2005.04	Rear Axle Left & Right Lower	Saloon FWD G4JP	For OE no.5521038000	Track Control Arm	S061695
	2001.06-2005.04	Rear Axle Left & Right Lower	Saloon FWD G4JP	For OE no.5527038000	Track Control Arm	S063066
	2001.06-2005.04	Rear Axle Left & Right Lower Outer	Saloon FWD G4JP		Track Control Arm	S063090
	2001.06-2005.04	Front Axle Left & Right Lower	Saloon FWD G4JP		Ball Joint	S080091
	2001.06-2005.04	Front Axle Left & Right Upper	Saloon FWD G4JP		Ball Joint	S080470
	2001.06-2005.04	Rear Axle Left & Right	Saloon FWD G4JP		Ball Joint	S080098
	2001.06-2005.04	Front Axle Left & Right Lower	Saloon FWD G4JP	Quantity:2	Control Arm Bushing	514314
	2001.06-2005.04	Front Axle Left & Right Lower	Saloon FWD G4JP		Control Arm Bushing	516004
	2001.06-2005.04	Front Axle Left & Right Lower	Saloon FWD G4JP		Control Arm Bushing	516081
	2001.06-2005.04	Front Axle Left & Right Lower	Saloon FWD G4JP	Date from:2004.08	Control Arm Bushing	530682
	2001.06-2005.04	Front Axle Left & Right Upper	Saloon FWD G4JP		Control Arm Bushing	516019
	2001.06-2005.04	Rear Axle Left & Right Lower	Saloon FWD G4JP	for article no.:SCA-3139; for article no.:SCA-3041	Control Arm Bushing	513686
	2001.06-2005.04	Rear Axle Left & Right Lower	Saloon FWD G4JP	Quantity:1	Control Arm Bushing	514980
	2001.06-2005.04	Rear Axle Left & Right Upper	Saloon FWD G4JP	Quantity:2;Type:AT WHEEL CARRIER	Control Arm Bushing	513689
	2001.06-2005.04	Rear Axle Left & Right Upper	Saloon FWD G4JP		Control Arm Bushing	514994
	2001.06-2005.04	Rear Axle Left & Right Upper	Saloon FWD G4JP		Control Arm Bushing	516012
	2001.06-2005.04	Rear Axle Left & Right Upper	Saloon FWD G4JP	Date from:2004.08	Control Arm Bushing	516171
	2001.06-2005.04	Rear Axle Left & Right Upper	Saloon FWD G4JP		Control Arm Bushing	519697
	2001.06-2005.04	Front Axle Left & Right	Saloon FWD G4JP		Tie Rod Axle Joint	S030119
	2001.06-2005.04	Front Axle Left	Saloon FWD G4JP		Tie Rod End	S070215
	2001.06-2005.04	Front Axle Right	Saloon FWD G4JP		Tie Rod End	S070216
	2001.06-2005.04	Front Axle Left & Right	Saloon FWD G4JP		Tie Rod End	S070862
	2001.06-2005.04	Front Axle Left & Right	Saloon FWD G4JP		Rod/Strut,stabiliser	S050204
	2001.06-2005.04	Rear Axle Left & Right	Saloon FWD G4JP		Rod/Strut,stabiliser	S050581
	2001.06-2005.04	Front Axle	Saloon FWD G4JP		Stabiliser Bushing	513683
2.5 (118 kw)	1998.06-2001.05	Front Axle Left Lower	Saloon FWD G6BV		Track Control Arm	S060540
	1998.06-2001.05	Front Axle Left Upper	Saloon FWD G6BV		Track Control Arm	S060538
	1998.06-2001.05	Front Axle Right Lower	Saloon FWD G6BV		Track Control Arm	S060541
	1998.06-2001.05	Front Axle Right Upper	Saloon FWD G6BV		Track Control Arm	S060539
	1998.06-2001.05	Rear Axle Left Upper	Saloon FWD G6BV		Track Control Arm	S061530
	1998.06-2001.05	Rear Axle Right Upper	Saloon FWD G6BV		Track Control Arm	S061531
	1998.06-2001.05	Rear Axle Left & Right Lower	Saloon FWD G6BV		Track Control Arm	S061695
	1998.06-2001.05	Rear Axle Left & Right Lower Outer	Saloon FWD G6BV		Track Control Arm	S063090
	1998.06-2001.05	Front Axle Left & Right Lower	Saloon FWD G6BV		Ball Joint	S080091
	1998.06-2001.05	Front Axle Left & Right Upper	Saloon FWD G6BV		Ball Joint	S080470
	1998.06-2001.05	Rear Axle Left & Right	Saloon FWD G6BV		Ball Joint	S080098
	1998.06-2001.05	Front Axle Left & Right Lower	Saloon FWD G6BV	Quantity:2	Control Arm Bushing	514314
	1998.06-2001.05	Front Axle Left & Right Lower	Saloon FWD G6BV	Date to:1999.11	Control Arm Bushing	514847
	1998.06-2001.05	Front Axle Left & Right Lower	Saloon FWD G6BV		Control Arm Bushing	516004
	1998.06-2001.05	Front Axle Left & Right Lower	Saloon FWD G6BV		Control Arm Bushing	516081
	1998.06-2001.05	Front Axle Left & Right Upper	Saloon FWD G6BV		Control Arm Bushing	516019
	1998.06-2001.05	Rear Axle Left & Right Lower	Saloon FWD G6BV	for article no.:SCA-3139; for article no.:SCA-3041	Control Arm Bushing	513686
	1998.06-2001.05	Rear Axle Left & Right Lower	Saloon FWD G6BV	Quantity:1	Control Arm Bushing	514980
	1998.06-2001.05	Rear Axle Left & Right Upper	Saloon FWD G6BV	Quantity:4;Type:AT WHEEL CARRIER	Control Arm Bushing	513689
	1998.06-2001.05	Rear Axle Left & Right Upper	Saloon FWD G6BV		Control Arm Bushing	514994
	1998.06-2001.05	Rear Axle Left & Right Upper	Saloon FWD G6BV	Date to:2001.06	Control Arm Bushing	516012
	1998.06-2001.05	Front Axle Left & Right	Saloon FWD G6BV		Tie Rod Axle Joint	S030119
	1998.06-2001.05	Front Axle Left	Saloon FWD G6BV		Tie Rod End	S070215
	1998.06-2001.05	Front Axle Right	Saloon FWD G6BV		Tie Rod End	S070216
	1998.06-2001.05	Front Axle Left & Right	Saloon FWD G6BV		Rod/Strut,stabiliser	S050204
	1998.06-2001.05	Rear Axle Left & Right	Saloon FWD G6BV		Rod/Strut,stabiliser	S050205
	1998.06-2001.05	Front Axle	Saloon FWD G6BV		Stabiliser Bushing	513683

	 YEAR	FITTING POSITION	BODY STYLE & DRIVE TYPE & ENGINE	REMARKS	PRODUCT	GSP Ref.
HYUNDAI						
Sonica						
3.3 (173 kw)	2005.05-2009.02	Front Axle Left Lower	Saloon FWD G6DB		Track Control Arm	S061107
	2005.05-2009.02	Front Axle Left Upper	Saloon FWD G6DB		Track Control Arm	S061050
	2005.05-2009.02	Front Axle Right Lower	Saloon FWD G6DB		Track Control Arm	S061108
	2005.05-2009.02	Front Axle Right Upper	Saloon FWD G6DB		Track Control Arm	S061051
	2005.05-2009.02	Rear Axle Left Upper Outer	Saloon FWD G6DB		Track Control Arm	S063239
	2005.05-2009.02	Rear Axle Right Upper Outer	Saloon FWD G6DB		Track Control Arm	S063242
	2005.05-2009.02	Front Axle Left & Right Lower	Saloon FWD G6DB		Ball Joint	S080093
	2005.05-2009.02	Front Axle Left & Right Upper	Saloon FWD G6DB		Ball Joint	S080470
	2005.05-2009.02	Front Axle Left & Right Lower	Saloon FWD G6DB	For OE no.1:545003K000,Quantity:1	Control Arm Bushing	516348
	2005.05-2009.02	Front Axle Left & Right Lower	Saloon FWD G6DB	AT	Control Arm Bushing	530682
	2005.05-2009.02	Front Axle Left & Right Lower	Saloon FWD G6DB	Date from:2007.05-2008.01	Control Arm Bushing	530682
	2005.05-2009.02	Front Axle Left & Right Upper	Saloon FWD G6DB		Control Arm Bushing	516338
	2005.05-2009.02	Rear Axle Left & Right Upper	Saloon FWD G6DB	AT	Control Arm Bushing	516012
	2005.05-2009.02	Rear Axle Left & Right Upper	Saloon FWD G6DB	AT	Control Arm Bushing	516171
	2005.05-2009.02	Rear Axle Left & Right Lower Outer	Saloon FWD G6DB		Control Arm Bushing	516166
	2005.05-2009.02	Front Axle Left & Right	Saloon FWD G6DB		Tie Rod Axle Joint	S030544
	2005.05-2009.02	Front Axle Left	Saloon FWD G6DB		Tie Rod End	S070219
	2005.05-2009.02	Front Axle Right	Saloon FWD G6DB		Tie Rod End	S070220
	2005.05-2009.02	Front Axle Left & Right	Saloon FWD G6DB		Rod/Strut,stabiliser	S050215
	2005.05-2009.02	Rear Axle Left & Right	Saloon FWD G6DB		Rod/Strut,stabiliser	S050653
	2005.05-2009.02	Front Axle	Saloon FWD G6DB	Date to:2010.02	Stabiliser Bushing	517821
Starex						
2.4 (101 kw)	2003.02-2004.04	Front Axle Left & Right Lower	BUS RWD G4JS		Ball Joint	S080085
	2003.02-2004.04	Front Axle Left & Right Lower	BUS RWD G4JS		Control Arm Bushing	516494
	2003.02-2004.04	Rear Axle Left & Right Centre	BUS RWD G4JS		Control Arm Bushing	516539
	2003.02-2004.04	Rear Axle Left & Right Lower	BUS RWD G4JS		Control Arm Bushing	535466
	2003.02-2004.04	Rear Axle Left & Right Upper	BUS RWD G4JS		Control Arm Bushing	516118
	2003.02-2004.04	Front Axle Left & Right	BUS RWD G4JS		Tie Rod Axle Joint	S030620
	2003.02-2004.04	Front Axle Left & Right	BUS RWD G4JS		Rod/Strut,stabiliser	S050209
	2003.02-2004.04	Rear Axle Left & Right	BUS RWD G4JS		Rod/Strut,stabiliser	S050210
2.5 (103 kw)	2002.12-2004.04	Front Axle Left Lower	BUS RWD D4CB		Track Control Arm	S060204
	2002.12-2004.04	Front Axle Left Lower	BUS RWD D4CB		Track Control Arm	S061112
	2002.12-2004.04	Front Axle Left Upper	BUS RWD D4CB		Track Control Arm	S061256
	2002.12-2004.04	Front Axle Right Lower	BUS RWD D4CB		Track Control Arm	S060205
	2002.12-2004.04	Front Axle Right Lower	BUS RWD D4CB		Track Control Arm	S061113
	2002.12-2004.04	Front Axle Right Upper	BUS RWD D4CB		Track Control Arm	S061255
	2002.12-2004.04	Front Axle Left & Right Lower	BUS RWD D4CB		Ball Joint	S080085
	2002.12-2004.04	Front Axle Left & Right Lower	BUS RWD D4CB		Ball Joint	S080455
	2002.12-2004.04	Front Axle Left & Right Upper	BUS RWD D4CB		Ball Joint	S080084
	2002.12-2004.04	Front Axle Left & Right Upper	BUS RWD D4CB		Ball Joint	S080147
	2002.12-2004.04	Front Axle Left & Right Lower	BUS RWD D4CB		Control Arm Bushing	514893
	2002.12-2004.04	Front Axle Left & Right Lower	BUS RWD D4CB		Control Arm Bushing	516494
	2002.12-2004.04	Rear Axle Left & Right Centre	BUS RWD D4CB		Control Arm Bushing	516343
	2002.12-2004.04	Rear Axle Left & Right Centre	BUS RWD D4CB		Control Arm Bushing	516539
	2002.12-2004.04	Rear Axle Left & Right Lower	BUS RWD D4CB		Control Arm Bushing	516344
	2002.12-2004.04	Rear Axle Left & Right Lower	BUS RWD D4CB		Control Arm Bushing	535466
	2002.12-2004.04	Rear Axle Left & Right Upper	BUS RWD D4CB		Control Arm Bushing	516118
	2002.12-2004.04	Rear Axle Left & Right Upper	BUS RWD D4CB		Control Arm Bushing	516329
	2002.12-2004.04	Front Axle Left	BUS RWD D4CB		Tie Rod Axle Joint	S030677
	2002.12-2004.04	Front Axle Right	BUS RWD D4CB		Tie Rod Axle Joint	S030678
	2002.12-2004.04	Front Axle Left	BUS RWD D4CB		Tie Rod End	S071024
	2002.12-2004.04	Front Axle Right	BUS RWD D4CB		Tie Rod End	S071025
	2002.12-2004.04	Front Axle Left & Right	BUS RWD D4CB		Tie Rod End	S070734
	2002.12-2004.04	Front Axle Left & Right	BUS RWD D4CB		Rod/Strut,stabiliser	S050209
	2002.12-2004.04	Rear Axle Left & Right	BUS RWD D4CB		Rod/Strut,stabiliser	S050210
	2002.12-2004.04	Front Axle	BUS RWD D4CB		Stabiliser Bushing	517821
Terracan						
2.5 (74 kw)	2001.06-2003.10	Front Axle Left Lower	SUV 4WD D4BH		Track Control Arm	S061685
	2001.06-2003.10	Front Axle Left Upper	SUV 4WD D4BH		Track Control Arm	S061809
	2001.06-2003.10	Front Axle Right Lower	SUV 4WD D4BH		Track Control Arm	S061686
	2001.06-2003.10	Front Axle Right Upper	SUV 4WD D4BH		Track Control Arm	S061810
	2001.06-2003.10	Front Axle Left & Right Lower	SUV 4WD D4BH		Ball Joint	S080584
	2001.06-2003.10	Front Axle Left & Right Upper	SUV 4WD D4BH		Ball Joint	S080643
	2001.06-2003.10	Front Axle Left & Right Upper	SUV 4WD D4BH		Control Arm Bushing	516015



	 YEAR	FITTING POSITION	BODY STYLE & DRIVE TYPE & ENGINE	REMARKS	PRODUCT	GSP Ref.	
HYUNDAI							
Terracan							
2.5 (74 kw)	2001.06-2003.10	Front Axle Left & Right	SUV 4WD D4BH		Rod Assembly	S100368	
	2001.06-2003.10	Front Axle Left	SUV 4WD D4BH		Rod/Strut,stabiliser	S050666	
	2001.06-2003.10	Front Axle Right	SUV 4WD D4BH		Rod/Strut,stabiliser	S050729	
	2001.06-2003.10	Rear Axle Left & Right	SUV 4WD D4BH		Rod/Strut,stabiliser	S050730	
	2001.06-2003.10	Front Axle	SUV 4WD D4BH		Stabiliser Bushing	517544	
	2001.06-2003.10	Rear Axle	SUV 4WD D4BH		Stabiliser Bushing	517546	
2.9 (120 kw)	2003.08-2007.12	Front Axle Left Lower	SUV 4WD J3(CRDI)		Track Control Arm	S061685	
	2003.08-2007.12	Front Axle Left Upper	SUV 4WD J3(CRDI)		Track Control Arm	S061809	
	2003.08-2007.12	Front Axle Right Lower	SUV 4WD J3(CRDI)		Track Control Arm	S061686	
	2003.08-2007.12	Front Axle Right Upper	SUV 4WD J3(CRDI)		Track Control Arm	S061810	
	2003.08-2007.12	Front Axle Left & Right Lower	SUV 4WD J3(CRDI)		Ball Joint	S080584	
	2003.08-2007.12	Front Axle Left & Right Upper	SUV 4WD J3(CRDI)		Ball Joint	S080643	
	2003.08-2007.12	Front Axle Left & Right Upper	SUV 4WD J3(CRDI)		Control Arm Bushing	516015	
	2003.08-2007.12	Front Axle Left & Right	SUV 4WD J3(CRDI)		Rod Assembly	S100368	
	2003.08-2007.12	Front Axle Left	SUV 4WD J3(CRDI)		Rod/Strut,stabiliser	S050666	
	2003.08-2007.12	Front Axle Right	SUV 4WD J3(CRDI)		Rod/Strut,stabiliser	S050729	
	2003.08-2007.12	Rear Axle Left & Right	SUV 4WD J3(CRDI)		Rod/Strut,stabiliser	S050730	
	2003.08-2007.12	Front Axle	SUV 4WD J3(CRDI)		Stabiliser Bushing	517544	
	2003.08-2007.12	Rear Axle	SUV 4WD J3(CRDI)		Stabiliser Bushing	517546	
	3.5 (147 kw)	2001.07-2006.10	Front Axle Left Upper	SUV 4WD G6CU		Track Control Arm	S061809
2001.07-2006.10		Front Axle Right Upper	SUV 4WD G6CU		Track Control Arm	S061810	
2001.07-2006.10		Front Axle Left & Right Lower	SUV 4WD G6CU		Ball Joint	S080584	
2001.07-2006.10		Front Axle Left & Right Upper	SUV 4WD G6CU		Ball Joint	S080643	
2001.07-2006.10		Front Axle Left & Right Upper	SUV 4WD G6CU		Control Arm Bushing	516015	
2001.07-2006.10		Front Axle Left	SUV 4WD G6CU		Rod/Strut,stabiliser	S050666	
2001.07-2006.10		Front Axle Right	SUV 4WD G6CU		Rod/Strut,stabiliser	S050729	
2001.07-2006.10		Rear Axle Left & Right	SUV 4WD G6CU		Rod/Strut,stabiliser	S050730	
2001.07-2006.10		Front Axle	SUV 4WD G6CU		Stabiliser Bushing	517544	
2001.07-2006.10	Rear Axle	SUV 4WD G6CU		Stabiliser Bushing	517546		
Tucson							
1.6 (130 kw)	2015.06-2020.09	Front Axle Left Lower	SUV FWD G4FJ		Ball Joint	S080986	
	2015.06-2020.09	Front Axle Right Lower	SUV FWD G4FJ		Ball Joint	S080985	
	2015.06-2020.09	Front Axle Left & Right Lower	SUV FWD G4FJ		Control Arm Bushing	514914	
	2015.06-2020.09	Front Axle Left & Right Lower	SUV FWD G4FJ		Control Arm Bushing	535473	
	2015.06-2020.09	Front Axle Left & Right	SUV FWD G4FJ	Equipment Vart.:2WD,ELEC PS RACK	Tie Rod Axle Joint	S031031	
	2015.06-2020.09	Front Axle Left & Right	SUV FWD G4FJ	Equipment Vart.:2WD,ELEC PS COLUMN	Tie Rod Axle Joint	S031035	
	2015.06-2020.09	Front Axle Left & Right	SUV FWD G4FJ		Rod/Strut,stabiliser	S050622	
	2015.06-2020.09	Rear Axle Left & Right	SUV FWD G4FJ		Rod/Strut,stabiliser	S051307	
	2015.06-2020.09	Front Axle	SUV FWD G4FJ		Stabiliser Bushing	535452	
	2015.06-2020.09	Rear Axle	SUV FWD G4FJ		Stabiliser Bushing	535186	
	2.0 (104 kw)	2004.06-2010.03	Front Axle Left Lower	SUV 4WD G4GC		Track Control Arm	S060835
		2004.06-2010.03	Front Axle Left Lower	SUV FWD G4GC		Track Control Arm	S060835
2004.06-2010.03		Front Axle Right Lower	SUV 4WD G4GC		Track Control Arm	S060836	
2004.06-2010.03		Front Axle Right Lower	SUV FWD G4GC		Track Control Arm	S060836	
2004.06-2010.03		Rear Axle Left & Right Lower Inner	SUV FWD G4GC		Track Control Arm	S062191	
2004.06-2010.03		Rear Axle Left & Right Lower Inner	SUV FWD G4GC	Date from:2007.12	Track Control Arm	S063124	
2004.06-2010.03		Rear Axle Left & Right Lower Outer	SUV 4WD G4GC	For OE no.55220-2E500	Track Control Arm	S061708	
2004.06-2010.03		Front Axle Left & Right Lower	SUV 4WD G4GC		Ball Joint	S080092	
2004.06-2010.03		Front Axle Left & Right Lower	SUV FWD G4GC		Ball Joint	S080092	
2004.06-2010.03		Front Axle Left & Right Lower	SUV 4WD G4GC		Control Arm Bushing	513688	
2004.06-2010.03		Front Axle Left & Right Lower	SUV FWD G4GC		Control Arm Bushing	513688	
2004.06-2010.03		Rear Axle Right Centre	SUV 4WD G4GC		Control Arm Bushing	530810	
2004.06-2010.03		Rear Axle Right Centre	SUV FWD G4GC		Control Arm Bushing	530810	
2004.06-2010.03		Rear Axle Left & Right Centre	SUV 4WD G4GC		Control Arm Bushing	530811	
2004.06-2010.03		Rear Axle Left & Right Centre	SUV FWD G4GC		Control Arm Bushing	530811	
2004.06-2010.03		Rear Axle Left & Right Upper	SUV 4WD G4GC		Control Arm Bushing	530816	
2004.06-2010.03		Rear Axle Left & Right Lower Outer	SUV 4WD G4GC		Control Arm Bushing	516149	
2004.06-2010.03		Rear Axle Left & Right Lower Outer	SUV FWD G4GC		Control Arm Bushing	516149	
2004.06-2010.03		Rear Axle Left & Right Lower Outer	SUV 4WD G4GC		Control Arm Bushing	516180	
2004.06-2010.03		Rear Axle Left & Right Lower Outer	SUV FWD G4GC		Control Arm Bushing	516180	
2004.06-2010.03		Rear Axle Left & Right Lower Outer	SUV 4WD G4GC		Control Arm Bushing	516232	
2004.06-2010.03		Rear Axle Left & Right Lower Outer	SUV FWD G4GC		Control Arm Bushing	516232	
2004.06-2010.03		Rear Axle Left & Right Lower Outer	SUV 4WD G4GC		Control Arm Bushing	530814	
2004.06-2010.03		Front Axle Left & Right	SUV 4WD G4GC		Tie Rod Axle Joint	S030127	



	 YEAR	FITTING POSITION	BODY STYLE & DRIVE TYPE & ENGINE	REMARKS	PRODUCT	GSP Ref.
HYUNDAI						
Tucson						
2.0 (104 kw)	2004.06-2010.03	Front Axle Left & Right	SUV FWD G4GC		Tie Rod Axle Joint	S030127
	2004.06-2010.03	Front Axle Left	SUV 4WD G4GC		Tie Rod End	S070218
	2004.06-2010.03	Front Axle Left	SUV FWD G4GC		Tie Rod End	S070218
	2004.06-2010.03	Front Axle Right	SUV 4WD G4GC		Tie Rod End	S070217
	2004.06-2010.03	Front Axle Right	SUV FWD G4GC		Tie Rod End	S070217
	2004.06-2010.03	Front Axle Left & Right	SUV 4WD G4GC		Rod/Strut,stabiliser	S050208
	2004.06-2010.03	Front Axle Left & Right	SUV FWD G4GC		Rod/Strut,stabiliser	S050208
	2004.06-2010.03	Front Axle Left & Right	SUV 4WD G4GC		Rod/Strut,stabiliser	S050592
	2004.06-2010.03	Front Axle Left & Right	SUV FWD G4GC		Rod/Strut,stabiliser	S050592
	2004.06-2010.03	Rear Axle Left & Right	SUV 4WD G4GC		Rod/Strut,stabiliser	S050207
	2004.06-2010.03	Rear Axle Left & Right	SUV FWD G4GC		Rod/Strut,stabiliser	S050207
	2004.06-2010.03	Rear Axle	SUV 4WD G4GC	Date from:2006.10	Stabiliser Bushing	517320
	2004.06-2010.03	Front Axle	SUV 4WD G4GC		Steering Boot	540420
	2004.06-2010.03	Front Axle	SUV FWD G4GC		Steering Boot	540420
	2004.06-2010.03	Front Axle	SUV 4WD G4GC		Steering Rack Bellow Kit	540420S
	2004.06-2010.03	Front Axle	SUV FWD G4GC		Steering Rack Bellow Kit	540420S
2.0 (105 kw)	2010.01-2012.08	Rear Axle Left & Right Lower Inner	SUV FWD G4GC		Track Control Arm	S062191
	2010.01-2012.08	Rear Axle Left & Right Lower Inner	SUV FWD G4GC		Track Control Arm	S063124
	2010.01-2012.08	Front Axle Left & Right Lower	SUV FWD G4GC		Control Arm Bushing	513688
	2010.01-2012.08	Rear Axle Right Centre	SUV FWD G4GC		Control Arm Bushing	530810
	2010.01-2012.08	Rear Axle Left & Right Centre	SUV FWD G4GC		Control Arm Bushing	530811
	2010.01-2012.08	Rear Axle Left & Right Lower Outer	SUV FWD G4GC		Control Arm Bushing	516232
	2010.01-2012.08	Front Axle Left & Right	SUV FWD G4GC		Rod/Strut,stabiliser	S050592
	2010.01-2012.08	Front Axle	SUV FWD G4GC		Steering Boot	540420
2.7 (129 kw)	2004.08-2010.11	Front Axle Left Lower	SUV 4WD G6BA		Track Control Arm	S060835
	2004.08-2010.11	Front Axle Right Lower	SUV 4WD G6BA		Track Control Arm	S060836
	2004.08-2010.11	Front Axle Left & Right Lower	SUV 4WD G6BA		Ball Joint	S080092
	2004.08-2010.11	Front Axle Left & Right Lower	SUV 4WD G6BA		Control Arm Bushing	513688
	2004.08-2010.11	Rear Axle Left & Right Lower Outer	SUV 4WD G6BA		Control Arm Bushing	516149
	2004.08-2010.11	Rear Axle Left & Right Lower Outer	SUV 4WD G6BA		Control Arm Bushing	516180
	2004.08-2010.11	Front Axle Left & Right	SUV 4WD G6BA		Tie Rod Axle Joint	S030127
	2004.08-2010.11	Front Axle Left	SUV 4WD G6BA		Tie Rod End	S070218
	2004.08-2010.11	Front Axle Right	SUV 4WD G6BA		Tie Rod End	S070217
	2004.08-2010.11	Front Axle Left & Right	SUV 4WD G6BA		Rod/Strut,stabiliser	S050208
	2004.08-2010.11	Rear Axle Left & Right	SUV 4WD G6BA		Rod/Strut,stabiliser	S050207
	2004.08-2010.11	Rear Axle	SUV 4WD G6BA	Date from-to:2006.10-2010.03	Stabiliser Bushing	517320
	2004.08-2010.11	Front Axle	SUV 4WD G6BA		Steering Boot	540420
	2004.08-2010.11	Front Axle	SUV 4WD G6BA		Steering Rack Bellow Kit	540420S
Veloster						
1.6 (94 kw)	2011.06-2017.12	Front Axle Left & Right Lower	Coupe FWD G4FC		Control Arm Bushing	530529
Veracruz						
3.8 (191 kw)	2007.01-2012.11	Front Axle Left Lower	SUV 4WD G6DA		Track Control Arm	S061805
	2007.01-2012.11	Front Axle Right Lower	SUV 4WD G6DA		Track Control Arm	S061806
	2007.01-2012.11	Front Axle Left & Right Lower	SUV 4WD G6DA		Ball Joint	S080455
	2007.01-2012.11	Rear Axle Left & Right Upper	SUV 4WD G6DA		Control Arm Bushing	516171
	2007.01-2012.11	Rear Axle Left & Right Lower Inner	SUV 4WD G6DA	AT,Date to:2013.04	Control Arm Bushing	516145
	2007.01-2012.11	Rear Axle Left & Right Lower Outer	SUV 4WD G6DA		Control Arm Bushing	516172
	2007.01-2012.11	Front Axle Left & Right	SUV 4WD G6DA		Tie Rod Axle Joint	S030717
	2007.01-2012.11	Front Axle Left	SUV 4WD G6DA		Tie Rod End	S070223
	2007.01-2012.11	Front Axle Right	SUV 4WD G6DA		Tie Rod End	S070224
	2007.01-2012.11	Front Axle Left	SUV 4WD G6DA		Rod/Strut,stabiliser	S050216
	2007.01-2012.11	Front Axle Right	SUV 4WD G6DA		Rod/Strut,stabiliser	S050217
	2007.01-2012.11	Rear Axle Left & Right	SUV 4WD G6DA		Rod/Strut,stabiliser	S050218
3.8 (199 kw)	2008.01-2012.11	Front Axle Left & Right Lower	SUV 4WD G6DA		Ball Joint	S080455
	2008.01-2012.11	Rear Axle Left & Right Upper	SUV 4WD G6DA		Control Arm Bushing	516171
	2008.01-2012.11	Rear Axle Left & Right Lower Inner	SUV 4WD G6DA	Type:AT WHEEL CARRIER	Control Arm Bushing	516145
	2008.01-2012.11	Rear Axle Left & Right Lower Outer	SUV 4WD G6DA		Control Arm Bushing	516172
	2008.01-2012.11	Front Axle Left	SUV 4WD G6DA		Tie Rod End	S070223
	2008.01-2012.11	Front Axle Right	SUV 4WD G6DA		Tie Rod End	S070224
	2008.01-2012.11	Front Axle Left	SUV 4WD G6DA		Rod/Strut,stabiliser	S050216
	2008.01-2012.11	Front Axle Right	SUV 4WD G6DA		Rod/Strut,stabiliser	S050217
	2008.01-2012.11	Rear Axle Left & Right	SUV 4WD G6DA		Rod/Strut,stabiliser	S050218

	 YEAR	FITTING POSITION	BODY STYLE & DRIVE TYPE & ENGINE	REMARKS	PRODUCT	GSP Ref.
INFINITI EX35						
3.5 (221 kw)	2008.10-2010.12	Front Axle Left & Right Lower	SUV 4WD VQ35HR		Control Arm Bushing	516550
	2008.10-2010.12	Front Axle Left & Right Upper	SUV 4WD VQ35HR		Control Arm Bushing	516108
	2008.10-2010.12	Rear Axle Left & Right Upper	SUV 4WD VQ35HR		Control Arm Bushing	516230
	2008.10-2010.12	Rear Axle Left & Right Lower Outer	SUV 4WD VQ35HR	AT,Date from-to:2009.03-2012.07	Control Arm Bushing	516100
	2008.10-2010.12	Rear Axle Left & Right Lower Outer	SUV 4WD VQ35HR		Control Arm Bushing	516541
	2008.10-2010.12	Front Axle Left	SUV 4WD VQ35HR		Tie Rod End	S071672
	2008.10-2010.12	Front Axle Right	SUV 4WD VQ35HR		Tie Rod End	S071279
	2008.10-2010.12	Rear Axle Left	SUV 4WD VQ35HR		Rod/Strut,stabiliser	S051245
	2008.10-2010.12	Rear Axle Right	SUV 4WD VQ35HR		Rod/Strut,stabiliser	S050726
FX35						
3.5 (205 kw)	2008.07-2009.05	Front Axle Left & Right Upper	SUV 4WD VQ35HR		Control Arm Bushing	516108
	2008.07-2009.05	Front Axle Left & Right Upper	SUV RWD VQ35HR		Control Arm Bushing	516108
	2008.07-2009.05	Rear Axle Left & Right Lower Outer	SUV 4WD VQ35HR		Control Arm Bushing	516541
	2008.07-2009.05	Rear Axle Left & Right Lower Outer	SUV RWD VQ35HR		Control Arm Bushing	516541
	2008.07-2009.05	Front Axle Left	SUV 4WD VQ35HR		Rod/Strut,stabiliser	S050964
	2008.07-2009.05	Front Axle Left	SUV RWD VQ35HR		Rod/Strut,stabiliser	S050964
	2008.07-2009.05	Front Axle Right	SUV 4WD VQ35HR		Rod/Strut,stabiliser	S050965
	2008.07-2009.05	Front Axle Right	SUV RWD VQ35HR		Rod/Strut,stabiliser	S050965
	2008.07-2009.05	Rear Axle Left	SUV 4WD VQ35HR		Rod/Strut,stabiliser	S050958
	2008.07-2009.05	Rear Axle Left	SUV RWD VQ35HR		Rod/Strut,stabiliser	S050958
	2008.07-2009.05	Rear Axle Right	SUV 4WD VQ35HR		Rod/Strut,stabiliser	S050959
	2008.07-2009.05	Rear Axle Right	SUV RWD VQ35HR		Rod/Strut,stabiliser	S050959
3.5 (206 kw)	2003.01-2008.12	Front Axle Left Lower	SUV 4WD VQ35DE		Track Control Arm	S061780
	2003.01-2008.12	Front Axle Right Lower	SUV 4WD VQ35DE		Track Control Arm	S061781
	2003.01-2008.12	Front Axle Left & Right Lower	SUV 4WD VQ35DE	AT	Control Arm Bushing	516233
	2003.01-2008.12	Front Axle Left & Right Lower	SUV 4WD VQ35DE	AT	Control Arm Bushing	516242
	2003.01-2008.12	Rear Axle Left & Right Upper	SUV 4WD VQ35DE		Control Arm Bushing	516174
	2003.01-2008.12	Rear Axle Left & Right Upper	SUV 4WD VQ35DE	AT,Date to:2004.08	Control Arm Bushing	516617
	2003.01-2008.12	Rear Axle Left & Right Lower Centre	SUV 4WD VQ35DE		Control Arm Bushing	516237
	2003.01-2008.12	Rear Axle Left & Right Lower Inner	SUV 4WD VQ35DE	AT	Control Arm Bushing	516234
	2003.01-2008.12	Rear Axle Left & Right Lower Outer	SUV 4WD VQ35DE		Control Arm Bushing	516236
	2003.01-2008.12	Front Axle Left & Right	SUV 4WD VQ35DE		Tie Rod Axle Joint	S030912
	2003.01-2008.12	Front Axle Left	SUV 4WD VQ35DE		Tie Rod End	S071099
	2003.01-2008.12	Front Axle Right	SUV 4WD VQ35DE		Tie Rod End	S071098
	2003.01-2008.12	Rear Axle Left	SUV 4WD VQ35DE		Rod/Strut,stabiliser	S050984
	2003.01-2008.12	Rear Axle Right	SUV 4WD VQ35DE		Rod/Strut,stabiliser	S050985
	2003.01-2008.12	Front Axle	SUV 4WD VQ35DE		Stabiliser Bushing	517306
	2003.01-2008.12	Rear Axle	SUV 4WD VQ35DE		Stabiliser Bushing	516828
3.5 (226 kw)	2009.09-2013.07	Front Axle Left & Right Upper	SUV 4WD VQ35HR		Control Arm Bushing	516108
	2009.09-2013.07	Rear Axle Left & Right Lower Outer	SUV 4WD VQ35HR		Control Arm Bushing	516541
	2009.09-2013.07	Front Axle Left	SUV 4WD VQ35HR		Tie Rod End	S071099
	2009.09-2013.07	Front Axle Right	SUV 4WD VQ35HR		Tie Rod End	S071098
	2009.09-2013.07	Front Axle Left	SUV 4WD VQ35HR		Rod/Strut,stabiliser	S050964
	2009.09-2013.07	Front Axle Right	SUV 4WD VQ35HR		Rod/Strut,stabiliser	S050965
	2009.09-2013.07	Rear Axle Left	SUV 4WD VQ35HR		Rod/Strut,stabiliser	S050958
	2009.09-2013.07	Rear Axle Right	SUV 4WD VQ35HR		Rod/Strut,stabiliser	S050959
IVECO Daily						
2.8 (76 kw)	2000.06-2007.05	Front Axle Left Upper	VAN RWD 8140.23		Track Control Arm	S063181
	2000.06-2007.05	Front Axle Right Upper	VAN RWD 8140.23		Track Control Arm	S063180
Daily 35C13						
2.8 (92 kw)	1999.07-2006.12	Front Axle Left Upper	VAN RWD 814043S		Track Control Arm	S063181
	1999.07-2006.12	Front Axle Right Upper	VAN RWD 814043S		Track Control Arm	S063180
	1999.07-2006.12	Front Axle Left & Right Lower	VAN RWD 814043S		Ball Joint	S080862
	1999.07-2006.12	Front Axle Left & Right	VAN RWD 814043S		Tie Rod End	S070565
	1999.07-2006.12	Front Axle Left & Right	VAN RWD 814043S		Tie Rod End	S070996
	1999.07-2006.12	Front Axle Right	VAN RWD 814043S		Rod/Strut,stabiliser	S051377
	1999.07-2006.12	Rear Axle Left & Right	VAN RWD 814043S		Rod/Strut,stabiliser	S051379
	1999.07-2006.12	Rear Axle	VAN RWD 814043S		Stabiliser Bushing	517578
	1999.07-2006.12	Rear Axle	VAN RWD 814043S		Stabiliser Bushing	517586
	1999.07-2006.12	Rear Axle	VAN RWD 814043S		Stabiliser Bushing	517587
	1999.07-2006.12	Rear Axle	VAN RWD 814043S		Stabiliser Bushing	517600
	1999.07-2006.12	Front Axle	VAN RWD 814043S		Steering Boot	540345
	1999.07-2006.12	Front Axle	VAN RWD 814043S		Steering Rack Bellow Kit	540345S



	 YEAR	FITTING POSITION	BODY STYLE & DRIVE TYPE & ENGINE	REMARKS	PRODUCT	GSP Ref.
IVECO						
Daily 35C13P						
2.8 (92 kw)	1999.07-2006.12	Front Axle Left Upper	VAN RWD 814043S		Track Control Arm	S063181
	1999.07-2006.12	Front Axle Right Upper	VAN RWD 814043S		Track Control Arm	S063180
	1999.07-2006.12	Front Axle Left & Right Lower	VAN RWD 814043S		Ball Joint	S080862
	1999.07-2006.12	Front Axle Left & Right	VAN RWD 814043S		Tie Rod End	S070565
	1999.07-2006.12	Front Axle Left & Right	VAN RWD 814043S		Tie Rod End	S070996
	1999.07-2006.12	Front Axle Right	VAN RWD 814043S		Rod/Strut, stabiliser	S051377
	1999.07-2006.12	Rear Axle Left & Right	VAN RWD 814043S		Rod/Strut, stabiliser	S051379
	1999.07-2006.12	Rear Axle	VAN RWD 814043S		Stabiliser Bushing	517578
	1999.07-2006.12	Rear Axle	VAN RWD 814043S		Stabiliser Bushing	517586
	1999.07-2006.12	Rear Axle	VAN RWD 814043S		Stabiliser Bushing	517587
	1999.07-2006.12	Rear Axle	VAN RWD 814043S		Stabiliser Bushing	517600
	1999.07-2006.12	Front Axle	VAN RWD 814043S		Steering Boot	540345
	1999.07-2006.12	Front Axle	VAN RWD 814043S		Steering Rack Bellow Kit	540345S
Daily 35C14						
3.0 (103 kw)	2009.09-2011.08	Front Axle Left Upper	Platform/Chassis RWD F1CE3481L		Track Control Arm	S063181
	2009.09-2011.08	Front Axle Right Upper	Platform/Chassis RWD F1CE3481L		Track Control Arm	S063180
	2009.09-2011.08	Front Axle Left & Right	Platform/Chassis RWD F1CE3481L		Tie Rod Axle Joint	S030593
	2009.09-2011.08	Front Axle Left & Right	Platform/Chassis RWD F1CE3481L	Alt. Version: 1 for vehicles with torsion bar suspension	Tie Rod End	S070565
	2009.09-2011.08	Front Axle Left & Right	Platform/Chassis RWD F1CE3481L		Tie Rod End	S070996
	2009.09-2011.08	Rear Axle	Platform/Chassis RWD F1CE3481L		Stabiliser Bushing	517578
	2009.09-2011.08	Rear Axle	Platform/Chassis RWD F1CE3481L		Stabiliser Bushing	517586
	2009.09-2011.08	Front Axle	Platform/Chassis RWD F1CE3481L		Steering Boot	540345
	2009.09-2011.08	Front Axle	Platform/Chassis RWD F1CE3481L		Steering Rack Bellow Kit	540345S
Daily 35C14P						
3.0 (103 kw)	2009.09-2011.08	Front Axle Left Upper	Platform/Chassis RWD F1CE3481L		Track Control Arm	S063181
	2009.09-2011.08	Front Axle Right Upper	Platform/Chassis RWD F1CE3481L		Track Control Arm	S063180
	2009.09-2011.08	Front Axle Left & Right	Platform/Chassis RWD F1CE3481L		Tie Rod Axle Joint	S030593
	2009.09-2011.08	Front Axle Left & Right	Platform/Chassis RWD F1CE3481L	Alt. Version: 1 for vehicles with torsion bar suspension	Tie Rod End	S070565
	2009.09-2011.08	Front Axle Left & Right	Platform/Chassis RWD F1CE3481L		Tie Rod End	S070996
	2009.09-2011.08	Rear Axle	Platform/Chassis RWD F1CE3481L		Stabiliser Bushing	517578
	2009.09-2011.08	Rear Axle	Platform/Chassis RWD F1CE3481L		Stabiliser Bushing	517586
	2009.09-2011.08	Front Axle	Platform/Chassis RWD F1CE3481L		Steering Boot	540345
	2009.09-2011.08	Front Axle	Platform/Chassis RWD F1CE3481L		Steering Rack Bellow Kit	540345S
Daily 35C17						
3.0 (125 kw)	2011.09-2014.02	Front Axle Left Upper	VAN RWD F1CE3481C/F1CE3481K		Track Control Arm	S063181
	2011.09-2014.02	Front Axle Right Upper	VAN RWD F1CE3481C/F1CE3481K		Track Control Arm	S063180
	2011.09-2014.02	Front Axle Left & Right	VAN RWD F1CE3481C/F1CE3481K	Alt. Version: 1 for vehicles with torsion bar suspension	Tie Rod End	S070565
	2011.09-2014.02	Front Axle Left & Right	VAN RWD F1CE3481C/F1CE3481K		Tie Rod End	S070996
	2011.09-2014.02	Rear Axle	VAN RWD F1CE3481C/F1CE3481K		Stabiliser Bushing	517578
	2011.09-2014.02	Rear Axle	VAN RWD F1CE3481C/F1CE3481K		Stabiliser Bushing	517586
	2011.09-2014.02	Front Axle	VAN RWD F1CE3481C/F1CE3481K		Steering Boot	540345
	2011.09-2014.02	Front Axle	VAN RWD F1CE3481C/F1CE3481K		Steering Rack Bellow Kit	540345S
Daily 35S13						
2.8 (92 kw)	1999.07-2006.12	Front Axle Left Upper	VAN RWD 814043S		Track Control Arm	S063181
	1999.07-2006.12	Front Axle Right Upper	VAN RWD 814043S		Track Control Arm	S063180
	1999.07-2006.12	Front Axle Left & Right Lower	VAN RWD 814043S		Ball Joint	S080862
	1999.07-2006.12	Front Axle Left & Right	VAN RWD 814043S		Tie Rod End	S070565
	1999.07-2006.12	Front Axle Left & Right	VAN RWD 814043S		Tie Rod End	S070996
	1999.07-2006.12	Front Axle Right	VAN RWD 814043S		Rod/Strut, stabiliser	S051377
	1999.07-2006.12	Rear Axle Left & Right	VAN RWD 814043S		Rod/Strut, stabiliser	S051379
	1999.07-2006.12	Rear Axle	VAN RWD 814043S		Stabiliser Bushing	517578
	1999.07-2006.12	Rear Axle	VAN RWD 814043S		Stabiliser Bushing	517586
	1999.07-2006.12	Rear Axle	VAN RWD 814043S		Stabiliser Bushing	517587
	1999.07-2006.12	Rear Axle	VAN RWD 814043S		Stabiliser Bushing	517600
	1999.07-2006.12	Front Axle	VAN RWD 814043S		Steering Boot	540345
	1999.07-2006.12	Front Axle	VAN RWD 814043S		Steering Rack Bellow Kit	540345S
Daily 35S13P						
2.8 (92 kw)	1999.07-2006.12	Front Axle Left Upper	VAN RWD 814043S		Track Control Arm	S063181
	1999.07-2006.12	Front Axle Right Upper	VAN RWD 814043S		Track Control Arm	S063180
	1999.07-2006.12	Front Axle Left & Right Lower	VAN RWD 814043S		Ball Joint	S080862
	1999.07-2006.12	Front Axle Left & Right	VAN RWD 814043S		Tie Rod End	S070565
	1999.07-2006.12	Front Axle Left & Right	VAN RWD 814043S		Tie Rod End	S070996
	1999.07-2006.12	Front Axle Right	VAN RWD 814043S		Rod/Strut, stabiliser	S051377
	1999.07-2006.12	Rear Axle Left & Right	VAN RWD 814043S		Rod/Strut, stabiliser	S051379



 YEAR	FITTING POSITION	BODY STYLE & DRIVE TYPE & ENGINE	REMARKS	PRODUCT	GSP Ref.
IVECO					
Daily 35S13P					
2.8 (92 kw)	1999.07-2006.12	Rear Axle	VAN RWD 814043S		Stabiliser Bushing 517578
	1999.07-2006.12	Rear Axle	VAN RWD 814043S		Stabiliser Bushing 517586
	1999.07-2006.12	Rear Axle	VAN RWD 814043S		Stabiliser Bushing 517587
	1999.07-2006.12	Rear Axle	VAN RWD 814043S		Stabiliser Bushing 517600
	1999.07-2006.12	Front Axle	VAN RWD 814043S		Steering Boot 540345
	1999.07-2006.12	Front Axle	VAN RWD 814043S		Steering Rack Bellow Kit 540345S
Daily 35S14					
3.0 (100 kw)	2007.08-2012.03	Front Axle Left Upper	VAN RWD F1CE0481A		Track Control Arm S063181
	2007.08-2012.03	Front Axle Right Upper	VAN RWD F1CE0481A		Track Control Arm S063180
3.0 (103 kw)	2009.09-2011.08	Front Axle Left Upper	Platform/Chassis RWD F1CE3481L		Track Control Arm S063181
	2009.09-2011.08	Front Axle Right Upper	Platform/Chassis RWD F1CE3481L		Track Control Arm S063180
	2009.09-2011.08	Front Axle Left & Right	Platform/Chassis RWD F1CE3481L		Tie Rod Axle Joint S030593
	2009.09-2011.08	Front Axle Left & Right	Platform/Chassis RWD F1CE3481L	Alt. Version: 1 for vehicles with torsion bar suspension	Tie Rod End S070565
	2009.09-2011.08	Front Axle Left & Right	Platform/Chassis RWD F1CE3481L		Tie Rod End S070996
	2009.09-2011.08	Rear Axle	Platform/Chassis RWD F1CE3481L		Stabiliser Bushing 517578
	2009.09-2011.08	Rear Axle	Platform/Chassis RWD F1CE3481L		Stabiliser Bushing 517586
	2009.09-2011.08	Front Axle	Platform/Chassis RWD F1CE3481L		Steering Boot 540345
	2009.09-2011.08	Front Axle	Platform/Chassis RWD F1CE3481L		Steering Rack Bellow Kit 540345S
3.0 (110 kw)	2012.04-2014.02	Front Axle Left Upper	VAN RWD F1CE3481L		Track Control Arm S063181
	2012.04-2014.02	Front Axle Right Upper	VAN RWD F1CE3481L		Track Control Arm S063180
Daily 35S14P					
3.0 (103 kw)	2009.09-2011.08	Front Axle Left Upper	Platform/Chassis RWD F1CE3481L		Track Control Arm S063181
	2009.09-2011.08	Front Axle Right Upper	Platform/Chassis RWD F1CE3481L		Track Control Arm S063180
	2009.09-2011.08	Front Axle Left & Right	Platform/Chassis RWD F1CE3481L		Tie Rod Axle Joint S030593
	2009.09-2011.08	Front Axle Left & Right	Platform/Chassis RWD F1CE3481L	Alt. Version: 1 for vehicles with torsion bar suspension	Tie Rod End S070565
	2009.09-2011.08	Front Axle Left & Right	Platform/Chassis RWD F1CE3481L		Tie Rod End S070996
	2009.09-2011.08	Rear Axle	Platform/Chassis RWD F1CE3481L		Stabiliser Bushing 517578
	2009.09-2011.08	Rear Axle	Platform/Chassis RWD F1CE3481L		Stabiliser Bushing 517586
	2009.09-2011.08	Front Axle	Platform/Chassis RWD F1CE3481L		Steering Boot 540345
	2009.09-2011.08	Front Axle	Platform/Chassis RWD F1CE3481L		Steering Rack Bellow Kit 540345S
JAGUAR					
E-Pace					
2.0 (183 kw)	2017.09-	Front Axle Left	SUV 4WD PT204		Tie Rod End S071689
	2017.09-	Front Axle Right	SUV 4WD PT204		Tie Rod End S071690
	2017.09-	Rear Axle Left	SUV 4WD PT204		Rod/Strut, stabiliser S051478
	2017.09-	Rear Axle Right	SUV 4WD PT204		Rod/Strut, stabiliser S051480
	2017.11-	Rear Axle Left	SUV 4WD PT204		Rod/Strut, stabiliser S051478
	2017.11-	Rear Axle Right	SUV 4WD PT204		Rod/Strut, stabiliser S051480
2.0 (221 kw)	2017.09-	Front Axle Left	SUV 4WD PT204		Tie Rod End S071689
	2017.09-	Front Axle Right	SUV 4WD PT204		Tie Rod End S071690
	2017.09-	Rear Axle Left	SUV 4WD PT204		Rod/Strut, stabiliser S051478
	2017.09-	Rear Axle Right	SUV 4WD PT204		Rod/Strut, stabiliser S051480
F-Pace					
2.0 (132 kw)	2015.09-	Front Axle Left & Right	SUV 4WD 204DTD		Tie Rod End S071819
2.0 (184 kw)	2017.02-	Front Axle Left & Right	SUV 4WD PT204		Tie Rod End S071819
3.0 (250 kw)	2015.09-	Front Axle Left & Right	SUV 4WD 306PS		Tie Rod End S071819
3.0 (280 kw)	2015.09-	Front Axle Left & Right	SUV 4WD 306PS		Tie Rod End S071819
F-Type					
2.0 (221 kw)	2017.01-	Rear Axle Left & Right	Cabriolet RWD PT204		Rod Assembly S100430
	2017.01-	Rear Axle Left	Cabriolet RWD PT204		Rod/Strut, stabiliser S050843
	2017.01-	Rear Axle Right	Cabriolet RWD PT204		Rod/Strut, stabiliser S050844
	2017.07-	Rear Axle Left & Right	Coupe RWD PT204		Rod Assembly S100430
	2017.07-	Rear Axle Left	Coupe RWD PT204		Rod/Strut, stabiliser S050843
	2017.07-	Rear Axle Right	Coupe RWD PT204		Rod/Strut, stabiliser S050844
	3.0 (250 kw)	2012.10-	Rear Axle Left	Cabriolet RWD 306PS	
2012.10-		Rear Axle Right	Cabriolet RWD 306PS		Rod/Strut, stabiliser S050844
2013.10-		Rear Axle Left	Coupe RWD 306PS		Rod/Strut, stabiliser S050843
2013.10-		Rear Axle Right	Coupe RWD 306PS		Rod/Strut, stabiliser S050844
3.0 (280 kw)	2012.10-	Rear Axle Left	Cabriolet RWD 306PS		Rod/Strut, stabiliser S050843
	2012.10-	Rear Axle Right	Cabriolet RWD 306PS		Rod/Strut, stabiliser S050844
	2013.10-	Rear Axle Left	Coupe RWD 306PS		Rod/Strut, stabiliser S050843
	2013.10-	Rear Axle Right	Coupe RWD 306PS		Rod/Strut, stabiliser S050844
5.0 (364 kw)	2012.10-	Rear Axle Left	Cabriolet RWD 508PS		Rod/Strut, stabiliser S050843
	2012.10-	Rear Axle Right	Cabriolet RWD 508PS		Rod/Strut, stabiliser S050844



	 YEAR	FITTING POSITION	BODY STYLE & DRIVE TYPE & ENGINE	REMARKS	PRODUCT	GSP Ref.
JAGUAR						
F-Type						
5.0 (405 kw)	2013.10-	Rear Axle Left & Right	Coupe RWD 508PS		Rod Assembly	S100430
	2013.10-	Rear Axle Left & Right	Cabriolet RWD 508PS		Rod Assembly	S100430
	2013.10-	Rear Axle Left	Coupe RWD 508PS		Rod/Strut,stabiliser	S050843
	2013.10-	Rear Axle Left	Cabriolet RWD 508PS		Rod/Strut,stabiliser	S050843
	2013.10-	Rear Axle Right	Coupe RWD 508PS		Rod/Strut,stabiliser	S050844
	2013.10-	Rear Axle Right	Cabriolet RWD 508PS		Rod/Strut,stabiliser	S050844
	2014.12-	Rear Axle Left & Right	Coupe 4WD 508PS		Rod Assembly	S100430
	2014.12-	Rear Axle Left	Coupe 4WD 508PS		Rod/Strut,stabiliser	S050843
	2014.12-	Rear Axle Right	Coupe 4WD 508PS		Rod/Strut,stabiliser	S050844
5.0 (423 kw)	2015.12-	Rear Axle Left & Right	Cabriolet 4WD 508PS/AJ133G2		Rod Assembly	S100430
	2015.12-	Rear Axle Left & Right	Coupe 4WD 508PS/AJ133G2		Rod Assembly	S100430
	2015.12-	Rear Axle Left	Cabriolet 4WD 508PS/AJ133G2		Rod/Strut,stabiliser	S050843
	2015.12-	Rear Axle Left	Coupe 4WD 508PS/AJ133G2		Rod/Strut,stabiliser	S050843
	2015.12-	Rear Axle Right	Cabriolet 4WD 508PS/AJ133G2		Rod/Strut,stabiliser	S050844
	2015.12-	Rear Axle Right	Coupe 4WD 508PS/AJ133G2		Rod/Strut,stabiliser	S050844
I-Pace						
ET (294 kw)	2018.02-	Front Axle Left & Right	SUV 4WD QG		Tie Rod End	S071819
S-Type						
3.0 (175 kw)	1998.10-2008.07	Front Axle Left Upper	Saloon RWD XR8	Chassis no. to:M45254	Track Control Arm	S061621
	1998.10-2008.07	Front Axle Left Upper	Saloon RWD XR8	Chassis no.from:M45255	Track Control Arm	S061623
	1998.10-2008.07	Front Axle Left Lower Inner	Saloon RWD XR8		Track Control Arm	S062758
	1998.10-2008.07	Front Axle Right Upper	Saloon RWD XR8	Chassis no. to:M45254	Track Control Arm	S061622
	1998.10-2008.07	Front Axle Right Upper	Saloon RWD XR8	Chassis no.from:M45255	Track Control Arm	S061624
	1998.10-2008.07	Front Axle Right Lower Inner	Saloon RWD XR8		Track Control Arm	S062759
	1998.10-2008.07	Front Axle Left & Right Lower	Saloon RWD XR8		Ball Joint	S080861
	1998.10-2008.07	Front Axle Left & Right Lower	Saloon RWD XR8		Control Arm Bushing	531944
	1998.10-2008.07	Front Axle Left	Saloon RWD XR8	Chassis no.to:M10264	Tie Rod End	S071074
	1998.10-2008.07	Front Axle Left	Saloon RWD XR8	Chassis no.from:M10265	Tie Rod End	S071157
	1998.10-2008.07	Front Axle Right	Saloon RWD XR8	Chassis no.to:M10264	Tie Rod End	S071075
	1998.10-2008.07	Front Axle Right	Saloon RWD XR8		Tie Rod End	S071158
	1998.10-2008.07	Front Axle Left & Right	Saloon RWD XR8		Tie Rod End	S070824
	1998.10-2008.07	Front Axle Left & Right	Saloon RWD XR8		Tie Rod End	S070866
	1998.10-2008.07	Front Axle Left & Right	Saloon RWD XR8		Rod/Strut,stabiliser	S050940
	1998.10-2008.07	Rear Axle Left	Saloon RWD XR8		Rod/Strut,stabiliser	S050843
	1998.10-2008.07	Rear Axle Right	Saloon RWD XR8		Rod/Strut,stabiliser	S050844
	1998.10-2008.07	Rear Axle Left & Right	Saloon RWD XR8		Rod/Strut,stabiliser	S100413
4.2 (219 kw)	2001.11-2008.07	Front Axle Left Upper	Saloon RWD AJ8FR		Track Control Arm	S061623
	2001.11-2008.07	Front Axle Left Lower Inner	Saloon RWD AJ8FR		Track Control Arm	S062758
	2001.11-2008.07	Front Axle Right Upper	Saloon RWD AJ8FR		Track Control Arm	S061624
	2001.11-2008.07	Front Axle Right Lower Inner	Saloon RWD AJ8FR		Track Control Arm	S062759
	2001.11-2008.07	Front Axle Left & Right Lower	Saloon RWD AJ8FR		Ball Joint	S080861
	2001.11-2008.07	Front Axle Left & Right Lower	Saloon RWD AJ8FR		Control Arm Bushing	531944
	2001.11-2008.07	Front Axle Left	Saloon RWD AJ8FR	Chassis no.to:M10264	Tie Rod End	S071074
	2001.11-2008.07	Front Axle Left	Saloon RWD AJ8FR	Chassis no.from:M10265	Tie Rod End	S071157
	2001.11-2008.07	Front Axle Right	Saloon RWD AJ8FR	Chassis no.to:M10264	Tie Rod End	S071075
	2001.11-2008.07	Front Axle Right	Saloon RWD AJ8FR		Tie Rod End	S071158
	2001.11-2008.07	Front Axle Left & Right	Saloon RWD AJ8FR		Rod/Strut,stabiliser	S050940
	2001.11-2008.07	Rear Axle Left	Saloon RWD AJ8FR		Rod/Strut,stabiliser	S050843
	2001.11-2008.07	Rear Axle Right	Saloon RWD AJ8FR		Rod/Strut,stabiliser	S050844
	2001.11-2008.07	Rear Axle Left & Right	Saloon RWD AJ8FR		Rod/Strut,stabiliser	S100413
4.2 (291 kw)	2001.11-2008.12	Front Axle Left Upper	Saloon RWD AJ8FT		Track Control Arm	S061623
	2001.11-2008.12	Front Axle Left Lower Inner	Saloon RWD AJ8FT		Track Control Arm	S062758
	2001.11-2008.12	Front Axle Right Upper	Saloon RWD AJ8FT		Track Control Arm	S061624
	2001.11-2008.12	Front Axle Right Lower Inner	Saloon RWD AJ8FT		Track Control Arm	S062759
	2001.11-2008.12	Front Axle Left & Right Lower	Saloon RWD AJ8FT		Ball Joint	S080861
	2001.11-2008.12	Front Axle Left & Right Lower	Saloon RWD AJ8FT		Control Arm Bushing	531944
	2001.11-2008.12	Front Axle Left	Saloon RWD AJ8FT	Chassis no.to:M10264	Tie Rod End	S071074
	2001.11-2008.12	Front Axle Left	Saloon RWD AJ8FT	Chassis no.from:M10265	Tie Rod End	S071157
	2001.11-2008.12	Front Axle Right	Saloon RWD AJ8FT	Chassis no.to:M10264	Tie Rod End	S071075
	2001.11-2008.12	Front Axle Right	Saloon RWD AJ8FT		Tie Rod End	S071158
	2001.11-2008.12	Front Axle Left & Right	Saloon RWD AJ8FT		Rod/Strut,stabiliser	S050940
	2001.11-2008.12	Rear Axle Left	Saloon RWD AJ8FT		Rod/Strut,stabiliser	S050843
	2001.11-2008.12	Rear Axle Right	Saloon RWD AJ8FT		Rod/Strut,stabiliser	S050844
	2001.11-2008.12	Rear Axle Left & Right	Saloon RWD AJ8FT		Rod/Strut,stabiliser	S100413



	 YEAR	FITTING POSITION	BODY STYLE & DRIVE TYPE & ENGINE	REMARKS	PRODUCT	GSP Ref.
JAGUAR						
Sovereign						
4.0 (216 kw)	1997.10-2003.04	Front Axle Left & Right Lower	Saloon RWD AJ26		Ball Joint	S080304
Vanden Plas						
4.0 (267 kw)	1997.10-2003.12	Front Axle Left & Right Lower	Saloon RWD AJ27S		Ball Joint	S080304
X-Type						
2.5 (144 kw)	2001.03-2009.12	Front Axle Left Lower	Saloon 4WD AJMXXB		Track Control Arm	S060447
	2001.03-2009.12	Front Axle Right Lower	Saloon 4WD AJMXXB		Track Control Arm	S060448
	2001.03-2009.12	Rear Axle Left & Right Upper	Saloon 4WD AJMXXB		Track Control Arm	S061663
	2001.03-2009.12	Rear Axle Left & Right Lower Inner	Saloon 4WD AJMXXB		Track Control Arm	S061472
	2001.03-2009.12	Front Axle Left & Right Lower	Saloon 4WD AJMXXB		Control Arm Bushing	516463
	2001.03-2009.12	Front Axle Left & Right Lower	Saloon 4WD AJMXXB		Control Arm Bushing	517347
	2001.03-2009.12	Front Axle Left & Right	Saloon 4WD AJMXXB		Rod/Strut, stabiliser	S050144
3.0 (169 kw)	2001.03-2009.11	Front Axle Left Lower	Saloon 4WD AJLWB		Track Control Arm	S060447
	2001.03-2009.11	Front Axle Right Lower	Saloon 4WD AJLWB		Track Control Arm	S060448
	2001.03-2009.11	Rear Axle Left & Right Upper	Saloon 4WD AJLWB		Track Control Arm	S061663
	2001.03-2009.11	Rear Axle Left & Right Lower Inner	Saloon 4WD AJLWB		Track Control Arm	S061472
	2001.03-2009.11	Front Axle Left & Right Lower	Saloon 4WD AJLWB		Control Arm Bushing	516463
	2001.03-2009.11	Front Axle Left & Right Lower	Saloon 4WD AJLWB		Control Arm Bushing	517347
	2001.03-2009.11	Front Axle Left & Right	Saloon 4WD AJLWB		Rod/Strut, stabiliser	S050144
	2003.11-2009.12	Front Axle Left Lower	Estate 4WD AJLWB		Track Control Arm	S060447
	2003.11-2009.12	Front Axle Right Lower	Estate 4WD AJLWB		Track Control Arm	S060448
	2003.11-2009.12	Rear Axle Left & Right Upper	Estate 4WD AJLWB		Track Control Arm	S061663
	2003.11-2009.12	Rear Axle Left & Right Lower Inner	Estate 4WD AJLWB		Track Control Arm	S061472
	2003.11-2009.12	Front Axle Left & Right Lower	Estate 4WD AJLWB		Control Arm Bushing	516463
	2003.11-2009.12	Front Axle Left & Right Lower	Estate 4WD AJLWB		Control Arm Bushing	517347
	2003.11-2009.12	Front Axle Left & Right	Estate 4WD AJLWB		Rod/Strut, stabiliser	S050144
XF						
2.0 (177 kw)	2012.06-2015.04	Front Axle Left Upper	Saloon RWD 204PT		Track Control Arm	S061623
	2012.06-2015.04	Front Axle Left Lower Inner	Saloon RWD 204PT		Track Control Arm	S062758
	2012.06-2015.04	Front Axle Right Upper	Saloon RWD 204PT		Track Control Arm	S061624
	2012.06-2015.04	Front Axle Right Lower Inner	Saloon RWD 204PT		Track Control Arm	S062759
	2012.06-2015.04	Front Axle Left & Right Lower	Saloon RWD 204PT		Control Arm Bushing	531944
	2012.06-2015.04	Rear Axle Left	Saloon RWD 204PT		Rod/Strut, stabiliser	S050843
	2012.06-2015.04	Rear Axle Right	Saloon RWD 204PT		Rod/Strut, stabiliser	S050844
3.0 (175 kw)	2007.10-2015.04	Front Axle Left Upper	Saloon RWD AJ6WG		Track Control Arm	S061623
	2007.10-2015.04	Front Axle Left Lower Inner	Saloon RWD AJ6WG		Track Control Arm	S062758
	2007.10-2015.04	Front Axle Right Upper	Saloon RWD AJ6WG		Track Control Arm	S061624
	2007.10-2015.04	Front Axle Right Lower Inner	Saloon RWD AJ6WG		Track Control Arm	S062759
	2007.10-2015.04	Front Axle Left & Right Lower	Saloon RWD AJ6WG		Control Arm Bushing	531944
	2007.10-2015.04	Rear Axle Left	Saloon RWD AJ6WG		Rod/Strut, stabiliser	S050843
	2007.10-2015.04	Rear Axle Right	Saloon RWD AJ6WG		Rod/Strut, stabiliser	S050844
3.0 (250 kw)	2012.03-2015.04	Front Axle Left Upper	Saloon RWD 306PS		Track Control Arm	S061623
	2012.03-2015.04	Front Axle Left Lower Inner	Saloon RWD 306PS		Track Control Arm	S062758
	2012.03-2015.04	Front Axle Right Upper	Saloon RWD 306PS		Track Control Arm	S061624
	2012.03-2015.04	Front Axle Right Lower Inner	Saloon RWD 306PS		Track Control Arm	S062759
	2012.03-2015.04	Front Axle Left & Right Lower	Saloon RWD 306PS		Control Arm Bushing	531944
	2012.03-2015.04	Rear Axle Left	Saloon RWD 306PS		Rod/Strut, stabiliser	S050843
	2012.03-2015.04	Rear Axle Right	Saloon RWD 306PS		Rod/Strut, stabiliser	S050844
4.2 (219 kw)	2008.03-2015.04	Front Axle Left Upper	Saloon RWD SV82G		Track Control Arm	S061623
	2008.03-2015.04	Front Axle Left Lower Inner	Saloon RWD SV82G		Track Control Arm	S062758
	2008.03-2015.04	Front Axle Right Upper	Saloon RWD SV82G		Track Control Arm	S061624
	2008.03-2015.04	Front Axle Right Lower Inner	Saloon RWD SV82G		Track Control Arm	S062759
	2008.03-2015.04	Front Axle Left & Right Lower	Saloon RWD SV82G		Control Arm Bushing	531944
	2008.03-2015.04	Rear Axle Left	Saloon RWD SV82G		Rod/Strut, stabiliser	S050843
	2008.03-2015.04	Rear Axle Right	Saloon RWD SV82G		Rod/Strut, stabiliser	S050844
4.2 (306 kw)	2008.03-2015.04	Front Axle Left Upper	Saloon RWD SV8TS		Track Control Arm	S061623
	2008.03-2015.04	Front Axle Left Lower Inner	Saloon RWD SV8TS		Track Control Arm	S062758
	2008.03-2015.04	Front Axle Right Upper	Saloon RWD SV8TS		Track Control Arm	S061624
	2008.03-2015.04	Front Axle Right Lower Inner	Saloon RWD SV8TS		Track Control Arm	S062759
	2008.03-2015.04	Front Axle Left & Right Lower	Saloon RWD SV8TS		Control Arm Bushing	531944
	2008.03-2015.04	Rear Axle Left	Saloon RWD SV8TS		Rod/Strut, stabiliser	S050843
	2008.03-2015.04	Rear Axle Right	Saloon RWD SV8TS		Rod/Strut, stabiliser	S050844
XFR						
5.0 (375 kw)	2009.01-2015.04	Front Axle Left Upper	Saloon RWD 508PS		Track Control Arm	S061623
	2009.01-2015.04	Front Axle Left Lower Inner	Saloon RWD 508PS		Track Control Arm	S062758



	 YEAR	FITTING POSITION	BODY STYLE & DRIVE TYPE & ENGINE	REMARKS	PRODUCT	GSP Ref.
JAGUAR XFR						
5.0 (375 kw)	2009.01-2015.04	Front Axle Right Upper	Saloon RWD 508PS		Track Control Arm	S061624
	2009.01-2015.04	Front Axle Right Lower Inner	Saloon RWD 508PS		Track Control Arm	S062759
	2009.01-2015.04	Front Axle Left & Right Lower	Saloon RWD 508PS		Control Arm Bushing	531944
	2009.01-2015.04	Rear Axle Left	Saloon RWD 508PS		Rod/Strut, stabiliser	S050843
	2009.01-2015.04	Rear Axle Right	Saloon RWD 508PS		Rod/Strut, stabiliser	S050844
XJ12						
6.0 (229 kw)	1993.03-1996.12	Front Axle Left & Right Lower	Saloon RWD 8C10100/8E10		Ball Joint	S080304
	1993.03-1996.12	Front Axle Left & Right Upper	Saloon RWD 8C10100/8E10		Ball Joint	S080340
6.0 (234 kw)	1994.09-1997.09	Front Axle Left & Right Lower	Saloon RWD 8E10		Ball Joint	S080304
	1994.09-1997.09	Front Axle Left & Right Upper	Saloon RWD 8E10		Ball Joint	S080340
XJ6						
4.0 (183 kw)	1993.06-1997.12	Front Axle Left & Right Lower	Saloon RWD AJ16		Ball Joint	S080304
	1993.06-1997.12	Front Axle Left & Right Upper	Saloon RWD AJ16		Ball Joint	S080340
XJ8						
4.2 (291 kw)	2003.03-2009.03	Front Axle Left Lower Inner	Saloon RWD AJ33SC/AJ8FT		Track Control Arm	S062758
	2003.03-2009.03	Front Axle Right Lower Inner	Saloon RWD AJ33SC/AJ8FT		Track Control Arm	S062759
	2003.03-2009.03	Front Axle Left & Right Lower	Saloon RWD AJ33SC/AJ8FT		Control Arm Bushing	531944
	2003.03-2009.03	Front Axle Left	Saloon RWD AJ33SC/AJ8FT		Tie Rod End	S071157
	2003.03-2009.03	Front Axle Right	Saloon RWD AJ33SC/AJ8FT		Tie Rod End	S071158
	2003.03-2009.03	Rear Axle Left	Saloon RWD AJ33SC/AJ8FT		Rod/Strut, stabiliser	S050843
2003.03-2009.03	Rear Axle Right	Saloon RWD AJ33SC/AJ8FT		Rod/Strut, stabiliser	S050844	
XJR						
4.0 (267 kw)	1997.10-2003.03	Front Axle Left & Right Lower	Saloon RWD AJ27S		Ball Joint	S080304
4.2 (291 kw)	2003.03-2009.03	Front Axle Left Lower Inner	Saloon RWD AJ33SC/AJ8FT		Track Control Arm	S062758
	2003.03-2009.03	Front Axle Right Lower Inner	Saloon RWD AJ33SC/AJ8FT		Track Control Arm	S062759
	2003.03-2009.03	Front Axle Left & Right Lower	Saloon RWD AJ33SC/AJ8FT		Control Arm Bushing	531944
	2003.03-2009.03	Front Axle Left	Saloon RWD AJ33SC/AJ8FT		Tie Rod End	S071157
	2003.03-2009.03	Front Axle Right	Saloon RWD AJ33SC/AJ8FT		Tie Rod End	S071158
	2003.03-2009.03	Rear Axle Left	Saloon RWD AJ33SC/AJ8FT		Rod/Strut, stabiliser	S050843
	2003.03-2009.03	Rear Axle Right	Saloon RWD AJ33SC/AJ8FT		Rod/Strut, stabiliser	S050844
XJSC						
6.0 (222 kw)	1992.09-1996.10	Front Axle Left & Right Lower	Cabriolet RWD 8C10100		Ball Joint	S080304
	1992.09-1996.10	Front Axle Left & Right Upper	Cabriolet RWD 8C10100		Ball Joint	S080340
XK						
5.0 (283 kw)	2009.01-2014.12	Front Axle Left Lower Inner	Coupe RWD 508PN		Track Control Arm	S062758
	2009.01-2014.12	Front Axle Right Lower Inner	Coupe RWD 508PN		Track Control Arm	S062759
	2009.01-2014.12	Front Axle Left	Coupe RWD 508PN		Tie Rod End	S071157
	2009.01-2014.12	Front Axle Right	Coupe RWD 508PN		Tie Rod End	S071158
	2009.01-2014.12	Rear Axle Left	Coupe RWD 508PN		Rod/Strut, stabiliser	S050843
	2009.01-2014.12	Rear Axle Right	Coupe RWD 508PN		Rod/Strut, stabiliser	S050844
XK8						
4.0 (209 kw)	1996.03-2002.10	Front Axle Left & Right	Coupe RWD AJEE		Tie Rod End	S070866
XKR						
4.2 (306 kw)	2006.03-2014.07	Front Axle Left Lower Inner	Coupe RWD AJ8T24R		Track Control Arm	S062758
	2006.03-2014.07	Front Axle Right Lower Inner	Coupe RWD AJ8T24R		Track Control Arm	S062759
	2006.03-2014.07	Front Axle Left	Coupe RWD AJ8T24R		Tie Rod End	S071157
	2006.03-2014.07	Front Axle Right	Coupe RWD AJ8T24R		Tie Rod End	S071158
XKRS						
5.0 (405 kw)	2011.01-2015.03	Front Axle Left Lower Inner	Coupe RWD 508PS		Track Control Arm	S062758
	2011.01-2015.03	Front Axle Right Lower Inner	Coupe RWD 508PS		Track Control Arm	S062759
	2011.01-2015.03	Front Axle Left	Coupe RWD 508PS		Tie Rod End	S071157
	2011.01-2015.03	Front Axle Right	Coupe RWD 508PS		Tie Rod End	S071158
	2011.01-2015.03	Rear Axle Left	Coupe RWD 508PS		Rod/Strut, stabiliser	S050843
	2011.01-2015.03	Rear Axle Right	Coupe RWD 508PS		Rod/Strut, stabiliser	S050844
JEEP Cherokee						
2.5 (85 kw)	1988.01-2001.09	Front Axle Left & Right Lower	Terrain cab wagon closed 4WD ENC/END		Track Control Arm	S062978
	1988.01-2001.09	Front Axle Left & Right Upper	Terrain cab wagon closed 4WD ENC/END		Track Control Arm	S062053
	1988.01-2001.09	Front Axle Left & Right Upper	Terrain cab wagon closed 4WD ENC/END		Ball Joint	S080271
	1988.01-2001.09	Front Axle Left & Right Lower	Terrain cab wagon closed 4WD ENC/END		Control Arm Bushing	519624
	1988.01-2001.09	Rear Axle Left & Right Upper	Terrain cab wagon closed 4WD ENC/END		Control Arm Bushing	532973
	1988.01-2001.09	Front Axle Left	Terrain cab wagon closed 4WD ENC/END		Tie Rod End	S070237
	1988.01-2001.09	Front Axle Left	Terrain cab wagon closed 4WD ENC/END		Tie Rod End	S070535
	1988.01-2001.09	Front Axle Left	Terrain cab wagon closed 4WD ENC/END		Tie Rod End	S070540



	 YEAR	FITTING POSITION	BODY STYLE & DRIVE TYPE & ENGINE	REMARKS	PRODUCT	GSP Ref.
JEEP Cherokee						
2.5 (85 kw)	1988.01-2001.09	Front Axle Right	Terrain cab wagon closed 4WD ENC/END		Tie Rod End	S070539
	1988.01-2001.09	Front Axle Right	Terrain cab wagon closed 4WD ENC/END		Tie Rod End	S071313
	1988.01-2001.09	Front Axle Left & Right	Terrain cab wagon closed 4WD ENC/END		Rod/Strut,stabiliser	S050942
2.5 (90 kw)	1986.10-2001.09	Front Axle Left & Right Lower	Terrain cab wagon closed 4WD EPE		Track Control Arm	S062978
	1986.10-2001.09	Front Axle Left & Right Upper	Terrain cab wagon closed 4WD EPE		Track Control Arm	S062053
	1986.10-2001.09	Front Axle Left & Right Lower	Terrain cab wagon closed 4WD EPE		Ball Joint	S080273
	1986.10-2001.09	Front Axle Left & Right Upper	Terrain cab wagon closed 4WD EPE		Ball Joint	S080271
	1986.10-2001.09	Front Axle Left & Right Lower	Terrain cab wagon closed 4WD EPE		Control Arm Bushing	519624
	1986.10-2001.09	Front Axle Left	Terrain cab wagon closed 4WD EPE		Tie Rod End	S070237
	1986.10-2001.09	Front Axle Left	Terrain cab wagon closed 4WD EPE		Tie Rod End	S070535
	1986.10-2001.09	Front Axle Left	Terrain cab wagon closed 4WD EPE		Tie Rod End	S070540
	1986.10-2001.09	Front Axle Right	Terrain cab wagon closed 4WD EPE		Tie Rod End	S070539
	1986.10-2001.09	Front Axle Right	Terrain cab wagon closed 4WD EPE		Tie Rod End	S071313
	1986.10-2001.09	Front Axle Left & Right	Terrain cab wagon closed 4WD EPE		Tie Rod End	S071312
	1986.10-2001.09	Front Axle Left & Right	Terrain cab wagon closed 4WD EPE		Rod/Strut,stabiliser	S050466
	1986.10-2001.09	Front Axle Left & Right	Terrain cab wagon closed 4WD EPE		Rod/Strut,stabiliser	S050942
	3.7 (157 kw)	2001.06-2007.10	Front Axle Left Lower	Terrain cab wagon closed 4WD EKG		Track Control Arm
2001.06-2007.10		Front Axle Right Lower	Terrain cab wagon closed 4WD EKG		Track Control Arm	S062623
2001.06-2007.10		Front Axle Left & Right Lower	Terrain cab wagon closed 4WD EKG		Ball Joint	S080275
2001.06-2007.10		Rear Axle Left & Right Upper	Terrain cab wagon closed 4WD EKG		Ball Joint	S080701
2001.06-2007.10		Front Axle Left & Right Lower	Terrain cab wagon closed 4WD EKG		Control Arm Bushing	511367
2001.06-2007.10		Front Axle Left & Right Upper	Terrain cab wagon closed 4WD EKG		Control Arm Bushing	519687
2001.06-2007.10		Rear Axle Left & Right Upper	Terrain cab wagon closed 4WD EKG		Control Arm Bushing	511366
2001.06-2007.10		Front Axle Left	Terrain cab wagon closed 4WD EKG	Date to:2005.09	Tie Rod End	S070546
2001.06-2007.10		Front Axle Left	Terrain cab wagon closed 4WD EKG	Date from:2005.09	Tie Rod End	S071320
2001.06-2007.10		Front Axle Right	Terrain cab wagon closed 4WD EKG	Date to:2005.09	Tie Rod End	S070547
2001.06-2007.10		Front Axle Right	Terrain cab wagon closed 4WD EKG	Date from:2005.09	Tie Rod End	S071015
2001.06-2007.10		Front Axle Left & Right	Terrain cab wagon closed 4WD EKG		Rod/Strut,stabiliser	S050815
2010.01-2013.03		Front Axle Left Lower	Terrain cab wagon closed 4WD EKG		Track Control Arm	S062622
2010.01-2013.03		Front Axle Right Lower	Terrain cab wagon closed 4WD EKG		Track Control Arm	S062623
2010.01-2013.03		Front Axle Left & Right Lower	Terrain cab wagon closed 4WD EKG		Ball Joint	S080639
2010.01-2013.03		Front Axle Left & Right Lower	Terrain cab wagon closed 4WD EKG		Control Arm Bushing	511367
2010.01-2013.03		Front Axle Left & Right	Terrain cab wagon closed 4WD EKG		Tie Rod Axle Joint	S030786
2010.01-2013.03		Front Axle Left	Terrain cab wagon closed 4WD EKG		Tie Rod End	S071011
2010.01-2013.03		Front Axle Right	Terrain cab wagon closed 4WD EKG		Tie Rod End	S071012
2010.01-2013.03		Front Axle Left & Right	Terrain cab wagon closed 4WD EKG		Rod/Strut,stabiliser	S050885
4.0 (127 kw)	1993.09-2001.09	Front Axle Left & Right Lower	Terrain cab wagon closed 4WD MX400L		Track Control Arm	S062978
	1993.09-2001.09	Front Axle Left & Right Upper	Terrain cab wagon closed 4WD MX400L		Track Control Arm	S062053
	1993.09-2001.09	Front Axle Left & Right Lower	Terrain cab wagon closed 4WD MX400L		Ball Joint	S080273
	1993.09-2001.09	Front Axle Left & Right Upper	Terrain cab wagon closed 4WD MX400L		Ball Joint	S080271
	1993.09-2001.09	Front Axle Left & Right Lower	Terrain cab wagon closed 4WD MX400L		Control Arm Bushing	519624
	1993.09-2001.09	Rear Axle Left & Right Upper	Terrain cab wagon closed 4WD MX400L		Control Arm Bushing	532973
	1993.09-2001.09	Front Axle Left	Terrain cab wagon closed 4WD MX400L		Tie Rod End	S070535
	1993.09-2001.09	Front Axle Right	Terrain cab wagon closed 4WD MX400L		Tie Rod End	S071313
Cherokee Classic						
4.0 (131 kw)	1999.02-2001.09	Front Axle Left & Right Lower	Terrain cab wagon closed 4WD ERH		Track Control Arm	S062978
	1999.02-2001.09	Front Axle Left & Right Upper	Terrain cab wagon closed 4WD ERH		Track Control Arm	S062053
	1999.02-2001.09	Front Axle Left & Right Upper	Terrain cab wagon closed 4WD ERH		Ball Joint	S080271
	1999.02-2001.09	Front Axle Left & Right Lower	Terrain cab wagon closed 4WD ERH		Control Arm Bushing	519624
	1999.02-2001.09	Front Axle Left & Right Lower	Terrain cab wagon closed 4WD ERH		Control Arm Bushing	519941
	1999.02-2001.09	Rear Axle Left & Right Upper	Terrain cab wagon closed 4WD ERH		Control Arm Bushing	532973
	1999.02-2001.09	Front Axle Left	Terrain cab wagon closed 4WD ERH		Tie Rod End	S070237
	1999.02-2001.09	Front Axle Left	Terrain cab wagon closed 4WD ERH		Tie Rod End	S070535
	1999.02-2001.09	Front Axle Left	Terrain cab wagon closed 4WD ERH		Tie Rod End	S070540
	1999.02-2001.09	Front Axle Right	Terrain cab wagon closed 4WD ERH		Tie Rod End	S070539
	1999.02-2001.09	Front Axle Right	Terrain cab wagon closed 4WD ERH		Tie Rod End	S071313
	1999.02-2001.09	Front Axle Left & Right	Terrain cab wagon closed 4WD ERH		Rod/Strut,stabiliser	S050942
Commander						
3.7 (157 kw)	2005.06-2010.12	Front Axle Left & Right Upper	SUV 4WD EKG		Track Control Arm	S061861
	2005.06-2010.12	Rear Axle Left & Right Lower Outer	SUV 4WD EKG		Track Control Arm	S063146
	2005.06-2010.12	Front Axle Left & Right Lower	SUV 4WD EKG		Ball Joint	S080639
	2005.06-2010.12	Front Axle Left & Right Upper	SUV 4WD EKG		Ball Joint	S080677
	2005.06-2010.12	Front Axle Left & Right	SUV 4WD EKG		Tie Rod Axle Joint	S030994
	2005.06-2010.12	Front Axle Left	SUV 4WD EKG		Tie Rod End	S071007

	 YEAR	FITTING POSITION	BODY STYLE & DRIVE TYPE & ENGINE	REMARKS	PRODUCT	GSP Ref.
JEEP Commander						
3.7 (157 kw)	2005.06-2010.12	Front Axle Right	SUV 4WD EKG		Tie Rod End	S071008
	2005.06-2010.12	Front Axle Left & Right	SUV 4WD EKG		Rod/Strut, stabiliser	S050816
	2005.06-2010.12	Rear Axle Left & Right	SUV 4WD EKG		Rod/Strut, stabiliser	S050817
Compass						
2.0 (115 kw)	2011.05-	Front Axle Left Lower	SUV FWD ECN		Track Control Arm	S061172
	2011.05-	Front Axle Right Lower	SUV FWD ECN		Track Control Arm	S061173
	2011.05-	Rear Axle Left & Right Lower	SUV FWD ECN		Track Control Arm	S061189
	2011.05-	Rear Axle Left & Right Lower Inner	SUV FWD ECN		Track Control Arm	S051070
	2011.05-	Front Axle Left & Right Lower	SUV FWD ECN		Ball Joint	S081054
	2011.05-	Front Axle Left & Right	SUV FWD ECN		Tie Rod End	S071136
	2011.05-	Front Axle Left & Right	SUV FWD ECN		Rod/Strut, stabiliser	S050714
	2011.05-	Front Axle Left & Right	SUV FWD ECN		Rod/Strut, stabiliser	S050925
2.0 (125 kw)	2016.01-	Rear Axle Left Lower Inner	SUV 4WD EBS(55263088)		Track Control Arm	S063126
	2016.01-	Rear Axle Right Lower Inner	SUV 4WD EBS(55263088)		Track Control Arm	S062981
Grand Cherokee						
2.7 (120 kw)	2001.10-2005.09	Front Axle Left & Right Upper	Terrain cab wagon closed 4WD DDAB		Track Control Arm	S062055
	2001.10-2005.09	Front Axle Left & Right Upper	Terrain cab wagon closed 4WD DDAB		Ball Joint	S080271
	2001.10-2005.09	Rear Axle Left & Right Lower	Terrain cab wagon closed 4WD DDAB		Control Arm Bushing	516384
	2001.10-2005.09	Rear Axle Left & Right Upper	Terrain cab wagon closed 4WD DDAB	Date to:2004	Control Arm Bushing	511366
	2001.10-2005.09	Rear Axle Left & Right Upper	Terrain cab wagon closed 4WD DDAB	Date to:2004	Control Arm Bushing	532973
	2001.10-2005.09	Rear Axle Left & Right Lower	Terrain cab wagon closed 4WD DDAB		Control Arm Bushing Kit	519641S
	2001.10-2005.09	Front Axle Left	Terrain cab wagon closed 4WD DDAB		Tie Rod End	S070545
	2001.10-2005.09	Front Axle Right	Terrain cab wagon closed 4WD DDAB		Tie Rod End	S070544
3.0 (160 kw)	2005.06-2010.12	Front Axle Left & Right Upper	Terrain cab wagon closed RWD EXL		Track Control Arm	S061861
	2005.06-2010.12	Rear Axle Left & Right Lower Outer	Terrain cab wagon closed RWD EXL		Track Control Arm	S063146
	2005.06-2010.12	Front Axle Left & Right Lower	Terrain cab wagon closed RWD EXL		Ball Joint	S080639
	2005.06-2010.12	Front Axle Left & Right Upper	Terrain cab wagon closed RWD EXL		Ball Joint	S080677
	2005.06-2010.12	Front Axle Left & Right	Terrain cab wagon closed RWD EXL		Tie Rod Axle Joint	S030994
	2005.06-2010.12	Front Axle Left	Terrain cab wagon closed RWD EXL		Tie Rod End	S071007
	2005.06-2010.12	Front Axle Right	Terrain cab wagon closed RWD EXL		Tie Rod End	S071008
	2005.06-2010.12	Front Axle Left & Right	Terrain cab wagon closed RWD EXL		Rod/Strut, stabiliser	S050816
3.0 (177 kw)	2005.06-2010.12	Rear Axle Left & Right	Terrain cab wagon closed RWD EXL		Rod/Strut, stabiliser	S050817
	2011.02-	Front Axle Left Upper	SUV 4WD EXF		Track Control Arm	S063079
	2011.02-	Front Axle Right Upper	SUV 4WD EXF		Track Control Arm	S063080
	2011.02-	Rear Axle Left & Right Lower Outer	SUV 4WD EXF		Track Control Arm	S063146
	2011.02-	Rear Axle Left & Right Lower	SUV 4WD EXF		Ball Joint	S080674
	2011.02-	Front Axle Left & Right Lower	SUV 4WD EXF	Date to:2015;Bushings for S061308	Control Arm Bushing	517766
	2011.02-	Rear Axle Left & Right Upper	SUV 4WD EXF		Control Arm Bushing	532971
	2011.02-	Front Axle Left & Right	SUV 4WD EXF		Tie Rod Axle Joint	S030850
	2011.02-	Front Axle Left	SUV 4WD EXF		Tie Rod End	S071329
	2011.02-	Front Axle Right	SUV 4WD EXF		Tie Rod End	S071328
3.1 (103 kw)	2011.02-	Front Axle Left	SUV 4WD EXF		Rod/Strut, stabiliser	S051344
	2011.02-	Front Axle Right	SUV 4WD EXF		Rod/Strut, stabiliser	S051343
	2011.02-	Rear Axle Left & Right	SUV 4WD EXF	Date to:2015.09 For Vehicles Without Increased Ground Clearance	Rod/Strut, stabiliser	S051317
	1998.10-2002.03	Front Axle Left & Right Lower	Terrain cab wagon closed 4WD EXA		Track Control Arm	S061179
	1998.10-2002.03	Front Axle Left & Right Upper	Terrain cab wagon closed 4WD EXA		Track Control Arm	S062055
	1998.10-2002.03	Rear Axle Left & Right Lower	Terrain cab wagon closed 4WD EXA		Track Control Arm	S061180
	1998.10-2002.03	Front Axle Left & Right Upper	Terrain cab wagon closed 4WD EXA		Ball Joint	S080103
	1998.10-2002.03	Front Axle Left & Right Upper	Terrain cab wagon closed 4WD EXA		Ball Joint	S080271
	1998.10-2002.03	Rear Axle Left & Right Upper	Terrain cab wagon closed 4WD EXA		Ball Joint	S080278
	1998.10-2002.03	Rear Axle Left & Right Lower	Terrain cab wagon closed 4WD EXA		Control Arm Bushing	516384
3.6 (210 kw)	1998.10-2002.03	Rear Axle Left & Right Upper	Terrain cab wagon closed 4WD EXA	for OE No.52088422AB,Quantity:2	Control Arm Bushing	511366
	1998.10-2002.03	Rear Axle Left & Right Upper	Terrain cab wagon closed 4WD EXA	Quantity:1	Control Arm Bushing	532973
	1998.10-2002.03	Rear Axle Left & Right Lower	Terrain cab wagon closed 4WD EXA		Control Arm Bushing Kit	519641S
	1998.10-2002.03	Front Axle Left	Terrain cab wagon closed 4WD EXA		Tie Rod End	S070545
	1998.10-2002.03	Front Axle Left	Terrain cab wagon closed 4WD EXA		Tie Rod End	S071093
	1998.10-2002.03	Front Axle Right	Terrain cab wagon closed 4WD EXA	for left-hand drive vehicles	Tie Rod End	S070544
	1998.10-2002.03	Front Axle Right	Terrain cab wagon closed 4WD EXA		Tie Rod End	S071092
	1998.10-2002.03	Front Axle Left & Right	Terrain cab wagon closed 4WD EXA		Rod/Strut, stabiliser	S050226
	1998.10-2002.03	Rear Axle Left & Right	Terrain cab wagon closed 4WD EXA		Rod/Strut, stabiliser	S050227
	3.6 (210 kw)	2010.11-	Front Axle Left Upper	SUV 4WD ERB/ERC		Track Control Arm
2010.11-		Front Axle Right Upper	SUV 4WD ERB/ERC		Track Control Arm	S063080
2010.11-		Rear Axle Left & Right Lower Outer	SUV 4WD ERB/ERC		Track Control Arm	S063146
2010.11-		Rear Axle Left & Right Lower	SUV 4WD ERB/ERC		Ball Joint	S080674



	 YEAR	FITTING POSITION	BODY STYLE & DRIVE TYPE & ENGINE	REMARKS	PRODUCT	GSP Ref.	
JEEP							
Grand Cherokee							
3.6 (210 kw)	2010.11-	Front Axle Left & Right Lower	SUV 4WD ERB/ERC	Date to:2015,Date from:2011,Bushings for 5061008	Control Arm Bushing	517766	
	2010.11-	Rear Axle Left & Right Upper	SUV 4WD ERB/ERC		Control Arm Bushing	532971	
	2010.11-	Front Axle Left & Right	SUV 4WD ERB/ERC		Tie Rod Axle Joint	S030850	
	2010.11-	Front Axle Left	SUV 4WD ERB/ERC		Tie Rod End	S071329	
	2010.11-	Front Axle Right	SUV 4WD ERB/ERC		Tie Rod End	S071328	
	2010.11-	Front Axle Left	SUV 4WD ERB/ERC		Rod/Strut,stabiliser	S051344	
	2010.11-	Front Axle Right	SUV 4WD ERB/ERC		Rod/Strut,stabiliser	S051343	
	2010.11-	Rear Axle Left & Right	SUV 4WD ERB/ERC	Date to:2015,08,For Vehicles Without Increased Ground Clearance	Rod/Strut,stabiliser	S051317	
4.7 (162 kw)	1999.02-2001.08	Front Axle Left & Right Lower	Terrain cab wagon closed 4WD EVA		Track Control Arm	S061179	
	1999.02-2001.08	Front Axle Left & Right Upper	Terrain cab wagon closed 4WD EVA		Track Control Arm	S062055	
	1999.02-2001.08	Rear Axle Left & Right Lower	Terrain cab wagon closed 4WD EVA		Track Control Arm	S061180	
	1999.02-2001.08	Front Axle Left & Right Upper	Terrain cab wagon closed 4WD EVA		Ball Joint	S080103	
	1999.02-2001.08	Front Axle Left & Right Upper	Terrain cab wagon closed 4WD EVA		Ball Joint	S080271	
	1999.02-2001.08	Rear Axle Left & Right Upper	Terrain cab wagon closed 4WD EVA		Ball Joint	S080278	
	1999.02-2001.08	Rear Axle Left & Right Lower	Terrain cab wagon closed 4WD EVA		Control Arm Bushing	516384	
	1999.02-2001.08	Rear Axle Left & Right Upper	Terrain cab wagon closed 4WD EVA	For OE no.1:52088422AB,Quantity:2	Control Arm Bushing	511366	
	1999.02-2001.08	Rear Axle Left & Right Upper	Terrain cab wagon closed 4WD EVA	Quantity:1	Control Arm Bushing	532973	
	1999.02-2001.08	Rear Axle Left & Right Lower	Terrain cab wagon closed 4WD EVA		Control Arm Bushing Kit	519641S	
	1999.02-2001.08	Front Axle Left	Terrain cab wagon closed 4WD EVA		Tie Rod End	S070545	
	1999.02-2001.08	Front Axle Left	Terrain cab wagon closed 4WD EVA		Tie Rod End	S071093	
	1999.02-2001.08	Front Axle Right	Terrain cab wagon closed 4WD EVA	for left-hand drive vehicles	Tie Rod End	S070544	
	1999.02-2001.08	Front Axle Right	Terrain cab wagon closed 4WD EVA		Tie Rod End	S071092	
	1999.02-2001.08	Front Axle Left & Right	Terrain cab wagon closed 4WD EVA		Rod/Strut,stabiliser	S050226	
	1999.02-2001.08	Rear Axle Left & Right	Terrain cab wagon closed 4WD EVA		Rod/Strut,stabiliser	S050227	
	5.2 (158 kw)	1992.09-1998.09	Front Axle Left & Right Lower	Terrain cab wagon closed 4WD ELF		Track Control Arm	S061925
		1992.09-1998.09	Front Axle Left & Right Upper	Terrain cab wagon closed 4WD ELF		Track Control Arm	S062053
1992.09-1998.09		Front Axle Left & Right Lower	Terrain cab wagon closed 4WD ELF		Ball Joint	S080273	
1992.09-1998.09		Front Axle Left & Right Upper	Terrain cab wagon closed 4WD ELF		Ball Joint	S080271	
1992.09-1998.09		Front Axle Left & Right Lower	Terrain cab wagon closed 4WD ELF		Control Arm Bushing	519624	
1992.09-1998.09		Rear Axle Left & Right Lower	Terrain cab wagon closed 4WD ELF		Control Arm Bushing	516384	
1992.09-1998.09		Rear Axle Left & Right Upper	Terrain cab wagon closed 4WD ELF		Control Arm Bushing	519635	
1992.09-1998.09		Rear Axle Left & Right Upper	Terrain cab wagon closed 4WD ELF	Date from-to:1997-1998	Control Arm Bushing	532973	
1992.09-1998.09		Rear Axle Left & Right Lower	Terrain cab wagon closed 4WD ELF		Control Arm Bushing Kit	519641S	
1992.09-1998.09		Front Axle	Terrain cab wagon closed 4WD ELF		Drag Link	S040017	
5.7 (240 kw)	2004.10-2010.12	Front Axle Left & Right Upper	Terrain cab wagon closed 4WD EZB		Track Control Arm	S061861	
	2004.10-2010.12	Rear Axle Left & Right Lower Outer	Terrain cab wagon closed 4WD EZB		Track Control Arm	S063146	
	2004.10-2010.12	Front Axle Left & Right Lower	Terrain cab wagon closed 4WD EZB		Ball Joint	S080639	
	2004.10-2010.12	Front Axle Left & Right Upper	Terrain cab wagon closed 4WD EZB		Ball Joint	S080677	
	2004.10-2010.12	Front Axle Left & Right	Terrain cab wagon closed 4WD EZB		Tie Rod Axle Joint	S030994	
	2004.10-2010.12	Front Axle Left	Terrain cab wagon closed 4WD EZB		Tie Rod End	S071007	
	2004.10-2010.12	Front Axle Right	Terrain cab wagon closed 4WD EZB		Tie Rod End	S071008	
	2004.10-2010.12	Front Axle Left & Right	Terrain cab wagon closed 4WD EZB		Rod/Strut,stabiliser	S050816	
5.9 (177 kw)	1997.08-1999.04	Front Axle Left & Right Lower	Terrain cab wagon closed 4WD EML		Track Control Arm	S061925	
	1997.08-1999.04	Front Axle Left & Right Upper	Terrain cab wagon closed 4WD EML		Track Control Arm	S062053	
	1997.08-1999.04	Front Axle Left & Right Lower	Terrain cab wagon closed 4WD EML		Ball Joint	S080273	
	1997.08-1999.04	Front Axle Left & Right Upper	Terrain cab wagon closed 4WD EML		Ball Joint	S080271	
	1997.08-1999.04	Front Axle Left & Right Lower	Terrain cab wagon closed 4WD EML		Control Arm Bushing	519624	
	1997.08-1999.04	Rear Axle Left & Right Lower	Terrain cab wagon closed 4WD EML		Control Arm Bushing	516384	
	1997.08-1999.04	Rear Axle Left & Right Upper	Terrain cab wagon closed 4WD EML		Control Arm Bushing	519635	
	1997.08-1999.04	Rear Axle Left & Right Upper	Terrain cab wagon closed 4WD EML	Date to:1998	Control Arm Bushing	532973	
	1997.08-1999.04	Rear Axle Left & Right Lower	Terrain cab wagon closed 4WD EML		Control Arm Bushing Kit	519641S	
	1997.08-1999.04	Front Axle	Terrain cab wagon closed 4WD EML		Drag Link	S040017	
Liberty							
3.7 (157 kw)	2007.09-2015.12	Front Axle Left Lower	Terrain cab wagon closed 4WD EKG		Track Control Arm	S062622	
	2007.09-2015.12	Front Axle Right Lower	Terrain cab wagon closed 4WD EKG		Track Control Arm	S062623	
	2007.09-2015.12	Front Axle Left & Right Lower	Terrain cab wagon closed 4WD EKG		Ball Joint	S080639	
	2007.09-2015.12	Front Axle Left & Right Lower	Terrain cab wagon closed 4WD EKG		Control Arm Bushing	511367	
	2007.09-2015.12	Front Axle Left & Right	Terrain cab wagon closed 4WD EKG		Tie Rod Axle Joint	S030786	
	2007.09-2015.12	Front Axle Left	Terrain cab wagon closed 4WD EKG		Tie Rod End	S071011	
	2007.09-2015.12	Front Axle Right	Terrain cab wagon closed 4WD EKG		Tie Rod End	S071012	
	2007.09-2015.12	Front Axle Left & Right	Terrain cab wagon closed 4WD EKG		Rod/Strut,stabiliser	S050885	



	 YEAR	FITTING POSITION	BODY STYLE & DRIVE TYPE & ENGINE	REMARKS	PRODUCT	GSP Ref.	
JEEP							
Renegade							
2.0 (125 kw)	2014.07-	Front Axle Left Lower	SUV 4WD 55283099/EBT(55263088)		Track Control Arm	S062915	
	2014.07-	Front Axle Right Lower	SUV 4WD 55283099/EBT(55263088)		Track Control Arm	S062916	
	2014.07-	Rear Axle Left Lower Inner	SUV 4WD 55283099/EBT(55263088)		Track Control Arm	S063126	
	2014.07-	Rear Axle Right Lower Inner	SUV 4WD 55283099/EBT(55263088)		Track Control Arm	S062981	
	2014.07-	Front Axle Left & Right Lower	SUV 4WD 55283099/EBT(55263088)		Ball Joint	S081027	
	2014.07-	Front Axle Left & Right	SUV 4WD 55283099/EBT(55263088)		Tie Rod Axle Joint	S030799	
	2014.07-	Front Axle Left	SUV 4WD 55283099/EBT(55263088)		Tie Rod End	S071621	
	2014.07-	Front Axle Right	SUV 4WD 55283099/EBT(55263088)		Tie Rod End	S071622	
	2014.07-	Front Axle Left & Right	SUV 4WD 55283099/EBT(55263088)		Rod/Strut, stabiliser	S051241	
Wagoneer							
2.5 (90 kw)	1986.10-1991.09	Front Axle Left & Right Lower	Terrain cab wagon closed 4WD EPE		Track Control Arm	S062978	
	1986.10-1991.09	Front Axle Left & Right Upper	Terrain cab wagon closed 4WD EPE		Track Control Arm	S062053	
	1986.10-1991.09	Front Axle Left & Right Lower	Terrain cab wagon closed 4WD EPE		Ball Joint	S080273	
	1986.10-1991.09	Front Axle Left & Right Upper	Terrain cab wagon closed 4WD EPE		Ball Joint	S080271	
	1986.10-1991.09	Front Axle Left & Right Lower	Terrain cab wagon closed 4WD EPE		Control Arm Bushing	519624	
	1986.10-1991.09	Front Axle Left	Terrain cab wagon closed 4WD EPE		Tie Rod End	S070237	
	1986.10-1991.09	Front Axle Left	Terrain cab wagon closed 4WD EPE		Tie Rod End	S070535	
	1986.10-1991.09	Front Axle Left	Terrain cab wagon closed 4WD EPE		Tie Rod End	S070540	
	1986.10-1991.09	Front Axle Right	Terrain cab wagon closed 4WD EPE		Tie Rod End	S070539	
	1986.10-1991.09	Front Axle Right	Terrain cab wagon closed 4WD EPE		Tie Rod End	S071313	
	1986.10-1991.09	Front Axle Left & Right	Terrain cab wagon closed 4WD EPE		Tie Rod End	S071312	
	1986.10-1991.09	Front Axle Left & Right	Terrain cab wagon closed 4WD EPE		Rod/Strut, stabiliser	S050466	
	1986.10-1991.09	Front Axle Left & Right	Terrain cab wagon closed 4WD EPE		Rod/Strut, stabiliser	S050942	
Wrangler							
3.6 (209 kw)	2011.10-	Front Axle Left	Terrain cab open 4WD ERB		Tie Rod End	S071319	
	2011.10-	Front Axle Left & Right	Terrain cab open 4WD ERB		Rod/Strut, stabiliser	S051441	
	2011.10-	Rear Axle Left & Right	Terrain cab open 4WD ERB		Rod/Strut, stabiliser	S050643	
3.8 (153 kw)	2006.02-2008.12	Front Axle Left	Terrain cab open 4WD EGT		Tie Rod End	S071319	
	2006.02-2008.12	Front Axle Left & Right	Terrain cab open 4WD EGT		Rod/Strut, stabiliser	S051441	
	2006.02-2008.12	Rear Axle Left & Right	Terrain cab open 4WD EGT		Rod/Strut, stabiliser	S050643	
4.0 (131 kw)	1986.10-1990.12	Front Axle Left & Right Upper	Terrain cab open 4WD M400L		Track Control Arm	S062053	
	1986.10-1990.12	Front Axle Left	Terrain cab open 4WD M400L		Tie Rod End	S070535	
	1986.10-1990.12	Front Axle Right	Terrain cab open 4WD M400L		Tie Rod End	S071313	
KIA							
Cadenza							
3.5 (213 kw)	2010.01-2015.12	Rear Axle Left & Right Lower Inner	Saloon FWD G6DC		Track Control Arm	S062191	
	2010.01-2015.12	Front Axle Left & Right Lower	Saloon FWD G6DC		Ball Joint	S080501	
	2010.01-2015.12	Rear Axle Left & Right Upper	Saloon FWD G6DC		Control Arm Bushing	535465	
	2010.01-2015.12	Front Axle Left & Right	Saloon FWD G6DC		Tie Rod Axle Joint	S030578	
	2010.01-2015.12	Front Axle Left	Saloon FWD G6DC		Rod/Strut, stabiliser	S050652	
	2010.01-2015.12	Front Axle Right	Saloon FWD G6DC		Rod/Strut, stabiliser	S051193	
	2010.01-2015.12	Front Axle Left & Right	Saloon FWD G6DC		Rod/Strut, stabiliser	S050592	
	2010.01-2015.12	Rear Axle Left & Right	Saloon FWD G6DC		Rod/Strut, stabiliser	S050590	
Carens							
1.8 (81 kw)	2000.03-2002.10	Front Axle Left & Right Lower	MPV FWD T8D		Ball Joint	S080106	
	2000.03-2002.10	Front Axle Left & Right Lower	MPV FWD T8D	Date to:2002.04	Ball Joint	S080106	
	2000.03-2002.10	Front Axle Left & Right Lower	MPV FWD T8D		Control Arm Bushing	516346	
	2000.03-2002.10	Rear Axle Left & Right Lower	MPV FWD T8D	Date from:2002.03	Control Arm Bushing	514905	
	2000.03-2002.10	Rear Axle Left & Right Lower	MPV FWD T8D	Date from:2002.03	Control Arm Bushing	514906	
	2000.03-2002.10	Front Axle Left & Right	MPV FWD T8D		Tie Rod End	S070240	
	2000.03-2002.10	Front Axle Left	MPV FWD T8D		Rod/Strut, stabiliser	S050506	
	2000.03-2002.10	Front Axle Right	MPV FWD T8D		Rod/Strut, stabiliser	S050505	
	2000.03-2002.10	Front Axle Right	MPV FWD T8D	Date to:2002.04	Rod/Strut, stabiliser	S050505	
	2000.03-2002.10	Rear Axle Left & Right	MPV FWD T8D		Rod/Strut, stabiliser	S050230	
	1.8 (93 kw)	2000.03-2006.08	Front Axle Left & Right Lower	MPV FWD TB		Ball Joint	S080106
		2000.03-2006.08	Front Axle Left & Right Lower	MPV FWD TB		Control Arm Bushing	516346
		2000.03-2006.08	Rear Axle Left & Right Lower	MPV FWD TB	Date from:2002.03	Control Arm Bushing	514905
2000.03-2006.08		Rear Axle Left & Right Lower	MPV FWD TB		Control Arm Bushing	514905	
2000.03-2006.08		Rear Axle Left & Right Lower	MPV FWD TB	Date from:2002.03	Control Arm Bushing	514906	
2000.03-2006.08		Rear Axle Left & Right Lower	MPV FWD TB		Control Arm Bushing	514906	
2000.03-2006.08		Front Axle Left & Right	MPV FWD TB		Tie Rod End	S070240	
2000.03-2006.08		Front Axle Left	MPV FWD TB		Rod/Strut, stabiliser	S050700	
2000.03-2006.08		Front Axle Right	MPV FWD TB		Rod/Strut, stabiliser	S050694	
2000.03-2006.08	Rear Axle Left & Right	MPV FWD TB		Rod/Strut, stabiliser	S050230		



	 YEAR	FITTING POSITION	BODY STYLE & DRIVE TYPE & ENGINE	REMARKS	PRODUCT	GSP Ref.
KIA						
Carens						
2.0 (111 kw)	2009.01-2013.03	Front Axle Left Lower	MPV FWD G4KA		Track Control Arm	S061270
	2009.01-2013.03	Front Axle Right Lower	MPV FWD G4KA		Track Control Arm	S061271
	2009.01-2013.03	Rear Axle Left & Right Lower Inner	MPV FWD G4KA		Track Control Arm	S062191
	2009.01-2013.03	Rear Axle Left & Right Centre	MPV FWD G4KA		Control Arm Bushing	516373
Carnival						
2.5 (110 kw)	2001.08-2005.11	Rear Axle Left & Right Upper	MPV FWD KV6		Control Arm Bushing	516050
	2001.08-2005.11	Front Axle Right	MPV FWD KV6		Tie Rod Axle Joint	S030681
	2001.08-2005.11	Front Axle Left	MPV FWD KV6		Tie Rod End	S070241
	2001.08-2005.11	Front Axle Right	MPV FWD KV6		Tie Rod End	S100058
	2001.08-2005.11	Front Axle Left & Right	MPV FWD KV6		Rod/Strut, stabiliser	S050234
2.5 (121 kw)	1999.08-2001.10	Front Axle Left Lower	MPV FWD KV6		Track Control Arm	S060833
	1999.08-2001.10	Front Axle Right Lower	MPV FWD KV6		Track Control Arm	S060834
	1999.08-2001.10	Rear Axle Left & Right Upper	MPV FWD KV6		Control Arm Bushing	516050
	1999.08-2001.10	Front Axle Left	MPV FWD KV6		Tie Rod Axle Joint	S031041
	1999.08-2001.10	Front Axle Right	MPV FWD KV6		Tie Rod Axle Joint	S030681
	1999.08-2001.10	Front Axle Left	MPV FWD KV6		Tie Rod End	S070241
	1999.08-2001.10	Front Axle Right	MPV FWD KV6		Tie Rod End	S100058
	1999.08-2001.10	Front Axle Left & Right	MPV FWD KV6		Rod/Strut, stabiliser	S050234
3.3 (199 kw)	2015.01-	Rear Axle Left & Right Upper	MPV FWD G6DF		Control Arm Bushing	535465
3.5 (203 kw)	2011.06-2015.06	Rear Axle Left Upper Inner	MPV FWD G6DC		Track Control Arm	S063221
	2011.06-2015.06	Rear Axle Left Upper Outer	MPV FWD G6DC		Track Control Arm	S063238
	2011.06-2015.06	Rear Axle Right Upper Outer	MPV FWD G6DC		Track Control Arm	S063237
	2011.06-2015.06	Rear Axle Left & Right Upper	MPV FWD G6DC		Control Arm Bushing	516556
3.8 (178 kw)	2010.01-2015.06	Rear Axle Left Upper Inner	MPV FWD G6DA		Track Control Arm	S063221
	2010.01-2015.06	Rear Axle Left Upper Outer	MPV FWD G6DA		Track Control Arm	S063238
	2010.01-2015.06	Rear Axle Right Upper Outer	MPV FWD G6DA		Track Control Arm	S063237
	2010.01-2015.06	Front Axle Left & Right Lower	MPV FWD G6DA		Control Arm Bushing	513688
	2010.01-2015.06	Rear Axle Left & Right Upper	MPV FWD G6DA		Control Arm Bushing	516556
Cerato						
1.6 (77 kw)	2004.03-2009.05	Front Axle Left Lower	Saloon FWD G4ED		Track Control Arm	S061105
	2004.03-2009.05	Front Axle Right Lower	Saloon FWD G4ED		Track Control Arm	S061106
	2004.03-2009.05	Front Axle Left & Right Lower	Saloon FWD G4ED		Control Arm Bushing	514291
	2004.03-2009.05	Front Axle Left & Right Lower	Saloon FWD G4ED		Control Arm Bushing	517748
	2004.03-2009.05	Front Axle Left & Right	Saloon FWD G4ED	Date to:2006.09	Tie Rod Axle Joint	S030123
	2004.03-2009.05	Front Axle Left & Right	Saloon FWD G4ED	Date from:2008.10	Tie Rod Axle Joint	S030900
	2004.03-2009.05	Front Axle Left & Right	Saloon FWD G4ED	For OE no.56540A7000	Tie Rod Axle Joint	S031007
	2004.03-2009.05	Front Axle Left & Right	Saloon FWD G4ED		Tie Rod End	S070209
	2004.03-2009.05	Front Axle Left	Saloon FWD G4ED		Rod/Strut, stabiliser	S050239
	2004.03-2009.05	Front Axle Right	Saloon FWD G4ED		Rod/Strut, stabiliser	S050240
	2004.03-2009.05	Rear Axle Left & Right	Saloon FWD G4ED		Rod/Strut, stabiliser	S050224
	2004.03-2009.05	Front Axle	Saloon FWD G4ED		Stabiliser Bushing	517313
	2004.03-2009.05	Rear Axle	Saloon FWD G4ED		Stabiliser Bushing	517321
	2004.03-2009.05	Front Axle	Saloon FWD G4ED		Steering Boot	540326
	2004.03-2009.05	Front Axle	Saloon FWD G4ED		Steering Rack Bellow Kit	540326S
1.6 (93 kw)	2009.09-2013.06	Front Axle Left Lower	Saloon FWD G4FC		Track Control Arm	S061671
	2009.09-2013.06	Front Axle Right Lower	Saloon FWD G4FC		Track Control Arm	S061672
	2009.09-2013.06	Front Axle Left & Right Lower	Saloon FWD G4FC		Ball Joint	S080096
	2009.09-2013.06	Front Axle Left & Right	Saloon FWD G4FC		Tie Rod Axle Joint	S030130
	2009.09-2013.06	Front Axle Left & Right	Saloon FWD G4FC	Date to:2013.03	Tie Rod Axle Joint	S030900
	2009.09-2013.06	Front Axle Left & Right	Saloon FWD G4FC	For OE no.56540A7000	Tie Rod Axle Joint	S031007
	2009.09-2013.06	Front Axle Left	Saloon FWD G4FC		Tie Rod End	S070225
	2009.09-2013.06	Front Axle Right	Saloon FWD G4FC		Tie Rod End	S070226
	2009.09-2013.06	Front Axle Left & Right	Saloon FWD G4FC		Rod/Strut, stabiliser	S050222
	2009.09-2013.06	Front Axle	Saloon FWD G4FC		Stabiliser Bushing	517312
1.6 (94 kw)	2013.06-2019.09	Front Axle Left & Right	Saloon FWD F4FA		Tie Rod Axle Joint	S031007
2.0 (105 kw)	2004.04-2007.01	Front Axle Left Lower	Saloon FWD G4GC		Track Control Arm	S061105
	2004.04-2007.01	Front Axle Right Lower	Saloon FWD G4GC		Track Control Arm	S061106
	2004.04-2007.01	Front Axle Left & Right Lower	Saloon FWD G4GC		Control Arm Bushing	514291
	2004.04-2007.01	Front Axle Left & Right Lower	Saloon FWD G4GC		Control Arm Bushing	517748
	2004.04-2007.01	Front Axle Left & Right	Saloon FWD G4GC	Date to:2006.09	Tie Rod Axle Joint	S030123
	2004.04-2007.01	Front Axle Left & Right	Saloon FWD G4GC	For OE no.56540A7000	Tie Rod Axle Joint	S031007
	2004.04-2007.01	Front Axle Left & Right	Saloon FWD G4GC		Tie Rod End	S070209
	2004.04-2007.01	Front Axle Left	Saloon FWD G4GC		Rod/Strut, stabiliser	S050239
	2004.04-2007.01	Front Axle Right	Saloon FWD G4GC		Rod/Strut, stabiliser	S050240



	 YEAR	FITTING POSITION	BODY STYLE & DRIVE TYPE & ENGINE	REMARKS	PRODUCT	GSP Ref.
KIA Cerato						
2.0 (105 kw)	2004.04-2007.01	Rear Axle Left & Right	Saloon FWD G4GC		Rod/Strut, stabiliser	S050224
	2004.04-2007.01	Front Axle	Saloon FWD G4GC		Stabiliser Bushing	517313
	2004.04-2007.01	Rear Axle	Saloon FWD G4GC		Stabiliser Bushing	517321
	2004.04-2007.01	Front Axle	Saloon FWD G4GC		Steering Boot	540326
	2004.04-2007.01	Front Axle	Saloon FWD G4GC		Steering Rack Bellow Kit	540326S
Cerato Koup						
2.0 (115 kw)	2009.06-2013.12	Front Axle Left & Right	Coupe FWD G4KD	for vehicles with hydraulic power steering	Tie Rod Axle Joint	S030900
	2009.06-2013.12	Front Axle Left & Right	Coupe FWD G4KD	For OE no.56540A7000	Tie Rod Axle Joint	S031007
	2009.06-2013.12	Front Axle Left	Coupe FWD G4KD		Tie Rod End	S070225
	2009.06-2013.12	Front Axle Right	Coupe FWD G4KD		Tie Rod End	S070226
	2009.06-2013.12	Front Axle Left & Right	Coupe FWD G4KD		Rod/Strut, stabiliser	S050222
Ceres						
2.2 (52 kw)	1992.06-1997.12	Front Axle Left	Platform/Chassis RWD S2		Tie Rod End	S070789
	1992.06-1997.12	Front Axle Left	Platform/Chassis RWD S2		Tie Rod End	S071124
	1992.06-1997.12	Front Axle Right	Platform/Chassis RWD S2		Tie Rod End	S070790
	1992.06-1997.12	Front Axle Right	Platform/Chassis RWD S2		Tie Rod End	S071123
Clarus						
2.0 (98 kw)	1996.06-2000.10	Front Axle Left & Right Lower	Saloon FWD FE(16V)		Ball Joint	S080107
	1996.06-2000.10	Front Axle Left & Right Lower	Saloon FWD FE(16V)		Control Arm Bushing	514927
	1996.06-2000.10	Front Axle Left & Right Lower	Saloon FWD FE(16V)	Date to:2000.04	Control Arm Bushing	514927
	1996.06-2000.10	Front Axle Left & Right	Saloon FWD FE(16V)		Tie Rod Axle Joint	S030140
	1996.06-2000.10	Front Axle Left & Right	Saloon FWD FE(16V)		Tie Rod End	S070240
Credos						
2.0 (98 kw)	1996.06-2000.10	Front Axle Left & Right Lower	Saloon FWD FE(16V)		Ball Joint	S080107
	1996.06-2000.10	Front Axle Left & Right Lower	Saloon FWD FE(16V)		Control Arm Bushing	514927
	1996.06-2000.10	Front Axle Left & Right Lower	Saloon FWD FE(16V)	Date to:2000.04	Control Arm Bushing	514927
	1996.06-2000.10	Front Axle Left & Right	Saloon FWD FE(16V)		Tie Rod Axle Joint	S030140
	1996.06-2000.10	Front Axle Left & Right	Saloon FWD FE(16V)		Tie Rod End	S070240
Grand Carnival						
3.3 (199 kw)	2015.01-	Rear Axle Left & Right Upper	MPV FWD G6DF		Control Arm Bushing	535465
K2500						
2.5 (96 kw)	2010.01-	Front Axle Left Lower	Platform/Chassis RWD D4CB		Track Control Arm	S061709
	2010.01-	Front Axle Left Upper	Platform/Chassis RWD D4CB		Track Control Arm	S062894
	2010.01-	Front Axle Right Lower	Platform/Chassis RWD D4CB		Track Control Arm	S061710
	2010.01-	Front Axle Right Upper	Platform/Chassis RWD D4CB		Track Control Arm	S062895
Lotze						
2.0 (106 kw)	2005.10-2010.11	Rear Axle Left & Right Upper	Saloon FWD G4KA		Track Control Arm	S062222
	2005.10-2010.11	Rear Axle Left & Right Lower Inner	Saloon FWD G4KA		Track Control Arm	S062191
	2005.10-2010.11	Front Axle Left & Right Lower	Saloon FWD G4KA		Ball Joint	S080096
	2005.10-2010.11	Rear Axle Left & Right Centre	Saloon FWD G4KA		Control Arm Bushing	516373
	2005.10-2010.11	Rear Axle Left & Right Lower Inner	Saloon FWD G4KA		Control Arm Bushing	514904
	2005.10-2010.11	Rear Axle Left & Right Lower Outer	Saloon FWD G4KA		Control Arm Bushing	516361
	2005.10-2010.11	Front Axle Left	Saloon FWD G4KA		Tie Rod End	S070826
	2005.10-2010.11	Front Axle Right	Saloon FWD G4KA		Tie Rod End	S070827
	2005.10-2010.11	Front Axle Left & Right	Saloon FWD G4KA		Rod/Strut, stabiliser	S050222
	2005.10-2010.11	Rear Axle Left & Right	Saloon FWD G4KA		Rod/Strut, stabiliser	S050831
Magentis						
2.0 (106 kw)	2005.10-2010.12	Rear Axle Left & Right Upper	Saloon FWD G4KA		Track Control Arm	S062222
	2005.10-2010.12	Rear Axle Left & Right Lower Inner	Saloon FWD G4KA		Track Control Arm	S062191
	2005.10-2010.12	Front Axle Left & Right Lower	Saloon FWD G4KA		Ball Joint	S080096
	2005.10-2010.12	Rear Axle Left & Right Centre	Saloon FWD G4KA		Control Arm Bushing	516373
	2005.10-2010.12	Rear Axle Left & Right Lower Inner	Saloon FWD G4KA		Control Arm Bushing	514904
	2005.10-2010.12	Rear Axle Left & Right Lower Outer	Saloon FWD G4KA		Control Arm Bushing	516361
	2005.10-2010.12	Front Axle Left	Saloon FWD G4KA		Tie Rod End	S070826
	2005.10-2010.12	Front Axle Right	Saloon FWD G4KA		Tie Rod End	S070827
	2005.10-2010.12	Front Axle Left & Right	Saloon FWD G4KA		Rod/Strut, stabiliser	S050222
	2005.10-2010.12	Rear Axle Left & Right	Saloon FWD G4KA		Rod/Strut, stabiliser	S050831
2.0 (121 kw)	2009.07-2010.12	Rear Axle Left & Right Upper	Saloon FWD G4KD		Track Control Arm	S062222
	2009.07-2010.12	Rear Axle Left & Right Lower Inner	Saloon FWD G4KD		Track Control Arm	S062191
	2009.07-2010.12	Front Axle Left & Right Lower	Saloon FWD G4KD		Ball Joint	S080096
	2009.07-2010.12	Front Axle Left & Right Lower	Saloon FWD G4KD		Control Arm Bushing	514914
	2009.07-2010.12	Rear Axle Left & Right Centre	Saloon FWD G4KD		Control Arm Bushing	516373
	2009.07-2010.12	Rear Axle Left & Right Lower Inner	Saloon FWD G4KD		Control Arm Bushing	514904
	2009.07-2010.12	Rear Axle Left & Right Lower Outer	Saloon FWD G4KD		Control Arm Bushing	516361



	 YEAR	FITTING POSITION	BODY STYLE & DRIVE TYPE & ENGINE	REMARKS	PRODUCT	GSP Ref.
KIA						
Magentis						
2.0 (121 kw)	2009.07-2010.12	Front Axle Left	Saloon FWD G4KD		Tie Rod End	S070826
	2009.07-2010.12	Front Axle Right	Saloon FWD G4KD		Tie Rod End	S070827
	2009.07-2010.12	Front Axle Left & Right	Saloon FWD G4KD		Rod/Strut,stabiliser	S050222
	2009.07-2010.12	Rear Axle Left & Right	Saloon FWD G4KD		Rod/Strut,stabiliser	S050831
Mentor						
1.5 (65 kw)	1997.10-2001.10	Front Axle Left Lower	Saloon FWD BFD		Track Control Arm	S061279
	1997.10-2001.10	Front Axle Right Lower	Saloon FWD BFD		Track Control Arm	S061280
	1997.10-2001.10	Rear Axle Left & Right Lower Outer	Saloon FWD BFD		Track Control Arm	S061688
	1997.10-2001.10	Front Axle Left & Right Lower	Saloon FWD BFD		Ball Joint	S080051
	1997.10-2001.10	Front Axle Left Lower	Saloon FWD BFD		Control Arm Bushing	531735
	1997.10-2001.10	Front Axle Left & Right Lower	Saloon FWD BFD	Date to:1998.12	Control Arm Bushing	516313
	1997.10-2001.10	Front Axle Left & Right Lower	Saloon FWD BFD		Control Arm Bushing	516346
	1997.10-2001.10	Front Axle Left & Right	Saloon FWD BFD		Tie Rod Axle Joint	S030140
	1997.10-2001.10	Front Axle Left & Right	Saloon FWD BFD		Tie Rod End	S070240
	1997.10-2001.10	Front Axle Left	Saloon FWD BFD		Rod/Strut,stabiliser	S050506
	1997.10-2001.10	Front Axle Right	Saloon FWD BFD		Rod/Strut,stabiliser	S050505
	1997.10-2001.10	Front Axle Left & Right	Saloon FWD BFD		Rod/Strut,stabiliser	S050229
	1997.10-2001.10	Rear Axle Left & Right	Saloon FWD BFD		Rod/Strut,stabiliser	S050230
Mohave						
3.0 (184 kw)	2007.11-	Front Axle Left & Right Lower	SUV 4WD D6EA/D6EB		Control Arm Bushing	516342
	2007.11-	Rear Axle Left & Right Upper	SUV 4WD D6EA/D6EB		Control Arm Bushing	516171
	2007.11-	Rear Axle Left & Right Lower Inner	SUV 4WD D6EA/D6EB		Control Arm Bushing	516145
	2007.11-	Rear Axle Left & Right Lower Outer	SUV 4WD D6EA/D6EB		Control Arm Bushing	516172
	2007.11-	Rear Axle Left & Right	SUV 4WD D6EA/D6EB		Rod/Strut,stabiliser	S050218
3.0 (188 kw)	2008.01-	Rear Axle Left & Right Upper	SUV 4WD D6EA/D6EB		Control Arm Bushing	516171
	2008.01-	Rear Axle Left & Right Lower Inner	SUV 4WD D6EA/D6EB		Control Arm Bushing	516145
3.8 (202 kw)	2008.06-	Front Axle Left & Right Lower	SUV 4WD G6DA		Control Arm Bushing	516342
	2008.06-	Rear Axle Left & Right Upper	SUV 4WD G6DA		Control Arm Bushing	516171
	2008.06-	Rear Axle Left & Right Lower Inner	SUV 4WD G6DA		Control Arm Bushing	516145
	2008.06-	Rear Axle Left & Right Lower Outer	SUV 4WD G6DA		Control Arm Bushing	516172
	2008.06-	Rear Axle Left & Right	SUV 4WD G6DA		Rod/Strut,stabiliser	S050218
4.6 (250 kw)	2008.06-	Rear Axle Left & Right Upper	SUV 4WD 8AHH		Control Arm Bushing	516171
	2008.06-	Rear Axle Left & Right Lower Inner	SUV 4WD 8AHH		Control Arm Bushing	516145
Opirus						
3.5 (149 kw)	2003.06-2006.09	Front Axle Right Upper	Saloon FWD G6CU		Track Control Arm	S060539
	2003.06-2006.09	Front Axle Left & Right Upper	Saloon FWD G6CU		Ball Joint	S080470
	2003.06-2006.09	Front Axle Left & Right Lower	Saloon FWD G6CU		Control Arm Bushing	516081
	2003.06-2006.09	Rear Axle Left & Right Lower	Saloon FWD G6CU		Control Arm Bushing	514980
	2003.06-2006.09	Rear Axle Left & Right Upper	Saloon FWD G6CU	Type:AT WHEEL CARRIER	Control Arm Bushing	513689
	2003.06-2006.09	Rear Axle Left & Right Upper	Saloon FWD G6CU	AT,Date to:2006.08	Control Arm Bushing	516012
	2003.06-2006.09	Front Axle Left & Right	Saloon FWD G6CU		Tie Rod Axle Joint	S030544
	2003.06-2006.09	Front Axle Left & Right	Saloon FWD G6CU		Tie Rod Axle Joint	S030793
	2003.06-2006.09	Front Axle Left	Saloon FWD G6CU		Tie Rod End	S070215
	2003.06-2006.09	Front Axle Right	Saloon FWD G6CU		Tie Rod End	S070216
	2003.06-2006.09	Front Axle Left & Right	Saloon FWD G6CU		Rod/Strut,stabiliser	S050204
	2003.06-2006.09	Front Axle Left & Right	Saloon FWD G6CU		Rod/Strut,stabiliser	S051287
	2003.06-2006.09	Rear Axle Left & Right	Saloon FWD G6CU		Rod/Strut,stabiliser	S050581
	2003.06-2006.09	Front Axle	Saloon FWD G6CU		Steering Boot	540326
3.8 (196 kw)	2006.10-2012.10	Front Axle Left & Right Lower	Saloon FWD G6DA		Ball Joint	S080093
	2006.10-2012.10	Front Axle Left & Right Lower	Saloon FWD G6DA	Date from:2007.11	Control Arm Bushing	530682
	2006.10-2012.10	Front Axle Left & Right Lower	Saloon FWD G6DA	Date to:2007.10	Control Arm Bushing	530682
	2006.10-2012.10	Front Axle Left & Right Upper	Saloon FWD G6DA		Control Arm Bushing	516338
	2006.10-2012.10	Rear Axle Left & Right Upper	Saloon FWD G6DA	For OE no.1552703F700,For OE no.2552803F700	Control Arm Bushing	516012
	2006.10-2012.10	Rear Axle Left & Right Upper	Saloon FWD G6DA		Control Arm Bushing	516171
	2006.10-2012.10	Front Axle Left & Right	Saloon FWD G6DA		Tie Rod Axle Joint	S030544
	2006.10-2012.10	Front Axle Left	Saloon FWD G6DA		Tie Rod End	S070219
	2006.10-2012.10	Front Axle Right	Saloon FWD G6DA		Tie Rod End	S070220
	2006.10-2012.10	Front Axle Left & Right	Saloon FWD G6DA		Rod/Strut,stabiliser	S050215
	2006.10-2012.10	Rear Axle Left & Right	Saloon FWD G6DA		Rod/Strut,stabiliser	S050581
	2006.10-2012.10	Rear Axle Left & Right	Saloon FWD G6DA	Date to:2008.10	Rod/Strut,stabiliser	S050653
	2006.10-2012.10	Front Axle	Saloon FWD G6DA	Date to:2009.07	Stabiliser Bushing	517821
	2006.10-2012.10	Front Axle	Saloon FWD G6DA		Steering Boot	540326



	 YEAR	FITTING POSITION	BODY STYLE & DRIVE TYPE & ENGINE	REMARKS	PRODUCT	GSP Ref.
KIA						
Optima						
2.0 (121 kw)	2012.03-2015.12	Front Axle Left Lower	Saloon FWD G4KD		Track Control Arm	S061956
	2012.03-2015.12	Front Axle Right Lower	Saloon FWD G4KD		Track Control Arm	S061957
	2012.03-2015.12	Rear Axle Left & Right Upper	Saloon FWD G4KD		Track Control Arm	S063011
	2012.03-2015.12	Front Axle Left & Right Lower	Saloon FWD G4KD		Ball Joint	S080500
	2012.03-2015.12	Front Axle Left & Right Lower	Saloon FWD G4KD		Control Arm Bushing	517305
	2012.03-2015.12	Front Axle Left & Right Lower	Saloon FWD G4KD		Control Arm Bushing	535472
	2012.03-2015.12	Rear Axle Left & Right Upper	Saloon FWD G4KD		Control Arm Bushing	535465
	2012.03-2015.12	Rear Axle Left & Right Lower Outer	Saloon FWD G4KD		Control Arm Bushing	530815
	2012.03-2015.12	Front Axle Left & Right	Saloon FWD G4KD	Date to:2015.06	Tie Rod Axle Joint	S030578
	2012.03-2015.12	Front Axle Left & Right	Saloon FWD G4KD	For right-hand drive vehicles	Tie Rod Axle Joint	S030997
	2012.03-2015.12	Front Axle Left	Saloon FWD G4KD		Tie Rod End	S070766
	2012.03-2015.12	Front Axle Right	Saloon FWD G4KD		Tie Rod End	S070767
	2012.03-2015.12	Front Axle Left	Saloon FWD G4KD	Date to:2012.04	Rod/Strut,stabiliser	S050652
	2012.03-2015.12	Front Axle Left	Saloon FWD G4KD	Date to:2012.04	Rod/Strut,stabiliser	S051320
	2012.03-2015.12	Front Axle Right	Saloon FWD G4KD	Date to:2012.04	Rod/Strut,stabiliser	S051193
	2012.03-2015.12	Front Axle Right	Saloon FWD G4KD	Date to:2012.04	Rod/Strut,stabiliser	S051324
	2012.03-2015.12	Front Axle Left & Right	Saloon FWD G4KD		Rod/Strut,stabiliser	S050592
	2012.03-2015.12	Rear Axle Left & Right	Saloon FWD G4KD		Rod/Strut,stabiliser	S050590
2.4 (132 kw)	2012.01-2015.12	Front Axle Left Lower	Saloon FWD G4KE/G4KJ		Track Control Arm	S061956
	2012.01-2015.12	Front Axle Right Lower	Saloon FWD G4KE/G4KJ		Track Control Arm	S061957
	2012.01-2015.12	Rear Axle Left & Right Upper	Saloon FWD G4KE/G4KJ		Track Control Arm	S063011
	2012.01-2015.12	Front Axle Left & Right Lower	Saloon FWD G4KE/G4KJ		Ball Joint	S080500
	2012.01-2015.12	Front Axle Left & Right Lower	Saloon FWD G4KE/G4KJ		Control Arm Bushing	517305
	2012.01-2015.12	Front Axle Left & Right Lower	Saloon FWD G4KE/G4KJ		Control Arm Bushing	535472
	2012.01-2015.12	Rear Axle Left & Right Upper	Saloon FWD G4KE/G4KJ		Control Arm Bushing	535465
	2012.01-2015.12	Rear Axle Left & Right Lower Outer	Saloon FWD G4KE/G4KJ		Control Arm Bushing	530815
	2012.01-2015.12	Front Axle Left	Saloon FWD G4KE/G4KJ		Tie Rod End	S070766
	2012.01-2015.12	Front Axle Right	Saloon FWD G4KE/G4KJ		Tie Rod End	S070767
	2012.01-2015.12	Front Axle Left	Saloon FWD G4KE/G4KJ	Date to:2012.04	Rod/Strut,stabiliser	S050652
	2012.01-2015.12	Front Axle Right	Saloon FWD G4KE/G4KJ	Date to:2012.04	Rod/Strut,stabiliser	S051193
	2012.01-2015.12	Front Axle Left & Right	Saloon FWD G4KE/G4KJ		Rod/Strut,stabiliser	S050592
Picanto						
1.0 (45 kw)	2004.05-2011.04	Front Axle Left Lower	Hatchback FWD G4HE	Date to:2008.09.for vehicles with power steering	Track Control Arm	S060544
	2004.05-2011.04	Front Axle Left Lower	Hatchback FWD G4HE	Date from:2008.09.for vehicles with power steering	Track Control Arm	S061027
	2004.05-2011.04	Front Axle Right Lower	Hatchback FWD G4HE	Date to:2008.09.for vehicles with power steering	Track Control Arm	S060545
	2004.05-2011.04	Front Axle Right Lower	Hatchback FWD G4HE	Date from:2008.09.for vehicles with power steering	Track Control Arm	S061026
	2004.05-2011.04	Front Axle Left & Right Lower	Hatchback FWD G4HE		Ball Joint	S080095
	2004.05-2011.04	Front Axle Left & Right Lower	Hatchback FWD G4HE	Bushings for S060544	Control Arm Bushing	514903
	2004.05-2011.04	Front Axle Left & Right	Hatchback FWD G4HE	Date to:2007.08.Date from:2007.08.for vehicles with hydraulic power steering	Tie Rod Axle Joint	S030135
	2004.05-2011.04	Front Axle Left & Right	Hatchback FWD G4HE	Date from:2007.08.for vehicles with hydraulic power steering	Tie Rod Axle Joint	S030958
	2004.05-2011.04	Front Axle Left & Right	Hatchback FWD G4HE	Hydraulic Power Steering Kit for vehicles with electric power steering	Tie Rod End	S070227
	2004.05-2011.04	Front Axle Left & Right	Hatchback FWD G4HE	Date to:2007.08.Date from:2007.08.for vehicles with hydraulic power steering	Tie Rod End	S070238
	2004.05-2011.04	Front Axle Left	Hatchback FWD G4HE		Rod/Strut,stabiliser	S050237
	2004.05-2011.04	Front Axle Right	Hatchback FWD G4HE		Rod/Strut,stabiliser	S050238
	2004.05-2011.04	Front Axle	Hatchback FWD G4HE		Stabiliser Bushing	517310
	2004.05-2011.04	Front Axle	Hatchback FWD G4HE		Steering Boot	540227
1.0 (46 kw)	2007.10-2011.04	Front Axle Left Lower	Hatchback FWD G4HE	Date to:2008.09.for vehicles with power steering	Track Control Arm	S060544
	2007.10-2011.04	Front Axle Left Lower	Hatchback FWD G4HE	Date from:2008.09.for vehicles with power steering	Track Control Arm	S061027
	2007.10-2011.04	Front Axle Right Lower	Hatchback FWD G4HE	Date to:2008.09.for vehicles with power steering	Track Control Arm	S060545
	2007.10-2011.04	Front Axle Right Lower	Hatchback FWD G4HE	Date from:2008.09.for vehicles with power steering	Track Control Arm	S061026
	2007.10-2011.04	Front Axle Left & Right Lower	Hatchback FWD G4HE		Ball Joint	S080095
	2007.10-2011.04	Front Axle Left & Right Lower	Hatchback FWD G4HE	Bushings for S060544	Control Arm Bushing	514903
	2007.10-2011.04	Front Axle Left & Right	Hatchback FWD G4HE	For vehicles with hydraulic power steering	Tie Rod Axle Joint	S030135
	2007.10-2011.04	Front Axle Left & Right	Hatchback FWD G4HE	for vehicles without hydraulic power steering	Tie Rod Axle Joint	S030958
	2007.10-2011.04	Front Axle Left & Right	Hatchback FWD G4HE	for vehicles with electric power steering for vehicles without power steering	Tie Rod End	S070227
	2007.10-2011.04	Front Axle Left & Right	Hatchback FWD G4HE	for vehicles with hydraulic power steering	Tie Rod End	S070238
	2007.10-2011.04	Front Axle Left	Hatchback FWD G4HE		Rod/Strut,stabiliser	S050237
	2007.10-2011.04	Front Axle Right	Hatchback FWD G4HE		Rod/Strut,stabiliser	S050238
	2007.10-2011.04	Front Axle	Hatchback FWD G4HE		Steering Boot	540227
1.0 (59 kw)	2011.01-2017.03	Front Axle	Hatchback FWD F3LA		Steering Rack Bellow Kit	540288S
1.1 (48 kw)	2004.04-2011.04	Front Axle Left Lower	Hatchback FWD G4HG	Date to:2008.09.for vehicles with power steering	Track Control Arm	S060544
	2004.04-2011.04	Front Axle Left Lower	Hatchback FWD G4HG	Date from:2008.09.for vehicles with power steering	Track Control Arm	S061027
	2004.04-2011.04	Front Axle Right Lower	Hatchback FWD G4HG	Date to:2008.09.for vehicles with power steering	Track Control Arm	S060545
	2004.04-2011.04	Front Axle Right Lower	Hatchback FWD G4HG	Date from:2008.09.for vehicles with power steering	Track Control Arm	S061026



	 YEAR	FITTING POSITION	BODY STYLE & DRIVE TYPE & ENGINE	REMARKS	PRODUCT	GSP Ref.
KIA Picanto						
1.1 (48 kw)	2004.04-2011.04	Front Axle Left & Right Lower	Hatchback FWD G4HG		Ball Joint	S080095
	2004.04-2011.04	Front Axle Left & Right Lower	Hatchback FWD G4HG	Bushings for S060544	Control Arm Bushing	514903
	2004.04-2011.04	Front Axle Left & Right	Hatchback FWD G4HG	<small>Date to 2007.08 Data from 2007.08 for vehicles with hydraulic power steering</small>	Tie Rod Axle Joint	S030135
	2004.04-2011.04	Front Axle Left & Right	Hatchback FWD G4HG	<small>Date from 2007.08 for vehicles with hydraulic power steering</small>	Tie Rod Axle Joint	S030958
	2004.04-2011.04	Front Axle Left & Right	Hatchback FWD G4HG	<small>Date from 2007.08 for vehicles with hydraulic power steering</small>	Tie Rod End	S070227
	2004.04-2011.04	Front Axle Left & Right	Hatchback FWD G4HG	<small>Date to 2007.08 Data from 2007.08 for vehicles with hydraulic power steering</small>	Tie Rod End	S070238
	2004.04-2011.04	Front Axle Left	Hatchback FWD G4HG		Rod/Strut, stabiliser	S050237
	2004.04-2011.04	Front Axle Right	Hatchback FWD G4HG		Rod/Strut, stabiliser	S050238
	2004.04-2011.04	Front Axle	Hatchback FWD G4HG		Stabiliser Bushing	517310
	2004.04-2011.04	Front Axle	Hatchback FWD G4HG		Steering Boot	540227
Sedona						
2.5 (110 kw)	2001.08-2005.11	Rear Axle Left & Right Upper	MPV FWD KV6		Control Arm Bushing	516050
	2001.08-2005.11	Front Axle Right	MPV FWD KV6		Tie Rod Axle Joint	S030681
	2001.08-2005.11	Front Axle Left	MPV FWD KV6		Tie Rod End	S070241
	2001.08-2005.11	Front Axle Right	MPV FWD KV6		Tie Rod End	S100058
	2001.08-2005.11	Front Axle Left & Right	MPV FWD KV6		Rod/Strut, stabiliser	S050234
2.5 (121 kw)	1999.08-2001.10	Front Axle Left Lower	MPV FWD KV6		Track Control Arm	S060833
	1999.08-2001.10	Front Axle Right Lower	MPV FWD KV6		Track Control Arm	S060834
	1999.08-2001.10	Rear Axle Left & Right Upper	MPV FWD KV6		Control Arm Bushing	516050
	1999.08-2001.10	Front Axle Left	MPV FWD KV6		Tie Rod Axle Joint	S031041
	1999.08-2001.10	Front Axle Right	MPV FWD KV6		Tie Rod Axle Joint	S030681
	1999.08-2001.10	Front Axle Left	MPV FWD KV6		Tie Rod End	S070241
	1999.08-2001.10	Front Axle Right	MPV FWD KV6		Tie Rod End	S100058
	1999.08-2001.10	Front Axle Left & Right	MPV FWD KV6		Rod/Strut, stabiliser	S050234
Sephia						
1.5 (59 kw)	1996.02-1997.10	Front Axle Left & Right Lower	Saloon FWD B5		Ball Joint	S080106
	1996.02-1997.10	Front Axle Left & Right Lower	Saloon FWD B5		Control Arm Bushing	516346
	1996.02-1997.10	Rear Axle Right Lower	Saloon FWD B5		Control Arm Bushing	518959
	1996.02-1997.10	Front Axle Left & Right	Saloon FWD B5		Tie Rod Axle Joint	S030140
	1996.02-1997.10	Front Axle Left & Right	Saloon FWD B5		Tie Rod End	S070240
	1996.02-1997.10	Front Axle Left & Right	Saloon FWD B5		Tie Rod End	S070866
1.5 (65 kw)	1997.10-2001.10	Front Axle Left Lower	Saloon FWD BFD		Track Control Arm	S061279
	1997.10-2001.10	Front Axle Right Lower	Saloon FWD BFD		Track Control Arm	S061280
	1997.10-2001.10	Rear Axle Left & Right Lower Outer	Saloon FWD BFD		Track Control Arm	S061688
	1997.10-2001.10	Front Axle Left & Right Lower	Saloon FWD BFD		Ball Joint	S080051
	1997.10-2001.10	Front Axle Left Lower	Saloon FWD BFD		Control Arm Bushing	531735
	1997.10-2001.10	Front Axle Left & Right Lower	Saloon FWD BFD	Date to: 1998.12	Control Arm Bushing	516313
	1997.10-2001.10	Front Axle Left & Right Lower	Saloon FWD BFD		Control Arm Bushing	516346
	1997.10-2001.10	Front Axle Left & Right	Saloon FWD BFD		Tie Rod Axle Joint	S030140
	1997.10-2001.10	Front Axle Left & Right	Saloon FWD BFD		Tie Rod End	S070240
	1997.10-2001.10	Front Axle Left	Saloon FWD BFD		Rod/Strut, stabiliser	S050506
	1997.10-2001.10	Front Axle Right	Saloon FWD BFD		Rod/Strut, stabiliser	S050505
	1997.10-2001.10	Front Axle Left & Right	Saloon FWD BFD		Rod/Strut, stabiliser	S050229
	1997.10-2001.10	Rear Axle Left & Right	Saloon FWD BFD		Rod/Strut, stabiliser	S050230
Shuma						
1.5 (65 kw)	1998.02-2001.03	Front Axle Left Lower	Saloon FWD BFD		Track Control Arm	S061279
	1998.02-2001.03	Front Axle Right Lower	Saloon FWD BFD		Track Control Arm	S061280
	1998.02-2001.03	Rear Axle Left & Right Lower Outer	Saloon FWD BFD		Track Control Arm	S061688
	1998.02-2001.03	Front Axle Left & Right Lower	Saloon FWD BFD		Ball Joint	S080051
	1998.02-2001.03	Front Axle Left Lower	Saloon FWD BFD		Control Arm Bushing	531735
	1998.02-2001.03	Front Axle Left & Right Lower	Saloon FWD BFD	Date to: 1998.12	Control Arm Bushing	516313
	1998.02-2001.03	Front Axle Left & Right Lower	Saloon FWD BFD		Control Arm Bushing	516346
	1998.02-2001.03	Front Axle Left & Right	Saloon FWD BFD		Tie Rod Axle Joint	S030140
	1998.02-2001.03	Front Axle Left & Right	Saloon FWD BFD		Tie Rod End	S070240
	1998.02-2001.03	Front Axle Left	Saloon FWD BFD		Rod/Strut, stabiliser	S050506
	1998.02-2001.03	Front Axle Right	Saloon FWD BFD		Rod/Strut, stabiliser	S050505
	1998.02-2001.03	Front Axle Left & Right	Saloon FWD BFD		Rod/Strut, stabiliser	S050229
	1998.02-2001.03	Rear Axle Left & Right	Saloon FWD BFD		Rod/Strut, stabiliser	S050230
Sorento						
2.4 (126 kw)	2015.01-	Front Axle Left Lower	SUV FWD G4KE		Track Control Arm	S063067
	2015.01-	Front Axle Left Lower	SUV 4WD G4KE		Track Control Arm	S063067
	2015.01-	Front Axle Right Lower	SUV FWD G4KE		Track Control Arm	S063068
	2015.01-	Front Axle Right Lower	SUV 4WD G4KE		Track Control Arm	S063068
	2015.01-	Front Axle Left & Right	SUV FWD G4KE		Tie Rod Axle Joint	S031071



	 YEAR	FITTING POSITION	BODY STYLE & DRIVE TYPE & ENGINE	REMARKS	PRODUCT	GSP Ref.	
KIA Sorento							
2.4 (126 kw)	2015.01-	Front Axle Left & Right	SUV 4WD G4KE		Tie Rod Axle Joint	S031071	
	2015.01-	Front Axle Left & Right	SUV FWD G4KE		Tie Rod Axle Joint	S031072	
	2015.01-	Front Axle Left & Right	SUV 4WD G4KE		Tie Rod Axle Joint	S031072	
	2015.01-	Front Axle	SUV 4WD G4KE		Stabiliser Bushing	535186	
2.4 (128 kw)	2009.06-2015.12	Rear Axle Left Upper	SUV 4WD G4KE		Track Control Arm	S063170	
	2009.06-2015.12	Rear Axle Right Upper	SUV 4WD G4KE		Track Control Arm	S063169	
	2009.06-2015.12	Rear Axle Left & Right Lower Inner	SUV 4WD G4KE		Track Control Arm	S063209	
	2009.06-2015.12	Front Axle Left & Right Lower	SUV 4WD G4KE		Control Arm Bushing	516150	
	2009.06-2015.12	Rear Axle Left & Right Upper	SUV 4WD G4KE		Control Arm Bushing	516171	
	2009.06-2015.12	Rear Axle Left & Right Upper	SUV 4WD G4KE	Date from-to:2012.07-2014.12	Control Arm Bushing	516269	
	2009.06-2015.12	Rear Axle Left & Right Upper	SUV 4WD G4KE		Control Arm Bushing	516269	
	2009.06-2015.12	Rear Axle Left & Right Lower Inner	SUV 4WD G4KE		Control Arm Bushing	516145	
	2009.06-2015.12	Rear Axle Left & Right Lower Outer	SUV 4WD G4KE	for OE No.552202P100	Control Arm Bushing	516172	
	2009.06-2015.12	Rear Axle Left & Right Lower Outer	SUV 4WD G4KE	Date from-to:2012.07-2014.12	Control Arm Bushing	516232	
	2009.06-2015.12	Front Axle Left	SUV 4WD G4KE		Tie Rod Axle Joint	S030719	
	2009.06-2015.12	Front Axle Right	SUV 4WD G4KE		Tie Rod Axle Joint	S030720	
	2009.06-2015.12	Front Axle Left & Right	SUV 4WD G4KE	Date to:2013.01,AT	Tie Rod Axle Joint	S030578	
	2009.06-2015.12	Front Axle Left & Right	SUV 4WD G4KE	Date from:2012.07 for vehicles with electric power steering	Tie Rod Axle Joint	S030997	
	2009.06-2015.12	Front Axle Left	SUV 4WD G4KE		Tie Rod End	S070223	
	2009.06-2015.12	Front Axle Right	SUV 4WD G4KE		Tie Rod End	S070224	
	2009.06-2015.12	Front Axle Left	SUV 4WD G4KE		Rod/Strut,stabiliser	S050216	
	2009.06-2015.12	Front Axle Right	SUV 4WD G4KE		Rod/Strut,stabiliser	S050217	
	2009.06-2015.12	Rear Axle Left	SUV 4WD G4KE		Rod/Strut,stabiliser	S051265	
	2009.06-2015.12	Rear Axle Right	SUV 4WD G4KE		Rod/Strut,stabiliser	S051266	
	2009.06-2015.12	Rear Axle Left & Right	SUV 4WD G4KE		Rod/Strut,stabiliser	S050224	
	2009.06-2015.12	Front Axle	SUV 4WD G4KE	Date to:2012.09	Stabiliser Bushing	517821	
	2009.06-2015.12	Rear Axle	SUV 4WD G4KE		Stabiliser Bushing	517319	
	2015.01-	Front Axle Left & Right	SUV FWD G4KE		Tie Rod Axle Joint	S031071	
	2015.01-	Front Axle Left & Right	SUV FWD G4KE		Tie Rod Axle Joint	S031072	
	2015.01-	Front Axle	SUV 4WD G4KE		Stabiliser Bushing	535186	
	2.5 (103 kw)	2002.08-2011.03	Front Axle Left Lower	SUV 4WD D4CB		Track Control Arm	S060549
		2002.08-2011.03	Front Axle Left Upper	SUV 4WD D4CB	Date to:2002.09	Track Control Arm	S061268
		2002.08-2011.03	Front Axle Right Lower	SUV 4WD D4CB		Track Control Arm	S060548
		2002.08-2011.03	Front Axle Right Upper	SUV 4WD D4CB	Chassis no.:JC521	Track Control Arm	S061269
		2002.08-2011.03	Front Axle Left & Right Lower	SUV 4WD D4CB		Control Arm Bushing	516333
		2002.08-2011.03	Front Axle Left & Right Lower	SUV 4WD D4CB		Control Arm Bushing	516342
2002.08-2011.03		Front Axle Left & Right Lower	SUV 4WD D4CB	Date to:2007.04	Control Arm Bushing	531779	
2002.08-2011.03		Front Axle Left & Right Upper	SUV 4WD D4CB		Control Arm Bushing	516349	
2002.08-2011.03		Rear Axle Left & Right Upper	SUV 4WD D4CB	Date to:2009.08	Control Arm Bushing	516329	
2002.08-2011.03		Rear Axle Left & Right Lower Inner	SUV 4WD D4CB		Control Arm Bushing	516330	
2002.08-2011.03		Rear Axle Left & Right Lower Inner	SUV 4WD D4CB		Control Arm Bushing	516332	
2002.08-2011.03		Rear Axle Left & Right Lower Outer	SUV 4WD D4CB		Control Arm Bushing	516343	
2002.08-2011.03		Rear Axle Left & Right Lower Outer	SUV 4WD D4CB		Control Arm Bushing	516344	
2002.08-2011.03		Front Axle Left	SUV 4WD D4CB		Tie Rod Axle Joint	S030137	
2002.08-2011.03		Front Axle Right	SUV 4WD D4CB		Tie Rod Axle Joint	S030138	
2002.08-2011.03		Front Axle Left	SUV 4WD D4CB		Tie Rod End	S070244	
2002.08-2011.03		Front Axle Right	SUV 4WD D4CB		Tie Rod End	S070243	
2002.08-2011.03		Front Axle Left	SUV 4WD D4CB		Rod/Strut,stabiliser	S050243	
2002.08-2011.03		Front Axle Right	SUV 4WD D4CB		Rod/Strut,stabiliser	S050244	
2002.08-2011.03		Front Axle Left & Right	SUV 4WD D4CB		Rod/Strut,stabiliser	S050242	
2002.08-2011.03		Rear Axle Left	SUV 4WD D4CB		Rod/Strut,stabiliser	S050501	
2002.08-2011.03		Rear Axle Right	SUV 4WD D4CB		Rod/Strut,stabiliser	S050502	
2002.08-2011.03		Rear Axle Left & Right	SUV 4WD D4CB		Rod/Strut,stabiliser	S051287	
2002.08-2011.03		Front Axle	SUV 4WD D4CB		Stabiliser Bushing	517317	
2.5 (125 kw)		2006.09-2011.12	Front Axle Left & Right Lower	SUV 4WD D4CB	Date to:2007.04	Control Arm Bushing	516342
		2006.09-2011.12	Front Axle Left & Right Lower	SUV 4WD D4CB	Date to:2007.04	Control Arm Bushing	531779
		2006.09-2011.12	Rear Axle Left & Right Upper	SUV 4WD D4CB	Date to:2009.08	Control Arm Bushing	516329
		2006.09-2011.12	Rear Axle Left & Right Lower Inner	SUV 4WD D4CB		Control Arm Bushing	516332
	2006.09-2011.12	Rear Axle Left & Right Lower Outer	SUV 4WD D4CB		Control Arm Bushing	516343	
	2006.09-2011.12	Rear Axle Left & Right Lower Outer	SUV 4WD D4CB		Control Arm Bushing	516344	
	2006.09-2011.12	Front Axle Left	SUV 4WD D4CB		Tie Rod Axle Joint	S030137	
	2006.09-2011.12	Front Axle Right	SUV 4WD D4CB		Tie Rod Axle Joint	S030138	
	2006.09-2011.12	Front Axle Left	SUV 4WD D4CB		Tie Rod End	S070244	
	2006.09-2011.12	Front Axle Right	SUV 4WD D4CB		Tie Rod End	S070243	



	 YEAR	FITTING POSITION	BODY STYLE & DRIVE TYPE & ENGINE	REMARKS	PRODUCT	GSP Ref.	
KIA Sorento							
2.5 (125 kw)	2006.09-2011.12	Front Axle Left	SUV 4WD D4CB		Rod/Strut,stabiliser	S050243	
	2006.09-2011.12	Front Axle Right	SUV 4WD D4CB		Rod/Strut,stabiliser	S050244	
	2006.09-2011.12	Rear Axle Left	SUV 4WD D4CB		Rod/Strut,stabiliser	S050501	
	2006.09-2011.12	Rear Axle Right	SUV 4WD D4CB		Rod/Strut,stabiliser	S050502	
	2006.09-2011.12	Rear Axle Left & Right	SUV 4WD D4CB		Rod/Strut,stabiliser	S051287	
3.3 (199 kw)	2015.04-	Front Axle Left & Right	SUV FWD G6DF		Tie Rod Axle Joint	S031071	
	2015.04-	Front Axle Left & Right	SUV FWD G6DF		Tie Rod Axle Joint	S031072	
3.5 (143 kw)	2002.07-2011.12	Front Axle Left Lower	SUV 4WD G6CU		Track Control Arm	S060549	
	2002.07-2011.12	Front Axle Left Upper	SUV 4WD G6CU		Track Control Arm	S061268	
	2002.07-2011.12	Front Axle Right Lower	SUV 4WD G6CU		Track Control Arm	S060548	
	2002.07-2011.12	Front Axle Right Upper	SUV 4WD G6CU		Track Control Arm	S061269	
	2002.07-2011.12	Front Axle Left & Right Lower	SUV 4WD G6CU		Control Arm Bushing	516254	
	2002.07-2011.12	Front Axle Left & Right Lower	SUV 4WD G6CU		Control Arm Bushing	516333	
	2002.07-2011.12	Front Axle Left & Right Lower	SUV 4WD G6CU		Control Arm Bushing	516342	
	2002.07-2011.12	Front Axle Left & Right Lower	SUV 4WD G6CU		Control Arm Bushing	531779	
	2002.07-2011.12	Front Axle Left & Right Upper	SUV 4WD G6CU		Control Arm Bushing	516349	
	2002.07-2011.12	Rear Axle Left & Right Upper	SUV 4WD G6CU		Control Arm Bushing	516171	
	2002.07-2011.12	Rear Axle Left & Right Upper	SUV 4WD G6CU		Control Arm Bushing	516269	
	2002.07-2011.12	Rear Axle Left & Right Upper	SUV 4WD G6CU	Quantity:4	Control Arm Bushing	516329	
	2002.07-2011.12	Rear Axle Left & Right Lower Inner	SUV 4WD G6CU		Control Arm Bushing	516145	
	2002.07-2011.12	Rear Axle Left & Right Lower Inner	SUV 4WD G6CU		Control Arm Bushing	516330	
	2002.07-2011.12	Rear Axle Left & Right Lower Inner	SUV 4WD G6CU		Control Arm Bushing	516332	
	2002.07-2011.12	Rear Axle Left & Right Lower Outer	SUV 4WD G6CU		Control Arm Bushing	516232	
	2002.07-2011.12	Rear Axle Left & Right Lower Outer	SUV 4WD G6CU		Control Arm Bushing	516343	
	2002.07-2011.12	Rear Axle Left & Right Lower Outer	SUV 4WD G6CU		Control Arm Bushing	516344	
	2002.07-2011.12	Front Axle Left	SUV 4WD G6CU		Tie Rod Axle Joint	S030137	
	2002.07-2011.12	Front Axle Right	SUV 4WD G6CU		Tie Rod Axle Joint	S030138	
	2002.07-2011.12	Front Axle Left	SUV 4WD G6CU		Tie Rod End	S070244	
	2002.07-2011.12	Front Axle Right	SUV 4WD G6CU		Tie Rod End	S070243	
	2002.07-2011.12	Front Axle Left	SUV 4WD G6CU		Rod/Strut,stabiliser	S050243	
	2002.07-2011.12	Front Axle Right	SUV 4WD G6CU		Rod/Strut,stabiliser	S050244	
	2002.07-2011.12	Front Axle Left & Right	SUV 4WD G6CU		Rod/Strut,stabiliser	S050242	
	2002.07-2011.12	Rear Axle Left	SUV 4WD G6CU		Rod/Strut,stabiliser	S050501	
	2002.07-2011.12	Rear Axle Right	SUV 4WD G6CU		Rod/Strut,stabiliser	S050502	
	2002.07-2011.12	Rear Axle Left & Right	SUV 4WD G6CU		Rod/Strut,stabiliser	S051287	
2002.07-2011.12	Front Axle	SUV 4WD G6CU		Stabiliser Bushing	517317		
3.5 (204 kw)	2013.05-2015.12	Rear Axle Left & Right Lower Inner	SUV 4WD G6DC		Track Control Arm	S062190	
	2013.05-2015.12	Rear Axle Left & Right Upper Inner	SUV FWD G6DC		Track Control Arm	S063220	
	2013.05-2015.12	Front Axle Left & Right Lower	SUV FWD G6DC		Control Arm Bushing	516150	
	2013.05-2015.12	Front Axle Left & Right Lower	SUV 4WD G6DC		Control Arm Bushing	516150	
	2013.05-2015.12	Rear Axle Left & Right Upper	SUV 4WD G6DC	AT,Date to:2014.10	Control Arm Bushing	516269	
	2013.05-2015.12	Rear Axle Left & Right Upper	SUV 4WD G6DC		Control Arm Bushing	516269	
	2013.05-2015.12	Rear Axle Left & Right Lower Outer	SUV FWD G6DC		Control Arm Bushing	516232	
	2013.05-2015.12	Rear Axle Left & Right Lower Outer	SUV 4WD G6DC		Control Arm Bushing	516232	
	2013.05-2015.12	Rear Axle Left & Right Lower Outer	SUV FWD G6DC		Control Arm Bushing	530815	
	2013.05-2015.12	Front Axle Left	SUV FWD G6DC		Tie Rod End	S071706	
	2013.05-2015.12	Front Axle Left	SUV 4WD G6DC		Tie Rod End	S071706	
	2013.05-2015.12	Front Axle Right	SUV FWD G6DC		Tie Rod End	S071707	
	2013.05-2015.12	Front Axle Right	SUV 4WD G6DC		Tie Rod End	S071707	
	2013.05-2015.12	Rear Axle Left	SUV 4WD G6DC		Rod/Strut,stabiliser	S050501	
	2013.05-2015.12	Rear Axle Right	SUV 4WD G6DC		Rod/Strut,stabiliser	S050502	
	2013.05-2015.12	Front Axle	SUV FWD G6DC		Stabiliser Bushing	535186	
	3.5 (206 kw)	2017.07-	Front Axle Left & Right	SUV FWD G6DC		Tie Rod Axle Joint	S031071
		2017.07-	Front Axle Left & Right	SUV FWD G6DC		Tie Rod Axle Joint	S031072
3.8 (196 kw)	2006.09-2011.12	Rear Axle Left & Right Upper	SUV 4WD G6DA		Control Arm Bushing	516329	
	2006.09-2011.12	Rear Axle Left & Right Lower Outer	SUV 4WD G6DA	AT,Date to:2008.12	Control Arm Bushing	516343	
	2006.09-2011.12	Rear Axle Left & Right Lower Outer	SUV 4WD G6DA	AT,Date to:2008.12	Control Arm Bushing	516344	
Soul							
1.6 (91 kw)	2009.09-2011.12	Front Axle Left Lower	Hatchback FWD G4FC	For OE no.545002K200	Track Control Arm	S062713	
	2009.09-2011.12	Front Axle Left Lower	Hatchback FWD G4FC	Equipment Vart.:ALL EXC.1600cc-U2	Track Control Arm	S062971	
	2009.09-2011.12	Front Axle Right Lower	Hatchback FWD G4FC	For OE no.545012K200	Track Control Arm	S062714	
	2009.09-2011.12	Front Axle Right Lower	Hatchback FWD G4FC	Equipment Vart.:ALL EXC.1600cc-U2	Track Control Arm	S062972	
	2009.09-2011.12	Front Axle Left & Right Lower	Hatchback FWD G4FC		Control Arm Bushing	514903	
	2009.09-2011.12	Front Axle Left & Right Lower	Hatchback FWD G4FC	Date to:2011.05	Control Arm Bushing	517263	

	 YEAR	FITTING POSITION	BODY STYLE & DRIVE TYPE & ENGINE	REMARKS	PRODUCT	GSP Ref.
KIA						
Soul						
1.6 (91 kw)	2009.09-2011.12	Front Axle Left & Right Lower	Hatchback FWD G4FC		Control Arm Bushing	530529
	2009.09-2011.12	Front Axle Left	Hatchback FWD G4FC		Tie Rod End	S070229
	2009.09-2011.12	Front Axle Right	Hatchback FWD G4FC		Tie Rod End	S070228
	2009.09-2011.12	Front Axle	Hatchback FWD G4FC		Steering Boot	541025
1.6 (93 kw)	2009.02-2011.12	Front Axle Left Lower	Hatchback FWD G4FC	For OE no.545002K200	Track Control Arm	S062713
	2009.02-2011.12	Front Axle Left Lower	Hatchback FWD G4FC	Equipment Vart.:ALL EXC.1600cc-U2	Track Control Arm	S062971
	2009.02-2011.12	Front Axle Right Lower	Hatchback FWD G4FC	For OE no.545012K200	Track Control Arm	S062714
	2009.02-2011.12	Front Axle Right Lower	Hatchback FWD G4FC	Equipment Vart.:ALL EXC.1600cc-U2	Track Control Arm	S062972
	2009.02-2011.12	Front Axle Left & Right Lower	Hatchback FWD G4FC		Ball Joint	S080507
	2009.02-2011.12	Front Axle Left & Right Lower	Hatchback FWD G4FC		Control Arm Bushing	514903
	2009.02-2011.12	Front Axle Left & Right Lower	Hatchback FWD G4FC	Date to:2011.05	Control Arm Bushing	517263
	2009.02-2011.12	Front Axle Left & Right Lower	Hatchback FWD G4FC	Inner diameter:14.4,Outer diameter:66	Control Arm Bushing	530529
	2009.02-2011.12	Front Axle Left & Right	Hatchback FWD G4FC		Tie Rod Axle Joint	S030721
	2009.02-2011.12	Front Axle Left	Hatchback FWD G4FC		Tie Rod End	S070229
	2009.02-2011.12	Front Axle Right	Hatchback FWD G4FC		Tie Rod End	S070228
	2009.02-2011.12	Front Axle	Hatchback FWD G4FC		Steering Boot	541025
1.6 (94 kw)	2011.01-2014.12	Front Axle	Hatchback FWD F4FA		Steering Boot	541025
Sportage						
2.0 (61 kw)	1997.10-2003.08	Front Axle Left & Right Upper	SUV 4WD RF		Track Control Arm	S061263
	1997.10-2003.08	Front Axle Left & Right Lower	SUV 4WD RF		Ball Joint	S080109
	1997.10-2003.08	Front Axle Left & Right Lower	SUV 4WD RF	for article no.:SCA-4022	Control Arm Bushing	516057
	1997.10-2003.08	Front Axle Left & Right Lower	SUV 4WD RF		Control Arm Bushing	516092
	1997.10-2003.08	Front Axle Left & Right Upper	SUV 4WD RF		Control Arm Bushing	516055
	1997.10-2003.08	Rear Axle Left & Right Lower	SUV 4WD RF		Control Arm Bushing	516051
	1997.10-2003.08	Rear Axle Left & Right Upper	SUV 4WD RF		Control Arm Bushing	516050
	1997.10-2003.08	Rear Axle Left & Right Outer	SUV 4WD RF		Control Arm Bushing	516087
	1997.10-2003.08	Front Axle	SUV 4WD RF		Idler Arm	S010026
	1997.10-2003.08	Front Axle Left	SUV 4WD RF		Rod Assembly	S100059
	1997.10-2003.08	Front Axle Right	SUV 4WD RF		Rod Assembly	S100057
	1997.10-2003.08	Front Axle Left Inner	SUV 4WD RF		Tie Rod End	S071274
	1997.10-2003.08	Front Axle Left Outer	SUV 4WD RF		Tie Rod End	S070982
	1997.10-2003.08	Front Axle Right Inner	SUV 4WD RF		Tie Rod End	S070791
	1997.10-2003.08	Front Axle Right Outer	SUV 4WD RF		Tie Rod End	S071544
	1997.10-2003.08	Front Axle Left & Right	SUV 4WD RF		Rod/Strut,stabliser	S050241
	1997.10-2003.08	Front Axle Left & Right	SUV 4WD RF		Rod/Strut,stabliser	S050659
2.0 (94 kw)	1994.06-2004.04	Front Axle Left & Right Upper	SUV 4WD FE(16V)		Track Control Arm	S061263
	1994.06-2004.04	Front Axle Left & Right Lower	SUV 4WD FE(16V)		Ball Joint	S080109
	1994.06-2004.04	Front Axle Left & Right Lower	SUV 4WD FE(16V)	for article no.:SCA-4022	Control Arm Bushing	516057
	1994.06-2004.04	Front Axle Left & Right Lower	SUV 4WD FE(16V)		Control Arm Bushing	516092
	1994.06-2004.04	Front Axle Left & Right Upper	SUV 4WD FE(16V)		Control Arm Bushing	516055
	1994.06-2004.04	Rear Axle Left & Right Lower	SUV 4WD FE(16V)		Control Arm Bushing	516051
	1994.06-2004.04	Rear Axle Left & Right Upper	SUV 4WD FE(16V)		Control Arm Bushing	516050
	1994.06-2004.04	Rear Axle Left & Right Outer	SUV 4WD FE(16V)		Control Arm Bushing	516087
	1994.06-2004.04	Front Axle	SUV 4WD FE(16V)		Idler Arm	S010026
	1994.06-2004.04	Front Axle Left	SUV 4WD FE(16V)		Rod Assembly	S100059
	1994.06-2004.04	Front Axle Right	SUV 4WD FE(16V)		Rod Assembly	S100057
	1994.06-2004.04	Front Axle Left Inner	SUV 4WD FE(16V)		Tie Rod End	S071274
	1994.06-2004.04	Front Axle Left Outer	SUV 4WD FE(16V)		Tie Rod End	S070982
	1994.06-2004.04	Front Axle Right Inner	SUV 4WD FE(16V)		Tie Rod End	S070791
	1994.06-2004.04	Front Axle Right Outer	SUV 4WD FE(16V)		Tie Rod End	S071544
	1994.06-2004.04	Front Axle Left & Right	SUV 4WD FE(16V)		Rod/Strut,stabliser	S050241
	1994.06-2004.04	Front Axle Left & Right	SUV 4WD FE(16V)		Rod/Strut,stabliser	S050659
2.0 (95 kw)	1998.11-2004.08	Front Axle Left & Right Lower	SUV 4WD FE		Control Arm Bushing	516092
	1998.11-2004.08	Rear Axle Left & Right Lower	SUV 4WD FE		Control Arm Bushing	516051
	1998.11-2004.08	Rear Axle Left & Right Upper	SUV 4WD FE		Control Arm Bushing	516050
	1998.11-2004.08	Rear Axle Left & Right Outer	SUV 4WD FE		Control Arm Bushing	516087
2.0 (104 kw)	2004.07-	Front Axle Left Lower	SUV FWD G4GC		Track Control Arm	S060835
	2004.07-	Front Axle Right Lower	SUV FWD G4GC		Track Control Arm	S060836
	2004.07-	Rear Axle Left & Right Lower Inner	SUV FWD G4GC	Date from:2010.03	Track Control Arm	S062191
	2004.07-	Rear Axle Left & Right Lower Inner	SUV FWD G4GC		Track Control Arm	S063124
	2004.07-	Front Axle Left & Right Lower	SUV FWD G4GC		Ball Joint	S080092
	2004.07-	Front Axle Left & Right Lower	SUV FWD G4GC		Control Arm Bushing	513688
	2004.07-	Rear Axle Left Centre	SUV FWD G4GC		Control Arm Bushing	530812
	2004.07-	Rear Axle Right Centre	SUV FWD G4GC		Control Arm Bushing	530813



	 YEAR	FITTING POSITION	BODY STYLE & DRIVE TYPE & ENGINE	REMARKS	PRODUCT	GSP Ref.	
KIA Sportage 2.0 (104 kw)	2004.07-	Rear Axle Left & Right Lower Inner	SUV FWD G4GC		Control Arm Bushing	517342	
	2004.07-	Rear Axle Left & Right Lower	SUV FWD G4GC		Control Arm Bushing	516030	
	2004.07-	Rear Axle Left & Right Lower	SUV FWD G4GC		Control Arm Bushing	516149	
	2004.07-	Rear Axle Left & Right Lower Outer	SUV FWD G4GC		Control Arm Bushing	516180	
	2004.07-	Rear Axle Left & Right Lower Outer	SUV FWD G4GC		Control Arm Bushing	516232	
	2004.07-	Front Axle Left & Right	SUV FWD G4GC		Tie Rod Axle Joint	S030127	
	2004.07-	Front Axle Left	SUV FWD G4GC		Tie Rod End	S070218	
	2004.07-	Front Axle Right	SUV FWD G4GC		Tie Rod End	S070217	
	2004.07-	Front Axle Left & Right	SUV FWD G4GC	Date to:2010.05	Rod/Strut,stabiliser	S050208	
	2004.07-	Front Axle Left & Right	SUV FWD G4GC	Date from:2010.03	Rod/Strut,stabiliser	S050592	
	2004.07-	Rear Axle Left & Right	SUV FWD G4GC		Rod/Strut,stabiliser	S050207	
	2004.07-	Rear Axle	SUV FWD G4GC	Date from:2009.04	Stabiliser Bushing	517320	
	2004.07-	Front Axle	SUV FWD G4GC		Steering Boot	540420	
	2004.07-	Front Axle	SUV FWD G4GC		Steering Rack Bellow Kit	540420S	
	2004.07-2010.05	Front Axle Left Lower	SUV 4WD G4GC		Track Control Arm	S060835	
	2004.07-2010.05	Front Axle Right Lower	SUV 4WD G4GC		Track Control Arm	S060836	
	2004.07-2010.05	Rear Axle Left & Right Lower Inner	SUV 4WD G4GC		Track Control Arm	S063124	
	2004.07-2010.05	Rear Axle Left & Right Lower Outer	SUV 4WD G4GC	For OE no.55220-2E500	Track Control Arm	S061708	
	2004.07-2010.05	Front Axle Left & Right Lower	SUV 4WD G4GC		Ball Joint	S080092	
	2004.07-2010.05	Front Axle Left & Right Lower	SUV 4WD G4GC		Control Arm Bushing	513688	
	2004.07-2010.05	Rear Axle Left Centre	SUV 4WD G4GC		Control Arm Bushing	530812	
	2004.07-2010.05	Rear Axle Right Centre	SUV 4WD G4GC		Control Arm Bushing	530813	
	2004.07-2010.05	Rear Axle Left & Right Upper	SUV 4WD G4GC	Date from:2010.03	Control Arm Bushing	530816	
	2004.07-2010.05	Rear Axle Left & Right Lower Inner	SUV 4WD G4GC		Control Arm Bushing	517342	
	2004.07-2010.05	Rear Axle Left & Right Lower	SUV 4WD G4GC		Control Arm Bushing	516030	
	2004.07-2010.05	Rear Axle Left & Right Lower	SUV 4WD G4GC		Control Arm Bushing	516149	
	2004.07-2010.05	Rear Axle Left & Right Lower Outer	SUV 4WD G4GC		Control Arm Bushing	516180	
	2004.07-2010.05	Rear Axle Left & Right Lower Outer	SUV 4WD G4GC		Control Arm Bushing	516232	
	2004.07-2010.05	Rear Axle Left & Right Lower Outer	SUV 4WD G4GC	Date from:2010.03	Control Arm Bushing	530814	
	2004.07-2010.05	Front Axle Left & Right	SUV 4WD G4GC		Tie Rod Axle Joint	S030127	
	2004.07-2010.05	Front Axle Left	SUV 4WD G4GC		Tie Rod End	S070218	
	2004.07-2010.05	Front Axle Right	SUV 4WD G4GC		Tie Rod End	S070217	
	2004.07-2010.05	Front Axle Left & Right	SUV 4WD G4GC	Date to:2010.05	Rod/Strut,stabiliser	S050208	
	2004.07-2010.05	Front Axle Left & Right	SUV 4WD G4GC	Date from:2010.03	Rod/Strut,stabiliser	S050592	
	2004.07-2010.05	Rear Axle Left & Right	SUV 4WD G4GC		Rod/Strut,stabiliser	S050207	
	2004.07-2010.05	Rear Axle	SUV 4WD G4GC	Date from:2009.04	Stabiliser Bushing	517320	
	2004.07-2010.05	Front Axle	SUV 4WD G4GC		Steering Boot	540420	
	2004.07-2010.05	Front Axle	SUV 4WD G4GC		Steering Rack Bellow Kit	540420S	
	2.0 (120 kw)	2010.06-2015.12	Front Axle Left Lower	SUV 4WD G4KD		Track Control Arm	S061259
		2010.06-2015.12	Front Axle Right Lower	SUV 4WD G4KD		Track Control Arm	S061260
		2010.06-2015.12	Rear Axle Left & Right Upper	SUV 4WD G4KD		Track Control Arm	S062188
		2010.06-2015.12	Rear Axle Left & Right Lower Inner	SUV 4WD G4KD		Track Control Arm	S062190
2010.06-2015.12		Rear Axle Left & Right Lower Inner	SUV 4WD G4KD		Track Control Arm	S062810	
2010.06-2015.12		Front Axle Left & Right Lower	SUV 4WD G4KD		Ball Joint	S080501	
2010.06-2015.12		Front Axle Left & Right Lower	SUV 4WD G4KD	for article no.:SCA-4121,SCA-4120	Control Arm Bushing	517304	
2010.06-2015.12		Front Axle Left & Right Lower	SUV 4WD G4KD		Control Arm Bushing	517305	
2010.06-2015.12		Rear Axle Left Centre	SUV 4WD G4KD		Control Arm Bushing	530812	
2010.06-2015.12		Rear Axle Right Centre	SUV 4WD G4KD		Control Arm Bushing	530813	
2010.06-2015.12		Rear Axle Left & Right Upper	SUV 4WD G4KD		Control Arm Bushing	530816	
2010.06-2015.12		Rear Axle Left & Right Lower Inner	SUV 4WD G4KD	Veh Prd Country: South Korea	Control Arm Bushing	516232	
2010.06-2015.12		Rear Axle Left & Right Lower Inner	SUV 4WD G4KD		Control Arm Bushing	535262	
2010.06-2015.12		Rear Axle Left & Right Lower Outer	SUV 4WD G4KD		Control Arm Bushing	516149	
2010.06-2015.12		Rear Axle Left & Right Lower Outer	SUV 4WD G4KD	Veh Prd Country:South Korea	Control Arm Bushing	530814	
2010.06-2015.12		Rear Axle Left & Right Lower Outer	SUV 4WD G4KD		Control Arm Bushing	530814	
2010.06-2015.12		Front Axle Left & Right	SUV 4WD G4KD		Tie Rod Axle Joint	S030575	
2010.06-2015.12		Front Axle Left	SUV 4WD G4KD		Tie Rod End	S070766	
2010.06-2015.12		Front Axle Right	SUV 4WD G4KD		Tie Rod End	S070767	
2010.06-2015.12		Front Axle Left & Right	SUV 4WD G4KD		Rod/Strut,stabiliser	S050592	
2010.06-2015.12		Rear Axle Left & Right	SUV 4WD G4KD		Rod/Strut,stabiliser	S050667	
2010.06-2015.12		Front Axle	SUV 4WD G4KD		Stabiliser Bushing	517314	
2010.06-2015.12		Front Axle	SUV 4WD G4KD		Stabiliser Bushing	531832	
2010.06-2015.12		Rear Axle	SUV 4WD G4KD		Stabiliser Bushing	517322	
2.0 (131 kw)	2012.01-2015.12	Rear Axle Left & Right Lower Inner	SUV FWD G4KD		Control Arm Bushing	535262	
	2012.01-2015.12	Rear Axle Left & Right Lower Inner	SUV 4WD G4KD		Control Arm Bushing	535262	



	 YEAR	FITTING POSITION	BODY STYLE & DRIVE TYPE & ENGINE	REMARKS	PRODUCT	GSP Ref.
KIA Sportage						
2.7 (129 kw)	2004.07-2010.05	Front Axle Left Lower	SUV 4WD G6BA		Track Control Arm	S060835
	2004.07-2010.05	Front Axle Right Lower	SUV 4WD G6BA		Track Control Arm	S060836
	2004.07-2010.05	Rear Axle Left & Right Lower Inner	SUV 4WD G6BA		Track Control Arm	S063124
	2004.07-2010.05	Front Axle Left & Right Lower	SUV 4WD G6BA		Ball Joint	S080092
	2004.07-2010.05	Front Axle Left & Right Lower	SUV 4WD G6BA		Control Arm Bushing	513688
	2004.07-2010.05	Rear Axle Left & Right Lower Inner	SUV 4WD G6BA		Control Arm Bushing	517342
	2004.07-2010.05	Rear Axle Left & Right Lower	SUV 4WD G6BA	Type:AT WHEEL CARRIER	Control Arm Bushing	516030
	2004.07-2010.05	Rear Axle Left & Right Lower	SUV 4WD G6BA		Control Arm Bushing	516149
	2004.07-2010.05	Rear Axle Left & Right Lower Outer	SUV 4WD G6BA		Control Arm Bushing	516180
	2004.07-2010.05	Front Axle Left & Right	SUV 4WD G6BA		Tie Rod Axle Joint	S030127
	2004.07-2010.05	Front Axle Left	SUV 4WD G6BA		Tie Rod End	S070218
	2004.07-2010.05	Front Axle Right	SUV 4WD G6BA		Tie Rod End	S070217
	2004.07-2010.05	Front Axle Left & Right	SUV 4WD G6BA		Rod/Strut, stabiliser	S050208
	2004.07-2010.05	Rear Axle Left & Right	SUV 4WD G6BA		Rod/Strut, stabiliser	S050207
	2004.07-2010.05	Rear Axle	SUV 4WD G6BA	Date from:2009.04	Stabiliser Bushing	517320
	2004.07-2010.05	Front Axle	SUV 4WD G6BA		Steering Boot	540420
	2004.07-2010.05	Front Axle	SUV 4WD G6BA		Steering Rack Bellow Kit	540420S
LADA Kalinka						
1.6 (56 kw)	1988.01-2001.10	Front Axle Left & Right Lower	Saloon RWD B032106		Ball Joint	S080112
	1988.01-2001.10	Front Axle Left & Right	Saloon RWD B032106		Rod Assembly	S100061
	1988.01-2001.10	Front Axle Left	Saloon RWD B032106		Tie Rod End	S070249
	1988.01-2001.10	Front Axle Right	Saloon RWD B032106		Tie Rod End	S070248
	1988.01-2001.10	Front Axle Left & Right	Saloon RWD B032106		Tie Rod End	S070187
Niva						
1.6 (54 kw)	1987.01-1995.03	Front Axle Left & Right Lower	Terrain cab wagon closed 4WD 2121		Ball Joint	S080112
	1987.01-1995.03	Front Axle Left & Right	Terrain cab wagon closed 4WD 2121		Rod Assembly	S100060
	1987.01-1995.03	Front Axle Left & Right	Terrain cab wagon closed 4WD 2121		Tie Rod End	S070187
	1987.01-1995.03	Front Axle Left & Right	Terrain cab wagon closed 4WD 2121		Tie Rod End	S070247
1.7 (59 kw)	1990.07-2002.08	Front Axle Left & Right Lower	Terrain cab wagon closed 4WD 21213/21214		Ball Joint	S080112
	1990.07-2002.08	Front Axle Left & Right	Terrain cab wagon closed 4WD 21213/21214		Rod Assembly	S100060
	1990.07-2002.08	Front Axle Left & Right	Terrain cab wagon closed 4WD 21213/21214		Tie Rod End	S070187
	1990.07-2002.08	Front Axle Left & Right	Terrain cab wagon closed 4WD 21213/21214		Tie Rod End	S070247
Nova						
1.6 (56 kw)	1981.09-1994.05	Front Axle Left & Right Lower	Saloon RWD B032106/BA32106		Ball Joint	S080112
	1981.09-1994.05	Front Axle Left & Right	Saloon RWD B032106/BA32106		Rod Assembly	S100061
	1981.09-1994.05	Front Axle Left	Saloon RWD B032106/BA32106		Tie Rod End	S070249
	1981.09-1994.05	Front Axle Right	Saloon RWD B032106/BA32106		Tie Rod End	S070248
	1981.09-1994.05	Front Axle Left & Right	Saloon RWD B032106/BA32106		Tie Rod End	S070187
Samara						
1.5 (55 kw)	1986.01-1996.12	Front Axle Left & Right Lower	Hatchback FWD 21083		Ball Joint	S080111
	1986.01-1996.12	Front Axle Left	Hatchback FWD 21083		Tie Rod End	S070246
	1986.01-1996.12	Front Axle Right	Hatchback FWD 21083		Tie Rod End	S070245
Taiga						
1.7 (59 kw)	1994.11-2011.09	Front Axle Left & Right Lower	Terrain cab wagon closed 4WD 21213		Ball Joint	S080112
	1994.11-2011.09	Front Axle Left & Right	Terrain cab wagon closed 4WD 21213		Rod Assembly	S100060
	1994.11-2011.09	Front Axle Left & Right	Terrain cab wagon closed 4WD 21213		Tie Rod End	S070187
	1994.11-2011.09	Front Axle Left & Right	Terrain cab wagon closed 4WD 21213		Tie Rod End	S070247
LAMBORGHINI Murcielago						
6.2 (426 kw)	2001.11-2006.12	Front Axle Left & Right	Coupe 4WD L535		Tie Rod End	S070862
LANCIA Lybra Estate/Wagon						
2.4 (103 kw)	2000.10-2002.04	Front Axle Left Lower	Estate FWD 839A6000		Track Control Arm	S060415
	2000.10-2002.04	Front Axle Right Lower	Estate FWD 839A6000		Track Control Arm	S060414
	2000.10-2002.04	Front Axle Left & Right	Estate FWD 839A6000		Tie Rod End	S070009
	2000.10-2002.04	Front Axle Left & Right	Estate FWD 839A6000		Rod/Strut, stabiliser	S050124
	2000.10-2002.04	Rear Axle Left & Right	Estate FWD 839A6000		Rod/Strut, stabiliser	S051497
LAND ROVER Defender 110						
2.0 (221 kw)	2019.09-	Front Axle Left & Right	Terrain cab wagon closed 4WD PT204		Rod/Strut, stabiliser	S051392
	2019.09-	Rear Axle Left	Terrain cab wagon closed 4WD PT204		Rod/Strut, stabiliser	S051407
	2019.09-	Rear Axle Right	Terrain cab wagon closed 4WD PT204		Rod/Strut, stabiliser	S051406



	 YEAR	FITTING POSITION	BODY STYLE & DRIVE TYPE & ENGINE	REMARKS	PRODUCT	GSP Ref.
LAND ROVER						
Defender 110						
2.4 (90 kw)	2006.10-	Rear Axle Left & Right Lower	Terrain cab wagon closed 4WD DT244	<small>for left-hand drive vehicles, Production no from 7A000001 Date from 2007</small>	Control Arm Bushing	513014
	2006.10-	Rear Axle Left & Right Lower	Terrain cab wagon closed 4WD DT244		Control Arm Bushing	513014
	2006.10-	Front Axle Left	Terrain cab wagon closed 4WD DT244		Tie Rod End	S071775
	2006.10-	Front Axle Right	Terrain cab wagon closed 4WD DT244		Tie Rod End	S071764
	2007.05-	Rear Axle Left & Right Lower	Terrain cab open 4WD DT244		Control Arm Bushing	513014
	2007.05-	Front Axle Left	Terrain cab open 4WD DT244		Tie Rod End	S071775
	2007.05-	Front Axle Right	Terrain cab open 4WD DT244		Tie Rod End	S071764
2.5 (83 kw)	1990.09-1998.12	Rear Axle Left & Right Lower	Terrain cab wagon closed 4WD 11L/16L/23L		Control Arm Bushing	513014
	1990.09-1998.12	Front Axle Left	Terrain cab wagon closed 4WD 11L/16L/23L		Tie Rod End	S071775
	1990.09-1998.12	Front Axle Right	Terrain cab wagon closed 4WD 11L/16L/23L		Tie Rod End	S071764
2.5 (90 kw)	1998.06-2006.09	Rear Axle Left & Right Lower	Terrain cab open 4WD 10P/14P	<small>for left-hand drive vehicles, Production no from 7A000001 Date from 2007</small>	Control Arm Bushing	513014
	1998.06-2006.09	Rear Axle Left & Right Lower	Terrain cab open 4WD 10P/14P	From Chassis:2A626646	Control Arm Bushing	513014
	1998.06-2012.12	Rear Axle Left & Right Lower	Terrain cab wagon closed 4WD 10P/14P/15P		Control Arm Bushing	513014
	1998.06-2012.12	Front Axle Left	Terrain cab wagon closed 4WD 10P/14P/15P		Tie Rod End	S071775
	1998.06-2012.12	Front Axle Right	Terrain cab wagon closed 4WD 10P/14P/15P		Tie Rod End	S071764
Defender 130						
2.4 (90 kw)	2006.10-	Rear Axle Left & Right Lower	Terrain cab wagon closed 4WD DT244	<small>for left-hand drive vehicles, Production no from 7A000001 Date from 2007</small>	Control Arm Bushing	513014
	2006.10-	Rear Axle Left & Right Lower	Terrain cab wagon closed 4WD DT244		Control Arm Bushing	513014
	2006.10-	Front Axle Left	Terrain cab wagon closed 4WD DT244		Tie Rod End	S071775
	2006.10-	Front Axle Right	Terrain cab wagon closed 4WD DT244		Tie Rod End	S071764
	2007.05-	Rear Axle Left & Right Lower	Terrain cab open 4WD DT244		Control Arm Bushing	513014
	2007.05-	Front Axle Left	Terrain cab open 4WD DT244		Tie Rod End	S071775
	2007.05-	Front Axle Right	Terrain cab open 4WD DT244		Tie Rod End	S071764
2.5 (83 kw)	1995.01-1998.03	Rear Axle Left & Right Lower	Terrain cab wagon closed 4WD 16L		Control Arm Bushing	513014
	1995.01-1998.03	Front Axle Left	Terrain cab wagon closed 4WD 16L		Tie Rod End	S071775
	1995.01-1998.03	Front Axle Right	Terrain cab wagon closed 4WD 16L		Tie Rod End	S071764
2.5 (90 kw)	1998.04-2006.09	Rear Axle Left & Right Lower	Terrain cab open 4WD 10P/14P	<small>for left-hand drive vehicles, Production no from 7A000001 Date from 2007</small>	Control Arm Bushing	513014
	1998.04-2006.09	Rear Axle Left & Right Lower	Terrain cab open 4WD 10P/14P	From Chassis:2A626646	Control Arm Bushing	513014
	1998.06-2007.07	Rear Axle Left & Right Lower	Terrain cab wagon closed 4WD 10P/14P/15P		Control Arm Bushing	513014
	1998.06-2007.07	Front Axle Left	Terrain cab wagon closed 4WD 10P/14P/15P		Tie Rod End	S071775
	1998.06-2007.07	Front Axle Right	Terrain cab wagon closed 4WD 10P/14P/15P		Tie Rod End	S071764
Defender 90						
2.0 (221 kw)	2019.09-	Front Axle Left & Right	Terrain cab wagon closed 4WD PT204		Rod/Strut, stabiliser	S051392
	2019.09-	Rear Axle Left	Terrain cab wagon closed 4WD PT204		Rod/Strut, stabiliser	S051407
	2019.09-	Rear Axle Right	Terrain cab wagon closed 4WD PT204		Rod/Strut, stabiliser	S051406
2.4 (90 kw)	2006.10-	Rear Axle Left & Right Lower	Terrain cab wagon closed 4WD DT244	<small>for left-hand drive vehicles, Production no from 7A000001 Date from 2007</small>	Control Arm Bushing	513014
	2006.10-	Rear Axle Left & Right Lower	Terrain cab wagon closed 4WD DT244		Control Arm Bushing	513014
	2006.10-	Front Axle Left	Terrain cab wagon closed 4WD DT244		Tie Rod End	S071775
	2006.10-	Front Axle Right	Terrain cab wagon closed 4WD DT244		Tie Rod End	S071764
2.5 (83 kw)	1990.09-1998.12	Rear Axle Left & Right Lower	Terrain cab wagon closed 4WD 11L/16L/23L		Control Arm Bushing	513014
	1990.09-1998.12	Front Axle Left	Terrain cab wagon closed 4WD 11L/16L/23L		Tie Rod End	S071775
	1990.09-1998.12	Front Axle Right	Terrain cab wagon closed 4WD 11L/16L/23L		Tie Rod End	S071764
2.5 (90 kw)	1998.06-2007.07	Rear Axle Left & Right Lower	Terrain cab open 4WD 10P/14P/15P	<small>for left-hand drive vehicles, Production no from 7A000001 Date from 2007</small>	Control Arm Bushing	513014
	1998.06-2007.07	Rear Axle Left & Right Lower	Terrain cab open 4WD 10P/14P/15P	From Chassis:2A626646	Control Arm Bushing	513014
	1998.06-2007.07	Rear Axle Left & Right Lower	Terrain cab wagon closed 4WD 10P/14P/15P		Control Arm Bushing	513014
	1998.06-2007.07	Front Axle Left	Terrain cab wagon closed 4WD 10P/14P/15P		Tie Rod End	S071775
	1998.06-2007.07	Front Axle Right	Terrain cab wagon closed 4WD 10P/14P/15P		Tie Rod End	S071764
Discovery						
2.5 (100 kw)	1998.11-2004.06	Rear Axle Left & Right Lower	Terrain cab wagon closed 4WD 15P		Control Arm Bushing	513014
	1998.11-2004.06	Front Axle Left & Right	Terrain cab wagon closed 4WD 15P		Rod Assembly	S100172
	1998.11-2004.06	Front Axle Left & Right	Terrain cab wagon closed 4WD 15P	for right-hand drive vehicles	Rod Assembly	S100417
3.0 (155 kw)	2009.09-2018.12	Front Axle Left Upper	Terrain cab wagon closed 4WD 306DT		Track Control Arm	S061765
	2009.09-2018.12	Front Axle Right Upper	Terrain cab wagon closed 4WD 306DT		Track Control Arm	S061766
	2009.09-2018.12	Front Axle Left & Right Lower	Terrain cab wagon closed 4WD 306DT		Ball Joint	S080995
	2009.09-2018.12	Front Axle Left & Right Upper	Terrain cab wagon closed 4WD 306DT		Ball Joint	S080312
	2009.09-2018.12	Front Axle Left & Right Lower	Terrain cab wagon closed 4WD 306DT	for armoured vehicles	Control Arm Bushing	530166
	2009.09-2018.12	Front Axle Left & Right Lower	Terrain cab wagon closed 4WD 306DT	Suspension:Normal Suspension	Control Arm Bushing	532976
	2009.09-2018.12	Front Axle Left & Right Lower	Terrain cab wagon closed 4WD 306DT		Control Arm Bushing	532976
	2009.09-2018.12	Front Axle Left & Right Lower	Terrain cab wagon closed 4WD 306DT	Suspension:Normal Suspension	Control Arm Bushing	532977
	2009.09-2018.12	Rear Axle Left & Right Lower	Terrain cab wagon closed 4WD 306DT	<small>Production no from AA518772, AA000001, Production no to AA518769</small>	Control Arm Bushing	516482
	2009.09-2018.12	Rear Axle Left & Right Lower	Terrain cab wagon closed 4WD 306DT		Control Arm Bushing	516496
	2009.09-2018.12	Rear Axle Left & Right Upper	Terrain cab wagon closed 4WD 306DT		Control Arm Bushing	533918
	2009.09-2018.12	Rear Axle Left & Right	Terrain cab wagon closed 4WD 306DT		Rod Assembly	S100421
	2009.09-2018.12	Front Axle Left	Terrain cab wagon closed 4WD 306DT		Tie Rod Axle Joint	S030387

	 YEAR	FITTING POSITION	BODY STYLE & DRIVE TYPE & ENGINE	REMARKS	PRODUCT	GSP Ref.	
LAND ROVER Discovery							
3.0 (155 kw)	2009.09-2018.12	Front Axle Right	Terrain cab wagon closed 4WD 306DT		Tie Rod Axle Joint	S030388	
	2009.09-2018.12	Front Axle Left	Terrain cab wagon closed 4WD 306DT		Rod/Strut, stabiliser	S050518	
	2009.09-2018.12	Front Axle Right	Terrain cab wagon closed 4WD 306DT		Rod/Strut, stabiliser	S051288	
	2009.09-2018.12	Front Axle Left & Right	Terrain cab wagon closed 4WD 306DT		Rod/Strut, stabiliser	S051326	
	2009.09-2018.12	Rear Axle Left & Right	Terrain cab wagon closed 4WD 306DT		Rod/Strut, stabiliser	S050515	
3.0 (180 kw)	2009.09-2018.12	Front Axle Left Upper	Terrain cab wagon closed 4WD 306DT		Track Control Arm	S061765	
	2009.09-2018.12	Front Axle Right Upper	Terrain cab wagon closed 4WD 306DT		Track Control Arm	S061766	
	2009.09-2018.12	Front Axle Left & Right Lower	Terrain cab wagon closed 4WD 306DT		Ball Joint	S080995	
	2009.09-2018.12	Front Axle Left & Right Upper	Terrain cab wagon closed 4WD 306DT		Ball Joint	S080312	
	2009.09-2018.12	Front Axle Left & Right Lower	Terrain cab wagon closed 4WD 306DT	for armoured vehicles	Control Arm Bushing	530166	
	2009.09-2018.12	Front Axle Left & Right Lower	Terrain cab wagon closed 4WD 306DT	Suspension:Normal Suspension	Control Arm Bushing	532976	
	2009.09-2018.12	Front Axle Left & Right Lower	Terrain cab wagon closed 4WD 306DT		Control Arm Bushing	532976	
	2009.09-2018.12	Front Axle Left & Right Lower	Terrain cab wagon closed 4WD 306DT	Suspension:Normal Suspension	Control Arm Bushing	532977	
	2009.09-2018.12	Rear Axle Left & Right Lower	Terrain cab wagon closed 4WD 306DT	Production no.from:AA518770.AA000001:Production no.to:AA518780.Date from:2010	Control Arm Bushing	516482	
	2009.09-2018.12	Rear Axle Left & Right Lower	Terrain cab wagon closed 4WD 306DT		Control Arm Bushing	516496	
	2009.09-2018.12	Rear Axle Left & Right Upper	Terrain cab wagon closed 4WD 306DT		Control Arm Bushing	533918	
	2009.09-2018.12	Rear Axle Left & Right	Terrain cab wagon closed 4WD 306DT		Rod Assembly	S100421	
	2009.09-2018.12	Front Axle Left	Terrain cab wagon closed 4WD 306DT		Tie Rod Axle Joint	S030387	
	2009.09-2018.12	Front Axle Right	Terrain cab wagon closed 4WD 306DT		Tie Rod Axle Joint	S030388	
	2009.09-2018.12	Front Axle Left	Terrain cab wagon closed 4WD 306DT		Rod/Strut, stabiliser	S050518	
	2009.09-2018.12	Front Axle Right	Terrain cab wagon closed 4WD 306DT		Rod/Strut, stabiliser	S051288	
	2009.09-2018.12	Front Axle Left & Right	Terrain cab wagon closed 4WD 306DT		Rod/Strut, stabiliser	S051326	
	2009.09-2018.12	Rear Axle Left & Right	Terrain cab wagon closed 4WD 306DT		Rod/Strut, stabiliser	S050515	
	3.0 (188 kw)	2009.09-2018.12	Front Axle Left Upper	Terrain cab wagon closed 4WD 306DT		Track Control Arm	S061765
		2009.09-2018.12	Front Axle Right Upper	Terrain cab wagon closed 4WD 306DT		Track Control Arm	S061766
2009.09-2018.12		Front Axle Left & Right Lower	Terrain cab wagon closed 4WD 306DT		Ball Joint	S080995	
2009.09-2018.12		Front Axle Left & Right Upper	Terrain cab wagon closed 4WD 306DT		Ball Joint	S080312	
2009.09-2018.12		Front Axle Left & Right Lower	Terrain cab wagon closed 4WD 306DT	for armoured vehicles	Control Arm Bushing	530166	
2009.09-2018.12		Front Axle Left & Right Lower	Terrain cab wagon closed 4WD 306DT	Suspension:Normal Suspension	Control Arm Bushing	532976	
2009.09-2018.12		Front Axle Left & Right Lower	Terrain cab wagon closed 4WD 306DT		Control Arm Bushing	532976	
2009.09-2018.12		Front Axle Left & Right Lower	Terrain cab wagon closed 4WD 306DT	Suspension:Normal Suspension	Control Arm Bushing	532977	
2009.09-2018.12		Rear Axle Left & Right Lower	Terrain cab wagon closed 4WD 306DT	Production no.from:AA518770.AA000001:Date from:2010	Control Arm Bushing	516482	
2009.09-2018.12		Rear Axle Left & Right Lower	Terrain cab wagon closed 4WD 306DT		Control Arm Bushing	516496	
2009.09-2018.12		Rear Axle Left & Right Upper	Terrain cab wagon closed 4WD 306DT		Control Arm Bushing	533918	
2009.09-2018.12		Rear Axle Left & Right	Terrain cab wagon closed 4WD 306DT		Rod Assembly	S100421	
2009.09-2018.12		Front Axle Left	Terrain cab wagon closed 4WD 306DT		Tie Rod Axle Joint	S030387	
2009.09-2018.12		Front Axle Right	Terrain cab wagon closed 4WD 306DT		Tie Rod Axle Joint	S030388	
2009.09-2018.12		Front Axle Left	Terrain cab wagon closed 4WD 306DT		Rod/Strut, stabiliser	S050518	
2009.09-2018.12		Front Axle Right	Terrain cab wagon closed 4WD 306DT		Rod/Strut, stabiliser	S051288	
2009.09-2018.12		Front Axle Left & Right	Terrain cab wagon closed 4WD 306DT		Rod/Strut, stabiliser	S051326	
2009.09-2018.12		Rear Axle Left & Right	Terrain cab wagon closed 4WD 306DT		Rod/Strut, stabiliser	S050515	
3.0 (190 kw)		2016.09-	Front Axle Left Upper	SUV 4WD 306DT		Track Control Arm	S063130
		2016.09-	Front Axle Left Lower Outer	SUV 4WD 306DT		Track Control Arm	S063073
	2016.09-	Front Axle Right Upper	SUV 4WD 306DT		Track Control Arm	S063131	
	2016.09-	Front Axle Right Lower Outer	SUV 4WD 306DT		Track Control Arm	S063072	
	2016.09-	Front Axle Left & Right Lower Outer	SUV 4WD 306DT		Control Arm Bushing	533928	
	2016.09-	Front Axle Left & Right	SUV 4WD 306DT		Rod/Strut, stabiliser	S051392	
	2016.09-	Rear Axle Left	SUV 4WD 306DT		Rod/Strut, stabiliser	S051407	
	2016.09-	Rear Axle Right	SUV 4WD 306DT		Rod/Strut, stabiliser	S051406	
3.0 (250 kw)	2016.09-	Front Axle Left Upper	SUV 4WD 306PS		Track Control Arm	S063130	
	2016.09-	Front Axle Left Lower Outer	SUV 4WD 306PS		Track Control Arm	S063073	
	2016.09-	Front Axle Right Upper	SUV 4WD 306PS		Track Control Arm	S063131	
	2016.09-	Front Axle Right Lower Outer	SUV 4WD 306PS		Track Control Arm	S063072	
	2016.09-	Front Axle Left & Right Lower Outer	SUV 4WD 306PS		Control Arm Bushing	533928	
	2016.09-	Front Axle Left & Right	SUV 4WD 306PS		Rod/Strut, stabiliser	S051392	
	2016.09-	Rear Axle Left	SUV 4WD 306PS		Rod/Strut, stabiliser	S051407	
2016.09-	Rear Axle Right	SUV 4WD 306PS		Rod/Strut, stabiliser	S051406		
4.0 (136 kw)	1998.11-2004.06	Front Axle Left & Right Lower	Terrain cab wagon closed 4WD 56D		Ball Joint	S080338	
	1998.11-2004.06	Front Axle Left & Right Upper	Terrain cab wagon closed 4WD 56D		Ball Joint	S080337	
	1998.11-2004.06	Rear Axle Left & Right Lower	Terrain cab wagon closed 4WD 56D		Control Arm Bushing	513014	
	1998.11-2004.06	Front Axle Left & Right	Terrain cab wagon closed 4WD 56D		Rod Assembly	S100172	
	1998.11-2004.06	Front Axle Left & Right	Terrain cab wagon closed 4WD 56D	for right-hand drive vehicles	Rod Assembly	S100417	
	1998.11-2004.06	Front Axle Left & Right	Terrain cab wagon closed 4WD 56D		Tie Rod End	S070598	
	1998.11-2004.06	Front Axle Left & Right	Terrain cab wagon closed 4WD 56D		Rod/Strut, stabiliser	S050511	



 YEAR	FITTING POSITION	BODY STYLE & DRIVE TYPE & ENGINE	REMARKS	PRODUCT	GSP Ref.	
LAND ROVER						
Discovery						
4.0 (136 kw)	1998.11-2004.06	Rear Axle Left & Right	Terrain cab wagon closed 4WD 56D	Rod/Strut, stabiliser	S050512	
4.4 (220 kw)	2004.07-2009.08	Front Axle Left Lower	Terrain cab wagon closed 4WD 448PN	Track Control Arm	S060849	
	2004.07-2009.08	Front Axle Left Upper	Terrain cab wagon closed 4WD 448PN	Track Control Arm	S062715	
	2004.07-2009.08	Front Axle Right Lower	Terrain cab wagon closed 4WD 448PN	Track Control Arm	S060850	
	2004.07-2009.08	Front Axle Right Upper	Terrain cab wagon closed 4WD 448PN	Track Control Arm	S062716	
	2004.07-2009.08	Front Axle Left & Right Lower	Terrain cab wagon closed 4WD 448PN	Ball Joint	S080995	
	2004.07-2009.08	Front Axle Left & Right Upper	Terrain cab wagon closed 4WD 448PN	Ball Joint	S080312	
	2004.07-2009.08	Front Axle Left & Right Lower	Terrain cab wagon closed 4WD 448PN	for armoured vehicles Control Arm Bushing	530166	
	2004.07-2009.08	Front Axle Left & Right Lower	Terrain cab wagon closed 4WD 448PN	Control Arm Bushing	532976	
	2004.07-2009.08	Front Axle Left & Right Lower	Terrain cab wagon closed 4WD 448PN	Control Arm Bushing	532977	
	2004.07-2009.08	Rear Axle Left & Right Lower	Terrain cab wagon closed 4WD 448PN	Control Arm Bushing	516482	
	2004.07-2009.08	Rear Axle Left & Right Lower	Terrain cab wagon closed 4WD 448PN	Control Arm Bushing	516496	
	2004.07-2009.08	Rear Axle Left & Right Upper	Terrain cab wagon closed 4WD 448PN	Control Arm Bushing	533918	
	2004.07-2009.08	Rear Axle Left & Right	Terrain cab wagon closed 4WD 448PN	Rod Assembly	S100421	
	2004.07-2009.08	Front Axle Left	Terrain cab wagon closed 4WD 448PN	Tie Rod Axle Joint	S030387	
	2004.07-2009.08	Front Axle Right	Terrain cab wagon closed 4WD 448PN	Tie Rod Axle Joint	S030388	
	2004.07-2009.08	Front Axle Left & Right	Terrain cab wagon closed 4WD 448PN	Tie Rod End	S070582	
	2004.07-2009.08	Front Axle Left	Terrain cab wagon closed 4WD 448PN	Rod/Strut, stabiliser	S050518	
	2004.07-2009.08	Front Axle Right	Terrain cab wagon closed 4WD 448PN	Rod/Strut, stabiliser	S051288	
	2004.07-2009.08	Front Axle Left & Right	Terrain cab wagon closed 4WD 448PN	Rod/Strut, stabiliser	S051326	
	2004.07-2009.08	Rear Axle Left & Right	Terrain cab wagon closed 4WD 448PN	Rod/Strut, stabiliser	S050515	
Discovery III						
4.0 (161 kw)	2005.02-2009.09	Front Axle Left & Right Lower	Closed Off-Road Vehicle AWD 406PN	Control Arm Bushing	532977	
	2005.02-2009.09	Rear Axle Left & Right Lower	Closed Off-Road Vehicle AWD 406PN	Control Arm Bushing	516482	
	2005.02-2009.09	Rear Axle Left & Right	Closed Off-Road Vehicle AWD 406PN	Rod Assembly	S100421	
Discovery Sport						
2.0 (132 kw)	2015.06-	Front Axle Left & Right	SUV 4WD 204DTD	Tie Rod Axle Joint	S030956	
	2015.06-	Front Axle Left	SUV 4WD 204DTD	Tie Rod End	S071689	
	2015.06-	Front Axle Right	SUV 4WD 204DTD	Tie Rod End	S071690	
	2015.06-	Rear Axle Left	SUV 4WD 204DTD	Rod/Strut, stabiliser	S051478	
	2015.06-	Rear Axle Right	SUV 4WD 204DTD	Rod/Strut, stabiliser	S051480	
2.0 (177 kw)	2017.08-	Front Axle Left & Right	SUV 4WD 204DTA	Tie Rod Axle Joint	S030956	
	2017.08-	Front Axle Left	SUV 4WD 204DTA	Tie Rod End	S071689	
	2017.08-	Front Axle Right	SUV 4WD 204DTA	Tie Rod End	S071690	
	2017.08-	Rear Axle Left	SUV 4WD 204DTA	Rod/Strut, stabiliser	S051478	
	2017.08-	Rear Axle Right	SUV 4WD 204DTA	Rod/Strut, stabiliser	S051480	
	2018.12-	Rear Axle Left	SUV 4WD PT204	Rod/Strut, stabiliser	S051478	
2018.12-	Rear Axle Right	SUV 4WD PT204	Rod/Strut, stabiliser	S051480		
2.2 (140 kw)	2014.09-	Front Axle Left & Right	SUV 4WD 224DT	Tie Rod Axle Joint	S030956	
	2014.09-	Front Axle Left	SUV 4WD 224DT	Tie Rod End	S071689	
	2014.09-	Front Axle Right	SUV 4WD 224DT	Tie Rod End	S071690	
	2014.09-	Rear Axle Left	SUV 4WD 224DT	Rod/Strut, stabiliser	S051478	
2014.09-	Rear Axle Right	SUV 4WD 224DT	Rod/Strut, stabiliser	S051480		
Freelander						
2.2 (110 kw)	2006.10-2014.10	Front Axle Left Lower	Terrain cab wagon closed 4WD 224DT	Track Control Arm	S060555	
	2006.10-2014.10	Front Axle Right Lower	Terrain cab wagon closed 4WD 224DT	Track Control Arm	S060554	
	2006.10-2014.10	Front Axle Left Lower	Terrain cab wagon closed 4WD 224DT	Control Arm Bushing	530560	
	2006.10-2014.10	Front Axle Right Lower	Terrain cab wagon closed 4WD 224DT	Control Arm Bushing	530559	
	2006.10-2014.10	Front Axle Left & Right Lower	Terrain cab wagon closed 4WD 224DT	Control Arm Bushing	516450	
	2006.10-2014.10	Front Axle Left & Right Lower	Terrain cab wagon closed 4WD 224DT	Control Arm Bushing	516461	
	2006.10-2014.10	Rear Axle Left & Right Centre	Terrain cab wagon closed 4WD 224DT	Control Arm Bushing	516493	
	2006.10-2014.10	Rear Axle Left & Right Lower Inner	Terrain cab wagon closed 4WD 224DT	Control Arm Bushing	516504	
	2006.10-2014.10	Rear Axle Left & Right Lower Inner	Terrain cab wagon closed 4WD 224DT	Control Arm Bushing	516505	
	2006.10-2014.10	Rear Axle Left & Right Lower Outer	Terrain cab wagon closed 4WD 224DT	Control Arm Bushing	516483	
	2006.10-2014.10	Front Axle Left & Right	Terrain cab wagon closed 4WD 224DT	Tie Rod Axle Joint	S030092	
	2006.10-2014.10	Front Axle Left	Terrain cab wagon closed 4WD 224DT	Tie Rod End	S070175	
	2006.10-2014.10	Front Axle Right	Terrain cab wagon closed 4WD 224DT	Tie Rod End	S070176	
	2006.10-2014.10	Front Axle Left & Right	Terrain cab wagon closed 4WD 224DT	Rod/Strut, stabiliser	S050521	
	2006.10-2014.10	Front Axle	Terrain cab wagon closed 4WD 224DT	Steering Rack Bellow Kit	540481S	
	2.2 (140 kw)	2010.08-2014.10	Front Axle Right Lower	Terrain cab wagon closed 4WD 224DT	Control Arm Bushing	530559
		2010.08-2014.10	Front Axle Left & Right Lower	Terrain cab wagon closed 4WD 224DT	Control Arm Bushing	516450
2010.08-2014.10		Rear Axle Left & Right Centre	Terrain cab wagon closed 4WD 224DT	Control Arm Bushing	516493	
2010.08-2014.10		Rear Axle Left & Right Lower Inner	Terrain cab wagon closed 4WD 224DT	Control Arm Bushing	516504	
2010.08-2014.10		Rear Axle Left & Right Lower Inner	Terrain cab wagon closed 4WD 224DT	Control Arm Bushing	516505	



	 YEAR	FITTING POSITION	BODY STYLE & DRIVE TYPE & ENGINE	REMARKS	PRODUCT	GSP Ref.
LAND ROVER						
Freelander						
2.2 (140 kw)	2010.08-2014.10	Rear Axle Left & Right Lower Outer	Terrain cab wagon closed 4WD 224DT		Control Arm Bushing	516483
	2010.08-2014.10	Front Axle Left	Terrain cab wagon closed 4WD 224DT		Tie Rod End	S070175
	2010.08-2014.10	Front Axle Right	Terrain cab wagon closed 4WD 224DT		Tie Rod End	S070176
	2010.08-2014.10	Front Axle Left & Right	Terrain cab wagon closed 4WD 224DT		Rod/Strut, stabiliser	S050521
2.5 (130 kw)	2000.11-2006.10	Front Axle Left Lower	Terrain cab wagon closed 4WD 25KV6		Track Control Arm	S060841
	2000.11-2006.10	Front Axle Right Lower	Terrain cab wagon closed 4WD 25KV6		Track Control Arm	S060842
	2000.11-2006.10	Front Axle Left & Right Lower	Terrain cab wagon closed 4WD 25KV6		Control Arm Bushing	516450
	2000.11-2006.10	Rear Axle Left & Right Centre	Terrain cab wagon closed 4WD 25KV6		Control Arm Bushing	516493
	2000.11-2006.10	Rear Axle Left & Right Lower	Terrain cab wagon closed 4WD 25KV6	Production no.from:YA548747, 1A000001	Control Arm Bushing	516490
	2000.11-2006.10	Rear Axle Left & Right Lower	Terrain cab wagon closed 4WD 25KV6	Production no.from:YA548747	Control Arm Bushing	516498
	2000.11-2006.10	Rear Axle Left & Right Lower Inner	Terrain cab wagon closed 4WD 25KV6		Control Arm Bushing	516505
	2000.11-2006.10	Rear Axle Left & Right Lower Outer	Terrain cab wagon closed 4WD 25KV6		Control Arm Bushing	516483
	2000.11-2006.10	Front Axle Left	Terrain cab wagon closed 4WD 25KV6		Tie Rod End	S070578
	2000.11-2006.10	Front Axle Right	Terrain cab wagon closed 4WD 25KV6		Tie Rod End	S070579
	2000.11-2006.10	Front Axle Left & Right	Terrain cab wagon closed 4WD 25KV6		Rod/Strut, stabiliser	S050509
	3.2 (171 kw)	2006.10-2014.10	Front Axle Left Lower	Terrain cab wagon closed 4WD 32PDP		Track Control Arm
2006.10-2014.10		Front Axle Right Lower	Terrain cab wagon closed 4WD 32PDP		Track Control Arm	S060554
2006.10-2014.10		Front Axle Right Lower	Terrain cab wagon closed 4WD 32PDP		Control Arm Bushing	530559
2006.10-2014.10		Front Axle Left & Right Lower	Terrain cab wagon closed 4WD 32PDP		Control Arm Bushing	516450
2006.10-2014.10		Rear Axle Left & Right Centre	Terrain cab wagon closed 4WD 32PDP		Control Arm Bushing	516493
2006.10-2014.10		Rear Axle Left & Right Lower Inner	Terrain cab wagon closed 4WD 32PDP		Control Arm Bushing	516504
2006.10-2014.10		Rear Axle Left & Right Lower Inner	Terrain cab wagon closed 4WD 32PDP		Control Arm Bushing	516505
2006.10-2014.10		Rear Axle Left & Right Lower Outer	Terrain cab wagon closed 4WD 32PDP		Control Arm Bushing	516483
2006.10-2014.10		Front Axle Left	Terrain cab wagon closed 4WD 32PDP		Tie Rod End	S070175
2006.10-2014.10		Front Axle Right	Terrain cab wagon closed 4WD 32PDP		Tie Rod End	S070176
2006.10-2014.10		Front Axle Left & Right	Terrain cab wagon closed 4WD 32PDP		Rod/Strut, stabiliser	S050521
Range Rover						
3.0 (190 kw)	2012.10-	Front Axle Left Upper	SUV 4WD 306DT		Track Control Arm	S063130
	2012.10-	Front Axle Left Lower Outer	SUV 4WD 306DT		Track Control Arm	S063073
	2012.10-	Front Axle Right Upper	SUV 4WD 306DT		Track Control Arm	S063131
	2012.10-	Front Axle Right Lower Outer	SUV 4WD 306DT		Track Control Arm	S063072
	2012.10-	Front Axle Left & Right Lower Outer	SUV 4WD 306DT		Control Arm Bushing	533928
	2012.10-	Front Axle Left & Right	SUV 4WD 306DT		Tie Rod Axle Joint	S030960
	2012.10-	Front Axle Left & Right	SUV 4WD 306DT		Tie Rod End	S071695
	2012.10-	Front Axle Left & Right	SUV 4WD 306DT		Rod/Strut, stabiliser	S051392
	2012.10-	Rear Axle Left	SUV 4WD 306DT	Wheelbase:Centre Wheelbase(standard)	Rod/Strut, stabiliser	S051397
	2012.10-	Rear Axle Left	SUV 4WD 306DT	Wheelbase:Long Wheelbase	Rod/Strut, stabiliser	S051407
	2012.10-	Rear Axle Right	SUV 4WD 306DT	Wheelbase:Centre Wheelbase(standard)	Rod/Strut, stabiliser	S051398
	2012.10-	Rear Axle Right	SUV 4WD 306DT	Wheelbase:Long Wheelbase	Rod/Strut, stabiliser	S051406
4.0 (136 kw)	1995.01-2002.08	Front Axle Left	Terrain cab wagon closed 4WD 58D		Rod Assembly	S100424
	1995.01-2002.08	Front Axle Right	Terrain cab wagon closed 4WD 58D		Rod Assembly	S100425
	1995.01-2002.08	Front Axle Left & Right	Terrain cab wagon closed 4WD 58D		Rod Assembly	S100178
	1995.01-2002.08	Front Axle Left & Right	Terrain cab wagon closed 4WD 58D	for left-hand drive vehicles	Rod Assembly	S100416
	1995.01-2002.08	Front Axle Left & Right	Terrain cab wagon closed 4WD 58D		Tie Rod End	S070598
4.3 (149 kw)	1992.09-1994.07	Front Axle Left & Right	Terrain cab wagon closed 4WD 40D		Tie Rod End	S070598
4.4 (210 kw)	2002.03-2005.12	Front Axle Left Lower Outer	Terrain cab wagon closed 4WD 44SDEX		Track Control Arm	S060847
	2002.03-2005.12	Front Axle Right Lower Outer	Terrain cab wagon closed 4WD 44SDEX		Track Control Arm	S060848
	2002.03-2005.12	Front Axle Left & Right Lower Inner	Terrain cab wagon closed 4WD 44SDEX		Track Control Arm	S060846
	2002.03-2005.12	Front Axle Left & Right Upper	Terrain cab wagon closed 4WD 44SDEX		Ball Joint	S080309
	2002.03-2005.12	Front Axle Left & Right Upper	Terrain cab wagon closed 4WD 44SDEX		Control Arm Bushing	535282
	2002.03-2005.12	Rear Axle Left & Right Lower	Terrain cab wagon closed 4WD 44SDEX	From Chassis:4A174096	Control Arm Bushing	516481
	2002.03-2005.12	Rear Axle Left & Right Lower	Terrain cab wagon closed 4WD 44SDEX		Control Arm Bushing	516506
	2002.03-2005.12	Rear Axle Left & Right Upper	Terrain cab wagon closed 4WD 44SDEX		Control Arm Bushing	533910
	2002.03-2005.12	Front Axle Left & Right	Terrain cab wagon closed 4WD 44SDEX		Tie Rod End	S070581
	2002.03-2005.12	Front Axle Left & Right	Terrain cab wagon closed 4WD 44SDEX		Rod/Strut, stabiliser	S050514
	2002.03-2005.12	Rear Axle Left & Right	Terrain cab wagon closed 4WD 44SDEX	For OE no.RGD000180	Rod/Strut, stabiliser	S051381
	2002.03-2005.12	Rear Axle Left & Right	Terrain cab wagon closed 4WD 44SDEX	For OE no.RGD500131	Rod/Strut, stabiliser	S051391
	2002.03-2005.12	Front Axle	Terrain cab wagon closed 4WD 44SDEX		Steering Rack Bellow Kit	540342S
	4.4 (220 kw)	2004.08-2012.08	Front Axle Left Lower Outer	Terrain cab wagon closed 4WD 448PN		Track Control Arm
2004.08-2012.08		Front Axle Right Lower Outer	Terrain cab wagon closed 4WD 448PN		Track Control Arm	S060848
2004.08-2012.08		Front Axle Left & Right Lower Inner	Terrain cab wagon closed 4WD 448PN		Track Control Arm	S060846
2004.08-2012.08		Front Axle Left & Right Upper	Terrain cab wagon closed 4WD 448PN		Ball Joint	S080309
2004.08-2012.08		Front Axle Left & Right Upper	Terrain cab wagon closed 4WD 448PN		Control Arm Bushing	535282
2004.08-2012.08		Front Axle Left & Right	Terrain cab wagon closed 4WD 448PN		Tie Rod End	S070581



	 YEAR	FITTING POSITION	BODY STYLE & DRIVE TYPE & ENGINE	REMARKS	PRODUCT	GSP Ref.
LAND ROVER Range Rover						
4.4 (220 kw)	2004.08-2012.08	Front Axle Left & Right	Terrain cab wagon closed 4WD 448PN		Rod/Strut, stabiliser	S050514
	2004.08-2012.08	Rear Axle Left & Right	Terrain cab wagon closed 4WD 448PN	For OE no.RGD000180	Rod/Strut, stabiliser	S051381
	2004.08-2012.08	Rear Axle Left & Right	Terrain cab wagon closed 4WD 448PN	For OE no.RGD500131	Rod/Strut, stabiliser	S051391
4.4 (230 kw)	2010.09-2012.08	Front Axle Left Lower Outer	Terrain cab wagon closed 4WD 44DD0R		Track Control Arm	S060847
	2010.09-2012.08	Front Axle Right Lower Outer	Terrain cab wagon closed 4WD 44DD0R		Track Control Arm	S060848
	2010.09-2012.08	Front Axle Left & Right Lower Inner	Terrain cab wagon closed 4WD 44DD0R		Track Control Arm	S060846
	2010.09-2012.08	Front Axle Left & Right Upper	Terrain cab wagon closed 4WD 44DD0R		Ball Joint	S080309
	2010.09-2012.08	Front Axle Left & Right Upper	Terrain cab wagon closed 4WD 44DD0R		Control Arm Bushing	535282
	2010.09-2012.08	Rear Axle Left & Right Lower	Terrain cab wagon closed 4WD 44DD0R		Control Arm Bushing	516481
	2010.09-2012.08	Rear Axle Left & Right Lower	Terrain cab wagon closed 4WD 44DD0R		Control Arm Bushing	516506
	2010.09-2012.08	Rear Axle Left & Right Upper	Terrain cab wagon closed 4WD 44DD0R		Control Arm Bushing	533910
	2010.09-2012.08	Front Axle Left & Right	Terrain cab wagon closed 4WD 44DD0R		Tie Rod End	S070581
	2010.09-2012.08	Front Axle Left & Right	Terrain cab wagon closed 4WD 44DD0R		Rod/Strut, stabiliser	S050514
	2010.09-2012.08	Rear Axle Left & Right	Terrain cab wagon closed 4WD 44DD0R	For OE no.RGD000180	Rod/Strut, stabiliser	S051381
	2010.09-2012.08	Rear Axle Left & Right	Terrain cab wagon closed 4WD 44DD0R	For OE no.RGD500131	Rod/Strut, stabiliser	S051391
	2010.09-2012.08	Front Axle	Terrain cab wagon closed 4WD 44DD0R		Steering Rack Bellow Kit	540342S
4.4 (249 kw)	2013.08-	Front Axle Left Upper	SUV 4WD 448DT		Track Control Arm	S063130
	2013.08-	Front Axle Left Lower Outer	SUV 4WD 448DT		Track Control Arm	S063073
	2013.08-	Front Axle Right Upper	SUV 4WD 448DT		Track Control Arm	S063131
	2013.08-	Front Axle Right Lower Outer	SUV 4WD 448DT		Track Control Arm	S063072
	2013.08-	Front Axle Left & Right Lower Outer	SUV 4WD 448DT		Control Arm Bushing	533928
	2013.08-	Front Axle Left & Right	SUV 4WD 448DT		Tie Rod Axle Joint	S030960
	2013.08-	Front Axle Left & Right	SUV 4WD 448DT		Tie Rod End	S071695
	2013.08-	Front Axle Left & Right	SUV 4WD 448DT		Rod/Strut, stabiliser	S051392
	2013.08-	Rear Axle Left	SUV 4WD 448DT	Wheelbase:Centre Wheelbase(standard)	Rod/Strut, stabiliser	S051397
	2013.08-	Rear Axle Left	SUV 4WD 448DT	Wheelbase:Long Wheelbase	Rod/Strut, stabiliser	S051407
	2013.08-	Rear Axle Right	SUV 4WD 448DT	Wheelbase:Centre Wheelbase(standard)	Rod/Strut, stabiliser	S051398
	2013.08-	Rear Axle Right	SUV 4WD 448DT	Wheelbase:Long Wheelbase	Rod/Strut, stabiliser	S051406
4.4 (250 kw)	2012.08-	Front Axle Left Upper	SUV 4WD 448DT		Track Control Arm	S063130
	2012.08-	Front Axle Left Lower Outer	SUV 4WD 448DT		Track Control Arm	S063073
	2012.08-	Front Axle Right Upper	SUV 4WD 448DT		Track Control Arm	S063131
	2012.08-	Front Axle Right Lower Outer	SUV 4WD 448DT		Track Control Arm	S063072
	2012.08-	Front Axle Left & Right Lower Outer	SUV 4WD 448DT		Control Arm Bushing	533928
	2012.08-	Front Axle Left & Right	SUV 4WD 448DT		Tie Rod Axle Joint	S030960
	2012.08-	Front Axle Left & Right	SUV 4WD 448DT		Tie Rod End	S071695
	2012.08-	Front Axle Left & Right	SUV 4WD 448DT		Rod/Strut, stabiliser	S051392
	2012.08-	Rear Axle Left	SUV 4WD 448DT	Wheelbase:Centre Wheelbase(standard)	Rod/Strut, stabiliser	S051397
	2012.08-	Rear Axle Left	SUV 4WD 448DT	Wheelbase:Long Wheelbase	Rod/Strut, stabiliser	S051407
	2012.08-	Rear Axle Right	SUV 4WD 448DT	Wheelbase:Centre Wheelbase(standard)	Rod/Strut, stabiliser	S051398
	2012.08-	Rear Axle Right	SUV 4WD 448DT	Wheelbase:Long Wheelbase	Rod/Strut, stabiliser	S051406
5.0 (375 kw)	2009.09-2012.08	Front Axle Left Lower Outer	Terrain cab wagon closed 4WD 508PS		Track Control Arm	S060847
	2009.09-2012.08	Front Axle Right Lower Outer	Terrain cab wagon closed 4WD 508PS		Track Control Arm	S060848
	2009.09-2012.08	Front Axle Left & Right Lower Inner	Terrain cab wagon closed 4WD 508PS		Track Control Arm	S060846
	2009.09-2012.08	Front Axle Left & Right Upper	Terrain cab wagon closed 4WD 508PS		Control Arm Bushing	535282
	2009.09-2012.08	Rear Axle Left & Right Lower	Terrain cab wagon closed 4WD 508PS		Control Arm Bushing	516481
	2009.09-2012.08	Rear Axle Left & Right Lower	Terrain cab wagon closed 4WD 508PS	For OE no.1.RGG000094, For OE no.2.RGG000084	Control Arm Bushing	516506
	2009.09-2012.08	Rear Axle Left & Right Upper	Terrain cab wagon closed 4WD 508PS		Control Arm Bushing	533910
	2009.09-2012.08	Front Axle Left & Right	Terrain cab wagon closed 4WD 508PS		Tie Rod End	S070581
	2009.09-2012.08	Front Axle Left & Right	Terrain cab wagon closed 4WD 508PS		Rod/Strut, stabiliser	S050514
	2009.09-2012.08	Rear Axle Left & Right	Terrain cab wagon closed 4WD 508PS		Rod/Strut, stabiliser	S051381
	2009.09-2012.08	Front Axle	Terrain cab wagon closed 4WD 508PS		Steering Rack Bellow Kit	540342S
	2012.08-	Front Axle Left Upper	SUV 4WD 508PS		Track Control Arm	S063130
	2012.08-	Front Axle Left Lower Outer	SUV 4WD 508PS		Track Control Arm	S063073
	2012.08-	Front Axle Right Upper	SUV 4WD 508PS		Track Control Arm	S063131
	2012.08-	Front Axle Right Lower Outer	SUV 4WD 508PS		Track Control Arm	S063072
	2012.08-	Front Axle Left & Right Lower Outer	SUV 4WD 508PS		Control Arm Bushing	533928
	2012.08-	Front Axle Left & Right	SUV 4WD 508PS		Tie Rod Axle Joint	S030960
	2012.08-	Front Axle Left & Right	SUV 4WD 508PS		Tie Rod End	S071695
	2012.08-	Front Axle Left & Right	SUV 4WD 508PS		Rod/Strut, stabiliser	S051392
	2012.08-	Rear Axle Left	SUV 4WD 508PS	Wheelbase:Centre Wheelbase(standard)	Rod/Strut, stabiliser	S051397
	2012.08-	Rear Axle Left	SUV 4WD 508PS	Wheelbase:Long Wheelbase	Rod/Strut, stabiliser	S051407
	2012.08-	Rear Axle Right	SUV 4WD 508PS	Wheelbase:Centre Wheelbase(standard)	Rod/Strut, stabiliser	S051398
	2012.08-	Rear Axle Right	SUV 4WD 508PS	Wheelbase:Long Wheelbase	Rod/Strut, stabiliser	S051406



	 YEAR	FITTING POSITION	BODY STYLE & DRIVE TYPE & ENGINE	REMARKS	PRODUCT	GSP Ref.	
LAND ROVER							
Range Rover							
5.0 (386 kw)	2017.11-	Front Axle Left Upper	SUV 4WD 508PS		Track Control Arm	S063130	
	2017.11-	Front Axle Left Lower Outer	SUV 4WD 508PS		Track Control Arm	S063073	
	2017.11-	Front Axle Right Upper	SUV 4WD 508PS		Track Control Arm	S063131	
	2017.11-	Front Axle Right Lower Outer	SUV 4WD 508PS		Track Control Arm	S063072	
	2017.11-	Front Axle Left & Right Lower Outer	SUV 4WD 508PS		Control Arm Bushing	533928	
	2017.11-	Front Axle Left & Right	SUV 4WD 508PS		Tie Rod Axle Joint	S030960	
	2017.11-	Front Axle Left & Right	SUV 4WD 508PS		Tie Rod End	S071695	
	2017.11-	Front Axle Left & Right	SUV 4WD 508PS		Rod/Strut, stabiliser	S051392	
	2017.11-	Rear Axle Left	SUV 4WD 508PS	Wheelbase:Centre Wheelbase(standard)	Rod/Strut, stabiliser	S051397	
	2017.11-	Rear Axle Left	SUV 4WD 508PS	Wheelbase:Long Wheelbase	Rod/Strut, stabiliser	S051407	
	2017.11-	Rear Axle Right	SUV 4WD 508PS	Wheelbase:Centre Wheelbase(standard)	Rod/Strut, stabiliser	S051398	
	2017.11-	Rear Axle Right	SUV 4WD 508PS	Wheelbase:Long Wheelbase	Rod/Strut, stabiliser	S051406	
	5.0 (405 kw)	2015.06-	Front Axle Left Upper	SUV 4WD 508PS		Track Control Arm	S063130
2015.06-		Front Axle Left Lower Outer	SUV 4WD 508PS		Track Control Arm	S063073	
2015.06-		Front Axle Right Upper	SUV 4WD 508PS		Track Control Arm	S063131	
2015.06-		Front Axle Right Lower Outer	SUV 4WD 508PS		Track Control Arm	S063072	
2015.06-		Front Axle Left & Right Lower Outer	SUV 4WD 508PS		Control Arm Bushing	533928	
2015.06-		Front Axle Left & Right	SUV 4WD 508PS		Tie Rod Axle Joint	S030960	
2015.06-		Front Axle Left & Right	SUV 4WD 508PS		Tie Rod End	S071695	
2015.06-		Front Axle Left & Right	SUV 4WD 508PS		Rod/Strut, stabiliser	S051392	
2015.06-		Rear Axle Left	SUV 4WD 508PS	Wheelbase:Centre Wheelbase(standard)	Rod/Strut, stabiliser	S051397	
2015.06-		Rear Axle Left	SUV 4WD 508PS	Wheelbase:Long Wheelbase	Rod/Strut, stabiliser	S051407	
2015.06-		Rear Axle Right	SUV 4WD 508PS	Wheelbase:Centre Wheelbase(standard)	Rod/Strut, stabiliser	S051398	
2015.06-		Rear Axle Right	SUV 4WD 508PS	Wheelbase:Long Wheelbase	Rod/Strut, stabiliser	S051406	
Range Rover Evoque							
2.0 (132 kw)	2015.05-2019.12	Front Axle Left Lower	SUV 4WD 204DTD		Track Control Arm	S061673	
	2015.05-2019.12	Front Axle Right Lower	SUV 4WD 204DTD		Track Control Arm	S061674	
	2015.05-2019.12	Front Axle Left & Right Lower	SUV 4WD 204DTD		Control Arm Bushing	516450	
	2015.05-2019.12	Rear Axle Left & Right Centre	SUV 4WD 204DTD		Control Arm Bushing	516493	
	2015.05-2019.12	Rear Axle Left & Right Lower Inner	SUV 4WD 204DTD		Control Arm Bushing	516505	
	2015.05-2019.12	Rear Axle Left & Right Lower Outer	SUV 4WD 204DTD		Control Arm Bushing	516483	
	2015.05-2019.12	Front Axle Left & Right	SUV 4WD 204DTD		Tie Rod Axle Joint	S030956	
	2015.05-2019.12	Front Axle Left	SUV 4WD 204DTD		Tie Rod End	S071689	
	2015.05-2019.12	Front Axle Right	SUV 4WD 204DTD		Tie Rod End	S071690	
	2015.11-2019.12	Front Axle Left Lower	Cabriolet 4WD 204DTD		Track Control Arm	S061673	
	2015.11-2019.12	Front Axle Right Lower	Cabriolet 4WD 204DTD		Track Control Arm	S061674	
	2015.11-2019.12	Front Axle Left & Right Lower	Cabriolet 4WD 204DTD		Control Arm Bushing	516450	
	2015.11-2019.12	Rear Axle Left & Right Centre	Cabriolet 4WD 204DTD		Control Arm Bushing	516493	
	2015.11-2019.12	Rear Axle Left & Right Lower Inner	Cabriolet 4WD 204DTD		Control Arm Bushing	516505	
	2015.11-2019.12	Rear Axle Left & Right Lower Outer	Cabriolet 4WD 204DTD		Control Arm Bushing	516483	
	2015.11-2019.12	Front Axle Left & Right	Cabriolet 4WD 204DTD		Tie Rod Axle Joint	S030956	
	2015.11-2019.12	Front Axle Left	Cabriolet 4WD 204DTD		Tie Rod End	S071689	
	2015.11-2019.12	Front Axle Right	Cabriolet 4WD 204DTD		Tie Rod End	S071690	
	2.0 (176 kw)	2011.09-2019.12	Front Axle Left Lower	SUV 4WD 204PT		Track Control Arm	S061673
		2011.09-2019.12	Front Axle Right Lower	SUV 4WD 204PT		Track Control Arm	S061674
2011.09-2019.12		Front Axle Left & Right Lower	SUV 4WD 204PT		Control Arm Bushing	516450	
2011.09-2019.12		Rear Axle Left & Right Centre	SUV 4WD 204PT		Control Arm Bushing	516493	
2011.09-2019.12		Rear Axle Left & Right Lower Inner	SUV 4WD 204PT		Control Arm Bushing	516505	
2011.09-2019.12		Rear Axle Left & Right Lower Outer	SUV 4WD 204PT		Control Arm Bushing	516483	
2.0 (177 kw)	2011.06-2019.12	Front Axle Left Lower	SUV 4WD 204PT		Track Control Arm	S061673	
	2011.06-2019.12	Front Axle Right Lower	SUV 4WD 204PT		Track Control Arm	S061674	
	2011.06-2019.12	Front Axle Left & Right Lower	SUV 4WD 204PT		Control Arm Bushing	516450	
	2011.06-2019.12	Rear Axle Left & Right Centre	SUV 4WD 204PT		Control Arm Bushing	516493	
	2011.06-2019.12	Rear Axle Left & Right Lower Inner	SUV 4WD 204PT		Control Arm Bushing	516505	
	2011.06-2019.12	Rear Axle Left & Right Lower Outer	SUV 4WD 204PT		Control Arm Bushing	516483	
	2011.06-2019.12	Front Axle Left & Right	SUV 4WD 204PT		Tie Rod Axle Joint	S030956	
	2011.06-2019.12	Front Axle Left	SUV 4WD 204PT		Tie Rod End	S071689	
	2011.06-2019.12	Front Axle Right	SUV 4WD 204PT		Tie Rod End	S071690	
	2017.08-2019.12	Front Axle Left Lower	SUV 4WD 204DTA		Track Control Arm	S061673	
	2017.08-2019.12	Front Axle Right Lower	SUV 4WD 204DTA		Track Control Arm	S061674	
	2017.08-2019.12	Front Axle Left & Right Lower	SUV 4WD 204DTA		Control Arm Bushing	516450	
	2017.08-2019.12	Rear Axle Left & Right Centre	SUV 4WD 204DTA		Control Arm Bushing	516493	
	2017.08-2019.12	Rear Axle Left & Right Lower Inner	SUV 4WD 204DTA		Control Arm Bushing	516505	
	2017.08-2019.12	Rear Axle Left & Right Lower Outer	SUV 4WD 204DTA		Control Arm Bushing	516483	



 YEAR	FITTING POSITION	BODY STYLE & DRIVE TYPE & ENGINE	REMARKS	PRODUCT	GSP Ref.
LAND ROVER					
Range Rover Evoque					
2.0 (177 kw)	2017.08-2019.12	Front Axle Left & Right	SUV 4WD 204DTA		Tie Rod Axle Joint S030956
	2017.08-2019.12	Front Axle Left	SUV 4WD 204DTA		Tie Rod End S071689
	2017.08-2019.12	Front Axle Right	SUV 4WD 204DTA		Tie Rod End S071690
2.0 (213 kw)	2017.08-2019.12	Front Axle Left Lower	SUV 4WD PT204		Track Control Arm S061673
	2017.08-2019.12	Front Axle Right Lower	SUV 4WD PT204		Track Control Arm S061674
	2017.08-2019.12	Front Axle Left & Right Lower	SUV 4WD PT204		Control Arm Bushing 516450
	2017.08-2019.12	Rear Axle Left & Right Centre	SUV 4WD PT204		Control Arm Bushing 516493
	2017.08-2019.12	Rear Axle Left & Right Lower Inner	SUV 4WD PT204		Control Arm Bushing 516505
	2017.08-2019.12	Rear Axle Left & Right Lower Outer	SUV 4WD PT204		Control Arm Bushing 516483
	2017.08-2019.12	Front Axle Left & Right	SUV 4WD PT204		Tie Rod Axle Joint S030956
	2017.08-2019.12	Front Axle Left	SUV 4WD PT204		Tie Rod End S071689
	2017.08-2019.12	Front Axle Right	SUV 4WD PT204		Tie Rod End S071690
2.0 (221 kw)	2020.07-	Rear Axle Left	SUV 4WD PT204		Rod/Strut, stabiliser S051478
	2020.07-	Rear Axle Right	SUV 4WD PT204		Rod/Strut, stabiliser S051480
2.2 (140 kw)	2011.06-2019.12	Front Axle Left Lower	SUV 4WD 224DT		Track Control Arm S061673
	2011.06-2019.12	Front Axle Right Lower	SUV 4WD 224DT		Track Control Arm S061674
	2011.06-2019.12	Front Axle Left & Right Lower	SUV 4WD 224DT		Control Arm Bushing 516450
	2011.06-2019.12	Rear Axle Left & Right Centre	SUV 4WD 224DT		Control Arm Bushing 516493
	2011.06-2019.12	Rear Axle Left & Right Lower Inner	SUV 4WD 224DT		Control Arm Bushing 516505
	2011.06-2019.12	Rear Axle Left & Right Lower Outer	SUV 4WD 224DT		Control Arm Bushing 516483
	2011.06-2019.12	Front Axle Left & Right	SUV 4WD 224DT		Tie Rod Axle Joint S030956
	2011.06-2019.12	Front Axle Left	SUV 4WD 224DT		Tie Rod End S071689
2011.06-2019.12	Front Axle Right	SUV 4WD 224DT		Tie Rod End S071690	
Range Rover Sport					
2.0 (221 kw)	2017.10-	Front Axle Left Upper	SUV 4WD PT204		Track Control Arm S063130
	2017.10-	Front Axle Left Lower Outer	SUV 4WD PT204		Track Control Arm S063073
	2017.10-	Front Axle Right Upper	SUV 4WD PT204		Track Control Arm S063131
	2017.10-	Front Axle Right Lower Outer	SUV 4WD PT204		Track Control Arm S063072
	2017.10-	Front Axle Left & Right Lower Outer	SUV 4WD PT204		Control Arm Bushing 533928
	2017.10-	Front Axle Left & Right	SUV 4WD PT204		Tie Rod Axle Joint S030960
	2017.10-	Front Axle Left & Right	SUV 4WD PT204		Tie Rod End S071695
	2017.10-	Front Axle Left & Right	SUV 4WD PT204	Chassis no to:FA527248;Chassis no from:FA600001-FA622729	Tie Rod End S071695
	2017.10-	Front Axle Left & Right	SUV 4WD PT204		Rod/Strut, stabiliser S051392
	2017.10-	Rear Axle Left	SUV 4WD PT204	for vehicles with pneumatic suspension	Rod/Strut, stabiliser S051397
	2017.10-	Rear Axle Left	SUV 4WD PT204		Rod/Strut, stabiliser S051407
	2017.10-	Rear Axle Right	SUV 4WD PT204	for vehicles with pneumatic suspension	Rod/Strut, stabiliser S051398
	2017.10-	Rear Axle Right	SUV 4WD PT204		Rod/Strut, stabiliser S051406
2.7 (140 kw)	2005.02-2009.09	Front Axle Left Lower	SUV 4WD 276DT		Track Control Arm S060849
	2005.02-2009.09	Front Axle Right Lower	SUV 4WD 276DT		Track Control Arm S060850
	2005.02-2009.09	Rear Axle Left Lower	SUV 4WD 276DT		Track Control Arm S062719
	2005.02-2009.09	Rear Axle Left Upper	SUV 4WD 276DT		Track Control Arm S062717
	2005.02-2009.09	Rear Axle Right Lower	SUV 4WD 276DT		Track Control Arm S062720
	2005.02-2009.09	Rear Axle Right Upper	SUV 4WD 276DT		Track Control Arm S062718
	2005.02-2009.09	Front Axle Left & Right Lower	SUV 4WD 276DT		Ball Joint S080995
	2005.02-2009.09	Front Axle Left & Right Upper	SUV 4WD 276DT		Ball Joint S080312
	2005.02-2009.09	Front Axle Left & Right Lower	SUV 4WD 276DT		Control Arm Bushing 530166
	2005.02-2009.09	Front Axle Left & Right Lower	SUV 4WD 276DT		Control Arm Bushing 532976
	2005.02-2009.09	Front Axle Left & Right Upper	SUV 4WD 276DT		Control Arm Bushing 535282
	2005.02-2009.09	Rear Axle Left & Right Lower	SUV 4WD 276DT	Production no from:AG2020;AG2021;Production no to:AG2020;Date from:4-2010-01-01	Control Arm Bushing 516482
	2005.02-2009.09	Rear Axle Left & Right Lower	SUV 4WD 276DT		Control Arm Bushing 516496
	2005.02-2009.09	Rear Axle Left & Right	SUV 4WD 276DT		Rod Assembly S100421
	2005.02-2009.09	Front Axle Left & Right	SUV 4WD 276DT		Tie Rod Axle Joint S030385
	2005.02-2009.09	Front Axle Left & Right	SUV 4WD 276DT	Chassis no.from:9A999999	Tie Rod End S070584
	2005.02-2009.09	Front Axle Left & Right	SUV 4WD 276DT	From Chassis:9A191792	Tie Rod End S071677
	2005.02-2009.09	Front Axle Left	SUV 4WD 276DT		Rod/Strut, stabiliser S050518
	2005.02-2009.09	Front Axle Right	SUV 4WD 276DT		Rod/Strut, stabiliser S051288
	2005.02-2009.09	Rear Axle Left & Right	SUV 4WD 276DT		Rod/Strut, stabiliser S050515
3.0 (188 kw)	2011.06-2013.06	Rear Axle Left Lower	SUV 4WD 306DT		Track Control Arm S062719
	2011.06-2013.06	Rear Axle Left Upper	SUV 4WD 306DT		Track Control Arm S062717
	2011.06-2013.06	Rear Axle Right Lower	SUV 4WD 306DT		Track Control Arm S062720
	2011.06-2013.06	Rear Axle Right Upper	SUV 4WD 306DT		Track Control Arm S062718
	2011.06-2013.06	Front Axle Left & Right Lower	SUV 4WD 306DT		Ball Joint S080995
	2011.06-2013.06	Front Axle Left & Right Upper	SUV 4WD 306DT		Ball Joint S080312
	2011.06-2013.06	Front Axle Left & Right Lower	SUV 4WD 306DT		Control Arm Bushing 532976



	 YEAR	FITTING POSITION	BODY STYLE & DRIVE TYPE & ENGINE	REMARKS	PRODUCT	GSP Ref.
LAND ROVER						
Range Rover Sport						
3.0 (188 kw)	2011.06-2013.06	Front Axle Left & Right Upper	SUV 4WD 306DT		Control Arm Bushing	535282
	2011.06-2013.06	Rear Axle Left & Right Lower	SUV 4WD 306DT	Production no.from:AA222240;AA000001;Production no.to:AA222239	Control Arm Bushing	516482
	2011.06-2013.06	Rear Axle Left & Right Lower	SUV 4WD 306DT		Control Arm Bushing	516496
	2011.06-2013.06	Rear Axle Left & Right Upper	SUV 4WD 306DT		Control Arm Bushing	533949
	2011.06-2013.06	Rear Axle Left & Right	SUV 4WD 306DT		Rod Assembly	S100421
	2011.06-2013.06	Front Axle Left & Right	SUV 4WD 306DT		Tie Rod Axle Joint	S030385
	2011.06-2013.06	Front Axle Left & Right	SUV 4WD 306DT	Chassis no.from:9A999999	Tie Rod End	S070584
	2011.06-2013.06	Front Axle Left & Right	SUV 4WD 306DT		Tie Rod End	S071677
	2011.06-2013.06	Front Axle Left	SUV 4WD 306DT		Rod/Strut,stabiliser	S050518
	2011.06-2013.06	Front Axle Right	SUV 4WD 306DT		Rod/Strut,stabiliser	S051288
	2011.06-2013.06	Rear Axle Left & Right	SUV 4WD 306DT		Rod/Strut,stabiliser	S050515
3.0 (225 kw)	2014.09-	Front Axle Left Upper	SUV 4WD 306DT		Track Control Arm	S063130
	2014.09-	Front Axle Left Lower Outer	SUV 4WD 306DT		Track Control Arm	S063073
	2014.09-	Front Axle Right Upper	SUV 4WD 306DT		Track Control Arm	S063131
	2014.09-	Front Axle Right Lower Outer	SUV 4WD 306DT		Track Control Arm	S063072
	2014.09-	Rear Axle Left Upper	SUV 4WD 306DT		Track Control Arm	S062717
	2014.09-	Rear Axle Right Upper	SUV 4WD 306DT		Track Control Arm	S062718
	2014.09-	Front Axle Left & Right Lower Outer	SUV 4WD 306DT		Control Arm Bushing	533928
	2014.09-	Front Axle Left & Right	SUV 4WD 306DT		Tie Rod Axle Joint	S030960
	2014.09-	Front Axle Left & Right	SUV 4WD 306DT		Tie Rod End	S071695
	2014.09-	Front Axle Left & Right	SUV 4WD 306DT		Rod/Strut,stabiliser	S051392
	2014.09-	Rear Axle Left	SUV 4WD 306DT	To Chassis:GA99999	Rod/Strut,stabiliser	S051397
	2014.09-	Rear Axle Left	SUV 4WD 306DT	From Chassis:HA99999	Rod/Strut,stabiliser	S051407
	2014.09-	Rear Axle Right	SUV 4WD 306DT	To Chassis:GA99999	Rod/Strut,stabiliser	S051398
2014.09-	Rear Axle Right	SUV 4WD 306DT	From Chassis:HA99999	Rod/Strut,stabiliser	S051406	
3.0 (250 kw)	2013.07-2019.12	Front Axle Left Upper	SUV 4WD 306PS		Track Control Arm	S063130
	2013.07-2019.12	Front Axle Left Lower Outer	SUV 4WD 306PS		Track Control Arm	S063073
	2013.07-2019.12	Front Axle Right Upper	SUV 4WD 306PS		Track Control Arm	S063131
	2013.07-2019.12	Front Axle Right Lower Outer	SUV 4WD 306PS		Track Control Arm	S063072
	2013.07-2019.12	Rear Axle Left Upper	SUV 4WD 306PS		Track Control Arm	S062717
	2013.07-2019.12	Rear Axle Right Upper	SUV 4WD 306PS		Track Control Arm	S062718
	2013.07-2019.12	Front Axle Left & Right Lower Outer	SUV 4WD 306PS		Control Arm Bushing	533928
	2013.07-2019.12	Rear Axle Left & Right Lower	SUV 4WD 306PS		Control Arm Bushing	516482
	2013.07-2019.12	Front Axle Left & Right	SUV 4WD 306PS		Tie Rod Axle Joint	S030960
	2013.07-2019.12	Front Axle Left & Right	SUV 4WD 306PS		Tie Rod End	S071695
	2013.07-2019.12	Front Axle Left & Right	SUV 4WD 306PS		Rod/Strut,stabiliser	S051392
	2013.07-2019.12	Rear Axle Left	SUV 4WD 306PS	To Chassis:GA99999	Rod/Strut,stabiliser	S051397
	2013.07-2019.12	Rear Axle Left	SUV 4WD 306PS	From Chassis:HA99999	Rod/Strut,stabiliser	S051407
	2013.07-2019.12	Rear Axle Right	SUV 4WD 306PS	To Chassis:GA99999	Rod/Strut,stabiliser	S051398
	2013.07-2019.12	Rear Axle Right	SUV 4WD 306PS	From Chassis:HA99999	Rod/Strut,stabiliser	S051406
3.0 (280 kw)	2015.06-2019.12	Front Axle Left Upper	SUV 4WD 306PS		Track Control Arm	S063130
	2015.06-2019.12	Front Axle Left Lower Outer	SUV 4WD 306PS		Track Control Arm	S063073
	2015.06-2019.12	Front Axle Right Upper	SUV 4WD 306PS		Track Control Arm	S063131
	2015.06-2019.12	Front Axle Right Lower Outer	SUV 4WD 306PS		Track Control Arm	S063072
	2015.06-2019.12	Rear Axle Left Upper	SUV 4WD 306PS		Track Control Arm	S062717
	2015.06-2019.12	Rear Axle Right Upper	SUV 4WD 306PS		Track Control Arm	S062718
	2015.06-2019.12	Front Axle Left & Right Lower Outer	SUV 4WD 306PS		Control Arm Bushing	533928
	2015.06-2019.12	Front Axle Left & Right	SUV 4WD 306PS		Tie Rod Axle Joint	S030960
	2015.06-2019.12	Front Axle Left & Right	SUV 4WD 306PS		Tie Rod End	S071695
	2015.06-2019.12	Front Axle Left & Right	SUV 4WD 306PS		Rod/Strut,stabiliser	S051392
	2015.06-2019.12	Rear Axle Left	SUV 4WD 306PS	To Chassis:GA99999	Rod/Strut,stabiliser	S051397
	2015.06-2019.12	Rear Axle Left	SUV 4WD 306PS	From Chassis:HA99999	Rod/Strut,stabiliser	S051407
	2015.06-2019.12	Rear Axle Right	SUV 4WD 306PS	To Chassis:GA99999	Rod/Strut,stabiliser	S051398
	2015.06-2019.12	Rear Axle Right	SUV 4WD 306PS	From Chassis:HA99999	Rod/Strut,stabiliser	S051406
	3.6 (200 kw)	2006.04-2012.12	Rear Axle Left Lower	SUV 4WD 36DDEX		Track Control Arm
2006.04-2012.12		Rear Axle Right Lower	SUV 4WD 36DDEX		Track Control Arm	S062720
2006.04-2012.12		Front Axle Left & Right Lower	SUV 4WD 36DDEX		Ball Joint	S080995
2006.04-2012.12		Front Axle Left & Right Upper	SUV 4WD 36DDEX		Ball Joint	S080312
2006.04-2012.12		Front Axle Left & Right Lower	SUV 4WD 36DDEX		Control Arm Bushing	530166
2006.04-2012.12		Front Axle Left & Right Lower	SUV 4WD 36DDEX		Control Arm Bushing	532976
2006.04-2012.12		Front Axle Left & Right Upper	SUV 4WD 36DDEX		Control Arm Bushing	535282
2006.04-2012.12		Rear Axle Left & Right Lower	SUV 4WD 36DDEX	Production no.from:AA222240;AA000001;Production no.to:AA222239	Control Arm Bushing	516482
2006.04-2012.12		Rear Axle Left & Right Lower	SUV 4WD 36DDEX		Control Arm Bushing	516496
2006.04-2012.12		Rear Axle Left & Right	SUV 4WD 36DDEX		Rod Assembly	S100421



	 YEAR	FITTING POSITION	BODY STYLE & DRIVE TYPE & ENGINE	REMARKS	PRODUCT	GSP Ref.	
LAND ROVER							
Range Rover Sport							
3.6 (200 kw)	2006.04-2012.12	Front Axle Left & Right	SUV 4WD 36DDEX		Tie Rod Axle Joint	S030385	
	2006.04-2012.12	Front Axle Left & Right	SUV 4WD 36DDEX	Chassis no.from:9A999999	Tie Rod End	S070584	
	2006.04-2012.12	Front Axle Left & Right	SUV 4WD 36DDEX	From Chassis:9A191792	Tie Rod End	S071677	
	2006.04-2012.12	Front Axle Left	SUV 4WD 36DDEX		Rod/Strut,stabiliser	S050518	
	2006.04-2012.12	Front Axle Right	SUV 4WD 36DDEX		Rod/Strut,stabiliser	S051288	
	2006.04-2012.12	Rear Axle Left & Right	SUV 4WD 36DDEX		Rod/Strut,stabiliser	S050515	
4.2 (287 kw)	2005.02-2013.06	Front Axle Left Lower	SUV 4WD 428PS		Track Control Arm	S060849	
	2005.02-2013.06	Front Axle Right Lower	SUV 4WD 428PS		Track Control Arm	S060850	
	2005.02-2013.06	Rear Axle Left Lower	SUV 4WD 428PS		Track Control Arm	S062719	
	2005.02-2013.06	Rear Axle Left Upper	SUV 4WD 428PS		Track Control Arm	S062717	
	2005.02-2013.06	Rear Axle Right Lower	SUV 4WD 428PS		Track Control Arm	S062720	
	2005.02-2013.06	Rear Axle Right Upper	SUV 4WD 428PS		Track Control Arm	S062718	
	2005.02-2013.06	Front Axle Left & Right Lower	SUV 4WD 428PS		Ball Joint	S080995	
	2005.02-2013.06	Front Axle Left & Right Upper	SUV 4WD 428PS		Ball Joint	S080312	
	2005.02-2013.06	Front Axle Left & Right Lower	SUV 4WD 428PS		Control Arm Bushing	530166	
	2005.02-2013.06	Front Axle Left & Right Lower	SUV 4WD 428PS		Control Arm Bushing	532976	
	2005.02-2013.06	Front Axle Left & Right Upper	SUV 4WD 428PS		Control Arm Bushing	535282	
	2005.02-2013.06	Rear Axle Left & Right Lower	SUV 4WD 428PS	Product code:AA022248;Product code:AA022248;Year:2006-2013	Control Arm Bushing	516482	
	2005.02-2013.06	Rear Axle Left & Right Lower	SUV 4WD 428PS		Control Arm Bushing	516496	
	2005.02-2013.06	Rear Axle Left & Right	SUV 4WD 428PS		Rod Assembly	S100421	
	2005.02-2013.06	Front Axle Left & Right	SUV 4WD 428PS		Tie Rod Axle Joint	S030385	
	2005.02-2013.06	Front Axle Left & Right	SUV 4WD 428PS	Chassis no.from:9A999999	Tie Rod End	S070584	
	2005.02-2013.06	Front Axle Left & Right	SUV 4WD 428PS	From Chassis:9A191792	Tie Rod End	S071677	
	2005.02-2013.06	Front Axle Left	SUV 4WD 428PS		Rod/Strut,stabiliser	S050518	
	2005.02-2013.06	Front Axle Right	SUV 4WD 428PS		Rod/Strut,stabiliser	S051288	
	2005.02-2013.06	Rear Axle Left & Right	SUV 4WD 428PS		Rod/Strut,stabiliser	S050515	
	4.4 (250 kw)	2013.10-	Front Axle Left Upper	SUV 4WD 44DD0R		Track Control Arm	S063130
		2013.10-	Front Axle Left Lower Outer	SUV 4WD 44DD0R		Track Control Arm	S063073
2013.10-		Front Axle Right Upper	SUV 4WD 44DD0R		Track Control Arm	S063131	
2013.10-		Front Axle Right Lower Outer	SUV 4WD 44DD0R		Track Control Arm	S063072	
2013.10-		Rear Axle Left Upper	SUV 4WD 44DD0R		Track Control Arm	S062717	
2013.10-		Rear Axle Right Upper	SUV 4WD 44DD0R		Track Control Arm	S062718	
2013.10-		Front Axle Left & Right Lower Outer	SUV 4WD 44DD0R		Control Arm Bushing	533928	
2013.10-		Front Axle Left & Right	SUV 4WD 44DD0R		Tie Rod Axle Joint	S030960	
2013.10-		Front Axle Left & Right	SUV 4WD 44DD0R		Tie Rod End	S071677	
2013.10-		Front Axle Left & Right	SUV 4WD 44DD0R	Chassis no to:FA527248;Chassis no from:FA60001-FA62729	Tie Rod End	S071695	
2013.10-		Front Axle Left & Right	SUV 4WD 44DD0R		Rod/Strut,stabiliser	S051392	
2013.10-		Rear Axle Left	SUV 4WD 44DD0R	To Chassis:GA99999	Rod/Strut,stabiliser	S051397	
2013.10-		Rear Axle Left	SUV 4WD 44DD0R	From Chassis:HA99999	Rod/Strut,stabiliser	S051407	
2013.10-		Rear Axle Right	SUV 4WD 44DD0R	To Chassis:GA99999	Rod/Strut,stabiliser	S051398	
2013.10-		Rear Axle Right	SUV 4WD 44DD0R	From Chassis:HA99999	Rod/Strut,stabiliser	S051406	
5.0 (375 kw)	2013.07-2018.12	Front Axle Left Upper	SUV 4WD 508PS		Track Control Arm	S063130	
	2013.07-2018.12	Front Axle Left Lower Outer	SUV 4WD 508PS		Track Control Arm	S063073	
	2013.07-2018.12	Front Axle Right Upper	SUV 4WD 508PS		Track Control Arm	S063131	
	2013.07-2018.12	Front Axle Right Lower Outer	SUV 4WD 508PS		Track Control Arm	S063072	
	2013.07-2018.12	Rear Axle Left Upper	SUV 4WD 508PS		Track Control Arm	S062717	
	2013.07-2018.12	Rear Axle Right Upper	SUV 4WD 508PS		Track Control Arm	S062718	
	2013.07-2018.12	Front Axle Left & Right Lower Outer	SUV 4WD 508PS		Control Arm Bushing	533928	
	2013.07-2018.12	Front Axle Left & Right	SUV 4WD 508PS		Tie Rod Axle Joint	S030960	
	2013.07-2018.12	Front Axle Left & Right	SUV 4WD 508PS		Tie Rod End	S071695	
	2013.07-2018.12	Front Axle Left & Right	SUV 4WD 508PS		Rod/Strut,stabiliser	S051392	
	2013.07-2018.12	Rear Axle Left	SUV 4WD 508PS	for vehicles with pneumatic suspension	Rod/Strut,stabiliser	S051397	
	2013.07-2018.12	Rear Axle Left	SUV 4WD 508PS		Rod/Strut,stabiliser	S051407	
	2013.07-2018.12	Rear Axle Right	SUV 4WD 508PS	for vehicles with pneumatic suspension	Rod/Strut,stabiliser	S051398	
	2013.07-2018.12	Rear Axle Right	SUV 4WD 508PS		Rod/Strut,stabiliser	S051406	
5.0 (405 kw)	2014.01-2018.12	Front Axle Left Upper	SUV 4WD 508PS		Track Control Arm	S063130	
	2014.01-2018.12	Front Axle Left Lower Outer	SUV 4WD 508PS		Track Control Arm	S063073	
	2014.01-2018.12	Front Axle Right Upper	SUV 4WD 508PS		Track Control Arm	S063131	
	2014.01-2018.12	Front Axle Right Lower Outer	SUV 4WD 508PS		Track Control Arm	S063072	
	2014.01-2018.12	Rear Axle Left Upper	SUV 4WD 508PS		Track Control Arm	S062717	
	2014.01-2018.12	Rear Axle Right Upper	SUV 4WD 508PS		Track Control Arm	S062718	
	2014.01-2018.12	Front Axle Left & Right Lower Outer	SUV 4WD 508PS		Control Arm Bushing	533928	
	2014.01-2018.12	Front Axle Left & Right	SUV 4WD 508PS		Tie Rod Axle Joint	S030960	
	2014.01-2018.12	Front Axle Left & Right	SUV 4WD 508PS		Tie Rod End	S071695	



	 YEAR	FITTING POSITION	BODY STYLE & DRIVE TYPE & ENGINE	REMARKS	PRODUCT	GSP Ref.
LAND ROVER						
Range Rover Sport						
5.0 (405 kw)	2014.01-2018.12	Front Axle Left & Right	SUV 4WD 508PS		Rod/Strut, stabiliser	S051392
	2014.01-2018.12	Rear Axle Left	SUV 4WD 508PS	for vehicles with pneumatic suspension	Rod/Strut, stabiliser	S051397
	2014.01-2018.12	Rear Axle Left	SUV 4WD 508PS		Rod/Strut, stabiliser	S051407
	2014.01-2018.12	Rear Axle Right	SUV 4WD 508PS	for vehicles with pneumatic suspension	Rod/Strut, stabiliser	S051398
	2014.01-2018.12	Rear Axle Right	SUV 4WD 508PS		Rod/Strut, stabiliser	S051406
5.0 (423 kw)	2017.11-	Front Axle Left Upper	SUV 4WD 508PS		Track Control Arm	S063130
	2017.11-	Front Axle Left Lower Outer	SUV 4WD 508PS		Track Control Arm	S063073
	2017.11-	Front Axle Right Upper	SUV 4WD 508PS		Track Control Arm	S063131
	2017.11-	Front Axle Right Lower Outer	SUV 4WD 508PS		Track Control Arm	S063072
	2017.11-	Front Axle Left & Right Lower Outer	SUV 4WD 508PS		Control Arm Bushing	533928
	2017.11-	Front Axle Left & Right	SUV 4WD 508PS		Tie Rod Axle Joint	S030960
	2017.11-	Front Axle Left & Right	SUV 4WD 508PS		Tie Rod End	S071695
	2017.11-	Front Axle Left & Right	SUV 4WD 508PS		Rod/Strut, stabiliser	S051392
	2017.11-	Rear Axle Left	SUV 4WD 508PS	for vehicles with pneumatic suspension	Rod/Strut, stabiliser	S051397
	2017.11-	Rear Axle Left	SUV 4WD 508PS		Rod/Strut, stabiliser	S051407
	2017.11-	Rear Axle Right	SUV 4WD 508PS	for vehicles with pneumatic suspension	Rod/Strut, stabiliser	S051398
	2017.11-	Rear Axle Right	SUV 4WD 508PS		Rod/Strut, stabiliser	S051406
	Range Rover Velar					
2.0 (132 kw)	2017.03-	Front Axle Left & Right	SUV 4WD 204DTD		Tie Rod End	S071819
2.0 (184 kw)	2017.03-	Front Axle Left & Right	SUV 4WD PT204		Tie Rod End	S071819
2.0 (221 kw)	2017.03-	Front Axle Left & Right	SUV 4WD PT204		Tie Rod End	S071819
3.0 (280 kw)	2017.03-	Front Axle Left & Right	SUV 4WD 306PS		Tie Rod End	S071819
LEXUS						
CT 200h						
1.8 (73 kw)	2010.12-	Front Axle Left & Right Lower	Hatchback FWD 2ZRFXE		Control Arm Bushing	516217
	2010.12-	Rear Axle Left & Right Upper	Hatchback FWD 2ZRFXE		Control Arm Bushing	517258
	2010.12-	Rear Axle Left & Right Upper Inner	Hatchback FWD 2ZRFXE		Control Arm Bushing	516223
	2010.12-	Rear Axle Left & Right Upper Inner	Hatchback FWD 2ZRFXE		Control Arm Bushing	517771
	2010.12-	Rear Axle Left & Right Lower Outer	Hatchback FWD 2ZRFXE		Control Arm Bushing	516229
	2010.12-	Front Axle Left	Hatchback FWD 2ZRFXE		Tie Rod End	S071807
	2010.12-	Front Axle Right	Hatchback FWD 2ZRFXE		Tie Rod End	S071824
ES 330						
3.3 (168 kw)	2001.07-2006.12	Rear Axle Left Lower Outer	Saloon FWD 3MZFE		Track Control Arm	517343S
	2001.07-2006.12	Rear Axle Right Lower Outer	Saloon FWD 3MZFE		Track Control Arm	517793S
	2001.07-2006.12	Front Axle Left & Right Lower	Saloon FWD 3MZFE	AT	Control Arm Bushing	514296
	2001.07-2006.12	Front Axle Left & Right Lower	Saloon FWD 3MZFE	AT	Control Arm Bushing	516708
	2001.07-2006.12	Rear Axle Left & Right Lower Centre	Saloon FWD 3MZFE		Control Arm Bushing	514918
ES 350						
3.5 (204 kw)	2012.06-2018.06	Front Axle Left Lower	Saloon FWD 2GRFE		Ball Joint	S080461
	2012.06-2018.06	Front Axle Right Lower	Saloon FWD 2GRFE		Ball Joint	S080462
	2012.06-2018.06	Rear Axle Left & Right Lower	Saloon FWD 2GRFE		Control Arm Bushing	514932
	2012.06-2018.06	Rear Axle Left & Right Upper Inner	Saloon FWD 2GRFE		Control Arm Bushing	517771
	2012.06-2018.06	Rear Axle Left & Right Lower Outer	Saloon FWD 2GRFE		Control Arm Bushing	513034
	2012.06-2018.06	Front Axle Left	Saloon FWD 2GRFE		Tie Rod End	S071733
	2012.06-2018.06	Front Axle Right	Saloon FWD 2GRFE		Tie Rod End	S071766
2012.06-2018.06	Front Axle Left & Right	Saloon FWD 2GRFE		Rod/Strut, stabiliser	S050564	
IS 250						
2.5 (153 kw)	2013.04-	Front Axle Left Lower	Saloon RWD 4GRFSE		Ball Joint	S080653
	2013.04-	Front Axle Right Lower	Saloon RWD 4GRFSE		Ball Joint	S080652
	2013.04-	Front Axle Left Lower	Saloon RWD 4GRFSE		Control Arm Bushing	532430
	2013.04-	Front Axle Right Lower	Saloon RWD 4GRFSE		Control Arm Bushing	532429
	2013.04-	Front Axle Left & Right Lower	Saloon RWD 4GRFSE		Control Arm Bushing	516137
	2013.04-	Front Axle Left & Right Upper	Saloon RWD 4GRFSE		Control Arm Bushing	517041
	2013.04-	Front Axle Left	Saloon RWD 4GRFSE		Tie Rod End	S071095
	2013.04-	Front Axle Right	Saloon RWD 4GRFSE		Tie Rod End	S071096
IS 300						
3.0 (170 kw)	2006.07-2013.03	Front Axle Left & Right Lower	Saloon RWD 3GRFE		Control Arm Bushing	516137
	2006.07-2013.03	Front Axle Left & Right Upper	Saloon RWD 3GRFE		Control Arm Bushing	517041
	2006.07-2013.03	Rear Axle Left & Right Lower Inner	Saloon RWD 3GRFE		Control Arm Bushing	516514
	2006.07-2013.03	Rear Axle Left & Right Upper Inner	Saloon RWD 3GRFE		Control Arm Bushing	516112
	2006.07-2013.03	Rear Axle Left & Right Lower Outer	Saloon RWD 3GRFE	AT	Control Arm Bushing	532790
	2006.07-2013.03	Rear Axle Left & Right Lower Outer	Saloon RWD 3GRFE		Control Arm Bushing	533085
	2006.07-2013.03	Front Axle Left & Right Lower	Saloon RWD 3GRFE		Control Arm Bushing Kit	516133S



	 YEAR	FITTING POSITION	BODY STYLE & DRIVE TYPE & ENGINE	REMARKS	PRODUCT	GSP Ref.
LEXUS						
LS 430						
4.3 (208 kw)	2000.08-2006.08	Front Axle Left & Right Lower	Saloon RWD 3UZFE		Control Arm Bushing	532789
	2000.08-2006.08	Front Axle Left & Right Upper	Saloon RWD 3UZFE		Control Arm Bushing	516710
	2000.08-2006.08	Rear Axle Left & Right Lower Inner	Saloon RWD 3UZFE		Control Arm Bushing	514855
LS 460						
4.6 (255 kw)	2006.08-	Front Axle Left Lower Inner	Saloon RWD 1URFE		Track Control Arm	S061791
	2006.08-	Front Axle Left Upper Inner	Saloon RWD 1URFE		Track Control Arm	S061719
	2006.08-	Front Axle Left Lower Outer	Saloon RWD 1URFE		Track Control Arm	S062782
	2006.08-	Front Axle Left Upper Outer	Saloon RWD 1URFE		Track Control Arm	S061721
	2006.08-	Front Axle Right Lower Inner	Saloon RWD 1URFE		Track Control Arm	S061790
	2006.08-	Front Axle Right Upper Inner	Saloon RWD 1URFE		Track Control Arm	S061720
	2006.08-	Front Axle Right Lower Outer	Saloon RWD 1URFE		Track Control Arm	S062783
	2006.08-	Front Axle Right Upper Outer	Saloon RWD 1URFE		Track Control Arm	S061722
	2006.08-	Rear Axle Left Centre	Saloon RWD 1URFE		Track Control Arm	S061726
	2006.08-	Rear Axle Right Centre	Saloon RWD 1URFE		Track Control Arm	S063061
	2006.08-	Rear Axle Left & Right Lower Inner	Saloon RWD 1URFE		Track Control Arm	S061723
	2006.08-	Rear Axle Left & Right Upper Inner	Saloon RWD 1URFE		Track Control Arm	S061724
	2006.08-	Rear Axle Left & Right Lower Outer	Saloon RWD 1URFE		Tie Rod Axle Joint	S062039
	2006.08-	Front Axle Left & Right	Saloon RWD 1URFE		Tie Rod Axle Joint	S031012
	2006.08-	Front Axle Left	Saloon RWD 1URFE		Rod/Strut, stabiliser	S051483
	2006.08-	Front Axle Right	Saloon RWD 1URFE		Rod/Strut, stabiliser	S051477
	2006.08-	Rear Axle Left	Saloon RWD 1URFE		Rod/Strut, stabiliser	S050986
	2006.08-	Rear Axle Right	Saloon RWD 1URFE		Rod/Strut, stabiliser	S050987
	2006.08-	Front Axle	Saloon RWD 1URFE		Stabiliser Bushing	535196
4.6 (270 kw)	2009.10-	Front Axle Left Lower Inner	Saloon RWD 1URFSE		Track Control Arm	S061791
	2009.10-	Front Axle Left Upper Inner	Saloon RWD 1URFSE		Track Control Arm	S061719
	2009.10-	Front Axle Left Lower Outer	Saloon RWD 1URFSE		Track Control Arm	S062782
	2009.10-	Front Axle Left Upper Outer	Saloon RWD 1URFSE		Track Control Arm	S061721
	2009.10-	Front Axle Right Lower Inner	Saloon RWD 1URFSE		Track Control Arm	S061790
	2009.10-	Front Axle Right Lower Outer	Saloon RWD 1URFSE		Track Control Arm	S062783
	2009.10-	Front Axle Right Upper Outer	Saloon RWD 1URFSE		Track Control Arm	S061722
	2009.10-	Front Axle Left	Saloon RWD 1URFSE		Rod/Strut, stabiliser	S051483
	2009.10-	Front Axle Right	Saloon RWD 1URFSE		Rod/Strut, stabiliser	S051477
4.6 (280 kw)	2006.08-	Front Axle Left Lower Inner	Saloon RWD 1URFSE		Track Control Arm	S061791
	2006.08-	Front Axle Left Upper Inner	Saloon RWD 1URFSE		Track Control Arm	S061719
	2006.08-	Front Axle Left Lower Outer	Saloon RWD 1URFSE		Track Control Arm	S062782
	2006.08-	Front Axle Left Upper Outer	Saloon RWD 1URFSE		Track Control Arm	S061721
	2006.08-	Front Axle Right Lower Inner	Saloon RWD 1URFSE		Track Control Arm	S061790
	2006.08-	Front Axle Right Upper Inner	Saloon RWD 1URFSE		Track Control Arm	S061720
	2006.08-	Front Axle Right Lower Outer	Saloon RWD 1URFSE		Track Control Arm	S062783
	2006.08-	Front Axle Right Upper Outer	Saloon RWD 1URFSE		Track Control Arm	S061722
	2006.08-	Rear Axle Left Centre	Saloon RWD 1URFSE		Track Control Arm	S061726
	2006.08-	Rear Axle Right Centre	Saloon RWD 1URFSE		Track Control Arm	S063061
	2006.08-	Rear Axle Left & Right Lower Inner	Saloon RWD 1URFSE		Track Control Arm	S061723
	2006.08-	Rear Axle Left & Right Upper Inner	Saloon RWD 1URFSE		Track Control Arm	S061724
	2006.08-	Front Axle Left & Right	Saloon RWD 1URFSE		Tie Rod Axle Joint	S031012
	2006.08-	Front Axle Left	Saloon RWD 1URFSE		Rod/Strut, stabiliser	S051483
	2006.08-	Front Axle Right	Saloon RWD 1URFSE		Rod/Strut, stabiliser	S051477
	2006.08-	Rear Axle Left	Saloon RWD 1URFSE		Rod/Strut, stabiliser	S050986
	2006.08-	Rear Axle Right	Saloon RWD 1URFSE		Rod/Strut, stabiliser	S050987
	2006.08-	Front Axle	Saloon RWD 1URFSE		Stabiliser Bushing	535196
LS 600h						
5.0 (290 kw)	2007.04-	Front Axle Left Upper Inner	Saloon 4WD 2URFSE		Track Control Arm	S061719
	2007.04-	Front Axle Left Upper Outer	Saloon 4WD 2URFSE		Track Control Arm	S061721
	2007.04-	Front Axle Right Upper Outer	Saloon 4WD 2URFSE		Track Control Arm	S061722
	2007.04-	Rear Axle Left Centre	Saloon 4WD 2URFSE		Track Control Arm	S061726
	2007.04-	Rear Axle Right Centre	Saloon 4WD 2URFSE		Track Control Arm	S063061
	2007.04-	Front Axle Left	Saloon 4WD 2URFSE		Rod/Strut, stabiliser	S051483
	2007.04-	Front Axle Right	Saloon 4WD 2URFSE		Rod/Strut, stabiliser	S051477
	2007.04-	Rear Axle Left	Saloon 4WD 2URFSE		Rod/Strut, stabiliser	S050986
	2007.04-	Rear Axle Right	Saloon 4WD 2URFSE		Rod/Strut, stabiliser	S050987
NX 200t						
2.0 (175 kw)	2014.07-	Front Axle Left Lower	SUV 4WD 8ARFTS		Track Control Arm	S060917
	2014.07-	Front Axle Right Lower	SUV 4WD 8ARFTS		Track Control Arm	S060918
	2014.07-	Rear Axle Left Upper Outer	SUV 4WD 8ARFTS		Track Control Arm	S062580



	 YEAR	FITTING POSITION	BODY STYLE & DRIVE TYPE & ENGINE	REMARKS	PRODUCT	GSP Ref.
LEXUS						
NX 200t						
2.0 (175 kw)	2014.07-	Rear Axle Right Upper Outer	SUV 4WD 8ARFTS		Track Control Arm	S062579
	2014.07-	Rear Axle Left & Right Lower Inner	SUV 4WD 8ARFTS		Track Control Arm	S063196
	2014.07-	Front Axle Left & Right Lower	SUV 4WD 8ARFTS		Ball Joint	S080244
	2014.07-	Front Axle Left & Right	SUV 4WD 8ARFTS		Control Arm Bushing	513205
	2014.07-	Front Axle Left & Right Lower	SUV 4WD 8ARFTS		Control Arm Bushing	516217
	2014.07-	Rear Axle Left & Right Lower Outer	SUV 4WD 8ARFTS		Control Arm Bushing	516229
	2014.07-	Rear Axle Left & Right Upper Outer	SUV 4WD 8ARFTS		Control Arm Bushing	516512
	2014.07-	Front Axle Left	SUV 4WD 8ARFTS		Tie Rod End	S070490
	2014.07-	Front Axle Right	SUV 4WD 8ARFTS		Tie Rod End	S070491
	2014.07-	Front Axle Left & Right	SUV 4WD 8ARFTS		Rod/Strut, stabiliser	S050440
	2014.07-	Rear Axle Left & Right	SUV 4WD 8ARFTS		Rod/Strut, stabiliser	S050441
	2014.07-2017.09	Front Axle Left Lower	SUV FWD 8ARFTS		Track Control Arm	S060917
	2014.07-2017.09	Front Axle Right Lower	SUV FWD 8ARFTS		Track Control Arm	S060918
	2014.07-2017.09	Rear Axle Left Upper Outer	SUV FWD 8ARFTS		Track Control Arm	S062580
	2014.07-2017.09	Rear Axle Right Upper Outer	SUV FWD 8ARFTS		Track Control Arm	S062579
	2014.07-2017.09	Rear Axle Left & Right Lower Inner	SUV FWD 8ARFTS		Track Control Arm	S063196
	2014.07-2017.09	Front Axle Left & Right Lower	SUV FWD 8ARFTS		Ball Joint	S080244
	2014.07-2017.09	Front Axle Left & Right	SUV FWD 8ARFTS		Control Arm Bushing	513205
	2014.07-2017.09	Front Axle Left & Right Lower	SUV FWD 8ARFTS		Control Arm Bushing	516217
	2014.07-2017.09	Rear Axle Left & Right Lower Outer	SUV FWD 8ARFTS		Control Arm Bushing	516229
	2014.07-2017.09	Rear Axle Left & Right Upper Outer	SUV FWD 8ARFTS		Control Arm Bushing	516512
	2014.07-2017.09	Front Axle Left	SUV FWD 8ARFTS		Tie Rod End	S070490
	2014.07-2017.09	Front Axle Right	SUV FWD 8ARFTS		Tie Rod End	S070491
	2014.07-2017.09	Front Axle Left & Right	SUV FWD 8ARFTS		Rod/Strut, stabiliser	S050440
	2014.07-2017.09	Rear Axle Left & Right	SUV FWD 8ARFTS		Rod/Strut, stabiliser	S050441
NX 300						
2.0 (175 kw)	2017.09-	Front Axle Right Lower	SUV 4WD 8ARFTS		Track Control Arm	S060918
	2017.09-	Rear Axle Left Upper Outer	SUV 4WD 8ARFTS		Track Control Arm	S062580
	2017.09-	Rear Axle Right Upper Outer	SUV 4WD 8ARFTS		Track Control Arm	S062579
	2017.09-	Rear Axle Left & Right Lower Inner	SUV 4WD 8ARFTS		Track Control Arm	S063196
	2017.09-	Front Axle Left & Right Lower	SUV 4WD 8ARFTS		Ball Joint	S080244
	2017.09-	Front Axle Left & Right	SUV 4WD 8ARFTS		Control Arm Bushing	513205
	2017.09-	Front Axle Left & Right Lower	SUV 4WD 8ARFTS		Control Arm Bushing	516217
	2017.09-	Rear Axle Left & Right Lower Outer	SUV 4WD 8ARFTS		Control Arm Bushing	516229
	2017.09-	Rear Axle Left & Right Upper Outer	SUV 4WD 8ARFTS		Control Arm Bushing	516512
	2017.09-	Front Axle Left	SUV 4WD 8ARFTS		Tie Rod End	S070490
	2017.09-	Front Axle Right	SUV 4WD 8ARFTS		Tie Rod End	S070491
	2017.09-	Front Axle Left & Right	SUV 4WD 8ARFTS		Rod/Strut, stabiliser	S050440
	2017.09-	Rear Axle Left & Right	SUV 4WD 8ARFTS		Rod/Strut, stabiliser	S050441
RX 350						
3.5 (204 kw)	2009.01-2015.09	Front Axle Left Lower	SUV 4WD 2GRFE	AT	Track Control Arm	S061713
	2009.01-2015.09	Front Axle Right Lower	SUV 4WD 2GRFE	AT	Track Control Arm	S061714
	2009.01-2015.09	Front Axle Left Lower	SUV 4WD 2GRFE		Ball Joint	S080668
	2009.01-2015.09	Front Axle Right Lower	SUV 4WD 2GRFE		Ball Joint	S080669
	2009.01-2015.09	Front Axle Left & Right Lower	SUV 4WD 2GRFE		Control Arm Bushing	514520
	2009.01-2015.09	Front Axle Left & Right Lower	SUV 4WD 2GRFE		Control Arm Bushing	516407
	2009.01-2015.09	Front Axle Left	SUV 4WD 2GRFE		Tie Rod End	S070811
	2009.01-2015.09	Front Axle Right	SUV 4WD 2GRFE		Tie Rod End	S070810
	2009.01-2015.09	Front Axle Left & Right	SUV 4WD 2GRFE		Rod/Strut, stabiliser	S050419
	2009.01-2015.09	Rear Axle Left	SUV 4WD 2GRFE		Rod/Strut, stabiliser	S051310
	2009.01-2015.09	Rear Axle Right	SUV 4WD 2GRFE		Rod/Strut, stabiliser	S050980
	2009.01-2015.09	Front Axle	SUV 4WD 2GRFE		Stabiliser Bushing	513127
	2009.01-2015.09	Front Axle	SUV 4WD 2GRFE		Stabiliser Bushing	532432
	2009.01-2015.09	Rear Axle	SUV 4WD 2GRFE		Stabiliser Bushing	532764
3.5 (224 kw)	2015.10-	Rear Axle Left	SUV 4WD 2GRFKS		Rod/Strut, stabiliser	S051310
	2015.10-	Rear Axle Right	SUV 4WD 2GRFKS		Rod/Strut, stabiliser	S050980
MASERATI						
3200 GT						
3.2 (271 kw)	1998.10-2002.03	Front Axle Left & Right	Coupe RWD AM585		Tie Rod End	S070824
	1998.10-2002.03	Front Axle Left & Right	Coupe RWD AM585		Tie Rod End	S070866
Quattroporte						
4.7 (323 kw)	2008.06-2012.04	Front Axle Left & Right	Saloon RWD M139S		Tie Rod End	S070840



	 YEAR	FITTING POSITION	BODY STYLE & DRIVE TYPE & ENGINE	REMARKS	PRODUCT	GSP Ref.
MAZDA						
626						
2.0 (85 kw)	1992.01-1997.06	Front Axle Left Lower	Saloon FWD FS83/FS84		Track Control Arm	S060556
	1992.01-1997.06	Front Axle Right Lower	Saloon FWD FS83/FS84		Track Control Arm	S060557
	1992.01-1997.06	Front Axle Left & Right Lower	Saloon FWD FS83/FS84		Ball Joint	S080107
	1992.01-1997.06	Front Axle Left Lower	Saloon FWD FS83/FS84		Control Arm Bushing	531506
	1992.01-1997.06	Front Axle Right Lower	Saloon FWD FS83/FS84		Control Arm Bushing	531505
	1992.01-1997.06	Front Axle Left & Right Lower	Saloon FWD FS83/FS84		Control Arm Bushing	511157
	1992.01-1997.06	Front Axle Left & Right Lower	Saloon FWD FS83/FS84		Control Arm Bushing	514927
	1992.01-1997.06	Rear Axle Left & Right Lower	Saloon FWD FS83/FS84		Control Arm Bushing	511158
	1992.01-1997.06	Front Axle Left & Right	Saloon FWD FS83/FS84		Tie Rod Axle Joint	S030389
	1992.01-1997.06	Front Axle Left & Right	Saloon FWD FS83/FS84		Tie Rod End	S070252
	1992.01-1997.06	Front Axle Left & Right	Saloon FWD FS83/FS84		Tie Rod End	S070824
	1992.01-1997.06	Front Axle Left & Right	Saloon FWD FS83/FS84		Tie Rod End	S070866
	1992.01-1997.06	Front Axle Left	Saloon FWD FS83/FS84		Rod/Strut, stabiliser	S050246
	1992.01-1997.06	Front Axle Right	Saloon FWD FS83/FS84		Rod/Strut, stabiliser	S050247
	1992.01-1997.06	Rear Axle Left & Right	Saloon FWD FS83/FS84		Rod/Strut, stabiliser	S050249
	1992.01-1997.06	Front Axle	Saloon FWD FS83/FS84		Stabiliser Bushing	513277
	1992.01-1997.06	Front Axle	Saloon FWD FS83/FS84		Stabiliser Bushing	516821
	1992.01-1997.06	Rear Axle	Saloon FWD FS83/FS84		Stabiliser Bushing	516826
	1992.01-1997.06	Front Axle	Saloon FWD FS83/FS84		Steering Rack Bellow Kit	540211K
AZ3						
1.6 (81 kw)	1993.11-1998.09	Front Axle Left & Right	Coupe FWD D6DK		Tie Rod Axle Joint	S030829
B2200						
2.2 (46 kw)	1985.01-1989.11	Front Axle Left & Right Lower	Pick up RWD R243		Ball Joint	S080117
	1985.01-1989.11	Front Axle Left & Right Lower	Pick up RWD R243		Ball Joint	S080124
	1985.01-1989.11	Front Axle Left & Right Lower	Pick up RWD R243		Ball Joint	S080931
	1985.01-1989.11	Front Axle Left & Right Upper	Pick up RWD R243		Ball Joint	S080116
	1985.01-1989.11	Front Axle Left & Right Upper	Pick up RWD R243		Ball Joint	S080408
	1985.01-1989.11	Front Axle Left & Right	Pick up RWD R243		Tie Rod End	S070259
	1985.01-1989.11	Front Axle Left & Right	Pick up RWD R243	Date from: 1986.10	Tie Rod End	S070262
	1985.01-1989.11	Front Axle Left & Right	Pick up RWD R243		Tie Rod End	S070782
B2500						
2.5 (57 kw)	1998.09-2006.07	Front Axle Left & Right Lower	Pick up 4WD WL81		Ball Joint	S080931
	1998.09-2006.07	Front Axle Left & Right Lower	Pick up 4WD WL81		Control Arm Bushing	516628
	1998.09-2006.07	Front Axle	Pick up 4WD WL81		Idler Arm	S010100
	1998.09-2006.07	Front Axle Left & Right	Pick up 4WD WL81		Tie Rod End	S070262
	1998.09-2006.07	Front Axle Left & Right	Pick up 4WD WL81		Tie Rod End	S070263
	1998.09-2006.07	Front Axle Left & Right	Pick up 4WD WL81		Tie Rod End	S070782
Cronos						
2.0 (85 kw)	1991.08-1994.12	Front Axle Left Lower	Saloon FWD FS		Track Control Arm	S060556
	1991.08-1994.12	Front Axle Right Lower	Saloon FWD FS		Track Control Arm	S060557
	1991.08-1994.12	Front Axle Left & Right Lower	Saloon FWD FS		Ball Joint	S080107
	1991.08-1994.12	Front Axle Left Lower	Saloon FWD FS		Control Arm Bushing	531506
	1991.08-1994.12	Front Axle Right Lower	Saloon FWD FS		Control Arm Bushing	531505
	1991.08-1994.12	Front Axle Left & Right Lower	Saloon FWD FS		Control Arm Bushing	511157
	1991.08-1994.12	Front Axle Left & Right Lower	Saloon FWD FS	Date from-to: 1994-1997	Control Arm Bushing	514927
	1991.08-1994.12	Front Axle Left & Right Lower	Saloon FWD FS		Control Arm Bushing	514927
	1991.08-1994.12	Rear Axle Left & Right Lower	Saloon FWD FS		Control Arm Bushing	511158
	1991.08-1994.12	Front Axle Left & Right	Saloon FWD FS		Tie Rod End	S070252
	1991.08-1994.12	Front Axle Left & Right	Saloon FWD FS		Tie Rod End	S070824
	1991.08-1994.12	Front Axle Left & Right	Saloon FWD FS		Tie Rod End	S070866
	1991.08-1994.12	Front Axle Left	Saloon FWD FS		Rod/Strut, stabiliser	S050246
	1991.08-1994.12	Front Axle Right	Saloon FWD FS		Rod/Strut, stabiliser	S050247
	1991.08-1994.12	Rear Axle Left & Right	Saloon FWD FS		Rod/Strut, stabiliser	S050249
	1991.08-1994.12	Front Axle	Saloon FWD FS		Stabiliser Bushing	513277
	1991.08-1994.12	Front Axle	Saloon FWD FS		Stabiliser Bushing	516821
	1991.08-1994.12	Rear Axle	Saloon FWD FS		Stabiliser Bushing	516826
	1991.08-1994.12	Front Axle	Saloon FWD FS		Steering Rack Bellow Kit	540211K
MX3						
1.6 (66 kw)	1991.05-1993.10	Front Axle Left & Right	Coupe FWD B67K		Tie Rod Axle Joint	S030829
	1991.05-1993.10	Front Axle Left & Right	Coupe FWD B67K		Tie Rod End	S070824
	1991.05-1993.10	Front Axle Left & Right	Coupe FWD B67K		Tie Rod End	S070866
	1991.05-1993.10	Rear Axle	Coupe FWD B67K		Stabiliser Bushing	512523
1.6 (79 kw)	1993.11-1998.09	Front Axle Left & Right Lower	Coupe FWD B6DA	Chassis no.to:126548	Ball Joint	S080119
	1993.11-1998.09	Front Axle Left & Right Lower	Coupe FWD B6DA		Ball Joint	S080123



	 YEAR	FITTING POSITION	BODY STYLE & DRIVE TYPE & ENGINE	REMARKS	PRODUCT	GSP Ref.
MAZDA MX3						
1.6 (79 kw)	1993.11-1998.09	Front Axle Left Lower	Coupe FWD B6DA		Control Arm Bushing	531502
	1993.11-1998.09	Front Axle Left Lower	Coupe FWD B6DA		Control Arm Bushing	531506
	1993.11-1998.09	Front Axle Right Lower	Coupe FWD B6DA		Control Arm Bushing	531501
	1993.11-1998.09	Front Axle Left & Right	Coupe FWD B6DA		Tie Rod Axle Joint	S030829
	1993.11-1998.09	Front Axle Left & Right	Coupe FWD B6DA		Tie Rod End	S070264
	1993.11-1998.09	Front Axle Left & Right	Coupe FWD B6DA		Rod/Strut, stabiliser	S050251
	1993.11-1998.09	Rear Axle Left & Right	Coupe FWD B6DA		Rod/Strut, stabiliser	S050264
Roadster						
1.8 (96 kw)	1993.01-1997.12	Front Axle Left & Right Lower	Cabriolet RWD BPF1		Ball Joint	S080121
	1993.01-1997.12	Front Axle; Rear Axle Left & Right	Cabriolet RWD BPF1		Rod/Strut, stabiliser	S050257
Telstar						
2.0 (85 kw)	1993.08-1996.12	Front Axle Left Lower	Saloon FWD FSJ2LP		Track Control Arm	S060556
	1993.08-1996.12	Front Axle Right Lower	Saloon FWD FSJ2LP		Track Control Arm	S060557
	1993.08-1996.12	Front Axle Left & Right Lower	Saloon FWD FSJ2LP		Ball Joint	S080107
	1993.08-1996.12	Front Axle Left Lower	Saloon FWD FSJ2LP		Control Arm Bushing	531506
	1993.08-1996.12	Front Axle Right Lower	Saloon FWD FSJ2LP		Control Arm Bushing	531505
	1993.08-1996.12	Front Axle Left & Right Lower	Saloon FWD FSJ2LP		Control Arm Bushing	511157
	1993.08-1996.12	Front Axle Left & Right Lower	Saloon FWD FSJ2LP		Control Arm Bushing	514927
	1993.08-1996.12	Rear Axle Left & Right Lower	Saloon FWD FSJ2LP		Control Arm Bushing	511158
	1993.08-1996.12	Front Axle Left & Right	Saloon FWD FSJ2LP		Tie Rod Axle Joint	S030389
	1993.08-1996.12	Front Axle Left & Right	Saloon FWD FSJ2LP		Tie Rod End	S070252
	1993.08-1996.12	Front Axle Left & Right	Saloon FWD FSJ2LP		Tie Rod End	S070824
	1993.08-1996.12	Front Axle Left & Right	Saloon FWD FSJ2LP		Tie Rod End	S070866
	1993.08-1996.12	Front Axle Left	Saloon FWD FSJ2LP		Rod/Strut, stabiliser	S050246
	1993.08-1996.12	Front Axle Right	Saloon FWD FSJ2LP		Rod/Strut, stabiliser	S050247
	1993.08-1996.12	Rear Axle Left & Right	Saloon FWD FSJ2LP		Rod/Strut, stabiliser	S050249
	1993.08-1996.12	Front Axle	Saloon FWD FSJ2LP		Stabiliser Bushing	513277
	1993.08-1996.12	Front Axle	Saloon FWD FSJ2LP		Stabiliser Bushing	516821
	1993.08-1996.12	Rear Axle	Saloon FWD FSJ2LP		Stabiliser Bushing	516826
	1993.08-1996.12	Front Axle	Saloon FWD FSJ2LP		Steering Rack Bellow Kit	540211K
	MERCEDES-BENZ 190					
2.3 (97 kw)	1986.09-1992.08	Front Axle Left Lower	Saloon RWD 102985		Track Control Arm	S060581
	1986.09-1992.08	Front Axle Right Lower	Saloon RWD 102985		Track Control Arm	S060582
	1986.09-1992.08	Rear Axle Left & Right Lower Inner	Saloon RWD 102985		Track Control Arm	S060217
	1986.09-1992.08	Rear Axle Left & Right Upper Inner	Saloon RWD 102985	Chassis no. from: A 217001, F 110001	Track Control Arm	S060216
	1986.09-1992.08	Rear Axle Left & Right Lower Outer	Saloon RWD 102985		Track Control Arm	S051055
	1986.09-1992.08	Rear Axle Left & Right Upper Outer	Saloon RWD 102985		Track Control Arm	S060218
	1986.09-1992.08	Front Axle Left & Right Lower	Saloon RWD 102985		Ball Joint	S080141
	1986.09-1992.08	Front Axle Left & Right Lower	Saloon RWD 102985		Control Arm Bushing	510427
	1986.09-1992.08	Front Axle Left & Right Lower	Saloon RWD 102985		Control Arm Bushing	510428
	1986.09-1992.08	Front Axle Left & Right Lower	Saloon RWD 102985		Control Arm Bushing	510563
	1986.09-1992.08	Rear Axle Left & Right Upper Inner	Saloon RWD 102985		Control Arm Bushing	517809
	1986.09-1992.08	Rear Axle Left & Right Lower Outer	Saloon RWD 102985		Control Arm Bushing	510431
	1986.09-1992.08	Rear Axle Left & Right Lower Outer	Saloon RWD 102985		Control Arm Bushing	512252
	1986.09-1992.08	Rear Axle Left & Right Upper Outer	Saloon RWD 102985		Control Arm Bushing	510430
	1986.09-1992.08	Front Axle Left & Right Lower	Saloon RWD 102985		Control Arm Bushing Kit	510426S
	1986.09-1992.08	Rear Axle	Saloon RWD 102985		Suspension Repair Kit	S990038SK
	1986.09-1992.08	Front Axle Left	Saloon RWD 102985		Rod Assembly	S100065
	1986.09-1992.08	Front Axle Right	Saloon RWD 102985		Rod Assembly	S100066
	1986.09-1992.08	Front Axle Left & Right	Saloon RWD 102985		Rod Assembly	S100181
	1986.09-1992.08	Front Axle Left & Right	Saloon RWD 102985	for left-hand drive vehicles	Tie Rod End	S070295
	1986.09-1992.08	Front Axle Left & Right	Saloon RWD 102985		Tie Rod End	S070295
	1986.09-1992.08	Front Axle Left & Right	Saloon RWD 102985		Tie Rod End	S070296
	1986.09-1992.08	Front Axle Left & Right	Saloon RWD 102985		Tie Rod End	S070297
	1986.09-1992.08	Rear Axle Left & Right	Saloon RWD 102985		Rod/Strut, stabiliser	S100063
	1986.09-1992.08	Rear Axle Left & Right	Saloon RWD 102985	Chassis no. from: A 163836, F 057881	Rod/Strut, stabiliser	S100063
	1986.09-1992.08	Front Axle	Saloon RWD 102985		Stabiliser Bushing	511541
	1986.09-1992.08	Front Axle	Saloon RWD 102985		Stabiliser Bushing	512608
	1986.09-1992.08	Rear Axle	Saloon RWD 102985		Stabiliser Bushing	517269
	1986.09-1992.08	Front Axle	Saloon RWD 102985		Stabiliser Bushing Kit	511546S
	2.3 (100 kw)	1982.10-1993.08	Front Axle Left Lower	Saloon RWD 102985		Track Control Arm
1982.10-1993.08		Front Axle Right Lower	Saloon RWD 102985		Track Control Arm	S060582
1982.10-1993.08		Rear Axle Left & Right Lower Inner	Saloon RWD 102985		Track Control Arm	S060217



	 YEAR	FITTING POSITION	BODY STYLE & DRIVE TYPE & ENGINE	REMARKS	PRODUCT	GSP Ref.
MERCEDES-BENZ						
190						
2.3 (100 kw)						
	1982.10-1993.08	Rear Axle Left & Right Upper Inner	Saloon RWD 102985	Chassis no.from:A 217001,F 110001	Track Control Arm	S060216
	1982.10-1993.08	Rear Axle Left & Right Lower Outer	Saloon RWD 102985		Track Control Arm	S051055
	1982.10-1993.08	Rear Axle Left & Right Upper Outer	Saloon RWD 102985		Track Control Arm	S060218
	1982.10-1993.08	Front Axle Left & Right Lower	Saloon RWD 102985		Ball Joint	S080141
	1982.10-1993.08	Front Axle Left & Right Lower	Saloon RWD 102985		Control Arm Bushing	510427
	1982.10-1993.08	Front Axle Left & Right Lower	Saloon RWD 102985		Control Arm Bushing	510428
	1982.10-1993.08	Front Axle Left & Right Lower	Saloon RWD 102985		Control Arm Bushing	510563
	1982.10-1993.08	Rear Axle Left & Right Upper Inner	Saloon RWD 102985		Control Arm Bushing	517809
	1982.10-1993.08	Rear Axle Left & Right Lower Outer	Saloon RWD 102985		Control Arm Bushing	510431
	1982.10-1993.08	Rear Axle Left & Right Lower Outer	Saloon RWD 102985		Control Arm Bushing	512252
	1982.10-1993.08	Rear Axle Left & Right Upper Outer	Saloon RWD 102985		Control Arm Bushing	510430
	1982.10-1993.08	Front Axle Left & Right Lower	Saloon RWD 102985		Control Arm Bushing Kit	510426S
	1982.10-1993.08	Rear Axle	Saloon RWD 102985		Suspension Repair Kit	S990038SK
	1982.10-1993.08	Front Axle Left	Saloon RWD 102985		Rod Assembly	S100065
	1982.10-1993.08	Front Axle Right	Saloon RWD 102985		Rod Assembly	S100066
	1982.10-1993.08	Front Axle Left & Right	Saloon RWD 102985		Rod Assembly	S100181
	1982.10-1993.08	Front Axle Left & Right	Saloon RWD 102985	for left-hand drive vehicles	Tie Rod End	S070295
	1982.10-1993.08	Front Axle Left & Right	Saloon RWD 102985		Tie Rod End	S070295
	1982.10-1993.08	Front Axle Left & Right	Saloon RWD 102985		Tie Rod End	S070296
	1982.10-1993.08	Front Axle Left & Right	Saloon RWD 102985		Tie Rod End	S070297
	1982.10-1993.08	Rear Axle Left & Right	Saloon RWD 102985		Rod/Strut,stabiliser	S100063
	1982.10-1993.08	Rear Axle Left & Right	Saloon RWD 102985	Chassis no.:A 163836,F 057881	Rod/Strut,stabiliser	S100063
	1982.10-1993.08	Front Axle	Saloon RWD 102985		Stabiliser Bushing	511541
	1982.10-1993.08	Rear Axle	Saloon RWD 102985		Stabiliser Bushing	517269
	1982.10-1993.08	Front Axle	Saloon RWD 102985		Stabiliser Bushing Kit	511546S
230						
2.3 (97 kw)						
	1984.12-1993.06	Front Axle Left Lower	Saloon RWD 102982	for vehicles with sports suspension	Track Control Arm	S060579
	1984.12-1993.06	Front Axle Left Lower	Saloon RWD 102982	for vehicles without sports suspension	Track Control Arm	S060581
	1984.12-1993.06	Front Axle Right Lower	Saloon RWD 102982	for vehicles with sports suspension	Track Control Arm	S060580
	1984.12-1993.06	Front Axle Right Lower	Saloon RWD 102982	for vehicles without sports suspension	Track Control Arm	S060582
	1984.12-1993.06	Rear Axle Left & Right Lower Inner	Saloon RWD 102982		Track Control Arm	S060217
	1984.12-1993.06	Rear Axle Left & Right Upper Inner	Saloon RWD 102982		Track Control Arm	S060216
	1984.12-1993.06	Rear Axle Left & Right Lower Outer	Saloon RWD 102982		Track Control Arm	S051055
	1984.12-1993.06	Rear Axle Left & Right Upper Outer	Saloon RWD 102982		Track Control Arm	S060218
	1984.12-1993.06	Front Axle Left & Right Lower	Saloon RWD 102982		Ball Joint	S080141
	1984.12-1993.06	Front Axle Left & Right Lower	Saloon RWD 102982		Control Arm Bushing	510427
	1984.12-1993.06	Front Axle Left & Right Lower	Saloon RWD 102982		Control Arm Bushing	510428
	1984.12-1993.06	Front Axle Left & Right Lower	Saloon RWD 102982		Control Arm Bushing	510563
	1984.12-1993.06	Rear Axle Left & Right Lower	Saloon RWD 102982		Control Arm Bushing	511560
	1984.12-1993.06	Rear Axle Left & Right Upper Inner	Saloon RWD 102982		Control Arm Bushing	517809
	1984.12-1993.06	Rear Axle Left & Right Lower Outer	Saloon RWD 102982		Control Arm Bushing	510431
	1984.12-1993.06	Rear Axle Left & Right Lower Outer	Saloon RWD 102982		Control Arm Bushing	512252
	1984.12-1993.06	Rear Axle Left & Right Upper Outer	Saloon RWD 102982		Control Arm Bushing	510430
	1984.12-1993.06	Front Axle Left & Right Lower	Saloon RWD 102982		Control Arm Bushing Kit	510426S
	1984.12-1993.06	Rear Axle	Saloon RWD 102982		Suspension Repair Kit	S990038SK
	1984.12-1993.06	Front Axle Left & Right	Saloon RWD 102982	Chassis no.to:1B 022104,2B 051198	Rod Assembly	S100189
	1984.12-1993.06	Front Axle Left & Right	Saloon RWD 102982	Chassis no.to:1B 022104,2B 051198	Rod Assembly	S100190
	1984.12-1993.06	Front Axle Left & Right Centre	Saloon RWD 102982		Rod Assembly	S100075
	1984.12-1993.06	Front Axle Left & Right	Saloon RWD 102982		Tie Rod End	S070048
	1984.12-1993.06	Rear Axle Left & Right	Saloon RWD 102982		Rod/Strut,stabiliser	S100063
	1984.12-1993.06	Front Axle Left & Right Outer	Saloon RWD 102982		Stabiliser Bushing	511553
	1984.12-1993.06	Front Axle	Saloon RWD 102982		Stabiliser Bushing	511541
	1984.12-1993.06	Front Axle	Saloon RWD 102982		Stabiliser Bushing	517172
	1984.12-1993.06	Front Axle	Saloon RWD 102982		Stabiliser Bushing Kit	511552S
	1984.12-1993.06	Front Axle	Saloon RWD 102982		Stabiliser Bushing Kit	519452S
250						
2.5 (93 kw)						
	1985.03-1993.05	Front Axle Left Lower	Saloon RWD 602962	for vehicles with sports suspension	Track Control Arm	S060579
	1985.03-1993.05	Front Axle Left Lower	Saloon RWD 602962	for vehicles without sports suspension	Track Control Arm	S060581
	1985.03-1993.05	Front Axle Right Lower	Saloon RWD 602962	for vehicles with sports suspension	Track Control Arm	S060580
	1985.03-1993.05	Front Axle Right Lower	Saloon RWD 602962	for vehicles without sports suspension	Track Control Arm	S060582
	1985.03-1993.05	Rear Axle Left & Right Lower Inner	Saloon RWD 602962		Track Control Arm	S060217
	1985.03-1993.05	Rear Axle Left & Right Upper Inner	Saloon RWD 602962		Track Control Arm	S060216
	1985.03-1993.05	Rear Axle Left & Right Lower Outer	Saloon RWD 602962		Track Control Arm	S051055
	1985.03-1993.05	Rear Axle Left & Right Upper Outer	Saloon RWD 602962		Track Control Arm	S060218



	 YEAR	FITTING POSITION	BODY STYLE & DRIVE TYPE & ENGINE	REMARKS	PRODUCT	GSP Ref.
MERCEDES-BENZ						
250						
2.5 (93 kw)	1985.03-1993.05	Front Axle Left & Right Lower	Saloon RWD 602962		Ball Joint	S080141
	1985.03-1993.05	Front Axle Left & Right Lower	Saloon RWD 602962		Control Arm Bushing	510427
	1985.03-1993.05	Front Axle Left & Right Lower	Saloon RWD 602962		Control Arm Bushing	510428
	1985.03-1993.05	Front Axle Left & Right Lower	Saloon RWD 602962		Control Arm Bushing	510563
	1985.03-1993.05	Front Axle Left & Right Lower	Saloon RWD 602962		Control Arm Bushing	510564
	1985.03-1993.05	Rear Axle Left & Right Lower	Saloon RWD 602962		Control Arm Bushing	511560
	1985.03-1993.05	Rear Axle Left & Right Upper Inner	Saloon RWD 602962		Control Arm Bushing	517809
	1985.03-1993.05	Rear Axle Left & Right Lower Outer	Saloon RWD 602962		Control Arm Bushing	510431
	1985.03-1993.05	Rear Axle Left & Right Lower Outer	Saloon RWD 602962		Control Arm Bushing	512252
	1985.03-1993.05	Rear Axle Left & Right Upper Outer	Saloon RWD 602962		Control Arm Bushing	510430
	1985.03-1993.05	Front Axle Left & Right Lower	Saloon RWD 602962		Control Arm Bushing Kit	510426S
	1985.03-1993.05	Rear Axle	Saloon RWD 602962		Suspension Repair Kit	S990038SK
	1985.03-1993.05	Front Axle Left & Right	Saloon RWD 602962		Rod Assembly	S100073
	1985.03-1993.05	Front Axle Left & Right Centre	Saloon RWD 602962		Rod Assembly	S100075
	1985.03-1993.05	Front Axle Left & Right	Saloon RWD 602962		Tie Rod End	S070048
	1985.03-1993.05	Rear Axle Left & Right	Saloon RWD 602962		Rod/Strut, stabiliser	S100063
	1985.03-1993.05	Front Axle Left & Right Outer	Saloon RWD 602962		Stabiliser Bushing	511553
	1985.03-1993.05	Front Axle	Saloon RWD 602962		Stabiliser Bushing	517172
	1985.03-1993.05	Rear Axle	Saloon RWD 602962		Stabiliser Bushing	517269
	1985.03-1993.05	Front Axle	Saloon RWD 602962		Stabiliser Bushing Kit	519452S
	1985.03-1993.05	Rear Axle	Saloon RWD 602962		Stabiliser Bushing Kit	531455S
260						
2.6 (122 kw)	1985.09-1989.12	Front Axle Left Lower	Saloon RWD 103940	for vehicles with sports suspension	Track Control Arm	S060579
	1985.09-1989.12	Front Axle Left Lower	Saloon RWD 103940	for vehicles without sports suspension	Track Control Arm	S060581
	1985.09-1989.12	Front Axle Right Lower	Saloon RWD 103940	for vehicles with sports suspension	Track Control Arm	S060580
	1985.09-1989.12	Front Axle Right Lower	Saloon RWD 103940	for vehicles without sports suspension	Track Control Arm	S060582
	1985.09-1989.12	Rear Axle Left & Right Lower Inner	Saloon RWD 103940		Track Control Arm	S060217
	1985.09-1989.12	Rear Axle Left & Right Upper Inner	Saloon RWD 103940		Track Control Arm	S060216
	1985.09-1989.12	Rear Axle Left & Right Lower Outer	Saloon RWD 103940		Track Control Arm	S051055
	1985.09-1989.12	Rear Axle Left & Right Upper Outer	Saloon RWD 103940		Track Control Arm	S060218
	1985.09-1989.12	Front Axle Left & Right Lower	Saloon RWD 103940		Ball Joint	S080141
	1985.09-1989.12	Front Axle Left & Right Lower	Saloon RWD 103940		Control Arm Bushing	510427
	1985.09-1989.12	Front Axle Left & Right Lower	Saloon RWD 103940		Control Arm Bushing	510428
	1985.09-1989.12	Front Axle Left & Right Lower	Saloon RWD 103940		Control Arm Bushing	510563
	1985.09-1989.12	Rear Axle Left & Right Lower	Saloon RWD 103940		Control Arm Bushing	511560
	1985.09-1989.12	Rear Axle Left & Right Upper Inner	Saloon RWD 103940		Control Arm Bushing	517809
	1985.09-1989.12	Rear Axle Left & Right Lower Outer	Saloon RWD 103940		Control Arm Bushing	510431
	1985.09-1989.12	Rear Axle Left & Right Lower Outer	Saloon RWD 103940		Control Arm Bushing	512252
	1985.09-1989.12	Rear Axle Left & Right Upper Outer	Saloon RWD 103940		Control Arm Bushing	510430
	1985.09-1989.12	Front Axle Left & Right Lower	Saloon RWD 103940		Control Arm Bushing Kit	510426S
	1985.09-1989.12	Rear Axle	Saloon RWD 103940		Suspension Repair Kit	S990038SK
	1985.09-1989.12	Front Axle Left & Right	Saloon RWD 103940		Rod Assembly	S100073
	1985.09-1989.12	Front Axle Left & Right	Saloon RWD 103940	Chassis no.1B 022104,2B 051198	Rod Assembly	S100189
	1985.09-1989.12	Front Axle Left & Right	Saloon RWD 103940	Chassis no.1B 022104,2B 051198	Rod Assembly	S100190
	1985.09-1989.12	Front Axle Left & Right Centre	Saloon RWD 103940		Rod Assembly	S100075
	1985.09-1989.12	Front Axle Left & Right	Saloon RWD 103940		Tie Rod End	S070048
	1985.09-1989.12	Rear Axle Left & Right	Saloon RWD 103940		Rod/Strut, stabiliser	S100063
	1985.09-1989.12	Front Axle Left & Right Outer	Saloon RWD 103940		Stabiliser Bushing	511553
	1985.09-1989.12	Front Axle	Saloon RWD 103940		Stabiliser Bushing	517172
	1985.09-1989.12	Rear Axle	Saloon RWD 103940		Stabiliser Bushing	517269
	1985.09-1989.12	Front Axle	Saloon RWD 103940		Stabiliser Bushing Kit	519452S
300						
3.0 (132 kw)	1985.08-1992.08	Front Axle Left Lower	Saloon RWD 103983	for vehicles with sports suspension	Track Control Arm	S060579
	1985.08-1992.08	Front Axle Left Lower	Saloon RWD 103983	for vehicles without sports suspension	Track Control Arm	S060581
	1985.08-1992.08	Front Axle Right Lower	Saloon RWD 103983	for vehicles with sports suspension	Track Control Arm	S060580
	1985.08-1992.08	Front Axle Right Lower	Saloon RWD 103983	for vehicles without sports suspension	Track Control Arm	S060582
	1985.08-1992.08	Rear Axle Left & Right Lower Inner	Saloon RWD 103983		Track Control Arm	S060217
	1985.08-1992.08	Rear Axle Left & Right Upper Inner	Saloon RWD 103983		Track Control Arm	S060216
	1985.08-1992.08	Rear Axle Left & Right Lower Outer	Saloon RWD 103983		Track Control Arm	S051055
	1985.08-1992.08	Rear Axle Left & Right Upper Outer	Saloon RWD 103983		Track Control Arm	S060218
	1985.08-1992.08	Front Axle Left & Right Lower	Saloon RWD 103983		Ball Joint	S080141
	1985.08-1992.08	Front Axle Left & Right Lower	Saloon RWD 103983		Control Arm Bushing	510427
	1985.08-1992.08	Front Axle Left & Right Lower	Saloon RWD 103983		Control Arm Bushing	510428
	1985.08-1992.08	Front Axle Left & Right Lower	Saloon RWD 103983		Control Arm Bushing	510450



	 YEAR	FITTING POSITION	BODY STYLE & DRIVE TYPE & ENGINE	REMARKS	PRODUCT	GSP Ref.
MERCEDES-BENZ						
300						
3.0 (132 kw)	1985.08-1992.08	Front Axle Left & Right Lower	Saloon RWD 103983		Control Arm Bushing	510563
	1985.08-1992.08	Front Axle Left & Right Lower	Saloon RWD 103983		Control Arm Bushing	510564
	1985.08-1992.08	Rear Axle Left & Right Lower	Saloon RWD 103983		Control Arm Bushing	511560
	1985.08-1992.08	Rear Axle Left & Right Upper Inner	Saloon RWD 103983		Control Arm Bushing	517809
	1985.08-1992.08	Rear Axle Left & Right Lower Outer	Saloon RWD 103983		Control Arm Bushing	510431
	1985.08-1992.08	Rear Axle Left & Right Lower Outer	Saloon RWD 103983		Control Arm Bushing	512252
	1985.08-1992.08	Rear Axle Left & Right Upper Outer	Saloon RWD 103983		Control Arm Bushing	510430
	1985.08-1992.08	Front Axle Left & Right Lower	Saloon RWD 103983		Control Arm Bushing Kit	510426S
	1985.08-1992.08	Rear Axle	Saloon RWD 103983		Suspension Repair Kit	S990038SK
	1985.08-1992.08	Front Axle Left & Right	Saloon RWD 103983		Rod Assembly	S100073
	1985.08-1992.08	Front Axle Left & Right	Saloon RWD 103983	Chassis no.to:1B 022104.2B 051198	Rod Assembly	S100189
	1985.08-1992.08	Front Axle Left & Right	Saloon RWD 103983	Chassis no.to:1B 022104.2B 051198	Rod Assembly	S100190
	1985.08-1992.08	Front Axle Left & Right Centre	Saloon RWD 103983		Rod Assembly	S100075
	1985.08-1992.08	Front Axle Left & Right	Saloon RWD 103983		Tie Rod End	S070048
	1985.08-1992.08	Front Axle Left & Right	Saloon RWD 103983		Tie Rod End	S070308
	1985.08-1992.08	Rear Axle Left & Right	Saloon RWD 103983		Rod/Strut, stabiliser	S100063
	1985.08-1992.08	Front Axle Left & Right Outer	Saloon RWD 103983		Stabiliser Bushing	511553
	1985.08-1992.08	Front Axle	Saloon RWD 103983		Stabiliser Bushing	517172
	1985.08-1992.08	Rear Axle	Saloon RWD 103983		Stabiliser Bushing	517269
	1985.08-1992.08	Front Axle	Saloon RWD 103983		Stabiliser Bushing Kit	519452S
	1985.08-1992.08	Rear Axle	Saloon RWD 103983		Stabiliser Bushing Kit	531455S
	1986.01-1992.08	Front Axle Left Lower	Estate RWD 103983		Track Control Arm	S060581
	1986.01-1992.08	Front Axle Right Lower	Estate RWD 103983		Track Control Arm	S060582
	1986.01-1992.08	Rear Axle Left & Right Lower Inner	Estate RWD 103983		Track Control Arm	S060217
	1986.01-1992.08	Rear Axle Left & Right Upper Inner	Estate RWD 103983		Track Control Arm	S060216
	1986.01-1992.08	Rear Axle Left & Right Lower Outer	Estate RWD 103983		Track Control Arm	S051055
	1986.01-1992.08	Rear Axle Left & Right Upper Outer	Estate RWD 103983		Track Control Arm	S060218
	1986.01-1992.08	Front Axle Left & Right Lower	Estate RWD 103983		Ball Joint	S080141
	1986.01-1992.08	Front Axle Left & Right Lower	Estate RWD 103983		Control Arm Bushing	510427
	1986.01-1992.08	Front Axle Left & Right Lower	Estate RWD 103983		Control Arm Bushing	510428
	1986.01-1992.08	Front Axle Left & Right Lower	Estate RWD 103983		Control Arm Bushing	510563
	1986.01-1992.08	Rear Axle Left & Right Lower	Estate RWD 103983		Control Arm Bushing	511560
	1986.01-1992.08	Rear Axle Left & Right Upper Inner	Estate RWD 103983		Control Arm Bushing	517809
	1986.01-1992.08	Rear Axle Left & Right Lower Outer	Estate RWD 103983		Control Arm Bushing	510431
	1986.01-1992.08	Rear Axle Left & Right Lower Outer	Estate RWD 103983		Control Arm Bushing	512252
	1986.01-1992.08	Rear Axle Left & Right Upper Outer	Estate RWD 103983		Control Arm Bushing	510430
	1986.01-1992.08	Front Axle Left & Right Lower	Estate RWD 103983		Control Arm Bushing Kit	510426S
	1986.01-1992.08	Rear Axle	Estate RWD 103983		Suspension Repair Kit	S990038SK
	1986.01-1992.08	Front Axle Left & Right	Estate RWD 103983		Rod Assembly	S100073
	1986.01-1992.08	Front Axle Left & Right	Estate RWD 103983	Chassis no.to:1F 114568.2F 120743	Rod Assembly	S100189
	1986.01-1992.08	Front Axle Left & Right	Estate RWD 103983	Chassis no.to:1F 114568.2F 120743	Rod Assembly	S100190
	1986.01-1992.08	Front Axle Left & Right Centre	Estate RWD 103983		Rod Assembly	S100075
	1986.01-1992.08	Front Axle Left & Right	Estate RWD 103983		Tie Rod End	S070048
	1986.01-1992.08	Front Axle Left & Right	Estate RWD 103983		Tie Rod End	S070308
	1986.01-1992.08	Rear Axle Left & Right	Estate RWD 103983		Rod/Strut, stabiliser	S050272
	1986.01-1992.08	Front Axle	Estate RWD 103983		Stabiliser Bushing	512608
	1986.01-1992.08	Rear Axle	Estate RWD 103983		Stabiliser Bushing	517269
	1986.01-1992.08	Rear Axle	Estate RWD 103983		Stabiliser Bushing Kit	531455S
3.0 (140 kw)	1989.09-1993.05	Front Axle Left Lower	Cabriolet RWD 103984		Track Control Arm	S060581
	1989.09-1993.05	Front Axle Right Lower	Cabriolet RWD 103984		Track Control Arm	S060582
	1989.09-1993.05	Rear Axle Left & Right Lower Inner	Cabriolet RWD 103984		Track Control Arm	S060217
	1989.09-1993.05	Rear Axle Left & Right Upper Inner	Cabriolet RWD 103984		Track Control Arm	S060216
	1989.09-1993.05	Rear Axle Left & Right Lower Outer	Cabriolet RWD 103984		Track Control Arm	S051055
	1989.09-1993.05	Rear Axle Left & Right Upper Outer	Cabriolet RWD 103984		Track Control Arm	S060218
	1989.09-1993.05	Front Axle Left & Right Lower	Cabriolet RWD 103984		Ball Joint	S080141
	1989.09-1993.05	Front Axle Left & Right Lower	Cabriolet RWD 103984		Control Arm Bushing	510427
	1989.09-1993.05	Front Axle Left & Right Lower	Cabriolet RWD 103984		Control Arm Bushing	510428
	1989.09-1993.05	Front Axle Left & Right Lower	Cabriolet RWD 103984		Control Arm Bushing	510563
	1989.09-1993.05	Rear Axle Left & Right Lower	Cabriolet RWD 103984		Control Arm Bushing	511560
	1989.09-1993.05	Rear Axle Left & Right Lower Outer	Cabriolet RWD 103984		Control Arm Bushing	510431
	1989.09-1993.05	Rear Axle Left & Right Lower Outer	Cabriolet RWD 103984		Control Arm Bushing	512252
	1989.09-1993.05	Rear Axle Left & Right Upper Outer	Cabriolet RWD 103984		Control Arm Bushing	510430
	1989.09-1993.05	Front Axle Left & Right Lower	Cabriolet RWD 103984		Control Arm Bushing Kit	510426S
	1989.09-1993.05	Rear Axle	Cabriolet RWD 103984		Suspension Repair Kit	S990038SK



	 YEAR	FITTING POSITION	BODY STYLE & DRIVE TYPE & ENGINE	REMARKS	PRODUCT	GSP Ref.
MERCEDES-BENZ						
300						
3.0 (140 kw)	1989.09-1993.05	Rear Axle Left & Right	Cabriolet RWD 103984		Rod/Strut, stabiliser	S100063
	1989.09-1993.05	Front Axle Left & Right Outer	Cabriolet RWD 103984		Stabiliser Bushing	511553
3.0 (170 kw)	1989.08-1992.12	Rear Axle Left & Right Lower Inner	Coupe RWD 104980		Track Control Arm	S060217
	1989.08-1992.12	Rear Axle Left & Right Upper Inner	Coupe RWD 104980		Track Control Arm	S060216
	1989.08-1992.12	Rear Axle Left & Right Lower Outer	Coupe RWD 104980		Track Control Arm	S051055
	1989.08-1992.12	Rear Axle Left & Right Upper Outer	Coupe RWD 104980		Track Control Arm	S060218
	1989.08-1992.12	Front Axle Left & Right Lower	Coupe RWD 104980		Ball Joint	S080141
	1989.08-1992.12	Front Axle Left & Right Lower	Coupe RWD 104980		Control Arm Bushing	510427
	1989.08-1992.12	Front Axle Left & Right Lower	Coupe RWD 104980		Control Arm Bushing	510428
	1989.08-1992.12	Front Axle Left & Right Lower	Coupe RWD 104980		Control Arm Bushing	510564
	1989.08-1992.12	Rear Axle Left & Right Lower	Coupe RWD 104980		Control Arm Bushing	511560
	1989.08-1992.12	Rear Axle Left & Right Upper Inner	Coupe RWD 104980		Control Arm Bushing	517809
	1989.08-1992.12	Rear Axle Left & Right Lower Outer	Coupe RWD 104980		Control Arm Bushing	510431
	1989.08-1992.12	Rear Axle Left & Right Lower Outer	Coupe RWD 104980		Control Arm Bushing	512252
	1989.08-1992.12	Rear Axle Left & Right Upper Outer	Coupe RWD 104980		Control Arm Bushing	510430
	1989.08-1992.12	Front Axle Left & Right Lower	Coupe RWD 104980		Control Arm Bushing Kit	510426S
	1989.08-1992.12	Front Axle Left & Right	Coupe RWD 104980		Rod Assembly	S100073
	1989.08-1992.12	Front Axle Left & Right Centre	Coupe RWD 104980		Rod Assembly	S100075
	1989.08-1992.12	Front Axle Left & Right	Coupe RWD 104980		Tie Rod End	S070048
	1989.08-1992.12	Front Axle Left & Right	Coupe RWD 104980		Tie Rod End	S070308
	1989.08-1992.12	Rear Axle Left & Right	Coupe RWD 104980		Rod/Strut, stabiliser	S100063
	1989.08-1992.12	Front Axle Left & Right Outer	Coupe RWD 104980		Stabiliser Bushing	511553
1989.08-1992.12	Front Axle	Coupe RWD 104980		Stabiliser Bushing	517172	
1989.08-1992.12	Rear Axle	Coupe RWD 104980		Stabiliser Bushing	517269	
1989.08-1992.12	Rear Axle	Coupe RWD 104980		Stabiliser Bushing Kit	531455S	
3.2 (170 kw)	1991.06-1993.05	Front Axle Left Upper	Saloon RWD 104990		Track Control Arm	S060267
	1991.06-1993.05	Front Axle Right Upper	Saloon RWD 104990		Track Control Arm	S060268
	1991.06-1993.05	Rear Axle Left & Right Lower Inner	Saloon RWD 104990		Track Control Arm	S060249
	1991.06-1993.05	Rear Axle Left & Right Upper Inner	Saloon RWD 104990		Track Control Arm	S060271
	1991.06-1993.05	Rear Axle Left & Right Upper Outer	Saloon RWD 104990		Track Control Arm	S060272
	1991.06-1993.05	Front Axle Left & Right Lower	Saloon RWD 104990		Ball Joint	S080142
	1991.06-1993.05	Front Axle Left & Right Lower	Saloon RWD 104990		Control Arm Bushing	510428
	1991.06-1993.05	Front Axle Left & Right Lower	Saloon RWD 104990		Control Arm Bushing	510445
	1991.06-1993.05	Rear Axle Left & Right	Saloon RWD 104990		Control Arm Bushing	510500
	1991.06-1993.05	Rear Axle Left & Right Upper	Saloon RWD 104990		Control Arm Bushing	510495
	1991.06-1993.05	Rear Axle Left & Right Upper	Saloon RWD 104990		Control Arm Bushing	510499
	1991.06-1993.05	Rear Axle Left & Right Lower Outer	Saloon RWD 104990		Control Arm Bushing	510446
	1991.06-1993.05	Front Axle Left & Right Lower	Saloon RWD 104990		Control Arm Bushing Kit	510444S
	1991.06-1993.05	Front Axle Left & Right	Saloon RWD 104990		Rod Assembly	S100078
	1991.06-1993.05	Front Axle Left & Right	Saloon RWD 104990		Rod Assembly	S100191
	1991.06-1993.05	Front Axle Left & Right	Saloon RWD 104990		Tie Rod End	S070289
	1991.06-1993.05	Front Axle Left & Right	Saloon RWD 104990		Tie Rod End	S070290
	1991.06-1993.05	Front Axle Left	Saloon RWD 104990		Rod/Strut, stabiliser	S100076
	1991.06-1993.05	Front Axle Right	Saloon RWD 104990		Rod/Strut, stabiliser	S100077
	1991.06-1993.05	Rear Axle Left & Right	Saloon RWD 104990		Rod/Strut, stabiliser	S050281
1991.06-1993.05	Front Axle	Saloon RWD 104990		Stabiliser Bushing	510472	
1991.06-1993.05	Front Axle	Saloon RWD 104990		Stabiliser Bushing	512765	
500						
5.0 (164 kw)	1985.09-1991.06	Front Axle Left & Right Lower	Saloon RWD 117965		Ball Joint	S080127
	1985.09-1991.06	Front Axle Left & Right Upper	Saloon RWD 117965		Control Arm Bushing	510520
	1985.09-1991.06	Front Axle Left & Right Lower	Saloon RWD 117965		Control Arm Bushing Kit	512642S
	1985.09-1991.06	Front Axle Left & Right	Saloon RWD 117965		Rod Assembly	S100070
	1985.09-1991.06	Front Axle Left & Right	Saloon RWD 117965		Rod Assembly	S100186
	1985.09-1991.06	Front Axle Left	Saloon RWD 117965		Tie Rod End	S070270
	1985.09-1991.06	Front Axle Right	Saloon RWD 117965		Tie Rod End	S070271
	1985.09-1991.06	Rear Axle Left & Right	Saloon RWD 117965		Rod/Strut, stabiliser	S050308
	5.0 (185 kw)	1987.09-1991.06	Front Axle Left & Right Lower	Saloon RWD 117965		Ball Joint
1987.09-1991.06		Front Axle Left & Right Upper	Saloon RWD 117965		Control Arm Bushing	510520
1987.09-1991.06		Front Axle Left & Right Lower	Saloon RWD 117965		Control Arm Bushing Kit	512642S
1987.09-1991.06		Front Axle Left & Right	Saloon RWD 117965		Rod Assembly	S100070
1987.09-1991.06		Front Axle Left & Right	Saloon RWD 117965		Rod Assembly	S100186
1987.09-1991.06		Front Axle Left	Saloon RWD 117965		Tie Rod End	S070270
1987.09-1991.06		Front Axle Right	Saloon RWD 117965		Tie Rod End	S070271
1987.09-1991.06		Rear Axle Left & Right	Saloon RWD 117965		Rod/Strut, stabiliser	S050308



	 YEAR	FITTING POSITION	BODY STYLE & DRIVE TYPE & ENGINE	REMARKS	PRODUCT	GSP Ref.
MERCEDES-BENZ						
500						
5.0 (235 kw)	1991.06-1993.05	Front Axle Left Upper	Saloon RWD 119970		Track Control Arm	S060267
	1991.06-1993.05	Front Axle Right Upper	Saloon RWD 119970		Track Control Arm	S060268
	1991.06-1993.05	Rear Axle Left & Right Lower Inner	Saloon RWD 119970		Track Control Arm	S060249
	1991.06-1993.05	Rear Axle Left & Right Upper Inner	Saloon RWD 119970		Track Control Arm	S060271
	1991.06-1993.05	Rear Axle Left & Right Upper Outer	Saloon RWD 119970		Track Control Arm	S060272
	1991.06-1993.05	Front Axle Left & Right Lower	Saloon RWD 119970		Ball Joint	S080142
	1991.06-1993.05	Front Axle Left & Right Lower	Saloon RWD 119970		Control Arm Bushing	510428
	1991.06-1993.05	Front Axle Left & Right Lower	Saloon RWD 119970		Control Arm Bushing	510445
	1991.06-1993.05	Rear Axle Left & Right	Saloon RWD 119970		Control Arm Bushing	510500
	1991.06-1993.05	Rear Axle Left & Right Upper	Saloon RWD 119970		Control Arm Bushing	510495
	1991.06-1993.05	Rear Axle Left & Right Upper	Saloon RWD 119970		Control Arm Bushing	510499
	1991.06-1993.05	Rear Axle Left & Right Lower Outer	Saloon RWD 119970		Control Arm Bushing	510446
	1991.06-1993.05	Front Axle Left & Right Lower	Saloon RWD 119970		Control Arm Bushing Kit	510444S
	1991.06-1993.05	Front Axle Left & Right	Saloon RWD 119970		Rod Assembly	S100078
	1991.06-1993.05	Front Axle Left & Right	Saloon RWD 119970		Rod Assembly	S100191
	1991.06-1993.05	Front Axle Left & Right	Saloon RWD 119970		Tie Rod End	S070289
	1991.06-1993.05	Front Axle Left & Right	Saloon RWD 119970		Tie Rod End	S070290
	1991.06-1993.05	Front Axle Left	Saloon RWD 119970		Rod/Strut,stabiliser	S100076
	1991.06-1993.05	Front Axle Right	Saloon RWD 119970		Rod/Strut,stabiliser	S100077
	1991.06-1993.05	Rear Axle Left & Right	Saloon RWD 119970		Rod/Strut,stabiliser	S050281
	1991.06-1993.05	Front Axle	Saloon RWD 119970		Stabiliser Bushing	510472
	1991.06-1993.05	Front Axle	Saloon RWD 119970		Stabiliser Bushing	512765
5.0 (240 kw)	1989.09-1993.05	Front Axle Left Lower	Cabriolet RWD 119960		Track Control Arm	S060581
	1989.09-1993.05	Front Axle Right Lower	Cabriolet RWD 119960		Track Control Arm	S060582
	1989.09-1993.05	Rear Axle Left & Right Lower Inner	Cabriolet RWD 119960		Track Control Arm	S060217
	1989.09-1993.05	Rear Axle Left & Right Upper Inner	Cabriolet RWD 119960	<small>Check to boot! 50007 Control arm, stabiliser, lower ball for country spec, 50008 ball, boot...</small>	Track Control Arm	S060216
	1989.09-1993.05	Rear Axle Left & Right Lower Outer	Cabriolet RWD 119960		Track Control Arm	S051055
	1989.09-1993.05	Rear Axle Left & Right Upper Outer	Cabriolet RWD 119960		Track Control Arm	S060218
	1989.09-1993.05	Front Axle Left & Right Lower	Cabriolet RWD 119960		Ball Joint	S080141
	1989.09-1993.05	Front Axle Left & Right Lower	Cabriolet RWD 119960		Control Arm Bushing	510427
	1989.09-1993.05	Front Axle Left & Right Lower	Cabriolet RWD 119960		Control Arm Bushing	510428
	1989.09-1993.05	Front Axle Left & Right Lower	Cabriolet RWD 119960		Control Arm Bushing	510563
	1989.09-1993.05	Rear Axle Left & Right Lower	Cabriolet RWD 119960		Control Arm Bushing	511560
	1989.09-1993.05	Rear Axle Left & Right Upper Inner	Cabriolet RWD 119960		Control Arm Bushing	517809
	1989.09-1993.05	Rear Axle Left & Right Lower Outer	Cabriolet RWD 119960		Control Arm Bushing	510431
	1989.09-1993.05	Rear Axle Left & Right Lower Outer	Cabriolet RWD 119960		Control Arm Bushing	512252
	1989.09-1993.05	Rear Axle Left & Right Upper Outer	Cabriolet RWD 119960		Control Arm Bushing	510430
	1989.09-1993.05	Front Axle Left & Right Lower	Cabriolet RWD 119960		Control Arm Bushing Kit	510426S
	1989.09-1993.05	Rear Axle	Cabriolet RWD 119960		Suspension Repair Kit	S990038SK
	1989.09-1993.05	Rear Axle Left & Right	Cabriolet RWD 119960		Rod/Strut,stabiliser	S100063
	1989.09-1993.05	Front Axle Left & Right Outer	Cabriolet RWD 119960		Stabiliser Bushing	511553
600						
6.0 (290 kw)	1991.08-1993.05	Rear Axle Left & Right Lower Inner	Cabriolet RWD 120983		Track Control Arm	S060217
	1991.08-1993.05	Rear Axle Left & Right Upper Inner	Cabriolet RWD 120983	<small>Check to boot! 50007 Control arm, stabiliser, lower ball for country spec, 50008 ball, boot...</small>	Track Control Arm	S060216
	1991.08-1993.05	Rear Axle Left & Right Lower Outer	Cabriolet RWD 120983		Track Control Arm	S051055
	1991.08-1993.05	Rear Axle Left & Right Upper Outer	Cabriolet RWD 120983		Track Control Arm	S060218
	1991.08-1993.05	Front Axle Left & Right Lower	Cabriolet RWD 120983		Ball Joint	S080141
	1991.08-1993.05	Front Axle Left & Right Lower	Cabriolet RWD 120983		Control Arm Bushing	510427
	1991.08-1993.05	Front Axle Left & Right Lower	Cabriolet RWD 120983		Control Arm Bushing	510428
	1991.08-1993.05	Rear Axle Left & Right Lower	Cabriolet RWD 120983		Control Arm Bushing	511560
	1991.08-1993.05	Rear Axle Left & Right Upper Inner	Cabriolet RWD 120983		Control Arm Bushing	517809
	1991.08-1993.05	Rear Axle Left & Right Lower Outer	Cabriolet RWD 120983		Control Arm Bushing	510431
	1991.08-1993.05	Rear Axle Left & Right Lower Outer	Cabriolet RWD 120983		Control Arm Bushing	512252
	1991.08-1993.05	Rear Axle Left & Right Upper Outer	Cabriolet RWD 120983		Control Arm Bushing	510430
	1991.08-1993.05	Rear Axle	Cabriolet RWD 120983		Suspension Repair Kit	S990038SK
	1991.08-1993.05	Rear Axle Left & Right	Cabriolet RWD 120983		Rod/Strut,stabiliser	S100063
	1991.08-1993.05	Front Axle Left & Right Outer	Cabriolet RWD 120983		Stabiliser Bushing	511553
	1991.08-1993.05	Front Axle	Cabriolet RWD 120983		Stabiliser Bushing Kit	519452S
A160						
1.6 (75 kw)	1997.07-2005.08	Front Axle Left Lower	Hatchback FWD 166960		Track Control Arm	S060852
	1997.07-2005.08	Front Axle Right Lower	Hatchback FWD 166960		Track Control Arm	S060851
	1997.07-2005.08	Front Axle Left & Right Lower	Hatchback FWD 166960		Ball Joint	S080132
	1997.07-2005.08	Front Axle Left & Right Lower	Hatchback FWD 166960		Control Arm Bushing	517629
	1997.07-2005.08	Front Axle Left & Right Lower	Hatchback FWD 166960		Control Arm Bushing	517870



	 YEAR	FITTING POSITION	BODY STYLE & DRIVE TYPE & ENGINE	REMARKS	PRODUCT	GSP Ref.	
MERCEDES-BENZ							
A160							
1.6 (75 kw)	1997.07-2005.08	Front Axle	Hatchback FWD 166960		Suspension Repair Kit	S990005SK	
	1997.07-2005.08	Front Axle Left & Right	Hatchback FWD 166960		Tie Rod Axle Joint	S030162	
	1997.07-2005.08	Front Axle Left	Hatchback FWD 166960		Tie Rod End	S070278	
	1997.07-2005.08	Front Axle Right	Hatchback FWD 166960		Tie Rod End	S070277	
	1997.07-2005.08	Front Axle Left & Right	Hatchback FWD 166960		Tie Rod End	S070824	
	1997.07-2005.08	Front Axle Left & Right	Hatchback FWD 166960		Tie Rod End	S070866	
	1997.07-2005.08	Front Axle Left & Right	Hatchback FWD 166960		Rod/Strut, stabiliser	S050269	
A190							
1.9 (92 kw)	1999.02-2005.06	Front Axle Left Lower	Hatchback FWD 166990		Track Control Arm	S060852	
	1999.02-2005.06	Front Axle Right Lower	Hatchback FWD 166990		Track Control Arm	S060851	
	1999.02-2005.06	Front Axle Left & Right Lower	Hatchback FWD 166990		Ball Joint	S080132	
	1999.02-2005.06	Front Axle Left & Right Lower	Hatchback FWD 166990		Control Arm Bushing	517629	
	1999.02-2005.06	Front Axle Left & Right Lower	Hatchback FWD 166990		Control Arm Bushing	517870	
	1999.02-2005.06	Front Axle	Hatchback FWD 166990		Suspension Repair Kit	S990005SK	
	1999.02-2005.06	Front Axle Left & Right	Hatchback FWD 166990		Tie Rod Axle Joint	S030162	
	1999.02-2005.06	Front Axle Left	Hatchback FWD 166990		Tie Rod End	S070278	
	1999.02-2005.06	Front Axle Right	Hatchback FWD 166990		Tie Rod End	S070277	
1999.02-2005.06	Front Axle Left & Right	Hatchback FWD 166990		Rod/Strut, stabiliser	S050269		
A200							
1.3 (120 kw)	2018.03-	Front Axle Left Upper Outer	Hatchback FWD 282914		Track Control Arm	S063236	
	2018.03-	Front Axle Right Upper Outer	Hatchback FWD 282914		Track Control Arm	S063235	
	2018.03-	Front Axle Left Upper Outer	Hatchback FWD 282914		Control Arm Bushing	535467	
	2018.03-	Front Axle Left & Right	Hatchback FWD 282914		Tie Rod Axle Joint	S031026	
	2018.03-	Front Axle Left	Hatchback FWD 282914		Tie Rod End	S071776	
	2018.03-	Front Axle Right	Hatchback FWD 282914		Tie Rod End	S071777	
	2018.03-	Front Axle Left & Right	Hatchback FWD 282914		Rod/Strut, stabiliser	S051359	
	2018.03-	Rear Axle Left & Right	Hatchback FWD 282914		Rod/Strut, stabiliser	S051428	
	2018.09-	Front Axle Left Upper Outer	Saloon FWD 282914		Track Control Arm	S063236	
	2018.09-	Front Axle Right Upper Outer	Saloon FWD 282914		Track Control Arm	S063235	
	2018.09-	Front Axle Left Upper Outer	Saloon FWD 282914		Control Arm Bushing	535467	
	2018.09-	Front Axle Left & Right	Saloon FWD 282914		Tie Rod Axle Joint	S031026	
	2018.09-	Front Axle Left	Saloon FWD 282914	Veh Prd Country:Mexico	Tie Rod End	S071763	
	2018.09-	Front Axle Left	Saloon FWD 282914		Tie Rod End	S071776	
	2018.09-	Front Axle Right	Saloon FWD 282914	Veh Prd Country:Mexico	Tie Rod End	S071762	
	2018.09-	Front Axle Right	Saloon FWD 282914		Tie Rod End	S071777	
	2018.09-	Front Axle Left & Right	Saloon FWD 282914		Rod/Strut, stabiliser	S051359	
	2018.09-	Rear Axle Left & Right	Saloon FWD 282914		Rod/Strut, stabiliser	S051428	
	1.6 (115 kw)	2012.06-2018.05	Front Axle Left Lower	Hatchback FWD 270910		Track Control Arm	S061677
2012.06-2018.05		Front Axle Right Lower	Hatchback FWD 270910		Track Control Arm	S061678	
2012.06-2018.05		Rear Axle Left Upper Inner	Hatchback FWD 270910		Track Control Arm	S062803	
2012.06-2018.05		Rear Axle Right Upper Inner	Hatchback FWD 270910		Track Control Arm	S063056	
2012.06-2018.05		Rear Axle Left & Right Lower Inner	Hatchback FWD 270910		Track Control Arm	S062807	
2012.06-2018.05		Rear Axle Left & Right Upper Outer	Hatchback FWD 270910		Track Control Arm	S062796	
2012.06-2018.05		Front Axle Left Lower	Hatchback FWD 270910		Control Arm Bushing	532866	
2012.06-2018.05		Front Axle Right Lower	Hatchback FWD 270910		Control Arm Bushing	532867	
2012.06-2018.05		Front Axle Left & Right Lower	Hatchback FWD 270910		Control Arm Bushing	535310	
2012.06-2018.05		Rear Axle Left & Right Lower Inner	Hatchback FWD 270910		Control Arm Bushing	535266	
2012.06-2018.05		Rear Axle Left & Right Upper Outer	Hatchback FWD 270910		Control Arm Bushing	535261	
2012.06-2018.05		Front Axle Left & Right	Hatchback FWD 270910		Tie Rod Axle Joint	S031088	
2012.06-2018.05		Front Axle Left	Hatchback FWD 270910		Tie Rod End	S071367	
2012.06-2018.05		Front Axle Right	Hatchback FWD 270910		Tie Rod End	S071368	
2012.06-2018.05		Front Axle Left & Right	Hatchback FWD 270910		Rod/Strut, stabiliser	S051410	
2012.06-2018.05		Rear Axle Left & Right	Hatchback FWD 270910	Date from:2013.12	Rod/Strut, stabiliser	S051251	
2012.06-2018.05		Rear Axle Left & Right	Hatchback FWD 270910	For OE no.2463200489	Rod/Strut, stabiliser	S051263	
2.0 (100 kw)		2004.09-2012.06	Front Axle Left & Right Lower	Hatchback FWD 266960		Ball Joint	S080133
		2004.09-2012.06	Front Axle Left & Right	Hatchback FWD 266960		Tie Rod Axle Joint	S030164
	2004.09-2012.06	Front Axle Left	Hatchback FWD 266960		Tie Rod End	S070282	
	2004.09-2012.06	Front Axle Right	Hatchback FWD 266960		Tie Rod End	S070283	
	2004.09-2012.06	Front Axle Left & Right	Hatchback FWD 266960		Rod/Strut, stabiliser	S050277	
	2004.09-2012.06	Rear Axle Left & Right	Hatchback FWD 266960		Rod/Strut, stabiliser	S051200	
	2004.09-2012.06	Rear Axle	Hatchback FWD 266960		Stabiliser Bushing	517269	
A250							
2.0 (155 kw)	2012.06-2018.05	Front Axle Left Lower	Hatchback FWD 270920		Track Control Arm	S061677	
	2012.06-2018.05	Front Axle Right Lower	Hatchback FWD 270920		Track Control Arm	S061678	



	 YEAR	FITTING POSITION	BODY STYLE & DRIVE TYPE & ENGINE	REMARKS	PRODUCT	GSP Ref.	
MERCEDES-BENZ A250							
2.0 (155 kw)	2012.06-2018.05	Rear Axle Left Upper Inner	Hatchback FWD 270920		Track Control Arm	S062803	
	2012.06-2018.05	Rear Axle Right Upper Inner	Hatchback FWD 270920		Track Control Arm	S063056	
	2012.06-2018.05	Rear Axle Left & Right Lower Inner	Hatchback FWD 270920		Track Control Arm	S062807	
	2012.06-2018.05	Rear Axle Left & Right Upper Outer	Hatchback FWD 270920		Track Control Arm	S062796	
	2012.06-2018.05	Front Axle Left Lower	Hatchback FWD 270920		Control Arm Bushing	532866	
	2012.06-2018.05	Front Axle Right Lower	Hatchback FWD 270920		Control Arm Bushing	532867	
	2012.06-2018.05	Front Axle Left & Right Lower	Hatchback FWD 270920		Control Arm Bushing	535310	
	2012.06-2018.05	Rear Axle Left & Right Lower Inner	Hatchback FWD 270920		Control Arm Bushing	535266	
	2012.06-2018.05	Rear Axle Left & Right Upper Outer	Hatchback FWD 270920		Control Arm Bushing	535261	
	2012.06-2018.05	Front Axle Left & Right	Hatchback FWD 270920		Tie Rod Axle Joint	S031088	
	2012.06-2018.05	Front Axle Left	Hatchback FWD 270920		Tie Rod End	S071367	
	2012.06-2018.05	Front Axle Right	Hatchback FWD 270920		Tie Rod End	S071368	
	2012.06-2018.05	Front Axle Left & Right	Hatchback FWD 270920		Rod/Strut, stabiliser	S051410	
	2012.06-2018.05	Rear Axle Left & Right	Hatchback FWD 270920	Date from:2013.12	Rod/Strut, stabiliser	S051251	
2.0 (165 kw)	2012.06-2018.05	Rear Axle Left & Right	Hatchback FWD 270920	For OE no.2463200489	Rod/Strut, stabiliser	S051263	
	2018.03-	Front Axle Left Upper Outer	Hatchback FWD 260920		Track Control Arm	S063236	
	2018.03-	Front Axle Right Upper Outer	Hatchback FWD 260920		Track Control Arm	S063235	
	2018.03-	Front Axle Left Upper Outer	Hatchback FWD 260920		Control Arm Bushing	535467	
	2018.03-	Front Axle Left & Right	Hatchback FWD 260920		Tie Rod Axle Joint	S031026	
	2018.03-	Front Axle Left	Hatchback FWD 260920		Tie Rod End	S071776	
	2018.03-	Front Axle Right	Hatchback FWD 260920		Tie Rod End	S071777	
	2018.03-	Front Axle Left & Right	Hatchback FWD 260920		Rod/Strut, stabiliser	S051359	
2018.03-	Rear Axle Left & Right	Hatchback FWD 260920		Rod/Strut, stabiliser	S051428		
A35 AMG							
2.0 (225 kw)	2018.09-	Front Axle Left Upper Outer	Hatchback 4WD 260920		Track Control Arm	S063236	
	2018.09-	Front Axle Right Upper Outer	Hatchback 4WD 260920		Track Control Arm	S063235	
	2018.09-	Front Axle Left & Right	Hatchback 4WD 260920		Tie Rod Axle Joint	S031026	
	2018.09-	Front Axle Left	Hatchback 4WD 260920		Tie Rod End	S071776	
	2018.09-	Front Axle Right	Hatchback 4WD 260920		Tie Rod End	S071777	
	2018.09-	Front Axle Left & Right	Hatchback 4WD 260920		Rod/Strut, stabiliser	S051359	
	2018.09-	Rear Axle Left & Right	Hatchback 4WD 260920		Rod/Strut, stabiliser	S051428	
	2019.03-	Front Axle Left Upper Outer	Saloon 4WD 260920		Track Control Arm	S063236	
	2019.03-	Front Axle Right Upper Outer	Saloon 4WD 260920		Track Control Arm	S063235	
	2019.03-	Front Axle Left & Right	Saloon 4WD 260920		Tie Rod Axle Joint	S031026	
	2019.03-	Front Axle Left	Saloon 4WD 260920		Tie Rod End	S071776	
	2019.03-	Front Axle Right	Saloon 4WD 260920		Tie Rod End	S071777	
	2019.03-	Front Axle Left & Right	Saloon 4WD 260920		Rod/Strut, stabiliser	S051359	
	2019.03-	Rear Axle Left & Right	Saloon 4WD 260920		Rod/Strut, stabiliser	S051428	
A45 AMG							
2.0 (265 kw)	2013.04-2018.05	Front Axle Left Lower	Hatchback 4WD 133980		Track Control Arm	S061677	
	2013.04-2018.05	Front Axle Right Lower	Hatchback 4WD 133980		Track Control Arm	S061678	
	2013.04-2018.05	Rear Axle Left Upper Inner	Hatchback 4WD 133980		Track Control Arm	S062803	
	2013.04-2018.05	Rear Axle Right Upper Inner	Hatchback 4WD 133980		Track Control Arm	S063056	
	2013.04-2018.05	Rear Axle Left & Right Lower Inner	Hatchback 4WD 133980		Track Control Arm	S062807	
	2013.04-2018.05	Rear Axle Left & Right Upper Outer	Hatchback 4WD 133980		Track Control Arm	S062796	
	2013.04-2018.05	Front Axle Left Lower	Hatchback 4WD 133980		Control Arm Bushing	532866	
	2013.04-2018.05	Front Axle Right Lower	Hatchback 4WD 133980		Control Arm Bushing	532867	
	2013.04-2018.05	Front Axle Left & Right Lower	Hatchback 4WD 133980		Control Arm Bushing	535310	
	2013.04-2018.05	Rear Axle Left & Right Lower Inner	Hatchback 4WD 133980		Control Arm Bushing	535266	
	2013.04-2018.05	Rear Axle Left & Right Upper Outer	Hatchback 4WD 133980		Control Arm Bushing	535261	
	2013.04-2018.05	Front Axle Left & Right	Hatchback 4WD 133980		Tie Rod Axle Joint	S031088	
	2013.04-2018.05	Front Axle Left	Hatchback 4WD 133980		Tie Rod End	S071367	
	2013.04-2018.05	Front Axle Right	Hatchback 4WD 133980		Tie Rod End	S071368	
	2013.04-2018.05	Front Axle Left & Right	Hatchback 4WD 133980		Rod/Strut, stabiliser	S051410	
	2013.04-2018.05	Rear Axle Left & Right	Hatchback 4WD 133980	For OE no.2463200100	Rod/Strut, stabiliser	S051251	
	2013.04-2018.05	Rear Axle Left & Right	Hatchback 4WD 133980	For OE no.2463200489	Rod/Strut, stabiliser	S051263	
	2.0 (310 kw)	2019.07-	Front Axle Left Upper Outer	Hatchback 4WD 139980		Track Control Arm	S063236
		2019.07-	Front Axle Right Upper Outer	Hatchback 4WD 139980		Track Control Arm	S063235
		2019.07-	Front Axle Left & Right	Hatchback 4WD 139980		Tie Rod Axle Joint	S031026
2019.07-		Front Axle Left	Hatchback 4WD 139980		Tie Rod End	S071776	
2019.07-		Front Axle Right	Hatchback 4WD 139980		Tie Rod End	S071777	
2019.07-		Front Axle Left & Right	Hatchback 4WD 139980		Rod/Strut, stabiliser	S051359	
2019.07-		Rear Axle Left & Right	Hatchback 4WD 139980		Rod/Strut, stabiliser	S051428	



	 YEAR	FITTING POSITION	BODY STYLE & DRIVE TYPE & ENGINE	REMARKS	PRODUCT	GSP Ref.
MERCEDES-BENZ AMG GT						
4.0 (340 kw)	2014.10-	Front Axle Left	Coupe RWD 178980		Tie Rod End	S070284
	2014.10-	Front Axle Right	Coupe RWD 178980		Tie Rod End	S070285
4.0 (375 kw)	2014.10-	Front Axle Left	Coupe RWD 178980		Tie Rod End	S070284
	2014.10-	Front Axle Right	Coupe RWD 178980		Tie Rod End	S070285
AMG GT 63						
4.0 (470 kw)	2018.07-	Front Axle Left & Right	Coupe 4WD 177980		Tie Rod Axle Joint	S031025
	2018.07-	Front Axle Left	Coupe 4WD 177980		Tie Rod End	S071773
	2018.07-	Front Axle	Coupe 4WD 177980		Steering Boot	541030
B180						
1.7 (85 kw)	2009.04-2011.11	Front Axle Left & Right Lower	Hatchback FWD 266940		Ball Joint	S080133
	2009.04-2011.11	Front Axle Left & Right Lower	Hatchback FWD 266940		Control Arm Bushing	530238
	2009.04-2011.11	Front Axle Left	Hatchback FWD 266940		Tie Rod End	S070282
	2009.04-2011.11	Front Axle Right	Hatchback FWD 266940		Tie Rod End	S070283
	2009.04-2011.11	Front Axle Left & Right	Hatchback FWD 266940		Rod/Strut, stabiliser	S050277
	2009.04-2011.11	Rear Axle Left & Right	Hatchback FWD 266940		Rod/Strut, stabiliser	S051200
B200						
1.6 (115 kw)	2011.11-2018.12	Front Axle Left Lower	Hatchback FWD 270910		Track Control Arm	S061677
	2011.11-2018.12	Front Axle Right Lower	Hatchback FWD 270910		Track Control Arm	S061678
	2011.11-2018.12	Rear Axle Left Upper Inner	Hatchback FWD 270910		Track Control Arm	S062803
	2011.11-2018.12	Rear Axle Right Upper Inner	Hatchback FWD 270910		Track Control Arm	S063056
	2011.11-2018.12	Rear Axle Left & Right Lower Inner	Hatchback FWD 270910		Track Control Arm	S062807
	2011.11-2018.12	Rear Axle Left & Right Upper Outer	Hatchback FWD 270910		Track Control Arm	S062796
	2011.11-2018.12	Front Axle Left Lower	Hatchback FWD 270910		Control Arm Bushing	532866
	2011.11-2018.12	Front Axle Right Lower	Hatchback FWD 270910		Control Arm Bushing	532867
	2011.11-2018.12	Front Axle Left & Right Lower	Hatchback FWD 270910		Control Arm Bushing	535310
	2011.11-2018.12	Rear Axle Left & Right Lower Inner	Hatchback FWD 270910		Control Arm Bushing	535266
	2011.11-2018.12	Rear Axle Left & Right Upper Outer	Hatchback FWD 270910		Control Arm Bushing	535261
	2011.11-2018.12	Front Axle Left & Right	Hatchback FWD 270910		Tie Rod Axle Joint	S031088
	2011.11-2018.12	Front Axle Left	Hatchback FWD 270910		Tie Rod End	S071367
	2011.11-2018.12	Front Axle Right	Hatchback FWD 270910		Tie Rod End	S071368
	2011.11-2018.12	Front Axle Left & Right	Hatchback FWD 270910		Rod/Strut, stabiliser	S051410
	2011.11-2018.12	Rear Axle Left & Right	Hatchback FWD 270910	Date from:2013.12	Rod/Strut, stabiliser	S051251
	2011.11-2018.12	Rear Axle Left & Right	Hatchback FWD 270910	For OE no.2463200489	Rod/Strut, stabiliser	S051263
	2.0 (100 kw)	2005.03-2011.11	Front Axle Left & Right Lower	Hatchback FWD 266960		Ball Joint
2005.03-2011.11		Front Axle Left & Right Lower	Hatchback FWD 266960		Control Arm Bushing	530238
2005.03-2011.11		Front Axle Left	Hatchback FWD 266960		Tie Rod End	S070282
2005.03-2011.11		Front Axle Right	Hatchback FWD 266960		Tie Rod End	S070283
2005.03-2011.11		Front Axle Left & Right	Hatchback FWD 266960		Rod/Strut, stabiliser	S050277
2005.03-2011.11		Rear Axle Left & Right	Hatchback FWD 266960		Rod/Strut, stabiliser	S051200
C180						
1.6 (115 kw)	2013.07-	Front Axle Left Upper	Saloon RWD 274910		Track Control Arm	S062802
	2013.07-	Front Axle Left Lower Inner	Saloon RWD 274910		Track Control Arm	S062805
	2013.07-	Front Axle Left Lower Outer	Saloon RWD 274910		Track Control Arm	S062844
	2013.07-	Front Axle Right Upper	Saloon RWD 274910		Track Control Arm	S062801
	2013.07-	Front Axle Right Lower Inner	Saloon RWD 274910		Track Control Arm	S062806
	2013.07-	Front Axle Right Lower Outer	Saloon RWD 274910		Track Control Arm	S062845
	2013.07-	Rear Axle Left Upper Inner	Saloon RWD 274910		Track Control Arm	S063227
	2013.07-	Rear Axle Left Lower Outer	Saloon RWD 274910		Track Control Arm	S061566
	2013.07-	Rear Axle Left Upper Outer	Saloon RWD 274910		Track Control Arm	S062798
	2013.07-	Rear Axle Right Upper Inner	Saloon RWD 274910		Track Control Arm	S063228
	2013.07-	Rear Axle Right Lower Outer	Saloon RWD 274910		Track Control Arm	S061567
	2013.07-	Rear Axle Right Upper Outer	Saloon RWD 274910		Track Control Arm	S062797
	2013.07-	Rear Axle Left & Right Lower Inner	Saloon RWD 274910		Track Control Arm	S062799
	2013.07-	Front Axle Left & Right Upper	Saloon RWD 274910		Control Arm Bushing	510529
	2013.07-	Front Axle Left & Right Lower Inner	Saloon RWD 274910		Control Arm Bushing	533481
	2013.07-	Front Axle Left & Right Lower Inner	Saloon RWD 274910		Control Arm Bushing	533482
	2013.07-	Front Axle Left & Right Lower Inner	Saloon RWD 274910		Control Arm Bushing	535418
	2013.07-	Front Axle Left & Right Lower Outer	Saloon RWD 274910		Control Arm Bushing	535456
	2013.07-	Rear Axle Left & Right Lower Inner	Saloon RWD 274910		Control Arm Bushing	530527
	2013.07-	Rear Axle Left & Right Upper Inner	Saloon RWD 274910		Control Arm Bushing	516563
	2013.07-	Rear Axle Left & Right Upper Inner	Saloon RWD 274910		Control Arm Bushing	530504
	2013.07-	Rear Axle Left & Right Upper Inner	Saloon RWD 274910		Control Arm Bushing	533480
	2013.07-	Rear Axle Left & Right Lower Outer	Saloon RWD 274910		Control Arm Bushing	516552
	2013.07-	Rear Axle Left & Right Lower Outer	Saloon RWD 274910		Control Arm Bushing	516553



	 YEAR	FITTING POSITION	BODY STYLE & DRIVE TYPE & ENGINE	REMARKS	PRODUCT	GSP Ref.
MERCEDES-BENZ C180						
1.6 (115 kw)	2013.07-	Front Axle Left & Right	Saloon RWD 274910		Tie Rod Axle Joint	S030926
	2013.07-	Front Axle Left	Saloon RWD 274910		Tie Rod End	S071616
	2013.07-	Front Axle Right	Saloon RWD 274910		Tie Rod End	S071617
	2013.07-	Front Axle Left	Saloon RWD 274910		Rod/Strut, stabiliser	S051250
	2013.07-	Front Axle Right	Saloon RWD 274910		Rod/Strut, stabiliser	S051249
	2013.07-	Rear Axle Left	Saloon RWD 274910		Rod/Strut, stabiliser	S051247
	2013.07-	Rear Axle Right	Saloon RWD 274910		Rod/Strut, stabiliser	S051248
	2014.03-	Front Axle Left Lower Outer	Saloon RWD M 274.910		Track Control Arm	S062844
	2014.03-	Rear Axle Left Upper Inner	Saloon RWD M 274.910		Track Control Arm	S063227
	2014.03-	Rear Axle Right Upper Inner	Saloon RWD M 274.910		Track Control Arm	S063228
	2014.03-	Front Axle Left & Right Lower Outer	Saloon RWD M 274.910		Control Arm Bushing	535456
	2014.03-	Rear Axle Left & Right Lower Outer	Saloon RWD M 274.910		Control Arm Bushing	516552
	2014.03-	Front Axle Left	Saloon RWD M 274.910		Rod/Strut, stabiliser	S051250
	2014.03-	Front Axle Right	Saloon RWD M 274.910		Rod/Strut, stabiliser	S051249
	2014.09-	Front Axle Left Upper	Estate RWD 274910		Track Control Arm	S062802
	2014.09-	Front Axle Left Lower Inner	Estate RWD 274910		Track Control Arm	S062805
	2014.09-	Front Axle Left Lower Outer	Estate RWD 274910		Track Control Arm	S062844
	2014.09-	Front Axle Right Upper	Estate RWD 274910		Track Control Arm	S062801
	2014.09-	Front Axle Right Inner	Estate RWD 274910		Track Control Arm	S062806
	2014.09-	Front Axle Right Lower Outer	Estate RWD 274910		Track Control Arm	S062845
	2014.09-	Rear Axle Left Upper Inner	Estate RWD 274910		Track Control Arm	S063227
	2014.09-	Rear Axle Left Lower Outer	Estate RWD 274910		Track Control Arm	S061566
	2014.09-	Rear Axle Left Upper Outer	Estate RWD 274910		Track Control Arm	S062798
	2014.09-	Rear Axle Right Upper Inner	Estate RWD 274910		Track Control Arm	S063228
	2014.09-	Rear Axle Right Lower Outer	Estate RWD 274910		Track Control Arm	S061567
	2014.09-	Rear Axle Right Upper Outer	Estate RWD 274910		Track Control Arm	S062797
	2014.09-	Rear Axle Left & Right Lower Inner	Estate RWD 274910		Track Control Arm	S062799
	2014.09-	Front Axle Left & Right Upper	Estate RWD 274910		Control Arm Bushing	510529
	2014.09-	Front Axle Left & Right Lower Inner	Estate RWD 274910		Control Arm Bushing	533481
	2014.09-	Front Axle Left & Right Lower Inner	Estate RWD 274910		Control Arm Bushing	533482
	2014.09-	Front Axle Left & Right Lower Inner	Estate RWD 274910		Control Arm Bushing	535418
	2014.09-	Front Axle Left & Right Lower Outer	Estate RWD 274910		Control Arm Bushing	535456
	2014.09-	Rear Axle Left & Right Lower Inner	Estate RWD 274910		Control Arm Bushing	530527
	2014.09-	Rear Axle Left & Right Upper Inner	Estate RWD 274910		Control Arm Bushing	530504
	2014.09-	Rear Axle Left & Right Upper Inner	Estate RWD 274910		Control Arm Bushing	533480
	2014.09-	Rear Axle Left & Right Lower Outer	Estate RWD 274910		Control Arm Bushing	516552
	2014.09-	Rear Axle Left & Right Lower Outer	Estate RWD 274910		Control Arm Bushing	516553
	2014.09-	Rear Axle Left & Right Upper Outer	Estate RWD 274910		Control Arm Bushing	531454
	2014.09-	Front Axle Left & Right	Estate RWD 274910		Tie Rod Axle Joint	S030926
	2014.09-	Front Axle Left	Estate RWD 274910		Tie Rod End	S071616
	2014.09-	Front Axle Right	Estate RWD 274910		Tie Rod End	S071617
	2014.09-	Front Axle Left	Estate RWD 274910		Rod/Strut, stabiliser	S051250
	2014.09-	Front Axle Right	Estate RWD 274910		Rod/Strut, stabiliser	S051249
	2014.09-	Rear Axle Left	Estate RWD 274910		Rod/Strut, stabiliser	S051247
	2014.09-	Rear Axle Right	Estate RWD 274910		Rod/Strut, stabiliser	S051248
	2015.10-	Front Axle Left Upper	Coupe RWD 274910		Track Control Arm	S062802
	2015.10-	Front Axle Left Lower Inner	Coupe RWD 274910		Track Control Arm	S062805
	2015.10-	Front Axle Left Lower Outer	Coupe RWD 274910		Track Control Arm	S062844
	2015.10-	Front Axle Right Upper	Coupe RWD 274910		Track Control Arm	S062801
	2015.10-	Front Axle Right Lower Inner	Coupe RWD 274910		Track Control Arm	S062806
	2015.10-	Front Axle Right Lower Outer	Coupe RWD 274910		Track Control Arm	S062845
	2015.10-	Front Axle Left & Right Lower Inner	Coupe RWD 274910		Track Control Arm	S062842
	2015.10-	Rear Axle Left Upper Inner	Coupe RWD 274910		Track Control Arm	S063227
	2015.10-	Rear Axle Left Lower Outer	Coupe RWD 274910		Track Control Arm	S061566
	2015.10-	Rear Axle Left Upper Outer	Coupe RWD 274910		Track Control Arm	S062798
	2015.10-	Rear Axle Right Upper Inner	Coupe RWD 274910		Track Control Arm	S063228
	2015.10-	Rear Axle Right Lower Outer	Coupe RWD 274910		Track Control Arm	S061567
	2015.10-	Rear Axle Right Upper Outer	Coupe RWD 274910		Track Control Arm	S062797
	2015.10-	Rear Axle Left & Right Lower Inner	Coupe RWD 274910		Track Control Arm	S062799
	2015.10-	Front Axle Left & Right Upper	Coupe RWD 274910		Control Arm Bushing	510529
	2015.10-	Front Axle Left & Right Lower Inner	Coupe RWD 274910		Control Arm Bushing	533481
	2015.10-	Front Axle Left & Right Lower Inner	Coupe RWD 274910		Control Arm Bushing	533482
	2015.10-	Front Axle Left & Right Lower Inner	Coupe RWD 274910		Control Arm Bushing	535418
	2015.10-	Front Axle Left & Right Lower Outer	Coupe RWD 274910		Control Arm Bushing	535456



	 YEAR	FITTING POSITION	BODY STYLE & DRIVE TYPE & ENGINE	REMARKS	PRODUCT	GSP Ref.
MERCEDES-BENZ C180						
1.6 (115 kw)	2015.10-	Rear Axle Left & Right Upper	Coupe RWD 274910		Control Arm Bushing	532971
	2015.10-	Rear Axle Left & Right Upper Inner	Coupe RWD 274910		Control Arm Bushing	530504
	2015.10-	Rear Axle Left & Right Upper Inner	Coupe RWD 274910		Control Arm Bushing	533480
	2015.10-	Rear Axle Left & Right Lower Outer	Coupe RWD 274910		Control Arm Bushing	516552
	2015.10-	Front Axle Left & Right	Coupe RWD 274910		Tie Rod Axle Joint	S030926
	2015.10-	Front Axle Left	Coupe RWD 274910		Tie Rod End	S071616
	2015.10-	Front Axle Right	Coupe RWD 274910		Tie Rod End	S071617
	2015.10-	Front Axle Left	Coupe RWD 274910		Rod/Strut,stabiliser	S051250
	2015.10-	Front Axle Right	Coupe RWD 274910		Rod/Strut,stabiliser	S051249
	2015.10-	Rear Axle Left	Coupe RWD 274910		Rod/Strut,stabiliser	S051247
	2015.10-	Rear Axle Right	Coupe RWD 274910		Rod/Strut,stabiliser	S051248
1.8 (90 kw)	1993.06-2000.10	Front Axle Left Lower	Saloon RWD 111920/111921		Track Control Arm	S060575
	1993.06-2000.10	Front Axle Left Upper	Saloon RWD 111920/111921		Track Control Arm	S060214
	1993.06-2000.10	Front Axle Right Lower	Saloon RWD 111920/111921		Track Control Arm	S060576
	1993.06-2000.10	Front Axle Right Upper	Saloon RWD 111920/111921		Track Control Arm	S060215
	1993.06-2000.10	Rear Axle Left & Right Lower Inner	Saloon RWD 111920/111921		Track Control Arm	S060217
	1993.06-2000.10	Rear Axle Left & Right Upper Inner	Saloon RWD 111920/111921	Chassis no.from:A 599099,F 698668	Track Control Arm	S060216
	1993.06-2000.10	Rear Axle Left & Right Lower Outer	Saloon RWD 111920/111921		Track Control Arm	S051055
	1993.06-2000.10	Rear Axle Left & Right Upper Outer	Saloon RWD 111920/111921		Track Control Arm	S060218
	1993.06-2000.10	Front Axle Left & Right Lower	Saloon RWD 111920/111921		Ball Joint	S080143
	1993.06-2000.10	Front Axle Left & Right Lower	Saloon RWD 111920/111921		Control Arm Bushing	510468
	1993.06-2000.10	Front Axle Left & Right Lower	Saloon RWD 111920/111921		Control Arm Bushing	510517
	1993.06-2000.10	Front Axle Left & Right Lower	Saloon RWD 111920/111921		Control Arm Bushing	530232
	1993.06-2000.10	Front Axle Left & Right Upper	Saloon RWD 111920/111921		Control Arm Bushing	510456
	1993.06-2000.10	Rear Axle Left & Right Lower	Saloon RWD 111920/111921		Control Arm Bushing	511560
	1993.06-2000.10	Rear Axle Left & Right Upper Inner	Saloon RWD 111920/111921		Control Arm Bushing	517809
	1993.06-2000.10	Rear Axle Left & Right Lower Outer	Saloon RWD 111920/111921		Control Arm Bushing	510431
	1993.06-2000.10	Rear Axle Left & Right Lower Outer	Saloon RWD 111920/111921		Control Arm Bushing	512252
	1993.06-2000.10	Rear Axle Left & Right Upper Outer	Saloon RWD 111920/111921		Control Arm Bushing	510430
	1993.06-2000.10	Front Axle Left & Right Lower	Saloon RWD 111920/111921		Control Arm Bushing Kit	S10483S
	1993.06-2000.10	Rear Axle	Saloon RWD 111920/111921		Suspension Repair Kit	S990038SK
	1993.06-2000.10	Front Axle Left & Right	Saloon RWD 111920/111921		Rod Assembly	S100079
	1993.06-2000.10	Front Axle Left & Right	Saloon RWD 111920/111921		Tie Rod End	S070309
	1993.06-2000.10	Rear Axle Left & Right	Saloon RWD 111920/111921		Rod/Strut,stabiliser	S100063
	1993.06-2000.10	Front Axle Left & Right Inner	Saloon RWD 111920/111921		Stabiliser Bushing	512609
	1993.06-2000.10	Front Axle Left & Right Inner	Saloon RWD 111920/111921		Stabiliser Bushing	512613
	1993.06-2000.10	Front Axle Left & Right Outer	Saloon RWD 111920/111921		Stabiliser Bushing	511553
	1993.06-2000.10	Front Axle Left & Right Inner	Saloon RWD 111920/111921		Stabiliser Bushing Kit	531456S
	1993.06-2000.10	Front Axle	Saloon RWD 111920/111921		Stabiliser Bushing Kit	519452S
1.8 (105 kw)	2002.05-2007.02	Front Axle Left Lower Inner	Saloon RWD 271946		Track Control Arm	S060219
	2002.05-2007.02	Front Axle Left Lower Outer	Saloon RWD 271946		Track Control Arm	S060221
	2002.05-2007.02	Front Axle Right Lower Inner	Saloon RWD 271946		Track Control Arm	S060220
	2002.05-2007.02	Front Axle Right Lower Outer	Saloon RWD 271946		Track Control Arm	S060222
	2002.05-2007.02	Rear Axle Left & Right Lower Inner	Saloon RWD 271946		Track Control Arm	S060217
	2002.05-2007.02	Rear Axle Left & Right Upper Inner	Saloon RWD 271946		Track Control Arm	S060216
	2002.05-2007.02	Rear Axle Left & Right Upper Outer	Saloon RWD 271946		Track Control Arm	S060218
	2002.05-2007.02	Front Axle Left & Right Lower Inner	Saloon RWD 271946		Control Arm Bushing	510565
	2002.05-2007.02	Front Axle Left & Right Lower Outer	Saloon RWD 271946		Control Arm Bushing	510491
	2002.05-2007.02	Front Axle Left & Right Lower Outer	Saloon RWD 271946		Control Arm Bushing	531450
	2002.05-2007.02	Rear Axle Left & Right Lower	Saloon RWD 271946		Control Arm Bushing	511560
	2002.05-2007.02	Rear Axle Left & Right Upper Inner	Saloon RWD 271946		Control Arm Bushing	517809
	2002.05-2007.02	Rear Axle Left & Right Lower Outer	Saloon RWD 271946		Control Arm Bushing	512252
	2002.05-2007.02	Front Axle	Saloon RWD 271946	for vehicles without sports suspension	Suspension Repair Kit	S990006SK
	2002.05-2007.02	Front Axle	Saloon RWD 271946		Suspension Repair Kit	S990034SK
	2002.05-2007.02	Front Axle Left & Right	Saloon RWD 271946		Tie Rod Axle Joint	S030853
	2002.05-2007.02	Front Axle Left	Saloon RWD 271946		Tie Rod End	S070284
	2002.05-2007.02	Front Axle Right	Saloon RWD 271946		Tie Rod End	S070285
	2002.05-2007.02	Front Axle Left & Right	Saloon RWD 271946		Rod/Strut,stabiliser	S050273
	2002.05-2007.02	Front Axle Left & Right	Saloon RWD 271946	for vehicles with sports suspension	Rod/Strut,stabiliser	S050315
	2002.05-2007.02	Rear Axle Left	Saloon RWD 271946		Rod/Strut,stabiliser	S050302
	2002.05-2007.02	Rear Axle Right	Saloon RWD 271946		Rod/Strut,stabiliser	S050303
	2002.05-2007.02	Front Axle	Saloon RWD 271946		Stabiliser Bushing	512614
	2002.05-2007.02	Front Axle	Saloon RWD 271946		Stabiliser Bushing	512615
	2002.05-2007.02	Rear Axle	Saloon RWD 271946	Inner Diameter:15mm	Stabiliser Bushing	530969



	 YEAR	FITTING POSITION	BODY STYLE & DRIVE TYPE & ENGINE	REMARKS	PRODUCT	GSP Ref.	
MERCEDES-BENZ C180							
1.8 (105 kw)	2002.05-2007.02	Rear Axle	Saloon RWD 271946	VIN from A 556897 from E 617521 from F 467376 from R 131145	Stabiliser Bushing	530970	
	2002.05-2007.02	Rear Axle	Saloon RWD 271946		Stabiliser Bushing	530972	
	2002.05-2007.02	Front Axle	Saloon RWD 271946		Steering Boot	540343	
	2002.05-2007.02	Front Axle	Saloon RWD 271946	540343S and 541198S different structure	Steering Rack Bellow Kit	540343S	
1.8 (115 kw)	2007.01-2014.01	Front Axle Left Lower Inner	Saloon RWD 271820/271952		Track Control Arm	S060262	
	2007.01-2014.01	Front Axle Left Lower Outer	Saloon RWD 271820/271952		Track Control Arm	S060221	
	2007.01-2014.01	Front Axle Right Lower Inner	Saloon RWD 271820/271952		Track Control Arm	S060263	
	2007.01-2014.01	Front Axle Right Lower Outer	Saloon RWD 271820/271952		Track Control Arm	S060222	
	2007.01-2014.01	Rear Axle Left Upper Inner	Saloon RWD 271820/271952		Track Control Arm	S063227	
	2007.01-2014.01	Rear Axle Left Lower Outer	Saloon RWD 271820/271952		Track Control Arm	S061566	
	2007.01-2014.01	Rear Axle Left Upper Outer	Saloon RWD 271820/271952		Track Control Arm	S062798	
	2007.01-2014.01	Rear Axle Right Upper Inner	Saloon RWD 271820/271952		Track Control Arm	S063228	
	2007.01-2014.01	Rear Axle Right Lower Outer	Saloon RWD 271820/271952		Track Control Arm	S061567	
	2007.01-2014.01	Rear Axle Right Upper Outer	Saloon RWD 271820/271952		Track Control Arm	S062797	
	2007.01-2014.01	Rear Axle Left & Right Lower Inner	Saloon RWD 271820/271952		Track Control Arm	S062799	
	2007.01-2014.01	Front Axle Left & Right Lower Inner	Saloon RWD 271820/271952		Control Arm Bushing	517969	
	2007.01-2014.01	Front Axle Left & Right Lower Outer	Saloon RWD 271820/271952		Control Arm Bushing	510491	
	2007.01-2014.01	Front Axle Left & Right Lower Outer	Saloon RWD 271820/271952		Control Arm Bushing	531450	
	2007.01-2014.01	Rear Axle Left & Right Lower Inner	Saloon RWD 271820/271952		Control Arm Bushing	530527	
	2007.01-2014.01	Rear Axle Left & Right Upper Inner	Saloon RWD 271820/271952		Control Arm Bushing	533480	
	2007.01-2014.01	Rear Axle Left & Right Lower Outer	Saloon RWD 271820/271952		Control Arm Bushing	516552	
	2007.01-2014.01	Rear Axle Left & Right Lower Outer	Saloon RWD 271820/271952		Control Arm Bushing	516553	
	2007.01-2014.01	Rear Axle Left & Right Upper Outer	Saloon RWD 271820/271952		Control Arm Bushing	531454	
	2007.01-2014.01	Front Axle Left & Right	Saloon RWD 271820/271952		Tie Rod Axle Joint	S030171	
	2007.01-2014.01	Front Axle Left & Right	Saloon RWD 271820/271952	for vehicles with hydraulic power steering	Tie Rod Axle Joint	S030171	
	2007.01-2014.01	Front Axle Left & Right	Saloon RWD 271820/271952		Tie Rod Axle Joint	S030932	
	2007.01-2014.01	Front Axle Left	Saloon RWD 271820/271952		Tie Rod End	S070284	
	2007.01-2014.01	Front Axle Right	Saloon RWD 271820/271952		Tie Rod End	S070285	
	2007.01-2014.01	Front Axle Left	Saloon RWD 271820/271952	for vehicles without sports suspension	Rod/Strut, stabiliser	S050304	
	2007.01-2014.01	Front Axle Left	Saloon RWD 271820/271952		Rod/Strut, stabiliser	S051290	
	2007.01-2014.01	Front Axle Right	Saloon RWD 271820/271952	for vehicles without sports suspension	Rod/Strut, stabiliser	S050305	
	2007.01-2014.01	Front Axle Right	Saloon RWD 271820/271952	Equipment Vari. EXC. 4MATIC - SPORT	Rod/Strut, stabiliser	S051289	
	2007.01-2014.01	Rear Axle Left	Saloon RWD 271820/271952		Rod/Strut, stabiliser	S050306	
	2007.01-2014.01	Rear Axle Right	Saloon RWD 271820/271952		Rod/Strut, stabiliser	S050307	
	2.0 (95 kw)	2000.06-2002.05	Front Axle Left Lower Inner	Saloon RWD 111951		Track Control Arm	S060219
		2000.06-2002.05	Front Axle Left Lower Outer	Saloon RWD 111951		Track Control Arm	S060221
2000.06-2002.05		Front Axle Right Lower Inner	Saloon RWD 111951		Track Control Arm	S060220	
2000.06-2002.05		Front Axle Right Lower Outer	Saloon RWD 111951		Track Control Arm	S060222	
2000.06-2002.05		Rear Axle Left & Right Lower Inner	Saloon RWD 111951		Track Control Arm	S060217	
2000.06-2002.05		Rear Axle Left & Right Upper Inner	Saloon RWD 111951		Track Control Arm	S060216	
2000.06-2002.05		Rear Axle Left & Right Upper Outer	Saloon RWD 111951		Track Control Arm	S060218	
2000.06-2002.05		Front Axle Left & Right Lower Inner	Saloon RWD 111951		Control Arm Bushing	510565	
2000.06-2002.05		Front Axle Left & Right Lower Outer	Saloon RWD 111951		Control Arm Bushing	510491	
2000.06-2002.05		Front Axle Left & Right Lower Outer	Saloon RWD 111951		Control Arm Bushing	531450	
2000.06-2002.05		Rear Axle Left & Right Lower	Saloon RWD 111951		Control Arm Bushing	511560	
2000.06-2002.05		Rear Axle Left & Right Upper Inner	Saloon RWD 111951		Control Arm Bushing	517809	
2000.06-2002.05		Rear Axle Left & Right Lower Outer	Saloon RWD 111951		Control Arm Bushing	512252	
2000.06-2002.05		Front Axle	Saloon RWD 111951	for vehicles without sports suspension	Suspension Repair Kit	S990006SK	
2000.06-2002.05		Front Axle	Saloon RWD 111951		Suspension Repair Kit	S990034SK	
2000.06-2002.05		Front Axle Left & Right	Saloon RWD 111951		Tie Rod Axle Joint	S030853	
2000.06-2002.05		Front Axle Left	Saloon RWD 111951		Tie Rod End	S070284	
2000.06-2002.05		Front Axle Right	Saloon RWD 111951		Tie Rod End	S070285	
2000.06-2002.05		Front Axle Left & Right	Saloon RWD 111951		Rod/Strut, stabiliser	S050273	
2000.06-2002.05		Front Axle Left & Right	Saloon RWD 111951	for vehicles with sports suspension	Rod/Strut, stabiliser	S050315	
2000.06-2002.05		Rear Axle Left	Saloon RWD 111951		Rod/Strut, stabiliser	S050302	
2000.06-2002.05		Rear Axle Right	Saloon RWD 111951		Rod/Strut, stabiliser	S050303	
2000.06-2002.05		Front Axle	Saloon RWD 111951		Stabiliser Bushing	512614	
2000.06-2002.05		Front Axle	Saloon RWD 111951		Stabiliser Bushing	512615	
2000.06-2002.05		Rear Axle	Saloon RWD 111951		Stabiliser Bushing	530969	
2000.06-2002.05		Rear Axle	Saloon RWD 111951	VIN from A 556897 from E 617521 from F 467376 from R 131145	Stabiliser Bushing	530970	
2000.06-2002.05		Rear Axle	Saloon RWD 111951		Stabiliser Bushing	530972	
2000.06-2002.05		Front Axle	Saloon RWD 111951		Steering Boot	540343	
2000.06-2002.05		Front Axle	Saloon RWD 111951	540343S and 541198S different structure	Steering Rack Bellow Kit	540343S	



	 YEAR	FITTING POSITION	BODY STYLE & DRIVE TYPE & ENGINE	REMARKS	PRODUCT	GSP Ref.
MERCEDES-BENZ C200						
1.5 (135 kw)	2018.04-	Front Axle Left Upper	Saloon RWD 264915		Track Control Arm	S062802
	2018.04-	Front Axle Left Lower Inner	Saloon RWD 264915		Track Control Arm	S062805
	2018.04-	Front Axle Left Lower Outer	Saloon RWD 264915		Track Control Arm	S062844
	2018.04-	Front Axle Right Upper	Saloon RWD 264915		Track Control Arm	S062801
	2018.04-	Front Axle Right Lower Inner	Saloon RWD 264915		Track Control Arm	S062806
	2018.04-	Front Axle Right Lower Outer	Saloon RWD 264915		Track Control Arm	S062845
	2018.04-	Rear Axle Left Upper Inner	Saloon RWD 264915		Track Control Arm	S063227
	2018.04-	Rear Axle Left Lower Outer	Saloon RWD 264915		Track Control Arm	S061566
	2018.04-	Rear Axle Right Upper Inner	Saloon RWD 264915		Track Control Arm	S063228
	2018.04-	Rear Axle Right Lower Outer	Saloon RWD 264915		Track Control Arm	S061567
	2018.04-	Front Axle Left & Right Upper	Saloon RWD 264915		Control Arm Bushing	510529
	2018.04-	Front Axle Left & Right Lower Inner	Saloon RWD 264915		Control Arm Bushing	533481
	2018.04-	Front Axle Left & Right Lower Inner	Saloon RWD 264915		Control Arm Bushing	533482
	2018.04-	Front Axle Left & Right Lower Inner	Saloon RWD 264915		Control Arm Bushing	535418
	2018.04-	Front Axle Left & Right Lower Outer	Saloon RWD 264915		Control Arm Bushing	535456
	2018.04-	Rear Axle Left & Right Upper Inner	Saloon RWD 264915		Control Arm Bushing	530504
	2018.04-	Rear Axle Left & Right Upper Inner	Saloon RWD 264915		Control Arm Bushing	533480
	2018.04-	Rear Axle Left & Right Lower Outer	Saloon RWD 264915		Control Arm Bushing	516552
	2018.04-	Front Axle Left & Right	Saloon RWD 264915		Tie Rod Axle Joint	S030926
	2018.04-	Front Axle Left	Saloon RWD 264915		Tie Rod End	S071616
	2018.04-	Front Axle Right	Saloon RWD 264915		Tie Rod End	S071617
	2018.04-	Front Axle Left	Saloon RWD 264915		Rod/Strut, stabiliser	S051250
	2018.04-	Front Axle Right	Saloon RWD 264915		Rod/Strut, stabiliser	S051249
	2018.04-	Rear Axle Left	Saloon RWD 264915		Rod/Strut, stabiliser	S051247
2018.04-	Rear Axle Right	Saloon RWD 264915		Rod/Strut, stabiliser	S051248	
1.8 (120 kw)	2002.05-2007.11	Front Axle Left Lower Inner	Saloon RWD 271940		Track Control Arm	S060219
	2002.05-2007.11	Front Axle Left Lower Outer	Saloon RWD 271940		Track Control Arm	S060221
	2002.05-2007.11	Front Axle Right Lower Inner	Saloon RWD 271940		Track Control Arm	S060220
	2002.05-2007.11	Front Axle Right Lower Outer	Saloon RWD 271940		Track Control Arm	S060222
	2002.05-2007.11	Rear Axle Left & Right Lower Inner	Saloon RWD 271940		Track Control Arm	S060217
	2002.05-2007.11	Rear Axle Left & Right Upper Inner	Saloon RWD 271940		Track Control Arm	S060216
	2002.05-2007.11	Rear Axle Left & Right Upper Outer	Saloon RWD 271940		Track Control Arm	S060218
	2002.05-2007.11	Front Axle Left & Right Lower Inner	Saloon RWD 271940		Control Arm Bushing	510565
	2002.05-2007.11	Front Axle Left & Right Lower Outer	Saloon RWD 271940		Control Arm Bushing	510491
	2002.05-2007.11	Front Axle Left & Right Lower Outer	Saloon RWD 271940		Control Arm Bushing	531450
	2002.05-2007.11	Rear Axle Left & Right Lower	Saloon RWD 271940		Control Arm Bushing	511560
	2002.05-2007.11	Rear Axle Left & Right Upper Inner	Saloon RWD 271940		Control Arm Bushing	517809
	2002.05-2007.11	Rear Axle Left & Right Lower Outer	Saloon RWD 271940		Control Arm Bushing	512252
	2002.05-2007.11	Front Axle	Saloon RWD 271940	for vehicles without sports suspension	Suspension Repair Kit	S990006SK
	2002.05-2007.11	Front Axle	Saloon RWD 271940		Suspension Repair Kit	S990034SK
	2002.05-2007.11	Front Axle Left & Right	Saloon RWD 271940		Tie Rod Axle Joint	S030853
	2002.05-2007.11	Front Axle Left	Saloon RWD 271940		Tie Rod End	S070284
	2002.05-2007.11	Front Axle Right	Saloon RWD 271940		Tie Rod End	S070285
	2002.05-2007.11	Front Axle Left & Right	Saloon RWD 271940		Rod/Strut, stabiliser	S050273
	2002.05-2007.11	Front Axle Left & Right	Saloon RWD 271940	for vehicles with sports suspension	Rod/Strut, stabiliser	S050315
	2002.05-2007.11	Rear Axle Left	Saloon RWD 271940		Rod/Strut, stabiliser	S050302
	2002.05-2007.11	Rear Axle Right	Saloon RWD 271940		Rod/Strut, stabiliser	S050303
	2002.05-2007.11	Front Axle	Saloon RWD 271940		Stabiliser Bushing	512614
	2002.05-2007.11	Front Axle	Saloon RWD 271940		Stabiliser Bushing	512615
	2002.05-2007.11	Rear Axle	Saloon RWD 271940		Stabiliser Bushing	530969
	2002.05-2007.11	Rear Axle	Saloon RWD 271940	VIN from A 55889 from E 01571 from F 45735 from R 131145	Stabiliser Bushing	530970
	2002.05-2007.11	Rear Axle	Saloon RWD 271940	VIN A 80034 C 01036 05007 10267 for vehicles without sports suspension	Stabiliser Bushing	530972
	2002.05-2007.11	Front Axle	Saloon RWD 271940		Steering Boot	540343
	2002.05-2007.11	Front Axle	Saloon RWD 271940	540343S and 541198S different structure	Steering Rack Bellow Kit	540343S
	1.8 (135 kw)	2007.01-2014.01	Front Axle Left Lower Inner	Saloon RWD 271820/271860/271950		Track Control Arm
2007.01-2014.01		Front Axle Left Lower Inner	Saloon RWD 271820/271860/271950	Engine code:M 271.820	Track Control Arm	S060262
2007.01-2014.01		Front Axle Left Lower Outer	Saloon RWD 271820/271860/271950		Track Control Arm	S060221
2007.01-2014.01		Front Axle Left Lower Outer	Saloon RWD 271820/271860/271950	Engine code:M 271.820	Track Control Arm	S060221
2007.01-2014.01		Front Axle Right Lower Inner	Saloon RWD 271820/271860/271950		Track Control Arm	S060263
2007.01-2014.01		Front Axle Right Lower Inner	Saloon RWD 271820/271860/271950	Engine code:M 271.820	Track Control Arm	S060263
2007.01-2014.01		Front Axle Right Lower Outer	Saloon RWD 271820/271860/271950		Track Control Arm	S060222
2007.01-2014.01		Front Axle Right Lower Outer	Saloon RWD 271820/271860/271950	Engine code:M 271.820	Track Control Arm	S060222
2007.01-2014.01		Rear Axle Left Upper Inner	Saloon RWD 271820/271860/271950		Track Control Arm	S063227
2007.01-2014.01		Rear Axle Left Lower Outer	Saloon RWD 271820/271860/271950		Track Control Arm	S061566



	 YEAR	FITTING POSITION	BODY STYLE & DRIVE TYPE & ENGINE	REMARKS	PRODUCT	GSP Ref.
MERCEDES-BENZ C200						
1.8 (135 kw)	2007.01-2014.01	Rear Axle Left Upper Outer	Saloon RWD 271820/271860/271950		Track Control Arm	S062798
	2007.01-2014.01	Rear Axle Left Upper Outer	Saloon RWD 271820/271860/271950	Engine code:M 271.820	Track Control Arm	S062798
	2007.01-2014.01	Rear Axle Right Upper Inner	Saloon RWD 271820/271860/271950		Track Control Arm	S063228
	2007.01-2014.01	Rear Axle Right Lower Outer	Saloon RWD 271820/271860/271950		Track Control Arm	S061567
	2007.01-2014.01	Rear Axle Right Upper Outer	Saloon RWD 271820/271860/271950		Track Control Arm	S062797
	2007.01-2014.01	Rear Axle Right Upper Outer	Saloon RWD 271820/271860/271950	Engine code:M 271.820	Track Control Arm	S062797
	2007.01-2014.01	Rear Axle Left & Right Lower Inner	Saloon RWD 271820/271860/271950		Track Control Arm	S062799
	2007.01-2014.01	Rear Axle Left & Right Lower Inner	Saloon RWD 271820/271860/271950	Engine code:M 271.820	Track Control Arm	S062799
	2007.01-2014.01	Front Axle Left & Right Lower Inner	Saloon RWD 271820/271860/271950		Control Arm Bushing	517969
	2007.01-2014.01	Front Axle Left & Right Lower Outer	Saloon RWD 271820/271860/271950		Control Arm Bushing	510491
	2007.01-2014.01	Front Axle Left & Right Lower Outer	Saloon RWD 271820/271860/271950		Control Arm Bushing	531450
	2007.01-2014.01	Rear Axle Left & Right Lower Inner	Saloon RWD 271820/271860/271950		Control Arm Bushing	530527
	2007.01-2014.01	Rear Axle Left & Right Upper Inner	Saloon RWD 271820/271860/271950		Control Arm Bushing	533480
	2007.01-2014.01	Rear Axle Left & Right Lower Outer	Saloon RWD 271820/271860/271950		Control Arm Bushing	516552
	2007.01-2014.01	Rear Axle Left & Right Lower Outer	Saloon RWD 271820/271860/271950		Control Arm Bushing	516553
	2007.01-2014.01	Rear Axle Left & Right Upper Outer	Saloon RWD 271820/271860/271950		Control Arm Bushing	531454
	2007.01-2014.01	Front Axle Left & Right	Saloon RWD 271820/271860/271950		Tie Rod Axle Joint	S030171
	2007.01-2014.01	Front Axle Left & Right	Saloon RWD 271820/271860/271950	for vehicles with hydraulic power steering	Tie Rod Axle Joint	S030171
	2007.01-2014.01	Front Axle Left & Right	Saloon RWD 271820/271860/271950		Tie Rod Axle Joint	S030932
	2007.01-2014.01	Front Axle Left	Saloon RWD 271820/271860/271950		Tie Rod End	S070284
	2007.01-2014.01	Front Axle Right	Saloon RWD 271820/271860/271950		Tie Rod End	S070285
	2007.01-2014.01	Front Axle Left	Saloon RWD 271820/271860/271950	for vehicles without sports suspension	Rod/Strut, stabiliser	S050304
	2007.01-2014.01	Front Axle Left	Saloon RWD 271820/271860/271950	Engine code M 271.820 for vehicles without sports suspension	Rod/Strut, stabiliser	S050304
	2007.01-2014.01	Front Axle Left	Saloon RWD 271820/271860/271950		Rod/Strut, stabiliser	S051290
	2007.01-2014.01	Front Axle Right	Saloon RWD 271820/271860/271950	for vehicles without sports suspension	Rod/Strut, stabiliser	S050305
	2007.01-2014.01	Front Axle Right	Saloon RWD 271820/271860/271950	Engine code M 271.820 for vehicles without sports suspension	Rod/Strut, stabiliser	S050305
	2007.01-2014.01	Front Axle Right	Saloon RWD 271820/271860/271950	Equipment Vari...EXC.4MATIC - SPORT	Rod/Strut, stabiliser	S051289
	2007.01-2014.01	Rear Axle Left	Saloon RWD 271820/271860/271950		Rod/Strut, stabiliser	S050306
	2007.01-2014.01	Rear Axle Right	Saloon RWD 271820/271860/271950		Rod/Strut, stabiliser	S050307
	2007.08-2014.01	Front Axle Left Lower Inner	Estate RWD 271820/271860/271950		Track Control Arm	S060262
	2007.08-2014.01	Front Axle Left Lower Outer	Estate RWD 271820/271860/271950		Track Control Arm	S060221
	2007.08-2014.01	Front Axle Right Lower Inner	Estate RWD 271820/271860/271950		Track Control Arm	S060263
	2007.08-2014.01	Front Axle Right Lower Outer	Estate RWD 271820/271860/271950		Track Control Arm	S060222
	2007.08-2014.01	Rear Axle Left Upper Inner	Estate RWD 271820/271860/271950		Track Control Arm	S063227
	2007.08-2014.01	Rear Axle Left Lower Outer	Estate RWD 271820/271860/271950		Track Control Arm	S061566
	2007.08-2014.01	Rear Axle Left Upper Outer	Estate RWD 271820/271860/271950		Track Control Arm	S062798
	2007.08-2014.01	Rear Axle Right Upper Inner	Estate RWD 271820/271860/271950		Track Control Arm	S063228
	2007.08-2014.01	Rear Axle Right Lower Outer	Estate RWD 271820/271860/271950		Track Control Arm	S061567
	2007.08-2014.01	Rear Axle Right Upper Outer	Estate RWD 271820/271860/271950		Track Control Arm	S062797
	2007.08-2014.01	Rear Axle Left & Right Lower Inner	Estate RWD 271820/271860/271950		Track Control Arm	S062799
	2007.08-2014.01	Front Axle Left & Right Lower Inner	Estate RWD 271820/271860/271950		Control Arm Bushing	517969
	2007.08-2014.01	Front Axle Left & Right Lower Outer	Estate RWD 271820/271860/271950		Control Arm Bushing	510491
	2007.08-2014.01	Front Axle Left & Right Lower Outer	Estate RWD 271820/271860/271950		Control Arm Bushing	531450
	2007.08-2014.01	Rear Axle Left & Right Lower Inner	Estate RWD 271820/271860/271950		Control Arm Bushing	530527
	2007.08-2014.01	Rear Axle Left & Right Upper Inner	Estate RWD 271820/271860/271950		Control Arm Bushing	533480
	2007.08-2014.01	Rear Axle Left & Right Lower Outer	Estate RWD 271820/271860/271950		Control Arm Bushing	516552
	2007.08-2014.01	Rear Axle Left & Right Lower Outer	Estate RWD 271820/271860/271950		Control Arm Bushing	516553
	2007.08-2014.01	Rear Axle Left & Right Upper Outer	Estate RWD 271820/271860/271950		Control Arm Bushing	531454
	2007.08-2014.01	Front Axle Left & Right	Estate RWD 271820/271860/271950		Tie Rod Axle Joint	S030171
	2007.08-2014.01	Front Axle Left & Right	Estate RWD 271820/271860/271950	for vehicles with hydraulic power steering	Tie Rod Axle Joint	S030171
	2007.08-2014.01	Front Axle Left & Right	Estate RWD 271820/271860/271950		Tie Rod Axle Joint	S030932
	2007.08-2014.01	Front Axle Left	Estate RWD 271820/271860/271950		Tie Rod End	S070284
	2007.08-2014.01	Front Axle Right	Estate RWD 271820/271860/271950		Tie Rod End	S070285
	2007.08-2014.01	Front Axle Left	Estate RWD 271820/271860/271950	for vehicles without sports suspension	Rod/Strut, stabiliser	S050304
	2007.08-2014.01	Front Axle Left	Estate RWD 271820/271860/271950		Rod/Strut, stabiliser	S051290
	2007.08-2014.01	Front Axle Right	Estate RWD 271820/271860/271950	for vehicles without sports suspension	Rod/Strut, stabiliser	S050305
	2007.08-2014.01	Front Axle Right	Estate RWD 271820/271860/271950	Equipment Vari...EXC.4MATIC - SPORT	Rod/Strut, stabiliser	S051289
	2007.08-2014.01	Rear Axle Left	Estate RWD 271820/271860/271950		Rod/Strut, stabiliser	S050306
	2007.08-2014.01	Rear Axle Right	Estate RWD 271820/271860/271950		Rod/Strut, stabiliser	S050307
2.0 (100 kw)	1993.06-2000.05	Front Axle Left Lower	Saloon RWD 111941/111945		Track Control Arm	S060575
	1993.06-2000.05	Front Axle Left Upper	Saloon RWD 111941/111945		Track Control Arm	S060214
	1993.06-2000.05	Front Axle Right Lower	Saloon RWD 111941/111945		Track Control Arm	S060576
	1993.06-2000.05	Front Axle Right Upper	Saloon RWD 111941/111945		Track Control Arm	S060215
	1993.06-2000.05	Rear Axle Left & Right Lower Inner	Saloon RWD 111941/111945		Track Control Arm	S060217



	 YEAR	FITTING POSITION	BODY STYLE & DRIVE TYPE & ENGINE	REMARKS	PRODUCT	GSP Ref.
MERCEDES-BENZ C200						
2.0 (100 kw)						
	1993.06-2000.05	Rear Axle Left & Right Upper Inner	Saloon RWD 111941/111945	Chassis no.from:A 599099,F 698668	Track Control Arm	S060216
	1993.06-2000.05	Rear Axle Left & Right Lower Outer	Saloon RWD 111941/111945		Track Control Arm	S051055
	1993.06-2000.05	Rear Axle Left & Right Upper Outer	Saloon RWD 111941/111945		Track Control Arm	S060218
	1993.06-2000.05	Front Axle Left & Right Lower	Saloon RWD 111941/111945		Ball Joint	S080143
	1993.06-2000.05	Front Axle Left & Right Lower	Saloon RWD 111941/111945		Control Arm Bushing	510468
	1993.06-2000.05	Front Axle Left & Right Lower	Saloon RWD 111941/111945		Control Arm Bushing	510517
	1993.06-2000.05	Front Axle Left & Right Lower	Saloon RWD 111941/111945		Control Arm Bushing	530232
	1993.06-2000.05	Front Axle Left & Right Upper	Saloon RWD 111941/111945		Control Arm Bushing	510456
	1993.06-2000.05	Rear Axle Left & Right Lower	Saloon RWD 111941/111945		Control Arm Bushing	511560
	1993.06-2000.05	Rear Axle Left & Right Upper Inner	Saloon RWD 111941/111945		Control Arm Bushing	517809
	1993.06-2000.05	Rear Axle Left & Right Lower Outer	Saloon RWD 111941/111945		Control Arm Bushing	510431
	1993.06-2000.05	Rear Axle Left & Right Lower Outer	Saloon RWD 111941/111945		Control Arm Bushing	512252
	1993.06-2000.05	Rear Axle Left & Right Upper Outer	Saloon RWD 111941/111945		Control Arm Bushing	510430
	1993.06-2000.05	Front Axle Left & Right Lower	Saloon RWD 111941/111945		Control Arm Bushing Kit	510483S
	1993.06-2000.05	Rear Axle	Saloon RWD 111941/111945		Suspension Repair Kit	S990038SK
	1993.06-2000.05	Front Axle Left & Right	Saloon RWD 111941/111945		Rod Assembly	S100079
	1993.06-2000.05	Front Axle Left & Right	Saloon RWD 111941/111945		Tie Rod End	S070309
	1993.06-2000.05	Rear Axle Left & Right	Saloon RWD 111941/111945		Rod/Strut, stabiliser	S100063
	1993.06-2000.05	Front Axle Left & Right Inner	Saloon RWD 111941/111945		Stabiliser Bushing	512609
	1993.06-2000.05	Front Axle Left & Right Inner	Saloon RWD 111941/111945		Stabiliser Bushing	512613
	1993.06-2000.05	Front Axle Left & Right Outer	Saloon RWD 111941/111945		Stabiliser Bushing	511553
	1993.06-2000.05	Front Axle Left & Right Inner	Saloon RWD 111941/111945		Stabiliser Bushing Kit	531456S
	1993.06-2000.05	Front Axle	Saloon RWD 111941/111945		Stabiliser Bushing Kit	519452S
2.0 (135 kw)						
	2013.12-2018.08	Front Axle Left Upper	Saloon RWD 274920		Track Control Arm	S062802
	2013.12-2018.08	Front Axle Left Lower Inner	Saloon RWD 274920		Track Control Arm	S062805
	2013.12-2018.08	Front Axle Left Lower Outer	Saloon RWD 274920		Track Control Arm	S062844
	2013.12-2018.08	Front Axle Right Upper	Saloon RWD 274920		Track Control Arm	S062801
	2013.12-2018.08	Front Axle Right Lower Inner	Saloon RWD 274920		Track Control Arm	S062806
	2013.12-2018.08	Front Axle Right Lower Outer	Saloon RWD 274920		Track Control Arm	S062845
	2013.12-2018.08	Rear Axle Left Upper Inner	Saloon RWD 274920		Track Control Arm	S063227
	2013.12-2018.08	Rear Axle Left Lower Outer	Saloon RWD 274920		Track Control Arm	S061566
	2013.12-2018.08	Rear Axle Left Upper Outer	Saloon RWD 274920		Track Control Arm	S062798
	2013.12-2018.08	Rear Axle Right Upper Inner	Saloon RWD 274920		Track Control Arm	S063228
	2013.12-2018.08	Rear Axle Right Lower Outer	Saloon RWD 274920		Track Control Arm	S061567
	2013.12-2018.08	Rear Axle Right Upper Outer	Saloon RWD 274920		Track Control Arm	S062797
	2013.12-2018.08	Rear Axle Left & Right Lower Inner	Saloon RWD 274920		Track Control Arm	S062799
	2013.12-2018.08	Front Axle Left & Right Upper	Saloon RWD 274920		Control Arm Bushing	510529
	2013.12-2018.08	Front Axle Left & Right Lower Inner	Saloon RWD 274920		Control Arm Bushing	533481
	2013.12-2018.08	Front Axle Left & Right Lower Inner	Saloon RWD 274920		Control Arm Bushing	533482
	2013.12-2018.08	Front Axle Left & Right Lower Inner	Saloon RWD 274920		Control Arm Bushing	535418
	2013.12-2018.08	Front Axle Left & Right Lower Outer	Saloon RWD 274920		Control Arm Bushing	535456
	2013.12-2018.08	Rear Axle Left & Right Lower Inner	Saloon RWD 274920		Control Arm Bushing	530527
	2013.12-2018.08	Rear Axle Left & Right Upper Inner	Saloon RWD 274920		Control Arm Bushing	516563
	2013.12-2018.08	Rear Axle Left & Right Upper Inner	Saloon RWD 274920		Control Arm Bushing	530504
	2013.12-2018.08	Rear Axle Left & Right Upper Inner	Saloon RWD 274920		Control Arm Bushing	533480
	2013.12-2018.08	Rear Axle Left & Right Lower Outer	Saloon RWD 274920		Control Arm Bushing	516552
	2013.12-2018.08	Rear Axle Left & Right Lower Outer	Saloon RWD 274920		Control Arm Bushing	516553
	2013.12-2018.08	Front Axle Left & Right	Saloon RWD 274920		Tie Rod Axle Joint	S030926
	2013.12-2018.08	Front Axle Left	Saloon RWD 274920		Tie Rod End	S071616
	2013.12-2018.08	Front Axle Right	Saloon RWD 274920		Tie Rod End	S071617
	2013.12-2018.08	Front Axle Left	Saloon RWD 274920		Rod/Strut, stabiliser	S051250
	2013.12-2018.08	Front Axle Right	Saloon RWD 274920		Rod/Strut, stabiliser	S051249
	2013.12-2018.08	Rear Axle Left	Saloon RWD 274920		Rod/Strut, stabiliser	S051247
	2013.12-2018.08	Rear Axle Right	Saloon RWD 274920		Rod/Strut, stabiliser	S051248
C220						
2.2 (110 kw)						
	1993.06-2000.05	Front Axle Left Lower	Saloon RWD 111961		Track Control Arm	S060575
	1993.06-2000.05	Front Axle Left Upper	Saloon RWD 111961		Track Control Arm	S060214
	1993.06-2000.05	Front Axle Right Lower	Saloon RWD 111961		Track Control Arm	S060576
	1993.06-2000.05	Front Axle Right Upper	Saloon RWD 111961		Track Control Arm	S060215
	1993.06-2000.05	Rear Axle Left & Right Lower Inner	Saloon RWD 111961		Track Control Arm	S060217
	1993.06-2000.05	Rear Axle Left & Right Upper Inner	Saloon RWD 111961	Chassis no.from:A 599099,F 698668	Track Control Arm	S060216
	1993.06-2000.05	Rear Axle Left & Right Lower Outer	Saloon RWD 111961		Track Control Arm	S051055
	1993.06-2000.05	Rear Axle Left & Right Upper Outer	Saloon RWD 111961		Track Control Arm	S060218
	1993.06-2000.05	Front Axle Left & Right Lower	Saloon RWD 111961		Ball Joint	S080143



	 YEAR	FITTING POSITION	BODY STYLE & DRIVE TYPE & ENGINE	REMARKS	PRODUCT	GSP Ref.
MERCEDES-BENZ						
C220						
2.2 (110 kw)						
	1993.06-2000.05	Front Axle Left & Right Lower	Saloon RWD 111961		Control Arm Bushing	510468
	1993.06-2000.05	Front Axle Left & Right Lower	Saloon RWD 111961		Control Arm Bushing	510517
	1993.06-2000.05	Front Axle Left & Right Lower	Saloon RWD 111961		Control Arm Bushing	530232
	1993.06-2000.05	Front Axle Left & Right Upper	Saloon RWD 111961		Control Arm Bushing	510456
	1993.06-2000.05	Rear Axle Left & Right Lower	Saloon RWD 111961		Control Arm Bushing	511560
	1993.06-2000.05	Rear Axle Left & Right Upper Inner	Saloon RWD 111961		Control Arm Bushing	517809
	1993.06-2000.05	Rear Axle Left & Right Lower Outer	Saloon RWD 111961		Control Arm Bushing	510431
	1993.06-2000.05	Rear Axle Left & Right Lower Outer	Saloon RWD 111961		Control Arm Bushing	512252
	1993.06-2000.05	Rear Axle Left & Right Upper Outer	Saloon RWD 111961		Control Arm Bushing	510430
	1993.06-2000.05	Front Axle Left & Right Lower	Saloon RWD 111961		Control Arm Bushing Kit	510483S
	1993.06-2000.05	Rear Axle	Saloon RWD 111961		Suspension Repair Kit	S990038SK
	1993.06-2000.05	Front Axle Left & Right	Saloon RWD 111961		Rod Assembly	S100079
	1993.06-2000.05	Front Axle Left & Right	Saloon RWD 111961		Tie Rod End	S070309
	1993.06-2000.05	Rear Axle Left & Right	Saloon RWD 111961		Rod/Strut, stabiliser	S100063
	1993.06-2000.05	Front Axle Left & Right Inner	Saloon RWD 111961		Stabiliser Bushing	512609
	1993.06-2000.05	Front Axle Left & Right Inner	Saloon RWD 111961		Stabiliser Bushing	512613
	1993.06-2000.05	Front Axle Left & Right Outer	Saloon RWD 111961		Stabiliser Bushing	511553
	1993.06-2000.05	Front Axle Left & Right Inner	Saloon RWD 111961		Stabiliser Bushing Kit	531456S
	1993.06-2000.05	Front Axle	Saloon RWD 111961		Stabiliser Bushing Kit	519452S
C230						
1.8 (141 kw)						
	2003.11-2005.07	Front Axle Left Lower Inner	Estate RWD 271948		Track Control Arm	S060219
	2003.11-2005.07	Front Axle Left Lower Outer	Estate RWD 271948		Track Control Arm	S060221
	2003.11-2005.07	Front Axle Right Lower Inner	Estate RWD 271948		Track Control Arm	S060220
	2003.11-2005.07	Front Axle Right Lower Outer	Estate RWD 271948		Track Control Arm	S060222
	2003.11-2005.07	Rear Axle Left & Right Lower Inner	Estate RWD 271948		Track Control Arm	S060217
	2003.11-2005.07	Rear Axle Left & Right Upper Inner	Estate RWD 271948		Track Control Arm	S060216
	2003.11-2005.07	Front Axle Left & Right Lower Inner	Estate RWD 271948		Control Arm Bushing	510565
	2003.11-2005.07	Front Axle Left & Right Lower Outer	Estate RWD 271948		Control Arm Bushing	510491
	2003.11-2005.07	Front Axle Left & Right Lower Outer	Estate RWD 271948		Control Arm Bushing	531450
	2003.11-2005.07	Rear Axle Left & Right Lower	Estate RWD 271948		Control Arm Bushing	511560
	2003.11-2005.07	Rear Axle Left & Right Upper Inner	Estate RWD 271948		Control Arm Bushing	517809
	2003.11-2005.07	Rear Axle Left & Right Lower Outer	Estate RWD 271948		Control Arm Bushing	512252
	2003.11-2005.07	Front Axle	Estate RWD 271948	for vehicles without sports suspension	Suspension Repair Kit	S990006SK
	2003.11-2005.07	Front Axle	Estate RWD 271948		Suspension Repair Kit	S990034SK
	2003.11-2005.07	Front Axle Left & Right	Estate RWD 271948		Tie Rod Axle Joint	S030853
	2003.11-2005.07	Front Axle Left	Estate RWD 271948		Tie Rod End	S070284
	2003.11-2005.07	Front Axle Right	Estate RWD 271948		Tie Rod End	S070285
	2003.11-2005.07	Front Axle Left & Right	Estate RWD 271948		Rod/Strut, stabiliser	S050273
	2003.11-2005.07	Front Axle Left & Right	Estate RWD 271948	for vehicles with sports suspension	Rod/Strut, stabiliser	S050315
	2003.11-2005.07	Rear Axle Left	Estate RWD 271948		Rod/Strut, stabiliser	S050302
	2003.11-2005.07	Rear Axle Right	Estate RWD 271948		Rod/Strut, stabiliser	S050303
	2003.11-2005.07	Rear Axle	Estate RWD 271948	Inner Diameter:15mm	Stabiliser Bushing	530969
	2003.11-2005.07	Rear Axle	Estate RWD 271948	Inner Diameter:14.2mm	Stabiliser Bushing	530970
	2003.11-2005.07	Front Axle	Estate RWD 271948		Steering Boot	540343
	2003.11-2005.07	Front Axle	Estate RWD 271948	Date to:2005.07	Steering Rack Bellow Kit	540343S
	2004.02-2007.02	Front Axle Left Lower Inner	Saloon RWD 271948		Track Control Arm	S060219
	2004.02-2007.02	Front Axle Left Lower Outer	Saloon RWD 271948		Track Control Arm	S060221
	2004.02-2007.02	Front Axle Right Lower Inner	Saloon RWD 271948		Track Control Arm	S060220
	2004.02-2007.02	Front Axle Right Lower Outer	Saloon RWD 271948		Track Control Arm	S060222
	2004.02-2007.02	Rear Axle Left & Right Lower Inner	Saloon RWD 271948		Track Control Arm	S060217
	2004.02-2007.02	Rear Axle Left & Right Upper Inner	Saloon RWD 271948		Track Control Arm	S060216
	2004.02-2007.02	Rear Axle Left & Right Upper Outer	Saloon RWD 271948		Track Control Arm	S060218
	2004.02-2007.02	Front Axle Left & Right Lower Inner	Saloon RWD 271948		Control Arm Bushing	510565
	2004.02-2007.02	Front Axle Left & Right Lower Outer	Saloon RWD 271948		Control Arm Bushing	510491
	2004.02-2007.02	Front Axle Left & Right Lower Outer	Saloon RWD 271948		Control Arm Bushing	531450
	2004.02-2007.02	Rear Axle Left & Right Lower	Saloon RWD 271948		Control Arm Bushing	511560
	2004.02-2007.02	Rear Axle Left & Right Upper Inner	Saloon RWD 271948		Control Arm Bushing	517809
	2004.02-2007.02	Rear Axle Left & Right Lower Outer	Saloon RWD 271948		Control Arm Bushing	512252
	2004.02-2007.02	Front Axle	Saloon RWD 271948	for vehicles without sports suspension	Suspension Repair Kit	S990006SK
	2004.02-2007.02	Front Axle	Saloon RWD 271948		Suspension Repair Kit	S990034SK
	2004.02-2007.02	Front Axle Left & Right	Saloon RWD 271948		Tie Rod Axle Joint	S030853
	2004.02-2007.02	Front Axle Left	Saloon RWD 271948		Tie Rod End	S070284
	2004.02-2007.02	Front Axle Right	Saloon RWD 271948		Tie Rod End	S070285
	2004.02-2007.02	Front Axle Left & Right	Saloon RWD 271948		Rod/Strut, stabiliser	S050273



	 YEAR	FITTING POSITION	BODY STYLE & DRIVE TYPE & ENGINE	REMARKS	PRODUCT	GSP Ref.
MERCEDES-BENZ C230						
1.8 (141 kw)	2004.02-2007.02	Front Axle Left & Right	Saloon RWD 271948	for vehicles with sports suspension	Rod/Strut, stabiliser	S050315
	2004.02-2007.02	Rear Axle Left	Saloon RWD 271948		Rod/Strut, stabiliser	S050302
	2004.02-2007.02	Rear Axle Right	Saloon RWD 271948		Rod/Strut, stabiliser	S050303
	2004.02-2007.02	Front Axle	Saloon RWD 271948		Stabiliser Bushing	512614
	2004.02-2007.02	Front Axle	Saloon RWD 271948		Stabiliser Bushing	512615
	2004.02-2007.02	Rear Axle	Saloon RWD 271948		Stabiliser Bushing	530969
	2004.02-2007.02	Rear Axle	Saloon RWD 271948	VIN from A 555897 from E 617571 from F 457375 from R 131145	Stabiliser Bushing	530970
	2004.02-2007.02	Rear Axle	Saloon RWD 271948	VIN to A 555204 to 519366, 522097, 525265 for vehicles without sports suspension	Stabiliser Bushing	530972
	2004.02-2007.02	Front Axle	Saloon RWD 271948		Steering Boot	540343
	2004.02-2007.02	Front Axle	Saloon RWD 271948	540343S and 541198S different structure	Steering Rack Bellow Kit	540343S
2.3 (142 kw)	1995.09-2000.05	Front Axle Left Lower	Saloon RWD 111975		Track Control Arm	S060575
	1995.09-2000.05	Front Axle Left Upper	Saloon RWD 111975		Track Control Arm	S060214
	1995.09-2000.05	Front Axle Right Lower	Saloon RWD 111975		Track Control Arm	S060576
	1995.09-2000.05	Front Axle Right Upper	Saloon RWD 111975		Track Control Arm	S060215
	1995.09-2000.05	Rear Axle Left & Right Lower Inner	Saloon RWD 111975		Track Control Arm	S060217
	1995.09-2000.05	Rear Axle Left & Right Upper Inner	Saloon RWD 111975	Chassis no. from: A 599099, F 698668	Track Control Arm	S060216
	1995.09-2000.05	Rear Axle Left & Right Lower Outer	Saloon RWD 111975		Track Control Arm	S051055
	1995.09-2000.05	Rear Axle Left & Right Upper Outer	Saloon RWD 111975		Track Control Arm	S060218
	1995.09-2000.05	Front Axle Left & Right Lower	Saloon RWD 111975		Ball Joint	S080143
	1995.09-2000.05	Front Axle Left & Right Lower	Saloon RWD 111975		Control Arm Bushing	510468
	1995.09-2000.05	Front Axle Left & Right Lower	Saloon RWD 111975		Control Arm Bushing	510517
	1995.09-2000.05	Front Axle Left & Right Lower	Saloon RWD 111975		Control Arm Bushing	530232
	1995.09-2000.05	Front Axle Left & Right Upper	Saloon RWD 111975		Control Arm Bushing	510456
	1995.09-2000.05	Rear Axle Left & Right Lower	Saloon RWD 111975		Control Arm Bushing	511560
	1995.09-2000.05	Rear Axle Left & Right Upper Inner	Saloon RWD 111975		Control Arm Bushing	517809
	1995.09-2000.05	Rear Axle Left & Right Lower Outer	Saloon RWD 111975		Control Arm Bushing	510431
	1995.09-2000.05	Rear Axle Left & Right Lower Outer	Saloon RWD 111975		Control Arm Bushing	512252
	1995.09-2000.05	Rear Axle Left & Right Upper Outer	Saloon RWD 111975		Control Arm Bushing	510430
	1995.09-2000.05	Front Axle Left & Right Lower	Saloon RWD 111975		Control Arm Bushing Kit	510483S
	1995.09-2000.05	Rear Axle	Saloon RWD 111975		Suspension Repair Kit	S990038SK
	1995.09-2000.05	Front Axle Left & Right	Saloon RWD 111975		Rod Assembly	S100079
	1995.09-2000.05	Front Axle Left & Right	Saloon RWD 111975		Tie Rod End	S070309
	1995.09-2000.05	Rear Axle Left & Right	Saloon RWD 111975		Rod/Strut, stabiliser	S100063
	1995.09-2000.05	Front Axle Left & Right Outer	Saloon RWD 111975		Stabiliser Bushing	511553
	1995.09-2000.05	Rear Axle	Saloon RWD 111975		Stabiliser Bushing	517269
	1995.09-2000.05	Front Axle	Saloon RWD 111975		Stabiliser Bushing Kit	519452S
	1997.04-1999.10	Front Axle Left Lower	Estate RWD 111975		Track Control Arm	S060575
	1997.04-1999.10	Front Axle Left Upper	Estate RWD 111975		Track Control Arm	S060214
	1997.04-1999.10	Front Axle Right Lower	Estate RWD 111975		Track Control Arm	S060576
	1997.04-1999.10	Front Axle Right Upper	Estate RWD 111975		Track Control Arm	S060215
	1997.04-1999.10	Rear Axle Left & Right Lower Inner	Estate RWD 111975		Track Control Arm	S060217
	1997.04-1999.10	Rear Axle Left & Right Upper Inner	Estate RWD 111975	Chassis no. from: A 599099, F 698668	Track Control Arm	S060216
	1997.04-1999.10	Rear Axle Left & Right Lower Outer	Estate RWD 111975		Track Control Arm	S051055
	1997.04-1999.10	Rear Axle Left & Right Upper Outer	Estate RWD 111975		Track Control Arm	S060218
	1997.04-1999.10	Front Axle Left & Right Lower	Estate RWD 111975		Ball Joint	S080143
	1997.04-1999.10	Front Axle Left & Right Lower	Estate RWD 111975		Control Arm Bushing	510468
	1997.04-1999.10	Front Axle Left & Right Lower	Estate RWD 111975		Control Arm Bushing	510517
	1997.04-1999.10	Front Axle Left & Right Lower	Estate RWD 111975		Control Arm Bushing	530232
	1997.04-1999.10	Front Axle Left & Right Upper	Estate RWD 111975		Control Arm Bushing	510456
	1997.04-1999.10	Rear Axle Left & Right Lower	Estate RWD 111975		Control Arm Bushing	511560
	1997.04-1999.10	Rear Axle Left & Right Upper Inner	Estate RWD 111975		Control Arm Bushing	517809
	1997.04-1999.10	Rear Axle Left & Right Lower Outer	Estate RWD 111975		Control Arm Bushing	510431
	1997.04-1999.10	Rear Axle Left & Right Upper Outer	Estate RWD 111975		Control Arm Bushing	512252
	1997.04-1999.10	Rear Axle Left & Right Lower Outer	Estate RWD 111975		Control Arm Bushing	510430
	1997.04-1999.10	Front Axle Left & Right Lower	Estate RWD 111975		Control Arm Bushing Kit	510483S
	1997.04-1999.10	Rear Axle	Estate RWD 111975		Suspension Repair Kit	S990038SK
	1997.04-1999.10	Front Axle Left & Right	Estate RWD 111975		Rod Assembly	S100079
	1997.04-1999.10	Front Axle Left & Right	Estate RWD 111975		Tie Rod End	S070309
	1997.04-1999.10	Rear Axle Left & Right	Estate RWD 111975		Rod/Strut, stabiliser	S100063
	1997.04-1999.10	Front Axle Left & Right Outer	Estate RWD 111975		Stabiliser Bushing	511553
	1997.04-1999.10	Rear Axle	Estate RWD 111975		Stabiliser Bushing	517269
	1997.04-1999.10	Front Axle	Estate RWD 111975		Stabiliser Bushing Kit	519452S
2.3 (145 kw)	2001.03-2002.05	Front Axle Left Lower Inner	Coupe RWD 111981		Track Control Arm	S060219
	2001.03-2002.05	Front Axle Left Lower Outer	Coupe RWD 111981		Track Control Arm	S060221



	 YEAR	FITTING POSITION	BODY STYLE & DRIVE TYPE & ENGINE	REMARKS	PRODUCT	GSP Ref.
MERCEDES-BENZ C230						
2.3 (145 kw)						
	2001.03-2002.05	Front Axle Right Lower Inner	Coupe RWD 111981		Track Control Arm	S060220
	2001.03-2002.05	Front Axle Right Lower Outer	Coupe RWD 111981		Track Control Arm	S060222
	2001.03-2002.05	Rear Axle Left & Right Lower Inner	Coupe RWD 111981		Track Control Arm	S060217
	2001.03-2002.05	Rear Axle Left & Right Upper Inner	Coupe RWD 111981		Track Control Arm	S060216
	2001.03-2002.05	Front Axle Left & Right Lower Inner	Coupe RWD 111981		Control Arm Bushing	510565
	2001.03-2002.05	Front Axle Left & Right Lower Outer	Coupe RWD 111981		Control Arm Bushing	510491
	2001.03-2002.05	Front Axle Left & Right Lower Outer	Coupe RWD 111981		Control Arm Bushing	531450
	2001.03-2002.05	Rear Axle Left & Right Lower	Coupe RWD 111981		Control Arm Bushing	511560
	2001.03-2002.05	Rear Axle Left & Right Upper Inner	Coupe RWD 111981		Control Arm Bushing	517809
	2001.03-2002.05	Rear Axle Left & Right Lower Outer	Coupe RWD 111981		Control Arm Bushing	510446
	2001.03-2002.05	Rear Axle Left & Right Lower Outer	Coupe RWD 111981		Control Arm Bushing	512252
	2001.03-2002.05	Front Axle	Coupe RWD 111981		Suspension Repair Kit	S990006SK
	2001.03-2002.05	Front Axle Left & Right	Coupe RWD 111981		Tie Rod Axle Joint	S030853
	2001.03-2002.05	Front Axle Left	Coupe RWD 111981		Tie Rod End	S070284
	2001.03-2002.05	Front Axle Right	Coupe RWD 111981		Tie Rod End	S070285
	2001.03-2002.05	Front Axle Left & Right	Coupe RWD 111981	Chassis no. to:A 436251	Rod/Strut, stabiliser	S050273
	2001.03-2002.05	Front Axle Left & Right	Coupe RWD 111981	for vehicles with sports suspension	Rod/Strut, stabiliser	S050315
	2001.03-2002.05	Rear Axle Left	Coupe RWD 111981		Rod/Strut, stabiliser	S050302
	2001.03-2002.05	Rear Axle Right	Coupe RWD 111981		Rod/Strut, stabiliser	S050303
	2001.03-2002.05	Front Axle	Coupe RWD 111981		Stabiliser Bushing	512614
	2001.03-2002.05	Front Axle	Coupe RWD 111981		Stabiliser Bushing	512615
	2001.03-2002.05	Rear Axle	Coupe RWD 111981	for vehicles with sports suspension	Stabiliser Bushing	530969
	2001.03-2002.05	Rear Axle	Coupe RWD 111981	VIN to A 435022 for vehicles without sports suspension	Stabiliser Bushing	530972
	2001.03-2002.05	Front Axle	Coupe RWD 111981		Steering Boot	540343
	2001.03-2002.05	Front Axle	Coupe RWD 111981	540343S and 541198S different structure	Steering Rack Bellow Kit	540343S
2.5 (150 kw)						
	2005.03-2007.12	Front Axle Left Lower Inner	Saloon RWD 272920		Track Control Arm	S060219
	2005.03-2007.12	Front Axle Left Lower Outer	Saloon RWD 272920		Track Control Arm	S060221
	2005.03-2007.12	Front Axle Right Lower Inner	Saloon RWD 272920		Track Control Arm	S060220
	2005.03-2007.12	Front Axle Right Lower Outer	Saloon RWD 272920		Track Control Arm	S060222
	2005.03-2007.12	Rear Axle Left & Right Lower Inner	Saloon RWD 272920		Track Control Arm	S060217
	2005.03-2007.12	Rear Axle Left & Right Upper Inner	Saloon RWD 272920		Track Control Arm	S060216
	2005.03-2007.12	Rear Axle Left & Right Upper Outer	Saloon RWD 272920		Track Control Arm	S060218
	2005.03-2007.12	Front Axle Left & Right Lower Inner	Saloon RWD 272920		Control Arm Bushing	510565
	2005.03-2007.12	Front Axle Left & Right Lower Outer	Saloon RWD 272920		Control Arm Bushing	510491
	2005.03-2007.12	Front Axle Left & Right Lower Outer	Saloon RWD 272920		Control Arm Bushing	531450
	2005.03-2007.12	Rear Axle Left & Right Lower	Saloon RWD 272920		Control Arm Bushing	511560
	2005.03-2007.12	Rear Axle Left & Right Upper Inner	Saloon RWD 272920		Control Arm Bushing	517809
	2005.03-2007.12	Rear Axle Left & Right Lower Outer	Saloon RWD 272920		Control Arm Bushing	512252
	2005.03-2007.12	Front Axle	Saloon RWD 272920		Suspension Repair Kit	S990006SK
	2005.03-2007.12	Front Axle	Saloon RWD 272920		Suspension Repair Kit	S990034SK
	2005.03-2007.12	Front Axle Left & Right	Saloon RWD 272920		Tie Rod Axle Joint	S030853
	2005.03-2007.12	Front Axle Left	Saloon RWD 272920		Tie Rod End	S070284
	2005.03-2007.12	Front Axle Right	Saloon RWD 272920		Tie Rod End	S070285
	2005.03-2007.12	Front Axle Left & Right	Saloon RWD 272920		Rod/Strut, stabiliser	S050273
	2005.03-2007.12	Front Axle Left & Right	Saloon RWD 272920	for vehicles with sports suspension	Rod/Strut, stabiliser	S050315
	2005.03-2007.12	Rear Axle Left	Saloon RWD 272920		Rod/Strut, stabiliser	S050302
	2005.03-2007.12	Rear Axle Right	Saloon RWD 272920		Rod/Strut, stabiliser	S050303
	2005.03-2007.12	Front Axle	Saloon RWD 272920		Stabiliser Bushing	512614
	2005.03-2007.12	Front Axle	Saloon RWD 272920		Stabiliser Bushing	512615
	2005.03-2007.12	Rear Axle	Saloon RWD 272920		Stabiliser Bushing	530969
	2005.03-2007.12	Rear Axle	Saloon RWD 272920	VIN from A 555891 from E 01571 from F 457375 from R 131145	Stabiliser Bushing	530970
	2005.03-2007.12	Rear Axle	Saloon RWD 272920	VIN to A 555891 from E 01571 from F 457375 from R 131145	Stabiliser Bushing	530972
	2005.03-2007.12	Front Axle	Saloon RWD 272920		Steering Boot	540343
	2005.03-2007.12	Front Axle	Saloon RWD 272920	540343S and 541198S different structure	Steering Rack Bellow Kit	540343S
C240						
2.4 (125 kw)						
	1995.09-2000.05	Front Axle Left Lower	Saloon RWD 112910		Track Control Arm	S060575
	1995.09-2000.05	Front Axle Left Upper	Saloon RWD 112910		Track Control Arm	S060214
	1995.09-2000.05	Front Axle Right Lower	Saloon RWD 112910		Track Control Arm	S060576
	1995.09-2000.05	Front Axle Right Upper	Saloon RWD 112910		Track Control Arm	S060215
	1995.09-2000.05	Rear Axle Left & Right Lower Inner	Saloon RWD 112910		Track Control Arm	S060217
	1995.09-2000.05	Rear Axle Left & Right Upper Inner	Saloon RWD 112910	Chassis no. from: A 599099, F 698668	Track Control Arm	S060216
	1995.09-2000.05	Rear Axle Left & Right Lower Outer	Saloon RWD 112910		Track Control Arm	S051055
	1995.09-2000.05	Rear Axle Left & Right Upper Outer	Saloon RWD 112910		Track Control Arm	S060218
	1995.09-2000.05	Front Axle Left & Right Lower	Saloon RWD 112910		Ball Joint	S080143



	 YEAR	FITTING POSITION	BODY STYLE & DRIVE TYPE & ENGINE	REMARKS	PRODUCT	GSP Ref.
MERCEDES-BENZ C240						
2.4 (125 kw)						
	1995.09-2000.05	Front Axle Left & Right Lower	Saloon RWD 112910		Control Arm Bushing	510468
	1995.09-2000.05	Front Axle Left & Right Lower	Saloon RWD 112910		Control Arm Bushing	510517
	1995.09-2000.05	Front Axle Left & Right Lower	Saloon RWD 112910		Control Arm Bushing	530232
	1995.09-2000.05	Front Axle Left & Right Upper	Saloon RWD 112910		Control Arm Bushing	510456
	1995.09-2000.05	Rear Axle Left & Right Lower	Saloon RWD 112910		Control Arm Bushing	511560
	1995.09-2000.05	Rear Axle Left & Right Upper Inner	Saloon RWD 112910		Control Arm Bushing	517809
	1995.09-2000.05	Rear Axle Left & Right Lower Outer	Saloon RWD 112910		Control Arm Bushing	510431
	1995.09-2000.05	Rear Axle Left & Right Lower Outer	Saloon RWD 112910		Control Arm Bushing	512252
	1995.09-2000.05	Rear Axle Left & Right Upper Outer	Saloon RWD 112910		Control Arm Bushing	510430
	1995.09-2000.05	Front Axle Left & Right Lower	Saloon RWD 112910		Control Arm Bushing Kit	510483S
	1995.09-2000.05	Rear Axle	Saloon RWD 112910		Suspension Repair Kit	S990038SK
	1995.09-2000.05	Front Axle Left & Right	Saloon RWD 112910		Rod Assembly	S100183
	1995.09-2000.05	Front Axle Left & Right	Saloon RWD 112910		Tie Rod End	S070309
	1995.09-2000.05	Rear Axle Left & Right	Saloon RWD 112910		Rod/Strut, stabiliser	S100063
	1995.09-2000.05	Front Axle Left & Right	Saloon RWD 112910		Stabiliser Bushing	530744
	1995.09-2000.05	Front Axle Left & Right Outer	Saloon RWD 112910		Stabiliser Bushing	511553
	1995.09-2000.05	Rear Axle	Saloon RWD 112910		Stabiliser Bushing	517269
	1995.09-2000.05	Front Axle	Saloon RWD 112910		Stabiliser Bushing Kit	519452S
2.6 (125 kw)						
	2000.01-2005.07	Front Axle Left Lower Inner	Saloon RWD 112912		Track Control Arm	S060219
	2000.01-2005.07	Front Axle Left Lower Outer	Saloon RWD 112912		Track Control Arm	S060221
	2000.01-2005.07	Front Axle Right Lower Inner	Saloon RWD 112912		Track Control Arm	S060220
	2000.01-2005.07	Front Axle Right Lower Outer	Saloon RWD 112912		Track Control Arm	S060222
	2000.01-2005.07	Rear Axle Left & Right Lower Inner	Saloon RWD 112912		Track Control Arm	S060217
	2000.01-2005.07	Rear Axle Left & Right Upper Inner	Saloon RWD 112912		Track Control Arm	S060216
	2000.01-2005.07	Rear Axle Left & Right Upper Outer	Saloon RWD 112912		Track Control Arm	S060218
	2000.01-2005.07	Front Axle Left & Right Lower Inner	Saloon RWD 112912		Control Arm Bushing	510565
	2000.01-2005.07	Front Axle Left & Right Lower Outer	Saloon RWD 112912		Control Arm Bushing	510491
	2000.01-2005.07	Front Axle Left & Right Lower Outer	Saloon RWD 112912		Control Arm Bushing	531450
	2000.01-2005.07	Rear Axle Left & Right Lower	Saloon RWD 112912		Control Arm Bushing	511560
	2000.01-2005.07	Rear Axle Left & Right Upper Inner	Saloon RWD 112912		Control Arm Bushing	517809
	2000.01-2005.07	Rear Axle Left & Right Lower Outer	Saloon RWD 112912		Control Arm Bushing	512252
	2000.01-2005.07	Front Axle	Saloon RWD 112912	for vehicles without sports suspension	Suspension Repair Kit	S990006SK
	2000.01-2005.07	Front Axle	Saloon RWD 112912		Suspension Repair Kit	S990034SK
	2000.01-2005.07	Front Axle Left & Right	Saloon RWD 112912		Tie Rod Axle Joint	S030853
	2000.01-2005.07	Front Axle Left	Saloon RWD 112912		Tie Rod End	S070284
	2000.01-2005.07	Front Axle Right	Saloon RWD 112912		Tie Rod End	S070285
	2000.01-2005.07	Front Axle Left & Right	Saloon RWD 112912		Rod/Strut, stabiliser	S050273
	2000.01-2005.07	Front Axle Left & Right	Saloon RWD 112912	for vehicles with sports suspension	Rod/Strut, stabiliser	S050315
	2000.01-2005.07	Rear Axle Left	Saloon RWD 112912		Rod/Strut, stabiliser	S050302
	2000.01-2005.07	Rear Axle Right	Saloon RWD 112912		Rod/Strut, stabiliser	S050303
	2000.01-2005.07	Front Axle Left & Right	Saloon RWD 112912		Stabiliser Bushing	530744
	2000.01-2005.07	Front Axle	Saloon RWD 112912		Stabiliser Bushing	512614
	2000.01-2005.07	Front Axle	Saloon RWD 112912		Stabiliser Bushing	512615
	2000.01-2005.07	Rear Axle	Saloon RWD 112912	for vehicles with sports suspension	Stabiliser Bushing	530969
	2000.01-2005.07	Rear Axle	Saloon RWD 112912	VIN from A 55680 from E 01751 from F 457375 from R 131145	Stabiliser Bushing	530970
	2000.01-2005.07	Rear Axle	Saloon RWD 112912	VIN A 80024 6 01300100101 10000 for vehicles without sports suspension	Stabiliser Bushing	530972
	2000.01-2005.07	Front Axle	Saloon RWD 112912		Steering Boot	540343
	2000.01-2005.07	Front Axle	Saloon RWD 112912	Date to:2005.07	Steering Rack Bellow Kit	540343S
C250						
1.8 (150 kw)						
	2009.05-2014.01	Front Axle Left Lower Inner	Saloon RWD 271860		Track Control Arm	S060262
	2009.05-2014.01	Front Axle Left Lower Outer	Saloon RWD 271860		Track Control Arm	S060221
	2009.05-2014.01	Front Axle Right Lower Inner	Saloon RWD 271860		Track Control Arm	S060263
	2009.05-2014.01	Front Axle Right Lower Outer	Saloon RWD 271860		Track Control Arm	S060222
	2009.05-2014.01	Rear Axle Left Upper Inner	Saloon RWD 271860		Track Control Arm	S063227
	2009.05-2014.01	Rear Axle Left Lower Outer	Saloon RWD 271860		Track Control Arm	S061566
	2009.05-2014.01	Rear Axle Left Upper Outer	Saloon RWD 271860		Track Control Arm	S062798
	2009.05-2014.01	Rear Axle Right Upper Inner	Saloon RWD 271860		Track Control Arm	S063228
	2009.05-2014.01	Rear Axle Right Lower Outer	Saloon RWD 271860		Track Control Arm	S061567
	2009.05-2014.01	Rear Axle Right Upper Outer	Saloon RWD 271860		Track Control Arm	S062797
	2009.05-2014.01	Rear Axle Left & Right Lower Inner	Saloon RWD 271860		Track Control Arm	S062799
	2009.05-2014.01	Front Axle Left & Right Lower Inner	Saloon RWD 271860		Control Arm Bushing	517969
	2009.05-2014.01	Front Axle Left & Right Lower Outer	Saloon RWD 271860		Control Arm Bushing	510491
	2009.05-2014.01	Front Axle Left & Right Lower Outer	Saloon RWD 271860		Control Arm Bushing	531450
	2009.05-2014.01	Rear Axle Left & Right Lower Inner	Saloon RWD 271860		Control Arm Bushing	530527



	 YEAR	FITTING POSITION	BODY STYLE & DRIVE TYPE & ENGINE	REMARKS	PRODUCT	GSP Ref.
MERCEDES-BENZ C250						
1.8 (150 kw)	2009.05-2014.01	Rear Axle Left & Right Upper Inner	Saloon RWD 271860		Control Arm Bushing	533480
	2009.05-2014.01	Rear Axle Left & Right Lower Outer	Saloon RWD 271860		Control Arm Bushing	516552
	2009.05-2014.01	Rear Axle Left & Right Lower Outer	Saloon RWD 271860		Control Arm Bushing	516553
	2009.05-2014.01	Rear Axle Left & Right Upper Outer	Saloon RWD 271860		Control Arm Bushing	531454
	2009.05-2014.01	Front Axle Left & Right	Saloon RWD 271860	for vehicles with hydraulic power steering	Tie Rod Axle Joint	S030171
	2009.05-2014.01	Front Axle Left & Right	Saloon RWD 271860		Tie Rod Axle Joint	S030932
	2009.05-2014.01	Front Axle Left	Saloon RWD 271860		Tie Rod End	S070284
	2009.05-2014.01	Front Axle Right	Saloon RWD 271860		Tie Rod End	S070285
	2009.05-2014.01	Front Axle Left	Saloon RWD 271860	for vehicles without sports suspension	Rod/Strut, stabiliser	S050304
	2009.05-2014.01	Front Axle Left	Saloon RWD 271860		Rod/Strut, stabiliser	S051290
	2009.05-2014.01	Front Axle Right	Saloon RWD 271860	for vehicles without sports suspension	Rod/Strut, stabiliser	S050305
	2009.05-2014.01	Front Axle Right	Saloon RWD 271860	Equipment Vari. EXC. 4MATIC - SPORT	Rod/Strut, stabiliser	S051289
	2009.05-2014.01	Rear Axle Left	Saloon RWD 271860		Rod/Strut, stabiliser	S050306
	2009.05-2014.01	Rear Axle Right	Saloon RWD 271860		Rod/Strut, stabiliser	S050307
	2011.03-2014.01	Front Axle Left Lower Inner	Coupe RWD 271860		Track Control Arm	S060262
	2011.03-2014.01	Front Axle Left Lower Outer	Coupe RWD 271860		Track Control Arm	S060221
	2011.03-2014.01	Front Axle Right Lower Inner	Coupe RWD 271860		Track Control Arm	S060263
	2011.03-2014.01	Front Axle Right Lower Outer	Coupe RWD 271860		Track Control Arm	S060222
	2011.03-2014.01	Rear Axle Left Upper Inner	Coupe RWD 271860		Track Control Arm	S063227
	2011.03-2014.01	Rear Axle Left Lower Outer	Coupe RWD 271860		Track Control Arm	S061566
	2011.03-2014.01	Rear Axle Left Upper Outer	Coupe RWD 271860		Track Control Arm	S062798
	2011.03-2014.01	Rear Axle Right Upper Inner	Coupe RWD 271860		Track Control Arm	S063228
	2011.03-2014.01	Rear Axle Right Lower Outer	Coupe RWD 271860		Track Control Arm	S061567
	2011.03-2014.01	Rear Axle Right Upper Outer	Coupe RWD 271860		Track Control Arm	S062797
	2011.03-2014.01	Rear Axle Left & Right Lower Inner	Coupe RWD 271860		Track Control Arm	S062799
	2011.03-2014.01	Front Axle Left & Right Lower Inner	Coupe RWD 271860		Control Arm Bushing	517969
	2011.03-2014.01	Front Axle Left & Right Lower Inner	Coupe RWD 271860		Control Arm Bushing	518120
	2011.03-2014.01	Front Axle Left & Right Lower Outer	Coupe RWD 271860		Control Arm Bushing	510491
	2011.03-2014.01	Front Axle Left & Right Lower Outer	Coupe RWD 271860		Control Arm Bushing	531450
	2011.03-2014.01	Rear Axle Left & Right Upper	Coupe RWD 271860		Control Arm Bushing	532971
	2011.03-2014.01	Rear Axle Left & Right Lower Inner	Coupe RWD 271860		Control Arm Bushing	530527
	2011.03-2014.01	Rear Axle Left & Right Upper Inner	Coupe RWD 271860		Control Arm Bushing	516563
	2011.03-2014.01	Rear Axle Left & Right Upper Inner	Coupe RWD 271860		Control Arm Bushing	533480
	2011.03-2014.01	Rear Axle Left & Right Lower Outer	Coupe RWD 271860		Control Arm Bushing	516552
	2011.03-2014.01	Rear Axle Left & Right Lower Outer	Coupe RWD 271860		Control Arm Bushing	516553
	2011.03-2014.01	Rear Axle Left & Right Upper Outer	Coupe RWD 271860		Control Arm Bushing	531454
	2011.03-2014.01	Front Axle Left & Right	Coupe RWD 271860	for vehicles with hydraulic power steering	Tie Rod Axle Joint	S030171
	2011.03-2014.01	Front Axle Left & Right	Coupe RWD 271860		Tie Rod Axle Joint	S030932
	2011.03-2014.01	Front Axle Left	Coupe RWD 271860		Tie Rod End	S070284
	2011.03-2014.01	Front Axle Right	Coupe RWD 271860		Tie Rod End	S070285
	2011.03-2014.01	Front Axle Left	Coupe RWD 271860	for vehicles without sports suspension	Rod/Strut, stabiliser	S050304
	2011.03-2014.01	Front Axle Left	Coupe RWD 271860		Rod/Strut, stabiliser	S051290
	2011.03-2014.01	Front Axle Right	Coupe RWD 271860	for vehicles without sports suspension	Rod/Strut, stabiliser	S050305
	2011.03-2014.01	Front Axle Right	Coupe RWD 271860	for vehicles with sports suspension	Rod/Strut, stabiliser	S051289
	2011.03-2014.01	Rear Axle Left	Coupe RWD 271860		Rod/Strut, stabiliser	S050306
	2011.03-2014.01	Rear Axle Right	Coupe RWD 271860		Rod/Strut, stabiliser	S050307
2.0 (155 kw)	2014.03-2018.05	Front Axle Left Upper	Saloon RWD 274920		Track Control Arm	S062802
	2014.03-2018.05	Front Axle Left Lower Inner	Saloon RWD 274920		Track Control Arm	S062805
	2014.03-2018.05	Front Axle Left Lower Outer	Saloon RWD 274920		Track Control Arm	S062844
	2014.03-2018.05	Front Axle Right Upper	Saloon RWD 274920		Track Control Arm	S062801
	2014.03-2018.05	Front Axle Right Lower Inner	Saloon RWD 274920		Track Control Arm	S062806
	2014.03-2018.05	Front Axle Right Lower Outer	Saloon RWD 274920		Track Control Arm	S062845
	2014.03-2018.05	Rear Axle Left Upper Inner	Saloon RWD 274920		Track Control Arm	S063227
	2014.03-2018.05	Rear Axle Left Lower Outer	Saloon RWD 274920		Track Control Arm	S061566
	2014.03-2018.05	Rear Axle Left Upper Outer	Saloon RWD 274920		Track Control Arm	S062798
	2014.03-2018.05	Rear Axle Right Upper Inner	Saloon RWD 274920		Track Control Arm	S063228
	2014.03-2018.05	Rear Axle Right Lower Outer	Saloon RWD 274920		Track Control Arm	S061567
	2014.03-2018.05	Rear Axle Right Upper Outer	Saloon RWD 274920		Track Control Arm	S062797
	2014.03-2018.05	Rear Axle Left & Right Lower Inner	Saloon RWD 274920		Track Control Arm	S062799
	2014.03-2018.05	Front Axle Left & Right Upper	Saloon RWD 274920		Control Arm Bushing	510529
	2014.03-2018.05	Front Axle Left & Right Lower Inner	Saloon RWD 274920		Control Arm Bushing	533481
	2014.03-2018.05	Front Axle Left & Right Lower Inner	Saloon RWD 274920		Control Arm Bushing	533482
	2014.03-2018.05	Front Axle Left & Right Lower Inner	Saloon RWD 274920		Control Arm Bushing	535418
	2014.03-2018.05	Front Axle Left & Right Lower Outer	Saloon RWD 274920		Control Arm Bushing	535456



	 YEAR	FITTING POSITION	BODY STYLE & DRIVE TYPE & ENGINE	REMARKS	PRODUCT	GSP Ref.
MERCEDES-BENZ C250						
2.0 (155 kw)						
	2014.03-2018.05	Rear Axle Left & Right Lower Inner	Saloon RWD 274920		Control Arm Bushing	530527
	2014.03-2018.05	Rear Axle Left & Right Upper Inner	Saloon RWD 274920		Control Arm Bushing	516563
	2014.03-2018.05	Rear Axle Left & Right Upper Inner	Saloon RWD 274920		Control Arm Bushing	530504
	2014.03-2018.05	Rear Axle Left & Right Upper Inner	Saloon RWD 274920		Control Arm Bushing	533480
	2014.03-2018.05	Rear Axle Left & Right Lower Outer	Saloon RWD 274920		Control Arm Bushing	516552
	2014.03-2018.05	Rear Axle Left & Right Lower Outer	Saloon RWD 274920		Control Arm Bushing	516553
	2014.03-2018.05	Front Axle Left & Right	Saloon RWD 274920		Tie Rod Axle Joint	S030926
	2014.03-2018.05	Front Axle Left	Saloon RWD 274920		Tie Rod End	S071616
	2014.03-2018.05	Front Axle Right	Saloon RWD 274920		Tie Rod End	S071617
	2014.03-2018.05	Front Axle Left	Saloon RWD 274920		Rod/Strut, stabiliser	S051250
	2014.03-2018.05	Front Axle Right	Saloon RWD 274920		Rod/Strut, stabiliser	S051249
	2014.03-2018.05	Rear Axle Left	Saloon RWD 274920		Rod/Strut, stabiliser	S051247
	2014.03-2018.05	Rear Axle Right	Saloon RWD 274920		Rod/Strut, stabiliser	S051248
C280						
2.8 (142 kw)						
	1993.06-2000.05	Front Axle Left Lower	Saloon RWD 104941		Track Control Arm	S060575
	1993.06-2000.05	Front Axle Left Upper	Saloon RWD 104941		Track Control Arm	S060214
	1993.06-2000.05	Front Axle Right Lower	Saloon RWD 104941		Track Control Arm	S060576
	1993.06-2000.05	Front Axle Right Upper	Saloon RWD 104941		Track Control Arm	S060215
	1993.06-2000.05	Rear Axle Left & Right Lower Inner	Saloon RWD 104941		Track Control Arm	S060217
	1993.06-2000.05	Rear Axle Left & Right Upper Inner	Saloon RWD 104941	Chassis no. from: A 599099, F 698668	Track Control Arm	S060216
	1993.06-2000.05	Rear Axle Left & Right Lower Outer	Saloon RWD 104941		Track Control Arm	S051055
	1993.06-2000.05	Rear Axle Left & Right Upper Outer	Saloon RWD 104941		Track Control Arm	S060218
	1993.06-2000.05	Front Axle Left & Right Lower	Saloon RWD 104941		Ball Joint	S080143
	1993.06-2000.05	Front Axle Left & Right Lower	Saloon RWD 104941		Control Arm Bushing	510468
	1993.06-2000.05	Front Axle Left & Right Lower	Saloon RWD 104941		Control Arm Bushing	510517
	1993.06-2000.05	Front Axle Left & Right Lower	Saloon RWD 104941		Control Arm Bushing	530232
	1993.06-2000.05	Front Axle Left & Right Upper	Saloon RWD 104941		Control Arm Bushing	510456
	1993.06-2000.05	Rear Axle Left & Right Lower	Saloon RWD 104941		Control Arm Bushing	511560
	1993.06-2000.05	Rear Axle Left & Right Upper Inner	Saloon RWD 104941		Control Arm Bushing	517809
	1993.06-2000.05	Rear Axle Left & Right Lower Outer	Saloon RWD 104941		Control Arm Bushing	510431
	1993.06-2000.05	Rear Axle Left & Right Lower Outer	Saloon RWD 104941		Control Arm Bushing	512252
	1993.06-2000.05	Rear Axle Left & Right Upper Outer	Saloon RWD 104941		Control Arm Bushing	510430
	1993.06-2000.05	Front Axle Left & Right Lower	Saloon RWD 104941		Control Arm Bushing Kit	510483S
	1993.06-2000.05	Rear Axle	Saloon RWD 104941		Suspension Repair Kit	S990038SK
	1993.06-2000.05	Front Axle Left & Right	Saloon RWD 104941		Rod Assembly	S100079
	1993.06-2000.05	Front Axle Left & Right	Saloon RWD 104941		Rod Assembly	S100183
	1993.06-2000.05	Front Axle Left & Right	Saloon RWD 104941		Tie Rod End	S070309
	1993.06-2000.05	Rear Axle Left & Right	Saloon RWD 104941		Rod/Strut, stabiliser	S100063
	1993.06-2000.05	Front Axle Left & Right Outer	Saloon RWD 104941		Stabiliser Bushing	511553
	1993.06-2000.05	Rear Axle	Saloon RWD 104941		Stabiliser Bushing	517269
	1993.06-2000.05	Front Axle	Saloon RWD 104941		Stabiliser Bushing Kit	519452S
2.8 (145 kw)						
	1997.06-2000.05	Front Axle Left Lower	Saloon RWD 112920		Track Control Arm	S060575
	1997.06-2000.05	Front Axle Left Upper	Saloon RWD 112920		Track Control Arm	S060214
	1997.06-2000.05	Front Axle Right Lower	Saloon RWD 112920		Track Control Arm	S060576
	1997.06-2000.05	Front Axle Right Upper	Saloon RWD 112920		Track Control Arm	S060215
	1997.06-2000.05	Rear Axle Left & Right Lower Inner	Saloon RWD 112920		Track Control Arm	S060217
	1997.06-2000.05	Rear Axle Left & Right Upper Inner	Saloon RWD 112920	Chassis no. from: A 599099, F 698668	Track Control Arm	S060216
	1997.06-2000.05	Rear Axle Left & Right Lower Outer	Saloon RWD 112920		Track Control Arm	S051055
	1997.06-2000.05	Rear Axle Left & Right Upper Outer	Saloon RWD 112920		Track Control Arm	S060218
	1997.06-2000.05	Front Axle Left & Right Lower	Saloon RWD 112920		Ball Joint	S080143
	1997.06-2000.05	Front Axle Left & Right Lower	Saloon RWD 112920		Control Arm Bushing	510468
	1997.06-2000.05	Front Axle Left & Right Lower	Saloon RWD 112920		Control Arm Bushing	510517
	1997.06-2000.05	Front Axle Left & Right Lower	Saloon RWD 112920		Control Arm Bushing	530232
	1997.06-2000.05	Front Axle Left & Right Upper	Saloon RWD 112920		Control Arm Bushing	510456
	1997.06-2000.05	Rear Axle Left & Right Lower	Saloon RWD 112920		Control Arm Bushing	511560
	1997.06-2000.05	Rear Axle Left & Right Upper Inner	Saloon RWD 112920		Control Arm Bushing	517809
	1997.06-2000.05	Rear Axle Left & Right Lower Outer	Saloon RWD 112920		Control Arm Bushing	510431
	1997.06-2000.05	Rear Axle Left & Right Lower Outer	Saloon RWD 112920		Control Arm Bushing	512252
	1997.06-2000.05	Rear Axle Left & Right Upper Outer	Saloon RWD 112920		Control Arm Bushing	510430
	1997.06-2000.05	Front Axle Left & Right Lower	Saloon RWD 112920		Control Arm Bushing Kit	510483S
	1997.06-2000.05	Rear Axle	Saloon RWD 112920		Suspension Repair Kit	S990038SK
	1997.06-2000.05	Front Axle Left & Right	Saloon RWD 112920		Rod Assembly	S100183
	1997.06-2000.05	Front Axle Left & Right	Saloon RWD 112920		Tie Rod End	S070309
	1997.06-2000.05	Rear Axle Left & Right	Saloon RWD 112920		Rod/Strut, stabiliser	S100063

	 YEAR	FITTING POSITION	BODY STYLE & DRIVE TYPE & ENGINE	REMARKS	PRODUCT	GSP Ref.
MERCEDES-BENZ C280						
2.8 (145 kw)	1997.06-2000.05	Front Axle Left & Right	Saloon RWD 112920		Stabiliser Bushing	530744
	1997.06-2000.05	Front Axle Left & Right Outer	Saloon RWD 112920		Stabiliser Bushing	511553
	1997.06-2000.05	Rear Axle	Saloon RWD 112920		Stabiliser Bushing	517269
	1997.06-2000.05	Front Axle	Saloon RWD 112920		Stabiliser Bushing Kit	519452S
3.0 (170 kw)	2007.02-2014.01	Front Axle Left Lower Inner	Saloon RWD 272947		Track Control Arm	S060262
	2007.02-2014.01	Front Axle Left Lower Outer	Saloon RWD 272947		Track Control Arm	S060221
	2007.02-2014.01	Front Axle Right Lower Inner	Saloon RWD 272947		Track Control Arm	S060263
	2007.02-2014.01	Front Axle Right Lower Outer	Saloon RWD 272947		Track Control Arm	S060222
	2007.02-2014.01	Rear Axle Left Upper Inner	Saloon RWD 272947		Track Control Arm	S063227
	2007.02-2014.01	Rear Axle Left Lower Outer	Saloon RWD 272947		Track Control Arm	S061566
	2007.02-2014.01	Rear Axle Left Upper Outer	Saloon RWD 272947		Track Control Arm	S062798
	2007.02-2014.01	Rear Axle Right Upper Inner	Saloon RWD 272947		Track Control Arm	S063228
	2007.02-2014.01	Rear Axle Right Lower Outer	Saloon RWD 272947		Track Control Arm	S061567
	2007.02-2014.01	Rear Axle Right Upper Outer	Saloon RWD 272947		Track Control Arm	S062797
	2007.02-2014.01	Rear Axle Left & Right Lower Inner	Saloon RWD 272947		Track Control Arm	S062799
	2007.02-2014.01	Front Axle Left & Right Lower Inner	Saloon RWD 272947		Control Arm Bushing	517969
	2007.02-2014.01	Front Axle Left & Right Lower Outer	Saloon RWD 272947		Control Arm Bushing	510491
	2007.02-2014.01	Front Axle Left & Right Lower Outer	Saloon RWD 272947		Control Arm Bushing	531450
	2007.02-2014.01	Rear Axle Left & Right Lower Inner	Saloon RWD 272947		Control Arm Bushing	530527
	2007.02-2014.01	Rear Axle Left & Right Upper Inner	Saloon RWD 272947		Control Arm Bushing	530504
	2007.02-2014.01	Rear Axle Left & Right Upper Inner	Saloon RWD 272947		Control Arm Bushing	533480
	2007.02-2014.01	Rear Axle Left & Right Lower Outer	Saloon RWD 272947		Control Arm Bushing	516552
	2007.02-2014.01	Rear Axle Left & Right Lower Outer	Saloon RWD 272947		Control Arm Bushing	516553
	2007.02-2014.01	Rear Axle Left & Right Upper Outer	Saloon RWD 272947		Control Arm Bushing	531454
	2007.02-2014.01	Front Axle Left & Right	Saloon RWD 272947		Tie Rod Axle Joint	S030171
	2007.02-2014.01	Front Axle Left & Right	Saloon RWD 272947		Tie Rod Axle Joint	S030932
	2007.02-2014.01	Front Axle Left	Saloon RWD 272947		Tie Rod End	S070284
	2007.02-2014.01	Front Axle Right	Saloon RWD 272947		Tie Rod End	S070285
	2007.02-2014.01	Front Axle Left	Saloon RWD 272947	for vehicles without sports suspension	Rod/Strut, stabiliser	S050304
	2007.02-2014.01	Front Axle Left	Saloon RWD 272947		Rod/Strut, stabiliser	S051290
	2007.02-2014.01	Front Axle Right	Saloon RWD 272947	for vehicles without sports suspension	Rod/Strut, stabiliser	S050305
	2007.02-2014.01	Front Axle Right	Saloon RWD 272947	Equipment Vari.:EXC.4MATIC - SPORT	Rod/Strut, stabiliser	S051289
	2007.02-2014.01	Rear Axle Left	Saloon RWD 272947		Rod/Strut, stabiliser	S050306
	2007.02-2014.01	Rear Axle Right	Saloon RWD 272947		Rod/Strut, stabiliser	S050307
C300						
2.0 (180 kw)	2015.01-2018.08	Front Axle Left Upper	Saloon RWD 274920		Track Control Arm	S062802
	2015.01-2018.08	Front Axle Left Lower Inner	Saloon RWD 274920		Track Control Arm	S062805
	2015.01-2018.08	Front Axle Left Lower Outer	Saloon RWD 274920		Track Control Arm	S062844
	2015.01-2018.08	Front Axle Right Upper	Saloon RWD 274920		Track Control Arm	S062801
	2015.01-2018.08	Front Axle Right Lower Inner	Saloon RWD 274920		Track Control Arm	S062806
	2015.01-2018.08	Front Axle Right Lower Outer	Saloon RWD 274920		Track Control Arm	S062845
	2015.01-2018.08	Rear Axle Left Upper Inner	Saloon RWD 274920		Track Control Arm	S063227
	2015.01-2018.08	Rear Axle Left Lower Outer	Saloon RWD 274920		Track Control Arm	S061566
	2015.01-2018.08	Rear Axle Left Upper Outer	Saloon RWD 274920		Track Control Arm	S062798
	2015.01-2018.08	Rear Axle Right Upper Inner	Saloon RWD 274920		Track Control Arm	S063228
	2015.01-2018.08	Rear Axle Right Lower Outer	Saloon RWD 274920		Track Control Arm	S061567
	2015.01-2018.08	Rear Axle Right Upper Outer	Saloon RWD 274920		Track Control Arm	S062797
	2015.01-2018.08	Rear Axle Left & Right Lower Inner	Saloon RWD 274920		Track Control Arm	S062799
	2015.01-2018.08	Front Axle Left & Right Upper	Saloon RWD 274920		Control Arm Bushing	510529
	2015.01-2018.08	Front Axle Left & Right Lower Inner	Saloon RWD 274920		Control Arm Bushing	533481
	2015.01-2018.08	Front Axle Left & Right Lower Inner	Saloon RWD 274920		Control Arm Bushing	533482
	2015.01-2018.08	Front Axle Left & Right Lower Inner	Saloon RWD 274920		Control Arm Bushing	535418
	2015.01-2018.08	Front Axle Left & Right Lower Outer	Saloon RWD 274920		Control Arm Bushing	535456
	2015.01-2018.08	Rear Axle Left & Right Lower Inner	Saloon RWD 274920		Control Arm Bushing	530527
	2015.01-2018.08	Rear Axle Left & Right Upper Inner	Saloon RWD 274920		Control Arm Bushing	516563
	2015.01-2018.08	Rear Axle Left & Right Upper Inner	Saloon RWD 274920		Control Arm Bushing	530504
	2015.01-2018.08	Rear Axle Left & Right Upper Inner	Saloon RWD 274920		Control Arm Bushing	533480
	2015.01-2018.08	Rear Axle Left & Right Lower Outer	Saloon RWD 274920		Control Arm Bushing	516552
	2015.01-2018.08	Rear Axle Left & Right Lower Outer	Saloon RWD 274920		Control Arm Bushing	516553
	2015.01-2018.08	Front Axle Left & Right	Saloon RWD 274920		Tie Rod Axle Joint	S030926
	2015.01-2018.08	Front Axle Left	Saloon RWD 274920		Tie Rod End	S071616
	2015.01-2018.08	Front Axle Right	Saloon RWD 274920		Tie Rod End	S071617
	2015.01-2018.08	Front Axle Left	Saloon RWD 274920		Rod/Strut, stabiliser	S051250
	2015.01-2018.08	Front Axle Right	Saloon RWD 274920		Rod/Strut, stabiliser	S051249



	 YEAR	FITTING POSITION	BODY STYLE & DRIVE TYPE & ENGINE	REMARKS	PRODUCT	GSP Ref.
MERCEDES-BENZ C300						
2.0 (180 kw)	2015.01-2018.08	Rear Axle Left	Saloon RWD 274920		Rod/Strut,stabiliser	S051247
	2015.01-2018.08	Rear Axle Right	Saloon RWD 274920		Rod/Strut,stabiliser	S051248
	2015.09-2018.05	Front Axle Left Upper	Estate RWD 274920		Track Control Arm	S062802
	2015.09-2018.05	Front Axle Left Lower Inner	Estate RWD 274920		Track Control Arm	S062805
	2015.09-2018.05	Front Axle Left Lower Outer	Estate RWD 274920		Track Control Arm	S062844
	2015.09-2018.05	Front Axle Right Upper	Estate RWD 274920		Track Control Arm	S062801
	2015.09-2018.05	Front Axle Right Lower Inner	Estate RWD 274920		Track Control Arm	S062806
	2015.09-2018.05	Front Axle Right Lower Outer	Estate RWD 274920		Track Control Arm	S062845
	2015.09-2018.05	Rear Axle Left Upper Inner	Estate RWD 274920		Track Control Arm	S063227
	2015.09-2018.05	Rear Axle Left Lower Outer	Estate RWD 274920		Track Control Arm	S061566
	2015.09-2018.05	Rear Axle Left Upper Outer	Estate RWD 274920		Track Control Arm	S062798
	2015.09-2018.05	Rear Axle Right Upper Inner	Estate RWD 274920		Track Control Arm	S063228
	2015.09-2018.05	Rear Axle Right Lower Outer	Estate RWD 274920		Track Control Arm	S061567
	2015.09-2018.05	Rear Axle Right Upper Outer	Estate RWD 274920		Track Control Arm	S062797
	2015.09-2018.05	Rear Axle Left & Right Lower Inner	Estate RWD 274920		Track Control Arm	S062799
	2015.09-2018.05	Front Axle Left & Right Upper	Estate RWD 274920		Control Arm Bushing	510529
	2015.09-2018.05	Front Axle Left & Right Lower Inner	Estate RWD 274920		Control Arm Bushing	533481
	2015.09-2018.05	Front Axle Left & Right Lower Inner	Estate RWD 274920		Control Arm Bushing	533482
	2015.09-2018.05	Front Axle Left & Right Lower Inner	Estate RWD 274920		Control Arm Bushing	535418
	2015.09-2018.05	Front Axle Left & Right Lower Outer	Estate RWD 274920		Control Arm Bushing	535456
	2015.09-2018.05	Rear Axle Left & Right Lower Inner	Estate RWD 274920		Control Arm Bushing	530527
	2015.09-2018.05	Rear Axle Left & Right Upper Inner	Estate RWD 274920		Control Arm Bushing	530504
	2015.09-2018.05	Rear Axle Left & Right Upper Inner	Estate RWD 274920		Control Arm Bushing	533480
	2015.09-2018.05	Rear Axle Left & Right Lower Outer	Estate RWD 274920		Control Arm Bushing	516552
	2015.09-2018.05	Rear Axle Left & Right Lower Outer	Estate RWD 274920		Control Arm Bushing	516553
	2015.09-2018.05	Rear Axle Left & Right Upper Outer	Estate RWD 274920		Control Arm Bushing	531454
	2015.09-2018.05	Front Axle Left & Right	Estate RWD 274920		Tie Rod Axle Joint	S030926
	2015.09-2018.05	Front Axle Left	Estate RWD 274920		Tie Rod End	S071616
	2015.09-2018.05	Front Axle Right	Estate RWD 274920		Tie Rod End	S071617
	2015.09-2018.05	Front Axle Left	Estate RWD 274920		Rod/Strut,stabiliser	S051250
	2015.09-2018.05	Front Axle Right	Estate RWD 274920		Rod/Strut,stabiliser	S051249
	2015.09-2018.05	Rear Axle Left	Estate RWD 274920		Rod/Strut,stabiliser	S051247
	2015.09-2018.05	Rear Axle Right	Estate RWD 274920		Rod/Strut,stabiliser	S051248
	2016.06-2018.05	Front Axle Left Upper	Cabriolet RWD 274920		Track Control Arm	S062802
	2016.06-2018.05	Front Axle Left Lower Inner	Cabriolet RWD 274920		Track Control Arm	S062805
	2016.06-2018.05	Front Axle Left Lower Outer	Cabriolet RWD 274920		Track Control Arm	S062844
	2016.06-2018.05	Front Axle Right Upper	Cabriolet RWD 274920		Track Control Arm	S062801
	2016.06-2018.05	Front Axle Right Lower Inner	Cabriolet RWD 274920		Track Control Arm	S062806
	2016.06-2018.05	Front Axle Left & Right Lower Inner	Cabriolet RWD 274920		Track Control Arm	S062842
	2016.06-2018.05	Rear Axle Left Upper Inner	Cabriolet RWD 274920		Track Control Arm	S063227
	2016.06-2018.05	Rear Axle Left Lower Outer	Cabriolet RWD 274920		Track Control Arm	S061566
	2016.06-2018.05	Rear Axle Right Upper Inner	Cabriolet RWD 274920		Track Control Arm	S063228
	2016.06-2018.05	Rear Axle Right Lower Outer	Cabriolet RWD 274920		Track Control Arm	S061567
	2016.06-2018.05	Front Axle Left & Right Upper	Cabriolet RWD 274920		Control Arm Bushing	510529
	2016.06-2018.05	Front Axle Left & Right Lower Inner	Cabriolet RWD 274920		Control Arm Bushing	533481
	2016.06-2018.05	Front Axle Left & Right Lower Inner	Cabriolet RWD 274920		Control Arm Bushing	533482
	2016.06-2018.05	Front Axle Left & Right Lower Inner	Cabriolet RWD 274920		Control Arm Bushing	535418
	2016.06-2018.05	Front Axle Left & Right Lower Outer	Cabriolet RWD 274920		Control Arm Bushing	535456
	2016.06-2018.05	Rear Axle Left & Right Upper	Cabriolet RWD 274920		Control Arm Bushing	532971
	2016.06-2018.05	Rear Axle Left & Right Upper Inner	Cabriolet RWD 274920		Control Arm Bushing	530504
	2016.06-2018.05	Rear Axle Left & Right Upper Inner	Cabriolet RWD 274920		Control Arm Bushing	533480
	2016.06-2018.05	Rear Axle Left & Right Lower Outer	Cabriolet RWD 274920		Control Arm Bushing	516552
	2016.06-2018.05	Front Axle Left & Right	Cabriolet RWD 274920		Tie Rod Axle Joint	S030926
	2016.06-2018.05	Front Axle Left	Cabriolet RWD 274920		Tie Rod End	S071616
	2016.06-2018.05	Front Axle Right	Cabriolet RWD 274920		Tie Rod End	S071617
	2016.06-2018.05	Front Axle Left	Cabriolet RWD 274920		Rod/Strut,stabiliser	S051250
	2016.06-2018.05	Front Axle Right	Cabriolet RWD 274920		Rod/Strut,stabiliser	S051249
	2016.06-2018.05	Rear Axle Left	Cabriolet RWD 274920		Rod/Strut,stabiliser	S051247
	2016.06-2018.05	Rear Axle Right	Cabriolet RWD 274920		Rod/Strut,stabiliser	S051248
2.0 (190 kw)	2018.05-	Front Axle Left Upper	Saloon RWD 264920		Track Control Arm	S062802
	2018.05-	Front Axle Left Lower Inner	Saloon RWD 264920		Track Control Arm	S062805
	2018.05-	Front Axle Left Lower Outer	Saloon RWD 264920		Track Control Arm	S062844
	2018.05-	Front Axle Right Upper	Saloon RWD 264920		Track Control Arm	S062801
	2018.05-	Front Axle Right Lower Inner	Saloon RWD 264920		Track Control Arm	S062806

	 YEAR	FITTING POSITION	BODY STYLE & DRIVE TYPE & ENGINE	REMARKS	PRODUCT	GSP Ref.
MERCEDES-BENZ C300						
2.0 (190 kw)						
	2018.05-	Front Axle Right Lower Outer	Saloon RWD 264920		Track Control Arm	S062845
	2018.05-	Rear Axle Left Upper Inner	Saloon RWD 264920		Track Control Arm	S063227
	2018.05-	Rear Axle Left Lower Outer	Saloon RWD 264920		Track Control Arm	S061566
	2018.05-	Rear Axle Right Upper Inner	Saloon RWD 264920		Track Control Arm	S063228
	2018.05-	Rear Axle Right Lower Outer	Saloon RWD 264920		Track Control Arm	S061567
	2018.05-	Front Axle Left & Right Upper	Saloon RWD 264920		Control Arm Bushing	S051529
	2018.05-	Front Axle Left & Right Lower Inner	Saloon RWD 264920		Control Arm Bushing	533481
	2018.05-	Front Axle Left & Right Lower Inner	Saloon RWD 264920		Control Arm Bushing	533482
	2018.05-	Front Axle Left & Right Lower Inner	Saloon RWD 264920		Control Arm Bushing	535418
	2018.05-	Front Axle Left & Right Lower Outer	Saloon RWD 264920		Control Arm Bushing	535456
	2018.05-	Rear Axle Left & Right Upper Inner	Saloon RWD 264920		Control Arm Bushing	530504
	2018.05-	Rear Axle Left & Right Upper Inner	Saloon RWD 264920		Control Arm Bushing	533480
	2018.05-	Rear Axle Left & Right Lower Outer	Saloon RWD 264920		Control Arm Bushing	516552
	2018.05-	Front Axle Left & Right	Saloon RWD 264920		Tie Rod Axle Joint	S030926
	2018.05-	Front Axle Left	Saloon RWD 264920		Tie Rod End	S071616
	2018.05-	Front Axle Right	Saloon RWD 264920		Tie Rod End	S071617
	2018.05-	Front Axle Left	Saloon RWD 264920		Rod/Strut, stabiliser	S051250
	2018.05-	Front Axle Right	Saloon RWD 264920		Rod/Strut, stabiliser	S051249
	2018.05-	Rear Axle Left	Saloon RWD 264920		Rod/Strut, stabiliser	S051247
	2018.05-	Rear Axle Right	Saloon RWD 264920		Rod/Strut, stabiliser	S051248
3.0 (170 kw)						
	2008.01-2014.01	Front Axle Left Lower Inner	Saloon RWD 272947		Track Control Arm	S060262
	2008.01-2014.01	Front Axle Left Lower Outer	Saloon RWD 272947		Track Control Arm	S060221
	2008.01-2014.01	Front Axle Right Lower Inner	Saloon RWD 272947		Track Control Arm	S060263
	2008.01-2014.01	Front Axle Right Lower Outer	Saloon RWD 272947		Track Control Arm	S060222
	2008.01-2014.01	Rear Axle Left Upper Inner	Saloon RWD 272947		Track Control Arm	S063227
	2008.01-2014.01	Rear Axle Left Lower Outer	Saloon RWD 272947		Track Control Arm	S061566
	2008.01-2014.01	Rear Axle Left Upper Outer	Saloon RWD 272947		Track Control Arm	S062798
	2008.01-2014.01	Rear Axle Right Upper Inner	Saloon RWD 272947		Track Control Arm	S063228
	2008.01-2014.01	Rear Axle Right Lower Outer	Saloon RWD 272947		Track Control Arm	S061567
	2008.01-2014.01	Rear Axle Right Upper Outer	Saloon RWD 272947		Track Control Arm	S062797
	2008.01-2014.01	Rear Axle Left & Right Lower Inner	Saloon RWD 272947		Track Control Arm	S062799
	2008.01-2014.01	Front Axle Left & Right Lower Inner	Saloon RWD 272947		Control Arm Bushing	517969
	2008.01-2014.01	Front Axle Left & Right Lower Outer	Saloon RWD 272947		Control Arm Bushing	510491
	2008.01-2014.01	Front Axle Left & Right Lower Outer	Saloon RWD 272947		Control Arm Bushing	531450
	2008.01-2014.01	Rear Axle Left & Right Lower Inner	Saloon RWD 272947		Control Arm Bushing	530527
	2008.01-2014.01	Rear Axle Left & Right Upper Inner	Saloon RWD 272947		Control Arm Bushing	530504
	2008.01-2014.01	Rear Axle Left & Right Upper Inner	Saloon RWD 272947		Control Arm Bushing	533480
	2008.01-2014.01	Rear Axle Left & Right Lower Outer	Saloon RWD 272947		Control Arm Bushing	516552
	2008.01-2014.01	Rear Axle Left & Right Lower Outer	Saloon RWD 272947		Control Arm Bushing	516553
	2008.01-2014.01	Rear Axle Left & Right Upper Outer	Saloon RWD 272947		Control Arm Bushing	531454
	2008.01-2014.01	Front Axle Left & Right	Saloon RWD 272947		Tie Rod Axle Joint	S030171
	2008.01-2014.01	Front Axle Left & Right	Saloon RWD 272947		Tie Rod Axle Joint	S030932
	2008.01-2014.01	Front Axle Left	Saloon RWD 272947		Tie Rod End	S070284
	2008.01-2014.01	Front Axle Right	Saloon RWD 272947		Tie Rod End	S070285
	2008.01-2014.01	Front Axle Left	Saloon RWD 272947	for vehicles without sports suspension	Rod/Strut, stabiliser	S050304
	2008.01-2014.01	Front Axle Left	Saloon RWD 272947		Rod/Strut, stabiliser	S051290
	2008.01-2014.01	Front Axle Right	Saloon RWD 272947	for vehicles without sports suspension	Rod/Strut, stabiliser	S050305
	2008.01-2014.01	Front Axle Right	Saloon RWD 272947	Equipment Vari.:EXC.4MATIC - SPORT	Rod/Strut, stabiliser	S051289
	2008.01-2014.01	Rear Axle Left	Saloon RWD 272947		Rod/Strut, stabiliser	S050306
	2008.01-2014.01	Rear Axle Right	Saloon RWD 272947		Rod/Strut, stabiliser	S050307
C32 AMG						
3.2 (260 kw)						
	2000.11-2004.12	Front Axle Left Lower Inner	Saloon RWD 112961		Track Control Arm	S060219
	2000.11-2004.12	Front Axle Left Lower Outer	Saloon RWD 112961		Track Control Arm	S060221
	2000.11-2004.12	Front Axle Right Lower Inner	Saloon RWD 112961		Track Control Arm	S060220
	2000.11-2004.12	Front Axle Right Lower Outer	Saloon RWD 112961		Track Control Arm	S060222
	2000.11-2004.12	Rear Axle Left & Right Lower Inner	Saloon RWD 112961		Track Control Arm	S060217
	2000.11-2004.12	Rear Axle Left & Right Upper Inner	Saloon RWD 112961		Track Control Arm	S060216
	2000.11-2004.12	Rear Axle Left & Right Upper Outer	Saloon RWD 112961		Track Control Arm	S060218
	2000.11-2004.12	Front Axle Left & Right Lower Inner	Saloon RWD 112961		Control Arm Bushing	510565
	2000.11-2004.12	Front Axle Left & Right Lower Outer	Saloon RWD 112961		Control Arm Bushing	510491
	2000.11-2004.12	Rear Axle Left & Right Lower	Saloon RWD 112961		Control Arm Bushing	511560
	2000.11-2004.12	Rear Axle Left & Right Upper Inner	Saloon RWD 112961		Control Arm Bushing	517809
	2000.11-2004.12	Rear Axle Left & Right Lower Outer	Saloon RWD 112961		Control Arm Bushing	512252
	2000.11-2004.12	Front Axle	Saloon RWD 112961	for vehicles without sports suspension	Suspension Repair Kit	S990006SK

	 YEAR	FITTING POSITION	BODY STYLE & DRIVE TYPE & ENGINE	REMARKS	PRODUCT	GSP Ref.
MERCEDES-BENZ						
C32 AMG						
3.2 (260 kw)						
	2000.11-2004.12	Front Axle	Saloon RWD 112961		Suspension Repair Kit	S990034SK
	2000.11-2004.12	Front Axle Left & Right	Saloon RWD 112961		Tie Rod Axle Joint	S030853
	2000.11-2004.12	Front Axle Left	Saloon RWD 112961		Tie Rod End	S070284
	2000.11-2004.12	Front Axle Right	Saloon RWD 112961		Tie Rod End	S070285
	2000.11-2004.12	Front Axle Left & Right	Saloon RWD 112961		Rod/Strut,stabiliser	S050273
	2000.11-2004.12	Front Axle Left & Right	Saloon RWD 112961	for vehicles with sports suspension	Rod/Strut,stabiliser	S050315
	2000.11-2004.12	Rear Axle Left	Saloon RWD 112961		Rod/Strut,stabiliser	S050302
	2000.11-2004.12	Rear Axle Right	Saloon RWD 112961		Rod/Strut,stabiliser	S050303
	2000.11-2004.12	Front Axle	Saloon RWD 112961		Stabiliser Bushing	512614
	2000.11-2004.12	Front Axle	Saloon RWD 112961		Stabiliser Bushing	512615
	2000.11-2004.12	Rear Axle	Saloon RWD 112961	Inner Diameter:15mm	Stabiliser Bushing	530969
	2000.11-2004.12	Rear Axle	Saloon RWD 112961	Inner diameter:13.4mm	Stabiliser Bushing	530972
	2000.11-2004.12	Front Axle	Saloon RWD 112961		Steering Boot	540343
	2000.11-2004.12	Front Axle	Saloon RWD 112961	Date to:2004.12	Steering Rack Bellow Kit	540343S
C320						
3.2 (160 kw)						
	2000.05-2005.07	Front Axle Left Lower Inner	Saloon RWD 112946		Track Control Arm	S060219
	2000.05-2005.07	Front Axle Left Lower Outer	Saloon RWD 112946		Track Control Arm	S060221
	2000.05-2005.07	Front Axle Right Lower Inner	Saloon RWD 112946		Track Control Arm	S060220
	2000.05-2005.07	Front Axle Right Lower Outer	Saloon RWD 112946		Track Control Arm	S060222
	2000.05-2005.07	Rear Axle Left & Right Lower Inner	Saloon RWD 112946		Track Control Arm	S060217
	2000.05-2005.07	Rear Axle Left & Right Upper Inner	Saloon RWD 112946		Track Control Arm	S060216
	2000.05-2005.07	Rear Axle Left & Right Upper Outer	Saloon RWD 112946		Track Control Arm	S060218
	2000.05-2005.07	Front Axle Left & Right Lower Inner	Saloon RWD 112946		Control Arm Bushing	510565
	2000.05-2005.07	Front Axle Left & Right Lower Outer	Saloon RWD 112946		Control Arm Bushing	510491
	2000.05-2005.07	Front Axle Left & Right Lower Outer	Saloon RWD 112946		Control Arm Bushing	531450
	2000.05-2005.07	Rear Axle Left & Right Lower	Saloon RWD 112946		Control Arm Bushing	511560
	2000.05-2005.07	Rear Axle Left & Right Upper Inner	Saloon RWD 112946		Control Arm Bushing	517809
	2000.05-2005.07	Rear Axle Left & Right Lower Outer	Saloon RWD 112946		Control Arm Bushing	512252
	2000.05-2005.07	Front Axle	Saloon RWD 112946	for vehicles without sports suspension	Suspension Repair Kit	S990006SK
	2000.05-2005.07	Front Axle	Saloon RWD 112946		Suspension Repair Kit	S990034SK
	2000.05-2005.07	Front Axle Left & Right	Saloon RWD 112946		Tie Rod Axle Joint	S030853
	2000.05-2005.07	Front Axle Left	Saloon RWD 112946		Tie Rod End	S070284
	2000.05-2005.07	Front Axle Right	Saloon RWD 112946		Tie Rod End	S070285
	2000.05-2005.07	Front Axle Left & Right	Saloon RWD 112946		Rod/Strut,stabiliser	S050273
	2000.05-2005.07	Front Axle Left & Right	Saloon RWD 112946	for vehicles with sports suspension	Rod/Strut,stabiliser	S050315
	2000.05-2005.07	Rear Axle Left	Saloon RWD 112946		Rod/Strut,stabiliser	S050302
	2000.05-2005.07	Rear Axle Right	Saloon RWD 112946		Rod/Strut,stabiliser	S050303
	2000.05-2005.07	Front Axle Left & Right	Saloon RWD 112946		Stabiliser Bushing	530744
	2000.05-2005.07	Front Axle	Saloon RWD 112946		Stabiliser Bushing	512614
	2000.05-2005.07	Front Axle	Saloon RWD 112946		Stabiliser Bushing	512615
	2000.05-2005.07	Rear Axle	Saloon RWD 112946	for vehicles with sports suspension	Stabiliser Bushing	530969
	2000.05-2005.07	Rear Axle	Saloon RWD 112946	VIN:WDBA555897 from E 617571 from F 467375 from R 131145	Stabiliser Bushing	530970
	2000.05-2005.07	Rear Axle	Saloon RWD 112946	VIN:WDBA555897 from E 617571 from F 467375 from R 131145	Stabiliser Bushing	530972
	2000.05-2005.07	Front Axle	Saloon RWD 112946		Steering Boot	540343
	2000.05-2005.07	Front Axle	Saloon RWD 112946	Date to:2005.07	Steering Rack Bellow Kit	540343S
	2002.08-2005.07	Front Axle Left Lower Inner	Saloon 4WD 112953		Track Control Arm	S060219
	2002.08-2005.07	Front Axle Right Lower Inner	Saloon 4WD 112953		Track Control Arm	S060220
	2002.08-2005.07	Rear Axle Left & Right Lower Inner	Saloon 4WD 112953		Track Control Arm	S060217
	2002.08-2005.07	Rear Axle Left & Right Upper Inner	Saloon 4WD 112953		Track Control Arm	S060216
	2002.08-2005.07	Rear Axle Left & Right Upper Outer	Saloon 4WD 112953		Track Control Arm	S060218
	2002.08-2005.07	Front Axle Left & Right Lower Inner	Saloon 4WD 112953		Control Arm Bushing	510565
	2002.08-2005.07	Rear Axle Left & Right Lower	Saloon 4WD 112953		Control Arm Bushing	511560
	2002.08-2005.07	Rear Axle Left & Right Upper Inner	Saloon 4WD 112953		Control Arm Bushing	517809
	2002.08-2005.07	Rear Axle Left & Right Lower Outer	Saloon 4WD 112953		Control Arm Bushing	512252
	2002.08-2005.07	Front Axle Left	Saloon 4WD 112953		Tie Rod End	S071162
	2002.08-2005.07	Front Axle Right	Saloon 4WD 112953		Tie Rod End	S071163
	2002.08-2005.07	Front Axle Left & Right	Saloon 4WD 112953		Rod/Strut,stabiliser	S050273
	2002.08-2005.07	Front Axle Left & Right	Saloon 4WD 112953	for vehicles with sports suspension	Rod/Strut,stabiliser	S050315
	2002.08-2005.07	Rear Axle Left	Saloon 4WD 112953		Rod/Strut,stabiliser	S050302
	2002.08-2005.07	Rear Axle Right	Saloon 4WD 112953		Rod/Strut,stabiliser	S050303
	2002.08-2005.07	Front Axle Left & Right	Saloon 4WD 112953		Stabiliser Bushing	530744
	2002.08-2005.07	Front Axle	Saloon 4WD 112953		Stabiliser Bushing	512614
	2002.08-2005.07	Front Axle	Saloon 4WD 112953		Stabiliser Bushing	512615
	2002.08-2005.07	Rear Axle	Saloon 4WD 112953		Stabiliser Bushing	530969

	 YEAR	FITTING POSITION	BODY STYLE & DRIVE TYPE & ENGINE	REMARKS	PRODUCT	GSP Ref.
MERCEDES-BENZ C320						
3.2 (160 kw)	2002.08-2005.07	Rear Axle	Saloon 4WD 112953		Stabiliser Bushing	530972
C350						
3.5 (200 kw)	2005.01-2007.02	Front Axle Left Lower Inner	Saloon RWD 272960		Track Control Arm	S060219
	2005.01-2007.02	Front Axle Left Lower Outer	Saloon RWD 272960		Track Control Arm	S060221
	2005.01-2007.02	Front Axle Right Lower Inner	Saloon RWD 272960		Track Control Arm	S060220
	2005.01-2007.02	Front Axle Right Lower Outer	Saloon RWD 272960		Track Control Arm	S060222
	2005.01-2007.02	Rear Axle Left & Right Lower Inner	Saloon RWD 272960		Track Control Arm	S060217
	2005.01-2007.02	Rear Axle Left & Right Upper Inner	Saloon RWD 272960		Track Control Arm	S060216
	2005.01-2007.02	Rear Axle Left & Right Upper Outer	Saloon RWD 272960		Track Control Arm	S060218
	2005.01-2007.02	Front Axle Left & Right Lower Inner	Saloon RWD 272960		Control Arm Bushing	510565
	2005.01-2007.02	Front Axle Left & Right Lower Outer	Saloon RWD 272960		Control Arm Bushing	510491
	2005.01-2007.02	Front Axle Left & Right Lower Outer	Saloon RWD 272960		Control Arm Bushing	531450
	2005.01-2007.02	Rear Axle Left & Right Lower	Saloon RWD 272960		Control Arm Bushing	511560
	2005.01-2007.02	Rear Axle Left & Right Upper Inner	Saloon RWD 272960		Control Arm Bushing	517809
	2005.01-2007.02	Rear Axle Left & Right Lower Outer	Saloon RWD 272960		Control Arm Bushing	512252
	2005.01-2007.02	Front Axle	Saloon RWD 272960		Suspension Repair Kit	S99006SK
	2005.01-2007.02	Front Axle	Saloon RWD 272960		Suspension Repair Kit	S990034SK
	2005.01-2007.02	Front Axle Left & Right	Saloon RWD 272960		Tie Rod Axle Joint	S030853
	2005.01-2007.02	Front Axle Left	Saloon RWD 272960		Tie Rod End	S070284
	2005.01-2007.02	Front Axle Right	Saloon RWD 272960		Tie Rod End	S070285
	2005.01-2007.02	Front Axle Left & Right	Saloon RWD 272960		Rod/Strut, stabiliser	S050273
	2005.01-2007.02	Front Axle Left & Right	Saloon RWD 272960	for vehicles with sports suspension	Rod/Strut, stabiliser	S050315
	2005.01-2007.02	Rear Axle Left	Saloon RWD 272960		Rod/Strut, stabiliser	S050302
	2005.01-2007.02	Rear Axle Right	Saloon RWD 272960		Rod/Strut, stabiliser	S050303
	2005.01-2007.02	Front Axle	Saloon RWD 272960		Stabiliser Bushing	512614
	2005.01-2007.02	Front Axle	Saloon RWD 272960		Stabiliser Bushing	512615
	2005.01-2007.02	Rear Axle	Saloon RWD 272960		Stabiliser Bushing	530969
	2005.01-2007.02	Rear Axle	Saloon RWD 272960	VIN from A 55589 from E 01751 from F 45735 from R 131145	Stabiliser Bushing	530970
	2005.01-2007.02	Rear Axle	Saloon RWD 272960	VIN A 9824 E 21926 26262 10585 for vehicles without sports suspension	Stabiliser Bushing	530972
	2005.01-2007.02	Front Axle	Saloon RWD 272960		Steering Boot	540343
	2005.01-2007.02	Front Axle	Saloon RWD 272960	540343S and 541198S different structure	Steering Rack Bellow Kit	540343S
	2005.03-2007.02	Front Axle Left Lower Inner	Saloon 4WD 272970		Track Control Arm	S060219
	2005.03-2007.02	Front Axle Right Lower Inner	Saloon 4WD 272970		Track Control Arm	S060220
	2005.03-2007.02	Rear Axle Left & Right Lower Inner	Saloon 4WD 272970		Track Control Arm	S060217
	2005.03-2007.02	Rear Axle Left & Right Upper Inner	Saloon 4WD 272970		Track Control Arm	S060216
	2005.03-2007.02	Rear Axle Left & Right Upper Outer	Saloon 4WD 272970		Track Control Arm	S060218
	2005.03-2007.02	Front Axle Left & Right Lower Inner	Saloon 4WD 272970		Control Arm Bushing	510565
	2005.03-2007.02	Rear Axle Left & Right Lower	Saloon 4WD 272970		Control Arm Bushing	511560
	2005.03-2007.02	Rear Axle Left & Right Upper Inner	Saloon 4WD 272970		Control Arm Bushing	517809
	2005.03-2007.02	Rear Axle Left & Right Lower Outer	Saloon 4WD 272970		Control Arm Bushing	512252
	2005.03-2007.02	Front Axle Left	Saloon 4WD 272970		Tie Rod End	S071162
	2005.03-2007.02	Front Axle Right	Saloon 4WD 272970		Tie Rod End	S071163
	2005.03-2007.02	Front Axle Left & Right	Saloon 4WD 272970	for vehicles without sports suspension	Rod/Strut, stabiliser	S050273
	2005.03-2007.02	Front Axle Left & Right	Saloon 4WD 272970	for vehicles with sports suspension	Rod/Strut, stabiliser	S050315
	2005.03-2007.02	Rear Axle Left	Saloon 4WD 272970		Rod/Strut, stabiliser	S050302
	2005.03-2007.02	Rear Axle Right	Saloon 4WD 272970		Rod/Strut, stabiliser	S050303
	2005.03-2007.02	Front Axle	Saloon 4WD 272970		Stabiliser Bushing	512614
	2005.03-2007.02	Front Axle	Saloon 4WD 272970		Stabiliser Bushing	512615
	2005.03-2007.02	Rear Axle	Saloon 4WD 272970		Stabiliser Bushing	530969
	2005.03-2007.02	Rear Axle	Saloon 4WD 272970		Stabiliser Bushing	530972
	2007.02-2014.01	Front Axle Left Lower Inner	Saloon RWD 272961		Track Control Arm	S060262
	2007.02-2014.01	Front Axle Left Lower Outer	Saloon RWD 272961		Track Control Arm	S060221
	2007.02-2014.01	Front Axle Right Lower Inner	Saloon RWD 272961		Track Control Arm	S060263
	2007.02-2014.01	Front Axle Right Lower Outer	Saloon RWD 272961		Track Control Arm	S060222
	2007.02-2014.01	Rear Axle Left Upper Inner	Saloon RWD 272961		Track Control Arm	S063227
	2007.02-2014.01	Rear Axle Left Lower Outer	Saloon RWD 272961		Track Control Arm	S061566
	2007.02-2014.01	Rear Axle Left Upper Outer	Saloon RWD 272961		Track Control Arm	S062798
	2007.02-2014.01	Rear Axle Right Upper Inner	Saloon RWD 272961		Track Control Arm	S063228
	2007.02-2014.01	Rear Axle Right Lower Outer	Saloon RWD 272961		Track Control Arm	S061567
	2007.02-2014.01	Rear Axle Right Upper Outer	Saloon RWD 272961		Track Control Arm	S062797
	2007.02-2014.01	Rear Axle Left & Right Lower Inner	Saloon RWD 272961		Track Control Arm	S062799
	2007.02-2014.01	Front Axle Left & Right Lower Inner	Saloon RWD 272961		Control Arm Bushing	517969
	2007.02-2014.01	Front Axle Left & Right Lower Outer	Saloon RWD 272961		Control Arm Bushing	510491
	2007.02-2014.01	Front Axle Left & Right Lower Outer	Saloon RWD 272961		Control Arm Bushing	531450



	 YEAR	FITTING POSITION	BODY STYLE & DRIVE TYPE & ENGINE	REMARKS	PRODUCT	GSP Ref.
MERCEDES-BENZ C350						
3.5 (200 kw)						
	2007.02-2014.01	Rear Axle Left & Right Lower Inner	Saloon RWD 272961		Control Arm Bushing	530527
	2007.02-2014.01	Rear Axle Left & Right Upper Inner	Saloon RWD 272961		Control Arm Bushing	530504
	2007.02-2014.01	Rear Axle Left & Right Upper Inner	Saloon RWD 272961		Control Arm Bushing	533480
	2007.02-2014.01	Rear Axle Left & Right Lower Outer	Saloon RWD 272961		Control Arm Bushing	516552
	2007.02-2014.01	Rear Axle Left & Right Lower Outer	Saloon RWD 272961		Control Arm Bushing	516553
	2007.02-2014.01	Rear Axle Left & Right Upper Outer	Saloon RWD 272961		Control Arm Bushing	531454
	2007.02-2014.01	Front Axle Left & Right	Saloon RWD 272961		Tie Rod Axle Joint	S030171
	2007.02-2014.01	Front Axle Left & Right	Saloon RWD 272961		Tie Rod Axle Joint	S030932
	2007.02-2014.01	Front Axle Left	Saloon RWD 272961		Tie Rod End	S070284
	2007.02-2014.01	Front Axle Right	Saloon RWD 272961		Tie Rod End	S070285
	2007.02-2014.01	Front Axle Left	Saloon RWD 272961	for vehicles without sports suspension	Rod/Strut, stabiliser	S050304
	2007.02-2014.01	Front Axle Left	Saloon RWD 272961		Rod/Strut, stabiliser	S051290
	2007.02-2014.01	Front Axle Right	Saloon RWD 272961	for vehicles without sports suspension	Rod/Strut, stabiliser	S050305
	2007.02-2014.01	Front Axle Right	Saloon RWD 272961	Equipment Vart.:EXC.4MATIC - SPORT	Rod/Strut, stabiliser	S051289
	2007.02-2014.01	Rear Axle Left	Saloon RWD 272961		Rod/Strut, stabiliser	S050306
	2007.02-2014.01	Rear Axle Right	Saloon RWD 272961		Rod/Strut, stabiliser	S050307
C36 AMG						
3.6 (206 kw)						
	1994.01-1998.01	Front Axle Left Lower	Saloon RWD 104941AMG		Track Control Arm	S060575
	1994.01-1998.01	Front Axle Left Upper	Saloon RWD 104941AMG		Track Control Arm	S060214
	1994.01-1998.01	Front Axle Right Lower	Saloon RWD 104941AMG		Track Control Arm	S060576
	1994.01-1998.01	Front Axle Right Upper	Saloon RWD 104941AMG		Track Control Arm	S060215
	1994.01-1998.01	Rear Axle Left & Right Lower Inner	Saloon RWD 104941AMG		Track Control Arm	S060217
	1994.01-1998.01	Rear Axle Left & Right Upper Inner	Saloon RWD 104941AMG	Chassis no. from: A 599099.F 698668	Track Control Arm	S060216
	1994.01-1998.01	Rear Axle Left & Right Lower Outer	Saloon RWD 104941AMG		Track Control Arm	S051055
	1994.01-1998.01	Rear Axle Left & Right Upper Outer	Saloon RWD 104941AMG		Track Control Arm	S060218
	1994.01-1998.01	Front Axle Left & Right Lower	Saloon RWD 104941AMG		Ball Joint	S080143
	1994.01-1998.01	Front Axle Left & Right Lower	Saloon RWD 104941AMG		Control Arm Bushing	510468
	1994.01-1998.01	Front Axle Left & Right Lower	Saloon RWD 104941AMG		Control Arm Bushing	510517
	1994.01-1998.01	Front Axle Left & Right Lower	Saloon RWD 104941AMG		Control Arm Bushing	530232
	1994.01-1998.01	Front Axle Left & Right Upper	Saloon RWD 104941AMG		Control Arm Bushing	510456
	1994.01-1998.01	Rear Axle Left & Right Lower	Saloon RWD 104941AMG		Control Arm Bushing	511560
	1994.01-1998.01	Rear Axle Left & Right Upper Inner	Saloon RWD 104941AMG		Control Arm Bushing	517809
	1994.01-1998.01	Rear Axle Left & Right Lower Outer	Saloon RWD 104941AMG		Control Arm Bushing	510431
	1994.01-1998.01	Rear Axle Left & Right Lower Outer	Saloon RWD 104941AMG		Control Arm Bushing	512252
	1994.01-1998.01	Rear Axle Left & Right Upper Outer	Saloon RWD 104941AMG		Control Arm Bushing	510430
	1994.01-1998.01	Front Axle Left & Right Lower	Saloon RWD 104941AMG		Control Arm Bushing Kit	510483S
	1994.01-1998.01	Rear Axle	Saloon RWD 104941AMG		Suspension Repair Kit	S990038SK
	1994.01-1998.01	Front Axle Left & Right	Saloon RWD 104941AMG		Rod Assembly	S100079
	1994.01-1998.01	Front Axle Left & Right	Saloon RWD 104941AMG		Tie Rod End	S070309
	1994.01-1998.01	Rear Axle Left & Right	Saloon RWD 104941AMG		Rod/Strut, stabiliser	S100063
	1994.01-1998.01	Front Axle Left & Right Outer	Saloon RWD 104941AMG		Stabiliser Bushing	511553
	1994.01-1998.01	Rear Axle	Saloon RWD 104941AMG		Stabiliser Bushing	517269
	1994.01-1998.01	Front Axle	Saloon RWD 104941AMG		Stabiliser Bushing Kit	519452S
C43 AMG						
3.0 (270 kw)						
	2016.04-2018.05	Front Axle Left & Right Lower Inner	Coupe 4WD 276823		Track Control Arm	S062842
	2016.04-2018.05	Rear Axle Left & Right Upper	Coupe 4WD 276823		Control Arm Bushing	533480
	2016.04-2018.05	Front Axle Left & Right	Coupe 4WD 276823		Tie Rod Axle Joint	S031025
	2016.04-2018.05	Front Axle Left	Coupe 4WD 276823		Tie Rod End	S071773
	2016.04-2018.05	Front Axle Right	Coupe 4WD 276823		Tie Rod End	S071774
	2016.04-2018.05	Front Axle Left	Coupe 4WD 276823		Rod/Strut, stabiliser	S051250
	2016.04-2018.05	Front Axle Right	Coupe 4WD 276823		Rod/Strut, stabiliser	S051249
	2016.04-2018.05	Rear Axle Left	Coupe 4WD 276823		Rod/Strut, stabiliser	S051247
	2016.04-2018.05	Rear Axle Right	Coupe 4WD 276823		Rod/Strut, stabiliser	S051248
4.3 (225 kw)						
	1996.12-2000.12	Front Axle Left Lower	Saloon RWD 113944		Track Control Arm	S060575
	1996.12-2000.12	Front Axle Left Upper	Saloon RWD 113944		Track Control Arm	S060214
	1996.12-2000.12	Front Axle Right Lower	Saloon RWD 113944		Track Control Arm	S060576
	1996.12-2000.12	Front Axle Right Upper	Saloon RWD 113944		Track Control Arm	S060215
	1996.12-2000.12	Rear Axle Left & Right Lower Inner	Saloon RWD 113944		Track Control Arm	S060217
	1996.12-2000.12	Rear Axle Left & Right Upper Inner	Saloon RWD 113944	Chassis no. from: A 599099.F 698668	Track Control Arm	S060216
	1996.12-2000.12	Rear Axle Left & Right Lower Outer	Saloon RWD 113944		Track Control Arm	S051055
	1996.12-2000.12	Front Axle Left & Right Lower	Saloon RWD 113944		Ball Joint	S080143
	1996.12-2000.12	Front Axle Left & Right Lower	Saloon RWD 113944		Control Arm Bushing	510468
	1996.12-2000.12	Front Axle Left & Right Lower	Saloon RWD 113944		Control Arm Bushing	510517
	1996.12-2000.12	Front Axle Left & Right Lower	Saloon RWD 113944		Control Arm Bushing	530232



	 YEAR	FITTING POSITION	BODY STYLE & DRIVE TYPE & ENGINE	REMARKS	PRODUCT	GSP Ref.
MERCEDES-BENZ C43 AMG						
4.3 (225 kw)						
	1996.12-2000.12	Front Axle Left & Right Upper	Saloon RWD 113944		Control Arm Bushing	510456
	1996.12-2000.12	Rear Axle Left & Right Lower	Saloon RWD 113944		Control Arm Bushing	511560
	1996.12-2000.12	Rear Axle Left & Right Upper Inner	Saloon RWD 113944		Control Arm Bushing	517809
	1996.12-2000.12	Rear Axle Left & Right Lower Outer	Saloon RWD 113944		Control Arm Bushing	512252
	1996.12-2000.12	Front Axle Left & Right Lower	Saloon RWD 113944		Control Arm Bushing Kit	510483S
	1996.12-2000.12	Rear Axle	Saloon RWD 113944		Suspension Repair Kit	S990038SK
	1996.12-2000.12	Front Axle Left & Right	Saloon RWD 113944		Rod Assembly	S100183
	1996.12-2000.12	Front Axle Left & Right	Saloon RWD 113944		Tie Rod End	S070309
	1996.12-2000.12	Rear Axle Left & Right	Saloon RWD 113944		Rod/Strut, stabiliser	S100063
	1996.12-2000.12	Front Axle Left & Right Outer	Saloon RWD 113944		Stabiliser Bushing	511553
	1996.12-2000.12	Rear Axle	Saloon RWD 113944		Stabiliser Bushing	517269
C55 AMG						
5.4 (270 kw)						
	2003.08-2007.11	Front Axle Left Lower Inner	Estate RWD 113988		Track Control Arm	S060219
	2003.08-2007.11	Front Axle Left Lower Outer	Estate RWD 113988		Track Control Arm	S060221
	2003.08-2007.11	Front Axle Right Lower Inner	Estate RWD 113988		Track Control Arm	S060220
	2003.08-2007.11	Front Axle Right Lower Outer	Estate RWD 113988		Track Control Arm	S060222
	2003.08-2007.11	Rear Axle Left & Right Lower Inner	Estate RWD 113988		Track Control Arm	S060217
	2003.08-2007.11	Rear Axle Left & Right Upper Inner	Estate RWD 113988		Track Control Arm	S060216
	2003.08-2007.11	Front Axle Left & Right Lower Inner	Estate RWD 113988		Control Arm Bushing	510565
	2003.08-2007.11	Front Axle Left & Right Lower Inner	Estate RWD 113988		Control Arm Bushing	518120
	2003.08-2007.11	Rear Axle Left & Right Lower	Estate RWD 113988		Control Arm Bushing	511560
	2003.08-2007.11	Rear Axle Left & Right Upper Inner	Estate RWD 113988		Control Arm Bushing	517809
	2003.08-2007.11	Rear Axle Left & Right Lower Outer	Estate RWD 113988		Control Arm Bushing	512252
	2003.08-2007.11	Front Axle	Estate RWD 113988	for vehicles without sports suspension	Suspension Repair Kit	S990006SK
	2003.08-2007.11	Front Axle	Estate RWD 113988		Suspension Repair Kit	S990034SK
	2003.08-2007.11	Front Axle Left & Right	Estate RWD 113988		Tie Rod Axle Joint	S030853
	2003.08-2007.11	Front Axle Left	Estate RWD 113988		Tie Rod End	S070284
	2003.08-2007.11	Front Axle Right	Estate RWD 113988		Tie Rod End	S070285
	2003.08-2007.11	Front Axle Left & Right	Estate RWD 113988	for vehicles with sports suspension	Rod/Strut, stabiliser	S050315
	2003.08-2007.11	Rear Axle Left	Estate RWD 113988		Rod/Strut, stabiliser	S050302
	2003.08-2007.11	Rear Axle Right	Estate RWD 113988		Rod/Strut, stabiliser	S050303
	2003.08-2007.11	Front Axle	Estate RWD 113988		Steering Boot	540343
	2003.08-2007.11	Front Axle	Estate RWD 113988	540343S and 541198S different structure	Steering Rack Bellow Kit	540343S
C63 AMG						
4.0 (375 kw)						
	2014.10-	Front Axle Left Lower Outer	Saloon RWD 177980		Track Control Arm	S062844
	2014.10-	Front Axle Right Lower Outer	Saloon RWD 177980		Track Control Arm	S062845
	2014.10-	Rear Axle Left & Right Upper	Saloon RWD 177980		Control Arm Bushing	533480
	2014.10-	Front Axle Left & Right	Saloon RWD 177980		Tie Rod Axle Joint	S030926
	2014.10-	Front Axle Left	Saloon RWD 177980		Tie Rod End	S071616
	2014.10-	Front Axle Right	Saloon RWD 177980		Tie Rod End	S071617
	2014.10-	Front Axle Left	Saloon RWD 177980		Rod/Strut, stabiliser	S051250
	2014.10-	Front Axle Right	Saloon RWD 177980		Rod/Strut, stabiliser	S051249
	2014.10-	Rear Axle Left	Saloon RWD 177980		Rod/Strut, stabiliser	S051247
	2014.10-	Rear Axle Right	Saloon RWD 177980		Rod/Strut, stabiliser	S051248
	2016.02-	Front Axle Right Lower Outer	Coupe RWD 177980		Track Control Arm	S062845
	2016.02-	Front Axle Left & Right Lower Inner	Coupe RWD 177980		Track Control Arm	S062842
	2016.02-	Rear Axle Left & Right Upper	Coupe RWD 177980		Control Arm Bushing	533480
	2016.02-	Front Axle Left & Right	Coupe RWD 177980		Tie Rod Axle Joint	S030926
	2016.02-	Front Axle Left	Coupe RWD 177980		Tie Rod End	S071616
	2016.02-	Front Axle Right	Coupe RWD 177980		Tie Rod End	S071617
	2016.02-	Front Axle Left	Coupe RWD 177980		Rod/Strut, stabiliser	S051250
	2016.02-	Front Axle Right	Coupe RWD 177980		Rod/Strut, stabiliser	S051249
	2016.02-	Rear Axle Left	Coupe RWD 177980		Rod/Strut, stabiliser	S051247
	2016.02-	Rear Axle Right	Coupe RWD 177980		Rod/Strut, stabiliser	S051248
6.2 (336 kw)						
	2007.08-2014.01	Rear Axle Left Upper Inner	Saloon RWD 156985		Track Control Arm	S063227
	2007.08-2014.01	Rear Axle Left Lower Outer	Saloon RWD 156985		Track Control Arm	S061566
	2007.08-2014.01	Rear Axle Left Upper Outer	Saloon RWD 156985		Track Control Arm	S062798
	2007.08-2014.01	Rear Axle Right Upper Inner	Saloon RWD 156985		Track Control Arm	S063228
	2007.08-2014.01	Rear Axle Right Lower Outer	Saloon RWD 156985		Track Control Arm	S061567
	2007.08-2014.01	Rear Axle Right Upper Outer	Saloon RWD 156985		Track Control Arm	S062797
	2007.08-2014.01	Rear Axle Left & Right Lower Inner	Saloon RWD 156985		Track Control Arm	S062799
	2007.08-2014.01	Front Axle Left & Right Lower Inner	Saloon RWD 156985		Control Arm Bushing	518120
	2007.08-2014.01	Rear Axle Left & Right Lower Inner	Saloon RWD 156985		Control Arm Bushing	530527
	2007.08-2014.01	Rear Axle Left & Right Upper Inner	Saloon RWD 156985		Control Arm Bushing	533480



	 YEAR	FITTING POSITION	BODY STYLE & DRIVE TYPE & ENGINE	REMARKS	PRODUCT	GSP Ref.	
MERCEDES-BENZ C63 AMG							
6.2 (336 kw)	2007.08-2014.01	Rear Axle Left & Right Lower Outer	Saloon RWD 156985	For Mdl Year:2011	Control Arm Bushing	516552	
	2007.08-2014.01	Rear Axle Left & Right Lower Outer	Saloon RWD 156985		Control Arm Bushing	516553	
	2007.08-2014.01	Rear Axle Left & Right Upper Outer	Saloon RWD 156985		Control Arm Bushing	531454	
	2007.08-2014.01	Front Axle Left & Right	Saloon RWD 156985		Tie Rod Axle Joint	S030932	
	2007.08-2014.01	Front Axle Left	Saloon RWD 156985		Tie Rod End	S070284	
	2007.08-2014.01	Front Axle Right	Saloon RWD 156985		Tie Rod End	S070285	
	2007.08-2014.01	Front Axle Left	Saloon RWD 156985		Rod/Strut,stabiliser	S051290	
	2007.08-2014.01	Front Axle Right	Saloon RWD 156985	Equipment Var.:EXC.4MATIC - SPORT	Rod/Strut,stabiliser	S051289	
	2007.08-2014.01	Rear Axle Left	Saloon RWD 156985		Rod/Strut,stabiliser	S050306	
2007.08-2014.01	Rear Axle Right	Saloon RWD 156985		Rod/Strut,stabiliser	S050307		
CL500							
5.0 (225 kw)	1999.09-2006.12	Front Axle Left Upper	Coupe RWD 113960		Track Control Arm	S060241	
	1999.09-2006.12	Front Axle Left Lower Outer	Coupe RWD 113960		Track Control Arm	S060239	
	1999.09-2006.12	Front Axle Right Upper	Coupe RWD 113960		Track Control Arm	S060242	
	1999.09-2006.12	Front Axle Right Lower Outer	Coupe RWD 113960		Track Control Arm	S060240	
	1999.09-2006.12	Front Axle Left & Right Lower Inner	Coupe RWD 113960		Track Control Arm	S062081	
	1999.09-2006.12	Rear Axle Left & Right Lower Inner	Coupe RWD 113960		Track Control Arm	S060250	
	1999.09-2006.12	Rear Axle Left & Right Upper Inner	Coupe RWD 113960		Track Control Arm	S060248	
	1999.09-2006.12	Rear Axle Left & Right Upper Outer	Coupe RWD 113960		Track Control Arm	S060247	
	1999.09-2006.12	Front Axle Left & Right Lower Inner	Coupe RWD 113960		Ball Joint	S080136	
	1999.09-2006.12	Front Axle Left & Right Upper	Coupe RWD 113960		Control Arm Bushing	510507	
	1999.09-2006.12	Front Axle Left & Right Lower Inner	Coupe RWD 113960		Control Arm Bushing	510557	
	1999.09-2006.12	Front Axle Left & Right Lower Outer	Coupe RWD 113960		Control Arm Bushing	510498	
	1999.09-2006.12	Rear Axle Left & Right Upper	Coupe RWD 113960		Control Arm Bushing	510499	
	1999.09-2006.12	Front Axle Left & Right Lower Inner	Coupe RWD 113960		Control Arm Bushing Kit	510558S	
	1999.09-2006.12	Front Axle Left & Right	Coupe RWD 113960		Tie Rod Axle Joint	S030853	
	1999.09-2006.12	Front Axle Left & Right	Coupe RWD 113960		Tie Rod End	S070298	
	1999.09-2006.12	Front Axle	Coupe RWD 113960		Steering Rack Bellow Kit	540188S	
CL55 AMG							
5.4 (368 kw)	2002.08-2006.12	Front Axle Left Upper	Coupe RWD 113991		Track Control Arm	S060241	
	2002.08-2006.12	Front Axle Right Upper	Coupe RWD 113991		Track Control Arm	S060242	
	2002.08-2006.12	Front Axle Left & Right Lower Inner	Coupe RWD 113991		Track Control Arm	S062081	
	2002.08-2006.12	Rear Axle Left & Right Lower Inner	Coupe RWD 113991		Track Control Arm	S060250	
	2002.08-2006.12	Front Axle Left & Right Lower Inner	Coupe RWD 113991		Ball Joint	S080136	
	2002.08-2006.12	Front Axle Left & Right Upper	Coupe RWD 113991		Control Arm Bushing	510507	
	2002.08-2006.12	Front Axle Left & Right Lower Inner	Coupe RWD 113991		Control Arm Bushing	510557	
	2002.08-2006.12	Front Axle Left & Right Lower Outer	Coupe RWD 113991		Control Arm Bushing	510498	
	2002.08-2006.12	Front Axle Left & Right Lower Inner	Coupe RWD 113991		Control Arm Bushing Kit	510558S	
	2002.08-2006.12	Front Axle Left & Right	Coupe RWD 113991		Tie Rod Axle Joint	S030853	
	2002.08-2006.12	Front Axle Left & Right	Coupe RWD 113991		Tie Rod End	S070298	
	2002.08-2006.12	Front Axle	Coupe RWD 113991		Steering Rack Bellow Kit	540188S	
	CL600						
5.8 (270 kw)	1999.09-2002.12	Front Axle Left Upper	Coupe RWD 137970		Track Control Arm	S060241	
	1999.09-2002.12	Front Axle Left Lower Outer	Coupe RWD 137970		Track Control Arm	S060239	
	1999.09-2002.12	Front Axle Right Upper	Coupe RWD 137970		Track Control Arm	S060242	
	1999.09-2002.12	Front Axle Right Lower Outer	Coupe RWD 137970		Track Control Arm	S060240	
	1999.09-2002.12	Front Axle Left & Right Lower Inner	Coupe RWD 137970		Track Control Arm	S062081	
	1999.09-2002.12	Rear Axle Left & Right Lower Inner	Coupe RWD 137970		Track Control Arm	S060250	
	1999.09-2002.12	Rear Axle Left & Right Upper Inner	Coupe RWD 137970		Track Control Arm	S060248	
	1999.09-2002.12	Rear Axle Left & Right Upper Outer	Coupe RWD 137970		Track Control Arm	S060247	
	1999.09-2002.12	Front Axle Left & Right Lower Inner	Coupe RWD 137970		Ball Joint	S080136	
	1999.09-2002.12	Front Axle Left & Right Upper	Coupe RWD 137970		Control Arm Bushing	510507	
	1999.09-2002.12	Front Axle Left & Right Lower Inner	Coupe RWD 137970		Control Arm Bushing	510557	
	1999.09-2002.12	Front Axle Left & Right Lower Outer	Coupe RWD 137970		Control Arm Bushing	510498	
	1999.09-2002.12	Rear Axle Left & Right Upper	Coupe RWD 137970		Control Arm Bushing	510499	
	1999.09-2002.12	Front Axle Left & Right Lower Inner	Coupe RWD 137970		Control Arm Bushing Kit	510558S	
	1999.09-2002.12	Front Axle Left & Right	Coupe RWD 137970		Tie Rod Axle Joint	S030853	
	1999.09-2002.12	Front Axle Left & Right	Coupe RWD 137970		Tie Rod End	S070298	
	1999.09-2002.12	Front Axle	Coupe RWD 137970		Steering Rack Bellow Kit	540188S	
	6.0 (290 kw)	1996.07-1999.08	Front Axle Left Upper	Coupe RWD 120982		Track Control Arm	S060267
		1996.07-1999.08	Front Axle Right Upper	Coupe RWD 120982		Track Control Arm	S060268
1996.07-1999.08		Rear Axle Left & Right Lower Inner	Coupe RWD 120982		Track Control Arm	S060249	
1996.07-1999.08		Rear Axle Left & Right Upper Inner	Coupe RWD 120982		Track Control Arm	S060271	
1996.07-1999.08		Rear Axle Left & Right Upper Outer	Coupe RWD 120982		Track Control Arm	S060272	



	 YEAR	FITTING POSITION	BODY STYLE & DRIVE TYPE & ENGINE	REMARKS	PRODUCT	GSP Ref.
MERCEDES-BENZ CL600						
6.0 (290 kw)	1996.07-1999.08	Front Axle Left & Right Lower	Coupe RWD 120982		Ball Joint	S080142
	1996.07-1999.08	Front Axle Left & Right Lower	Coupe RWD 120982		Control Arm Bushing	510428
	1996.07-1999.08	Front Axle Left & Right Lower	Coupe RWD 120982		Control Arm Bushing	510445
	1996.07-1999.08	Rear Axle Left & Right	Coupe RWD 120982		Control Arm Bushing	510500
	1996.07-1999.08	Rear Axle Left & Right Upper	Coupe RWD 120982		Control Arm Bushing	510495
	1996.07-1999.08	Rear Axle Left & Right Upper	Coupe RWD 120982		Control Arm Bushing	510499
	1996.07-1999.08	Rear Axle Left & Right Lower Outer	Coupe RWD 120982		Control Arm Bushing	510446
	1996.07-1999.08	Front Axle Left & Right Lower	Coupe RWD 120982		Control Arm Bushing Kit	510444S
	1996.07-1999.08	Front Axle Left & Right	Coupe RWD 120982		Rod Assembly	S100078
	1996.07-1999.08	Front Axle Left & Right	Coupe RWD 120982		Rod Assembly	S100191
	1996.07-1999.08	Front Axle Left & Right	Coupe RWD 120982		Tie Rod End	S070289
	1996.07-1999.08	Front Axle Left & Right	Coupe RWD 120982		Tie Rod End	S070290
	1996.07-1999.08	Front Axle Left	Coupe RWD 120982		Rod/Strut,stabiliser	S100076
	1996.07-1999.08	Front Axle Right	Coupe RWD 120982		Rod/Strut,stabiliser	S100077
	1996.07-1999.08	Rear Axle Left & Right	Coupe RWD 120982		Rod/Strut,stabiliser	S050281
	1996.07-1999.08	Front Axle	Coupe RWD 120982		Stabiliser Bushing	510472
	1996.07-1999.08	Front Axle	Coupe RWD 120982		Stabiliser Bushing	512765
CL63 AMG						
6.2 (386 kw)	2006.10-2013.12	Front Axle Left Upper	Coupe RWD 156984		Track Control Arm	S061294
	2006.10-2013.12	Front Axle Left Lower Outer	Coupe RWD 156984		Track Control Arm	S060253
	2006.10-2013.12	Front Axle Right Upper	Coupe RWD 156984		Track Control Arm	S061295
	2006.10-2013.12	Front Axle Right Lower Outer	Coupe RWD 156984		Track Control Arm	S060254
	2006.10-2013.12	Rear Axle Left Lower Inner	Coupe RWD 156984		Track Control Arm	S060260
	2006.10-2013.12	Rear Axle Left Lower Outer	Coupe RWD 156984		Track Control Arm	S060258
	2006.10-2013.12	Rear Axle Right Lower Inner	Coupe RWD 156984		Track Control Arm	S060261
	2006.10-2013.12	Rear Axle Right Lower Outer	Coupe RWD 156984		Track Control Arm	S060259
	2006.10-2013.12	Front Axle Left & Right Upper	Coupe RWD 156984		Control Arm Bushing	510502
	2006.10-2013.12	Front Axle Left & Right Lower Outer	Coupe RWD 156984		Control Arm Bushing	510508
	2006.10-2013.12	Front Axle Left & Right Lower Outer	Coupe RWD 156984	Date from:2012.01,From Chassis:A02984	Control Arm Bushing	531450
	2006.10-2013.12	Rear Axle Left & Right Lower Inner	Coupe RWD 156984		Control Arm Bushing	510496
	2006.10-2013.12	Rear Axle Left & Right Lower Inner	Coupe RWD 156984		Control Arm Bushing	510497
	2006.10-2013.12	Rear Axle Left & Right Lower Outer	Coupe RWD 156984		Control Arm Bushing	510493
	2006.10-2013.12	Rear Axle Left & Right Upper Outer	Coupe RWD 156984		Control Arm Bushing	510505
	2006.10-2013.12	Rear Axle Left & Right Upper Outer	Coupe RWD 156984		Control Arm Bushing	510506
	2006.10-2013.12	Front Axle Left & Right	Coupe RWD 156984		Tie Rod End	S070302
	2006.10-2013.12	Rear Axle Left	Coupe RWD 156984		Rod/Strut,stabiliser	S050298
	2006.10-2013.12	Rear Axle Right	Coupe RWD 156984		Rod/Strut,stabiliser	S050299
CL65 AMG						
6.0 (450 kw)	2006.10-2010.12	Front Axle Left Upper	Coupe RWD 275982		Track Control Arm	S061294
	2006.10-2010.12	Front Axle Left Lower Outer	Coupe RWD 275982		Track Control Arm	S060253
	2006.10-2010.12	Front Axle Right Upper	Coupe RWD 275982		Track Control Arm	S061295
	2006.10-2010.12	Front Axle Right Lower Outer	Coupe RWD 275982		Track Control Arm	S060254
	2006.10-2010.12	Rear Axle Left Lower Inner	Coupe RWD 275982		Track Control Arm	S060260
	2006.10-2010.12	Rear Axle Right Lower Inner	Coupe RWD 275982		Track Control Arm	S060261
	2006.10-2010.12	Front Axle Left & Right Upper	Coupe RWD 275982		Control Arm Bushing	510502
	2006.10-2010.12	Front Axle Left & Right Lower Outer	Coupe RWD 275982		Control Arm Bushing	510508
	2006.10-2010.12	Rear Axle Left & Right Lower Inner	Coupe RWD 275982		Control Arm Bushing	510496
	2006.10-2010.12	Rear Axle Left & Right Lower Inner	Coupe RWD 275982		Control Arm Bushing	510497
	2006.10-2010.12	Front Axle Left & Right	Coupe RWD 275982		Tie Rod End	S070302
	2006.10-2010.12	Rear Axle Left	Coupe RWD 275982		Rod/Strut,stabiliser	S050298
	2006.10-2010.12	Rear Axle Right	Coupe RWD 275982		Rod/Strut,stabiliser	S050299
CLA180						
1.6 (90 kw)	2013.01-2019.03	Front Axle Left Lower	Coupe FWD 270910		Track Control Arm	S061677
	2013.01-2019.03	Front Axle Right Lower	Coupe FWD 270910		Track Control Arm	S061678
	2013.01-2019.03	Rear Axle Left Upper Inner	Coupe FWD 270910		Track Control Arm	S062803
	2013.01-2019.03	Rear Axle Right Upper Inner	Coupe FWD 270910		Track Control Arm	S063056
	2013.01-2019.03	Rear Axle Left & Right Lower Inner	Coupe FWD 270910		Track Control Arm	S062807
	2013.01-2019.03	Rear Axle Left & Right Upper Outer	Coupe FWD 270910		Track Control Arm	S062796
	2013.01-2019.03	Front Axle Left Lower	Coupe FWD 270910		Control Arm Bushing	532866
	2013.01-2019.03	Front Axle Right Lower	Coupe FWD 270910		Control Arm Bushing	532867
	2013.01-2019.03	Front Axle Left & Right Lower	Coupe FWD 270910		Control Arm Bushing	535310
	2013.01-2019.03	Rear Axle Left & Right Lower Inner	Coupe FWD 270910		Control Arm Bushing	535266
	2013.01-2019.03	Rear Axle Left & Right Upper Outer	Coupe FWD 270910		Control Arm Bushing	535261
	2013.01-2019.03	Front Axle Left & Right	Coupe FWD 270910		Tie Rod Axle Joint	S031088



	 YEAR	FITTING POSITION	BODY STYLE & DRIVE TYPE & ENGINE	REMARKS	PRODUCT	GSP Ref.	
MERCEDES-BENZ CLA180							
1.6 (90 kw)	2013.01-2019.03	Front Axle Left	Coupe FWD 270910		Tie Rod End	S071367	
	2013.01-2019.03	Front Axle Right	Coupe FWD 270910		Tie Rod End	S071368	
	2013.01-2019.03	Front Axle Left & Right	Coupe FWD 270910		Rod/Strut, stabiliser	S051410	
	2013.01-2019.03	Rear Axle Left & Right	Coupe FWD 270910	Date from:2013.12	Rod/Strut, stabiliser	S051251	
	2013.01-2019.03	Rear Axle Left & Right	Coupe FWD 270910	For OE no.2463200489	Rod/Strut, stabiliser	S051263	
CLA200							
1.6 (115 kw)	2013.01-2019.03	Front Axle Left Lower	Coupe FWD 270910		Track Control Arm	S061677	
	2013.01-2019.03	Front Axle Right Lower	Coupe FWD 270910		Track Control Arm	S061678	
	2013.01-2019.03	Rear Axle Left Upper Inner	Coupe FWD 270910		Track Control Arm	S062803	
	2013.01-2019.03	Rear Axle Right Upper Inner	Coupe FWD 270910		Track Control Arm	S063056	
	2013.01-2019.03	Rear Axle Left & Right Lower Inner	Coupe FWD 270910		Track Control Arm	S062807	
	2013.01-2019.03	Rear Axle Left & Right Upper Outer	Coupe FWD 270910		Track Control Arm	S062796	
	2013.01-2019.03	Front Axle Left Lower	Coupe FWD 270910		Control Arm Bushing	532866	
	2013.01-2019.03	Front Axle Right Lower	Coupe FWD 270910		Control Arm Bushing	532867	
	2013.01-2019.03	Front Axle Left & Right Lower	Coupe FWD 270910		Control Arm Bushing	535310	
	2013.01-2019.03	Rear Axle Left & Right Lower Inner	Coupe FWD 270910		Control Arm Bushing	535266	
	2013.01-2019.03	Rear Axle Left & Right Upper Outer	Coupe FWD 270910		Control Arm Bushing	535261	
	2013.01-2019.03	Front Axle Left & Right	Coupe FWD 270910		Tie Rod Axle Joint	S031088	
	2013.01-2019.03	Front Axle Left	Coupe FWD 270910		Tie Rod End	S071367	
	2013.01-2019.03	Front Axle Right	Coupe FWD 270910		Tie Rod End	S071368	
	2013.01-2019.03	Front Axle Left & Right	Coupe FWD 270910		Rod/Strut, stabiliser	S051410	
	2013.01-2019.03	Rear Axle Left & Right	Coupe FWD 270910	Date from:2013.12	Rod/Strut, stabiliser	S051251	
	2013.01-2019.03	Rear Axle Left & Right	Coupe FWD 270910	For OE no.2463200489	Rod/Strut, stabiliser	S051263	
	CLA250						
	2.0 (155 kw)	2013.07-2019.03	Front Axle Left Lower	Coupe 4WD 270920		Track Control Arm	S061677
		2013.07-2019.03	Front Axle Right Lower	Coupe 4WD 270920		Track Control Arm	S061678
2013.07-2019.03		Rear Axle Left Upper Inner	Coupe 4WD 270920		Track Control Arm	S062803	
2013.07-2019.03		Rear Axle Right Upper Inner	Coupe 4WD 270920		Track Control Arm	S063056	
2013.07-2019.03		Rear Axle Left & Right Lower Inner	Coupe 4WD 270920		Track Control Arm	S062807	
2013.07-2019.03		Rear Axle Left & Right Upper Outer	Coupe 4WD 270920		Track Control Arm	S062796	
2013.07-2019.03		Front Axle Left Lower	Coupe 4WD 270920		Control Arm Bushing	532866	
2013.07-2019.03		Front Axle Right Lower	Coupe 4WD 270920		Control Arm Bushing	532867	
2013.07-2019.03		Front Axle Left & Right Lower	Coupe 4WD 270920		Control Arm Bushing	535310	
2013.07-2019.03		Rear Axle Left & Right Lower Inner	Coupe 4WD 270920		Control Arm Bushing	535266	
2013.07-2019.03		Rear Axle Left & Right Upper Outer	Coupe 4WD 270920		Control Arm Bushing	535261	
2013.07-2019.03		Front Axle Left & Right	Coupe 4WD 270920		Tie Rod Axle Joint	S031088	
2013.07-2019.03		Front Axle Left	Coupe 4WD 270920		Tie Rod End	S071367	
2013.07-2019.03		Front Axle Right	Coupe 4WD 270920		Tie Rod End	S071368	
2013.07-2019.03		Front Axle Left & Right	Coupe 4WD 270920		Rod/Strut, stabiliser	S051410	
2013.07-2019.03		Rear Axle Left & Right	Coupe 4WD 270920	Date from:2013.12	Rod/Strut, stabiliser	S051251	
2013.07-2019.03		Rear Axle Left & Right	Coupe 4WD 270920	For OE no.2463200489	Rod/Strut, stabiliser	S051263	
2.0 (165 kw)		2019.03-	Front Axle Left Upper Outer	Coupe 4WD 260920		Control Arm Bushing	535467
		2019.03-	Front Axle Left	Coupe 4WD 260920		Tie Rod End	S071776
		2019.03-	Front Axle Right	Coupe 4WD 260920		Tie Rod End	S071777
	2019.03-	Front Axle Left & Right	Coupe 4WD 260920		Rod/Strut, stabiliser	S051359	
	2019.03-	Rear Axle Left & Right	Coupe 4WD 260920		Rod/Strut, stabiliser	S051428	
CLA45 AMG							
2.0 (265 kw)	2013.07-2019.03	Front Axle Left Lower	Coupe 4WD 133980		Track Control Arm	S061677	
	2013.07-2019.03	Front Axle Right Lower	Coupe 4WD 133980		Track Control Arm	S061678	
	2013.07-2019.03	Rear Axle Left Upper Inner	Coupe 4WD 133980		Track Control Arm	S062803	
	2013.07-2019.03	Rear Axle Right Upper Inner	Coupe 4WD 133980		Track Control Arm	S063056	
	2013.07-2019.03	Front Axle Left & Right Lower	Coupe 4WD 133980		Control Arm Bushing	535310	
	2013.07-2019.03	Rear Axle Left & Right Upper Outer	Coupe 4WD 133980		Control Arm Bushing	535261	
	2013.07-2019.03	Front Axle Left & Right	Coupe 4WD 133980		Tie Rod Axle Joint	S031088	
	2013.07-2019.03	Front Axle Left	Coupe 4WD 133980		Tie Rod End	S071367	
	2013.07-2019.03	Front Axle Right	Coupe 4WD 133980		Tie Rod End	S071368	
	2013.07-2019.03	Front Axle Left & Right	Coupe 4WD 133980		Rod/Strut, stabiliser	S051410	
	2013.07-2019.03	Rear Axle Left & Right	Coupe 4WD 133980	For OE no.2463200100	Rod/Strut, stabiliser	S051251	
	2013.07-2019.03	Rear Axle Left & Right	Coupe 4WD 133980	For OE no.2463200489	Rod/Strut, stabiliser	S051263	
	2.0 (280 kw)	2015.07-2019.03	Front Axle Left Lower	Coupe 4WD 133980		Track Control Arm	S061677
		2015.07-2019.03	Front Axle Right Lower	Coupe 4WD 133980		Track Control Arm	S061678
		2015.07-2019.03	Rear Axle Left Upper Inner	Coupe 4WD 133980		Track Control Arm	S062803
2015.07-2019.03		Rear Axle Right Upper Inner	Coupe 4WD 133980		Track Control Arm	S063056	
2015.07-2019.03		Front Axle Left & Right Lower	Coupe 4WD 133980		Control Arm Bushing	535310	



	 YEAR	FITTING POSITION	BODY STYLE & DRIVE TYPE & ENGINE	REMARKS	PRODUCT	GSP Ref.	
MERCEDES-BENZ CLA45 AMG							
2.0 (280 kw)	2015.07-2019.03	Rear Axle Left & Right Upper Outer	Coupe 4WD 133980		Control Arm Bushing	535261	
	2015.07-2019.03	Front Axle Left & Right	Coupe 4WD 133980		Tie Rod Axle Joint	S031088	
	2015.07-2019.03	Front Axle Left	Coupe 4WD 133980		Tie Rod End	S071367	
	2015.07-2019.03	Front Axle Right	Coupe 4WD 133980		Tie Rod End	S071368	
	2015.07-2019.03	Front Axle Left & Right	Coupe 4WD 133980		Rod/Strut,stabiliser	S051410	
	2015.07-2019.03	Rear Axle Left & Right	Coupe 4WD 133980	For OE no.2463200100	Rod/Strut,stabiliser	S051251	
	2015.07-2019.03	Rear Axle Left & Right	Coupe 4WD 133980	For OE no.2463200489	Rod/Strut,stabiliser	S051263	
2.0 (310 kw)	2019.07-	Front Axle Left	Coupe 4WD 139980		Tie Rod End	S071776	
	2019.07-	Front Axle Right	Coupe 4WD 139980		Tie Rod End	S071777	
	2019.07-	Front Axle Left & Right	Coupe 4WD 139980		Rod/Strut,stabiliser	S051359	
	2019.07-	Rear Axle Left & Right	Coupe 4WD 139980		Rod/Strut,stabiliser	S051428	
CLC200							
1.8 (135 kw)	2008.05-2011.06	Front Axle Left Lower Inner	Coupe RWD 271957		Track Control Arm	S060219	
	2008.05-2011.06	Front Axle Left Lower Outer	Coupe RWD 271957		Track Control Arm	S060221	
	2008.05-2011.06	Front Axle Right Lower Inner	Coupe RWD 271957		Track Control Arm	S060220	
	2008.05-2011.06	Front Axle Right Lower Outer	Coupe RWD 271957		Track Control Arm	S060222	
	2008.05-2011.06	Rear Axle Left & Right Lower Inner	Coupe RWD 271957		Track Control Arm	S060217	
	2008.05-2011.06	Rear Axle Left & Right Upper Inner	Coupe RWD 271957		Track Control Arm	S060216	
	2008.05-2011.06	Front Axle Left & Right Lower Inner	Coupe RWD 271957		Control Arm Bushing	510565	
	2008.05-2011.06	Front Axle Left & Right Lower Outer	Coupe RWD 271957		Control Arm Bushing	510491	
	2008.05-2011.06	Front Axle Left & Right Lower Outer	Coupe RWD 271957		Control Arm Bushing	531450	
	2008.05-2011.06	Rear Axle Left & Right Upper Inner	Coupe RWD 271957		Control Arm Bushing	517809	
	2008.05-2011.06	Rear Axle Left & Right Lower Outer	Coupe RWD 271957		Control Arm Bushing	510446	
	2008.05-2011.06	Rear Axle Left & Right Lower Outer	Coupe RWD 271957		Control Arm Bushing	512252	
	2008.05-2011.06	Front Axle	Coupe RWD 271957		Suspension Repair Kit	S990034SK	
	2008.05-2011.06	Front Axle Left & Right	Coupe RWD 271957		Tie Rod Axle Joint	S030853	
	2008.05-2011.06	Front Axle Left	Coupe RWD 271957		Tie Rod End	S070284	
	2008.05-2011.06	Front Axle Right	Coupe RWD 271957		Tie Rod End	S070285	
	2008.05-2011.06	Front Axle Left & Right	Coupe RWD 271957	for vehicles with standard suspension	Rod/Strut,stabiliser	S050273	
	2008.05-2011.06	Front Axle Left & Right	Coupe RWD 271957	for vehicles with sports suspension	Rod/Strut,stabiliser	S050315	
	2008.05-2011.06	Rear Axle Left	Coupe RWD 271957		Rod/Strut,stabiliser	S050302	
	2008.05-2011.06	Rear Axle Right	Coupe RWD 271957		Rod/Strut,stabiliser	S050303	
	2008.05-2011.06	Front Axle	Coupe RWD 271957		Stabiliser Bushing	512615	
	2008.05-2011.06	Rear Axle	Coupe RWD 271957		Stabiliser Bushing	530969	
	2008.05-2011.06	Front Axle	Coupe RWD 271957		Steering Boot	540343	
	CLK230						
2.3 (142 kw)	1997.04-2000.05	Front Axle Left Upper	Coupe RWD 111975		Track Control Arm	S060214	
	1997.04-2000.05	Front Axle Right Upper	Coupe RWD 111975		Track Control Arm	S060215	
	1997.04-2000.05	Rear Axle Left & Right Lower Inner	Coupe RWD 111975		Track Control Arm	S060217	
	1997.04-2000.05	Rear Axle Left & Right Upper Inner	Coupe RWD 111975		Track Control Arm	S060216	
	1997.04-2000.05	Rear Axle Left & Right Lower Outer	Coupe RWD 111975		Track Control Arm	S051055	
	1997.04-2000.05	Rear Axle Left & Right Upper Outer	Coupe RWD 111975		Track Control Arm	S060218	
	1997.04-2000.05	Front Axle Left & Right Lower	Coupe RWD 111975		Ball Joint	S080143	
	1997.04-2000.05	Front Axle Left & Right Upper	Coupe RWD 111975		Control Arm Bushing	510456	
	1997.04-2000.05	Rear Axle Left & Right Lower	Coupe RWD 111975		Control Arm Bushing	511560	
	1997.04-2000.05	Rear Axle Left & Right Upper Inner	Coupe RWD 111975		Control Arm Bushing	517809	
	1997.04-2000.05	Rear Axle Left & Right Lower Outer	Coupe RWD 111975		Control Arm Bushing	510431	
	1997.04-2000.05	Rear Axle Left & Right Lower Outer	Coupe RWD 111975		Control Arm Bushing	512252	
	1997.04-2000.05	Rear Axle Left & Right Upper Outer	Coupe RWD 111975		Control Arm Bushing	510430	
	1997.04-2000.05	Rear Axle	Coupe RWD 111975		Suspension Repair Kit	S990038SK	
	1997.04-2000.05	Front Axle Left & Right	Coupe RWD 111975		Rod Assembly	S100079	
	1997.04-2000.05	Front Axle Left & Right	Coupe RWD 111975		Tie Rod End	S070309	
	1997.04-2000.05	Rear Axle Left & Right	Coupe RWD 111975		Rod/Strut,stabiliser	S100063	
	1997.04-2000.05	Front Axle Left & Right Outer	Coupe RWD 111975		Stabiliser Bushing	511553	
	1997.04-2000.05	Rear Axle	Coupe RWD 111975		Stabiliser Bushing	517269	
	CLK320						
	3.2 (160 kw)	1997.04-2002.07	Front Axle Left Upper	Coupe RWD 112940		Track Control Arm	S060214
		1997.04-2002.07	Front Axle Right Upper	Coupe RWD 112940		Track Control Arm	S060215
1997.04-2002.07		Rear Axle Left & Right Lower Inner	Coupe RWD 112940		Track Control Arm	S060217	
1997.04-2002.07		Rear Axle Left & Right Upper Inner	Coupe RWD 112940		Track Control Arm	S060216	
1997.04-2002.07		Rear Axle Left & Right Lower Outer	Coupe RWD 112940		Track Control Arm	S051055	
1997.04-2002.07		Rear Axle Left & Right Upper Outer	Coupe RWD 112940		Track Control Arm	S060218	
1997.04-2002.07		Front Axle Left & Right Lower	Coupe RWD 112940		Ball Joint	S080143	
1997.04-2002.07		Front Axle Left & Right Upper	Coupe RWD 112940		Control Arm Bushing	510456	



	 YEAR	FITTING POSITION	BODY STYLE & DRIVE TYPE & ENGINE	REMARKS	PRODUCT	GSP Ref.
MERCEDES-BENZ CLK320						
3.2 (160 kw)						
	1997.04-2002.07	Rear Axle Left & Right Lower	Coupe RWD 112940		Control Arm Bushing	511560
	1997.04-2002.07	Rear Axle Left & Right Upper Inner	Coupe RWD 112940		Control Arm Bushing	517809
	1997.04-2002.07	Rear Axle Left & Right Lower Outer	Coupe RWD 112940		Control Arm Bushing	510431
	1997.04-2002.07	Rear Axle Left & Right Lower Outer	Coupe RWD 112940		Control Arm Bushing	512252
	1997.04-2002.07	Rear Axle Left & Right Upper Outer	Coupe RWD 112940		Control Arm Bushing	510430
	1997.04-2002.07	Rear Axle	Coupe RWD 112940		Suspension Repair Kit	S990038SK
	1997.04-2002.07	Front Axle Left & Right	Coupe RWD 112940		Rod Assembly	S100183
	1997.04-2002.07	Front Axle Left & Right	Coupe RWD 112940		Tie Rod End	S070309
	1997.04-2002.07	Rear Axle Left & Right	Coupe RWD 112940		Rod/Strut, stabiliser	S100063
	1997.04-2002.07	Front Axle Left & Right	Coupe RWD 112940		Stabiliser Bushing	530744
	1997.04-2002.07	Front Axle Left & Right Outer	Coupe RWD 112940		Stabiliser Bushing	511553
	1997.04-2002.07	Rear Axle	Coupe RWD 112940		Stabiliser Bushing	517269
	1997.04-2002.07	Front Axle	Coupe RWD 112940		Stabiliser Bushing Kit	519452S
	2003.01-2005.12	Front Axle Left Lower Inner	Cabriolet RWD 112955		Track Control Arm	S060219
	2003.01-2005.12	Front Axle Left Lower Outer	Cabriolet RWD 112955		Track Control Arm	S060221
	2003.01-2005.12	Front Axle Right Lower Inner	Cabriolet RWD 112955		Track Control Arm	S060220
	2003.01-2005.12	Front Axle Right Lower Outer	Cabriolet RWD 112955		Track Control Arm	S060222
	2003.01-2005.12	Rear Axle Left & Right Lower Inner	Cabriolet RWD 112955		Track Control Arm	S060217
	2003.01-2005.12	Rear Axle Left & Right Upper Inner	Cabriolet RWD 112955		Track Control Arm	S060216
	2003.01-2005.12	Rear Axle Left & Right Upper Outer	Cabriolet RWD 112955		Track Control Arm	S060218
	2003.01-2005.12	Front Axle Left & Right Lower Inner	Cabriolet RWD 112955		Control Arm Bushing	510565
	2003.01-2005.12	Front Axle Left & Right Lower Outer	Cabriolet RWD 112955		Control Arm Bushing	510491
	2003.01-2005.12	Front Axle Left & Right Lower Outer	Cabriolet RWD 112955		Control Arm Bushing	531450
	2003.01-2005.12	Rear Axle Left & Right Lower	Cabriolet RWD 112955		Control Arm Bushing	511560
	2003.01-2005.12	Rear Axle Left & Right Upper Inner	Cabriolet RWD 112955		Control Arm Bushing	517809
	2003.01-2005.12	Rear Axle Left & Right Lower Outer	Cabriolet RWD 112955		Control Arm Bushing	510431
	2003.01-2005.12	Rear Axle Left & Right Lower Outer	Cabriolet RWD 112955		Control Arm Bushing	510446
	2003.01-2005.12	Rear Axle Left & Right Lower Outer	Cabriolet RWD 112955		Control Arm Bushing	512252
	2003.01-2005.12	Rear Axle Left & Right Upper Outer	Cabriolet RWD 112955		Control Arm Bushing	510430
	2003.01-2005.12	Front Axle	Cabriolet RWD 112955	for vehicles without sports suspension	Suspension Repair Kit	S990006SK
	2003.01-2005.12	Front Axle	Cabriolet RWD 112955		Suspension Repair Kit	S990034SK
	2003.01-2005.12	Front Axle Left & Right	Cabriolet RWD 112955		Tie Rod Axle Joint	S030853
	2003.01-2005.12	Front Axle Left	Cabriolet RWD 112955		Tie Rod End	S070284
	2003.01-2005.12	Front Axle Right	Cabriolet RWD 112955		Tie Rod End	S070285
	2003.01-2005.12	Front Axle Left & Right	Cabriolet RWD 112955		Rod/Strut, stabiliser	S050273
	2003.01-2005.12	Front Axle Left & Right	Cabriolet RWD 112955	for vehicles with sports suspension	Rod/Strut, stabiliser	S050315
	2003.01-2005.12	Rear Axle Left	Cabriolet RWD 112955		Rod/Strut, stabiliser	S050302
	2003.01-2005.12	Rear Axle Right	Cabriolet RWD 112955		Rod/Strut, stabiliser	S050303
	2003.01-2005.12	Front Axle	Cabriolet RWD 112955		Stabiliser Bushing	512615
	2003.01-2005.12	Rear Axle	Cabriolet RWD 112955	Inner Diameter: 15mm	Stabiliser Bushing	530969
	2003.01-2005.12	Rear Axle	Cabriolet RWD 112955	VIN to T 000994, for vehicles with sports suspension	Stabiliser Bushing	530973
	2003.01-2005.12	Front Axle	Cabriolet RWD 112955		Steering Boot	540343
	2003.01-2005.12	Front Axle	Cabriolet RWD 112955	Vehicle Identification Number(VIN) until F 167229	Steering Rack Bellow Kit	540343S
CLK350						
3.5 (200 kw)						
	2005.03-2010.03	Front Axle Left Lower Inner	Cabriolet RWD 272960		Track Control Arm	S060219
	2005.03-2010.03	Front Axle Left Lower Outer	Cabriolet RWD 272960		Track Control Arm	S060221
	2005.03-2010.03	Front Axle Right Lower Inner	Cabriolet RWD 272960		Track Control Arm	S060220
	2005.03-2010.03	Front Axle Right Lower Outer	Cabriolet RWD 272960		Track Control Arm	S060222
	2005.03-2010.03	Rear Axle Left & Right Lower Inner	Cabriolet RWD 272960		Track Control Arm	S060217
	2005.03-2010.03	Rear Axle Left & Right Upper Inner	Cabriolet RWD 272960		Track Control Arm	S060216
	2005.03-2010.03	Front Axle Left & Right Lower Inner	Cabriolet RWD 272960		Control Arm Bushing	510565
	2005.03-2010.03	Front Axle Left & Right Lower Outer	Cabriolet RWD 272960		Control Arm Bushing	510491
	2005.03-2010.03	Front Axle Left & Right Lower Outer	Cabriolet RWD 272960		Control Arm Bushing	531450
	2005.03-2010.03	Rear Axle Left & Right Upper Inner	Cabriolet RWD 272960		Control Arm Bushing	517809
	2005.03-2010.03	Rear Axle Left & Right Lower Outer	Cabriolet RWD 272960		Control Arm Bushing	510446
	2005.03-2010.03	Rear Axle Left & Right Lower Outer	Cabriolet RWD 272960		Control Arm Bushing	512252
	2005.03-2010.03	Front Axle	Cabriolet RWD 272960		Suspension Repair Kit	S990034SK
	2005.03-2010.03	Front Axle Left & Right	Cabriolet RWD 272960		Tie Rod Axle Joint	S030853
	2005.03-2010.03	Front Axle Left	Cabriolet RWD 272960		Tie Rod End	S070284
	2005.03-2010.03	Front Axle Right	Cabriolet RWD 272960		Tie Rod End	S070285
	2005.03-2010.03	Front Axle Left & Right	Cabriolet RWD 272960		Rod/Strut, stabiliser	S050273
	2005.03-2010.03	Front Axle Left & Right	Cabriolet RWD 272960	for vehicles with sports suspension	Rod/Strut, stabiliser	S050315
	2005.03-2010.03	Rear Axle Left	Cabriolet RWD 272960		Rod/Strut, stabiliser	S050302
	2005.03-2010.03	Rear Axle Right	Cabriolet RWD 272960		Rod/Strut, stabiliser	S050303



	 YEAR	FITTING POSITION	BODY STYLE & DRIVE TYPE & ENGINE	REMARKS	PRODUCT	GSP Ref.	
MERCEDES-BENZ CLK350							
3.5 (200 kw)	2005.03-2010.03	Rear Axle	Cabriolet RWD 272960		Stabiliser Bushing	530969	
	2005.03-2010.03	Front Axle	Cabriolet RWD 272960		Steering Boot	540343	
	2005.03-2010.03	Front Axle	Cabriolet RWD 272960	Vehicle Identification Number(VIN)until F 167229	Steering Rack Bellow Kit	540343S	
CLK430							
4.3 (205 kw)	1997.04-2003.07	Front Axle Left Upper	Coupe RWD 113943		Track Control Arm	S060214	
	1997.04-2003.07	Front Axle Right Upper	Coupe RWD 113943		Track Control Arm	S060215	
	1997.04-2003.07	Rear Axle Left & Right Lower Inner	Coupe RWD 113943		Track Control Arm	S060217	
	1997.04-2003.07	Rear Axle Left & Right Upper Inner	Coupe RWD 113943		Track Control Arm	S060216	
	1997.04-2003.07	Rear Axle Left & Right Lower Outer	Coupe RWD 113943		Track Control Arm	S051055	
	1997.04-2003.07	Rear Axle Left & Right Upper Outer	Coupe RWD 113943		Track Control Arm	S060218	
	1997.04-2003.07	Front Axle Left & Right Lower	Coupe RWD 113943		Ball Joint	S080143	
	1997.04-2003.07	Front Axle Left & Right Upper	Coupe RWD 113943		Control Arm Bushing	510456	
	1997.04-2003.07	Rear Axle Left & Right Lower	Coupe RWD 113943		Control Arm Bushing	511560	
	1997.04-2003.07	Rear Axle Left & Right Upper Inner	Coupe RWD 113943		Control Arm Bushing	517809	
	1997.04-2003.07	Rear Axle Left & Right Lower Outer	Coupe RWD 113943		Control Arm Bushing	510431	
	1997.04-2003.07	Rear Axle Left & Right Lower Outer	Coupe RWD 113943		Control Arm Bushing	512252	
	1997.04-2003.07	Rear Axle Left & Right Upper Outer	Coupe RWD 113943		Control Arm Bushing	510430	
	1997.04-2003.07	Rear Axle	Coupe RWD 113943		Suspension Repair Kit	S990038SK	
	1997.04-2003.07	Front Axle Left & Right	Coupe RWD 113943		Rod Assembly	S100183	
	1997.04-2003.07	Front Axle Left & Right	Coupe RWD 113943		Tie Rod End	S070309	
	1997.04-2003.07	Rear Axle Left & Right	Coupe RWD 113943		Rod/Strut,stabiliser	S100063	
	1997.04-2003.07	Front Axle Left & Right Outer	Coupe RWD 113943		Stabiliser Bushing	511553	
	1997.04-2003.07	Rear Axle	Coupe RWD 113943		Stabiliser Bushing	517269	
	CLK500						
5.0 (225 kw)	2002.06-2009.05	Front Axle Left Lower Inner	Coupe RWD 113968		Track Control Arm	S060219	
	2002.06-2009.05	Front Axle Left Lower Outer	Coupe RWD 113968		Track Control Arm	S060221	
	2002.06-2009.05	Front Axle Right Lower Inner	Coupe RWD 113968		Track Control Arm	S060220	
	2002.06-2009.05	Front Axle Right Lower Outer	Coupe RWD 113968		Track Control Arm	S060222	
	2002.06-2009.05	Rear Axle Left & Right Lower Inner	Coupe RWD 113968		Track Control Arm	S060217	
	2002.06-2009.05	Rear Axle Left & Right Upper Inner	Coupe RWD 113968		Track Control Arm	S060216	
	2002.06-2009.05	Rear Axle Left & Right Upper Outer	Coupe RWD 113968		Track Control Arm	S060218	
	2002.06-2009.05	Front Axle Left & Right Lower Inner	Coupe RWD 113968		Control Arm Bushing	510565	
	2002.06-2009.05	Front Axle Left & Right Lower Outer	Coupe RWD 113968		Control Arm Bushing	510491	
	2002.06-2009.05	Front Axle Left & Right Lower Outer	Coupe RWD 113968		Control Arm Bushing	531450	
	2002.06-2009.05	Rear Axle Left & Right Lower	Coupe RWD 113968		Control Arm Bushing	511560	
	2002.06-2009.05	Rear Axle Left & Right Upper Inner	Coupe RWD 113968		Control Arm Bushing	517809	
	2002.06-2009.05	Rear Axle Left & Right Lower Outer	Coupe RWD 113968		Control Arm Bushing	510431	
	2002.06-2009.05	Rear Axle Left & Right Lower Outer	Coupe RWD 113968		Control Arm Bushing	510446	
	2002.06-2009.05	Rear Axle Left & Right Lower Outer	Coupe RWD 113968		Control Arm Bushing	512252	
	2002.06-2009.05	Rear Axle Left & Right Upper Outer	Coupe RWD 113968		Control Arm Bushing	510430	
	2002.06-2009.05	Front Axle	Coupe RWD 113968	for vehicles without sports suspension	Suspension Repair Kit	S990006SK	
	2002.06-2009.05	Front Axle	Coupe RWD 113968		Suspension Repair Kit	S990034SK	
	2002.06-2009.05	Front Axle Left & Right	Coupe RWD 113968		Tie Rod Axle Joint	S030853	
	2002.06-2009.05	Front Axle Left	Coupe RWD 113968		Tie Rod End	S070284	
	2002.06-2009.05	Front Axle Right	Coupe RWD 113968		Tie Rod End	S070285	
	2002.06-2009.05	Front Axle Left & Right	Coupe RWD 113968		Tie Rod End	S070824	
	2002.06-2009.05	Front Axle Left & Right	Coupe RWD 113968		Tie Rod End	S070866	
	2002.06-2009.05	Front Axle Left & Right	Coupe RWD 113968		Rod/Strut,stabiliser	S050273	
	2002.06-2009.05	Front Axle Left & Right	Coupe RWD 113968	for vehicles with sports suspension	Rod/Strut,stabiliser	S050315	
	2002.06-2009.05	Rear Axle Left	Coupe RWD 113968		Rod/Strut,stabiliser	S050302	
	2002.06-2009.05	Rear Axle Right	Coupe RWD 113968		Rod/Strut,stabiliser	S050303	
	2002.06-2009.05	Front Axle	Coupe RWD 113968		Stabiliser Bushing	512614	
	2002.06-2009.05	Front Axle	Coupe RWD 113968		Stabiliser Bushing	512615	
	2002.06-2009.05	Rear Axle	Coupe RWD 113968	Inner Diameter:15mm	Stabiliser Bushing	530969	
	2002.06-2009.05	Rear Axle	Coupe RWD 113968	Country-spec. model:USA	Stabiliser Bushing	530970	
	2002.06-2009.05	Rear Axle	Coupe RWD 113968	VIN to F 07 1028,for vehicles with sports suspension	Stabiliser Bushing	530973	
	2002.06-2009.05	Front Axle	Coupe RWD 113968		Steering Boot	540343	
	2002.06-2009.05	Front Axle	Coupe RWD 113968	Vehicle Identification Number(VIN)until F 167229	Steering Rack Bellow Kit	540343S	
	CLK55 AMG						
	5.4 (270 kw)	2002.06-2006.05	Front Axle Left Lower Inner	Coupe RWD 113987		Track Control Arm	S060219
		2002.06-2006.05	Front Axle Left Lower Outer	Coupe RWD 113987		Track Control Arm	S060221
		2002.06-2006.05	Front Axle Right Lower Inner	Coupe RWD 113987		Track Control Arm	S060220
		2002.06-2006.05	Front Axle Right Lower Outer	Coupe RWD 113987		Track Control Arm	S060222
		2002.06-2006.05	Rear Axle Left & Right Lower Inner	Coupe RWD 113987		Track Control Arm	S060217



	 YEAR	FITTING POSITION	BODY STYLE & DRIVE TYPE & ENGINE	REMARKS	PRODUCT	GSP Ref.
MERCEDES-BENZ CLK55 AMG						
5.4 (270 kw)						
	2002.06-2006.05	Rear Axle Left & Right Upper Inner	Coupe RWD 113987		Track Control Arm	S060216
	2002.06-2006.05	Rear Axle Left & Right Upper Outer	Coupe RWD 113987		Track Control Arm	S060218
	2002.06-2006.05	Front Axle Left & Right Lower Inner	Coupe RWD 113987		Control Arm Bushing	510565
	2002.06-2006.05	Rear Axle Left & Right Lower	Coupe RWD 113987		Control Arm Bushing	511560
	2002.06-2006.05	Rear Axle Left & Right Upper Inner	Coupe RWD 113987		Control Arm Bushing	517809
	2002.06-2006.05	Rear Axle Left & Right Lower Outer	Coupe RWD 113987		Control Arm Bushing	510431
	2002.06-2006.05	Rear Axle Left & Right Lower Outer	Coupe RWD 113987		Control Arm Bushing	512252
	2002.06-2006.05	Rear Axle Left & Right Upper Outer	Coupe RWD 113987		Control Arm Bushing	510430
	2002.06-2006.05	Front Axle	Coupe RWD 113987	for vehicles without sports suspension	Suspension Repair Kit	S990006SK
	2002.06-2006.05	Front Axle	Coupe RWD 113987		Suspension Repair Kit	S990034SK
	2002.06-2006.05	Front Axle Left & Right	Coupe RWD 113987		Tie Rod Axle Joint	S030853
	2002.06-2006.05	Front Axle Left	Coupe RWD 113987		Tie Rod End	S070284
	2002.06-2006.05	Front Axle Right	Coupe RWD 113987		Tie Rod End	S070285
	2002.06-2006.05	Front Axle Left & Right	Coupe RWD 113987		Rod/Strut, stabiliser	S050315
	2002.06-2006.05	Rear Axle Left	Coupe RWD 113987		Rod/Strut, stabiliser	S050302
	2002.06-2006.05	Rear Axle Right	Coupe RWD 113987		Rod/Strut, stabiliser	S050303
	2002.06-2006.05	Front Axle	Coupe RWD 113987		Stabiliser Bushing	512615
	2002.06-2006.05	Front Axle	Coupe RWD 113987		Steering Boot	540343
	2002.06-2006.05	Front Axle	Coupe RWD 113987	Vehicle Identification Number(VIN) until F 167229	Steering Rack Bellow Kit	540343S
CLS350						
3.5 (200 kw)						
	2004.07-2010.12	Front Axle Left Upper	Coupe RWD 272964		Track Control Arm	S060223
	2004.07-2010.12	Front Axle Left Lower Inner	Coupe RWD 272964		Track Control Arm	S060225
	2004.07-2010.12	Front Axle Left Lower Outer	Coupe RWD 272964		Track Control Arm	S060227
	2004.07-2010.12	Front Axle Right Upper	Coupe RWD 272964		Track Control Arm	S060224
	2004.07-2010.12	Front Axle Right Lower Inner	Coupe RWD 272964		Track Control Arm	S060226
	2004.07-2010.12	Front Axle Right Lower Outer	Coupe RWD 272964		Track Control Arm	S060228
	2004.07-2010.12	Rear Axle Left Upper Inner	Coupe RWD 272964		Track Control Arm	S060231
	2004.07-2010.12	Rear Axle Left Upper Outer	Coupe RWD 272964		Track Control Arm	S060229
	2004.07-2010.12	Rear Axle Right Upper Inner	Coupe RWD 272964		Track Control Arm	S060232
	2004.07-2010.12	Rear Axle Right Upper Outer	Coupe RWD 272964		Track Control Arm	S060230
	2004.07-2010.12	Rear Axle Left & Right Lower Inner	Coupe RWD 272964		Track Control Arm	S060233
	2004.07-2010.12	Front Axle Left & Right Upper	Coupe RWD 272964		Ball Joint	S080145
	2004.07-2010.12	Front Axle Left & Right Lower Inner	Coupe RWD 272964	for OE No.211 330 81 07	Ball Joint	S080134
	2004.07-2010.12	Front Axle Left & Right Lower Inner	Coupe RWD 272964		Ball Joint	S080136
	2004.07-2010.12	Front Axle Left & Right Upper	Coupe RWD 272964		Control Arm Bushing	510529
	2004.07-2010.12	Front Axle Left & Right Lower Inner	Coupe RWD 272964		Control Arm Bushing	518119
	2004.07-2010.12	Front Axle Left & Right Lower Inner	Coupe RWD 272964		Control Arm Bushing	518120
	2004.07-2010.12	Front Axle Left & Right Lower Outer	Coupe RWD 272964		Control Arm Bushing	510491
	2004.07-2010.12	Front Axle Left & Right Lower Outer	Coupe RWD 272964		Control Arm Bushing	510518
	2004.07-2010.12	Front Axle Left & Right Lower Outer	Coupe RWD 272964		Control Arm Bushing	530133
	2004.07-2010.12	Front Axle Left & Right Lower Outer	Coupe RWD 272964		Control Arm Bushing	531450
	2004.07-2010.12	Rear Axle Left & Right Lower Inner	Coupe RWD 272964		Control Arm Bushing	530527
	2004.07-2010.12	Rear Axle Left & Right Upper Inner	Coupe RWD 272964		Control Arm Bushing	510521
	2004.07-2010.12	Rear Axle Left & Right Upper Outer	Coupe RWD 272964		Control Arm Bushing	510522
	2004.07-2010.12	Front Axle	Coupe RWD 272964		Suspension Repair Kit	S990007SK
	2004.07-2010.12	Front Axle	Coupe RWD 272964		Suspension Repair Kit	S990035SK
	2004.07-2010.12	Front Axle	Coupe RWD 272964		Suspension Repair Kit	S990039SK
	2004.07-2010.12	Rear Axle	Coupe RWD 272964		Suspension Repair Kit	S990056SK
	2004.07-2010.12	Front Axle Left & Right	Coupe RWD 272964		Tie Rod Axle Joint	S030853
	2004.07-2010.12	Front Axle Left	Coupe RWD 272964		Tie Rod End	S070286
	2004.07-2010.12	Front Axle Right	Coupe RWD 272964		Tie Rod End	S070287
	2004.07-2010.12	Front Axle Left	Coupe RWD 272964		Rod/Strut, stabiliser	510516
	2004.07-2010.12	Front Axle Right	Coupe RWD 272964		Rod/Strut, stabiliser	510515
	2004.07-2010.12	Front Axle	Coupe RWD 272964		Stabiliser Bushing	510514
	2004.07-2010.12	Front Axle	Coupe RWD 272964	Vehicle Identification Number(VIN) until A 047016	Steering Rack Bellow Kit	540204S
3.5 (225 kw)						
	2011.01-2014.08	Rear Axle Left Upper Inner	Coupe RWD 276952		Track Control Arm	S063227
	2011.01-2014.08	Rear Axle Left Lower Outer	Coupe RWD 276952		Track Control Arm	S061566
	2011.01-2014.08	Rear Axle Left Upper Outer	Coupe RWD 276952		Track Control Arm	S062798
	2011.01-2014.08	Rear Axle Right Upper Inner	Coupe RWD 276952		Track Control Arm	S063228
	2011.01-2014.08	Rear Axle Right Lower Outer	Coupe RWD 276952		Track Control Arm	S061567
	2011.01-2014.08	Rear Axle Right Upper Outer	Coupe RWD 276952		Track Control Arm	S062797
	2011.01-2014.08	Rear Axle Left & Right Lower Inner	Coupe RWD 276952		Track Control Arm	S062799
	2011.01-2014.08	Front Axle Left & Right Lower Outer	Coupe RWD 276952		Ball Joint	S080671
	2011.01-2014.08	Rear Axle Left & Right Upper	Coupe RWD 276952		Control Arm Bushing	532971



	 YEAR	FITTING POSITION	BODY STYLE & DRIVE TYPE & ENGINE	REMARKS	PRODUCT	GSP Ref.
MERCEDES-BENZ						
CLS350						
3.5 (225 kw)	2011.01-2014.08	Rear Axle Left & Right Lower Inner	Coupe RWD 276952		Control Arm Bushing	530527
	2011.01-2014.08	Rear Axle Left & Right Upper Inner	Coupe RWD 276952		Control Arm Bushing	516563
	2011.01-2014.08	Rear Axle Left & Right Upper Inner	Coupe RWD 276952		Control Arm Bushing	530504
	2011.01-2014.08	Rear Axle Left & Right Upper Inner	Coupe RWD 276952		Control Arm Bushing	533480
	2011.01-2014.08	Rear Axle Left & Right Lower Outer	Coupe RWD 276952		Control Arm Bushing	516552
	2011.01-2014.08	Rear Axle Left & Right Lower Outer	Coupe RWD 276952		Control Arm Bushing	516553
	2011.01-2014.08	Front Axle Left & Right	Coupe RWD 276952		Tie Rod Axle Joint	S031011
	2011.01-2014.08	Front Axle Left	Coupe RWD 276952		Tie Rod End	S070998
	2011.01-2014.08	Front Axle Right	Coupe RWD 276952		Tie Rod End	S070997
	2011.01-2014.08	Front Axle Left	Coupe RWD 276952		Rod/Strut, stabiliser	S050804
	2011.01-2014.08	Front Axle Right	Coupe RWD 276952		Rod/Strut, stabiliser	S050803
	2011.01-2014.08	Rear Axle Left	Coupe RWD 276952		Rod/Strut, stabiliser	S050306
	2011.01-2014.08	Rear Axle Right	Coupe RWD 276952		Rod/Strut, stabiliser	S050307
CLS400						
3.0 (245 kw)	2014.05-2017.12	Rear Axle Left Upper Inner	Coupe RWD 276820		Track Control Arm	S063227
	2014.05-2017.12	Rear Axle Left Lower Outer	Coupe RWD 276820		Track Control Arm	S061566
	2014.05-2017.12	Rear Axle Right Upper Inner	Coupe RWD 276820		Track Control Arm	S063228
	2014.05-2017.12	Rear Axle Right Lower Outer	Coupe RWD 276820		Track Control Arm	S061567
	2014.05-2017.12	Rear Axle Left & Right Upper	Coupe RWD 276820		Control Arm Bushing	532971
	2014.05-2017.12	Rear Axle Left & Right Lower Inner	Coupe RWD 276820		Control Arm Bushing	530527
	2014.05-2017.12	Rear Axle Left & Right Upper Inner	Coupe RWD 276820		Control Arm Bushing	516563
	2014.05-2017.12	Rear Axle Left & Right Upper Inner	Coupe RWD 276820		Control Arm Bushing	530504
	2014.05-2017.12	Rear Axle Left & Right Upper Inner	Coupe RWD 276820		Control Arm Bushing	533480
	2014.05-2017.12	Rear Axle Left & Right Lower Outer	Coupe RWD 276820		Control Arm Bushing	516552
	2014.05-2017.12	Rear Axle Left & Right Lower Outer	Coupe RWD 276820		Control Arm Bushing	516553
	2014.05-2017.12	Front Axle Left & Right	Coupe RWD 276820		Tie Rod Axle Joint	S031011
	2014.05-2017.12	Front Axle Left	Coupe RWD 276820		Tie Rod End	S070998
	2014.05-2017.12	Front Axle Right	Coupe RWD 276820		Tie Rod End	S070997
	2014.05-2017.12	Front Axle Left	Coupe RWD 276820		Rod/Strut, stabiliser	S050804
	2014.05-2017.12	Front Axle Right	Coupe RWD 276820		Rod/Strut, stabiliser	S050803
	2014.05-2017.12	Rear Axle Left	Coupe RWD 276820		Rod/Strut, stabiliser	S050306
	2014.05-2017.12	Rear Axle Right	Coupe RWD 276820		Rod/Strut, stabiliser	S050307
CLS500						
5.0 (225 kw)	2004.10-2010.12	Front Axle Left Upper	Coupe RWD 113967		Track Control Arm	S060223
	2004.10-2010.12	Front Axle Left Upper	Coupe RWD 113967		Track Control Arm	S060241
	2004.10-2010.12	Front Axle Left Lower Inner	Coupe RWD 113967		Track Control Arm	S060225
	2004.10-2010.12	Front Axle Left Lower Outer	Coupe RWD 113967		Track Control Arm	S060227
	2004.10-2010.12	Front Axle Right Upper	Coupe RWD 113967		Track Control Arm	S060224
	2004.10-2010.12	Front Axle Right Lower Inner	Coupe RWD 113967		Track Control Arm	S060226
	2004.10-2010.12	Front Axle Right Lower Outer	Coupe RWD 113967		Track Control Arm	S060228
	2004.10-2010.12	Rear Axle Left Upper Inner	Coupe RWD 113967		Track Control Arm	S060231
	2004.10-2010.12	Rear Axle Left Upper Outer	Coupe RWD 113967		Track Control Arm	S060229
	2004.10-2010.12	Rear Axle Right Upper Inner	Coupe RWD 113967		Track Control Arm	S060232
	2004.10-2010.12	Rear Axle Right Upper Outer	Coupe RWD 113967		Track Control Arm	S060230
	2004.10-2010.12	Rear Axle Left & Right Lower Inner	Coupe RWD 113967		Track Control Arm	S060233
	2004.10-2010.12	Front Axle Left & Right Upper	Coupe RWD 113967		Ball Joint	S080145
	2004.10-2010.12	Front Axle Left & Right Lower Inner	Coupe RWD 113967	for OE No.211 330 81 07	Ball Joint	S080134
	2004.10-2010.12	Front Axle Left & Right Lower Inner	Coupe RWD 113967		Ball Joint	S080136
	2004.10-2010.12	Front Axle Left & Right Upper	Coupe RWD 113967		Control Arm Bushing	510507
	2004.10-2010.12	Front Axle Left & Right Upper	Coupe RWD 113967		Control Arm Bushing	510529
	2004.10-2010.12	Front Axle Left & Right Lower Inner	Coupe RWD 113967		Control Arm Bushing	518119
	2004.10-2010.12	Front Axle Left & Right Lower Inner	Coupe RWD 113967		Control Arm Bushing	518120
	2004.10-2010.12	Front Axle Left & Right Lower Outer	Coupe RWD 113967		Control Arm Bushing	510491
	2004.10-2010.12	Front Axle Left & Right Lower Outer	Coupe RWD 113967		Control Arm Bushing	510518
	2004.10-2010.12	Front Axle Left & Right Lower Outer	Coupe RWD 113967		Control Arm Bushing	530133
	2004.10-2010.12	Front Axle Left & Right Lower Outer	Coupe RWD 113967		Control Arm Bushing	531450
	2004.10-2010.12	Rear Axle Left & Right Lower Inner	Coupe RWD 113967		Control Arm Bushing	530527
	2004.10-2010.12	Rear Axle Left & Right Upper Inner	Coupe RWD 113967		Control Arm Bushing	510521
	2004.10-2010.12	Rear Axle Left & Right Upper Outer	Coupe RWD 113967		Control Arm Bushing	510522
	2004.10-2010.12	Front Axle	Coupe RWD 113967		Suspension Repair Kit	S990007SK
	2004.10-2010.12	Front Axle	Coupe RWD 113967		Suspension Repair Kit	S990035SK
	2004.10-2010.12	Front Axle	Coupe RWD 113967		Suspension Repair Kit	S990039SK
	2004.10-2010.12	Rear Axle	Coupe RWD 113967		Suspension Repair Kit	S990056SK
	2004.10-2010.12	Front Axle Left & Right	Coupe RWD 113967		Tie Rod Axle Joint	S030853



	 YEAR	FITTING POSITION	BODY STYLE & DRIVE TYPE & ENGINE	REMARKS	PRODUCT	GSP Ref.
MERCEDES-BENZ CLS500						
5.0 (225 kw)	2004.10-2010.12	Front Axle Left	Coupe RWD 113967		Tie Rod End	S070286
	2004.10-2010.12	Front Axle Right	Coupe RWD 113967		Tie Rod End	S070287
	2004.10-2010.12	Front Axle Left & Right	Coupe RWD 113967		Tie Rod End	S070298
	2004.10-2010.12	Front Axle Left	Coupe RWD 113967		Rod/Strut, stabiliser	510516
	2004.10-2010.12	Front Axle Right	Coupe RWD 113967		Rod/Strut, stabiliser	510515
	2004.10-2010.12	Front Axle	Coupe RWD 113967		Stabiliser Bushing	510514
	2004.10-2010.12	Front Axle	Coupe RWD 113967	for left-hand drive vehicles, for right-hand drive vehicles	Steering Rack Bellow Kit	540204S
5.5 (285 kw)	2006.04-2011.12	Front Axle Left Upper	Coupe RWD 273960		Track Control Arm	S060223
	2006.04-2011.12	Front Axle Left Lower Inner	Coupe RWD 273960		Track Control Arm	S060225
	2006.04-2011.12	Front Axle Right Upper	Coupe RWD 273960		Track Control Arm	S060224
	2006.04-2011.12	Front Axle Right Lower Inner	Coupe RWD 273960		Track Control Arm	S060226
	2006.04-2011.12	Rear Axle Left Upper Inner	Coupe RWD 273960		Track Control Arm	S060231
	2006.04-2011.12	Rear Axle Left Upper Outer	Coupe RWD 273960		Track Control Arm	S060229
	2006.04-2011.12	Rear Axle Right Upper Inner	Coupe RWD 273960		Track Control Arm	S060232
	2006.04-2011.12	Rear Axle Right Upper Outer	Coupe RWD 273960		Track Control Arm	S060230
	2006.04-2011.12	Rear Axle Left & Right Lower Inner	Coupe RWD 273960		Track Control Arm	S060233
	2006.04-2011.12	Front Axle Left & Right Upper	Coupe RWD 273960		Ball Joint	S080145
	2006.04-2011.12	Front Axle Left & Right Lower Inner	Coupe RWD 273960	for OE No.211 330 81 07	Ball Joint	S080134
	2006.04-2011.12	Front Axle Left & Right Lower Inner	Coupe RWD 273960		Ball Joint	S080136
	2006.04-2011.12	Front Axle Left & Right Upper	Coupe RWD 273960		Control Arm Bushing	510502
	2006.04-2011.12	Front Axle Left & Right Upper	Coupe RWD 273960		Control Arm Bushing	510529
	2006.04-2011.12	Front Axle Left & Right Lower Inner	Coupe RWD 273960		Control Arm Bushing	518119
	2006.04-2011.12	Front Axle Left & Right Lower Inner	Coupe RWD 273960		Control Arm Bushing	518120
	2006.04-2011.12	Front Axle Left & Right Lower Outer	Coupe RWD 273960		Control Arm Bushing	510491
	2006.04-2011.12	Front Axle Left & Right Lower Outer	Coupe RWD 273960		Control Arm Bushing	510518
	2006.04-2011.12	Front Axle Left & Right Lower Outer	Coupe RWD 273960		Control Arm Bushing	530133
	2006.04-2011.12	Front Axle Left & Right Lower Outer	Coupe RWD 273960		Control Arm Bushing	531450
	2006.04-2011.12	Rear Axle Left & Right Lower Inner	Coupe RWD 273960		Control Arm Bushing	530527
	2006.04-2011.12	Rear Axle Left & Right Upper Inner	Coupe RWD 273960		Control Arm Bushing	510521
	2006.04-2011.12	Rear Axle Left & Right Upper Outer	Coupe RWD 273960		Control Arm Bushing	510522
	2006.04-2011.12	Front Axle	Coupe RWD 273960		Suspension Repair Kit	S990007SK
	2006.04-2011.12	Front Axle	Coupe RWD 273960		Suspension Repair Kit	S990035SK
	2006.04-2011.12	Front Axle	Coupe RWD 273960		Suspension Repair Kit	S990039SK
	2006.04-2011.12	Rear Axle	Coupe RWD 273960		Suspension Repair Kit	S990056SK
	2006.04-2011.12	Front Axle Left & Right	Coupe RWD 273960		Tie Rod Axle Joint	S030853
	2006.04-2011.12	Front Axle Left	Coupe RWD 273960		Tie Rod End	S070286
	2006.04-2011.12	Front Axle Right	Coupe RWD 273960		Tie Rod End	S070287
	2006.04-2011.12	Front Axle Left	Coupe RWD 273960		Rod/Strut, stabiliser	510516
	2006.04-2011.12	Front Axle Right	Coupe RWD 273960		Rod/Strut, stabiliser	510515
	2006.04-2011.12	Front Axle	Coupe RWD 273960		Stabiliser Bushing	510514
2006.04-2011.12	Front Axle	Coupe RWD 273960	for left-hand drive vehicles, for right-hand drive vehicles	Steering Rack Bellow Kit	540204S	
CLS53 AMG						
3.0 (320 kw)	2018.05-	Front Axle Left Upper	Coupe 4WD 256930		Track Control Arm	S062802
	2018.05-	Front Axle Right Upper	Coupe 4WD 256930		Track Control Arm	S062801
	2018.05-	Rear Axle Left Upper Inner	Coupe 4WD 256930		Track Control Arm	S063227
	2018.05-	Rear Axle Right Upper Inner	Coupe 4WD 256930		Track Control Arm	S063228
	2018.05-	Front Axle Left & Right Lower Inner	Coupe 4WD 256930		Control Arm Bushing	535411
	2018.05-	Rear Axle Left & Right Upper Inner	Coupe 4WD 256930		Control Arm Bushing	530504
	2018.05-	Rear Axle Left & Right Upper Inner	Coupe 4WD 256930		Control Arm Bushing	533480
	2018.05-	Rear Axle Left & Right Lower Outer	Coupe 4WD 256930		Control Arm Bushing	516552
	2018.05-	Front Axle Left & Right	Coupe 4WD 256930		Tie Rod Axle Joint	S031025
	2018.05-	Front Axle Left	Coupe 4WD 256930		Tie Rod End	S071773
	2018.05-	Rear Axle Left	Coupe 4WD 256930		Rod/Strut, stabiliser	S051247
	2018.05-	Rear Axle Right	Coupe 4WD 256930		Rod/Strut, stabiliser	S051248
	2018.05-	Front Axle	Coupe 4WD 256930		Steering Boot	541030
	CLS55 AMG					
5.4 (350 kw)	2005.01-2010.12	Front Axle Left Upper	Coupe RWD 113990		Track Control Arm	S060223
	2005.01-2010.12	Front Axle Left Lower Inner	Coupe RWD 113990		Track Control Arm	S060225
	2005.01-2010.12	Front Axle Left Lower Outer	Coupe RWD 113990		Track Control Arm	S060227
	2005.01-2010.12	Front Axle Right Upper	Coupe RWD 113990		Track Control Arm	S060224
	2005.01-2010.12	Front Axle Right Lower Inner	Coupe RWD 113990		Track Control Arm	S060226
	2005.01-2010.12	Front Axle Right Lower Outer	Coupe RWD 113990		Track Control Arm	S060228
	2005.01-2010.12	Front Axle Left & Right Upper	Coupe RWD 113990		Ball Joint	S080145
	2005.01-2010.12	Front Axle Left & Right Lower Inner	Coupe RWD 113990	for OE No.211 330 81 07	Ball Joint	S080134



	 YEAR	FITTING POSITION	BODY STYLE & DRIVE TYPE & ENGINE	REMARKS	PRODUCT	GSP Ref.
MERCEDES-BENZ						
CLS55 AMG						
5.4 (350 kw)						
	2005.01-2010.12	Front Axle Left & Right Lower Inner	Coupe RWD 113990		Ball Joint	S080136
	2005.01-2010.12	Front Axle Left & Right Upper	Coupe RWD 113990		Control Arm Bushing	510529
	2005.01-2010.12	Front Axle Left & Right Lower Inner	Coupe RWD 113990		Control Arm Bushing	518119
	2005.01-2010.12	Front Axle Left & Right Lower Outer	Coupe RWD 113990		Control Arm Bushing	510491
	2005.01-2010.12	Front Axle Left & Right Lower Outer	Coupe RWD 113990		Control Arm Bushing	531450
	2005.01-2010.12	Front Axle	Coupe RWD 113990		Suspension Repair Kit	S990007SK
	2005.01-2010.12	Front Axle	Coupe RWD 113990		Suspension Repair Kit	S990035SK
	2005.01-2010.12	Front Axle	Coupe RWD 113990		Suspension Repair Kit	S990039SK
	2005.01-2010.12	Front Axle Left & Right	Coupe RWD 113990		Tie Rod Axle Joint	S030853
	2005.01-2010.12	Front Axle Left	Coupe RWD 113990		Tie Rod End	S070286
	2005.01-2010.12	Front Axle Right	Coupe RWD 113990		Tie Rod End	S070287
	2005.01-2010.12	Front Axle Left	Coupe RWD 113990		Rod/Strut, stabiliser	510516
	2005.01-2010.12	Front Axle Right	Coupe RWD 113990		Rod/Strut, stabiliser	510515
	2005.01-2010.12	Front Axle	Coupe RWD 113990		Stabiliser Bushing	510514
	2005.01-2010.12	Front Axle	Coupe RWD 113990	for left-hand drive vehicles, for right-hand drive vehicles	Steering Rack Bellow Kit	540204S
CLS550						
5.5 (285 kw)						
	2006.04-2011.12	Front Axle Left Upper	Coupe RWD 273960		Track Control Arm	S060223
	2006.04-2011.12	Front Axle Left Lower Inner	Coupe RWD 273960		Track Control Arm	S060225
	2006.04-2011.12	Front Axle Right Upper	Coupe RWD 273960		Track Control Arm	S060224
	2006.04-2011.12	Front Axle Right Lower Inner	Coupe RWD 273960		Track Control Arm	S060226
	2006.04-2011.12	Rear Axle Left Upper Inner	Coupe RWD 273960		Track Control Arm	S060231
	2006.04-2011.12	Rear Axle Left Upper Outer	Coupe RWD 273960		Track Control Arm	S060229
	2006.04-2011.12	Rear Axle Right Upper Inner	Coupe RWD 273960		Track Control Arm	S060232
	2006.04-2011.12	Rear Axle Right Upper Outer	Coupe RWD 273960		Track Control Arm	S060230
	2006.04-2011.12	Rear Axle Left & Right Lower Inner	Coupe RWD 273960		Track Control Arm	S060233
	2006.04-2011.12	Front Axle Left & Right Upper	Coupe RWD 273960		Ball Joint	S080145
	2006.04-2011.12	Front Axle Left & Right Lower Inner	Coupe RWD 273960	for OE No.211 330 81 07	Ball Joint	S080134
	2006.04-2011.12	Front Axle Left & Right Lower Inner	Coupe RWD 273960		Ball Joint	S080136
	2006.04-2011.12	Front Axle Left & Right Upper	Coupe RWD 273960		Control Arm Bushing	510502
	2006.04-2011.12	Front Axle Left & Right Upper	Coupe RWD 273960		Control Arm Bushing	510529
	2006.04-2011.12	Front Axle Left & Right Lower Inner	Coupe RWD 273960		Control Arm Bushing	518119
	2006.04-2011.12	Front Axle Left & Right Lower Inner	Coupe RWD 273960		Control Arm Bushing	518120
	2006.04-2011.12	Front Axle Left & Right Lower Outer	Coupe RWD 273960		Control Arm Bushing	510491
	2006.04-2011.12	Front Axle Left & Right Lower Outer	Coupe RWD 273960		Control Arm Bushing	510518
	2006.04-2011.12	Front Axle Left & Right Lower Outer	Coupe RWD 273960		Control Arm Bushing	530133
	2006.04-2011.12	Front Axle Left & Right Lower Outer	Coupe RWD 273960		Control Arm Bushing	531450
	2006.04-2011.12	Rear Axle Left & Right Lower Inner	Coupe RWD 273960		Control Arm Bushing	530527
	2006.04-2011.12	Rear Axle Left & Right Upper Inner	Coupe RWD 273960		Control Arm Bushing	510521
	2006.04-2011.12	Rear Axle Left & Right Upper Outer	Coupe RWD 273960		Control Arm Bushing	510522
	2006.04-2011.12	Front Axle	Coupe RWD 273960		Suspension Repair Kit	S990007SK
	2006.04-2011.12	Front Axle	Coupe RWD 273960		Suspension Repair Kit	S990035SK
	2006.04-2011.12	Front Axle	Coupe RWD 273960		Suspension Repair Kit	S990039SK
	2006.04-2011.12	Rear Axle	Coupe RWD 273960		Suspension Repair Kit	S990056SK
	2006.04-2011.12	Front Axle Left & Right	Coupe RWD 273960		Tie Rod Axle Joint	S030853
	2006.04-2011.12	Front Axle Left	Coupe RWD 273960		Tie Rod End	S070286
	2006.04-2011.12	Front Axle Right	Coupe RWD 273960		Tie Rod End	S070287
	2006.04-2011.12	Front Axle Left	Coupe RWD 273960		Rod/Strut, stabiliser	510516
	2006.04-2011.12	Front Axle Right	Coupe RWD 273960		Rod/Strut, stabiliser	510515
	2006.04-2011.12	Front Axle	Coupe RWD 273960		Stabiliser Bushing	510514
	2006.04-2011.12	Front Axle	Coupe RWD 273960	for left-hand drive vehicles, for right-hand drive vehicles	Steering Rack Bellow Kit	540204S
CLS63 AMG						
5.5 (386 kw)						
	2011.02-2017.12	Rear Axle Left Upper Outer	Coupe RWD 157980/157981		Track Control Arm	S062798
	2011.02-2017.12	Rear Axle Right Upper Outer	Coupe RWD 157980/157981		Track Control Arm	S062797
	2011.02-2017.12	Rear Axle Left & Right Lower Inner	Coupe RWD 157980/157981		Track Control Arm	S062799
	2011.02-2017.12	Front Axle Left & Right Lower Outer	Coupe RWD 157980/157981		Ball Joint	S080671
	2011.02-2017.12	Rear Axle Left & Right Upper	Coupe RWD 157980/157981		Control Arm Bushing	532971
	2011.02-2017.12	Rear Axle Left & Right Upper Inner	Coupe RWD 157980/157981		Control Arm Bushing	516563
	2011.02-2017.12	Rear Axle Left & Right Upper Inner	Coupe RWD 157980/157981		Control Arm Bushing	533480
	2011.02-2017.12	Front Axle Left & Right	Coupe RWD 157980/157981		Tie Rod Axle Joint	S031011
	2011.02-2017.12	Front Axle Left	Coupe RWD 157980/157981		Rod/Strut, stabiliser	S050804
	2011.02-2017.12	Front Axle Right	Coupe RWD 157980/157981		Rod/Strut, stabiliser	S050803
	2011.02-2017.12	Rear Axle Left	Coupe RWD 157980/157981		Rod/Strut, stabiliser	S050306
	2011.02-2017.12	Rear Axle Right	Coupe RWD 157980/157981		Rod/Strut, stabiliser	S050307



	 YEAR	FITTING POSITION	BODY STYLE & DRIVE TYPE & ENGINE	REMARKS	PRODUCT	GSP Ref.
MERCEDES-BENZ						
CLS63 AMG						
5.5 (410 kw)						
	2011.01-2017.12	Rear Axle Left & Right Lower Inner	Coupe RWD 157981		Track Control Arm	S062799
	2011.01-2017.12	Front Axle Left & Right Lower Outer	Coupe RWD 157981		Ball Joint	S080671
	2011.01-2017.12	Rear Axle Left & Right Upper	Coupe RWD 157981		Control Arm Bushing	532971
	2011.01-2017.12	Rear Axle Left & Right Upper Inner	Coupe RWD 157981		Control Arm Bushing	516563
	2011.01-2017.12	Rear Axle Left & Right Upper Inner	Coupe RWD 157981		Control Arm Bushing	533480
	2011.01-2017.12	Front Axle Left & Right	Coupe RWD 157981		Tie Rod Axle Joint	S031011
	2011.01-2017.12	Front Axle Left & Right	Coupe RWD 157981		Tie Rod End	S070824
	2011.01-2017.12	Front Axle Left & Right	Coupe RWD 157981		Tie Rod End	S070866
	2011.01-2017.12	Front Axle Left	Coupe RWD 157981		Rod/Strut, stabiliser	S050804
	2011.01-2017.12	Front Axle Right	Coupe RWD 157981		Rod/Strut, stabiliser	S050803
	2011.01-2017.12	Rear Axle Left	Coupe RWD 157981		Rod/Strut, stabiliser	S050306
	2011.01-2017.12	Rear Axle Right	Coupe RWD 157981		Rod/Strut, stabiliser	S050307
	2013.05-2017.12	Rear Axle Left & Right Upper Inner	Coupe 4WD 157981		Control Arm Bushing	533480
	2013.05-2017.12	Rear Axle Left & Right Upper Inner	Estate 4WD 157981		Control Arm Bushing	533480
	2013.05-2017.12	Front Axle Left & Right	Coupe 4WD 157981		Tie Rod Axle Joint	S031011
	2013.05-2017.12	Front Axle Left & Right	Estate 4WD 157981		Tie Rod Axle Joint	S031011
	2013.05-2017.12	Front Axle Left	Coupe 4WD 157981		Tie Rod End	S071739
	2013.05-2017.12	Front Axle Left	Estate 4WD 157981		Tie Rod End	S071739
	2013.05-2017.12	Front Axle Right	Coupe 4WD 157981		Tie Rod End	S071740
	2013.05-2017.12	Front Axle Right	Estate 4WD 157981		Tie Rod End	S071740
	2013.05-2017.12	Rear Axle Left	Coupe 4WD 157981		Rod/Strut, stabiliser	S050306
	2013.05-2017.12	Rear Axle Left	Estate 4WD 157981		Rod/Strut, stabiliser	S050306
	2013.05-2017.12	Rear Axle Right	Coupe 4WD 157981		Rod/Strut, stabiliser	S050307
	2013.05-2017.12	Rear Axle Right	Estate 4WD 157981		Rod/Strut, stabiliser	S050307
6.2 (378 kw)						
	2006.04-2010.12	Front Axle Left Upper	Coupe RWD 156983		Track Control Arm	S060223
	2006.04-2010.12	Front Axle Left Lower Inner	Coupe RWD 156983		Track Control Arm	S060225
	2006.04-2010.12	Front Axle Right Upper	Coupe RWD 156983		Track Control Arm	S060224
	2006.04-2010.12	Front Axle Right Lower Inner	Coupe RWD 156983		Track Control Arm	S060226
	2006.04-2010.12	Front Axle Left & Right Upper	Coupe RWD 156983		Ball Joint	S080145
	2006.04-2010.12	Front Axle Left & Right Lower Inner	Coupe RWD 156983	for OE No.211 330 81 07	Ball Joint	S080134
	2006.04-2010.12	Front Axle Left & Right Lower Inner	Coupe RWD 156983		Ball Joint	S080136
	2006.04-2010.12	Front Axle Left & Right Upper	Coupe RWD 156983		Control Arm Bushing	510529
	2006.04-2010.12	Front Axle Left & Right Lower Inner	Coupe RWD 156983		Control Arm Bushing	518119
	2006.04-2010.12	Front Axle Left & Right Lower Outer	Coupe RWD 156983		Control Arm Bushing	510491
	2006.04-2010.12	Front Axle Left & Right Lower Outer	Coupe RWD 156983		Control Arm Bushing	531450
	2006.04-2010.12	Front Axle	Coupe RWD 156983		Suspension Repair Kit	S990035SK
	2006.04-2010.12	Front Axle	Coupe RWD 156983		Suspension Repair Kit	S990039SK
	2006.04-2010.12	Front Axle Left & Right	Coupe RWD 156983		Tie Rod Axle Joint	S030853
	2006.04-2010.12	Front Axle Left	Coupe RWD 156983		Tie Rod End	S070286
	2006.04-2010.12	Front Axle Right	Coupe RWD 156983		Tie Rod End	S070287
	2006.04-2010.12	Front Axle Left	Coupe RWD 156983		Rod/Strut, stabiliser	510516
	2006.04-2010.12	Front Axle Right	Coupe RWD 156983		Rod/Strut, stabiliser	510515
	2006.04-2010.12	Front Axle	Coupe RWD 156983		Stabiliser Bushing	510514
	2006.04-2010.12	Front Axle	Coupe RWD 156983	for left-hand drive vehicles, for right-hand drive vehicles	Steering Rack Bellow Kit	540204S
E200						
2.0 (100 kw)						
	1993.06-1995.06	Front Axle Left Lower	Saloon RWD 111940	for vehicles with sports suspension	Track Control Arm	S060579
	1993.06-1995.06	Front Axle Left Lower	Saloon RWD 111940	Check to find 070222 for vehicles with sports suspension for vehicles without sports suspension	Track Control Arm	S060581
	1993.06-1995.06	Front Axle Right Lower	Saloon RWD 111940	for vehicles with sports suspension	Track Control Arm	S060580
	1993.06-1995.06	Front Axle Right Lower	Saloon RWD 111940	Check to find 070222 for vehicles with sports suspension for vehicles without sports suspension	Track Control Arm	S060582
	1993.06-1995.06	Rear Axle Left & Right Lower Inner	Saloon RWD 111940		Track Control Arm	S060217
	1993.06-1995.06	Rear Axle Left & Right Upper Inner	Saloon RWD 111940		Track Control Arm	S060216
	1993.06-1995.06	Rear Axle Left & Right Lower Outer	Saloon RWD 111940		Track Control Arm	S051055
	1993.06-1995.06	Rear Axle Left & Right Upper Outer	Saloon RWD 111940		Track Control Arm	S060218
	1993.06-1995.06	Front Axle Left & Right Lower	Saloon RWD 111940		Ball Joint	S080141
	1993.06-1995.06	Front Axle Left & Right Lower	Saloon RWD 111940		Control Arm Bushing	510427
	1993.06-1995.06	Front Axle Left & Right Lower	Saloon RWD 111940		Control Arm Bushing	510428
	1993.06-1995.06	Front Axle Left & Right Lower	Saloon RWD 111940		Control Arm Bushing	510450
	1993.06-1995.06	Front Axle Left & Right Lower	Saloon RWD 111940		Control Arm Bushing	510563
	1993.06-1995.06	Front Axle Left & Right Lower	Saloon RWD 111940		Control Arm Bushing	510564
	1993.06-1995.06	Rear Axle Left & Right Lower	Saloon RWD 111940		Control Arm Bushing	511560
	1993.06-1995.06	Rear Axle Left & Right Upper Inner	Saloon RWD 111940		Control Arm Bushing	517809
	1993.06-1995.06	Rear Axle Left & Right Lower Outer	Saloon RWD 111940		Control Arm Bushing	510431
	1993.06-1995.06	Rear Axle Left & Right Lower Outer	Saloon RWD 111940		Control Arm Bushing	512252
	1993.06-1995.06	Rear Axle Left & Right Upper Outer	Saloon RWD 111940		Control Arm Bushing	510430



	 YEAR	FITTING POSITION	BODY STYLE & DRIVE TYPE & ENGINE	REMARKS	PRODUCT	GSP Ref.
MERCEDES-BENZ E200						
2.0 (100 kw)	1993.06-1995.06	Rear Axle	Saloon RWD 111940		Suspension Repair Kit	S990038SK
	1993.06-1995.06	Front Axle Left & Right	Saloon RWD 111940		Rod Assembly	S100073
	1993.06-1995.06	Front Axle Left & Right Centre	Saloon RWD 111940		Rod Assembly	S100075
	1993.06-1995.06	Front Axle Left & Right	Saloon RWD 111940		Tie Rod End	S070048
	1993.06-1995.06	Front Axle Left & Right	Saloon RWD 111940		Tie Rod End	S070308
	1993.06-1995.06	Front Axle Left & Right	Saloon RWD 111940		Tie Rod End	S070824
	1993.06-1995.06	Rear Axle Left & Right	Saloon RWD 111940		Rod/Strut,stabiliser	S100063
	1993.06-1995.06	Front Axle Left & Right Inner	Saloon RWD 111940		Stabiliser Bushing	512609
	1993.06-1995.06	Front Axle Left & Right Outer	Saloon RWD 111940		Stabiliser Bushing	511553
	1993.06-1995.06	Front Axle	Saloon RWD 111940		Stabiliser Bushing	511541
	1993.06-1995.06	Front Axle	Saloon RWD 111940		Stabiliser Bushing Kit	519452S
	1993.06-1995.06	Rear Axle	Saloon RWD 111940		Stabiliser Bushing Kit	531455S
	1995.07-2000.06	Front Axle Left Lower	Saloon RWD 111942		Track Control Arm	S060578
	1995.07-2000.06	Front Axle Left Upper	Saloon RWD 111942		Track Control Arm	S060214
	1995.07-2000.06	Front Axle Right Lower	Saloon RWD 111942		Track Control Arm	S060577
	1995.07-2000.06	Front Axle Right Upper	Saloon RWD 111942		Track Control Arm	S060215
	1995.07-2000.06	Rear Axle Left & Right Lower Inner	Saloon RWD 111942		Track Control Arm	S060217
	1995.07-2000.06	Rear Axle Left & Right Upper Inner	Saloon RWD 111942	not for armoured vehicles	Track Control Arm	S060216
	1995.07-2000.06	Rear Axle Left & Right Lower Outer	Saloon RWD 111942		Track Control Arm	S051055
	1995.07-2000.06	Rear Axle Left & Right Upper Outer	Saloon RWD 111942		Track Control Arm	S060218
	1995.07-2000.06	Front Axle Left & Right Lower	Saloon RWD 111942		Ball Joint	S080143
	1995.07-2000.06	Front Axle Left & Right Upper	Saloon RWD 111942		Control Arm Bushing	510456
	1995.07-2000.06	Rear Axle Left & Right Lower	Saloon RWD 111942		Control Arm Bushing	511560
	1995.07-2000.06	Rear Axle Left & Right Upper Inner	Saloon RWD 111942		Control Arm Bushing	517809
	1995.07-2000.06	Rear Axle Left & Right Lower Outer	Saloon RWD 111942		Control Arm Bushing	510431
	1995.07-2000.06	Rear Axle Left & Right Lower Outer	Saloon RWD 111942		Control Arm Bushing	512252
	1995.07-2000.06	Rear Axle Left & Right Upper Outer	Saloon RWD 111942		Control Arm Bushing	510430
	1995.07-2000.06	Front Axle Left & Right Lower	Saloon RWD 111942		Control Arm Bushing Kit	510470S
	1995.07-2000.06	Rear Axle	Saloon RWD 111942		Suspension Repair Kit	S990038SK
	1995.07-2000.06	Front Axle Left & Right	Saloon RWD 111942		Tie Rod Axle Joint	S030853
	1995.07-2000.06	Front Axle Left	Saloon RWD 111942		Tie Rod End	S070312
	1995.07-2000.06	Front Axle Right	Saloon RWD 111942		Tie Rod End	S070313
	1995.07-2000.06	Front Axle Left	Saloon RWD 111942		Rod/Strut,stabiliser	510478
	1995.07-2000.06	Front Axle Right	Saloon RWD 111942		Rod/Strut,stabiliser	510479
	1995.07-2000.06	Rear Axle Left & Right	Saloon RWD 111942		Rod/Strut,stabiliser	S050272
	1995.07-2000.06	Rear Axle Left & Right	Saloon RWD 111942	not for armoured vehicles	Rod/Strut,stabiliser	S100063
	1995.07-2000.06	Front Axle	Saloon RWD 111942		Stabiliser Bushing	510472
	1995.07-2000.06	Front Axle	Saloon RWD 111942		Stabiliser Bushing	512616
	1995.07-2000.06	Rear Axle	Saloon RWD 111942		Stabiliser Bushing	517269
	1995.07-2000.06	Front Axle	Saloon RWD 111942		Steering Boot	540204
	1995.07-2000.06	Front Axle	Saloon RWD 111942		Steering Boot	540345
	1995.07-2000.06	Front Axle	Saloon RWD 111942		Steering Boot	540443
E220						
2.2 (110 kw)	1993.06-1995.06	Front Axle Left Lower	Saloon RWD 111960		Track Control Arm	S060581
	1993.06-1995.06	Front Axle Right Lower	Saloon RWD 111960		Track Control Arm	S060582
	1993.06-1995.06	Rear Axle Left & Right Lower Inner	Saloon RWD 111960		Track Control Arm	S060217
	1993.06-1995.06	Rear Axle Left & Right Upper Inner	Saloon RWD 111960		Track Control Arm	S060216
	1993.06-1995.06	Rear Axle Left & Right Lower Outer	Saloon RWD 111960		Track Control Arm	S051055
	1993.06-1995.06	Rear Axle Left & Right Upper Outer	Saloon RWD 111960		Track Control Arm	S060218
	1993.06-1995.06	Front Axle Left & Right Lower	Saloon RWD 111960		Ball Joint	S080141
	1993.06-1995.06	Front Axle Left & Right Lower	Saloon RWD 111960		Control Arm Bushing	510427
	1993.06-1995.06	Front Axle Left & Right Lower	Saloon RWD 111960		Control Arm Bushing	510428
	1993.06-1995.06	Front Axle Left & Right Lower	Saloon RWD 111960		Control Arm Bushing	510564
	1993.06-1995.06	Rear Axle Left & Right Lower	Saloon RWD 111960		Control Arm Bushing	511560
	1993.06-1995.06	Rear Axle Left & Right Upper Inner	Saloon RWD 111960		Control Arm Bushing	517809
	1993.06-1995.06	Rear Axle Left & Right Lower Outer	Saloon RWD 111960		Control Arm Bushing	510431
	1993.06-1995.06	Rear Axle Left & Right Lower Outer	Saloon RWD 111960		Control Arm Bushing	512252
	1993.06-1995.06	Rear Axle Left & Right Upper Outer	Saloon RWD 111960		Control Arm Bushing	510430
	1993.06-1995.06	Rear Axle	Saloon RWD 111960		Suspension Repair Kit	S990038SK
	1993.06-1995.06	Front Axle Left & Right	Saloon RWD 111960		Rod Assembly	S100073
	1993.06-1995.06	Front Axle Left & Right Centre	Saloon RWD 111960		Rod Assembly	S100075
	1993.06-1995.06	Front Axle Left & Right	Saloon RWD 111960		Tie Rod End	S070048
	1993.06-1995.06	Front Axle Left & Right	Saloon RWD 111960		Tie Rod End	S070308
	1993.06-1995.06	Rear Axle Left & Right	Saloon RWD 111960		Rod/Strut,stabiliser	S100063



	 YEAR	FITTING POSITION	BODY STYLE & DRIVE TYPE & ENGINE	REMARKS	PRODUCT	GSP Ref.	
MERCEDES-BENZ							
E220							
2.2 (110 kw)	1993.06-1995.06	Front Axle Left & Right Inner	Saloon RWD 111960		Stabiliser Bushing	512609	
	1993.06-1995.06	Front Axle Left & Right Outer	Saloon RWD 111960		Stabiliser Bushing	511553	
	1993.06-1995.06	Front Axle	Saloon RWD 111960		Stabiliser Bushing Kit	519452S	
	1993.06-1995.06	Rear Axle	Saloon RWD 111960		Stabiliser Bushing Kit	531455S	
E230							
2.3 (110 kw)	1995.07-1997.10	Front Axle Left Lower	Saloon RWD 111970		Track Control Arm	S060578	
	1995.07-1997.10	Front Axle Left Upper	Saloon RWD 111970		Track Control Arm	S060214	
	1995.07-1997.10	Front Axle Right Lower	Saloon RWD 111970		Track Control Arm	S060577	
	1995.07-1997.10	Front Axle Right Upper	Saloon RWD 111970		Track Control Arm	S060215	
	1995.07-1997.10	Rear Axle Left & Right Lower Inner	Saloon RWD 111970		Track Control Arm	S060217	
	1995.07-1997.10	Rear Axle Left & Right Upper Inner	Saloon RWD 111970	Chassis no.from:A 597177.X 007199	Track Control Arm	S060216	
	1995.07-1997.10	Rear Axle Left & Right Lower Outer	Saloon RWD 111970		Track Control Arm	S051055	
	1995.07-1997.10	Rear Axle Left & Right Upper Outer	Saloon RWD 111970		Track Control Arm	S060218	
	1995.07-1997.10	Front Axle Left & Right Lower	Saloon RWD 111970		Ball Joint	S080143	
	1995.07-1997.10	Front Axle Left & Right Upper	Saloon RWD 111970		Control Arm Bushing	510456	
	1995.07-1997.10	Rear Axle Left & Right Lower	Saloon RWD 111970		Control Arm Bushing	511560	
	1995.07-1997.10	Rear Axle Left & Right Upper Inner	Saloon RWD 111970		Control Arm Bushing	517809	
	1995.07-1997.10	Rear Axle Left & Right Lower Outer	Saloon RWD 111970		Control Arm Bushing	510431	
	1995.07-1997.10	Rear Axle Left & Right Lower Outer	Saloon RWD 111970		Control Arm Bushing	512252	
	1995.07-1997.10	Rear Axle Left & Right Upper Outer	Saloon RWD 111970		Control Arm Bushing	510430	
	1995.07-1997.10	Front Axle Left & Right Lower	Saloon RWD 111970		Control Arm Bushing Kit	510470S	
	1995.07-1997.10	Rear Axle	Saloon RWD 111970		Suspension Repair Kit	S990038SK	
	1995.07-1997.10	Front Axle Left & Right	Saloon RWD 111970		Tie Rod Axle Joint	S030853	
	1995.07-1997.10	Front Axle Left	Saloon RWD 111970		Tie Rod End	S070312	
	1995.07-1997.10	Front Axle Right	Saloon RWD 111970		Tie Rod End	S070313	
	1995.07-1997.10	Front Axle Left	Saloon RWD 111970		Rod/Strut,stabiliser	510478	
	1995.07-1997.10	Front Axle Right	Saloon RWD 111970		Rod/Strut,stabiliser	510479	
	1995.07-1997.10	Rear Axle Left & Right	Saloon RWD 111970		Rod/Strut,stabiliser	S100063	
	1995.07-1997.10	Front Axle	Saloon RWD 111970		Stabiliser Bushing	510472	
	1995.07-1997.10	Front Axle	Saloon RWD 111970		Stabiliser Bushing	512616	
	1995.07-1997.10	Rear Axle	Saloon RWD 111970		Stabiliser Bushing	517269	
	1995.07-1997.10	Front Axle	Saloon RWD 111970		Steering Boot	540204	
	1995.07-1997.10	Front Axle	Saloon RWD 111970		Steering Boot	540345	
	1995.07-1997.10	Front Axle	Saloon RWD 111970		Steering Boot	540443	
	E240						
	2.4 (125 kw)	1997.04-2000.06	Front Axle Left Lower	Saloon RWD 112911		Track Control Arm	S060578
		1997.04-2000.06	Front Axle Left Upper	Saloon RWD 112911		Track Control Arm	S060214
1997.04-2000.06		Front Axle Right Lower	Saloon RWD 112911		Track Control Arm	S060577	
1997.04-2000.06		Front Axle Right Upper	Saloon RWD 112911		Track Control Arm	S060215	
1997.04-2000.06		Rear Axle Left & Right Lower Inner	Saloon RWD 112911		Track Control Arm	S060217	
1997.04-2000.06		Rear Axle Left & Right Upper Inner	Saloon RWD 112911	Chassis no.from:A 597177.X 007199	Track Control Arm	S060216	
1997.04-2000.06		Rear Axle Left & Right Lower Outer	Saloon RWD 112911		Track Control Arm	S051055	
1997.04-2000.06		Rear Axle Left & Right Upper Outer	Saloon RWD 112911		Track Control Arm	S060218	
1997.04-2000.06		Front Axle Left & Right Lower	Saloon RWD 112911		Ball Joint	S080143	
1997.04-2000.06		Front Axle Left & Right Lower	Saloon RWD 112911		Control Arm Bushing	510471	
1997.04-2000.06		Front Axle Left & Right Upper	Saloon RWD 112911		Control Arm Bushing	510456	
1997.04-2000.06		Rear Axle Left & Right Lower	Saloon RWD 112911		Control Arm Bushing	511560	
1997.04-2000.06		Rear Axle Left & Right Upper Inner	Saloon RWD 112911		Control Arm Bushing	517809	
1997.04-2000.06		Rear Axle Left & Right Lower Outer	Saloon RWD 112911		Control Arm Bushing	510431	
1997.04-2000.06		Rear Axle Left & Right Lower Outer	Saloon RWD 112911		Control Arm Bushing	512252	
1997.04-2000.06		Rear Axle Left & Right Upper Outer	Saloon RWD 112911		Control Arm Bushing	510430	
1997.04-2000.06		Front Axle Left & Right Lower	Saloon RWD 112911		Control Arm Bushing Kit	510470S	
1997.04-2000.06		Rear Axle	Saloon RWD 112911		Suspension Repair Kit	S990038SK	
1997.04-2000.06		Front Axle Left & Right	Saloon RWD 112911		Tie Rod Axle Joint	S030853	
1997.04-2000.06		Front Axle Left	Saloon RWD 112911		Tie Rod End	S070312	
1997.04-2000.06		Front Axle Right	Saloon RWD 112911		Tie Rod End	S070313	
1997.04-2000.06		Front Axle Left	Saloon RWD 112911		Rod/Strut,stabiliser	510478	
1997.04-2000.06		Front Axle Right	Saloon RWD 112911		Rod/Strut,stabiliser	510479	
1997.04-2000.06		Rear Axle Left & Right	Saloon RWD 112911	Special Purpose:For armoured vehicles	Rod/Strut,stabiliser	S050272	
1997.04-2000.06		Rear Axle Left & Right	Saloon RWD 112911	not for armoured vehicles	Rod/Strut,stabiliser	S100063	
1997.04-2000.06		Front Axle Left & Right	Saloon RWD 112911		Stabiliser Bushing	530744	
1997.04-2000.06		Front Axle	Saloon RWD 112911		Stabiliser Bushing	512616	
1997.04-2000.06		Rear Axle	Saloon RWD 112911		Stabiliser Bushing	517269	
1997.04-2000.06		Front Axle	Saloon RWD 112911		Steering Boot	540204	



	 YEAR	FITTING POSITION	BODY STYLE & DRIVE TYPE & ENGINE	REMARKS	PRODUCT	GSP Ref.	
MERCEDES-BENZ E240							
2.4 (125 kw)	1997.04-2000.06	Front Axle	Saloon RWD 112911		Steering Boot	540345	
	1997.04-2000.06	Front Axle	Saloon RWD 112911		Steering Boot	540443	
2.6 (125 kw)	2000.07-2002.03	Front Axle Left Lower	Saloon RWD 112914		Track Control Arm	S060578	
	2000.07-2002.03	Front Axle Left Upper	Saloon RWD 112914		Track Control Arm	S060214	
	2000.07-2002.03	Front Axle Right Lower	Saloon RWD 112914		Track Control Arm	S060577	
	2000.07-2002.03	Front Axle Right Upper	Saloon RWD 112914		Track Control Arm	S060215	
	2000.07-2002.03	Rear Axle Left & Right Lower Inner	Saloon RWD 112914		Track Control Arm	S060217	
	2000.07-2002.03	Rear Axle Left & Right Upper Inner	Saloon RWD 112914	not for armoured vehicles	Track Control Arm	S060216	
	2000.07-2002.03	Rear Axle Left & Right Lower Outer	Saloon RWD 112914		Track Control Arm	S051055	
	2000.07-2002.03	Front Axle Left & Right Lower	Saloon RWD 112914		Ball Joint	S080143	
	2000.07-2002.03	Front Axle Left & Right Upper	Saloon RWD 112914		Control Arm Bushing	510456	
	2000.07-2002.03	Rear Axle Left & Right Lower	Saloon RWD 112914		Control Arm Bushing	511560	
	2000.07-2002.03	Rear Axle Left & Right Upper Inner	Saloon RWD 112914		Control Arm Bushing	517809	
	2000.07-2002.03	Rear Axle Left & Right Lower Outer	Saloon RWD 112914		Control Arm Bushing	512252	
	2000.07-2002.03	Front Axle Left & Right Lower	Saloon RWD 112914		Control Arm Bushing Kit	510470S	
	2000.07-2002.03	Rear Axle	Saloon RWD 112914		Suspension Repair Kit	S990038SK	
	2000.07-2002.03	Front Axle Left & Right	Saloon RWD 112914		Tie Rod Axle Joint	S030853	
	2000.07-2002.03	Front Axle Left	Saloon RWD 112914		Tie Rod End	S070312	
	2000.07-2002.03	Front Axle Right	Saloon RWD 112914		Tie Rod End	S070313	
	2000.07-2002.03	Front Axle Left	Saloon RWD 112914		Rod/Strut, stabiliser	510478	
	2000.07-2002.03	Front Axle Right	Saloon RWD 112914		Rod/Strut, stabiliser	510479	
	2000.07-2002.03	Rear Axle Left & Right	Saloon RWD 112914	Special Purpose:For armoured vehicles	Rod/Strut, stabiliser	S050272	
	2000.07-2002.03	Rear Axle Left & Right	Saloon RWD 112914	not for armoured vehicles	Rod/Strut, stabiliser	S100063	
	2000.07-2002.03	Front Axle Left & Right	Saloon RWD 112914		Stabiliser Bushing	530744	
	2000.07-2002.03	Front Axle	Saloon RWD 112914		Stabiliser Bushing	512616	
	2000.07-2002.03	Rear Axle	Saloon RWD 112914		Stabiliser Bushing	517269	
	2000.07-2002.03	Front Axle	Saloon RWD 112914		Steering Boot	540204	
	2000.07-2002.03	Front Axle	Saloon RWD 112914		Steering Boot	540345	
	2000.07-2002.03	Front Axle	Saloon RWD 112914		Steering Boot	540443	
	2.6 (130 kw)	2002.04-2006.07	Front Axle Left Upper	Saloon RWD 112913		Track Control Arm	S060223
		2002.04-2006.07	Front Axle Left Lower Inner	Saloon RWD 112913		Track Control Arm	S060225
		2002.04-2006.07	Front Axle Left Lower Outer	Saloon RWD 112913		Track Control Arm	S060227
2002.04-2006.07		Front Axle Right Upper	Saloon RWD 112913		Track Control Arm	S060224	
2002.04-2006.07		Front Axle Right Lower Inner	Saloon RWD 112913		Track Control Arm	S060226	
2002.04-2006.07		Front Axle Right Lower Outer	Saloon RWD 112913		Track Control Arm	S060228	
2002.04-2006.07		Rear Axle Left Upper Inner	Saloon RWD 112913		Track Control Arm	S060231	
2002.04-2006.07		Rear Axle Left Upper Outer	Saloon RWD 112913		Track Control Arm	S060229	
2002.04-2006.07		Rear Axle Right Upper Inner	Saloon RWD 112913		Track Control Arm	S060232	
2002.04-2006.07		Rear Axle Right Upper Outer	Saloon RWD 112913		Track Control Arm	S060230	
2002.04-2006.07		Rear Axle Left & Right Lower Inner	Saloon RWD 112913		Track Control Arm	S060233	
2002.04-2006.07		Front Axle Left & Right Upper	Saloon RWD 112913		Ball Joint	S080145	
2002.04-2006.07		Front Axle Left & Right Lower Inner	Saloon RWD 112913	for OE No.211 330 81 07	Ball Joint	S080134	
2002.04-2006.07		Front Axle Left & Right Lower Inner	Saloon RWD 112913		Ball Joint	S080136	
2002.04-2006.07		Front Axle Left & Right Upper	Saloon RWD 112913		Control Arm Bushing	510529	
2002.04-2006.07		Front Axle Left & Right Lower Inner	Saloon RWD 112913		Control Arm Bushing	518119	
2002.04-2006.07		Front Axle Left & Right Lower Inner	Saloon RWD 112913		Control Arm Bushing	518120	
2002.04-2006.07		Front Axle Left & Right Lower Outer	Saloon RWD 112913		Control Arm Bushing	510518	
2002.04-2006.07		Front Axle Left & Right Lower Outer	Saloon RWD 112913		Control Arm Bushing	530133	
2002.04-2006.07		Rear Axle Left & Right Lower Inner	Saloon RWD 112913		Control Arm Bushing	530527	
2002.04-2006.07		Rear Axle Left & Right Upper Inner	Saloon RWD 112913		Control Arm Bushing	510521	
2002.04-2006.07		Rear Axle Left & Right Upper Outer	Saloon RWD 112913		Control Arm Bushing	510522	
2002.04-2006.07		Front Axle	Saloon RWD 112913		Suspension Repair Kit	S990007SK	
2002.04-2006.07		Front Axle	Saloon RWD 112913		Suspension Repair Kit	S990035SK	
2002.04-2006.07		Front Axle	Saloon RWD 112913		Suspension Repair Kit	S990039SK	
2002.04-2006.07		Rear Axle	Saloon RWD 112913		Suspension Repair Kit	S990056SK	
2002.04-2006.07		Front Axle Left & Right	Saloon RWD 112913		Tie Rod Axle Joint	S030853	
2002.04-2006.07		Front Axle Left	Saloon RWD 112913		Tie Rod End	S070286	
2002.04-2006.07		Front Axle Right	Saloon RWD 112913		Tie Rod End	S070287	
2002.04-2006.07		Front Axle Left	Saloon RWD 112913		Rod/Strut, stabiliser	510516	
2002.04-2006.07		Front Axle Right	Saloon RWD 112913		Rod/Strut, stabiliser	510515	
2002.04-2006.07		Front Axle	Saloon RWD 112913		Stabiliser Bushing	510514	
2002.04-2006.07		Front Axle	Saloon RWD 112913	Date to:2006.07	Steering Rack Bellow Kit	540204S	



	 YEAR	FITTING POSITION	BODY STYLE & DRIVE TYPE & ENGINE	REMARKS	PRODUCT	GSP Ref.
MERCEDES-BENZ E250						
1.8 (150 kw)	2009.01-2015.12	Front Axle Left Lower Inner	Saloon RWD 271860		Track Control Arm	S061637
	2009.01-2015.12	Front Axle Left Lower Outer	Saloon RWD 271860		Track Control Arm	S061607
	2009.01-2015.12	Front Axle Right Lower Inner	Saloon RWD 271860		Track Control Arm	S061638
	2009.01-2015.12	Front Axle Right Lower Outer	Saloon RWD 271860		Track Control Arm	S061608
	2009.01-2015.12	Rear Axle Left Upper Inner	Saloon RWD 271860		Track Control Arm	S063227
	2009.01-2015.12	Rear Axle Left Lower Outer	Saloon RWD 271860		Track Control Arm	S061566
	2009.01-2015.12	Rear Axle Left Upper Outer	Saloon RWD 271860		Track Control Arm	S062798
	2009.01-2015.12	Rear Axle Right Upper Inner	Saloon RWD 271860		Track Control Arm	S063228
	2009.01-2015.12	Rear Axle Right Lower Outer	Saloon RWD 271860		Track Control Arm	S061567
	2009.01-2015.12	Rear Axle Right Upper Outer	Saloon RWD 271860		Track Control Arm	S062797
	2009.01-2015.12	Rear Axle Left & Right Lower Inner	Saloon RWD 271860		Track Control Arm	S062799
	2009.01-2015.12	Front Axle Left & Right Lower Outer	Saloon RWD 271860		Ball Joint	S080671
	2009.01-2015.12	Front Axle Left & Right Lower Inner	Saloon RWD 271860		Control Arm Bushing	517477
	2009.01-2015.12	Front Axle Left & Right Lower Outer	Saloon RWD 271860		Control Arm Bushing	531452
	2009.01-2015.12	Rear Axle Left & Right Lower Inner	Saloon RWD 271860		Control Arm Bushing	530527
	2009.01-2015.12	Rear Axle Left & Right Upper Inner	Saloon RWD 271860		Control Arm Bushing	516563
	2009.01-2015.12	Rear Axle Left & Right Upper Inner	Saloon RWD 271860		Control Arm Bushing	530504
	2009.01-2015.12	Rear Axle Left & Right Upper Inner	Saloon RWD 271860		Control Arm Bushing	533480
	2009.01-2015.12	Rear Axle Left & Right Upper Inner	Saloon RWD 271860		Control Arm Bushing	516552
	2009.01-2015.12	Rear Axle Left & Right Lower Outer	Saloon RWD 271860		Control Arm Bushing	516553
	2009.01-2015.12	Rear Axle Left & Right Lower Outer	Saloon RWD 271860		Control Arm Bushing	531454
	2009.01-2015.12	Rear Axle Left & Right Upper Outer	Saloon RWD 271860		Control Arm Bushing	531454
	2009.01-2015.12	Front Axle Left & Right	Saloon RWD 271860		Tie Rod Axle Joint	S030649
	2009.01-2015.12	Front Axle Left	Saloon RWD 271860		Tie Rod End	S070998
	2009.01-2015.12	Front Axle Right	Saloon RWD 271860		Tie Rod End	S070997
	2009.01-2015.12	Front Axle Left	Saloon RWD 271860		Rod/Strut, stabiliser	S050804
	2009.01-2015.12	Front Axle Right	Saloon RWD 271860		Rod/Strut, stabiliser	S050803
	2009.01-2015.12	Rear Axle Left	Saloon RWD 271860		Rod/Strut, stabiliser	S050306
	2009.01-2015.12	Rear Axle Right	Saloon RWD 271860		Rod/Strut, stabiliser	S050307
	2009.01-2016.12	Front Axle Left Lower Inner	Coupe RWD 271860		Track Control Arm	S060262
	2009.01-2016.12	Front Axle Left Lower Outer	Coupe RWD 271860		Track Control Arm	S060221
	2009.01-2016.12	Front Axle Right Lower Inner	Coupe RWD 271860		Track Control Arm	S060263
	2009.01-2016.12	Front Axle Right Lower Outer	Coupe RWD 271860		Track Control Arm	S060222
	2009.01-2016.12	Rear Axle Left Upper Inner	Coupe RWD 271860		Track Control Arm	S063227
	2009.01-2016.12	Rear Axle Left Lower Outer	Coupe RWD 271860		Track Control Arm	S061566
	2009.01-2016.12	Rear Axle Left Upper Outer	Coupe RWD 271860		Track Control Arm	S062798
	2009.01-2016.12	Rear Axle Right Upper Inner	Coupe RWD 271860		Track Control Arm	S063228
	2009.01-2016.12	Rear Axle Right Lower Outer	Coupe RWD 271860		Track Control Arm	S061567
	2009.01-2016.12	Rear Axle Right Upper Outer	Coupe RWD 271860		Track Control Arm	S062797
	2009.01-2016.12	Rear Axle Left & Right Lower Inner	Coupe RWD 271860		Track Control Arm	S062799
	2009.01-2016.12	Front Axle Left & Right Lower Inner	Coupe RWD 271860		Control Arm Bushing	517969
	2009.01-2016.12	Front Axle Left & Right Lower Outer	Coupe RWD 271860		Control Arm Bushing	510491
	2009.01-2016.12	Front Axle Left & Right Lower Outer	Coupe RWD 271860		Control Arm Bushing	513450
	2009.01-2016.12	Rear Axle Left & Right Upper	Coupe RWD 271860		Control Arm Bushing	532971
	2009.01-2016.12	Rear Axle Left & Right Lower Inner	Coupe RWD 271860		Control Arm Bushing	530527
	2009.01-2016.12	Rear Axle Left & Right Upper Inner	Coupe RWD 271860		Control Arm Bushing	516563
	2009.01-2016.12	Rear Axle Left & Right Upper Inner	Coupe RWD 271860		Control Arm Bushing	530504
	2009.01-2016.12	Rear Axle Left & Right Upper Inner	Coupe RWD 271860		Control Arm Bushing	533480
	2009.01-2016.12	Rear Axle Left & Right Lower Outer	Coupe RWD 271860		Control Arm Bushing	516552
	2009.01-2016.12	Rear Axle Left & Right Lower Outer	Coupe RWD 271860		Control Arm Bushing	516553
	2009.01-2016.12	Rear Axle Left & Right Upper Outer	Coupe RWD 271860		Control Arm Bushing	531454
	2009.01-2016.12	Front Axle Left & Right	Coupe RWD 271860	for vehicles with hydraulic power steering	Tie Rod Axle Joint	S030171
	2009.01-2016.12	Front Axle Left & Right	Coupe RWD 271860	for vehicles with electric power steering	Tie Rod Axle Joint	S030932
	2009.01-2016.12	Front Axle Left	Coupe RWD 271860		Tie Rod End	S070284
	2009.01-2016.12	Front Axle Right	Coupe RWD 271860		Tie Rod End	S070285
	2009.01-2016.12	Front Axle Left	Coupe RWD 271860		Rod/Strut, stabiliser	S050304
	2009.01-2016.12	Front Axle Right	Coupe RWD 271860	for vehicles without electronic steering regulators for vehicles without power suspension	Rod/Strut, stabiliser	S050305
	2009.01-2016.12	Front Axle Right	Coupe RWD 271860		Rod/Strut, stabiliser	S051289
	2009.01-2016.12	Rear Axle Left	Coupe RWD 271860		Rod/Strut, stabiliser	S050306
	2009.01-2016.12	Rear Axle Right	Coupe RWD 271860		Rod/Strut, stabiliser	S050307
2.0 (155 kw)	2013.01-2016.12	Front Axle Left Lower Inner	Saloon RWD 274920		Track Control Arm	S061637
	2013.01-2016.12	Front Axle Left Lower Outer	Saloon RWD 274920		Track Control Arm	S061607
	2013.01-2016.12	Front Axle Right Lower Inner	Saloon RWD 274920		Track Control Arm	S061638
	2013.01-2016.12	Front Axle Right Lower Outer	Saloon RWD 274920		Track Control Arm	S061608
	2013.01-2016.12	Rear Axle Left Upper Inner	Saloon RWD 274920		Track Control Arm	S063227



	 YEAR	FITTING POSITION	BODY STYLE & DRIVE TYPE & ENGINE	REMARKS	PRODUCT	GSP Ref.
MERCEDES-BENZ E250						
2.0 (155 kw)	2013.01-2016.12	Rear Axle Left Lower Outer	Saloon RWD 274920		Track Control Arm	S061566
	2013.01-2016.12	Rear Axle Left Upper Outer	Saloon RWD 274920		Track Control Arm	S062798
	2013.01-2016.12	Rear Axle Right Upper Inner	Saloon RWD 274920		Track Control Arm	S063228
	2013.01-2016.12	Rear Axle Right Lower Outer	Saloon RWD 274920		Track Control Arm	S061567
	2013.01-2016.12	Rear Axle Right Upper Outer	Saloon RWD 274920		Track Control Arm	S062797
	2013.01-2016.12	Front Axle Left & Right Lower Outer	Saloon RWD 274920		Ball Joint	S080671
	2013.01-2016.12	Front Axle Left & Right Lower Inner	Saloon RWD 274920		Control Arm Bushing	517477
	2013.01-2016.12	Front Axle Left & Right Lower Outer	Saloon RWD 274920		Control Arm Bushing	531452
	2013.01-2016.12	Rear Axle Left & Right Lower Inner	Saloon RWD 274920		Control Arm Bushing	530527
	2013.01-2016.12	Rear Axle Left & Right Upper Inner	Saloon RWD 274920		Control Arm Bushing	516563
	2013.01-2016.12	Rear Axle Left & Right Upper Inner	Saloon RWD 274920		Control Arm Bushing	530504
	2013.01-2016.12	Rear Axle Left & Right Upper Inner	Saloon RWD 274920		Control Arm Bushing	533480
	2013.01-2016.12	Rear Axle Left & Right Lower Outer	Saloon RWD 274920		Control Arm Bushing	516552
	2013.01-2016.12	Rear Axle Left & Right Lower Outer	Saloon RWD 274920		Control Arm Bushing	516553
	2013.01-2016.12	Rear Axle Left & Right Upper Outer	Saloon RWD 274920		Control Arm Bushing	531454
	2013.01-2016.12	Front Axle Left & Right	Saloon RWD 274920		Tie Rod Axle Joint	S030649
	2013.01-2016.12	Front Axle Left	Saloon RWD 274920		Tie Rod End	S070998
	2013.01-2016.12	Front Axle Right	Saloon RWD 274920		Tie Rod End	S070997
	2013.01-2016.12	Front Axle Left	Saloon RWD 274920		Rod/Strut, stabiliser	S050804
	2013.01-2016.12	Front Axle Right	Saloon RWD 274920		Rod/Strut, stabiliser	S050803
	2013.01-2016.12	Rear Axle Left	Saloon RWD 274920		Rod/Strut, stabiliser	S050306
	2013.01-2016.12	Rear Axle Right	Saloon RWD 274920		Rod/Strut, stabiliser	S050307
	2016.07-	Front Axle Left Upper	Saloon RWD 274920		Track Control Arm	S062802
	2016.07-	Front Axle Left Lower Inner	Saloon RWD 274920		Track Control Arm	S062805
	2016.07-	Front Axle Left Lower Outer	Saloon RWD 274920		Track Control Arm	S062844
	2016.07-	Front Axle Right Upper	Saloon RWD 274920		Track Control Arm	S062801
	2016.07-	Front Axle Right Lower Inner	Saloon RWD 274920		Track Control Arm	S062806
	2016.07-	Front Axle Right Lower Outer	Saloon RWD 274920		Track Control Arm	S062845
	2016.07-	Rear Axle Left Upper Inner	Saloon RWD 274920		Track Control Arm	S063227
	2016.07-	Rear Axle Left Lower Outer	Saloon RWD 274920		Track Control Arm	S061566
	2016.07-	Rear Axle Right Upper Inner	Saloon RWD 274920		Track Control Arm	S063228
	2016.07-	Rear Axle Right Lower Outer	Saloon RWD 274920		Track Control Arm	S061567
	2016.07-	Front Axle Left & Right Upper	Saloon RWD 274920		Control Arm Bushing	510529
	2016.07-	Front Axle Left & Right Lower Inner	Saloon RWD 274920		Control Arm Bushing	533481
	2016.07-	Front Axle Left & Right Lower Inner	Saloon RWD 274920		Control Arm Bushing	533482
	2016.07-	Front Axle Left & Right Lower Inner	Saloon RWD 274920		Control Arm Bushing	535418
	2016.07-	Rear Axle Left & Right Upper Inner	Saloon RWD 274920		Control Arm Bushing	530504
	2016.07-	Rear Axle Left & Right Upper Inner	Saloon RWD 274920		Control Arm Bushing	533480
	2016.07-	Rear Axle Left & Right Lower Outer	Saloon RWD 274920		Control Arm Bushing	516552
	2016.07-	Front Axle Left & Right	Saloon RWD 274920		Tie Rod Axle Joint	S030926
	2016.07-	Front Axle Left	Saloon RWD 274920		Tie Rod End	S071616
	2016.07-	Front Axle Right	Saloon RWD 274920		Tie Rod End	S071617
	2016.07-	Rear Axle Left	Saloon RWD 274920		Rod/Strut, stabiliser	S051247
	2016.07-	Rear Axle Right	Saloon RWD 274920		Rod/Strut, stabiliser	S051248
E280						
2.8 (142 kw)	1993.06-1995.06	Rear Axle Left & Right Lower Inner	Saloon RWD 104942		Track Control Arm	S060217
	1993.06-1995.06	Rear Axle Left & Right Upper Inner	Saloon RWD 104942		Track Control Arm	S060216
	1993.06-1995.06	Rear Axle Left & Right Lower Outer	Saloon RWD 104942		Track Control Arm	S051055
	1993.06-1995.06	Rear Axle Left & Right Upper Outer	Saloon RWD 104942		Track Control Arm	S060218
	1993.06-1995.06	Front Axle Left & Right Lower	Saloon RWD 104942		Ball Joint	S080141
	1993.06-1995.06	Rear Axle Left & Right Lower	Saloon RWD 104942		Control Arm Bushing	511560
	1993.06-1995.06	Rear Axle Left & Right Upper Inner	Saloon RWD 104942		Control Arm Bushing	517809
	1993.06-1995.06	Rear Axle Left & Right Lower Outer	Saloon RWD 104942		Control Arm Bushing	510431
	1993.06-1995.06	Rear Axle Left & Right Lower Outer	Saloon RWD 104942		Control Arm Bushing	512252
	1993.06-1995.06	Rear Axle Left & Right Upper Outer	Saloon RWD 104942		Control Arm Bushing	510430
	1993.06-1995.06	Rear Axle	Saloon RWD 104942		Suspension Repair Kit	S990038SK
	1993.06-1995.06	Front Axle Left & Right	Saloon RWD 104942		Rod Assembly	S100073
	1993.06-1995.06	Front Axle Left & Right Centre	Saloon RWD 104942		Rod Assembly	S100075
	1993.06-1995.06	Front Axle Left & Right	Saloon RWD 104942		Tie Rod End	S070048
	1993.06-1995.06	Rear Axle Left & Right	Saloon RWD 104942		Rod/Strut, stabiliser	S100063
	1993.06-1995.06	Rear Axle	Saloon RWD 104942		Stabiliser Bushing	517269
	1993.06-1995.06	Front Axle	Saloon RWD 104942		Stabiliser Bushing Kit	519452S
2.8 (150 kw)	1997.04-2002.03	Front Axle Left Lower	Saloon RWD 112921		Track Control Arm	S060578
	1997.04-2002.03	Front Axle Left Upper	Saloon RWD 112921		Track Control Arm	S060214



	 YEAR	FITTING POSITION	BODY STYLE & DRIVE TYPE & ENGINE	REMARKS	PRODUCT	GSP Ref.
MERCEDES-BENZ E280						
2.8 (150 kw)	1997.04-2002.03	Front Axle Right Lower	Saloon RWD 112921		Track Control Arm	S060577
	1997.04-2002.03	Front Axle Right Upper	Saloon RWD 112921		Track Control Arm	S060215
	1997.04-2002.03	Rear Axle Left & Right Lower Inner	Saloon RWD 112921		Track Control Arm	S060217
	1997.04-2002.03	Rear Axle Left & Right Upper Inner	Saloon RWD 112921	not for armoured vehicles	Track Control Arm	S060216
	1997.04-2002.03	Rear Axle Left & Right Lower Outer	Saloon RWD 112921		Track Control Arm	S051055
	1997.04-2002.03	Rear Axle Left & Right Upper Outer	Saloon RWD 112921		Track Control Arm	S060218
	1997.04-2002.03	Front Axle Left & Right Lower	Saloon RWD 112921		Ball Joint	S080143
	1997.04-2002.03	Front Axle Left & Right Lower	Saloon RWD 112921		Control Arm Bushing	510471
	1997.04-2002.03	Front Axle Left & Right Upper	Saloon RWD 112921		Control Arm Bushing	510456
	1997.04-2002.03	Rear Axle Left & Right Lower	Saloon RWD 112921		Control Arm Bushing	511560
	1997.04-2002.03	Rear Axle Left & Right Upper Inner	Saloon RWD 112921		Control Arm Bushing	517809
	1997.04-2002.03	Rear Axle Left & Right Lower Outer	Saloon RWD 112921		Control Arm Bushing	510431
	1997.04-2002.03	Rear Axle Left & Right Lower Outer	Saloon RWD 112921		Control Arm Bushing	512252
	1997.04-2002.03	Rear Axle Left & Right Upper Outer	Saloon RWD 112921		Control Arm Bushing	510430
	1997.04-2002.03	Front Axle Left & Right Lower	Saloon RWD 112921		Control Arm Bushing Kit	510470S
	1997.04-2002.03	Rear Axle	Saloon RWD 112921		Suspension Repair Kit	S990038SK
	1997.04-2002.03	Front Axle Left & Right	Saloon RWD 112921		Tie Rod Axle Joint	S030853
	1997.04-2002.03	Front Axle Left	Saloon RWD 112921		Tie Rod End	S070312
	1997.04-2002.03	Front Axle Right	Saloon RWD 112921		Tie Rod End	S070313
	1997.04-2002.03	Front Axle Left	Saloon RWD 112921		Rod/Strut, stabiliser	510478
	1997.04-2002.03	Front Axle Right	Saloon RWD 112921		Rod/Strut, stabiliser	510479
	1997.04-2002.03	Rear Axle Left & Right	Saloon RWD 112921		Rod/Strut, stabiliser	S050272
	1997.04-2002.03	Rear Axle Left & Right	Saloon RWD 112921	not for armoured vehicles	Rod/Strut, stabiliser	S100063
	1997.04-2002.03	Front Axle Left & Right	Saloon RWD 112921		Stabiliser Bushing	530744
	1997.04-2002.03	Front Axle	Saloon RWD 112921		Stabiliser Bushing	512616
	1997.04-2002.03	Rear Axle	Saloon RWD 112921		Stabiliser Bushing	517269
	1997.04-2002.03	Front Axle	Saloon RWD 112921		Steering Boot	540204
	1997.04-2002.03	Front Axle	Saloon RWD 112921		Steering Boot	540345
	1997.04-2002.03	Front Axle	Saloon RWD 112921		Steering Boot	540443
3.0 (170 kw)	2005.03-2008.12	Front Axle Left Upper	Saloon RWD 272943		Track Control Arm	S060223
	2005.03-2008.12	Front Axle Left Lower Inner	Saloon RWD 272943		Track Control Arm	S060225
	2005.03-2008.12	Front Axle Left Lower Outer	Saloon RWD 272943		Track Control Arm	S060227
	2005.03-2008.12	Front Axle Right Upper	Saloon RWD 272943		Track Control Arm	S060224
	2005.03-2008.12	Front Axle Right Lower Inner	Saloon RWD 272943		Track Control Arm	S060226
	2005.03-2008.12	Rear Axle Left Upper Inner	Saloon RWD 272943		Track Control Arm	S060231
	2005.03-2008.12	Rear Axle Left Upper Outer	Saloon RWD 272943		Track Control Arm	S060229
	2005.03-2008.12	Rear Axle Right Upper Inner	Saloon RWD 272943		Track Control Arm	S060232
	2005.03-2008.12	Rear Axle Right Upper Outer	Saloon RWD 272943		Track Control Arm	S060230
	2005.03-2008.12	Rear Axle Left & Right Lower Inner	Saloon RWD 272943		Track Control Arm	S060233
	2005.03-2008.12	Front Axle Left & Right Upper	Saloon RWD 272943		Ball Joint	S080145
	2005.03-2008.12	Front Axle Left & Right Lower Inner	Saloon RWD 272943	for OE No.211 330 81 07	Ball Joint	S080134
	2005.03-2008.12	Front Axle Left & Right Lower Inner	Saloon RWD 272943		Ball Joint	S080136
	2005.03-2008.12	Front Axle Left & Right Upper	Saloon RWD 272943		Control Arm Bushing	510529
	2005.03-2008.12	Front Axle Left & Right Lower Inner	Saloon RWD 272943		Control Arm Bushing	518119
	2005.03-2008.12	Front Axle Left & Right Lower Inner	Saloon RWD 272943		Control Arm Bushing	518120
	2005.03-2008.12	Front Axle Left & Right Lower Outer	Saloon RWD 272943		Control Arm Bushing	510518
	2005.03-2008.12	Front Axle Left & Right Lower Outer	Saloon RWD 272943		Control Arm Bushing	530133
	2005.03-2008.12	Rear Axle Left & Right Lower Inner	Saloon RWD 272943		Control Arm Bushing	530527
	2005.03-2008.12	Rear Axle Left & Right Upper Inner	Saloon RWD 272943		Control Arm Bushing	510521
	2005.03-2008.12	Rear Axle Left & Right Upper Outer	Saloon RWD 272943		Control Arm Bushing	510522
	2005.03-2008.12	Front Axle	Saloon RWD 272943		Suspension Repair Kit	S990007SK
	2005.03-2008.12	Front Axle	Saloon RWD 272943		Suspension Repair Kit	S990035SK
	2005.03-2008.12	Front Axle	Saloon RWD 272943		Suspension Repair Kit	S990039SK
	2005.03-2008.12	Rear Axle	Saloon RWD 272943		Suspension Repair Kit	S990056SK
	2005.03-2008.12	Front Axle Left & Right	Saloon RWD 272943		Tie Rod Axle Joint	S030853
	2005.03-2008.12	Front Axle Left	Saloon RWD 272943		Tie Rod End	S070286
	2005.03-2008.12	Front Axle Right	Saloon RWD 272943		Tie Rod End	S070287
	2005.03-2008.12	Front Axle Left	Saloon RWD 272943		Rod/Strut, stabiliser	510516
	2005.03-2008.12	Front Axle Right	Saloon RWD 272943		Rod/Strut, stabiliser	510515
	2005.03-2008.12	Front Axle	Saloon RWD 272943		Stabiliser Bushing	510514
	2005.03-2008.12	Front Axle Left	Saloon RWD 272943	for left-hand drive vehicles, VIN from: B 125934	Steering Rack Bellow Kit	540204S
	2005.03-2008.12	Front Axle Right	Saloon RWD 272943	for right-hand drive vehicles, VIN from: B 125934	Steering Rack Bellow Kit	540204S



	 YEAR	FITTING POSITION	BODY STYLE & DRIVE TYPE & ENGINE	REMARKS	PRODUCT	GSP Ref.
MERCEDES-BENZ E300						
2.0 (180 kw)	2016.12-	Front Axle Left Upper	Coupe RWD 274920		Track Control Arm	S062802
	2016.12-	Front Axle Left Lower Inner	Coupe RWD 274920		Track Control Arm	S062805
	2016.12-	Front Axle Left Lower Outer	Coupe RWD 274920		Track Control Arm	S062844
	2016.12-	Front Axle Right Upper	Coupe RWD 274920		Track Control Arm	S062801
	2016.12-	Front Axle Right Lower Inner	Coupe RWD 274920		Track Control Arm	S062806
	2016.12-	Rear Axle Left Upper Inner	Coupe RWD 274920		Track Control Arm	S063227
	2016.12-	Rear Axle Left Lower Outer	Coupe RWD 274920		Track Control Arm	S061566
	2016.12-	Rear Axle Right Upper Inner	Coupe RWD 274920		Track Control Arm	S063228
	2016.12-	Rear Axle Right Lower Outer	Coupe RWD 274920		Track Control Arm	S061567
	2016.12-	Front Axle Left & Right Upper	Coupe RWD 274920		Control Arm Bushing	510529
	2016.12-	Front Axle Left & Right Lower Inner	Coupe RWD 274920		Control Arm Bushing	533481
	2016.12-	Front Axle Left & Right Lower Inner	Coupe RWD 274920		Control Arm Bushing	533482
	2016.12-	Front Axle Left & Right Lower Inner	Coupe RWD 274920		Control Arm Bushing	535418
	2016.12-	Front Axle Left & Right Lower Outer	Coupe RWD 274920		Control Arm Bushing	535456
	2016.12-	Rear Axle Left & Right Upper	Coupe RWD 274920		Control Arm Bushing	532971
	2016.12-	Rear Axle Left & Right Upper Inner	Coupe RWD 274920		Control Arm Bushing	530504
	2016.12-	Rear Axle Left & Right Upper Inner	Coupe RWD 274920		Control Arm Bushing	533480
	2016.12-	Rear Axle Left & Right Lower Outer	Coupe RWD 274920		Control Arm Bushing	516552
	2016.12-	Front Axle Left & Right	Coupe RWD 274920		Tie Rod Axle Joint	S030926
	2016.12-	Front Axle Left	Coupe RWD 274920		Tie Rod End	S071616
	2016.12-	Front Axle Right	Coupe RWD 274920		Tie Rod End	S071617
	2016.12-	Rear Axle Left	Coupe RWD 274920		Rod/Strut, stabiliser	S051247
	2016.12-	Rear Axle Right	Coupe RWD 274920		Rod/Strut, stabiliser	S051248
	2017.06-	Front Axle Left Upper	Cabriolet RWD 274920		Track Control Arm	S062802
	2017.06-	Front Axle Left Lower Inner	Cabriolet RWD 274920		Track Control Arm	S062805
	2017.06-	Front Axle Left Lower Outer	Cabriolet RWD 274920		Track Control Arm	S062844
	2017.06-	Front Axle Right Upper	Cabriolet RWD 274920		Track Control Arm	S062801
	2017.06-	Front Axle Right Lower Inner	Cabriolet RWD 274920		Track Control Arm	S062806
	2017.06-	Rear Axle Left Upper Inner	Cabriolet RWD 274920		Track Control Arm	S063227
	2017.06-	Rear Axle Left Lower Outer	Cabriolet RWD 274920		Track Control Arm	S061566
	2017.06-	Rear Axle Right Upper Inner	Cabriolet RWD 274920		Track Control Arm	S063228
	2017.06-	Rear Axle Right Lower Outer	Cabriolet RWD 274920		Track Control Arm	S061567
	2017.06-	Front Axle Left & Right Upper	Cabriolet RWD 274920		Control Arm Bushing	510529
	2017.06-	Front Axle Left & Right Lower Inner	Cabriolet RWD 274920		Control Arm Bushing	533481
	2017.06-	Front Axle Left & Right Lower Inner	Cabriolet RWD 274920		Control Arm Bushing	533482
	2017.06-	Front Axle Left & Right Lower Inner	Cabriolet RWD 274920		Control Arm Bushing	535418
	2017.06-	Front Axle Left & Right Lower Outer	Cabriolet RWD 274920		Control Arm Bushing	535456
	2017.06-	Rear Axle Left & Right Upper	Cabriolet RWD 274920		Control Arm Bushing	532971
	2017.06-	Rear Axle Left & Right Upper Inner	Cabriolet RWD 274920		Control Arm Bushing	530504
	2017.06-	Rear Axle Left & Right Upper Inner	Cabriolet RWD 274920		Control Arm Bushing	533480
	2017.06-	Rear Axle Left & Right Lower Outer	Cabriolet RWD 274920		Control Arm Bushing	516552
	2017.06-	Front Axle Left & Right	Cabriolet RWD 274920		Tie Rod Axle Joint	S030926
	2017.06-	Front Axle Left	Cabriolet RWD 274920		Tie Rod End	S071616
	2017.06-	Front Axle Right	Cabriolet RWD 274920		Tie Rod End	S071617
	2017.06-	Rear Axle Left	Cabriolet RWD 274920		Rod/Strut, stabiliser	S051247
	2017.06-	Rear Axle Right	Cabriolet RWD 274920		Rod/Strut, stabiliser	S051248
2.0 (190 kw)	2019.02-	Front Axle Left Lower Outer	Saloon RWD 264920/274920		Track Control Arm	S062844
	2019.02-	Rear Axle Left Lower Outer	Saloon RWD 264920/274920		Track Control Arm	S061566
	2019.02-	Rear Axle Right Lower Outer	Saloon RWD 264920/274920		Track Control Arm	S061567
	2019.02-	Front Axle Left & Right Lower Inner	Saloon RWD 264920/274920		Control Arm Bushing	533482
	2019.02-	Front Axle Left & Right Lower Inner	Saloon RWD 264920/274920		Control Arm Bushing	535418
	2019.02-	Rear Axle Left & Right Lower Outer	Saloon RWD 264920/274920		Control Arm Bushing	516552
	2019.02-	Front Axle Left & Right	Saloon RWD 264920/274920		Tie Rod Axle Joint	S030926
	2019.02-	Front Axle Left	Saloon RWD 264920/274920		Tie Rod End	S071616
	2019.02-	Front Axle Right	Saloon RWD 264920/274920		Tie Rod End	S071617
E320						
3.2 (162 kw)	1993.06-1995.06	Rear Axle Left & Right Lower Inner	Saloon RWD 104992		Track Control Arm	S060217
	1993.06-1995.06	Rear Axle Left & Right Upper Inner	Saloon RWD 104992		Track Control Arm	S060216
	1993.06-1995.06	Rear Axle Left & Right Lower Outer	Saloon RWD 104992		Track Control Arm	S051055
	1993.06-1995.06	Rear Axle Left & Right Upper Outer	Saloon RWD 104992		Track Control Arm	S060218
	1993.06-1995.06	Front Axle Left & Right Lower	Saloon RWD 104992		Control Arm Bushing	510427
	1993.06-1995.06	Front Axle Left & Right Lower	Saloon RWD 104992		Control Arm Bushing	510428
	1993.06-1995.06	Front Axle Left & Right Lower	Saloon RWD 104992		Control Arm Bushing	510564
	1993.06-1995.06	Rear Axle Left & Right Lower	Saloon RWD 104992		Control Arm Bushing	511560



	 YEAR	FITTING POSITION	BODY STYLE & DRIVE TYPE & ENGINE	REMARKS	PRODUCT	GSP Ref.
MERCEDES-BENZ						
E320						
3.2 (162 kw)	1993.06-1995.06	Rear Axle Left & Right Upper Inner	Saloon RWD 104992		Control Arm Bushing	517809
	1993.06-1995.06	Rear Axle Left & Right Lower Outer	Saloon RWD 104992		Control Arm Bushing	510431
	1993.06-1995.06	Rear Axle Left & Right Lower Outer	Saloon RWD 104992		Control Arm Bushing	512252
	1993.06-1995.06	Rear Axle Left & Right Upper Outer	Saloon RWD 104992		Control Arm Bushing	510430
	1993.06-1995.06	Rear Axle	Saloon RWD 104992		Suspension Repair Kit	S990038SK
	1993.06-1995.06	Front Axle Left & Right	Saloon RWD 104992		Rod Assembly	S100073
	1993.06-1995.06	Front Axle Left & Right Centre	Saloon RWD 104992		Rod Assembly	S100075
	1993.06-1995.06	Front Axle Left & Right	Saloon RWD 104992		Tie Rod End	S070048
	1993.06-1995.06	Front Axle Left & Right	Saloon RWD 104992		Tie Rod End	S070308
	1993.06-1995.06	Rear Axle Left & Right	Saloon RWD 104992		Rod/Strut, stabiliser	S100063
	1993.06-1995.06	Front Axle Left & Right Outer	Saloon RWD 104992		Stabiliser Bushing	511553
	1993.06-1995.06	Front Axle	Saloon RWD 104992		Stabiliser Bushing	517172
	1993.06-1995.06	Rear Axle	Saloon RWD 104992		Stabiliser Bushing	517269
	1993.06-1995.06	Front Axle	Saloon RWD 104992		Stabiliser Bushing Kit	519452S
	1993.06-1995.06	Rear Axle	Saloon RWD 104992		Stabiliser Bushing Kit	531455S
	1993.06-1996.01	Rear Axle Left & Right Lower Inner	Estate RWD 104992		Track Control Arm	S060217
	1993.06-1996.01	Rear Axle Left & Right Upper Inner	Estate RWD 104992		Track Control Arm	S060216
	1993.06-1996.01	Rear Axle Left & Right Lower Outer	Estate RWD 104992		Track Control Arm	S051055
	1993.06-1996.01	Rear Axle Left & Right Upper Outer	Estate RWD 104992		Track Control Arm	S060218
	1993.06-1996.01	Rear Axle Left & Right Lower	Estate RWD 104992		Control Arm Bushing	511560
	1993.06-1996.01	Rear Axle Left & Right Upper Inner	Estate RWD 104992		Control Arm Bushing	517809
	1993.06-1996.01	Rear Axle Left & Right Lower Outer	Estate RWD 104992		Control Arm Bushing	510431
	1993.06-1996.01	Rear Axle Left & Right Lower Outer	Estate RWD 104992		Control Arm Bushing	512252
	1993.06-1996.01	Rear Axle Left & Right Upper Outer	Estate RWD 104992		Control Arm Bushing	510430
	1993.06-1996.01	Rear Axle	Estate RWD 104992		Suspension Repair Kit	S990038SK
	1993.06-1996.01	Front Axle Left & Right	Estate RWD 104992		Rod Assembly	S100073
	1993.06-1996.01	Front Axle Left & Right	Estate RWD 104992		Tie Rod End	S070048
	1993.06-1996.01	Rear Axle Left & Right	Estate RWD 104992		Rod/Strut, stabiliser	S050272
	1993.06-1996.01	Front Axle	Estate RWD 104992		Stabiliser Bushing	512608
	1993.06-1996.01	Rear Axle	Estate RWD 104992		Stabiliser Bushing	517269
	1993.06-1996.01	Rear Axle	Estate RWD 104992		Stabiliser Bushing Kit	531455S
	1995.07-1997.06	Front Axle Left Lower	Saloon RWD 104995		Track Control Arm	S060578
	1995.07-1997.06	Front Axle Left Upper	Saloon RWD 104995		Track Control Arm	S060214
	1995.07-1997.06	Front Axle Right Lower	Saloon RWD 104995		Track Control Arm	S060577
	1995.07-1997.06	Front Axle Right Upper	Saloon RWD 104995		Track Control Arm	S060215
	1995.07-1997.06	Rear Axle Left & Right Lower Inner	Saloon RWD 104995		Track Control Arm	S060217
	1995.07-1997.06	Rear Axle Left & Right Upper Inner	Saloon RWD 104995	Chassis no.from:A 597177,X 007199	Track Control Arm	S060216
	1995.07-1997.06	Rear Axle Left & Right Lower Outer	Saloon RWD 104995		Track Control Arm	S051055
	1995.07-1997.06	Front Axle Left & Right Lower	Saloon RWD 104995		Ball Joint	S080143
	1995.07-1997.06	Front Axle Left & Right Upper	Saloon RWD 104995		Control Arm Bushing	510456
	1995.07-1997.06	Rear Axle Left & Right Lower	Saloon RWD 104995		Control Arm Bushing	511560
	1995.07-1997.06	Rear Axle Left & Right Upper Inner	Saloon RWD 104995		Control Arm Bushing	517809
	1995.07-1997.06	Rear Axle Left & Right Lower Outer	Saloon RWD 104995		Control Arm Bushing	512252
	1995.07-1997.06	Front Axle Left & Right Lower	Saloon RWD 104995		Control Arm Bushing Kit	510470S
	1995.07-1997.06	Rear Axle	Saloon RWD 104995		Suspension Repair Kit	S990038SK
	1995.07-1997.06	Front Axle Left & Right	Saloon RWD 104995		Tie Rod Axle Joint	S030853
	1995.07-1997.06	Front Axle Left	Saloon RWD 104995		Tie Rod End	S070312
	1995.07-1997.06	Front Axle Right	Saloon RWD 104995		Tie Rod End	S070313
	1995.07-1997.06	Front Axle Left	Saloon RWD 104995		Rod/Strut, stabiliser	510478
	1995.07-1997.06	Front Axle Right	Saloon RWD 104995		Rod/Strut, stabiliser	510479
	1995.07-1997.06	Rear Axle Left & Right	Saloon RWD 104995		Rod/Strut, stabiliser	S100063
	1995.07-1997.06	Rear Axle	Saloon RWD 104995		Stabiliser Bushing	517269
	1995.07-1997.06	Front Axle	Saloon RWD 104995		Steering Boot	540204
	1995.07-1997.06	Front Axle	Saloon RWD 104995		Steering Boot	540345
3.2 (165 kw)	1997.04-2002.03	Front Axle Left Lower	Saloon RWD 112941		Track Control Arm	S060578
	1997.04-2002.03	Front Axle Left Upper	Saloon RWD 112941		Track Control Arm	S060214
	1997.04-2002.03	Front Axle Right Lower	Saloon RWD 112941		Track Control Arm	S060577
	1997.04-2002.03	Front Axle Right Upper	Saloon RWD 112941		Track Control Arm	S060215
	1997.04-2002.03	Rear Axle Left & Right Lower Inner	Saloon RWD 112941		Track Control Arm	S060217
	1997.04-2002.03	Rear Axle Left & Right Upper Inner	Saloon RWD 112941		Track Control Arm	S060216
	1997.04-2002.03	Rear Axle Left & Right Lower Outer	Saloon RWD 112941		Track Control Arm	S051055
	1997.04-2002.03	Rear Axle Left & Right Upper Outer	Saloon RWD 112941		Track Control Arm	S060218
	1997.04-2002.03	Front Axle Left & Right Lower	Saloon RWD 112941		Ball Joint	S080143
	1997.04-2002.03	Front Axle Left & Right Lower	Saloon RWD 112941		Control Arm Bushing	510471



	 YEAR	FITTING POSITION	BODY STYLE & DRIVE TYPE & ENGINE	REMARKS	PRODUCT	GSP Ref.
MERCEDES-BENZ						
E320						
3.2 (165 kw)	1997.04-2002.03	Front Axle Left & Right Upper	Saloon RWD 112941		Control Arm Bushing	510456
	1997.04-2002.03	Rear Axle Left & Right Lower	Saloon RWD 112941		Control Arm Bushing	511560
	1997.04-2002.03	Rear Axle Left & Right Upper Inner	Saloon RWD 112941		Control Arm Bushing	517809
	1997.04-2002.03	Rear Axle Left & Right Lower Outer	Saloon RWD 112941		Control Arm Bushing	510431
	1997.04-2002.03	Rear Axle Left & Right Lower Outer	Saloon RWD 112941		Control Arm Bushing	512252
	1997.04-2002.03	Rear Axle Left & Right Upper Outer	Saloon RWD 112941		Control Arm Bushing	510430
	1997.04-2002.03	Front Axle Left & Right Lower	Saloon RWD 112941		Control Arm Bushing Kit	510470S
	1997.04-2002.03	Rear Axle	Saloon RWD 112941		Suspension Repair Kit	S990038SK
	1997.04-2002.03	Front Axle Left & Right	Saloon RWD 112941		Tie Rod Axle Joint	S030853
	1997.04-2002.03	Front Axle Left	Saloon RWD 112941		Tie Rod End	S070312
	1997.04-2002.03	Front Axle Right	Saloon RWD 112941		Tie Rod End	S070313
	1997.04-2002.03	Front Axle Left	Saloon RWD 112941		Rod/Strut, stabiliser	510478
	1997.04-2002.03	Front Axle Right	Saloon RWD 112941		Rod/Strut, stabiliser	510479
	1997.04-2002.03	Rear Axle Left & Right	Saloon RWD 112941		Rod/Strut, stabiliser	S050272
	1997.04-2002.03	Rear Axle Left & Right	Saloon RWD 112941	not for armoured vehicles	Rod/Strut, stabiliser	S100063
	1997.04-2002.03	Front Axle Left & Right	Saloon RWD 112941		Stabiliser Bushing	530744
	1997.04-2002.03	Front Axle	Saloon RWD 112941		Stabiliser Bushing	512616
	1997.04-2002.03	Rear Axle	Saloon RWD 112941		Stabiliser Bushing	517269
	1997.04-2002.03	Front Axle	Saloon RWD 112941		Steering Boot	540204
	1997.04-2002.03	Front Axle	Saloon RWD 112941		Steering Boot	540345
	1997.04-2002.03	Front Axle	Saloon RWD 112941		Steering Boot	540443
	1997.04-2003.05	Front Axle Left Lower	Estate RWD 112941		Track Control Arm	S060578
	1997.04-2003.05	Front Axle Left Upper	Estate RWD 112941		Track Control Arm	S060214
	1997.04-2003.05	Front Axle Right Lower	Estate RWD 112941		Track Control Arm	S060577
	1997.04-2003.05	Front Axle Right Upper	Estate RWD 112941		Track Control Arm	S060215
	1997.04-2003.05	Rear Axle Left & Right Lower Inner	Estate RWD 112941		Track Control Arm	S060217
	1997.04-2003.05	Rear Axle Left & Right Lower Outer	Estate RWD 112941		Track Control Arm	S051055
	1997.04-2003.05	Rear Axle Left & Right Upper Outer	Estate RWD 112941		Track Control Arm	S060218
	1997.04-2003.05	Front Axle Left & Right Lower	Estate RWD 112941		Ball Joint	S080143
	1997.04-2003.05	Front Axle Left & Right Lower	Estate RWD 112941		Control Arm Bushing	510471
	1997.04-2003.05	Front Axle Left & Right Upper	Estate RWD 112941		Control Arm Bushing	510456
	1997.04-2003.05	Rear Axle Left & Right Lower	Estate RWD 112941		Control Arm Bushing	511560
	1997.04-2003.05	Rear Axle Left & Right Upper Inner	Estate RWD 112941		Control Arm Bushing	517809
	1997.04-2003.05	Rear Axle Left & Right Lower Outer	Estate RWD 112941		Control Arm Bushing	510431
	1997.04-2003.05	Rear Axle Left & Right Lower Outer	Estate RWD 112941		Control Arm Bushing	512252
	1997.04-2003.05	Rear Axle Left & Right Upper Outer	Estate RWD 112941		Control Arm Bushing	510430
	1997.04-2003.05	Front Axle Left & Right Lower	Estate RWD 112941		Control Arm Bushing Kit	510470S
	1997.04-2003.05	Rear Axle	Estate RWD 112941		Suspension Repair Kit	S990038SK
	1997.04-2003.05	Front Axle Left & Right	Estate RWD 112941		Tie Rod Axle Joint	S030853
	1997.04-2003.05	Front Axle Left	Estate RWD 112941		Tie Rod End	S070312
	1997.04-2003.05	Front Axle Right	Estate RWD 112941		Tie Rod End	S070313
	1997.04-2003.05	Front Axle Left	Estate RWD 112941		Rod/Strut, stabiliser	510478
	1997.04-2003.05	Front Axle Right	Estate RWD 112941		Rod/Strut, stabiliser	510479
	1997.04-2003.05	Rear Axle Left & Right	Estate RWD 112941		Rod/Strut, stabiliser	S050272
	1997.04-2003.05	Front Axle Left & Right	Estate RWD 112941		Stabiliser Bushing	530744
	1997.04-2003.05	Front Axle	Estate RWD 112941		Steering Boot	540345
	1997.04-2003.05	Front Axle	Estate RWD 112941		Steering Boot	540443
	2002.04-2004.07	Front Axle Left Upper	Saloon RWD 112949		Track Control Arm	S060223
	2002.04-2004.07	Front Axle Left Lower Inner	Saloon RWD 112949		Track Control Arm	S060225
	2002.04-2004.07	Front Axle Left Lower Outer	Saloon RWD 112949		Track Control Arm	S060227
	2002.04-2004.07	Front Axle Right Upper	Saloon RWD 112949		Track Control Arm	S060224
	2002.04-2004.07	Front Axle Right Lower Inner	Saloon RWD 112949		Track Control Arm	S060226
	2002.04-2004.07	Front Axle Right Lower Outer	Saloon RWD 112949		Track Control Arm	S060228
	2002.04-2004.07	Rear Axle Left Upper Inner	Saloon RWD 112949		Track Control Arm	S060231
	2002.04-2004.07	Rear Axle Left Upper Outer	Saloon RWD 112949		Track Control Arm	S060229
	2002.04-2004.07	Rear Axle Right Upper Inner	Saloon RWD 112949		Track Control Arm	S060232
	2002.04-2004.07	Rear Axle Right Upper Outer	Saloon RWD 112949		Track Control Arm	S060230
	2002.04-2004.07	Rear Axle Left & Right Lower Inner	Saloon RWD 112949		Track Control Arm	S060233
	2002.04-2004.07	Front Axle Left & Right Upper	Saloon RWD 112949		Ball Joint	S080145
	2002.04-2004.07	Front Axle Left & Right Lower Inner	Saloon RWD 112949	for OE No.211 330 81 07	Ball Joint	S080134
	2002.04-2004.07	Front Axle Left & Right Lower Inner	Saloon RWD 112949		Ball Joint	S080136
	2002.04-2004.07	Front Axle Left & Right Upper	Saloon RWD 112949		Control Arm Bushing	510529
	2002.04-2004.07	Front Axle Left & Right Lower Inner	Saloon RWD 112949		Control Arm Bushing	518119
	2002.04-2004.07	Front Axle Left & Right Lower Inner	Saloon RWD 112949		Control Arm Bushing	518120



	 YEAR	FITTING POSITION	BODY STYLE & DRIVE TYPE & ENGINE	REMARKS	PRODUCT	GSP Ref.
MERCEDES-BENZ						
E320						
3.2 (165 kw)						
	2002.04-2004.07	Front Axle Left & Right Lower Outer	Saloon RWD 112949		Control Arm Bushing	510518
	2002.04-2004.07	Front Axle Left & Right Lower Outer	Saloon RWD 112949		Control Arm Bushing	530133
	2002.04-2004.07	Rear Axle Left & Right Lower Inner	Saloon RWD 112949		Control Arm Bushing	530527
	2002.04-2004.07	Rear Axle Left & Right Upper Inner	Saloon RWD 112949		Control Arm Bushing	510521
	2002.04-2004.07	Rear Axle Left & Right Upper Outer	Saloon RWD 112949		Control Arm Bushing	510522
	2002.04-2004.07	Front Axle	Saloon RWD 112949		Suspension Repair Kit	S990007SK
	2002.04-2004.07	Front Axle	Saloon RWD 112949		Suspension Repair Kit	S990039SK
	2002.04-2004.07	Rear Axle	Saloon RWD 112949		Suspension Repair Kit	S990056SK
	2002.04-2004.07	Front Axle Left & Right	Saloon RWD 112949		Tie Rod Axle Joint	S030853
	2002.04-2004.07	Front Axle Left	Saloon RWD 112949		Tie Rod End	S070286
	2002.04-2004.07	Front Axle Right	Saloon RWD 112949		Tie Rod End	S070287
	2002.04-2004.07	Front Axle Left	Saloon RWD 112949		Rod/Strut, stabiliser	510516
	2002.04-2004.07	Front Axle Right	Saloon RWD 112949		Rod/Strut, stabiliser	510515
	2002.04-2004.07	Front Axle	Saloon RWD 112949		Stabiliser Bushing	510514
	2002.04-2004.07	Front Axle	Saloon RWD 112949	Date to:2004.07	Steering Rack Bellow Kit	540204S
	2003.04-2004.07	Front Axle Left Upper	Estate RWD 112949		Track Control Arm	S060223
	2003.04-2004.07	Front Axle Left Lower Inner	Estate RWD 112949		Track Control Arm	S060225
	2003.04-2004.07	Front Axle Left Lower Outer	Estate RWD 112949		Track Control Arm	S060227
	2003.04-2004.07	Front Axle Right Upper	Estate RWD 112949		Track Control Arm	S060224
	2003.04-2004.07	Front Axle Right Lower Inner	Estate RWD 112949		Track Control Arm	S060226
	2003.04-2004.07	Front Axle Right Lower Outer	Estate RWD 112949		Track Control Arm	S060228
	2003.04-2004.07	Rear Axle Left Upper Inner	Estate RWD 112949		Track Control Arm	S060231
	2003.04-2004.07	Rear Axle Left Upper Outer	Estate RWD 112949		Track Control Arm	S060229
	2003.04-2004.07	Rear Axle Right Upper Inner	Estate RWD 112949		Track Control Arm	S060232
	2003.04-2004.07	Rear Axle Right Upper Outer	Estate RWD 112949		Track Control Arm	S060230
	2003.04-2004.07	Rear Axle Left & Right Lower Inner	Estate RWD 112949		Track Control Arm	S060233
	2003.04-2004.07	Front Axle Left & Right Upper	Estate RWD 112949		Ball Joint	S080145
	2003.04-2004.07	Front Axle Left & Right Lower Inner	Estate RWD 112949	for OE No.211 330 81 07	Ball Joint	S080134
	2003.04-2004.07	Front Axle Left & Right Lower Inner	Estate RWD 112949		Ball Joint	S080136
	2003.04-2004.07	Front Axle Left & Right Upper	Estate RWD 112949		Control Arm Bushing	510502
	2003.04-2004.07	Front Axle Left & Right Upper	Estate RWD 112949		Control Arm Bushing	510529
	2003.04-2004.07	Front Axle Left & Right Lower Inner	Estate RWD 112949		Control Arm Bushing	518119
	2003.04-2004.07	Front Axle Left & Right Lower Inner	Estate RWD 112949		Control Arm Bushing	518120
	2003.04-2004.07	Front Axle Left & Right Lower Outer	Estate RWD 112949		Control Arm Bushing	510518
	2003.04-2004.07	Front Axle Left & Right Lower Outer	Estate RWD 112949		Control Arm Bushing	530133
	2003.04-2004.07	Rear Axle Left & Right Lower Inner	Estate RWD 112949		Control Arm Bushing	530527
	2003.04-2004.07	Rear Axle Left & Right Upper Inner	Estate RWD 112949		Control Arm Bushing	510521
	2003.04-2004.07	Rear Axle Left & Right Upper Outer	Estate RWD 112949		Control Arm Bushing	510522
	2003.04-2004.07	Front Axle	Estate RWD 112949		Suspension Repair Kit	S990007SK
	2003.04-2004.07	Front Axle	Estate RWD 112949		Suspension Repair Kit	S990035SK
	2003.04-2004.07	Front Axle	Estate RWD 112949		Suspension Repair Kit	S990039SK
	2003.04-2004.07	Rear Axle	Estate RWD 112949		Suspension Repair Kit	S990056SK
	2003.04-2004.07	Front Axle Left & Right	Estate RWD 112949		Tie Rod Axle Joint	S030853
	2003.04-2004.07	Front Axle Left	Estate RWD 112949		Tie Rod End	S070286
	2003.04-2004.07	Front Axle Right	Estate RWD 112949		Tie Rod End	S070287
	2003.04-2004.07	Front Axle Left	Estate RWD 112949		Rod/Strut, stabiliser	510516
	2003.04-2004.07	Front Axle Right	Estate RWD 112949		Rod/Strut, stabiliser	510515
	2003.04-2004.07	Front Axle	Estate RWD 112949		Stabiliser Bushing	510514
	2003.04-2004.07	Front Axle	Estate RWD 112949	Date to:2004.07	Steering Rack Bellow Kit	540204S
E350						
3.5 (200 kw)						
	2004.08-2008.12	Front Axle Left Upper	Saloon RWD 272964		Track Control Arm	S060223
	2004.08-2008.12	Front Axle Left Lower Inner	Saloon RWD 272964		Track Control Arm	S060225
	2004.08-2008.12	Front Axle Left Lower Outer	Saloon RWD 272964		Track Control Arm	S060227
	2004.08-2008.12	Front Axle Right Upper	Saloon RWD 272964		Track Control Arm	S060224
	2004.08-2008.12	Front Axle Right Lower Inner	Saloon RWD 272964		Track Control Arm	S060226
	2004.08-2008.12	Rear Axle Left Upper Inner	Saloon RWD 272964		Track Control Arm	S060231
	2004.08-2008.12	Rear Axle Left Upper Outer	Saloon RWD 272964		Track Control Arm	S060229
	2004.08-2008.12	Rear Axle Right Upper Inner	Saloon RWD 272964		Track Control Arm	S060232
	2004.08-2008.12	Rear Axle Right Upper Outer	Saloon RWD 272964		Track Control Arm	S060230
	2004.08-2008.12	Rear Axle Left & Right Lower Inner	Saloon RWD 272964		Track Control Arm	S060233
	2004.08-2008.12	Front Axle Left & Right Upper	Saloon RWD 272964		Ball Joint	S080145
	2004.08-2008.12	Front Axle Left & Right Lower Inner	Saloon RWD 272964	for OE No.211 330 81 07	Ball Joint	S080134
	2004.08-2008.12	Front Axle Left & Right Lower Inner	Saloon RWD 272964		Ball Joint	S080136
	2004.08-2008.12	Front Axle Left & Right Upper	Saloon RWD 272964		Control Arm Bushing	510529



	 YEAR	FITTING POSITION	BODY STYLE & DRIVE TYPE & ENGINE	REMARKS	PRODUCT	GSP Ref.
MERCEDES-BENZ						
E350						
3.5 (200 kw)	2004.08-2008.12	Front Axle Left & Right Lower Inner	Saloon RWD 272964		Control Arm Bushing	518119
	2004.08-2008.12	Front Axle Left & Right Lower Inner	Saloon RWD 272964		Control Arm Bushing	518120
	2004.08-2008.12	Front Axle Left & Right Lower Outer	Saloon RWD 272964		Control Arm Bushing	510518
	2004.08-2008.12	Front Axle Left & Right Lower Outer	Saloon RWD 272964		Control Arm Bushing	530133
	2004.08-2008.12	Rear Axle Left & Right Lower Inner	Saloon RWD 272964		Control Arm Bushing	530527
	2004.08-2008.12	Rear Axle Left & Right Upper Inner	Saloon RWD 272964		Control Arm Bushing	510521
	2004.08-2008.12	Rear Axle Left & Right Upper Outer	Saloon RWD 272964		Control Arm Bushing	510522
	2004.08-2008.12	Front Axle	Saloon RWD 272964		Suspension Repair Kit	S990007SK
	2004.08-2008.12	Front Axle	Saloon RWD 272964		Suspension Repair Kit	S990035SK
	2004.08-2008.12	Front Axle	Saloon RWD 272964		Suspension Repair Kit	S990039SK
	2004.08-2008.12	Rear Axle	Saloon RWD 272964		Suspension Repair Kit	S990056SK
	2004.08-2008.12	Front Axle Left & Right	Saloon RWD 272964		Tie Rod Axle Joint	S030853
	2004.08-2008.12	Front Axle Left	Saloon RWD 272964		Tie Rod End	S070286
	2004.08-2008.12	Front Axle Right	Saloon RWD 272964		Tie Rod End	S070287
	2004.08-2008.12	Front Axle Left	Saloon RWD 272964		Rod/Strut, stabiliser	510516
	2004.08-2008.12	Front Axle Right	Saloon RWD 272964		Rod/Strut, stabiliser	510515
	2004.08-2008.12	Front Axle	Saloon RWD 272964		Stabiliser Bushing	510514
	2004.08-2008.12	Front Axle Left	Saloon RWD 272964	for left-hand drive vehicles, VIN from B 125934	Steering Rack Bellow Kit	540204S
	2004.08-2008.12	Front Axle Right	Saloon RWD 272964	for right-hand drive vehicles, VIN from B 125934	Steering Rack Bellow Kit	540204S
	2009.01-2013.12	Front Axle Left Lower Inner	Saloon RWD 272980		Track Control Arm	S061637
	2009.01-2013.12	Front Axle Left Lower Outer	Saloon RWD 272980		Track Control Arm	S061607
	2009.01-2013.12	Front Axle Right Lower Inner	Saloon RWD 272980		Track Control Arm	S061638
	2009.01-2013.12	Front Axle Right Lower Outer	Saloon RWD 272980		Track Control Arm	S061608
	2009.01-2013.12	Rear Axle Left Upper Inner	Saloon RWD 272980		Track Control Arm	S063227
	2009.01-2013.12	Rear Axle Left Lower Outer	Saloon RWD 272980		Track Control Arm	S061566
	2009.01-2013.12	Rear Axle Left Upper Outer	Saloon RWD 272980		Track Control Arm	S062798
	2009.01-2013.12	Rear Axle Right Upper Inner	Saloon RWD 272980		Track Control Arm	S063228
	2009.01-2013.12	Rear Axle Right Lower Outer	Saloon RWD 272980		Track Control Arm	S061567
	2009.01-2013.12	Rear Axle Right Upper Outer	Saloon RWD 272980		Track Control Arm	S062797
	2009.01-2013.12	Rear Axle Left & Right Lower Inner	Saloon RWD 272980		Track Control Arm	S062799
	2009.01-2013.12	Front Axle Left & Right Lower Outer	Saloon RWD 272980		Ball Joint	S080671
	2009.01-2013.12	Front Axle Left & Right Lower Inner	Saloon RWD 272980		Control Arm Bushing	517477
	2009.01-2013.12	Front Axle Left & Right Lower Outer	Saloon RWD 272980		Control Arm Bushing	531452
	2009.01-2013.12	Rear Axle Left & Right Lower Inner	Saloon RWD 272980		Control Arm Bushing	530527
	2009.01-2013.12	Rear Axle Left & Right Upper Inner	Saloon RWD 272980		Control Arm Bushing	516563
	2009.01-2013.12	Rear Axle Left & Right Upper Inner	Saloon RWD 272980		Control Arm Bushing	530504
	2009.01-2013.12	Rear Axle Left & Right Upper Inner	Saloon RWD 272980		Control Arm Bushing	533480
	2009.01-2013.12	Rear Axle Left & Right Lower Outer	Saloon RWD 272980		Control Arm Bushing	516552
	2009.01-2013.12	Rear Axle Left & Right Lower Outer	Saloon RWD 272980		Control Arm Bushing	516553
	2009.01-2013.12	Rear Axle Left & Right Upper Outer	Saloon RWD 272980		Control Arm Bushing	531454
	2009.01-2013.12	Front Axle Left & Right	Saloon RWD 272980		Tie Rod Axle Joint	S030649
	2009.01-2013.12	Front Axle Left	Saloon RWD 272980		Tie Rod End	S070998
	2009.01-2013.12	Front Axle Right	Saloon RWD 272980		Tie Rod End	S070997
	2009.01-2013.12	Front Axle Left	Saloon RWD 272980		Rod/Strut, stabiliser	S050804
	2009.01-2013.12	Front Axle Right	Saloon RWD 272980		Rod/Strut, stabiliser	S050803
	2009.01-2013.12	Rear Axle Left	Saloon RWD 272980		Rod/Strut, stabiliser	S050306
	2009.01-2013.12	Rear Axle Right	Saloon RWD 272980		Rod/Strut, stabiliser	S050307
3.5 (215 kw)	2009.01-2011.08	Front Axle Left Lower Inner	Saloon RWD 272983		Track Control Arm	S061637
	2009.01-2011.08	Front Axle Left Lower Outer	Saloon RWD 272983		Track Control Arm	S061607
	2009.01-2011.08	Front Axle Right Lower Inner	Saloon RWD 272983		Track Control Arm	S061638
	2009.01-2011.08	Front Axle Right Lower Outer	Saloon RWD 272983		Track Control Arm	S061608
	2009.01-2011.08	Rear Axle Left Upper Inner	Saloon RWD 272983		Track Control Arm	S063227
	2009.01-2011.08	Rear Axle Left Lower Outer	Saloon RWD 272983		Track Control Arm	S061566
	2009.01-2011.08	Rear Axle Left Upper Outer	Saloon RWD 272983		Track Control Arm	S062798
	2009.01-2011.08	Rear Axle Right Upper Inner	Saloon RWD 272983		Track Control Arm	S063228
	2009.01-2011.08	Rear Axle Right Lower Outer	Saloon RWD 272983		Track Control Arm	S061567
	2009.01-2011.08	Rear Axle Right Upper Outer	Saloon RWD 272983		Track Control Arm	S062797
	2009.01-2011.08	Rear Axle Left & Right Lower Inner	Saloon RWD 272983		Track Control Arm	S062799
	2009.01-2011.08	Front Axle Left & Right Lower Outer	Saloon RWD 272983		Ball Joint	S080671
	2009.01-2011.08	Front Axle Left & Right Lower Inner	Saloon RWD 272983		Control Arm Bushing	517477
	2009.01-2011.08	Front Axle Left & Right Lower Outer	Saloon RWD 272983		Control Arm Bushing	531452
	2009.01-2011.08	Rear Axle Left & Right Lower Inner	Saloon RWD 272983		Control Arm Bushing	530527
	2009.01-2011.08	Rear Axle Left & Right Upper Inner	Saloon RWD 272983		Control Arm Bushing	516563
	2009.01-2011.08	Rear Axle Left & Right Upper Inner	Saloon RWD 272983		Control Arm Bushing	530504

	 YEAR	FITTING POSITION	BODY STYLE & DRIVE TYPE & ENGINE	REMARKS	PRODUCT	GSP Ref.
MERCEDES-BENZ E350						
3.5 (215 kw)	2009.01-2011.08	Rear Axle Left & Right Upper Inner	Saloon RWD 272983		Control Arm Bushing	533480
	2009.01-2011.08	Rear Axle Left & Right Lower Outer	Saloon RWD 272983		Control Arm Bushing	516552
	2009.01-2011.08	Rear Axle Left & Right Lower Outer	Saloon RWD 272983		Control Arm Bushing	516553
	2009.01-2011.08	Rear Axle Left & Right Upper Outer	Saloon RWD 272983		Control Arm Bushing	531454
	2009.01-2011.08	Front Axle Left & Right	Saloon RWD 272983		Tie Rod Axle Joint	S030649
	2009.01-2011.08	Front Axle Left	Saloon RWD 272983		Tie Rod End	S070998
	2009.01-2011.08	Front Axle Right	Saloon RWD 272983		Tie Rod End	S070997
	2009.01-2011.08	Front Axle Left	Saloon RWD 272983		Rod/Strut, stabiliser	S050804
	2009.01-2011.08	Front Axle Right	Saloon RWD 272983		Rod/Strut, stabiliser	S050803
	2009.01-2011.08	Rear Axle Left	Saloon RWD 272983		Rod/Strut, stabiliser	S050306
	2009.01-2011.08	Rear Axle Right	Saloon RWD 272983		Rod/Strut, stabiliser	S050307
3.5 (225 kw)	2011.04-2014.12	Front Axle Left Lower Inner	Cabriolet RWD 276957		Track Control Arm	S060262
	2011.04-2014.12	Front Axle Left Lower Outer	Cabriolet RWD 276957		Track Control Arm	S060221
	2011.04-2014.12	Front Axle Right Lower Inner	Cabriolet RWD 276957		Track Control Arm	S060263
	2011.04-2014.12	Front Axle Right Lower Outer	Cabriolet RWD 276957		Track Control Arm	S060222
	2011.04-2014.12	Rear Axle Left Upper Inner	Cabriolet RWD 276957		Track Control Arm	S063227
	2011.04-2014.12	Rear Axle Left Lower Outer	Cabriolet RWD 276957		Track Control Arm	S061566
	2011.04-2014.12	Rear Axle Left Upper Outer	Cabriolet RWD 276957		Track Control Arm	S062798
	2011.04-2014.12	Rear Axle Right Upper Inner	Cabriolet RWD 276957		Track Control Arm	S063228
	2011.04-2014.12	Rear Axle Right Lower Outer	Cabriolet RWD 276957		Track Control Arm	S061567
	2011.04-2014.12	Rear Axle Right Upper Outer	Cabriolet RWD 276957		Track Control Arm	S062797
	2011.04-2014.12	Rear Axle Left & Right Lower Inner	Cabriolet RWD 276957		Track Control Arm	S062799
	2011.04-2014.12	Front Axle Left & Right Lower Inner	Cabriolet RWD 276957		Control Arm Bushing	517969
	2011.04-2014.12	Front Axle Left & Right Lower Outer	Cabriolet RWD 276957		Control Arm Bushing	510491
	2011.04-2014.12	Front Axle Left & Right Lower Outer	Cabriolet RWD 276957		Control Arm Bushing	531450
	2011.04-2014.12	Rear Axle Left & Right Upper	Cabriolet RWD 276957		Control Arm Bushing	532971
	2011.04-2014.12	Rear Axle Left & Right Lower Inner	Cabriolet RWD 276957		Control Arm Bushing	530527
	2011.04-2014.12	Rear Axle Left & Right Upper Inner	Cabriolet RWD 276957		Control Arm Bushing	516563
	2011.04-2014.12	Rear Axle Left & Right Upper Inner	Cabriolet RWD 276957		Control Arm Bushing	530504
	2011.04-2014.12	Rear Axle Left & Right Upper Inner	Cabriolet RWD 276957		Control Arm Bushing	533480
	2011.04-2014.12	Rear Axle Left & Right Lower Outer	Cabriolet RWD 276957		Control Arm Bushing	516552
	2011.04-2014.12	Rear Axle Left & Right Lower Outer	Cabriolet RWD 276957		Control Arm Bushing	516553
	2011.04-2014.12	Rear Axle Left & Right Upper Outer	Cabriolet RWD 276957		Control Arm Bushing	531454
	2011.04-2014.12	Front Axle Left & Right	Cabriolet RWD 276957	for vehicles with hydraulic power steering	Tie Rod Axle Joint	S030171
	2011.04-2014.12	Front Axle Left & Right	Cabriolet RWD 276957		Tie Rod Axle Joint	S030932
	2011.04-2014.12	Front Axle Left	Cabriolet RWD 276957		Tie Rod End	S070284
	2011.04-2014.12	Front Axle Right	Cabriolet RWD 276957		Tie Rod End	S070285
	2011.04-2014.12	Front Axle Left	Cabriolet RWD 276957	to vehicles without electronic drive systems regulated by vehicle without sports suspension	Rod/Strut, stabiliser	S050304
	2011.04-2014.12	Front Axle Left	Cabriolet RWD 276957		Rod/Strut, stabiliser	S051290
	2011.04-2014.12	Front Axle Right	Cabriolet RWD 276957	to vehicles without electronic drive systems regulated by vehicle without sports suspension	Rod/Strut, stabiliser	S050305
	2011.04-2014.12	Front Axle Right	Cabriolet RWD 276957		Rod/Strut, stabiliser	S051289
	2011.04-2014.12	Rear Axle Left	Cabriolet RWD 276957		Rod/Strut, stabiliser	S050306
	2011.04-2014.12	Rear Axle Right	Cabriolet RWD 276957		Rod/Strut, stabiliser	S050307
	2011.09-2015.12	Front Axle Left Lower Inner	Saloon RWD 276952		Track Control Arm	S061637
	2011.09-2015.12	Front Axle Left Lower Outer	Saloon RWD 276952		Track Control Arm	S061607
	2011.09-2015.12	Front Axle Right Lower Inner	Saloon RWD 276952		Track Control Arm	S061638
	2011.09-2015.12	Front Axle Right Lower Outer	Saloon RWD 276952		Track Control Arm	S061608
	2011.09-2015.12	Rear Axle Left Upper Inner	Saloon RWD 276952		Track Control Arm	S063227
	2011.09-2015.12	Rear Axle Left Lower Outer	Saloon RWD 276952		Track Control Arm	S061566
	2011.09-2015.12	Rear Axle Left Upper Outer	Saloon RWD 276952		Track Control Arm	S062798
	2011.09-2015.12	Rear Axle Right Upper Inner	Saloon RWD 276952		Track Control Arm	S063228
	2011.09-2015.12	Rear Axle Right Lower Outer	Saloon RWD 276952		Track Control Arm	S061567
	2011.09-2015.12	Rear Axle Right Upper Outer	Saloon RWD 276952		Track Control Arm	S062797
	2011.09-2015.12	Rear Axle Left & Right Lower Inner	Saloon RWD 276952		Track Control Arm	S062799
	2011.09-2015.12	Front Axle Left & Right Lower Outer	Saloon RWD 276952		Ball Joint	S080671
	2011.09-2015.12	Front Axle Left & Right Lower Inner	Saloon RWD 276952		Control Arm Bushing	517477
	2011.09-2015.12	Front Axle Left & Right Lower Outer	Saloon RWD 276952		Control Arm Bushing	531452
	2011.09-2015.12	Rear Axle Left & Right Lower Inner	Saloon RWD 276952		Control Arm Bushing	530527
	2011.09-2015.12	Rear Axle Left & Right Upper Inner	Saloon RWD 276952		Control Arm Bushing	516563
	2011.09-2015.12	Rear Axle Left & Right Upper Inner	Saloon RWD 276952		Control Arm Bushing	530504
	2011.09-2015.12	Rear Axle Left & Right Upper Inner	Saloon RWD 276952		Control Arm Bushing	533480
	2011.09-2015.12	Rear Axle Left & Right Lower Outer	Saloon RWD 276952		Control Arm Bushing	516552
	2011.09-2015.12	Rear Axle Left & Right Lower Outer	Saloon RWD 276952		Control Arm Bushing	516553
	2011.09-2015.12	Rear Axle Left & Right Upper Outer	Saloon RWD 276952		Control Arm Bushing	531454



	 YEAR	FITTING POSITION	BODY STYLE & DRIVE TYPE & ENGINE	REMARKS	PRODUCT	GSP Ref.
MERCEDES-BENZ E350						
3.5 (225 kw)						
	2011.09-2015.12	Front Axle Left & Right	Saloon RWD 276952		Tie Rod Axle Joint	S030649
	2011.09-2015.12	Front Axle Left	Saloon RWD 276952		Tie Rod End	S070998
	2011.09-2015.12	Front Axle Right	Saloon RWD 276952		Tie Rod End	S070997
	2011.09-2015.12	Front Axle Left	Saloon RWD 276952		Rod/Strut,stabiliser	S050804
	2011.09-2015.12	Front Axle Right	Saloon RWD 276952		Rod/Strut,stabiliser	S050803
	2011.09-2015.12	Rear Axle Left	Saloon RWD 276952		Rod/Strut,stabiliser	S050306
	2011.09-2015.12	Rear Axle Right	Saloon RWD 276952		Rod/Strut,stabiliser	S050307
E420						
4.2 (205 kw)						
	1993.06-1995.06	Rear Axle Left & Right Lower Inner	Saloon RWD 119975		Track Control Arm	S060217
	1993.06-1995.06	Rear Axle Left & Right Upper Inner	Saloon RWD 119975		Track Control Arm	S060216
	1993.06-1995.06	Rear Axle Left & Right Lower Outer	Saloon RWD 119975		Track Control Arm	S051055
	1993.06-1995.06	Rear Axle Left & Right Upper Outer	Saloon RWD 119975		Track Control Arm	S060218
	1993.06-1995.06	Front Axle Left & Right Lower	Saloon RWD 119975		Control Arm Bushing	510427
	1993.06-1995.06	Front Axle Left & Right Lower	Saloon RWD 119975		Control Arm Bushing	510428
	1993.06-1995.06	Rear Axle Left & Right Lower	Saloon RWD 119975		Control Arm Bushing	511560
	1993.06-1995.06	Rear Axle Left & Right Upper Inner	Saloon RWD 119975		Control Arm Bushing	517809
	1993.06-1995.06	Rear Axle Left & Right Lower Outer	Saloon RWD 119975		Control Arm Bushing	510431
	1993.06-1995.06	Rear Axle Left & Right Lower Outer	Saloon RWD 119975		Control Arm Bushing	512252
	1993.06-1995.06	Rear Axle Left & Right Upper Outer	Saloon RWD 119975		Control Arm Bushing	510430
	1993.06-1995.06	Front Axle Left & Right Lower	Saloon RWD 119975		Control Arm Bushing Kit	510426S
	1993.06-1995.06	Rear Axle	Saloon RWD 119975		Suspension Repair Kit	S990038SK
	1993.06-1995.06	Front Axle Left & Right	Saloon RWD 119975		Rod Assembly	S100073
	1993.06-1995.06	Rear Axle Left & Right	Saloon RWD 119975		Rod/Strut,stabiliser	S100063
	1993.06-1995.06	Front Axle	Saloon RWD 119975		Stabiliser Bushing	512608
	1993.06-1995.06	Front Axle	Saloon RWD 119975		Stabiliser Bushing	517172
	1993.06-1995.06	Rear Axle	Saloon RWD 119975		Stabiliser Bushing	517269
	1993.06-1995.06	Rear Axle	Saloon RWD 119975		Stabiliser Bushing Kit	531455S
	1995.07-1997.10	Front Axle Left Lower	Saloon RWD 119985		Track Control Arm	S060578
	1995.07-1997.10	Front Axle Left Upper	Saloon RWD 119985		Track Control Arm	S060214
	1995.07-1997.10	Front Axle Right Lower	Saloon RWD 119985		Track Control Arm	S060577
	1995.07-1997.10	Front Axle Right Upper	Saloon RWD 119985		Track Control Arm	S060215
	1995.07-1997.10	Rear Axle Left & Right Lower Inner	Saloon RWD 119985		Track Control Arm	S060217
	1995.07-1997.10	Rear Axle Left & Right Upper Inner	Saloon RWD 119985	Chassis no.from:A 597177.X 007199	Track Control Arm	S060216
	1995.07-1997.10	Rear Axle Left & Right Lower Outer	Saloon RWD 119985		Track Control Arm	S051055
	1995.07-1997.10	Rear Axle Left & Right Upper Outer	Saloon RWD 119985		Track Control Arm	S060218
	1995.07-1997.10	Front Axle Left & Right Lower	Saloon RWD 119985		Ball Joint	S080143
	1995.07-1997.10	Front Axle Left & Right Lower	Saloon RWD 119985		Control Arm Bushing	510471
	1995.07-1997.10	Front Axle Left & Right Upper	Saloon RWD 119985		Control Arm Bushing	510456
	1995.07-1997.10	Rear Axle Left & Right Lower	Saloon RWD 119985		Control Arm Bushing	511560
	1995.07-1997.10	Rear Axle Left & Right Upper Inner	Saloon RWD 119985		Control Arm Bushing	517809
	1995.07-1997.10	Rear Axle Left & Right Lower Outer	Saloon RWD 119985		Control Arm Bushing	510431
	1995.07-1997.10	Rear Axle Left & Right Lower Outer	Saloon RWD 119985		Control Arm Bushing	512252
	1995.07-1997.10	Rear Axle Left & Right Upper Outer	Saloon RWD 119985		Control Arm Bushing	510430
	1995.07-1997.10	Front Axle Left & Right Lower	Saloon RWD 119985		Control Arm Bushing Kit	510470S
	1995.07-1997.10	Rear Axle	Saloon RWD 119985		Suspension Repair Kit	S990038SK
	1995.07-1997.10	Front Axle Left & Right	Saloon RWD 119985		Tie Rod Axle Joint	S030853
	1995.07-1997.10	Front Axle Left	Saloon RWD 119985		Tie Rod End	S070312
	1995.07-1997.10	Front Axle Right	Saloon RWD 119985		Tie Rod End	S070313
	1995.07-1997.10	Front Axle Left	Saloon RWD 119985		Rod/Strut,stabiliser	510478
	1995.07-1997.10	Front Axle Right	Saloon RWD 119985		Rod/Strut,stabiliser	510479
	1995.07-1997.10	Rear Axle Left & Right	Saloon RWD 119985		Rod/Strut,stabiliser	S050272
	1995.07-1997.10	Rear Axle Left & Right	Saloon RWD 119985		Rod/Strut,stabiliser	S100063
	1995.07-1997.10	Front Axle	Saloon RWD 119985		Stabiliser Bushing	512616
	1995.07-1997.10	Rear Axle	Saloon RWD 119985		Stabiliser Bushing	517269
	1995.07-1997.10	Front Axle	Saloon RWD 119985		Steering Boot	540204
	1995.07-1997.10	Front Axle	Saloon RWD 119985		Steering Boot	540345
	1995.07-1997.10	Front Axle	Saloon RWD 119985		Steering Boot	540443
E43 AMG						
3.0 (295 kw)						
	2016.07-	Front Axle Left Upper	Saloon 4WD 276823		Track Control Arm	S062802
	2016.07-	Front Axle Right Upper	Saloon 4WD 276823		Track Control Arm	S062801
	2016.07-	Front Axle Left & Right Lower Inner	Saloon 4WD 276823		Track Control Arm	S062842
	2016.07-	Front Axle Left & Right Lower Inner	Saloon 4WD 276823		Control Arm Bushing	533481
	2016.07-	Front Axle Left & Right Lower Inner	Saloon 4WD 276823		Control Arm Bushing	535411
	2016.07-	Front Axle Left & Right Lower Inner	Saloon 4WD 276823		Control Arm Bushing	535418



	 YEAR	FITTING POSITION	BODY STYLE & DRIVE TYPE & ENGINE	REMARKS	PRODUCT	GSP Ref.
MERCEDES-BENZ						
E43 AMG						
3.0 (295 kw)	2016.07-	Rear Axle Left & Right Upper Inner	Saloon 4WD 276823		Control Arm Bushing	533480
	2016.07-	Front Axle Left & Right	Saloon 4WD 276823		Tie Rod Axle Joint	S031025
	2016.07-	Front Axle Left	Saloon 4WD 276823		Tie Rod End	S071773
	2016.07-	Front Axle Right	Saloon 4WD 276823		Tie Rod End	S071774
	2016.07-	Rear Axle Left	Saloon 4WD 276823		Rod/Strut,stabiliser	S051247
	2016.07-	Rear Axle Right	Saloon 4WD 276823		Rod/Strut,stabiliser	S051248
E430						
4.3 (205 kw)	1997.04-2002.03	Front Axle Left Lower	Saloon RWD 113940		Track Control Arm	S060578
	1997.04-2002.03	Front Axle Left Upper	Saloon RWD 113940		Track Control Arm	S060214
	1997.04-2002.03	Front Axle Right Lower	Saloon RWD 113940		Track Control Arm	S060577
	1997.04-2002.03	Front Axle Right Upper	Saloon RWD 113940		Track Control Arm	S060215
	1997.04-2002.03	Rear Axle Left & Right Lower Inner	Saloon RWD 113940		Track Control Arm	S060217
	1997.04-2002.03	Rear Axle Left & Right Upper Inner	Saloon RWD 113940		Track Control Arm	S060216
	1997.04-2002.03	Rear Axle Left & Right Lower Outer	Saloon RWD 113940		Track Control Arm	S051055
	1997.04-2002.03	Rear Axle Left & Right Upper Outer	Saloon RWD 113940		Track Control Arm	S060218
	1997.04-2002.03	Front Axle Left & Right Lower	Saloon RWD 113940		Ball Joint	S080143
	1997.04-2002.03	Front Axle Left & Right Lower	Saloon RWD 113940		Control Arm Bushing	510471
	1997.04-2002.03	Front Axle Left & Right Upper	Saloon RWD 113940		Control Arm Bushing	510456
	1997.04-2002.03	Rear Axle Left & Right Lower	Saloon RWD 113940		Control Arm Bushing	511560
	1997.04-2002.03	Rear Axle Left & Right Upper Inner	Saloon RWD 113940		Control Arm Bushing	517809
	1997.04-2002.03	Rear Axle Left & Right Lower Outer	Saloon RWD 113940		Control Arm Bushing	510431
	1997.04-2002.03	Rear Axle Left & Right Lower Outer	Saloon RWD 113940		Control Arm Bushing	512252
	1997.04-2002.03	Rear Axle Left & Right Upper Outer	Saloon RWD 113940		Control Arm Bushing	510430
	1997.04-2002.03	Front Axle Left & Right Lower	Saloon RWD 113940		Control Arm Bushing Kit	510470S
	1997.04-2002.03	Rear Axle	Saloon RWD 113940		Suspension Repair Kit	S990038SK
	1997.04-2002.03	Front Axle Left & Right	Saloon RWD 113940		Tie Rod Axle Joint	S030853
	1997.04-2002.03	Front Axle Left	Saloon RWD 113940		Tie Rod End	S070312
	1997.04-2002.03	Front Axle Right	Saloon RWD 113940		Tie Rod End	S070313
	1997.04-2002.03	Front Axle Left	Saloon RWD 113940		Rod/Strut,stabiliser	510478
	1997.04-2002.03	Front Axle Right	Saloon RWD 113940		Rod/Strut,stabiliser	510479
	1997.04-2002.03	Rear Axle Left & Right	Saloon RWD 113940	Special Purpose:For armoured vehicles	Rod/Strut,stabiliser	S050272
	1997.04-2002.03	Rear Axle Left & Right	Saloon RWD 113940	not for armoured vehicles	Rod/Strut,stabiliser	S100063
	1997.04-2002.03	Front Axle	Saloon RWD 113940		Stabiliser Bushing	512616
	1997.04-2002.03	Front Axle	Saloon RWD 113940		Steering Boot	540204
	1997.04-2002.03	Front Axle	Saloon RWD 113940		Steering Boot	540443
	1997.11-2003.05	Front Axle Left Lower	Estate RWD 113940		Track Control Arm	S060578
	1997.11-2003.05	Front Axle Left Upper	Estate RWD 113940		Track Control Arm	S060214
	1997.11-2003.05	Front Axle Right Lower	Estate RWD 113940		Track Control Arm	S060577
	1997.11-2003.05	Front Axle Right Upper	Estate RWD 113940		Track Control Arm	S060215
	1997.11-2003.05	Rear Axle Left & Right Lower Inner	Estate RWD 113940		Track Control Arm	S060217
	1997.11-2003.05	Rear Axle Left & Right Lower Outer	Estate RWD 113940		Track Control Arm	S051055
	1997.11-2003.05	Rear Axle Left & Right Upper Outer	Estate RWD 113940		Track Control Arm	S060218
	1997.11-2003.05	Front Axle Left & Right Lower	Estate RWD 113940		Ball Joint	S080143
	1997.11-2003.05	Front Axle Left & Right Lower	Estate RWD 113940		Control Arm Bushing	510471
	1997.11-2003.05	Front Axle Left & Right Upper	Estate RWD 113940		Control Arm Bushing	510456
	1997.11-2003.05	Rear Axle Left & Right Lower	Estate RWD 113940		Control Arm Bushing	511560
	1997.11-2003.05	Rear Axle Left & Right Upper Inner	Estate RWD 113940		Control Arm Bushing	517809
	1997.11-2003.05	Rear Axle Left & Right Lower Outer	Estate RWD 113940		Control Arm Bushing	510431
	1997.11-2003.05	Rear Axle Left & Right Lower Outer	Estate RWD 113940		Control Arm Bushing	512252
	1997.11-2003.05	Rear Axle Left & Right Upper Outer	Estate RWD 113940		Control Arm Bushing	510430
	1997.11-2003.05	Front Axle Left & Right Lower	Estate RWD 113940		Control Arm Bushing Kit	510470S
	1997.11-2003.05	Rear Axle	Estate RWD 113940		Suspension Repair Kit	S990038SK
	1997.11-2003.05	Front Axle Left & Right	Estate RWD 113940		Tie Rod Axle Joint	S030853
	1997.11-2003.05	Front Axle Left	Estate RWD 113940		Tie Rod End	S070312
	1997.11-2003.05	Front Axle Right	Estate RWD 113940		Tie Rod End	S070313
	1997.11-2003.05	Front Axle Left	Estate RWD 113940		Rod/Strut,stabiliser	510478
	1997.11-2003.05	Front Axle Right	Estate RWD 113940		Rod/Strut,stabiliser	510479
	1997.11-2003.05	Rear Axle Left & Right	Estate RWD 113940		Rod/Strut,stabiliser	S050272
	1997.11-2003.05	Front Axle	Estate RWD 113940		Steering Boot	540443
	E500					
4.7 (300 kw)	2011.09-2015.12	Front Axle Left Lower Inner	Saloon RWD 278922		Track Control Arm	S061637
	2011.09-2015.12	Front Axle Left Lower Outer	Saloon RWD 278922		Track Control Arm	S061607
	2011.09-2015.12	Front Axle Right Lower Inner	Saloon RWD 278922		Track Control Arm	S061638
	2011.09-2015.12	Front Axle Right Lower Outer	Saloon RWD 278922		Track Control Arm	S061608



	 YEAR	FITTING POSITION	BODY STYLE & DRIVE TYPE & ENGINE	REMARKS	PRODUCT	GSP Ref.
MERCEDES-BENZ E500						
4.7 (300 kw)	2011.09-2015.12	Rear Axle Left Upper Inner	Saloon RWD 278922		Track Control Arm	S063227
	2011.09-2015.12	Rear Axle Left Lower Outer	Saloon RWD 278922		Track Control Arm	S061566
	2011.09-2015.12	Rear Axle Left Upper Outer	Saloon RWD 278922		Track Control Arm	S062798
	2011.09-2015.12	Rear Axle Right Upper Inner	Saloon RWD 278922		Track Control Arm	S063228
	2011.09-2015.12	Rear Axle Right Lower Outer	Saloon RWD 278922		Track Control Arm	S061567
	2011.09-2015.12	Rear Axle Right Upper Outer	Saloon RWD 278922		Track Control Arm	S062797
	2011.09-2015.12	Rear Axle Left & Right Lower Inner	Saloon RWD 278922		Track Control Arm	S062799
	2011.09-2015.12	Front Axle Left & Right Lower Outer	Saloon RWD 278922		Ball Joint	S080671
	2011.09-2015.12	Front Axle Left & Right Lower Inner	Saloon RWD 278922		Control Arm Bushing	517477
	2011.09-2015.12	Front Axle Left & Right Lower Outer	Saloon RWD 278922		Control Arm Bushing	531452
	2011.09-2015.12	Rear Axle Left & Right Lower Inner	Saloon RWD 278922		Control Arm Bushing	530527
	2011.09-2015.12	Rear Axle Left & Right Upper Inner	Saloon RWD 278922		Control Arm Bushing	516563
	2011.09-2015.12	Rear Axle Left & Right Upper Inner	Saloon RWD 278922		Control Arm Bushing	530504
	2011.09-2015.12	Rear Axle Left & Right Upper Inner	Saloon RWD 278922		Control Arm Bushing	533480
	2011.09-2015.12	Rear Axle Left & Right Lower Outer	Saloon RWD 278922		Control Arm Bushing	516552
	2011.09-2015.12	Rear Axle Left & Right Lower Outer	Saloon RWD 278922		Control Arm Bushing	516553
	2011.09-2015.12	Rear Axle Left & Right Upper Outer	Saloon RWD 278922		Control Arm Bushing	531454
	2011.09-2015.12	Front Axle Left & Right	Saloon RWD 278922		Tie Rod Axle Joint	S030649
	2011.09-2015.12	Front Axle Left	Saloon RWD 278922		Tie Rod End	S070998
	2011.09-2015.12	Front Axle Right	Saloon RWD 278922		Tie Rod End	S070997
	2011.09-2015.12	Front Axle Left	Saloon RWD 278922		Rod/Strut, stabiliser	S050804
	2011.09-2015.12	Front Axle Right	Saloon RWD 278922		Rod/Strut, stabiliser	S050803
	2011.09-2015.12	Rear Axle Left	Saloon RWD 278922		Rod/Strut, stabiliser	S050306
	2011.09-2015.12	Rear Axle Right	Saloon RWD 278922		Rod/Strut, stabiliser	S050307
5.0 (225 kw)	2002.04-2005.06	Front Axle Left Upper	Saloon RWD 113967		Track Control Arm	S060223
	2002.04-2005.06	Front Axle Left Lower Inner	Saloon RWD 113967		Track Control Arm	S060225
	2002.04-2005.06	Front Axle Left Lower Outer	Saloon RWD 113967		Track Control Arm	S060227
	2002.04-2005.06	Front Axle Right Upper	Saloon RWD 113967		Track Control Arm	S060224
	2002.04-2005.06	Front Axle Right Lower Inner	Saloon RWD 113967		Track Control Arm	S060226
	2002.04-2005.06	Front Axle Right Lower Outer	Saloon RWD 113967		Track Control Arm	S060228
	2002.04-2005.06	Rear Axle Left Upper Inner	Saloon RWD 113967		Track Control Arm	S060231
	2002.04-2005.06	Rear Axle Left Upper Outer	Saloon RWD 113967		Track Control Arm	S060229
	2002.04-2005.06	Rear Axle Right Upper Inner	Saloon RWD 113967		Track Control Arm	S060232
	2002.04-2005.06	Rear Axle Right Upper Outer	Saloon RWD 113967		Track Control Arm	S060230
	2002.04-2005.06	Rear Axle Left & Right Lower Inner	Saloon RWD 113967		Track Control Arm	S060233
	2002.04-2005.06	Front Axle Left & Right Upper	Saloon RWD 113967		Ball Joint	S080145
	2002.04-2005.06	Front Axle Left & Right Lower Inner	Saloon RWD 113967	for OE No.211 330 81 07	Ball Joint	S080134
	2002.04-2005.06	Front Axle Left & Right Lower Inner	Saloon RWD 113967		Ball Joint	S080136
	2002.04-2005.06	Front Axle Left & Right Upper	Saloon RWD 113967		Control Arm Bushing	510529
	2002.04-2005.06	Front Axle Left & Right Lower Inner	Saloon RWD 113967		Control Arm Bushing	518119
	2002.04-2005.06	Front Axle Left & Right Lower Inner	Saloon RWD 113967		Control Arm Bushing	518120
	2002.04-2005.06	Front Axle Left & Right Lower Outer	Saloon RWD 113967		Control Arm Bushing	510518
	2002.04-2005.06	Front Axle Left & Right Lower Outer	Saloon RWD 113967		Control Arm Bushing	530133
	2002.04-2005.06	Rear Axle Left & Right Lower Inner	Saloon RWD 113967		Control Arm Bushing	530527
	2002.04-2005.06	Rear Axle Left & Right Upper Inner	Saloon RWD 113967		Control Arm Bushing	510521
	2002.04-2005.06	Rear Axle Left & Right Upper Outer	Saloon RWD 113967		Control Arm Bushing	510522
	2002.04-2005.06	Front Axle	Saloon RWD 113967		Suspension Repair Kit	S990007SK
	2002.04-2005.06	Front Axle	Saloon RWD 113967		Suspension Repair Kit	S990035SK
	2002.04-2005.06	Front Axle	Saloon RWD 113967		Suspension Repair Kit	S990039SK
	2002.04-2005.06	Rear Axle	Saloon RWD 113967		Suspension Repair Kit	S990056SK
	2002.04-2005.06	Front Axle Left & Right	Saloon RWD 113967		Tie Rod Axle Joint	S030853
	2002.04-2005.06	Front Axle Left	Saloon RWD 113967		Tie Rod End	S070286
	2002.04-2005.06	Front Axle Right	Saloon RWD 113967		Tie Rod End	S070287
	2002.04-2005.06	Front Axle Left	Saloon RWD 113967		Rod/Strut, stabiliser	510516
	2002.04-2005.06	Front Axle Right	Saloon RWD 113967		Rod/Strut, stabiliser	510515
	2002.04-2005.06	Front Axle	Saloon RWD 113967		Stabiliser Bushing	510514
	2002.04-2005.06	Front Axle	Saloon RWD 113967	Date to:2005.06	Steering Rack Bellow Kit	540204S
5.5 (285 kw)	2006.05-2009.03	Front Axle Left Upper	Saloon RWD 273960		Track Control Arm	S060223
	2006.05-2009.03	Front Axle Left Lower Inner	Saloon RWD 273960		Track Control Arm	S060225
	2006.05-2009.03	Front Axle Left Lower Outer	Saloon RWD 273960		Track Control Arm	S060227
	2006.05-2009.03	Front Axle Right Upper	Saloon RWD 273960		Track Control Arm	S060224
	2006.05-2009.03	Front Axle Right Lower Inner	Saloon RWD 273960		Track Control Arm	S060226
	2006.05-2009.03	Rear Axle Left Upper Inner	Saloon RWD 273960		Track Control Arm	S060231
	2006.05-2009.03	Rear Axle Left Upper Outer	Saloon RWD 273960		Track Control Arm	S060229



	 YEAR	FITTING POSITION	BODY STYLE & DRIVE TYPE & ENGINE	REMARKS	PRODUCT	GSP Ref.
MERCEDES-BENZ E500						
5.5 (285 kw)	2006.05-2009.03	Rear Axle Right Upper Inner	Saloon RWD 273960		Track Control Arm	S060232
	2006.05-2009.03	Rear Axle Right Upper Outer	Saloon RWD 273960		Track Control Arm	S060230
	2006.05-2009.03	Rear Axle Left & Right Lower Inner	Saloon RWD 273960		Track Control Arm	S060233
	2006.05-2009.03	Front Axle Left & Right Upper	Saloon RWD 273960		Ball Joint	S080145
	2006.05-2009.03	Front Axle Left & Right Lower Inner	Saloon RWD 273960		Ball Joint	S080134
	2006.05-2009.03	Front Axle Left & Right Lower Inner	Saloon RWD 273960		Ball Joint	S080136
	2006.05-2009.03	Front Axle Left & Right Upper	Saloon RWD 273960		Control Arm Bushing	510529
	2006.05-2009.03	Front Axle Left & Right Lower Inner	Saloon RWD 273960		Control Arm Bushing	518119
	2006.05-2009.03	Front Axle Left & Right Lower Inner	Saloon RWD 273960		Control Arm Bushing	518120
	2006.05-2009.03	Front Axle Left & Right Lower Outer	Saloon RWD 273960		Control Arm Bushing	530133
	2006.05-2009.03	Rear Axle Left & Right Lower Inner	Saloon RWD 273960		Control Arm Bushing	530527
	2006.05-2009.03	Rear Axle Left & Right Upper Inner	Saloon RWD 273960		Control Arm Bushing	510521
	2006.05-2009.03	Rear Axle Left & Right Upper Outer	Saloon RWD 273960		Control Arm Bushing	510522
	2006.05-2009.03	Front Axle	Saloon RWD 273960		Suspension Repair Kit	S990035SK
	2006.05-2009.03	Front Axle	Saloon RWD 273960		Suspension Repair Kit	S990039SK
	2006.05-2009.03	Rear Axle	Saloon RWD 273960		Suspension Repair Kit	S990056SK
	2006.05-2009.03	Front Axle Left & Right	Saloon RWD 273960		Tie Rod Axle Joint	S030853
	2006.05-2009.03	Front Axle Left	Saloon RWD 273960		Tie Rod End	S070286
	2006.05-2009.03	Front Axle Right	Saloon RWD 273960		Tie Rod End	S070287
	2006.05-2009.03	Front Axle Left	Saloon RWD 273960		Rod/Strut, stabiliser	510516
	2006.05-2009.03	Front Axle Right	Saloon RWD 273960		Rod/Strut, stabiliser	510515
	2006.05-2009.03	Front Axle	Saloon RWD 273960		Stabiliser Bushing	510514
	2006.05-2009.03	Front Axle	Saloon RWD 273960	Date to:2007.01	Steering Rack Bellow Kit	540204S
	2009.01-2011.12	Front Axle Left Lower Inner	Saloon RWD 273971		Track Control Arm	S061637
	2009.01-2011.12	Front Axle Left Lower Outer	Saloon RWD 273971		Track Control Arm	S061607
	2009.01-2011.12	Front Axle Right Lower Inner	Saloon RWD 273971		Track Control Arm	S061638
	2009.01-2011.12	Front Axle Right Lower Outer	Saloon RWD 273971		Track Control Arm	S061608
	2009.01-2011.12	Rear Axle Left Upper Inner	Saloon RWD 273971		Track Control Arm	S063227
	2009.01-2011.12	Rear Axle Left Lower Outer	Saloon RWD 273971		Track Control Arm	S061566
	2009.01-2011.12	Rear Axle Left Upper Outer	Saloon RWD 273971		Track Control Arm	S062798
	2009.01-2011.12	Rear Axle Right Upper Inner	Saloon RWD 273971		Track Control Arm	S063228
	2009.01-2011.12	Rear Axle Right Lower Outer	Saloon RWD 273971		Track Control Arm	S061567
	2009.01-2011.12	Rear Axle Right Upper Outer	Saloon RWD 273971		Track Control Arm	S062797
	2009.01-2011.12	Rear Axle Left & Right Lower Inner	Saloon RWD 273971		Track Control Arm	S062799
	2009.01-2011.12	Front Axle Left & Right Lower Outer	Saloon RWD 273971		Ball Joint	S080671
	2009.01-2011.12	Front Axle Left & Right Lower Inner	Saloon RWD 273971		Control Arm Bushing	517477
	2009.01-2011.12	Front Axle Left & Right Lower Outer	Saloon RWD 273971		Control Arm Bushing	531452
	2009.01-2011.12	Rear Axle Left & Right Lower Inner	Saloon RWD 273971		Control Arm Bushing	530527
	2009.01-2011.12	Rear Axle Left & Right Upper Inner	Saloon RWD 273971		Control Arm Bushing	516563
	2009.01-2011.12	Rear Axle Left & Right Upper Inner	Saloon RWD 273971		Control Arm Bushing	530504
	2009.01-2011.12	Rear Axle Left & Right Upper Inner	Saloon RWD 273971		Control Arm Bushing	533480
	2009.01-2011.12	Rear Axle Left & Right Lower Outer	Saloon RWD 273971		Control Arm Bushing	516552
	2009.01-2011.12	Rear Axle Left & Right Lower Outer	Saloon RWD 273971		Control Arm Bushing	516553
	2009.01-2011.12	Rear Axle Left & Right Upper Outer	Saloon RWD 273971		Control Arm Bushing	531454
	2009.01-2011.12	Front Axle Left & Right	Saloon RWD 273971		Tie Rod Axle Joint	S030649
	2009.01-2011.12	Front Axle Left	Saloon RWD 273971		Tie Rod End	S070998
	2009.01-2011.12	Front Axle Right	Saloon RWD 273971		Tie Rod End	S070997
	2009.01-2011.12	Front Axle Left	Saloon RWD 273971		Rod/Strut, stabiliser	S050804
	2009.01-2011.12	Front Axle Right	Saloon RWD 273971		Rod/Strut, stabiliser	S050803
	2009.01-2011.12	Rear Axle Left	Saloon RWD 273971		Rod/Strut, stabiliser	S050306
	2009.01-2011.12	Rear Axle Right	Saloon RWD 273971		Rod/Strut, stabiliser	S050307
E55 AMG						
5.4 (260 kw)	1997.01-2002.11	Front Axle Left Lower	Saloon RWD 113980		Track Control Arm	S060578
	1997.01-2002.11	Front Axle Left Upper	Saloon RWD 113980		Track Control Arm	S060214
	1997.01-2002.11	Front Axle Right Lower	Saloon RWD 113980		Track Control Arm	S060577
	1997.01-2002.11	Front Axle Right Upper	Saloon RWD 113980		Track Control Arm	S060215
	1997.01-2002.11	Rear Axle Left & Right Lower Inner	Saloon RWD 113980		Track Control Arm	S060217
	1997.01-2002.11	Rear Axle Left & Right Upper Inner	Saloon RWD 113980		Track Control Arm	S060216
	1997.01-2002.11	Rear Axle Left & Right Lower Outer	Saloon RWD 113980		Track Control Arm	S051055
	1997.01-2002.11	Rear Axle Left & Right Upper Outer	Saloon RWD 113980		Track Control Arm	S060218
	1997.01-2002.11	Front Axle Left & Right Lower	Saloon RWD 113980		Ball Joint	S080143
	1997.01-2002.11	Front Axle Left & Right Lower	Saloon RWD 113980		Control Arm Bushing	510471
	1997.01-2002.11	Front Axle Left & Right Upper	Saloon RWD 113980		Control Arm Bushing	510456
	1997.01-2002.11	Rear Axle Left & Right Lower	Saloon RWD 113980		Control Arm Bushing	511560

	 YEAR	FITTING POSITION	BODY STYLE & DRIVE TYPE & ENGINE	REMARKS	PRODUCT	GSP Ref.
MERCEDES-BENZ E55 AMG						
5.4 (260 kw)						
	1997.01-2002.11	Rear Axle Left & Right Upper Inner	Saloon RWD 113980		Control Arm Bushing	517809
	1997.01-2002.11	Rear Axle Left & Right Lower Outer	Saloon RWD 113980		Control Arm Bushing	510431
	1997.01-2002.11	Rear Axle Left & Right Lower Outer	Saloon RWD 113980		Control Arm Bushing	512252
	1997.01-2002.11	Rear Axle Left & Right Upper Outer	Saloon RWD 113980		Control Arm Bushing	510430
	1997.01-2002.11	Front Axle Left & Right Lower	Saloon RWD 113980		Control Arm Bushing Kit	510470S
	1997.01-2002.11	Front Axle Left & Right	Saloon RWD 113980		Tie Rod Axle Joint	S030853
	1997.01-2002.11	Front Axle Left	Saloon RWD 113980		Tie Rod End	S070312
	1997.01-2002.11	Front Axle Right	Saloon RWD 113980		Tie Rod End	S070313
	1997.01-2002.11	Front Axle Left	Saloon RWD 113980		Rod/Strut, stabiliser	510478
	1997.01-2002.11	Front Axle Right	Saloon RWD 113980		Rod/Strut, stabiliser	510479
	1997.01-2002.11	Rear Axle Left & Right	Saloon RWD 113980	Special Purpose:For armoured vehicles	Rod/Strut, stabiliser	S050272
	1997.01-2002.11	Rear Axle Left & Right	Saloon RWD 113980	not for armoured vehicles	Rod/Strut, stabiliser	S100063
	1997.01-2002.11	Front Axle	Saloon RWD 113980		Steering Boot	540204
	1997.01-2002.11	Front Axle	Saloon RWD 113980		Steering Boot	540443
5.4 (350 kw)						
	2002.11-2006.07	Front Axle Left Upper	Saloon RWD 113990		Track Control Arm	S060223
	2002.11-2006.07	Front Axle Left Lower Inner	Saloon RWD 113990		Track Control Arm	S060225
	2002.11-2006.07	Front Axle Left Lower Outer	Saloon RWD 113990		Track Control Arm	S060227
	2002.11-2006.07	Front Axle Right Upper	Saloon RWD 113990		Track Control Arm	S060224
	2002.11-2006.07	Front Axle Right Lower Inner	Saloon RWD 113990		Track Control Arm	S060226
	2002.11-2006.07	Front Axle Right Lower Outer	Saloon RWD 113990		Track Control Arm	S060228
	2002.11-2006.07	Front Axle Left & Right Upper	Saloon RWD 113990		Ball Joint	S080145
	2002.11-2006.07	Front Axle Left & Right Lower Inner	Saloon RWD 113990	for OE No.211 330 81 07	Ball Joint	S080134
	2002.11-2006.07	Front Axle Left & Right Lower Inner	Saloon RWD 113990		Ball Joint	S080136
	2002.11-2006.07	Front Axle Left & Right Upper	Saloon RWD 113990		Control Arm Bushing	510529
	2002.11-2006.07	Front Axle Left & Right Lower Inner	Saloon RWD 113990		Control Arm Bushing	518119
	2002.11-2006.07	Front Axle Left & Right Lower Inner	Saloon RWD 113990		Control Arm Bushing	518120
	2002.11-2006.07	Front Axle Left & Right Lower Outer	Saloon RWD 113990		Control Arm Bushing	530133
	2002.11-2006.07	Front Axle	Saloon RWD 113990		Suspension Repair Kit	S990007SK
	2002.11-2006.07	Front Axle	Saloon RWD 113990		Suspension Repair Kit	S990035SK
	2002.11-2006.07	Front Axle	Saloon RWD 113990		Suspension Repair Kit	S990039SK
	2002.11-2006.07	Front Axle Left & Right	Saloon RWD 113990		Tie Rod Axle Joint	S030853
	2002.11-2006.07	Front Axle Left	Saloon RWD 113990		Tie Rod End	S070286
	2002.11-2006.07	Front Axle Right	Saloon RWD 113990		Tie Rod End	S070287
	2002.11-2006.07	Front Axle Left	Saloon RWD 113990		Rod/Strut, stabiliser	510516
	2002.11-2006.07	Front Axle Right	Saloon RWD 113990		Rod/Strut, stabiliser	510515
	2002.11-2006.07	Front Axle	Saloon RWD 113990		Stabiliser Bushing	510514
	2002.11-2006.07	Front Axle	Saloon RWD 113990	Date to:2006.07	Steering Rack Bellow Kit	540204S
E63 AMG						
5.5 (386 kw)						
	2011.02-2016.12	Rear Axle Left & Right Lower Inner	Saloon RWD 157981		Track Control Arm	S062799
	2011.02-2016.12	Front Axle Left & Right Lower Outer	Saloon RWD 157981		Ball Joint	S080671
	2011.02-2016.12	Rear Axle Left & Right Lower Inner	Saloon RWD 157981		Control Arm Bushing	530527
	2011.02-2016.12	Rear Axle Left & Right Upper Inner	Saloon RWD 157981		Control Arm Bushing	516563
	2011.02-2016.12	Rear Axle Left & Right Upper Inner	Saloon RWD 157981		Control Arm Bushing	533480
	2011.02-2016.12	Front Axle Left & Right	Saloon RWD 157981		Tie Rod Axle Joint	S031011
	2011.02-2016.12	Front Axle Left	Saloon RWD 157981		Tie Rod End	S070998
	2011.02-2016.12	Front Axle Right	Saloon RWD 157981		Tie Rod End	S070997
	2011.02-2016.12	Front Axle Left	Saloon RWD 157981		Rod/Strut, stabiliser	S050804
	2011.02-2016.12	Front Axle Right	Saloon RWD 157981		Rod/Strut, stabiliser	S050803
	2011.02-2016.12	Rear Axle Left	Saloon RWD 157981		Rod/Strut, stabiliser	S050306
	2011.02-2016.12	Rear Axle Right	Saloon RWD 157981		Rod/Strut, stabiliser	S050307
5.5 (410 kw)						
	2013.01-2016.12	Rear Axle Left & Right Lower Inner	Estate 4WD 157981		Control Arm Bushing	530527
	2013.01-2016.12	Rear Axle Left & Right Lower Inner	Saloon 4WD 157981		Control Arm Bushing	530527
	2013.01-2016.12	Rear Axle Left & Right Upper Inner	Estate 4WD 157981		Control Arm Bushing	533480
	2013.01-2016.12	Rear Axle Left & Right Upper Inner	Saloon 4WD 157981		Control Arm Bushing	533480
	2013.01-2016.12	Front Axle Left & Right	Estate 4WD 157981	For Vehicles Without Asd for vehicles without electric power steering	Tie Rod Axle Joint	S030177
	2013.01-2016.12	Front Axle Left & Right	Saloon 4WD 157981	For Vehicles Without Asd for vehicles without electric power steering	Tie Rod Axle Joint	S030177
	2013.01-2016.12	Front Axle Left & Right	Estate 4WD 157981	For Vehicles With Asd for vehicles with electric power steering	Tie Rod Axle Joint	S031011
	2013.01-2016.12	Front Axle Left & Right	Saloon 4WD 157981	for vehicles with asd for vehicles with electric power steering	Tie Rod Axle Joint	S031011
	2013.01-2016.12	Front Axle Left	Estate 4WD 157981		Tie Rod End	S071739
	2013.01-2016.12	Front Axle Left	Saloon 4WD 157981		Tie Rod End	S071739
	2013.01-2016.12	Front Axle Right	Estate 4WD 157981		Tie Rod End	S071740
	2013.01-2016.12	Front Axle Right	Saloon 4WD 157981		Tie Rod End	S071740
	2013.01-2016.12	Rear Axle Left	Estate 4WD 157981		Rod/Strut, stabiliser	S050306
	2013.01-2016.12	Rear Axle Left	Saloon 4WD 157981		Rod/Strut, stabiliser	S050306



	 YEAR	FITTING POSITION	BODY STYLE & DRIVE TYPE & ENGINE	REMARKS	PRODUCT	GSP Ref.
MERCEDES-BENZ E63 AMG						
5.5 (410 kw)	2013.01-2016.12	Rear Axle Right	Estate 4WD 157981		Rod/Strut,stabiliser	S050307
	2013.01-2016.12	Rear Axle Right	Saloon 4WD 157981		Rod/Strut,stabiliser	S050307
6.2 (378 kw)	2006.08-2009.11	Front Axle Left Upper	Saloon RWD 156983		Track Control Arm	S060223
	2006.08-2009.11	Front Axle Left Lower Inner	Saloon RWD 156983		Track Control Arm	S060225
	2006.08-2009.11	Front Axle Left Lower Outer	Saloon RWD 156983		Track Control Arm	S060227
	2006.08-2009.11	Front Axle Right Upper	Saloon RWD 156983		Track Control Arm	S060224
	2006.08-2009.11	Front Axle Right Lower Inner	Saloon RWD 156983		Track Control Arm	S060226
	2006.08-2009.11	Front Axle Left & Right Upper	Saloon RWD 156983		Ball Joint	S080145
	2006.08-2009.11	Front Axle Left & Right Lower Inner	Saloon RWD 156983	for OE No.211 330 81 07	Ball Joint	S080134
	2006.08-2009.11	Front Axle Left & Right Lower Inner	Saloon RWD 156983		Ball Joint	S080136
	2006.08-2009.11	Front Axle Left & Right Upper	Saloon RWD 156983		Control Arm Bushing	510529
	2006.08-2009.11	Front Axle Left & Right Lower Inner	Saloon RWD 156983		Control Arm Bushing	518119
	2006.08-2009.11	Front Axle Left & Right Lower Inner	Saloon RWD 156983		Control Arm Bushing	518120
	2006.08-2009.11	Front Axle Left & Right Lower Outer	Saloon RWD 156983		Control Arm Bushing	510518
	2006.08-2009.11	Front Axle Left & Right Lower Outer	Saloon RWD 156983		Control Arm Bushing	530133
	2006.08-2009.11	Front Axle	Saloon RWD 156983		Suspension Repair Kit	S990007SK
	2006.08-2009.11	Front Axle	Saloon RWD 156983		Suspension Repair Kit	S990035SK
	2006.08-2009.11	Front Axle	Saloon RWD 156983		Suspension Repair Kit	S990039SK
	2006.08-2009.11	Front Axle Left & Right	Saloon RWD 156983		Tie Rod Axle Joint	S030853
	2006.08-2009.11	Front Axle Left	Saloon RWD 156983		Tie Rod End	S070286
	2006.08-2009.11	Front Axle Right	Saloon RWD 156983		Tie Rod End	S070287
	2006.08-2009.11	Front Axle Left	Saloon RWD 156983		Rod/Strut,stabiliser	510516
	2006.08-2009.11	Front Axle Right	Saloon RWD 156983		Rod/Strut,stabiliser	510515
	2006.08-2009.11	Front Axle	Saloon RWD 156983		Stabiliser Bushing	510514
	2006.08-2009.11	Front Axle	Saloon RWD 156983	Date to:2007.01	Steering Rack Bellow Kit	540204S
6.2 (386 kw)	2009.12-2015.12	Front Axle Left & Right Lower Outer	Saloon RWD 156985		Ball Joint	S080671
	2009.12-2015.12	Rear Axle Left & Right Lower Inner	Saloon RWD 156985		Control Arm Bushing	530527
	2009.12-2015.12	Rear Axle Left & Right Upper Inner	Saloon RWD 156985		Control Arm Bushing	516563
	2009.12-2015.12	Rear Axle Left & Right Upper Inner	Saloon RWD 156985		Control Arm Bushing	533480
	2009.12-2015.12	Front Axle Left & Right	Saloon RWD 156985		Tie Rod Axle Joint	S030649
	2009.12-2015.12	Front Axle Left	Saloon RWD 156985		Tie Rod End	S070998
	2009.12-2015.12	Front Axle Right	Saloon RWD 156985		Tie Rod End	S070997
	2009.12-2015.12	Front Axle Left	Saloon RWD 156985		Rod/Strut,stabiliser	S050804
	2009.12-2015.12	Front Axle Right	Saloon RWD 156985		Rod/Strut,stabiliser	S050803
	2009.12-2015.12	Rear Axle Left	Saloon RWD 156985		Rod/Strut,stabiliser	S050306
	2009.12-2015.12	Rear Axle Right	Saloon RWD 156985		Rod/Strut,stabiliser	S050307
G320						
3.2 (158 kw)	1997.07-2004.08	Front Axle Left & Right Lower	Terrain cab wagon closed 4WD 112945		Control Arm Bushing	530528
	1997.07-2004.08	Front Axle Left & Right	Terrain cab wagon closed 4WD 112945		Stabiliser Bushing	530744
G55 AMG						
5.4 (350 kw)	2004.06-2006.07	Front Axle Left & Right Lower	Terrain cab wagon closed 4WD 113993		Control Arm Bushing	530528
G63 AMG						
4.0 (430 kw)	2018.03-	Front Axle Left & Right Lower	Terrain cab wagon closed 4WD 177980		Control Arm Bushing	517775
	2018.03-	Front Axle Left & Right Lower	Terrain cab wagon closed 4WD 177980		Control Arm Bushing	531449
5.5 (420 kw)	2015.06-	Front Axle Left & Right Lower	Terrain cab wagon closed 4WD 157984		Control Arm Bushing	530528
GLA200						
1.6 (115 kw)	2013.12-	Front Axle Left Lower	SUV FWD 270910		Track Control Arm	S061677
	2013.12-	Front Axle Right Lower	SUV FWD 270910		Track Control Arm	S061678
	2013.12-	Rear Axle Left Upper Inner	SUV FWD 270910		Track Control Arm	S062803
	2013.12-	Rear Axle Right Upper Inner	SUV FWD 270910		Track Control Arm	S063056
	2013.12-	Rear Axle Left & Right Lower Inner	SUV FWD 270910		Track Control Arm	S062807
	2013.12-	Rear Axle Left & Right Upper Outer	SUV FWD 270910		Track Control Arm	S062796
	2013.12-	Rear Axle Left & Right Lower Inner	SUV FWD 270910		Control Arm Bushing	535266
	2013.12-	Rear Axle Left & Right Upper Outer	SUV FWD 270910		Control Arm Bushing	535261
	2013.12-	Front Axle Left & Right	SUV FWD 270910		Tie Rod Axle Joint	S031088
	2013.12-	Front Axle Left	SUV FWD 270910		Tie Rod End	S071367
	2013.12-	Front Axle Right	SUV FWD 270910		Tie Rod End	S071368
	2013.12-	Front Axle Left & Right	SUV FWD 270910		Rod/Strut,stabiliser	S051410
	2013.12-	Rear Axle Left & Right	SUV FWD 270910	For OE no.2463200100	Rod/Strut,stabiliser	S051251
	2013.12-	Rear Axle Left & Right	SUV FWD 270910	For OE no.2463200489	Rod/Strut,stabiliser	S051263
GLA250						
2.0 (155 kw)	2013.12-	Front Axle Left Lower	SUV 4WD 270920		Track Control Arm	S061677
	2013.12-	Front Axle Left Lower	SUV FWD 270920		Track Control Arm	S061677
	2013.12-	Front Axle Right Lower	SUV 4WD 270920		Track Control Arm	S061678



	 YEAR	FITTING POSITION	BODY STYLE & DRIVE TYPE & ENGINE	REMARKS	PRODUCT	GSP Ref.
MERCEDES-BENZ GLA250						
2.0 (155 kw)						
	2013.12-	Front Axle Right Lower	SUV FWD 270920		Track Control Arm	S061678
	2013.12-	Rear Axle Left Upper Inner	SUV 4WD 270920		Track Control Arm	S062803
	2013.12-	Rear Axle Left Upper Inner	SUV FWD 270920		Track Control Arm	S062803
	2013.12-	Rear Axle Right Upper Inner	SUV 4WD 270920		Track Control Arm	S063056
	2013.12-	Rear Axle Right Upper Inner	SUV FWD 270920		Track Control Arm	S063056
	2013.12-	Rear Axle Left & Right Lower Inner	SUV 4WD 270920		Track Control Arm	S062807
	2013.12-	Rear Axle Left & Right Lower Inner	SUV FWD 270920		Track Control Arm	S062807
	2013.12-	Rear Axle Left & Right Upper Outer	SUV 4WD 270920		Track Control Arm	S062796
	2013.12-	Rear Axle Left & Right Upper Outer	SUV FWD 270920		Track Control Arm	S062796
	2013.12-	Rear Axle Left & Right Lower Inner	SUV 4WD 270920		Control Arm Bushing	535266
	2013.12-	Rear Axle Left & Right Lower Inner	SUV FWD 270920		Control Arm Bushing	535266
	2013.12-	Rear Axle Left & Right Upper Outer	SUV 4WD 270920		Control Arm Bushing	535261
	2013.12-	Rear Axle Left & Right Upper Outer	SUV FWD 270920		Control Arm Bushing	535261
	2013.12-	Front Axle Left & Right	SUV 4WD 270920		Tie Rod Axle Joint	S031088
	2013.12-	Front Axle Left & Right	SUV FWD 270920		Tie Rod Axle Joint	S031088
	2013.12-	Front Axle Left	SUV 4WD 270920		Tie Rod End	S071367
	2013.12-	Front Axle Left	SUV FWD 270920		Tie Rod End	S071367
	2013.12-	Front Axle Right	SUV 4WD 270920		Tie Rod End	S071368
	2013.12-	Front Axle Right	SUV FWD 270920		Tie Rod End	S071368
	2013.12-	Front Axle Left & Right	SUV 4WD 270920		Rod/Strut, stabiliser	S051410
	2013.12-	Front Axle Left & Right	SUV FWD 270920		Rod/Strut, stabiliser	S051410
	2013.12-	Rear Axle Left & Right	SUV 4WD 270920	For OE no.2463200100	Rod/Strut, stabiliser	S051251
	2013.12-	Rear Axle Left & Right	SUV FWD 270920	For OE no.2463200100	Rod/Strut, stabiliser	S051251
	2013.12-	Rear Axle Left & Right	SUV 4WD 270920	For OE no.2463200489	Rod/Strut, stabiliser	S051263
	2013.12-	Rear Axle Left & Right	SUV FWD 270920	For OE no.2463200489	Rod/Strut, stabiliser	S051263
GLA45 AMG						
2.0 (265 kw)						
	2014.05-	Front Axle Left Lower	SUV 4WD 133980		Track Control Arm	S061677
	2014.05-	Front Axle Right Lower	SUV 4WD 133980		Track Control Arm	S061678
	2014.05-	Rear Axle Left Upper Inner	SUV 4WD 133980		Track Control Arm	S062803
	2014.05-	Rear Axle Right Upper Inner	SUV 4WD 133980		Track Control Arm	S063056
	2014.05-	Rear Axle Left & Right Lower Inner	SUV 4WD 133980		Track Control Arm	S062807
	2014.05-	Front Axle Left & Right Lower	SUV 4WD 133980		Control Arm Bushing	535310
	2014.05-	Rear Axle Left & Right Lower Inner	SUV 4WD 133980		Control Arm Bushing	535266
	2014.05-	Rear Axle Left & Right Upper Outer	SUV 4WD 133980		Control Arm Bushing	535261
	2014.05-	Front Axle Left & Right	SUV 4WD 133980		Tie Rod Axle Joint	S031088
	2014.05-	Front Axle Left	SUV 4WD 133980		Tie Rod End	S071367
	2014.05-	Front Axle Right	SUV 4WD 133980		Tie Rod End	S071368
	2014.05-	Front Axle Left & Right	SUV 4WD 133980		Rod/Strut, stabiliser	S051410
	2014.05-	Rear Axle Left & Right	SUV 4WD 133980	For OE no.2463200100	Rod/Strut, stabiliser	S051251
	2014.05-	Rear Axle Left & Right	SUV 4WD 133980	For OE no.2463200489	Rod/Strut, stabiliser	S051263
GLB200						
1.3 (120 kw)						
	2019.08-	Front Axle Left & Right	SUV FWD 282914		Rod/Strut, stabiliser	S051359
	2019.08-	Rear Axle Left & Right	SUV FWD 282914		Rod/Strut, stabiliser	S051428
GLC250						
2.0 (155 kw)						
	2015.06-2019.04	Front Axle Left Upper	SUV 4WD 274920		Track Control Arm	S062802
	2015.06-2019.04	Front Axle Left Lower Outer	SUV 4WD 274920		Track Control Arm	S063218
	2015.06-2019.04	Front Axle Right Upper	SUV 4WD 274920		Track Control Arm	S062801
	2015.06-2019.04	Front Axle Right Lower Outer	SUV 4WD 274920		Track Control Arm	S063219
	2015.06-2019.04	Front Axle Left & Right Lower Inner	SUV 4WD 274920		Track Control Arm	S062842
	2015.06-2019.04	Rear Axle Left Upper Inner	SUV 4WD 274920		Track Control Arm	S063227
	2015.06-2019.04	Rear Axle Left Lower Outer	SUV 4WD 274920		Track Control Arm	S061566
	2015.06-2019.04	Rear Axle Left Upper Outer	SUV 4WD 274920		Track Control Arm	S062798
	2015.06-2019.04	Rear Axle Right Upper Inner	SUV 4WD 274920		Track Control Arm	S063228
	2015.06-2019.04	Rear Axle Right Lower Outer	SUV 4WD 274920		Track Control Arm	S061567
	2015.06-2019.04	Rear Axle Right Upper Outer	SUV 4WD 274920		Track Control Arm	S062797
	2015.06-2019.04	Rear Axle Left & Right Lower Inner	SUV 4WD 274920		Track Control Arm	S062799
	2015.06-2019.04	Front Axle Left & Right Upper	SUV 4WD 274920		Control Arm Bushing	510529
	2015.06-2019.04	Front Axle Left & Right Lower Inner	SUV 4WD 274920		Control Arm Bushing	533481
	2015.06-2019.04	Front Axle Left & Right Lower Inner	SUV 4WD 274920		Control Arm Bushing	535411
	2015.06-2019.04	Front Axle Left & Right Lower Inner	SUV 4WD 274920		Control Arm Bushing	535418
	2015.06-2019.04	Front Axle Left & Right Lower Outer	SUV 4WD 274920		Control Arm Bushing	535456
	2015.06-2019.04	Rear Axle Left & Right Upper Inner	SUV 4WD 274920		Control Arm Bushing	530504
	2015.06-2019.04	Rear Axle Left & Right Upper Inner	SUV 4WD 274920		Control Arm Bushing	533480
	2015.06-2019.04	Rear Axle Left & Right Lower Outer	SUV 4WD 274920		Control Arm Bushing	516552



	 YEAR	FITTING POSITION	BODY STYLE & DRIVE TYPE & ENGINE	REMARKS	PRODUCT	GSP Ref.
MERCEDES-BENZ						
GLC250						
2.0 (155 kw)						
	2015.06-2019.04	Front Axle Left & Right	SUV 4WD 274920		Tie Rod Axle Joint	S031025
	2015.06-2019.04	Front Axle Left	SUV 4WD 274920		Tie Rod End	S071773
	2015.06-2019.04	Front Axle Right	SUV 4WD 274920		Tie Rod End	S071774
	2015.06-2019.04	Front Axle Left	SUV 4WD 274920		Rod/Strut, stabiliser	S051374
	2015.06-2019.04	Front Axle Right	SUV 4WD 274920		Rod/Strut, stabiliser	S051373
	2015.06-2019.04	Rear Axle Left	SUV 4WD 274920		Rod/Strut, stabiliser	S051247
	2015.06-2019.04	Rear Axle Right	SUV 4WD 274920		Rod/Strut, stabiliser	S051248
	2015.06-2019.04	Front Axle	SUV 4WD 274920		Steering Boot	541030
	2016.06-2019.04	Front Axle Left Upper	SUV 4WD 274920		Track Control Arm	S062802
	2016.06-2019.04	Front Axle Left Lower Outer	SUV 4WD 274920		Track Control Arm	S063218
	2016.06-2019.04	Front Axle Right Upper	SUV 4WD 274920		Track Control Arm	S062801
	2016.06-2019.04	Front Axle Right Lower Outer	SUV 4WD 274920		Track Control Arm	S063219
	2016.06-2019.04	Front Axle Left & Right Lower Inner	SUV 4WD 274920		Track Control Arm	S062842
	2016.06-2019.04	Rear Axle Left Upper Inner	SUV 4WD 274920		Track Control Arm	S063227
	2016.06-2019.04	Rear Axle Left Lower Outer	SUV 4WD 274920		Track Control Arm	S061566
	2016.06-2019.04	Rear Axle Left Upper Outer	SUV 4WD 274920		Track Control Arm	S062798
	2016.06-2019.04	Rear Axle Right Upper Inner	SUV 4WD 274920		Track Control Arm	S063228
	2016.06-2019.04	Rear Axle Right Lower Outer	SUV 4WD 274920		Track Control Arm	S061567
	2016.06-2019.04	Rear Axle Right Upper Outer	SUV 4WD 274920		Track Control Arm	S062797
	2016.06-2019.04	Rear Axle Left & Right Lower Inner	SUV 4WD 274920		Track Control Arm	S062799
	2016.06-2019.04	Front Axle Left & Right Upper	SUV 4WD 274920		Control Arm Bushing	510529
	2016.06-2019.04	Front Axle Left & Right Lower Inner	SUV 4WD 274920		Control Arm Bushing	533481
	2016.06-2019.04	Front Axle Left & Right Lower Inner	SUV 4WD 274920		Control Arm Bushing	535411
	2016.06-2019.04	Front Axle Left & Right Lower Inner	SUV 4WD 274920		Control Arm Bushing	535418
	2016.06-2019.04	Front Axle Left & Right Lower Outer	SUV 4WD 274920		Control Arm Bushing	535456
	2016.06-2019.04	Rear Axle Left & Right Upper	SUV 4WD 274920		Control Arm Bushing	532971
	2016.06-2019.04	Rear Axle Left & Right Upper Inner	SUV 4WD 274920		Control Arm Bushing	530504
	2016.06-2019.04	Rear Axle Left & Right Upper Inner	SUV 4WD 274920		Control Arm Bushing	533480
	2016.06-2019.04	Rear Axle Left & Right Lower Outer	SUV 4WD 274920		Control Arm Bushing	516552
	2016.06-2019.04	Front Axle Left & Right	SUV 4WD 274920		Tie Rod Axle Joint	S031025
	2016.06-2019.04	Front Axle Left	SUV 4WD 274920		Tie Rod End	S071773
	2016.06-2019.04	Front Axle Right	SUV 4WD 274920		Tie Rod End	S071774
	2016.06-2019.04	Front Axle Left	SUV 4WD 274920		Rod/Strut, stabiliser	S051374
	2016.06-2019.04	Front Axle Right	SUV 4WD 274920		Rod/Strut, stabiliser	S051373
	2016.06-2019.04	Rear Axle Left	SUV 4WD 274920		Rod/Strut, stabiliser	S051247
	2016.06-2019.04	Rear Axle Right	SUV 4WD 274920		Rod/Strut, stabiliser	S051248
	2016.06-2019.04	Front Axle	SUV 4WD 274920		Steering Boot	541030
GLC300						
2.0 (190 kw)						
	2019.11-	Front Axle Left Lower Outer	SUV 4WD 264920		Track Control Arm	S063218
	2019.11-	Front Axle Right Lower Outer	SUV 4WD 264920		Track Control Arm	S063219
	2019.11-	Rear Axle Left Upper Inner	SUV 4WD 264920		Track Control Arm	S063227
	2019.11-	Rear Axle Left Lower Outer	SUV 4WD 264920		Track Control Arm	S061566
	2019.11-	Rear Axle Left Upper Outer	SUV 4WD 264920		Track Control Arm	S062798
	2019.11-	Rear Axle Right Upper Inner	SUV 4WD 264920		Track Control Arm	S063228
	2019.11-	Rear Axle Right Lower Outer	SUV 4WD 264920		Track Control Arm	S061567
	2019.11-	Rear Axle Right Upper Outer	SUV 4WD 264920		Track Control Arm	S062797
	2019.11-	Rear Axle Left & Right Lower Inner	SUV 4WD 264920		Track Control Arm	S062799
	2019.11-	Front Axle Left & Right Lower Inner	SUV 4WD 264920		Control Arm Bushing	535411
	2019.11-	Front Axle Left & Right Lower Inner	SUV 4WD 264920		Control Arm Bushing	535418
	2019.11-	Front Axle Left & Right Lower Outer	SUV 4WD 264920		Control Arm Bushing	535456
	2019.11-	Rear Axle Left & Right Upper Inner	SUV 4WD 264920		Control Arm Bushing	530504
	2019.11-	Front Axle Left & Right	SUV 4WD 264920		Tie Rod Axle Joint	S031025
	2019.11-	Front Axle Left	SUV 4WD 264920		Tie Rod End	S071773
	2019.11-	Front Axle Left	SUV 4WD 264920		Rod/Strut, stabiliser	S051374
	2019.11-	Front Axle Right	SUV 4WD 264920		Rod/Strut, stabiliser	S051373
	2019.11-	Rear Axle Left	SUV 4WD 264920		Rod/Strut, stabiliser	S051247
	2019.11-	Rear Axle Right	SUV 4WD 264920		Rod/Strut, stabiliser	S051248
	2019.11-	Front Axle	SUV 4WD 264920		Steering Boot	541030
GLC43 AMG						
3.0 (270 kw)						
	2015.07-2019.08	Front Axle Left Upper	SUV 4WD 276823		Track Control Arm	S062802
	2015.07-2019.08	Front Axle Right Upper	SUV 4WD 276823		Track Control Arm	S062801
	2015.07-2019.08	Front Axle Left & Right Lower Inner	SUV 4WD 276823		Track Control Arm	S062842
	2015.07-2019.08	Front Axle Left & Right Lower Inner	SUV 4WD 276823		Control Arm Bushing	533481
	2015.07-2019.08	Front Axle Left & Right Lower Inner	SUV 4WD 276823		Control Arm Bushing	535411



	 YEAR	FITTING POSITION	BODY STYLE & DRIVE TYPE & ENGINE	REMARKS	PRODUCT	GSP Ref.
MERCEDES-BENZ GLC43 AMG						
3.0 (270 kw)						
	2015.07-2019.08	Front Axle Left & Right Lower Inner	SUV 4WD 276823		Control Arm Bushing	535418
	2015.07-2019.08	Rear Axle Left & Right Upper Inner	SUV 4WD 276823		Control Arm Bushing	533480
	2015.07-2019.08	Front Axle Left & Right	SUV 4WD 276823		Tie Rod Axle Joint	S031025
	2015.07-2019.08	Front Axle Left	SUV 4WD 276823		Tie Rod End	S071773
	2015.07-2019.08	Front Axle Right	SUV 4WD 276823		Tie Rod End	S071774
	2015.07-2019.08	Front Axle Left	SUV 4WD 276823		Rod/Strut,stabiliser	S051374
	2015.07-2019.08	Front Axle Right	SUV 4WD 276823		Rod/Strut,stabiliser	S051373
	2015.07-2019.08	Rear Axle Left	SUV 4WD 276823		Rod/Strut,stabiliser	S051247
	2015.07-2019.08	Rear Axle Right	SUV 4WD 276823		Rod/Strut,stabiliser	S051248
	2015.07-2019.08	Front Axle	SUV 4WD 276823		Steering Boot	541030
	2016.10-2019.08	Front Axle Left Upper	SUV 4WD 276823		Track Control Arm	S062802
	2016.10-2019.08	Front Axle Right Upper	SUV 4WD 276823		Track Control Arm	S062801
	2016.10-2019.08	Front Axle Left & Right Lower Inner	SUV 4WD 276823		Track Control Arm	S062842
	2016.10-2019.08	Front Axle Left & Right Lower Inner	SUV 4WD 276823		Control Arm Bushing	533481
	2016.10-2019.08	Front Axle Left & Right Lower Inner	SUV 4WD 276823		Control Arm Bushing	535411
	2016.10-2019.08	Front Axle Left & Right Lower Inner	SUV 4WD 276823		Control Arm Bushing	535418
	2016.10-2019.08	Rear Axle Left & Right Upper Inner	SUV 4WD 276823		Control Arm Bushing	533480
	2016.10-2019.08	Front Axle Left & Right	SUV 4WD 276823		Tie Rod Axle Joint	S031025
	2016.10-2019.08	Front Axle Left	SUV 4WD 276823		Tie Rod End	S071773
	2016.10-2019.08	Front Axle Right	SUV 4WD 276823		Tie Rod End	S071774
	2016.10-2019.08	Front Axle Left	SUV 4WD 276823		Rod/Strut,stabiliser	S051374
	2016.10-2019.08	Front Axle Right	SUV 4WD 276823		Rod/Strut,stabiliser	S051373
	2016.10-2019.08	Rear Axle Left	SUV 4WD 276823		Rod/Strut,stabiliser	S051247
	2016.10-2019.08	Rear Axle Right	SUV 4WD 276823		Rod/Strut,stabiliser	S051248
	2016.10-2019.08	Front Axle	SUV 4WD 276823		Steering Boot	541030
3.0 (287 kw)						
	2019.08-	Front Axle Left Upper	SUV 4WD 276823		Track Control Arm	S062802
	2019.08-	Front Axle Right Upper	SUV 4WD 276823		Track Control Arm	S062801
	2019.08-	Front Axle Left & Right Lower Inner	SUV 4WD 276823		Track Control Arm	S062842
	2019.08-	Front Axle Left & Right Lower Inner	SUV 4WD 276823		Control Arm Bushing	535411
	2019.08-	Front Axle Left & Right Lower Inner	SUV 4WD 276823		Control Arm Bushing	535418
	2019.08-	Front Axle Left & Right	SUV 4WD 276823		Tie Rod Axle Joint	S031025
	2019.08-	Front Axle Left	SUV 4WD 276823		Tie Rod End	S071773
	2019.08-	Front Axle Left	SUV 4WD 276823		Rod/Strut,stabiliser	S051374
	2019.08-	Front Axle Right	SUV 4WD 276823		Rod/Strut,stabiliser	S051373
	2019.08-	Rear Axle Left	SUV 4WD 276823		Rod/Strut,stabiliser	S051247
	2019.08-	Rear Axle Right	SUV 4WD 276823		Rod/Strut,stabiliser	S051248
	2019.08-	Front Axle	SUV 4WD 276823		Steering Boot	541030
GLC63 AMG						
4.0 (350 kw)						
	2017.06-	Front Axle Left Upper	SUV 4WD 177980		Track Control Arm	S062802
	2017.06-	Front Axle Right Upper	SUV 4WD 177980		Track Control Arm	S062801
	2017.06-	Front Axle Left & Right Lower Inner	SUV 4WD 177980		Track Control Arm	S062842
	2017.06-	Front Axle Left & Right Lower Inner	SUV 4WD 177980		Control Arm Bushing	533481
	2017.06-	Front Axle Left & Right Lower Inner	SUV 4WD 177980		Control Arm Bushing	535411
	2017.06-	Front Axle Left & Right Lower Inner	SUV 4WD 177980		Control Arm Bushing	535418
	2017.06-	Rear Axle Left & Right Upper Inner	SUV 4WD 177980		Control Arm Bushing	533480
	2017.06-	Front Axle Left & Right	SUV 4WD 177980		Tie Rod Axle Joint	S031025
	2017.06-	Front Axle Left	SUV 4WD 177980		Tie Rod End	S071773
	2017.06-	Front Axle Left	SUV 4WD 177980		Rod/Strut,stabiliser	S051374
	2017.06-	Front Axle Right	SUV 4WD 177980		Rod/Strut,stabiliser	S051373
	2017.06-	Front Axle	SUV 4WD 177980		Steering Boot	541030
4.0 (375 kw)						
	2017.06-	Front Axle Left Upper	SUV 4WD 177980		Track Control Arm	S062802
	2017.06-	Front Axle Right Upper	SUV 4WD 177980		Track Control Arm	S062801
	2017.06-	Front Axle Left & Right Lower Inner	SUV 4WD 177980		Track Control Arm	S062842
	2017.06-	Front Axle Left & Right Lower Inner	SUV 4WD 177980		Control Arm Bushing	533481
	2017.06-	Front Axle Left & Right Lower Inner	SUV 4WD 177980		Control Arm Bushing	535411
	2017.06-	Front Axle Left & Right Lower Inner	SUV 4WD 177980		Control Arm Bushing	535418
	2017.06-	Rear Axle Left & Right Upper Inner	SUV 4WD 177980		Control Arm Bushing	533480
	2017.06-	Front Axle Left & Right	SUV 4WD 177980		Tie Rod Axle Joint	S031025
	2017.06-	Front Axle Left	SUV 4WD 177980		Tie Rod End	S071773
	2017.06-	Front Axle Left	SUV 4WD 177980		Rod/Strut,stabiliser	S051374
	2017.06-	Front Axle Right	SUV 4WD 177980		Rod/Strut,stabiliser	S051373
	2017.06-	Front Axle	SUV 4WD 177980		Steering Boot	541030



	 YEAR	FITTING POSITION	BODY STYLE & DRIVE TYPE & ENGINE	REMARKS	PRODUCT	GSP Ref.
MERCEDES-BENZ GLE350						
3.0 (190 kw)	2015.04-2018.10	Front Axle Left Lower	SUV 4WD 642826		Track Control Arm	S063166
	2015.04-2018.10	Front Axle Left Upper	SUV 4WD 642826		Track Control Arm	S063047
	2015.04-2018.10	Front Axle Right Lower	SUV 4WD 642826		Track Control Arm	S063156
	2015.04-2018.10	Front Axle Right Upper	SUV 4WD 642826		Track Control Arm	S063048
	2015.04-2018.10	Rear Axle Left & Right Centre	SUV 4WD 642826		Track Control Arm	S063127
	2015.04-2018.10	Front Axle Right Lower	SUV 4WD 642826		Control Arm Bushing	535169
	2015.04-2018.10	Front Axle Left & Right Lower	SUV 4WD 642826		Control Arm Bushing	517775
	2015.04-2018.10	Front Axle Left & Right Lower	SUV 4WD 642826		Control Arm Bushing	531449
	2015.04-2018.10	Front Axle Left & Right Upper	SUV 4WD 642826		Control Arm Bushing	517773
	2015.04-2018.10	Rear Axle Left & Right Lower	SUV 4WD 642826		Control Arm Bushing	532478
	2015.04-2018.10	Rear Axle Left & Right Upper	SUV 4WD 642826		Control Arm Bushing	532971
	2015.04-2018.10	Rear Axle Left & Right	SUV 4WD 642826		Rod/Strut, stabiliser	S050292
GLE400						
3.0 (245 kw)	2015.03-2019.10	Front Axle Left Lower	SUV 4WD 276821/276825		Track Control Arm	S063166
	2015.03-2019.10	Front Axle Left Upper	SUV 4WD 276821/276825		Track Control Arm	S063047
	2015.03-2019.10	Front Axle Right Lower	SUV 4WD 276821/276825		Track Control Arm	S063156
	2015.03-2019.10	Front Axle Right Upper	SUV 4WD 276821/276825		Track Control Arm	S063048
	2015.03-2019.10	Rear Axle Left & Right Centre	SUV 4WD 276821/276825		Track Control Arm	S063127
	2015.03-2019.10	Front Axle Right Lower	SUV 4WD 276821/276825		Control Arm Bushing	535169
	2015.03-2019.10	Front Axle Left & Right Lower	SUV 4WD 276821/276825		Control Arm Bushing	517775
	2015.03-2019.10	Front Axle Left & Right Lower	SUV 4WD 276821/276825		Control Arm Bushing	531449
	2015.03-2019.10	Front Axle Left & Right Upper	SUV 4WD 276821/276825		Control Arm Bushing	517773
	2015.03-2019.10	Rear Axle Left & Right Lower	SUV 4WD 276821/276825		Control Arm Bushing	532478
	2015.03-2019.10	Rear Axle Left & Right Upper	SUV 4WD 276821/276825		Control Arm Bushing	532971
	2015.03-2019.10	Rear Axle Left & Right	SUV 4WD 276821/276825		Rod/Strut, stabiliser	S050292
GLE43 AMG						
3.0 (270 kw)	2016.05-2018.10	Front Axle Left Upper	SUV 4WD 276821		Track Control Arm	S063047
	2016.05-2018.10	Front Axle Right Upper	SUV 4WD 276821		Track Control Arm	S063048
	2016.05-2018.10	Rear Axle Left & Right Centre	SUV 4WD 276821		Track Control Arm	S063127
	2016.05-2018.10	Front Axle Left & Right Lower	SUV 4WD 276821		Control Arm Bushing	517775
	2016.05-2018.10	Front Axle Left & Right Lower	SUV 4WD 276821		Control Arm Bushing	531449
	2016.05-2018.10	Front Axle Left & Right Upper	SUV 4WD 276821		Control Arm Bushing	517773
	2016.05-2018.10	Rear Axle Left & Right Lower	SUV 4WD 276821		Control Arm Bushing	532478
	2016.05-2018.10	Rear Axle Left & Right Upper	SUV 4WD 276821		Control Arm Bushing	532971
	2016.05-2018.10	Rear Axle Left & Right	SUV 4WD 276821		Rod/Strut, stabiliser	S050292
	2016.05-2019.10	Front Axle Left Upper	SUV 4WD 276821		Track Control Arm	S063047
	2016.05-2019.10	Front Axle Right Upper	SUV 4WD 276821		Track Control Arm	S063048
	2016.05-2019.10	Rear Axle Left & Right Centre	SUV 4WD 276821		Track Control Arm	S063127
	2016.05-2019.10	Front Axle Right Lower	SUV 4WD 276821		Control Arm Bushing	535169
	2016.05-2019.10	Front Axle Left & Right Lower	SUV 4WD 276821		Control Arm Bushing	517775
	2016.05-2019.10	Front Axle Left & Right Lower	SUV 4WD 276821		Control Arm Bushing	531449
	2016.05-2019.10	Front Axle Left & Right Upper	SUV 4WD 276821		Control Arm Bushing	517773
	2016.05-2019.10	Rear Axle Left & Right Lower	SUV 4WD 276821		Control Arm Bushing	532478
	2016.05-2019.10	Rear Axle Left & Right Upper	SUV 4WD 276821		Control Arm Bushing	532971
2016.05-2019.10	Rear Axle Left & Right	SUV 4WD 276821		Rod/Strut, stabiliser	S050292	
GLE450 AMG						
3.0 (270 kw)	2015.10-2018.10	Front Axle Left Upper	SUV 4WD 276821		Track Control Arm	S063047
	2015.10-2018.10	Front Axle Right Upper	SUV 4WD 276821		Track Control Arm	S063048
	2015.10-2018.10	Rear Axle Left & Right Centre	SUV 4WD 276821		Track Control Arm	S063127
	2015.10-2018.10	Front Axle Right Lower	SUV 4WD 276821		Control Arm Bushing	535169
	2015.10-2018.10	Front Axle Left & Right Lower	SUV 4WD 276821		Control Arm Bushing	517775
	2015.10-2018.10	Front Axle Left & Right Lower	SUV 4WD 276821		Control Arm Bushing	531449
	2015.10-2018.10	Front Axle Left & Right Upper	SUV 4WD 276821		Control Arm Bushing	517773
	2015.10-2018.10	Rear Axle Left & Right Lower	SUV 4WD 276821		Control Arm Bushing	532478
	2015.10-2018.10	Rear Axle Left & Right Upper	SUV 4WD 276821		Control Arm Bushing	532971
2015.10-2018.10	Rear Axle Left & Right	SUV 4WD 276821		Rod/Strut, stabiliser	S050292	
GLE63 AMG						
5.5 (410 kw)	2015.03-2019.10	Front Axle Left Upper	SUV 4WD 157982		Track Control Arm	S063047
	2015.03-2019.10	Front Axle Right Upper	SUV 4WD 157982		Track Control Arm	S063048
	2015.03-2019.10	Rear Axle Left & Right Centre	SUV 4WD 157982		Track Control Arm	S063127
	2015.03-2019.10	Front Axle Right Lower	SUV 4WD 157982		Control Arm Bushing	535169
	2015.03-2019.10	Front Axle Left & Right Lower	SUV 4WD 157982		Control Arm Bushing	517775
	2015.03-2019.10	Front Axle Left & Right Lower	SUV 4WD 157982		Control Arm Bushing	531449
2015.03-2019.10	Front Axle Left & Right Upper	SUV 4WD 157982		Control Arm Bushing	517773	



	 YEAR	FITTING POSITION	BODY STYLE & DRIVE TYPE & ENGINE	REMARKS	PRODUCT	GSP Ref.
MERCEDES-BENZ GLE63 AMG						
5.5 (410 kw)	2015.03-2019.10	Rear Axle Left & Right Lower	SUV 4WD 157982		Control Arm Bushing	532478
	2015.03-2019.10	Rear Axle Left & Right Upper	SUV 4WD 157982		Control Arm Bushing	532971
	2015.03-2019.10	Rear Axle Left & Right	SUV 4WD 157982		Rod/Strut, stabiliser	S050292
	2015.04-2018.10	Front Axle Left Lower	SUV 4WD 157982		Track Control Arm	S063166
	2015.04-2018.10	Front Axle Left Upper	SUV 4WD 157982		Track Control Arm	S063047
	2015.04-2018.10	Front Axle Right Lower	SUV 4WD 157982		Track Control Arm	S063156
	2015.04-2018.10	Front Axle Right Upper	SUV 4WD 157982		Track Control Arm	S063048
	2015.04-2018.10	Rear Axle Left & Right Centre	SUV 4WD 157982		Track Control Arm	S063127
	2015.04-2018.10	Rear Axle Left & Right Lower	SUV 4WD 157982		Ball Joint	S080674
	2015.04-2018.10	Front Axle Right Lower	SUV 4WD 157982		Control Arm Bushing	535169
	2015.04-2018.10	Front Axle Left & Right Lower	SUV 4WD 157982		Control Arm Bushing	517775
	2015.04-2018.10	Front Axle Left & Right Lower	SUV 4WD 157982		Control Arm Bushing	531449
	2015.04-2018.10	Front Axle Left & Right Upper	SUV 4WD 157982		Control Arm Bushing	517773
	2015.04-2018.10	Rear Axle Left & Right Lower	SUV 4WD 157982		Control Arm Bushing	532478
	2015.04-2018.10	Rear Axle Left & Right Upper	SUV 4WD 157982		Control Arm Bushing	532971
	2015.04-2018.10	Rear Axle Left & Right	SUV 4WD 157982		Rod/Strut, stabiliser	S050292
GLK220						
2.2 (125 kw)	2008.06-2015.06	Front Axle Left Lower Outer	SUV 4WD 651912		Track Control Arm	S063049
	2008.06-2015.06	Front Axle Right Lower Outer	SUV 4WD 651912		Track Control Arm	S063050
	2008.06-2015.06	Front Axle Left & Right Lower Inner	SUV 4WD 651912		Track Control Arm	S063099
	2008.06-2015.06	Rear Axle Left Lower Outer	SUV 4WD 651912		Track Control Arm	S061566
	2008.06-2015.06	Rear Axle Right Lower Outer	SUV 4WD 651912		Track Control Arm	S061567
	2008.06-2015.06	Rear Axle Left & Right Lower Inner	SUV 4WD 651912		Track Control Arm	S062799
	2008.06-2015.06	Front Axle Left & Right Lower Inner	SUV 4WD 651912		Control Arm Bushing	531451
	2008.06-2015.06	Front Axle Left & Right Lower Outer	SUV 4WD 651912		Control Arm Bushing	510491
	2008.06-2015.06	Front Axle Left & Right Lower Outer	SUV 4WD 651912		Control Arm Bushing	531450
	2008.06-2015.06	Rear Axle Left & Right Lower Inner	SUV 4WD 651912		Control Arm Bushing	530527
	2008.06-2015.06	Rear Axle Left & Right Upper Inner	SUV 4WD 651912		Control Arm Bushing	516563
	2008.06-2015.06	Rear Axle Left & Right Upper Inner	SUV 4WD 651912		Control Arm Bushing	533480
	2008.06-2015.06	Rear Axle Left & Right Lower Outer	SUV 4WD 651912		Control Arm Bushing	516552
	2008.06-2015.06	Rear Axle Left & Right Lower Outer	SUV 4WD 651912		Control Arm Bushing	516553
	2008.06-2015.06	Front Axle Left & Right	SUV 4WD 651912	for vehicles with hydraulic power steering	Tie Rod Axle Joint	S030177
	2008.06-2015.06	Front Axle Left & Right	SUV 4WD 651912	for vehicles with electric power steering	Tie Rod Axle Joint	S031011
	2008.06-2015.06	Front Axle Left	SUV 4WD 651912		Tie Rod End	S071739
	2008.06-2015.06	Front Axle Right	SUV 4WD 651912		Tie Rod End	S071740
	2008.06-2015.06	Front Axle Left	SUV 4WD 651912	For OE no.2043200789	Rod/Strut, stabiliser	S050904
	2008.06-2015.06	Front Axle Left	SUV 4WD 651912	For OE no.2043200789	Rod/Strut, stabiliser	S051363
	2008.06-2015.06	Front Axle Right	SUV 4WD 651912		Rod/Strut, stabiliser	S050905
	2008.06-2015.06	Front Axle Right	SUV 4WD 651912		Rod/Strut, stabiliser	S051412
	2008.06-2015.06	Rear Axle Left	SUV 4WD 651912		Rod/Strut, stabiliser	S050306
	2008.06-2015.06	Rear Axle Right	SUV 4WD 651912		Rod/Strut, stabiliser	S050307
GLK280						
3.0 (170 kw)	2008.06-2013.12	Front Axle Left Lower Outer	SUV 4WD 272948		Track Control Arm	S063049
	2008.06-2013.12	Front Axle Right Lower Outer	SUV 4WD 272948		Track Control Arm	S063050
	2008.06-2013.12	Front Axle Left & Right Lower Inner	SUV 4WD 272948		Track Control Arm	S063099
	2008.06-2013.12	Rear Axle Left Lower Outer	SUV 4WD 272948		Track Control Arm	S061566
	2008.06-2013.12	Rear Axle Left Upper Outer	SUV 4WD 272948		Track Control Arm	S062798
	2008.06-2013.12	Rear Axle Right Lower Outer	SUV 4WD 272948		Track Control Arm	S061567
	2008.06-2013.12	Rear Axle Right Upper Outer	SUV 4WD 272948		Track Control Arm	S062797
	2008.06-2013.12	Rear Axle Left & Right Lower Inner	SUV 4WD 272948		Track Control Arm	S062799
	2008.06-2013.12	Front Axle Left & Right Lower Inner	SUV 4WD 272948		Control Arm Bushing	531451
	2008.06-2013.12	Front Axle Left & Right Lower Outer	SUV 4WD 272948		Control Arm Bushing	510491
	2008.06-2013.12	Front Axle Left & Right Lower Outer	SUV 4WD 272948		Control Arm Bushing	531450
	2008.06-2013.12	Rear Axle Left & Right Lower Inner	SUV 4WD 272948		Control Arm Bushing	530527
	2008.06-2013.12	Rear Axle Left & Right Upper Inner	SUV 4WD 272948		Control Arm Bushing	516563
	2008.06-2013.12	Rear Axle Left & Right Upper Inner	SUV 4WD 272948		Control Arm Bushing	533480
	2008.06-2013.12	Rear Axle Left & Right Lower Outer	SUV 4WD 272948		Control Arm Bushing	516552
	2008.06-2013.12	Rear Axle Left & Right Lower Outer	SUV 4WD 272948		Control Arm Bushing	516553
	2008.06-2013.12	Front Axle Left & Right	SUV 4WD 272948	for vehicles with hydraulic power steering	Tie Rod Axle Joint	S030177
	2008.06-2013.12	Front Axle Left & Right	SUV 4WD 272948	for vehicles with electric power steering	Tie Rod Axle Joint	S031011
	2008.06-2013.12	Front Axle Left	SUV 4WD 272948		Tie Rod End	S071739
	2008.06-2013.12	Front Axle Right	SUV 4WD 272948		Tie Rod End	S071740
	2008.06-2013.12	Front Axle Left	SUV 4WD 272948	For OE no.2043200789	Rod/Strut, stabiliser	S050904
	2008.06-2013.12	Front Axle Left	SUV 4WD 272948	For OE no.2043200789	Rod/Strut, stabiliser	S051363



	 YEAR	FITTING POSITION	BODY STYLE & DRIVE TYPE & ENGINE	REMARKS	PRODUCT	GSP Ref.	
MERCEDES-BENZ GLK280							
3.0 (170 kw)	2008.06-2013.12	Front Axle Right	SUV 4WD 272948		Rod/Strut, stabiliser	S050905	
	2008.06-2013.12	Front Axle Right	SUV 4WD 272948		Rod/Strut, stabiliser	S051412	
	2008.06-2013.12	Rear Axle Left	SUV 4WD 272948		Rod/Strut, stabiliser	S050306	
	2008.06-2013.12	Rear Axle Right	SUV 4WD 272948		Rod/Strut, stabiliser	S050307	
GLK300							
3.0 (170 kw)	2008.11-2015.12	Front Axle Left Lower Outer	SUV 4WD 272948		Track Control Arm	S063049	
	2008.11-2015.12	Front Axle Right Lower Outer	SUV 4WD 272948		Track Control Arm	S063050	
	2008.11-2015.12	Front Axle Left & Right Lower Inner	SUV 4WD 272948		Track Control Arm	S063099	
	2008.11-2015.12	Rear Axle Left Lower Outer	SUV 4WD 272948		Track Control Arm	S061566	
	2008.11-2015.12	Rear Axle Left Upper Outer	SUV 4WD 272948		Track Control Arm	S062798	
	2008.11-2015.12	Rear Axle Right Lower Outer	SUV 4WD 272948		Track Control Arm	S061567	
	2008.11-2015.12	Rear Axle Right Upper Outer	SUV 4WD 272948		Track Control Arm	S062797	
	2008.11-2015.12	Rear Axle Left & Right Lower Inner	SUV 4WD 272948		Track Control Arm	S062799	
	2008.11-2015.12	Front Axle Left & Right Lower Inner	SUV 4WD 272948		Control Arm Bushing	531451	
	2008.11-2015.12	Front Axle Left & Right Lower Outer	SUV 4WD 272948		Control Arm Bushing	510491	
	2008.11-2015.12	Front Axle Left & Right Lower Outer	SUV 4WD 272948		Control Arm Bushing	531450	
	2008.11-2015.12	Rear Axle Left & Right Lower Inner	SUV 4WD 272948		Control Arm Bushing	530527	
	2008.11-2015.12	Rear Axle Left & Right Upper Inner	SUV 4WD 272948		Control Arm Bushing	516563	
	2008.11-2015.12	Rear Axle Left & Right Upper Inner	SUV 4WD 272948		Control Arm Bushing	533480	
	2008.11-2015.12	Rear Axle Left & Right Lower Outer	SUV 4WD 272948		Control Arm Bushing	516552	
	2008.11-2015.12	Rear Axle Left & Right Lower Outer	SUV 4WD 272948		Control Arm Bushing	516553	
	2008.11-2015.12	Front Axle Left & Right	SUV 4WD 272948	for vehicles with hydraulic power steering	Tie Rod Axle Joint	S030177	
	2008.11-2015.12	Front Axle Left & Right	SUV 4WD 272948	for vehicles with electric power steering	Tie Rod Axle Joint	S031011	
	2008.11-2015.12	Front Axle Left	SUV 4WD 272948		Tie Rod End	S071739	
	2008.11-2015.12	Front Axle Right	SUV 4WD 272948		Tie Rod End	S071740	
	2008.11-2015.12	Front Axle Left	SUV 4WD 272948		For OE no.2043200789	Rod/Strut, stabiliser	S050904
	2008.11-2015.12	Front Axle Left	SUV 4WD 272948		For OE no.2043200789	Rod/Strut, stabiliser	S051363
	2008.11-2015.12	Front Axle Right	SUV 4WD 272948			Rod/Strut, stabiliser	S050905
	2008.11-2015.12	Front Axle Right	SUV 4WD 272948			Rod/Strut, stabiliser	S051412
	2008.11-2015.12	Rear Axle Left	SUV 4WD 272948			Rod/Strut, stabiliser	S050306
	2008.11-2015.12	Rear Axle Right	SUV 4WD 272948			Rod/Strut, stabiliser	S050307
	GLS350						
	3.0 (190 kw)	2015.11-2019.04	Front Axle Left Lower	SUV 4WD 642826		Track Control Arm	S063166
2015.11-2019.04		Front Axle Left Upper	SUV 4WD 642826		Track Control Arm	S063047	
2015.11-2019.04		Front Axle Right Lower	SUV 4WD 642826		Track Control Arm	S063156	
2015.11-2019.04		Front Axle Right Upper	SUV 4WD 642826		Track Control Arm	S063048	
2015.11-2019.04		Rear Axle Left & Right Centre	SUV 4WD 642826		Track Control Arm	S063127	
2015.11-2019.04		Front Axle Right Lower	SUV 4WD 642826		Control Arm Bushing	535169	
2015.11-2019.04		Front Axle Left & Right Lower	SUV 4WD 642826		Control Arm Bushing	517775	
2015.11-2019.04		Front Axle Left & Right Lower	SUV 4WD 642826		Control Arm Bushing	531449	
2015.11-2019.04		Front Axle Left & Right Upper	SUV 4WD 642826		Control Arm Bushing	517773	
2015.11-2019.04		Rear Axle Left & Right Lower	SUV 4WD 642826		Control Arm Bushing	532478	
2015.11-2019.04		Rear Axle Left & Right Upper	SUV 4WD 642826		Control Arm Bushing	532971	
2015.11-2019.04		Rear Axle Left & Right	SUV 4WD 642826		Rod/Strut, stabiliser	S050292	
ML230							
2.3 (110 kw)	1998.04-2000.08	Front Axle Left Lower	SUV 4WD 111977		Track Control Arm	S061302	
	1998.04-2000.08	Front Axle Left Upper	SUV 4WD 111977		Track Control Arm	S060593	
	1998.04-2000.08	Front Axle Right Lower	SUV 4WD 111977		Track Control Arm	S061303	
	1998.04-2000.08	Front Axle Right Upper	SUV 4WD 111977		Track Control Arm	S060594	
	1998.04-2000.08	Rear Axle Left Upper Inner	SUV 4WD 111977		Track Control Arm	S060269	
	1998.04-2000.08	Rear Axle Left Upper Outer	SUV 4WD 111977		Track Control Arm	S060245	
	1998.04-2000.08	Rear Axle Right Upper Inner	SUV 4WD 111977		Track Control Arm	S060270	
	1998.04-2000.08	Rear Axle Right Upper Outer	SUV 4WD 111977		Track Control Arm	S060246	
	1998.04-2000.08	Front Axle Left & Right Lower	SUV 4WD 111977		Ball Joint	S080130	
	1998.04-2000.08	Rear Axle Left & Right Lower	SUV 4WD 111977		Ball Joint	S080131	
	1998.04-2000.08	Front Axle Left & Right Lower	SUV 4WD 111977		Control Arm Bushing	512766	
	1998.04-2000.08	Front Axle Left & Right Upper	SUV 4WD 111977		Control Arm Bushing	510509	
	1998.04-2000.08	Rear Axle Left & Right Upper Inner	SUV 4WD 111977		Control Arm Bushing	512252	
	1998.04-2000.08	Rear Axle Left & Right Upper Outer	SUV 4WD 111977		Control Arm Bushing	510509	
	1998.04-2000.08	Front Axle Left & Right Upper	SUV 4WD 111977		Control Arm Bushing Kit	510509S	
	1998.04-2000.08	Rear Axle Left & Right Upper Outer	SUV 4WD 111977		Control Arm Bushing Kit	510509S	
	1998.04-2000.08	Front Axle Left & Right	SUV 4WD 111977		Tie Rod Axle Joint	S030161	
	1998.04-2000.08	Front Axle Left	SUV 4WD 111977		Tie Rod End	S070276	
	1998.04-2000.08	Front Axle Right	SUV 4WD 111977		Tie Rod End	S070275	



	 YEAR	FITTING POSITION	BODY STYLE & DRIVE TYPE & ENGINE	REMARKS	PRODUCT	GSP Ref.	
MERCEDES-BENZ ML230							
2.3 (110 kw)	1998.04-2000.08	Rear Axle Left & Right	SUV 4WD 111977		Rod/Strut, stabiliser	S050309	
	1998.04-2000.08	Front Axle	SUV 4WD 111977		Steering Boot	540206	
	1998.04-2000.08	Front Axle	SUV 4WD 111977		Steering Rack Bellow Kit	540206S	
	1998.04-2000.08	Front Axle	SUV 4WD 111977		Stabiliser Bushing Kit	512575S	
	1998.04-2000.08	Rear Axle	SUV 4WD 111977		Stabiliser Bushing Kit	516869S	
ML270							
2.7 (120 kw)	1999.06-2005.07	Front Axle Left Lower	SUV 4WD 612963		Track Control Arm	S061302	
	1999.06-2005.07	Front Axle Left Upper	SUV 4WD 612963		Track Control Arm	S060593	
	1999.06-2005.07	Front Axle Right Lower	SUV 4WD 612963		Track Control Arm	S061303	
	1999.06-2005.07	Front Axle Right Upper	SUV 4WD 612963		Track Control Arm	S060594	
	1999.06-2005.07	Rear Axle Left Upper Inner	SUV 4WD 612963		Track Control Arm	S060269	
	1999.06-2005.07	Rear Axle Left Upper Outer	SUV 4WD 612963		Track Control Arm	S060245	
	1999.06-2005.07	Rear Axle Right Upper Inner	SUV 4WD 612963		Track Control Arm	S060270	
	1999.06-2005.07	Rear Axle Right Upper Outer	SUV 4WD 612963		Track Control Arm	S060246	
	1999.06-2005.07	Front Axle Left & Right Lower	SUV 4WD 612963		Ball Joint	S080130	
	1999.06-2005.07	Rear Axle Left & Right Lower	SUV 4WD 612963		Ball Joint	S080131	
	1999.06-2005.07	Front Axle Left & Right Lower	SUV 4WD 612963		Control Arm Bushing	512766	
	1999.06-2005.07	Front Axle Left & Right Upper	SUV 4WD 612963		Control Arm Bushing	510509	
	1999.06-2005.07	Rear Axle Left & Right Upper Inner	SUV 4WD 612963		Control Arm Bushing	512252	
	1999.06-2005.07	Rear Axle Left & Right Upper Outer	SUV 4WD 612963		Control Arm Bushing	510509	
	1999.06-2005.07	Front Axle Left & Right Upper	SUV 4WD 612963		Control Arm Bushing Kit	510509S	
	1999.06-2005.07	Rear Axle Left & Right Upper Outer	SUV 4WD 612963		Control Arm Bushing Kit	510509S	
	1999.06-2005.07	Front Axle Left & Right	SUV 4WD 612963		Tie Rod Axle Joint	S030161	
	1999.06-2005.07	Front Axle Left	SUV 4WD 612963		Tie Rod End	S070276	
	1999.06-2005.07	Front Axle Right	SUV 4WD 612963		Tie Rod End	S070275	
	1999.06-2005.07	Rear Axle Left & Right	SUV 4WD 612963		Rod/Strut, stabiliser	S050309	
	1999.06-2005.07	Front Axle	SUV 4WD 612963		Steering Boot	540206	
	1999.06-2005.07	Front Axle	SUV 4WD 612963		Steering Rack Bellow Kit	540206S	
	1999.06-2005.07	Front Axle	SUV 4WD 612963		Stabiliser Bushing Kit	512575S	
	1999.06-2005.07	Rear Axle	SUV 4WD 612963		Stabiliser Bushing Kit	516869S	
	ML320						
	3.0 (165 kw)	2005.07-2011.07	Front Axle Left Lower	SUV 4WD 642940		Track Control Arm	S061308
		2005.07-2011.07	Front Axle Left Upper	SUV 4WD 642940		Track Control Arm	S061306
2005.07-2011.07		Front Axle Right Lower	SUV 4WD 642940		Track Control Arm	S061307	
2005.07-2011.07		Front Axle Right Upper	SUV 4WD 642940		Track Control Arm	S061305	
2005.07-2011.07		Rear Axle Left & Right Centre	SUV 4WD 642940		Track Control Arm	S063127	
2005.07-2011.07		Front Axle Left & Right Lower	SUV 4WD 642940		Ball Joint	S080138	
2005.07-2011.07		Rear Axle Left & Right Lower	SUV 4WD 642940		Ball Joint	S080674	
2005.07-2011.07		Front Axle Left & Right Lower	SUV 4WD 642940		Control Arm Bushing	517766	
2005.07-2011.07		Front Axle Left & Right Lower	SUV 4WD 642940		Control Arm Bushing	517775	
2005.07-2011.07		Front Axle Left & Right Lower	SUV 4WD 642940		Control Arm Bushing	517776	
2005.07-2011.07		Front Axle Left & Right Lower	SUV 4WD 642940		Control Arm Bushing	531937	
2005.07-2011.07		Front Axle Left & Right Upper	SUV 4WD 642940		Control Arm Bushing	517773	
2005.07-2011.07		Rear Axle Left & Right Upper	SUV 4WD 642940		Control Arm Bushing	532971	
2005.07-2011.07		Rear Axle Left & Right Lower Inner	SUV 4WD 642940		Control Arm Bushing	532478	
2005.07-2011.07		Front Axle Left & Right	SUV 4WD 642940		Tie Rod Axle Joint	S030170	
2005.07-2011.07		Front Axle Left	SUV 4WD 642940		Tie Rod End	S070303	
2005.07-2011.07		Front Axle Right	SUV 4WD 642940		Tie Rod End	S070304	
2005.07-2011.07		Front Axle Left & Right	SUV 4WD 642940		Rod/Strut, stabiliser	S050300	
2005.07-2011.07		Rear Axle Left & Right	SUV 4WD 642940		Rod/Strut, stabiliser	S050292	
2005.07-2011.07		Front Axle	SUV 4WD 642940		Stabiliser Bushing	530168	
2005.07-2011.07		Front Axle	SUV 4WD 642940		Steering Boot	540209	
2005.07-2011.07		Front Axle	SUV 4WD 642940		Steering Rack Bellow Kit	540209S	
3.2 (160 kw)		1998.02-2003.04	Front Axle Left Lower	SUV 4WD 112942		Track Control Arm	S061302
	1998.02-2003.04	Front Axle Left Upper	SUV 4WD 112942		Track Control Arm	S060593	
	1998.02-2003.04	Front Axle Right Lower	SUV 4WD 112942		Track Control Arm	S061303	
	1998.02-2003.04	Front Axle Right Upper	SUV 4WD 112942		Track Control Arm	S060594	
	1998.02-2003.04	Rear Axle Left Upper Inner	SUV 4WD 112942		Track Control Arm	S060269	
	1998.02-2003.04	Rear Axle Left Upper Outer	SUV 4WD 112942		Track Control Arm	S060245	
	1998.02-2003.04	Rear Axle Right Upper Inner	SUV 4WD 112942		Track Control Arm	S060270	
	1998.02-2003.04	Rear Axle Right Upper Outer	SUV 4WD 112942		Track Control Arm	S060246	
	1998.02-2003.04	Front Axle Left & Right Lower	SUV 4WD 112942		Ball Joint	S080130	
	1998.02-2003.04	Rear Axle Left & Right Lower	SUV 4WD 112942		Ball Joint	S080131	
	1998.02-2003.04	Front Axle Left & Right Lower	SUV 4WD 112942		Control Arm Bushing	512766	



	 YEAR	FITTING POSITION	BODY STYLE & DRIVE TYPE & ENGINE	REMARKS	PRODUCT	GSP Ref.
MERCEDES-BENZ ML320						
3.2 (160 kw)						
	1998.02-2003.04	Front Axle Left & Right Upper	SUV 4WD 112942		Control Arm Bushing	510509
	1998.02-2003.04	Rear Axle Left & Right Upper Inner	SUV 4WD 112942		Control Arm Bushing	512252
	1998.02-2003.04	Rear Axle Left & Right Upper Outer	SUV 4WD 112942		Control Arm Bushing	510509
	1998.02-2003.04	Front Axle Left & Right Upper	SUV 4WD 112942		Control Arm Bushing Kit	510509S
	1998.02-2003.04	Rear Axle Left & Right Upper Outer	SUV 4WD 112942		Control Arm Bushing Kit	510509S
	1998.02-2003.04	Front Axle Left & Right	SUV 4WD 112942		Tie Rod Axle Joint	S030161
	1998.02-2003.04	Front Axle Left	SUV 4WD 112942		Tie Rod End	S070276
	1998.02-2003.04	Front Axle Right	SUV 4WD 112942		Tie Rod End	S070275
	1998.02-2003.04	Rear Axle Left & Right	SUV 4WD 112942		Rod/Strut, stabiliser	S050309
	1998.02-2003.04	Front Axle Left & Right	SUV 4WD 112942		Stabiliser Bushing	530744
	1998.02-2003.04	Front Axle	SUV 4WD 112942		Steering Boot	540206
	1998.02-2003.04	Front Axle	SUV 4WD 112942		Steering Rack Bellow Kit	540206S
	1998.02-2003.04	Front Axle	SUV 4WD 112942		Stabiliser Bushing Kit	512575S
	1998.02-2003.04	Front Axle	SUV 4WD 112942		Stabiliser Bushing Kit	516871S
	1998.02-2003.04	Rear Axle	SUV 4WD 112942		Stabiliser Bushing Kit	516869S
ML350						
3.0 (165 kw)						
	2009.06-2012.11	Front Axle Left Lower	SUV 4WD 642940		Track Control Arm	S061308
	2009.06-2012.11	Front Axle Left Upper	SUV 4WD 642940		Track Control Arm	S061306
	2009.06-2012.11	Front Axle Right Lower	SUV 4WD 642940		Track Control Arm	S061307
	2009.06-2012.11	Front Axle Right Upper	SUV 4WD 642940		Track Control Arm	S061305
	2009.06-2012.11	Rear Axle Left & Right Centre	SUV 4WD 642940		Track Control Arm	S063127
	2009.06-2012.11	Front Axle Left & Right Lower	SUV 4WD 642940		Ball Joint	S080138
	2009.06-2012.11	Rear Axle Left & Right Lower	SUV 4WD 642940		Ball Joint	S080674
	2009.06-2012.11	Front Axle Left & Right Lower	SUV 4WD 642940		Control Arm Bushing	517766
	2009.06-2012.11	Front Axle Left & Right Lower	SUV 4WD 642940		Control Arm Bushing	517775
	2009.06-2012.11	Front Axle Left & Right Lower	SUV 4WD 642940		Control Arm Bushing	517776
	2009.06-2012.11	Front Axle Left & Right Lower	SUV 4WD 642940		Control Arm Bushing	531937
	2009.06-2012.11	Front Axle Left & Right Upper	SUV 4WD 642940		Control Arm Bushing	517773
	2009.06-2012.11	Rear Axle Left & Right Upper	SUV 4WD 642940		Control Arm Bushing	532971
	2009.06-2012.11	Rear Axle Left & Right Lower Inner	SUV 4WD 642940		Control Arm Bushing	532478
	2009.06-2012.11	Front Axle Left & Right	SUV 4WD 642940		Tie Rod Axle Joint	S030170
	2009.06-2012.11	Front Axle Left	SUV 4WD 642940		Tie Rod End	S070303
	2009.06-2012.11	Front Axle Right	SUV 4WD 642940		Tie Rod End	S070304
	2009.06-2012.11	Front Axle Left & Right	SUV 4WD 642940		Rod/Strut, stabiliser	S050300
	2009.06-2012.11	Rear Axle Left & Right	SUV 4WD 642940		Rod/Strut, stabiliser	S050292
	2009.06-2012.11	Front Axle	SUV 4WD 642940		Stabiliser Bushing	530168
	2009.06-2012.11	Front Axle	SUV 4WD 642940		Steering Boot	540209
	2009.06-2012.11	Front Axle	SUV 4WD 642940		Steering Rack Bellow Kit	540209S
3.0 (190 kw)						
	2011.06-2015.02	Front Axle Left Lower	SUV 4WD 642826		Track Control Arm	S063166
	2011.06-2015.02	Front Axle Left Upper	SUV 4WD 642826		Track Control Arm	S063047
	2011.06-2015.02	Front Axle Right Lower	SUV 4WD 642826		Track Control Arm	S063156
	2011.06-2015.02	Front Axle Right Upper	SUV 4WD 642826		Track Control Arm	S063048
	2011.06-2015.02	Rear Axle Left & Right Centre	SUV 4WD 642826		Track Control Arm	S063127
	2011.06-2015.02	Front Axle Right Lower	SUV 4WD 642826		Control Arm Bushing	535169
	2011.06-2015.02	Front Axle Left & Right Lower	SUV 4WD 642826		Control Arm Bushing	517775
	2011.06-2015.02	Front Axle Left & Right Lower	SUV 4WD 642826		Control Arm Bushing	531449
	2011.06-2015.02	Front Axle Left & Right Upper	SUV 4WD 642826		Control Arm Bushing	517773
	2011.06-2015.02	Rear Axle Left & Right Lower	SUV 4WD 642826		Control Arm Bushing	532478
	2011.06-2015.02	Rear Axle Left & Right Upper	SUV 4WD 642826		Control Arm Bushing	532971
	2011.06-2015.02	Rear Axle Left & Right	SUV 4WD 642826		Rod/Strut, stabiliser	S050292
3.5 (200 kw)						
	2005.02-2011.12	Front Axle Left Lower	SUV 4WD 272967		Track Control Arm	S061308
	2005.02-2011.12	Front Axle Left Upper	SUV 4WD 272967		Track Control Arm	S061306
	2005.02-2011.12	Front Axle Right Lower	SUV 4WD 272967		Track Control Arm	S061307
	2005.02-2011.12	Front Axle Right Upper	SUV 4WD 272967		Track Control Arm	S061305
	2005.02-2011.12	Rear Axle Left & Right Centre	SUV 4WD 272967		Track Control Arm	S063127
	2005.02-2011.12	Front Axle Left & Right Lower	SUV 4WD 272967		Ball Joint	S080138
	2005.02-2011.12	Rear Axle Left & Right Lower	SUV 4WD 272967		Ball Joint	S080674
	2005.02-2011.12	Front Axle Left & Right Lower	SUV 4WD 272967		Control Arm Bushing	517766
	2005.02-2011.12	Front Axle Left & Right Lower	SUV 4WD 272967		Control Arm Bushing	517775
	2005.02-2011.12	Front Axle Left & Right Lower	SUV 4WD 272967		Control Arm Bushing	517776
	2005.02-2011.12	Front Axle Left & Right Lower	SUV 4WD 272967		Control Arm Bushing	531937
	2005.02-2011.12	Front Axle Left & Right Upper	SUV 4WD 272967		Control Arm Bushing	517773
	2005.02-2011.12	Rear Axle Left & Right Upper	SUV 4WD 272967		Control Arm Bushing	532971
	2005.02-2011.12	Rear Axle Left & Right Lower Inner	SUV 4WD 272967		Control Arm Bushing	532478



	 YEAR	FITTING POSITION	BODY STYLE & DRIVE TYPE & ENGINE	REMARKS	PRODUCT	GSP Ref.
MERCEDES-BENZ ML350						
3.5 (200 kw)	2005.02-2011.12	Front Axle Left & Right	SUV 4WD 272967		Tie Rod Axle Joint	S030170
	2005.02-2011.12	Front Axle Left	SUV 4WD 272967		Tie Rod End	S070303
	2005.02-2011.12	Front Axle Right	SUV 4WD 272967		Tie Rod End	S070304
	2005.02-2011.12	Front Axle Left & Right	SUV 4WD 272967		Rod/Strut, stabiliser	S050300
	2005.02-2011.12	Rear Axle Left & Right	SUV 4WD 272967		Rod/Strut, stabiliser	S050292
	2005.02-2011.12	Front Axle	SUV 4WD 272967		Stabiliser Bushing	530168
	2005.02-2011.12	Front Axle	SUV 4WD 272967		Steering Boot	540209
	2005.02-2011.12	Front Axle	SUV 4WD 272967		Steering Rack Bellow Kit	540209S
3.5 (225 kw)	2011.06-2015.02	Front Axle Left Lower	SUV 4WD 276955		Track Control Arm	S063166
	2011.06-2015.02	Front Axle Left Upper	SUV 4WD 276955		Track Control Arm	S063047
	2011.06-2015.02	Front Axle Right Lower	SUV 4WD 276955		Track Control Arm	S063156
	2011.06-2015.02	Front Axle Right Upper	SUV 4WD 276955		Track Control Arm	S063048
	2011.06-2015.02	Rear Axle Left & Right Centre	SUV 4WD 276955		Track Control Arm	S063127
	2011.06-2015.02	Rear Axle Left & Right Lower	SUV 4WD 276955		Ball Joint	S080674
	2011.06-2015.02	Front Axle Right Lower	SUV 4WD 276955		Control Arm Bushing	535169
	2011.06-2015.02	Front Axle Left & Right Lower	SUV 4WD 276955		Control Arm Bushing	517775
	2011.06-2015.02	Front Axle Left & Right Lower	SUV 4WD 276955		Control Arm Bushing	531449
	2011.06-2015.02	Front Axle Left & Right Upper	SUV 4WD 276955		Control Arm Bushing	517773
	2011.06-2015.02	Rear Axle Left & Right Lower	SUV 4WD 276955		Control Arm Bushing	532478
	2011.06-2015.02	Rear Axle Left & Right Upper	SUV 4WD 276955		Control Arm Bushing	532971
3.7 (173 kw)	2003.01-2005.12	Front Axle Left Lower	SUV 4WD 112970		Track Control Arm	S061302
	2003.01-2005.12	Front Axle Left Upper	SUV 4WD 112970		Track Control Arm	S060593
	2003.01-2005.12	Front Axle Right Lower	SUV 4WD 112970		Track Control Arm	S061303
	2003.01-2005.12	Front Axle Right Upper	SUV 4WD 112970		Track Control Arm	S060594
	2003.01-2005.12	Rear Axle Left Upper Inner	SUV 4WD 112970		Track Control Arm	S060269
	2003.01-2005.12	Rear Axle Left Upper Outer	SUV 4WD 112970		Track Control Arm	S060245
	2003.01-2005.12	Rear Axle Right Upper Inner	SUV 4WD 112970		Track Control Arm	S060270
	2003.01-2005.12	Rear Axle Right Upper Outer	SUV 4WD 112970		Track Control Arm	S060246
	2003.01-2005.12	Front Axle Left & Right Lower	SUV 4WD 112970		Ball Joint	S080130
	2003.01-2005.12	Rear Axle Left & Right Lower	SUV 4WD 112970		Ball Joint	S080131
	2003.01-2005.12	Front Axle Left & Right Lower	SUV 4WD 112970		Control Arm Bushing	512766
	2003.01-2005.12	Front Axle Left & Right Upper	SUV 4WD 112970		Control Arm Bushing	510509
	2003.01-2005.12	Rear Axle Left & Right Upper Inner	SUV 4WD 112970		Control Arm Bushing	512252
	2003.01-2005.12	Rear Axle Left & Right Upper Outer	SUV 4WD 112970		Control Arm Bushing	510509
	2003.01-2005.12	Front Axle Left & Right Upper	SUV 4WD 112970		Control Arm Bushing Kit	510509S
	2003.01-2005.12	Rear Axle Left & Right Upper Outer	SUV 4WD 112970		Control Arm Bushing Kit	510509S
	2003.01-2005.12	Front Axle Left & Right	SUV 4WD 112970		Tie Rod Axle Joint	S030161
	2003.01-2005.12	Front Axle Left	SUV 4WD 112970		Tie Rod End	S070276
	2003.01-2005.12	Front Axle Right	SUV 4WD 112970		Tie Rod End	S070275
	2003.01-2005.12	Rear Axle Left & Right	SUV 4WD 112970		Rod/Strut, stabiliser	S050309
2003.01-2005.12	Front Axle	SUV 4WD 112970		Steering Boot	540206	
2003.01-2005.12	Front Axle	SUV 4WD 112970		Steering Rack Bellow Kit	540206S	
2003.01-2005.12	Front Axle	SUV 4WD 112970		Stabiliser Bushing Kit	512575S	
2003.01-2005.12	Rear Axle	SUV 4WD 112970		Stabiliser Bushing Kit	516869S	
ML430						
4.3 (200 kw)	1998.11-2002.08	Front Axle Left Lower	SUV 4WD 113942		Track Control Arm	S061302
	1998.11-2002.08	Front Axle Left Upper	SUV 4WD 113942		Track Control Arm	S060593
	1998.11-2002.08	Front Axle Right Lower	SUV 4WD 113942		Track Control Arm	S061303
	1998.11-2002.08	Front Axle Right Upper	SUV 4WD 113942		Track Control Arm	S060594
	1998.11-2002.08	Rear Axle Left Upper Inner	SUV 4WD 113942		Track Control Arm	S060269
	1998.11-2002.08	Rear Axle Left Upper Outer	SUV 4WD 113942		Track Control Arm	S060245
	1998.11-2002.08	Rear Axle Right Upper Inner	SUV 4WD 113942		Track Control Arm	S060270
	1998.11-2002.08	Rear Axle Right Upper Outer	SUV 4WD 113942		Track Control Arm	S060246
	1998.11-2002.08	Front Axle Left & Right Lower	SUV 4WD 113942		Ball Joint	S080130
	1998.11-2002.08	Rear Axle Left & Right Lower	SUV 4WD 113942		Ball Joint	S080131
	1998.11-2002.08	Front Axle Left & Right Lower	SUV 4WD 113942		Control Arm Bushing	512766
	1998.11-2002.08	Front Axle Left & Right Upper	SUV 4WD 113942		Control Arm Bushing	510509
	1998.11-2002.08	Rear Axle Left & Right Upper Inner	SUV 4WD 113942		Control Arm Bushing	512252
	1998.11-2002.08	Rear Axle Left & Right Upper Outer	SUV 4WD 113942		Control Arm Bushing	510509
	1998.11-2002.08	Front Axle Left & Right Upper	SUV 4WD 113942		Control Arm Bushing Kit	510509S
	1998.11-2002.08	Rear Axle Left & Right Upper Outer	SUV 4WD 113942		Control Arm Bushing Kit	510509S
	1998.11-2002.08	Front Axle Left & Right	SUV 4WD 113942		Tie Rod Axle Joint	S030161
	1998.11-2002.08	Front Axle Left	SUV 4WD 113942		Tie Rod End	S070276



	 YEAR	FITTING POSITION	BODY STYLE & DRIVE TYPE & ENGINE	REMARKS	PRODUCT	GSP Ref.
MERCEDES-BENZ ML430						
4.3 (200 kw)	1998.11-2002.08	Front Axle Right	SUV 4WD 113942		Tie Rod End	S070275
	1998.11-2002.08	Rear Axle Left & Right	SUV 4WD 113942		Rod/Strut, stabiliser	S050309
	1998.11-2002.08	Front Axle	SUV 4WD 113942		Steering Boot	540206
	1998.11-2002.08	Front Axle	SUV 4WD 113942		Steering Rack Bellow Kit	540206S
	1998.11-2002.08	Front Axle	SUV 4WD 113942		Stabiliser Bushing Kit	512575S
	1998.11-2002.08	Front Axle	SUV 4WD 113942		Stabiliser Bushing Kit	516871S
	1998.11-2002.08	Rear Axle	SUV 4WD 113942		Stabiliser Bushing Kit	516869S
ML500						
5.0 (215 kw)	2001.09-2005.06	Front Axle Left Lower	SUV 4WD 113965		Track Control Arm	S061302
	2001.09-2005.06	Front Axle Left Upper	SUV 4WD 113965		Track Control Arm	S060593
	2001.09-2005.06	Front Axle Right Lower	SUV 4WD 113965		Track Control Arm	S061303
	2001.09-2005.06	Front Axle Right Upper	SUV 4WD 113965		Track Control Arm	S060594
	2001.09-2005.06	Rear Axle Left Upper Inner	SUV 4WD 113965		Track Control Arm	S060269
	2001.09-2005.06	Rear Axle Left Upper Outer	SUV 4WD 113965		Track Control Arm	S060245
	2001.09-2005.06	Rear Axle Right Upper Inner	SUV 4WD 113965		Track Control Arm	S060270
	2001.09-2005.06	Rear Axle Right Upper Outer	SUV 4WD 113965		Track Control Arm	S060246
	2001.09-2005.06	Front Axle Left & Right Lower	SUV 4WD 113965		Ball Joint	S080130
	2001.09-2005.06	Rear Axle Left & Right Lower	SUV 4WD 113965		Ball Joint	S080131
	2001.09-2005.06	Front Axle Left & Right Lower	SUV 4WD 113965		Control Arm Bushing	512766
	2001.09-2005.06	Front Axle Left & Right Upper	SUV 4WD 113965		Control Arm Bushing	510509
	2001.09-2005.06	Rear Axle Left & Right Upper Inner	SUV 4WD 113965		Control Arm Bushing	512252
	2001.09-2005.06	Rear Axle Left & Right Upper Outer	SUV 4WD 113965		Control Arm Bushing	510509
	2001.09-2005.06	Front Axle Left & Right Upper	SUV 4WD 113965		Control Arm Bushing Kit	510509S
	2001.09-2005.06	Rear Axle Left & Right Upper Outer	SUV 4WD 113965		Control Arm Bushing Kit	510509S
	2001.09-2005.06	Front Axle Left & Right	SUV 4WD 113965		Tie Rod Axle Joint	S030161
	2001.09-2005.06	Front Axle Left	SUV 4WD 113965		Tie Rod End	S070276
	2001.09-2005.06	Front Axle Right	SUV 4WD 113965		Tie Rod End	S070275
	2001.09-2005.06	Rear Axle Left & Right	SUV 4WD 113965		Rod/Strut, stabiliser	S050309
	2001.09-2005.06	Front Axle	SUV 4WD 113965		Steering Boot	540206
	2001.09-2005.06	Front Axle	SUV 4WD 113965		Steering Rack Bellow Kit	540206S
	2001.09-2005.06	Front Axle	SUV 4WD 113965		Stabiliser Bushing Kit	512575S
	2001.09-2005.06	Rear Axle	SUV 4WD 113965		Stabiliser Bushing Kit	516869S
	5.0 (225 kw)	2005.08-2007.12	Front Axle Left Lower	SUV 4WD 113964		Track Control Arm
2005.08-2007.12		Front Axle Left Upper	SUV 4WD 113964		Track Control Arm	S061306
2005.08-2007.12		Front Axle Right Lower	SUV 4WD 113964		Track Control Arm	S061307
2005.08-2007.12		Front Axle Right Upper	SUV 4WD 113964		Track Control Arm	S061305
2005.08-2007.12		Rear Axle Left & Right Centre	SUV 4WD 113964		Track Control Arm	S063127
2005.08-2007.12		Front Axle Left & Right Lower	SUV 4WD 113964		Ball Joint	S080138
2005.08-2007.12		Rear Axle Left & Right Lower	SUV 4WD 113964		Ball Joint	S080674
2005.08-2007.12		Front Axle Left & Right Lower	SUV 4WD 113964		Control Arm Bushing	517766
2005.08-2007.12		Front Axle Left & Right Lower	SUV 4WD 113964		Control Arm Bushing	517775
2005.08-2007.12		Front Axle Left & Right Lower	SUV 4WD 113964		Control Arm Bushing	517776
2005.08-2007.12		Front Axle Left & Right Lower	SUV 4WD 113964		Control Arm Bushing	531937
2005.08-2007.12		Front Axle Left & Right Upper	SUV 4WD 113964		Control Arm Bushing	517773
2005.08-2007.12		Rear Axle Left & Right Upper	SUV 4WD 113964		Control Arm Bushing	532971
2005.08-2007.12		Rear Axle Left & Right Lower Inner	SUV 4WD 113964		Control Arm Bushing	532478
2005.08-2007.12		Front Axle Left & Right	SUV 4WD 113964		Tie Rod Axle Joint	S030170
2005.08-2007.12		Front Axle Left	SUV 4WD 113964		Tie Rod End	S070303
2005.08-2007.12		Front Axle Right	SUV 4WD 113964		Tie Rod End	S070304
2005.08-2007.12		Front Axle Left & Right	SUV 4WD 113964		Rod/Strut, stabiliser	S050300
2005.08-2007.12		Rear Axle Left & Right	SUV 4WD 113964		Rod/Strut, stabiliser	S050292
2005.08-2007.12		Front Axle	SUV 4WD 113964		Stabiliser Bushing	530168
2005.08-2007.12		Front Axle	SUV 4WD 113964		Steering Boot	540209
2005.08-2007.12		Front Axle	SUV 4WD 113964		Steering Rack Bellow Kit	540209S
5.5 (285 kw)	2007.04-2012.06	Front Axle Left Lower	SUV 4WD 273963		Track Control Arm	S061308
	2007.04-2012.06	Front Axle Left Upper	SUV 4WD 273963		Track Control Arm	S061306
	2007.04-2012.06	Front Axle Right Lower	SUV 4WD 273963		Track Control Arm	S061307
	2007.04-2012.06	Front Axle Right Upper	SUV 4WD 273963		Track Control Arm	S061305
	2007.04-2012.06	Rear Axle Left & Right Centre	SUV 4WD 273963		Track Control Arm	S063127
	2007.04-2012.06	Front Axle Left & Right Lower	SUV 4WD 273963		Ball Joint	S080138
	2007.04-2012.06	Rear Axle Left & Right Lower	SUV 4WD 273963		Ball Joint	S080674
	2007.04-2012.06	Front Axle Left & Right Lower	SUV 4WD 273963		Control Arm Bushing	517766
	2007.04-2012.06	Front Axle Left & Right Lower	SUV 4WD 273963		Control Arm Bushing	517775
	2007.04-2012.06	Front Axle Left & Right Lower	SUV 4WD 273963		Control Arm Bushing	517776



	 YEAR	FITTING POSITION	BODY STYLE & DRIVE TYPE & ENGINE	REMARKS	PRODUCT	GSP Ref.	
MERCEDES-BENZ ML500							
5.5 (285 kw)	2007.04-2012.06	Front Axle Left & Right Lower	SUV 4WD 273963		Control Arm Bushing	531937	
	2007.04-2012.06	Front Axle Left & Right Upper	SUV 4WD 273963		Control Arm Bushing	517773	
	2007.04-2012.06	Rear Axle Left & Right Upper	SUV 4WD 273963		Control Arm Bushing	532971	
	2007.04-2012.06	Rear Axle Left & Right Lower Inner	SUV 4WD 273963		Control Arm Bushing	532478	
	2007.04-2012.06	Front Axle Left & Right	SUV 4WD 273963		Tie Rod Axle Joint	S030170	
	2007.04-2012.06	Front Axle Left	SUV 4WD 273963		Tie Rod End	S070303	
	2007.04-2012.06	Front Axle Right	SUV 4WD 273963		Tie Rod End	S070304	
	2007.04-2012.06	Front Axle Left & Right	SUV 4WD 273963		Rod/Strut, stabiliser	S050300	
	2007.04-2012.06	Rear Axle Left & Right	SUV 4WD 273963		Rod/Strut, stabiliser	S050292	
	2007.04-2012.06	Front Axle	SUV 4WD 273963		Stabiliser Bushing	530168	
	2007.04-2012.06	Front Axle	SUV 4WD 273963		Steering Boot	540209	
	2007.04-2012.06	Front Axle	SUV 4WD 273963		Steering Rack Bellow Kit	540209S	
ML55 AMG							
5.4 (255 kw)	1999.06-2005.07	Front Axle Left Lower	SUV 4WD 113981		Track Control Arm	S061302	
	1999.06-2005.07	Front Axle Left Upper	SUV 4WD 113981		Track Control Arm	S060593	
	1999.06-2005.07	Front Axle Right Lower	SUV 4WD 113981		Track Control Arm	S061303	
	1999.06-2005.07	Front Axle Right Upper	SUV 4WD 113981		Track Control Arm	S060594	
	1999.06-2005.07	Rear Axle Left Upper Inner	SUV 4WD 113981		Track Control Arm	S060269	
	1999.06-2005.07	Rear Axle Left Upper Outer	SUV 4WD 113981		Track Control Arm	S060245	
	1999.06-2005.07	Rear Axle Right Upper Inner	SUV 4WD 113981		Track Control Arm	S060270	
	1999.06-2005.07	Rear Axle Right Upper Outer	SUV 4WD 113981		Track Control Arm	S060246	
	1999.06-2005.07	Front Axle Left & Right Lower	SUV 4WD 113981		Ball Joint	S080130	
	1999.06-2005.07	Rear Axle Left & Right Lower	SUV 4WD 113981		Ball Joint	S080131	
	1999.06-2005.07	Front Axle Left & Right Lower	SUV 4WD 113981		Control Arm Bushing	512766	
	1999.06-2005.07	Front Axle Left & Right Upper	SUV 4WD 113981		Control Arm Bushing	510509	
	1999.06-2005.07	Rear Axle Left & Right Upper Inner	SUV 4WD 113981		Control Arm Bushing	512252	
	1999.06-2005.07	Rear Axle Left & Right Upper Outer	SUV 4WD 113981		Control Arm Bushing	510509	
	1999.06-2005.07	Front Axle Left & Right Upper	SUV 4WD 113981		Control Arm Bushing Kit	510509S	
	1999.06-2005.07	Rear Axle Left & Right Upper Outer	SUV 4WD 113981		Control Arm Bushing Kit	510509S	
	1999.06-2005.07	Front Axle Left & Right	SUV 4WD 113981		Tie Rod Axle Joint	S030161	
	1999.06-2005.07	Front Axle Left	SUV 4WD 113981		Tie Rod End	S070276	
	1999.06-2005.07	Front Axle Right	SUV 4WD 113981		Tie Rod End	S070275	
	1999.06-2005.07	Rear Axle Left & Right	SUV 4WD 113981		Rod/Strut, stabiliser	S050309	
	1999.06-2005.07	Front Axle	SUV 4WD 113981		Steering Boot	540206	
	1999.06-2005.07	Front Axle	SUV 4WD 113981		Steering Rack Bellow Kit	540206S	
	1999.06-2005.07	Front Axle	SUV 4WD 113981		Stabiliser Bushing Kit	512575S	
	1999.06-2005.07	Front Axle	SUV 4WD 113981		Stabiliser Bushing Kit	516871S	
	1999.06-2005.07	Rear Axle	SUV 4WD 113981		Stabiliser Bushing Kit	516869S	
	ML63 AMG						
	5.5 (386 kw)	2011.11-2015.02	Front Axle Left Lower	SUV 4WD 157982		Track Control Arm	S063166
		2011.11-2015.02	Front Axle Left Upper	SUV 4WD 157982		Track Control Arm	S063047
2011.11-2015.02		Front Axle Right Lower	SUV 4WD 157982		Track Control Arm	S063156	
2011.11-2015.02		Front Axle Right Upper	SUV 4WD 157982		Track Control Arm	S063048	
2011.11-2015.02		Rear Axle Left & Right Centre	SUV 4WD 157982		Track Control Arm	S063127	
2011.11-2015.02		Rear Axle Left & Right Lower	SUV 4WD 157982		Ball Joint	S080674	
2011.11-2015.02		Front Axle Right Lower	SUV 4WD 157982		Control Arm Bushing	535169	
2011.11-2015.02		Front Axle Left & Right Lower	SUV 4WD 157982		Control Arm Bushing	517775	
2011.11-2015.02		Front Axle Left & Right Lower	SUV 4WD 157982		Control Arm Bushing	531449	
2011.11-2015.02		Front Axle Left & Right Upper	SUV 4WD 157982		Control Arm Bushing	517773	
2011.11-2015.02		Rear Axle Left & Right Lower	SUV 4WD 157982		Control Arm Bushing	532478	
2011.11-2015.02		Rear Axle Left & Right Upper	SUV 4WD 157982		Control Arm Bushing	532971	
2011.11-2015.02		Rear Axle Left & Right	SUV 4WD 157982		Rod/Strut, stabiliser	S050292	
6.2 (375 kw)		2005.12-2011.12	Front Axle Left Upper	SUV 4WD 156980		Track Control Arm	S061306
	2005.12-2011.12	Front Axle Right Upper	SUV 4WD 156980		Track Control Arm	S061305	
	2005.12-2011.12	Rear Axle Left & Right Centre	SUV 4WD 156980		Track Control Arm	S063127	
	2005.12-2011.12	Front Axle Left & Right Lower	SUV 4WD 156980		Ball Joint	S080138	
	2005.12-2011.12	Rear Axle Left & Right Lower	SUV 4WD 156980		Ball Joint	S080674	
	2005.12-2011.12	Front Axle Left & Right Lower	SUV 4WD 156980		Control Arm Bushing	517775	
	2005.12-2011.12	Front Axle Left & Right Lower	SUV 4WD 156980		Control Arm Bushing	517776	
	2005.12-2011.12	Front Axle Left & Right Lower	SUV 4WD 156980	Date from:2008.03	Control Arm Bushing	531937	
	2005.12-2011.12	Front Axle Left & Right Upper	SUV 4WD 156980		Control Arm Bushing	517773	
	2005.12-2011.12	Rear Axle Left & Right Upper	SUV 4WD 156980		Control Arm Bushing	532971	
	2005.12-2011.12	Rear Axle Left & Right Lower Inner	SUV 4WD 156980		Control Arm Bushing	532478	
	2005.12-2011.12	Front Axle Left & Right	SUV 4WD 156980		Tie Rod Axle Joint	S030170	



	 YEAR	FITTING POSITION	BODY STYLE & DRIVE TYPE & ENGINE	REMARKS	PRODUCT	GSP Ref.
MERCEDES-BENZ ML63 AMG						
6.2 (375 kw)						
	2005.12-2011.12	Front Axle Left	SUV 4WD 156980		Tie Rod End	S070303
	2005.12-2011.12	Front Axle Right	SUV 4WD 156980		Tie Rod End	S070304
	2005.12-2011.12	Front Axle Left & Right	SUV 4WD 156980		Rod/Strut,stabiliser	S050300
	2005.12-2011.12	Rear Axle Left & Right	SUV 4WD 156980		Rod/Strut,stabiliser	S050292
	2005.12-2011.12	Front Axle	SUV 4WD 156980		Stabiliser Bushing	530168
	2005.12-2011.12	Front Axle	SUV 4WD 156980		Steering Boot	540209
	2005.12-2011.12	Front Axle	SUV 4WD 156980		Steering Rack Bellow Kit	540209S
R500						
5.0 (225 kw)						
	2005.08-2014.12	Front Axle Left Upper	MPV 4WD 113971		Track Control Arm	S061306
	2005.08-2014.12	Front Axle Right Upper	MPV 4WD 113971		Track Control Arm	S061305
	2005.08-2014.12	Rear Axle Left & Right Centre	MPV 4WD 113971		Track Control Arm	S063127
	2005.08-2014.12	Front Axle Left & Right Lower	MPV 4WD 113971		Ball Joint	S080138
	2005.08-2014.12	Rear Axle Left & Right Lower	MPV 4WD 113971		Ball Joint	S080674
	2005.08-2014.12	Front Axle Left & Right Lower	MPV 4WD 113971		Control Arm Bushing	516549
	2005.08-2014.12	Front Axle Left & Right Lower	MPV 4WD 113971		Control Arm Bushing	517775
	2005.08-2014.12	Front Axle Left & Right Lower	MPV 4WD 113971		Control Arm Bushing	517776
	2005.08-2014.12	Front Axle Left & Right Upper	MPV 4WD 113971		Control Arm Bushing	517773
	2005.08-2014.12	Rear Axle Left & Right Lower	MPV 4WD 113971		Control Arm Bushing	532478
	2005.08-2014.12	Rear Axle Left & Right Upper	MPV 4WD 113971		Control Arm Bushing	532971
	2005.08-2014.12	Front Axle Left & Right	MPV 4WD 113971		Tie Rod Axle Joint	S030170
	2005.08-2014.12	Front Axle Left	MPV 4WD 113971		Tie Rod End	S070588
	2005.08-2014.12	Front Axle Right	MPV 4WD 113971		Tie Rod End	S070589
	2005.08-2014.12	Front Axle Left & Right	MPV 4WD 113971		Rod/Strut,stabiliser	S050300
	2005.08-2014.12	Rear Axle Left & Right	MPV 4WD 113971		Rod/Strut,stabiliser	S050292
	2005.08-2014.12	Front Axle	MPV 4WD 113971		Steering Boot	540209
	2005.08-2014.12	Front Axle	MPV 4WD 113971		Steering Rack Bellow Kit	540209S
S280						
2.8 (142 kw)						
	1993.06-1999.01	Front Axle Left Upper	Saloon RWD 104944		Track Control Arm	S060267
	1993.06-1999.01	Front Axle Right Upper	Saloon RWD 104944		Track Control Arm	S060268
	1993.06-1999.01	Rear Axle Left & Right Lower Inner	Saloon RWD 104944		Track Control Arm	S060249
	1993.06-1999.01	Rear Axle Left & Right Upper Inner	Saloon RWD 104944		Track Control Arm	S060271
	1993.06-1999.01	Rear Axle Left & Right Upper Outer	Saloon RWD 104944		Track Control Arm	S060272
	1993.06-1999.01	Front Axle Left & Right Lower	Saloon RWD 104944		Ball Joint	S080142
	1993.06-1999.01	Front Axle Left & Right Lower	Saloon RWD 104944		Control Arm Bushing	510428
	1993.06-1999.01	Rear Axle Left & Right	Saloon RWD 104944		Control Arm Bushing	510500
	1993.06-1999.01	Rear Axle Left & Right Upper	Saloon RWD 104944		Control Arm Bushing	510495
	1993.06-1999.01	Rear Axle Left & Right Upper	Saloon RWD 104944		Control Arm Bushing	510499
	1993.06-1999.01	Rear Axle Left & Right Lower Outer	Saloon RWD 104944		Control Arm Bushing	510446
	1993.06-1999.01	Front Axle Left & Right Lower	Saloon RWD 104944		Control Arm Bushing Kit	510444S
	1993.06-1999.01	Front Axle Left & Right	Saloon RWD 104944		Rod Assembly	S100078
	1993.06-1999.01	Front Axle Left & Right	Saloon RWD 104944		Rod Assembly	S100191
	1993.06-1999.01	Front Axle Left & Right	Saloon RWD 104944		Tie Rod End	S070289
	1993.06-1999.01	Front Axle Left & Right	Saloon RWD 104944		Tie Rod End	S070290
	1993.06-1999.01	Front Axle Left	Saloon RWD 104944		Rod/Strut,stabiliser	S100076
	1993.06-1999.01	Front Axle Right	Saloon RWD 104944		Rod/Strut,stabiliser	S100077
	1993.06-1999.01	Rear Axle Left & Right	Saloon RWD 104944		Rod/Strut,stabiliser	S050281
	1993.06-1999.01	Front Axle	Saloon RWD 104944		Stabiliser Bushing	512765
S320						
3.2 (165 kw)						
	1999.02-2002.08	Front Axle Left Upper	Saloon RWD 112944		Track Control Arm	S060241
	1999.02-2002.08	Front Axle Left Lower Inner	Saloon RWD 112944		Track Control Arm	S060243
	1999.02-2002.08	Front Axle Left Lower Outer	Saloon RWD 112944		Track Control Arm	S060239
	1999.02-2002.08	Front Axle Right Upper	Saloon RWD 112944		Track Control Arm	S060242
	1999.02-2002.08	Front Axle Right Lower Inner	Saloon RWD 112944		Track Control Arm	S060244
	1999.02-2002.08	Front Axle Right Lower Outer	Saloon RWD 112944		Track Control Arm	S060240
	1999.02-2002.08	Front Axle Left & Right Lower Inner	Saloon RWD 112944		Track Control Arm	S062081
	1999.02-2002.08	Rear Axle Left & Right Lower Inner	Saloon RWD 112944		Track Control Arm	S060250
	1999.02-2002.08	Rear Axle Left & Right Upper Inner	Saloon RWD 112944		Track Control Arm	S060248
	1999.02-2002.08	Rear Axle Left & Right Upper Outer	Saloon RWD 112944		Track Control Arm	S060247
	1999.02-2002.08	Front Axle Left & Right Lower Inner	Saloon RWD 112944	for OE No.211 330 81 07	Ball Joint	S080134
	1999.02-2002.08	Front Axle Left & Right Lower Inner	Saloon RWD 112944		Ball Joint	S080136
	1999.02-2002.08	Front Axle Left & Right Upper	Saloon RWD 112944		Control Arm Bushing	510507
	1999.02-2002.08	Front Axle Left & Right Lower Inner	Saloon RWD 112944		Control Arm Bushing	510557
	1999.02-2002.08	Front Axle Left & Right Lower Outer	Saloon RWD 112944		Control Arm Bushing	510498
	1999.02-2002.08	Rear Axle Left & Right Upper	Saloon RWD 112944		Control Arm Bushing	510499



	 YEAR	FITTING POSITION	BODY STYLE & DRIVE TYPE & ENGINE	REMARKS	PRODUCT	GSP Ref.	
MERCEDES-BENZ S320							
3.2 (165 kw)	1999.02-2002.08	Front Axle Left & Right Lower Inner	Saloon RWD 112944		Control Arm Bushing Kit	510558S	
	1999.02-2002.08	Front Axle Left & Right	Saloon RWD 112944		Tie Rod Axle Joint	S030853	
	1999.02-2002.08	Front Axle Left & Right	Saloon RWD 112944		Tie Rod End	S070298	
	1999.02-2002.08	Front Axle Right	Saloon RWD 112944		Rod/Strut, stabiliser	517496	
	1999.02-2002.08	Rear Axle Left & Right	Saloon RWD 112944		Rod/Strut, stabiliser	S050281	
	1999.02-2002.08	Front Axle Left & Right	Saloon RWD 112944		Stabiliser Bushing	530744	
	1999.02-2002.08	Front Axle	Saloon RWD 112944		Steering Boot	540188	
	1999.02-2002.08	Front Axle	Saloon RWD 112944		Steering Rack Bellow Kit	540188S	
3.2 (170 kw)	1993.06-1998.10	Front Axle Left Upper	Saloon RWD 104990/104994		Track Control Arm	S060267	
	1993.06-1998.10	Front Axle Right Upper	Saloon RWD 104990/104994		Track Control Arm	S060268	
	1993.06-1998.10	Rear Axle Left & Right Lower Inner	Saloon RWD 104990/104994		Track Control Arm	S060249	
	1993.06-1998.10	Rear Axle Left & Right Upper Inner	Saloon RWD 104990/104994		Track Control Arm	S060271	
	1993.06-1998.10	Rear Axle Left & Right Upper Outer	Saloon RWD 104990/104994		Track Control Arm	S060272	
	1993.06-1998.10	Front Axle Left & Right Lower	Saloon RWD 104990/104994		Ball Joint	S080142	
	1993.06-1998.10	Front Axle Left & Right Lower	Saloon RWD 104990/104994		Control Arm Bushing	510428	
	1993.06-1998.10	Front Axle Left & Right Lower	Saloon RWD 104990/104994		Control Arm Bushing	510445	
	1993.06-1998.10	Rear Axle Left & Right	Saloon RWD 104990/104994		Control Arm Bushing	510500	
	1993.06-1998.10	Rear Axle Left & Right Upper	Saloon RWD 104990/104994		Control Arm Bushing	510495	
	1993.06-1998.10	Rear Axle Left & Right Upper	Saloon RWD 104990/104994		Control Arm Bushing	510499	
	1993.06-1998.10	Rear Axle Left & Right Lower Outer	Saloon RWD 104990/104994		Control Arm Bushing	510446	
	1993.06-1998.10	Front Axle Left & Right Lower	Saloon RWD 104990/104994		Control Arm Bushing Kit	510444S	
	1993.06-1998.10	Front Axle Left & Right	Saloon RWD 104990/104994		Rod Assembly	S100078	
	1993.06-1998.10	Front Axle Left & Right	Saloon RWD 104990/104994		Rod Assembly	S100191	
	1993.06-1998.10	Front Axle Left & Right	Saloon RWD 104990/104994		Tie Rod End	S070289	
	1993.06-1998.10	Front Axle Left & Right	Saloon RWD 104990/104994		Tie Rod End	S070290	
	1993.06-1998.10	Front Axle Left	Saloon RWD 104990/104994		Rod/Strut, stabiliser	S100076	
	1993.06-1998.10	Front Axle Right	Saloon RWD 104990/104994		Rod/Strut, stabiliser	S100077	
	1993.06-1998.10	Rear Axle Left & Right	Saloon RWD 104990/104994		Rod/Strut, stabiliser	S050281	
1993.06-1998.10	Front Axle	Saloon RWD 104990/104994		Stabiliser Bushing	510472		
1993.06-1998.10	Front Axle	Saloon RWD 104990/104994		Stabiliser Bushing	512765		
S350							
3.5 (200 kw)	2005.09-2013.07	Front Axle Left Upper	Saloon RWD 272965		Track Control Arm	S061294	
	2005.09-2013.07	Front Axle Left Lower Inner	Saloon RWD 272965	For Vehicles Without Abs	Track Control Arm	S060251	
	2005.09-2013.07	Front Axle Left Lower Inner	Saloon RWD 272965		Track Control Arm	S061309	
	2005.09-2013.07	Front Axle Left Lower Outer	Saloon RWD 272965		Track Control Arm	S060253	
	2005.09-2013.07	Front Axle Right Upper	Saloon RWD 272965		Track Control Arm	S061295	
	2005.09-2013.07	Front Axle Right Lower Inner	Saloon RWD 272965	For Vehicles Without Abs	Track Control Arm	S060252	
	2005.09-2013.07	Front Axle Right Lower Inner	Saloon RWD 272965		Track Control Arm	S061310	
	2005.09-2013.07	Front Axle Right Lower Outer	Saloon RWD 272965		Track Control Arm	S060254	
	2005.09-2013.07	Rear Axle Left Lower Inner	Saloon RWD 272965		Track Control Arm	S060260	
	2005.09-2013.07	Rear Axle Left Lower Outer	Saloon RWD 272965		Track Control Arm	S060258	
	2005.09-2013.07	Rear Axle Right Lower Inner	Saloon RWD 272965		Track Control Arm	S060261	
	2005.09-2013.07	Rear Axle Right Lower Outer	Saloon RWD 272965		Track Control Arm	S060259	
	2005.09-2013.07	Front Axle Left & Right Upper	Saloon RWD 272965		Control Arm Bushing	510502	
	2005.09-2013.07	Front Axle Left & Right Lower Outer	Saloon RWD 272965		Control Arm Bushing	510508	
	2005.09-2013.07	Front Axle Left & Right Lower Outer	Saloon RWD 272965		Control Arm Bushing	531450	
	2005.09-2013.07	Rear Axle Left & Right Lower Inner	Saloon RWD 272965		Control Arm Bushing	510496	
	2005.09-2013.07	Rear Axle Left & Right Lower Inner	Saloon RWD 272965		Control Arm Bushing	510497	
	2005.09-2013.07	Rear Axle Left & Right Lower Outer	Saloon RWD 272965		Control Arm Bushing	510493	
	2005.09-2013.07	Rear Axle Left & Right Upper Outer	Saloon RWD 272965		Control Arm Bushing	510505	
	2005.09-2013.07	Rear Axle Left & Right Upper Outer	Saloon RWD 272965		Control Arm Bushing	510506	
	2005.09-2013.07	Front Axle Left & Right	Saloon RWD 272965		Tie Rod End	S070302	
	2005.09-2013.07	Front Axle Left	Saloon RWD 272965		Rod/Strut, stabiliser	S050293	
	2005.09-2013.07	Front Axle Right	Saloon RWD 272965		Rod/Strut, stabiliser	S050294	
	2005.09-2013.07	Rear Axle Left	Saloon RWD 272965		Rod/Strut, stabiliser	S050298	
	2005.09-2013.07	Rear Axle Right	Saloon RWD 272965		Rod/Strut, stabiliser	S050299	
	S400						
	3.5 (205 kw)	2008.11-2013.12	Front Axle Left Upper	Saloon RWD 272974		Track Control Arm	S061294
2008.11-2013.12		Front Axle Left Lower Inner	Saloon RWD 272974		Track Control Arm	S060251	
2008.11-2013.12		Front Axle Left Lower Outer	Saloon RWD 272974		Track Control Arm	S060253	
2008.11-2013.12		Front Axle Right Upper	Saloon RWD 272974		Track Control Arm	S061295	
2008.11-2013.12		Front Axle Right Lower Inner	Saloon RWD 272974		Track Control Arm	S060252	
2008.11-2013.12		Front Axle Right Lower Outer	Saloon RWD 272974		Track Control Arm	S060254	
2008.11-2013.12		Rear Axle Left Lower Inner	Saloon RWD 272974		Track Control Arm	S060260	



	 YEAR	FITTING POSITION	BODY STYLE & DRIVE TYPE & ENGINE	REMARKS	PRODUCT	GSP Ref.
MERCEDES-BENZ S400						
3.5 (205 kw)	2008.11-2013.12	Rear Axle Left Lower Outer	Saloon RWD 272974		Track Control Arm	S060258
	2008.11-2013.12	Rear Axle Right Lower Inner	Saloon RWD 272974		Track Control Arm	S060261
	2008.11-2013.12	Rear Axle Right Lower Outer	Saloon RWD 272974		Track Control Arm	S060259
	2008.11-2013.12	Front Axle Left & Right Upper	Saloon RWD 272974		Control Arm Bushing	510502
	2008.11-2013.12	Front Axle Left & Right Lower Outer	Saloon RWD 272974		Control Arm Bushing	510508
	2008.11-2013.12	Front Axle Left & Right Lower Outer	Saloon RWD 272974	From Chassis:461633	Control Arm Bushing	531450
	2008.11-2013.12	Rear Axle Left & Right Lower Inner	Saloon RWD 272974		Control Arm Bushing	510496
	2008.11-2013.12	Rear Axle Left & Right Lower Inner	Saloon RWD 272974		Control Arm Bushing	510497
	2008.11-2013.12	Rear Axle Left & Right Lower Outer	Saloon RWD 272974		Control Arm Bushing	510493
	2008.11-2013.12	Rear Axle Left & Right Upper Outer	Saloon RWD 272974		Control Arm Bushing	510505
	2008.11-2013.12	Rear Axle Left & Right Upper Outer	Saloon RWD 272974		Control Arm Bushing	510506
	2008.11-2013.12	Front Axle Left & Right	Saloon RWD 272974		Tie Rod End	S070302
	2008.11-2013.12	Front Axle Left & Right	Saloon RWD 272974		Tie Rod End	S070866
	2008.11-2013.12	Front Axle Left	Saloon RWD 272974		Rod/Strut, stabiliser	S050293
	2008.11-2013.12	Front Axle Right	Saloon RWD 272974		Rod/Strut, stabiliser	S050294
	2008.11-2013.12	Rear Axle Left	Saloon RWD 272974		Rod/Strut, stabiliser	S050298
	2008.11-2013.12	Rear Axle Right	Saloon RWD 272974		Rod/Strut, stabiliser	S050299
S500						
4.7 (335 kw)	2013.05-2017.05	Front Axle Left Upper	Saloon RWD 278929		Track Control Arm	S063167
	2013.05-2017.05	Front Axle Left Lower Inner	Saloon RWD 278929		Track Control Arm	S062740
	2013.05-2017.05	Front Axle Left Lower Outer	Saloon RWD 278929		Track Control Arm	S062738
	2013.05-2017.05	Front Axle Right Upper	Saloon RWD 278929		Track Control Arm	S063168
	2013.05-2017.05	Front Axle Right Lower Inner	Saloon RWD 278929		Track Control Arm	S062741
	2013.05-2017.05	Front Axle Right Lower Outer	Saloon RWD 278929		Track Control Arm	S062739
	2013.05-2017.05	Front Axle Left & Right Lower Inner	Saloon RWD 278929		Control Arm Bushing	533482
5.0 (225 kw)	1998.10-2005.08	Front Axle Left Upper	Saloon RWD 113960		Track Control Arm	S060241
	1998.10-2005.08	Front Axle Left Lower Inner	Saloon RWD 113960		Track Control Arm	S060243
	1998.10-2005.08	Front Axle Left Lower Outer	Saloon RWD 113960		Track Control Arm	S060239
	1998.10-2005.08	Front Axle Right Upper	Saloon RWD 113960		Track Control Arm	S060242
	1998.10-2005.08	Front Axle Right Lower Inner	Saloon RWD 113960		Track Control Arm	S060244
	1998.10-2005.08	Front Axle Right Lower Outer	Saloon RWD 113960		Track Control Arm	S060240
	1998.10-2005.08	Front Axle Left & Right Lower Inner	Saloon RWD 113960		Track Control Arm	S062081
	1998.10-2005.08	Rear Axle Left & Right Lower Inner	Saloon RWD 113960		Track Control Arm	S060250
	1998.10-2005.08	Rear Axle Left & Right Upper Inner	Saloon RWD 113960		Track Control Arm	S060248
	1998.10-2005.08	Rear Axle Left & Right Upper Outer	Saloon RWD 113960		Track Control Arm	S060247
	1998.10-2005.08	Front Axle Left & Right Lower Inner	Saloon RWD 113960	for OE No.211 330 81 07	Ball Joint	S080134
	1998.10-2005.08	Front Axle Left & Right Lower Inner	Saloon RWD 113960		Ball Joint	S080136
	1998.10-2005.08	Front Axle Left & Right Upper	Saloon RWD 113960		Control Arm Bushing	510507
	1998.10-2005.08	Front Axle Left & Right Lower Inner	Saloon RWD 113960		Control Arm Bushing	510557
	1998.10-2005.08	Front Axle Left & Right Lower Outer	Saloon RWD 113960		Control Arm Bushing	510498
	1998.10-2005.08	Rear Axle Left & Right Upper	Saloon RWD 113960		Control Arm Bushing	510499
	1998.10-2005.08	Front Axle Left & Right Lower Inner	Saloon RWD 113960		Control Arm Bushing Kit	510558S
	1998.10-2005.08	Front Axle Left & Right	Saloon RWD 113960		Tie Rod Axle Joint	S030853
	1998.10-2005.08	Front Axle Left & Right	Saloon RWD 113960		Tie Rod End	S070298
	1998.10-2005.08	Front Axle Right	Saloon RWD 113960		Rod/Strut, stabiliser	517496
	1998.10-2005.08	Rear Axle Left & Right	Saloon RWD 113960		Rod/Strut, stabiliser	S050281
	1998.10-2005.08	Front Axle	Saloon RWD 113960		Steering Boot	540188
	1998.10-2005.08	Front Axle	Saloon RWD 113960		Steering Rack Bellow Kit	540188S
5.0 (235 kw)	1993.01-1997.12	Front Axle Left Upper	Saloon RWD 119980		Track Control Arm	S060267
	1993.01-1997.12	Front Axle Right Upper	Saloon RWD 119980		Track Control Arm	S060268
	1993.01-1997.12	Rear Axle Left & Right Lower Inner	Saloon RWD 119980		Track Control Arm	S060249
	1993.01-1997.12	Rear Axle Left & Right Upper Inner	Saloon RWD 119980		Track Control Arm	S060271
	1993.01-1997.12	Rear Axle Left & Right Upper Outer	Saloon RWD 119980		Track Control Arm	S060272
	1993.01-1997.12	Front Axle Left & Right Lower	Saloon RWD 119980		Ball Joint	S080142
	1993.01-1997.12	Front Axle Left & Right Lower	Saloon RWD 119980		Control Arm Bushing	510428
	1993.01-1997.12	Front Axle Left & Right Lower	Saloon RWD 119980		Control Arm Bushing	510445
	1993.01-1997.12	Rear Axle Left & Right	Saloon RWD 119980		Control Arm Bushing	510500
	1993.01-1997.12	Rear Axle Left & Right Upper	Saloon RWD 119980		Control Arm Bushing	510495
	1993.01-1997.12	Rear Axle Left & Right Upper	Saloon RWD 119980		Control Arm Bushing	510499
	1993.01-1997.12	Rear Axle Left & Right Lower Outer	Saloon RWD 119980		Control Arm Bushing	510446
	1993.01-1997.12	Front Axle Left & Right Lower	Saloon RWD 119980		Control Arm Bushing Kit	510444S
	1993.01-1997.12	Front Axle Left & Right	Saloon RWD 119980		Rod Assembly	S100078
	1993.01-1997.12	Front Axle Left & Right	Saloon RWD 119980		Rod Assembly	S100191
	1993.01-1997.12	Front Axle Left & Right	Saloon RWD 119980		Tie Rod End	S070289



	 YEAR	FITTING POSITION	BODY STYLE & DRIVE TYPE & ENGINE	REMARKS	PRODUCT	GSP Ref.	
MERCEDES-BENZ S500							
5.0 (235 kw)	1993.01-1997.12	Front Axle Left & Right	Saloon RWD 119980		Tie Rod End	S070290	
	1993.01-1997.12	Front Axle Left	Saloon RWD 119980		Rod/Strut,stabiliser	S100076	
	1993.01-1997.12	Front Axle Right	Saloon RWD 119980		Rod/Strut,stabiliser	S100077	
	1993.01-1997.12	Rear Axle Left & Right	Saloon RWD 119980		Rod/Strut,stabiliser	S050281	
	1993.01-1997.12	Front Axle	Saloon RWD 119980		Stabiliser Bushing	510472	
	1993.01-1997.12	Front Axle	Saloon RWD 119980		Stabiliser Bushing	512765	
5.0 (240 kw)	1991.06-1998.10	Front Axle Left Upper	Saloon RWD 119970		Track Control Arm	S060267	
	1991.06-1998.10	Front Axle Right Upper	Saloon RWD 119970		Track Control Arm	S060268	
	1991.06-1998.10	Rear Axle Left & Right Lower Inner	Saloon RWD 119970		Track Control Arm	S060249	
	1991.06-1998.10	Rear Axle Left & Right Upper Inner	Saloon RWD 119970		Track Control Arm	S060271	
	1991.06-1998.10	Rear Axle Left & Right Upper Outer	Saloon RWD 119970		Track Control Arm	S060272	
	1991.06-1998.10	Front Axle Left & Right Lower	Saloon RWD 119970		Ball Joint	S080142	
	1991.06-1998.10	Front Axle Left & Right Lower	Saloon RWD 119970		Control Arm Bushing	510428	
	1991.06-1998.10	Rear Axle Left & Right	Saloon RWD 119970		Control Arm Bushing	510500	
	1991.06-1998.10	Rear Axle Left & Right Upper	Saloon RWD 119970		Control Arm Bushing	510495	
	1991.06-1998.10	Rear Axle Left & Right Upper	Saloon RWD 119970		Control Arm Bushing	510499	
	1991.06-1998.10	Rear Axle Left & Right Lower Outer	Saloon RWD 119970		Control Arm Bushing	510446	
	1991.06-1998.10	Front Axle Left & Right Lower	Saloon RWD 119970		Control Arm Bushing Kit	510444S	
	1991.06-1998.10	Front Axle Left & Right	Saloon RWD 119970		Rod Assembly	S100078	
	1991.06-1998.10	Front Axle Left & Right	Saloon RWD 119970		Rod Assembly	S100191	
	1991.06-1998.10	Front Axle Left & Right	Saloon RWD 119970		Tie Rod End	S070289	
	1991.06-1998.10	Front Axle Left & Right	Saloon RWD 119970		Tie Rod End	S070290	
	1991.06-1998.10	Front Axle Left	Saloon RWD 119970		Rod/Strut,stabiliser	S100076	
	1991.06-1998.10	Front Axle Right	Saloon RWD 119970		Rod/Strut,stabiliser	S100077	
	1991.06-1998.10	Rear Axle Left & Right	Saloon RWD 119970		Rod/Strut,stabiliser	S050281	
	1991.06-1998.10	Front Axle	Saloon RWD 119970		Stabiliser Bushing	510472	
1991.06-1998.10	Front Axle	Saloon RWD 119970		Stabiliser Bushing	512765		
5.5 (285 kw)	2005.09-2013.07	Front Axle Left Upper	Saloon RWD 273961		Track Control Arm	S061294	
	2005.09-2013.07	Front Axle Left Lower Inner	Saloon RWD 273961	For Vehicles Without Abc	Track Control Arm	S060251	
	2005.09-2013.07	Front Axle Left Lower Inner	Saloon RWD 273961		Track Control Arm	S061309	
	2005.09-2013.07	Front Axle Left Lower Outer	Saloon RWD 273961		Track Control Arm	S060253	
	2005.09-2013.07	Front Axle Right Upper	Saloon RWD 273961		Track Control Arm	S061295	
	2005.09-2013.07	Front Axle Right Lower Inner	Saloon RWD 273961	For Vehicles Without Abc	Track Control Arm	S060252	
	2005.09-2013.07	Front Axle Right Lower Inner	Saloon RWD 273961		Track Control Arm	S061310	
	2005.09-2013.07	Front Axle Right Lower Outer	Saloon RWD 273961		Track Control Arm	S060254	
	2005.09-2013.07	Rear Axle Left Lower Inner	Saloon RWD 273961		Track Control Arm	S060260	
	2005.09-2013.07	Rear Axle Left Lower Outer	Saloon RWD 273961		Track Control Arm	S060258	
	2005.09-2013.07	Rear Axle Right Lower Inner	Saloon RWD 273961		Track Control Arm	S060261	
	2005.09-2013.07	Rear Axle Right Lower Outer	Saloon RWD 273961		Track Control Arm	S060259	
	2005.09-2013.07	Front Axle Left & Right Upper	Saloon RWD 273961		Control Arm Bushing	510502	
	2005.09-2013.07	Front Axle Left & Right Lower Outer	Saloon RWD 273961		Control Arm Bushing	510508	
	2005.09-2013.07	Front Axle Left & Right Lower Outer	Saloon RWD 273961	From Chassis:461633	Control Arm Bushing	531450	
	2005.09-2013.07	Rear Axle Left & Right Lower Inner	Saloon RWD 273961		Control Arm Bushing	510496	
	2005.09-2013.07	Rear Axle Left & Right Lower Inner	Saloon RWD 273961		Control Arm Bushing	510497	
	2005.09-2013.07	Rear Axle Left & Right Lower Outer	Saloon RWD 273961		Control Arm Bushing	510493	
	2005.09-2013.07	Rear Axle Left & Right Upper Outer	Saloon RWD 273961		Control Arm Bushing	510505	
	2005.09-2013.07	Rear Axle Left & Right Upper Outer	Saloon RWD 273961		Control Arm Bushing	510506	
	2005.09-2013.07	Front Axle Left & Right	Saloon RWD 273961		Tie Rod End	S070302	
	2005.09-2013.07	Front Axle Left	Saloon RWD 273961		Rod/Strut,stabiliser	S050293	
	2005.09-2013.07	Front Axle Right	Saloon RWD 273961		Rod/Strut,stabiliser	S050294	
	2005.09-2013.07	Rear Axle Left	Saloon RWD 273961		Rod/Strut,stabiliser	S050298	
	2005.09-2013.07	Rear Axle Right	Saloon RWD 273961		Rod/Strut,stabiliser	S050299	
	S500 Maybach						
	4.7 (335 kw)	2014.12-	Front Axle Left Upper	Saloon RWD 278929		Track Control Arm	S063167
		2014.12-	Front Axle Left Lower Inner	Saloon RWD 278929		Track Control Arm	S062740
2014.12-		Front Axle Left Lower Outer	Saloon RWD 278929		Track Control Arm	S062738	
2014.12-		Front Axle Right Upper	Saloon RWD 278929		Track Control Arm	S063168	
2014.12-		Front Axle Right Lower Inner	Saloon RWD 278929		Track Control Arm	S062741	
2014.12-		Front Axle Right Lower Outer	Saloon RWD 278929		Track Control Arm	S062739	
2014.12-		Rear Axle Left Lower Outer	Saloon RWD 278929		Track Control Arm	S060258	
2014.12-		Rear Axle Right Lower Outer	Saloon RWD 278929		Track Control Arm	S060259	
2014.12-		Front Axle Left & Right Lower Inner	Saloon RWD 278929		Control Arm Bushing	533482	



	 YEAR	FITTING POSITION	BODY STYLE & DRIVE TYPE & ENGINE	REMARKS	PRODUCT	GSP Ref.
MERCEDES-BENZ						
S55 AMG						
5.4 (368 kw)	2002.09-2005.08	Front Axle Left Upper	Saloon RWD 113991		Track Control Arm	S060241
	2002.09-2005.08	Front Axle Left Lower Inner	Saloon RWD 113991		Track Control Arm	S060243
	2002.09-2005.08	Front Axle Left Lower Outer	Saloon RWD 113991		Track Control Arm	S060239
	2002.09-2005.08	Front Axle Right Upper	Saloon RWD 113991		Track Control Arm	S060242
	2002.09-2005.08	Front Axle Right Lower Inner	Saloon RWD 113991		Track Control Arm	S060244
	2002.09-2005.08	Front Axle Right Lower Outer	Saloon RWD 113991		Track Control Arm	S060240
	2002.09-2005.08	Front Axle Left & Right Lower Inner	Saloon RWD 113991		Track Control Arm	S062081
	2002.09-2005.08	Rear Axle Left & Right Upper Inner	Saloon RWD 113991		Track Control Arm	S060248
	2002.09-2005.08	Rear Axle Left & Right Upper Outer	Saloon RWD 113991		Track Control Arm	S060247
	2002.09-2005.08	Front Axle Left & Right Lower Inner	Saloon RWD 113991		Ball Joint	S080134
	2002.09-2005.08	Front Axle Left & Right Lower Inner	Saloon RWD 113991		Ball Joint	S080136
	2002.09-2005.08	Front Axle Left & Right Upper	Saloon RWD 113991		Control Arm Bushing	510507
	2002.09-2005.08	Front Axle Left & Right Lower Inner	Saloon RWD 113991		Control Arm Bushing	510557
	2002.09-2005.08	Front Axle Left & Right Lower Outer	Saloon RWD 113991		Control Arm Bushing	510498
	2002.09-2005.08	Rear Axle Left & Right Upper	Saloon RWD 113991		Control Arm Bushing	510499
	2002.09-2005.08	Front Axle Left & Right Lower Inner	Saloon RWD 113991		Control Arm Bushing Kit	510558S
	2002.09-2005.08	Front Axle Left & Right	Saloon RWD 113991		Tie Rod Axle Joint	S030853
	2002.09-2005.08	Front Axle Left & Right	Saloon RWD 113991		Tie Rod End	S070298
	2002.09-2005.08	Front Axle Right	Saloon RWD 113991		Rod/Strut, stabiliser	517496
	2002.09-2005.08	Rear Axle Left & Right	Saloon RWD 113991		Rod/Strut, stabiliser	S050281
	2002.09-2005.08	Front Axle	Saloon RWD 113991		Steering Rack Bellow Kit	540188S
S560						
4.0 (345 kw)	2017.07-	Front Axle Left Upper	Saloon RWD 176980		Track Control Arm	S063167
	2017.07-	Front Axle Left Lower Inner	Saloon RWD 176980		Track Control Arm	S062740
	2017.07-	Front Axle Left Lower Outer	Saloon RWD 176980		Track Control Arm	S062738
	2017.07-	Front Axle Right Upper	Saloon RWD 176980		Track Control Arm	S063168
	2017.07-	Front Axle Right Lower Inner	Saloon RWD 176980		Track Control Arm	S062741
	2017.07-	Front Axle Right Lower Outer	Saloon RWD 176980		Track Control Arm	S062739
	2017.07-	Front Axle Left & Right Lower Inner	Saloon RWD 176980		Control Arm Bushing	533482
S600						
5.5 (380 kw)	2005.09-2013.12	Front Axle Left Upper	Saloon RWD 275953		Track Control Arm	S061294
	2005.09-2013.12	Front Axle Left Lower Inner	Saloon RWD 275953	For Vehicles Without Abs	Track Control Arm	S060251
	2005.09-2013.12	Front Axle Left Lower Inner	Saloon RWD 275953	<small>Check to SA 057586 for fitment vehicles For vehicles ABS. Not to SA 05807</small>	Track Control Arm	S061309
	2005.09-2013.12	Front Axle Left Lower Outer	Saloon RWD 275953		Track Control Arm	S060253
	2005.09-2013.12	Front Axle Right Upper	Saloon RWD 275953		Track Control Arm	S061295
	2005.09-2013.12	Front Axle Right Lower Inner	Saloon RWD 275953	For Vehicles Without Abs	Track Control Arm	S060252
	2005.09-2013.12	Front Axle Right Lower Inner	Saloon RWD 275953	<small>Check to SA 057586 for fitment vehicles For vehicles ABS. Not to SA 05807</small>	Track Control Arm	S061310
	2005.09-2013.12	Front Axle Right Lower Outer	Saloon RWD 275953		Track Control Arm	S060254
	2005.09-2013.12	Rear Axle Left Lower Inner	Saloon RWD 275953		Track Control Arm	S060260
	2005.09-2013.12	Rear Axle Left Lower Outer	Saloon RWD 275953		Track Control Arm	S060258
	2005.09-2013.12	Rear Axle Right Lower Inner	Saloon RWD 275953		Track Control Arm	S060261
	2005.09-2013.12	Rear Axle Right Lower Outer	Saloon RWD 275953		Track Control Arm	S060259
	2005.09-2013.12	Front Axle Left & Right Upper	Saloon RWD 275953		Control Arm Bushing	510502
	2005.09-2013.12	Front Axle Left & Right Lower Outer	Saloon RWD 275953		Control Arm Bushing	510508
	2005.09-2013.12	Front Axle Left & Right Lower Outer	Saloon RWD 275953	From Chassis:461633	Control Arm Bushing	531450
	2005.09-2013.12	Rear Axle Left & Right Lower Inner	Saloon RWD 275953		Control Arm Bushing	510496
	2005.09-2013.12	Rear Axle Left & Right Lower Inner	Saloon RWD 275953		Control Arm Bushing	510497
	2005.09-2013.12	Rear Axle Left & Right Upper Outer	Saloon RWD 275953		Control Arm Bushing	510506
	2005.09-2013.12	Front Axle Left & Right	Saloon RWD 275953		Tie Rod End	S070302
	2005.09-2013.12	Front Axle Left	Saloon RWD 275953		Rod/Strut, stabiliser	S050293
	2005.09-2013.12	Front Axle Right	Saloon RWD 275953		Rod/Strut, stabiliser	S050294
	2005.09-2013.12	Rear Axle Left	Saloon RWD 275953		Rod/Strut, stabiliser	S050298
	2005.09-2013.12	Rear Axle Right	Saloon RWD 275953		Rod/Strut, stabiliser	S050299
5.8 (270 kw)	1999.09-2002.08	Front Axle Left Upper	Saloon RWD 137970		Track Control Arm	S060241
	1999.09-2002.08	Front Axle Left Lower Inner	Saloon RWD 137970		Track Control Arm	S060243
	1999.09-2002.08	Front Axle Left Lower Outer	Saloon RWD 137970		Track Control Arm	S060239
	1999.09-2002.08	Front Axle Right Upper	Saloon RWD 137970		Track Control Arm	S060242
	1999.09-2002.08	Front Axle Right Lower Inner	Saloon RWD 137970		Track Control Arm	S060244
	1999.09-2002.08	Front Axle Right Lower Outer	Saloon RWD 137970		Track Control Arm	S060240
	1999.09-2002.08	Front Axle Left & Right Lower Inner	Saloon RWD 137970		Track Control Arm	S062081
	1999.09-2002.08	Rear Axle Left & Right Lower Inner	Saloon RWD 137970		Track Control Arm	S060250
	1999.09-2002.08	Rear Axle Left & Right Upper Inner	Saloon RWD 137970		Track Control Arm	S060248
	1999.09-2002.08	Rear Axle Left & Right Upper Outer	Saloon RWD 137970		Track Control Arm	S060247
	1999.09-2002.08	Front Axle Left & Right Lower Inner	Saloon RWD 137970	for OE No.211 330 81 07	Ball Joint	S080134



	 YEAR	FITTING POSITION	BODY STYLE & DRIVE TYPE & ENGINE	REMARKS	PRODUCT	GSP Ref.
MERCEDES-BENZ S600						
5.8 (270 kw)						
	1999.09-2002.08	Front Axle Left & Right Lower Inner	Saloon RWD 137970		Ball Joint	S080136
	1999.09-2002.08	Front Axle Left & Right Upper	Saloon RWD 137970		Control Arm Bushing	510507
	1999.09-2002.08	Front Axle Left & Right Lower Inner	Saloon RWD 137970		Control Arm Bushing	510557
	1999.09-2002.08	Front Axle Left & Right Lower Outer	Saloon RWD 137970		Control Arm Bushing	510498
	1999.09-2002.08	Rear Axle Left & Right Upper	Saloon RWD 137970		Control Arm Bushing	510499
	1999.09-2002.08	Front Axle Left & Right Lower Inner	Saloon RWD 137970		Control Arm Bushing Kit	510558S
	1999.09-2002.08	Front Axle Left & Right	Saloon RWD 137970		Tie Rod Axle Joint	S030853
	1999.09-2002.08	Front Axle Left & Right	Saloon RWD 137970		Tie Rod End	S070298
	1999.09-2002.08	Front Axle Right	Saloon RWD 137970		Rod/Strut, stabiliser	517496
	1999.09-2002.08	Rear Axle Left & Right	Saloon RWD 137970		Rod/Strut, stabiliser	S050281
	1999.09-2002.08	Front Axle	Saloon RWD 137970		Steering Boot	540188
	1999.09-2002.08	Front Axle	Saloon RWD 137970		Steering Rack Bellow Kit	540188S
6.0 (290 kw)						
	1991.09-1998.10	Front Axle Left Upper	Saloon RWD 120980/120982		Track Control Arm	S060267
	1991.09-1998.10	Front Axle Right Upper	Saloon RWD 120980/120982		Track Control Arm	S060268
	1991.09-1998.10	Rear Axle Left & Right Lower Inner	Saloon RWD 120980/120982		Track Control Arm	S060249
	1991.09-1998.10	Rear Axle Left & Right Upper Inner	Saloon RWD 120980/120982		Track Control Arm	S060271
	1991.09-1998.10	Rear Axle Left & Right Upper Outer	Saloon RWD 120980/120982		Track Control Arm	S060272
	1991.09-1998.10	Front Axle Left & Right Lower	Saloon RWD 120980/120982		Ball Joint	S080142
	1991.09-1998.10	Front Axle Left & Right Lower	Saloon RWD 120980/120982		Control Arm Bushing	510428
	1991.09-1998.10	Front Axle Left & Right Lower	Saloon RWD 120980/120982		Control Arm Bushing	510445
	1991.09-1998.10	Rear Axle Left & Right	Saloon RWD 120980/120982		Control Arm Bushing	510500
	1991.09-1998.10	Rear Axle Left & Right Upper	Saloon RWD 120980/120982		Control Arm Bushing	510495
	1991.09-1998.10	Rear Axle Left & Right Upper	Saloon RWD 120980/120982		Control Arm Bushing	510499
	1991.09-1998.10	Rear Axle Left & Right Upper	Saloon RWD 120980/120982		Control Arm Bushing	510499
	1991.09-1998.10	Rear Axle Left & Right Lower Outer	Saloon RWD 120980/120982		Control Arm Bushing	510446
	1991.09-1998.10	Front Axle Left & Right Lower	Saloon RWD 120980/120982		Control Arm Bushing Kit	510444S
	1991.09-1998.10	Front Axle Left & Right	Saloon RWD 120980/120982	Engine Code:M 120.980	Rod Assembly	S100078
	1991.09-1998.10	Front Axle Left & Right	Saloon RWD 120980/120982	Engine Code:M 120.980	Rod Assembly	S100191
	1991.09-1998.10	Front Axle Left & Right	Saloon RWD 120980/120982	Engine Code:M 120.980	Tie Rod End	S070289
	1991.09-1998.10	Front Axle Left & Right	Saloon RWD 120980/120982	Engine Code:M 120.980	Tie Rod End	S070290
	1991.09-1998.10	Front Axle Left	Saloon RWD 120980/120982		Rod/Strut, stabiliser	S100076
	1991.09-1998.10	Front Axle Right	Saloon RWD 120980/120982		Rod/Strut, stabiliser	S100077
	1991.09-1998.10	Rear Axle Left & Right	Saloon RWD 120980/120982		Rod/Strut, stabiliser	S050281
	1991.09-1998.10	Front Axle	Saloon RWD 120980/120982		Stabiliser Bushing	510472
	1991.09-1998.10	Front Axle	Saloon RWD 120980/120982		Stabiliser Bushing	512765
	1992.09-1999.02	Front Axle Left Upper	Coupe RWD 120980/120982		Track Control Arm	S060267
	1992.09-1999.02	Front Axle Right Upper	Coupe RWD 120980/120982		Track Control Arm	S060268
	1992.09-1999.02	Rear Axle Left & Right Lower Inner	Coupe RWD 120980/120982		Track Control Arm	S060249
	1992.09-1999.02	Rear Axle Left & Right Upper Inner	Coupe RWD 120980/120982		Track Control Arm	S060271
	1992.09-1999.02	Rear Axle Left & Right Upper Outer	Coupe RWD 120980/120982		Track Control Arm	S060272
	1992.09-1999.02	Front Axle Left & Right Lower	Coupe RWD 120980/120982		Ball Joint	S080142
	1992.09-1999.02	Front Axle Left & Right Lower	Coupe RWD 120980/120982		Control Arm Bushing	510428
	1992.09-1999.02	Front Axle Left & Right Lower	Coupe RWD 120980/120982		Control Arm Bushing	510445
	1992.09-1999.02	Rear Axle Left & Right	Coupe RWD 120980/120982		Control Arm Bushing	510500
	1992.09-1999.02	Rear Axle Left & Right Upper	Coupe RWD 120980/120982		Control Arm Bushing	510495
	1992.09-1999.02	Rear Axle Left & Right Upper	Coupe RWD 120980/120982		Control Arm Bushing	510499
	1992.09-1999.02	Rear Axle Left & Right Upper	Coupe RWD 120980/120982		Control Arm Bushing	510499
	1992.09-1999.02	Rear Axle Left & Right Lower Outer	Coupe RWD 120980/120982		Control Arm Bushing	510446
	1992.09-1999.02	Front Axle Left & Right Lower	Coupe RWD 120980/120982		Control Arm Bushing Kit	510444S
	1992.09-1999.02	Front Axle Left & Right	Coupe RWD 120980/120982		Rod Assembly	S100078
	1992.09-1999.02	Front Axle Left & Right	Coupe RWD 120980/120982		Rod Assembly	S100191
	1992.09-1999.02	Front Axle Left & Right	Coupe RWD 120980/120982		Tie Rod End	S070289
	1992.09-1999.02	Front Axle Left & Right	Coupe RWD 120980/120982		Tie Rod End	S070290
	1992.09-1999.02	Front Axle Left	Coupe RWD 120980/120982		Rod/Strut, stabiliser	S100076
	1992.09-1999.02	Front Axle Right	Coupe RWD 120980/120982		Rod/Strut, stabiliser	S100077
	1992.09-1999.02	Rear Axle Left & Right	Coupe RWD 120980/120982		Rod/Strut, stabiliser	S050281
	1992.09-1999.02	Front Axle	Coupe RWD 120980/120982		Stabiliser Bushing	510472
	1992.09-1999.02	Front Axle	Coupe RWD 120980/120982		Stabiliser Bushing	512765
S63 AMG						
5.5 (430 kw)						
	2013.07-2017.05	Front Axle Left Upper	Saloon 4WD 157985		Track Control Arm	S063167
	2013.07-2017.05	Front Axle Right Upper	Saloon 4WD 157985		Track Control Arm	S063168
	2013.07-2017.05	Front Axle Left & Right Lower Inner	Saloon 4WD 157985		Control Arm Bushing	533482
	2013.07-2017.05	Front Axle Left & Right	Saloon 4WD 157985		Tie Rod Axle Joint	S031011
	2014.04-2017.10	Front Axle Left Upper	Coupe 4WD 157985		Track Control Arm	S063167
	2014.04-2017.10	Front Axle Right Upper	Coupe 4WD 157985		Track Control Arm	S063168
	2014.04-2017.10	Front Axle Left & Right Lower Inner	Coupe 4WD 157985		Control Arm Bushing	533482



	 YEAR	FITTING POSITION	BODY STYLE & DRIVE TYPE & ENGINE	REMARKS	PRODUCT	GSP Ref.	
MERCEDES-BENZ							
S63 AMG							
5.5 (430 kw)	2014.04-2017.10	Front Axle Left & Right	Coupe 4WD 157985		Tie Rod Axle Joint	S031011	
	2015.11-2017.10	Front Axle Left Upper	Cabriolet 4WD 157985		Track Control Arm	S063167	
	2015.11-2017.10	Front Axle Right Upper	Cabriolet 4WD 157985		Track Control Arm	S063168	
	2015.11-2017.10	Front Axle Left & Right	Cabriolet 4WD 157985		Tie Rod Axle Joint	S031011	
6.2 (386 kw)	2006.12-2013.07	Front Axle Left Upper	Saloon RWD 156984		Track Control Arm	S061294	
	2006.12-2013.07	Front Axle Left Lower Inner	Saloon RWD 156984		Track Control Arm	S060251	
	2006.12-2013.07	Front Axle Left Lower Outer	Saloon RWD 156984		Track Control Arm	S060253	
	2006.12-2013.07	Front Axle Right Upper	Saloon RWD 156984		Track Control Arm	S061295	
	2006.12-2013.07	Front Axle Right Lower Inner	Saloon RWD 156984		Track Control Arm	S060252	
	2006.12-2013.07	Front Axle Right Lower Outer	Saloon RWD 156984		Track Control Arm	S060254	
	2006.12-2013.07	Rear Axle Left Lower Inner	Saloon RWD 156984		Track Control Arm	S060260	
	2006.12-2013.07	Rear Axle Left Lower Outer	Saloon RWD 156984		Track Control Arm	S060258	
	2006.12-2013.07	Rear Axle Right Lower Inner	Saloon RWD 156984		Track Control Arm	S060261	
	2006.12-2013.07	Rear Axle Right Lower Outer	Saloon RWD 156984		Track Control Arm	S060259	
	2006.12-2013.07	Front Axle Left & Right Upper	Saloon RWD 156984		Control Arm Bushing	510502	
	2006.12-2013.07	Front Axle Left & Right Lower Outer	Saloon RWD 156984		Control Arm Bushing	510508	
	2006.12-2013.07	Front Axle Left & Right Lower Outer	Saloon RWD 156984	From Chassis:461633	Control Arm Bushing	531450	
	2006.12-2013.07	Rear Axle Left & Right Lower Inner	Saloon RWD 156984		Control Arm Bushing	510496	
	2006.12-2013.07	Rear Axle Left & Right Lower Inner	Saloon RWD 156984		Control Arm Bushing	510497	
	2006.12-2013.07	Rear Axle Left & Right Lower Outer	Saloon RWD 156984		Control Arm Bushing	510493	
	2006.12-2013.07	Rear Axle Left & Right Upper Outer	Saloon RWD 156984		Control Arm Bushing	510505	
	2006.12-2013.07	Rear Axle Left & Right Upper Outer	Saloon RWD 156984		Control Arm Bushing	510506	
	2006.12-2013.07	Front Axle Left & Right	Saloon RWD 156984		Tie Rod End	S070302	
	2006.12-2013.07	Front Axle Left	Saloon RWD 156984		Rod/Strut, stabiliser	S050293	
	2006.12-2013.07	Front Axle Right	Saloon RWD 156984		Rod/Strut, stabiliser	S050294	
	2006.12-2013.07	Rear Axle Left	Saloon RWD 156984		Rod/Strut, stabiliser	S050298	
2006.12-2013.07	Rear Axle Right	Saloon RWD 156984		Rod/Strut, stabiliser	S050299		
S65 AMG							
6.0 (450 kw)	2005.12-2013.07	Front Axle Left Upper	Saloon RWD 275982		Track Control Arm	S061294	
	2005.12-2013.07	Front Axle Left Lower Inner	Saloon RWD 275982		Track Control Arm	S060251	
	2005.12-2013.07	Front Axle Left Lower Outer	Saloon RWD 275982		Track Control Arm	S060253	
	2005.12-2013.07	Front Axle Right Upper	Saloon RWD 275982		Track Control Arm	S061295	
	2005.12-2013.07	Front Axle Right Lower Inner	Saloon RWD 275982		Track Control Arm	S060252	
	2005.12-2013.07	Front Axle Right Lower Outer	Saloon RWD 275982		Track Control Arm	S060254	
	2005.12-2013.07	Rear Axle Left Lower Inner	Saloon RWD 275982		Track Control Arm	S060260	
	2005.12-2013.07	Rear Axle Left Lower Outer	Saloon RWD 275982		Track Control Arm	S060258	
	2005.12-2013.07	Rear Axle Right Lower Inner	Saloon RWD 275982		Track Control Arm	S060261	
	2005.12-2013.07	Rear Axle Right Lower Outer	Saloon RWD 275982		Track Control Arm	S060259	
	2005.12-2013.07	Front Axle Left & Right Upper	Saloon RWD 275982		Control Arm Bushing	510502	
	2005.12-2013.07	Front Axle Left & Right Lower Outer	Saloon RWD 275982		Control Arm Bushing	510508	
	2005.12-2013.07	Front Axle Left & Right Lower Outer	Saloon RWD 275982	From Chassis:461633	Control Arm Bushing	531450	
	2005.12-2013.07	Rear Axle Left & Right Lower Inner	Saloon RWD 275982		Control Arm Bushing	510496	
	2005.12-2013.07	Rear Axle Left & Right Lower Inner	Saloon RWD 275982		Control Arm Bushing	510497	
	2005.12-2013.07	Front Axle Left & Right	Saloon RWD 275982		Tie Rod End	S070302	
	2005.12-2013.07	Front Axle Left	Saloon RWD 275982		Rod/Strut, stabiliser	S050293	
	2005.12-2013.07	Front Axle Right	Saloon RWD 275982		Rod/Strut, stabiliser	S050294	
	2005.12-2013.07	Rear Axle Left	Saloon RWD 275982		Rod/Strut, stabiliser	S050298	
	2005.12-2013.07	Rear Axle Right	Saloon RWD 275982		Rod/Strut, stabiliser	S050299	
	SL280						
	2.8 (142 kw)	1993.06-1998.05	Front Axle Left Lower	Cabriolet RWD 104943		Track Control Arm	S060581
1993.06-1998.05		Front Axle Right Lower	Cabriolet RWD 104943		Track Control Arm	S060582	
1993.06-1998.05		Rear Axle Left & Right Lower Inner	Cabriolet RWD 104943		Track Control Arm	S060217	
1993.06-1998.05		Rear Axle Left & Right Upper Inner	Cabriolet RWD 104943		Track Control Arm	S060216	
1993.06-1998.05		Rear Axle Left & Right Lower Outer	Cabriolet RWD 104943		Track Control Arm	S051055	
1993.06-1998.05		Rear Axle Left & Right Upper Outer	Cabriolet RWD 104943		Track Control Arm	S060218	
1993.06-1998.05		Front Axle Left & Right Lower	Cabriolet RWD 104943		Ball Joint	S080141	
1993.06-1998.05		Front Axle Left & Right Lower	Cabriolet RWD 104943		Control Arm Bushing	510427	
1993.06-1998.05		Front Axle Left & Right Lower	Cabriolet RWD 104943		Control Arm Bushing	510428	
1993.06-1998.05		Front Axle Left & Right Lower	Cabriolet RWD 104943		Control Arm Bushing	510563	
1993.06-1998.05		Rear Axle Left & Right Lower	Cabriolet RWD 104943		Control Arm Bushing	511560	
1993.06-1998.05		Rear Axle Left & Right Upper Inner	Cabriolet RWD 104943		Control Arm Bushing	517809	
1993.06-1998.05		Rear Axle Left & Right Lower Outer	Cabriolet RWD 104943		Control Arm Bushing	510431	
1993.06-1998.05		Rear Axle Left & Right Lower Outer	Cabriolet RWD 104943		Control Arm Bushing	512252	
1993.06-1998.05		Rear Axle Left & Right Upper Outer	Cabriolet RWD 104943		Control Arm Bushing	510430	



	 YEAR	FITTING POSITION	BODY STYLE & DRIVE TYPE & ENGINE	REMARKS	PRODUCT	GSP Ref.
MERCEDES-BENZ						
SL280						
2.8 (142 kw)	1993.06-1998.05	Rear Axle	Cabriolet RWD 104943		Suspension Repair Kit	S990038SK
	1993.06-1998.05	Rear Axle Left & Right	Cabriolet RWD 104943		Rod/Strut, stabiliser	S100063
	1993.06-1998.05	Front Axle Left & Right Outer	Cabriolet RWD 104943		Stabiliser Bushing	511553
	1993.06-1998.05	Front Axle	Cabriolet RWD 104943		Stabiliser Bushing Kit	519452S
SL320						
3.2 (170 kw)	1994.01-1998.05	Front Axle Left Lower	Cabriolet RWD 104991		Track Control Arm	S060581
	1994.01-1998.05	Front Axle Right Lower	Cabriolet RWD 104991		Track Control Arm	S060582
	1994.01-1998.05	Rear Axle Left & Right Lower Inner	Cabriolet RWD 104991		Track Control Arm	S060217
	1994.01-1998.05	Rear Axle Left & Right Upper Inner	Cabriolet RWD 104991		Track Control Arm	S060216
	1994.01-1998.05	Rear Axle Left & Right Lower Outer	Cabriolet RWD 104991		Track Control Arm	S051055
	1994.01-1998.05	Rear Axle Left & Right Upper Outer	Cabriolet RWD 104991		Track Control Arm	S060218
	1994.01-1998.05	Front Axle Left & Right Lower	Cabriolet RWD 104991		Ball Joint	S080141
	1994.01-1998.05	Front Axle Left & Right Lower	Cabriolet RWD 104991		Control Arm Bushing	510427
	1994.01-1998.05	Front Axle Left & Right Lower	Cabriolet RWD 104991		Control Arm Bushing	510428
	1994.01-1998.05	Front Axle Left & Right Lower	Cabriolet RWD 104991		Control Arm Bushing	510563
	1994.01-1998.05	Rear Axle Left & Right Lower	Cabriolet RWD 104991		Control Arm Bushing	511560
	1994.01-1998.05	Rear Axle Left & Right Upper Inner	Cabriolet RWD 104991		Control Arm Bushing	517809
	1994.01-1998.05	Rear Axle Left & Right Lower Outer	Cabriolet RWD 104991		Control Arm Bushing	510431
	1994.01-1998.05	Rear Axle Left & Right Lower Outer	Cabriolet RWD 104991		Control Arm Bushing	512252
	1994.01-1998.05	Rear Axle Left & Right Upper Outer	Cabriolet RWD 104991		Control Arm Bushing	510430
	1994.01-1998.05	Rear Axle	Cabriolet RWD 104991		Suspension Repair Kit	S990038SK
	1994.01-1998.05	Rear Axle Left & Right	Cabriolet RWD 104991		Rod/Strut, stabiliser	S100063
	1994.01-1998.05	Front Axle Left & Right Outer	Cabriolet RWD 104991		Stabiliser Bushing	511553
	1994.01-1998.05	Front Axle	Cabriolet RWD 104991		Stabiliser Bushing Kit	519452S
SL350						
3.5 (232 kw)	2008.04-2012.01	Rear Axle Left Upper Inner	Cabriolet RWD 272968		Track Control Arm	S060231
	2008.04-2012.01	Rear Axle Left Upper Outer	Cabriolet RWD 272968		Track Control Arm	S060229
	2008.04-2012.01	Rear Axle Right Upper Inner	Cabriolet RWD 272968		Track Control Arm	S060232
	2008.04-2012.01	Rear Axle Right Upper Outer	Cabriolet RWD 272968		Track Control Arm	S060230
	2008.04-2012.01	Rear Axle Left & Right Lower Inner	Cabriolet RWD 272968		Track Control Arm	S060233
	2008.04-2012.01	Front Axle Left & Right Upper	Cabriolet RWD 272968		Ball Joint	S080145
	2008.04-2012.01	Front Axle Left & Right Lower Inner	Cabriolet RWD 272968		Ball Joint	S080136
	2008.04-2012.01	Front Axle Left & Right Lower Inner	Cabriolet RWD 272968		Control Arm Bushing	510557
	2008.04-2012.01	Front Axle Left & Right Lower Outer	Cabriolet RWD 272968		Control Arm Bushing	530133
	2008.04-2012.01	Rear Axle Left & Right Lower Inner	Cabriolet RWD 272968		Control Arm Bushing	530527
	2008.04-2012.01	Rear Axle Left & Right Upper Inner	Cabriolet RWD 272968		Control Arm Bushing	510521
	2008.04-2012.01	Rear Axle Left & Right Upper Outer	Cabriolet RWD 272968		Control Arm Bushing	510522
	2008.04-2012.01	Rear Axle	Cabriolet RWD 272968		Suspension Repair Kit	S990056SK
	2008.04-2012.01	Front Axle Left & Right	Cabriolet RWD 272968		Tie Rod Axle Joint	S030853
	2008.04-2012.01	Front Axle Left & Right	Cabriolet RWD 272968		Tie Rod End	S070298
2008.04-2012.01	Front Axle	Cabriolet RWD 272968		Steering Rack Bellow Kit	540188S	
SL400						
3.0 (245 kw)	2014.04-	Front Axle Left & Right Lower Inner	Cabriolet RWD 276825		Ball Joint	S080134
	2014.04-	Front Axle Left & Right Lower Outer	Cabriolet RWD 276825		Control Arm Bushing	530133
	2014.04-	Rear Axle Left & Right Upper Inner	Cabriolet RWD 276825		Control Arm Bushing	516563
SL500						
5.0 (225 kw)	2001.08-2012.01	Front Axle Left Lower Outer	Cabriolet RWD 113963		Track Control Arm	S060227
	2001.08-2012.01	Front Axle Right Lower Outer	Cabriolet RWD 113963		Track Control Arm	S060228
	2001.08-2012.01	Rear Axle Left Upper Inner	Cabriolet RWD 113963		Track Control Arm	S060231
	2001.08-2012.01	Rear Axle Left Upper Outer	Cabriolet RWD 113963		Track Control Arm	S060229
	2001.08-2012.01	Rear Axle Right Upper Inner	Cabriolet RWD 113963		Track Control Arm	S060232
	2001.08-2012.01	Rear Axle Right Upper Outer	Cabriolet RWD 113963		Track Control Arm	S060230
	2001.08-2012.01	Rear Axle Left & Right Lower Inner	Cabriolet RWD 113963		Track Control Arm	S060233
	2001.08-2012.01	Front Axle Left & Right Upper	Cabriolet RWD 113963		Ball Joint	S080145
	2001.08-2012.01	Front Axle Left & Right Lower Inner	Cabriolet RWD 113963	for OE No.211 330 81 07	Ball Joint	S080134
	2001.08-2012.01	Front Axle Left & Right Lower Inner	Cabriolet RWD 113963		Ball Joint	S080136
	2001.08-2012.01	Front Axle Left & Right Lower Inner	Cabriolet RWD 113963		Control Arm Bushing	510557
	2001.08-2012.01	Front Axle Left & Right Lower Outer	Cabriolet RWD 113963		Control Arm Bushing	510518
	2001.08-2012.01	Front Axle Left & Right Lower Outer	Cabriolet RWD 113963		Control Arm Bushing	530133
	2001.08-2012.01	Rear Axle Left & Right Lower Inner	Cabriolet RWD 113963		Control Arm Bushing	530527
	2001.08-2012.01	Rear Axle Left & Right Upper Inner	Cabriolet RWD 113963		Control Arm Bushing	510521
	2001.08-2012.01	Rear Axle Left & Right Upper Outer	Cabriolet RWD 113963		Control Arm Bushing	510522
	2001.08-2012.01	Rear Axle	Cabriolet RWD 113963		Suspension Repair Kit	S990056SK
	2001.08-2012.01	Front Axle Left & Right	Cabriolet RWD 113963		Tie Rod Axle Joint	S030853



	 YEAR	FITTING POSITION	BODY STYLE & DRIVE TYPE & ENGINE	REMARKS	PRODUCT	GSP Ref.	
MERCEDES-BENZ SL500							
5.0 (225 kw)	2001.08-2012.01	Front Axle Left & Right	Cabriolet RWD 113963		Tie Rod End	S070298	
	2001.08-2012.01	Front Axle	Cabriolet RWD 113963		Steering Rack Bellow Kit	540188S	
5.0 (235 kw)	1992.09-2003.12	Front Axle Left Lower	Cabriolet RWD 119972/119982		Track Control Arm	S060581	
	1992.09-2003.12	Front Axle Right Lower	Cabriolet RWD 119972/119982		Track Control Arm	S060582	
	1992.09-2003.12	Rear Axle Left & Right Lower Inner	Cabriolet RWD 119972/119982		Track Control Arm	S060217	
	1992.09-2003.12	Rear Axle Left & Right Upper Inner	Cabriolet RWD 119972/119982		Track Control Arm	S060216	
	1992.09-2003.12	Rear Axle Left & Right Lower Outer	Cabriolet RWD 119972/119982		Track Control Arm	S051055	
	1992.09-2003.12	Rear Axle Left & Right Upper Outer	Cabriolet RWD 119972/119982		Track Control Arm	S060218	
	1992.09-2003.12	Front Axle Left & Right Lower	Cabriolet RWD 119972/119982		Ball Joint	S080141	
	1992.09-2003.12	Front Axle Left & Right Lower	Cabriolet RWD 119972/119982		Control Arm Bushing	510427	
	1992.09-2003.12	Front Axle Left & Right Lower	Cabriolet RWD 119972/119982		Control Arm Bushing	510428	
	1992.09-2003.12	Front Axle Left & Right Lower	Cabriolet RWD 119972/119982		Control Arm Bushing	510563	
	1992.09-2003.12	Rear Axle Left & Right Lower	Cabriolet RWD 119972/119982		Control Arm Bushing	511560	
	1992.09-2003.12	Rear Axle Left & Right Upper Inner	Cabriolet RWD 119972/119982		Control Arm Bushing	517809	
	1992.09-2003.12	Rear Axle Left & Right Lower Outer	Cabriolet RWD 119972/119982		Control Arm Bushing	510431	
	1992.09-2003.12	Rear Axle Left & Right Lower Outer	Cabriolet RWD 119972/119982		Control Arm Bushing	512252	
	1992.09-2003.12	Rear Axle Left & Right Upper Outer	Cabriolet RWD 119972/119982		Control Arm Bushing	510430	
	1992.09-2003.12	Rear Axle	Cabriolet RWD 119972/119982		Suspension Repair Kit	S990038SK	
	1992.09-2003.12	Front Axle Left & Right	Cabriolet RWD 119972/119982		Tie Rod End	S070824	
	1992.09-2003.12	Rear Axle Left & Right	Cabriolet RWD 119972/119982		Rod/Strut, stabiliser	S100063	
	1992.09-2003.12	Front Axle Left & Right Outer	Cabriolet RWD 119972/119982		Stabiliser Bushing	511553	
	1992.09-2003.12	Front Axle	Cabriolet RWD 119972/119982		Stabiliser Bushing Kit	519452S	
5.5 (285 kw)	2006.03-2012.01	Rear Axle Left Upper Inner	Cabriolet RWD 273965		Track Control Arm	S060231	
	2006.03-2012.01	Rear Axle Left Upper Outer	Cabriolet RWD 273965		Track Control Arm	S060229	
	2006.03-2012.01	Rear Axle Right Upper Inner	Cabriolet RWD 273965		Track Control Arm	S060232	
	2006.03-2012.01	Rear Axle Right Upper Outer	Cabriolet RWD 273965		Track Control Arm	S060230	
	2006.03-2012.01	Rear Axle Left & Right Lower Inner	Cabriolet RWD 273965		Track Control Arm	S060233	
	2006.03-2012.01	Front Axle Left & Right Upper	Cabriolet RWD 273965		Ball Joint	S080145	
	2006.03-2012.01	Front Axle Left & Right Lower Inner	Cabriolet RWD 273965	for OE No.211 330 81 07	Ball Joint	S080134	
	2006.03-2012.01	Front Axle Left & Right Lower Inner	Cabriolet RWD 273965		Ball Joint	S080136	
	2006.03-2012.01	Front Axle Left & Right Lower Inner	Cabriolet RWD 273965		Control Arm Bushing	510557	
	2006.03-2012.01	Front Axle Left & Right Lower Outer	Cabriolet RWD 273965		Control Arm Bushing	510518	
	2006.03-2012.01	Front Axle Left & Right Lower Outer	Cabriolet RWD 273965		Control Arm Bushing	530133	
	2006.03-2012.01	Rear Axle Left & Right Lower Inner	Cabriolet RWD 273965		Control Arm Bushing	530527	
	2006.03-2012.01	Rear Axle Left & Right Upper Inner	Cabriolet RWD 273965		Control Arm Bushing	510521	
	2006.03-2012.01	Rear Axle Left & Right Upper Outer	Cabriolet RWD 273965		Control Arm Bushing	510522	
	2006.03-2012.01	Rear Axle	Cabriolet RWD 273965		Suspension Repair Kit	S990056SK	
	2006.03-2012.01	Front Axle Left & Right	Cabriolet RWD 273965		Tie Rod Axle Joint	S030853	
	2006.03-2012.01	Front Axle Left & Right	Cabriolet RWD 273965		Tie Rod End	S070298	
	2006.03-2012.01	Front Axle	Cabriolet RWD 273965		Steering Rack Bellow Kit	540188S	
	SL600						
	6.0 (290 kw)	1992.07-2001.10	Rear Axle Left & Right Lower Inner	Cabriolet RWD 120981/120983		Track Control Arm	S060217
1992.07-2001.10		Rear Axle Left & Right Upper Inner	Cabriolet RWD 120981/120983		Track Control Arm	S060216	
1992.07-2001.10		Rear Axle Left & Right Lower Outer	Cabriolet RWD 120981/120983		Track Control Arm	S051055	
1992.07-2001.10		Rear Axle Left & Right Upper Outer	Cabriolet RWD 120981/120983		Track Control Arm	S060218	
1992.07-2001.10		Front Axle Left & Right Lower	Cabriolet RWD 120981/120983		Ball Joint	S080141	
1992.07-2001.10		Front Axle Left & Right Lower	Cabriolet RWD 120981/120983		Control Arm Bushing	510427	
1992.07-2001.10		Front Axle Left & Right Lower	Cabriolet RWD 120981/120983		Control Arm Bushing	510428	
1992.07-2001.10		Rear Axle Left & Right Lower	Cabriolet RWD 120981/120983		Control Arm Bushing	511560	
1992.07-2001.10		Rear Axle Left & Right Upper Inner	Cabriolet RWD 120981/120983		Control Arm Bushing	517809	
1992.07-2001.10		Rear Axle Left & Right Lower Outer	Cabriolet RWD 120981/120983		Control Arm Bushing	510431	
1992.07-2001.10		Rear Axle Left & Right Lower Outer	Cabriolet RWD 120981/120983		Control Arm Bushing	512252	
1992.07-2001.10		Rear Axle Left & Right Upper Outer	Cabriolet RWD 120981/120983		Control Arm Bushing	510430	
1992.07-2001.10		Rear Axle	Cabriolet RWD 120981/120983		Suspension Repair Kit	S990038SK	
1992.07-2001.10		Rear Axle Left & Right	Cabriolet RWD 120981/120983		Rod/Strut, stabiliser	S100063	
1992.07-2001.10		Front Axle Left & Right Outer	Cabriolet RWD 120981/120983		Stabiliser Bushing	511553	
1992.07-2001.10		Front Axle	Cabriolet RWD 120981/120983		Stabiliser Bushing Kit	519452S	
SL63 AMG							
6.2 (386 kw)		2008.03-2012.01	Front Axle Left & Right Upper	Cabriolet RWD 156981		Ball Joint	S080145
		2008.03-2012.01	Front Axle Left & Right Lower Inner	Cabriolet RWD 156981		Ball Joint	S080136
		2008.03-2012.01	Front Axle Left & Right Lower Inner	Cabriolet RWD 156981		Control Arm Bushing	510557
	2008.03-2012.01	Front Axle Left & Right Lower Inner	Cabriolet RWD 156981		Control Arm Bushing	518120	
	2008.03-2012.01	Front Axle Left & Right	Cabriolet RWD 156981		Tie Rod Axle Joint	S030853	
	2008.03-2012.01	Front Axle Left & Right	Cabriolet RWD 156981		Tie Rod End	S070298	



	 YEAR	FITTING POSITION	BODY STYLE & DRIVE TYPE & ENGINE	REMARKS	PRODUCT	GSP Ref.
MERCEDES-BENZ						
SL63 AMG						
6.2 (386 kw)	2008.03-2012.01	Front Axle	Cabriolet RWD 156981		Steering Rack Bellow Kit	540188S
SL65 AMG						
6.0 (450 kw)	2004.09-2011.12	Front Axle Left Lower Outer	Cabriolet RWD 275981		Track Control Arm	S060227
	2004.09-2011.12	Front Axle Right Lower Outer	Cabriolet RWD 275981		Track Control Arm	S060228
	2004.09-2011.12	Front Axle Left & Right Upper	Cabriolet RWD 275981		Ball Joint	S080145
	2004.09-2011.12	Front Axle Left & Right Lower Inner	Cabriolet RWD 275981	for OE No.211 330 81 07	Ball Joint	S080134
	2004.09-2011.12	Front Axle Left & Right Lower Inner	Cabriolet RWD 275981		Ball Joint	S080136
	2004.09-2011.12	Front Axle Left & Right Lower Inner	Cabriolet RWD 275981		Control Arm Bushing	510557
	2004.09-2011.12	Front Axle Left & Right	Cabriolet RWD 275981		Tie Rod Axle Joint	S030853
	2004.09-2011.12	Front Axle Left & Right	Cabriolet RWD 275981		Tie Rod End	S070298
	2004.09-2011.12	Front Axle	Cabriolet RWD 275981		Steering Rack Bellow Kit	540188S
SLC300						
2.0 (180 kw)	2016.01-	Front Axle Left Lower Inner	Cabriolet RWD 274920		Track Control Arm	S060262
	2016.01-	Front Axle Left Lower Outer	Cabriolet RWD 274920		Track Control Arm	S060221
	2016.01-	Front Axle Right Lower Inner	Cabriolet RWD 274920		Track Control Arm	S060263
	2016.01-	Front Axle Right Lower Outer	Cabriolet RWD 274920		Track Control Arm	S060222
	2016.01-	Front Axle Left & Right Lower Inner	Cabriolet RWD 274920		Control Arm Bushing	517969
	2016.01-	Front Axle Left & Right Lower Outer	Cabriolet RWD 274920		Control Arm Bushing	510491
	2016.01-	Front Axle Left & Right Lower Outer	Cabriolet RWD 274920		Control Arm Bushing	531450
	2016.01-	Rear Axle Left & Right Lower	Cabriolet RWD 274920		Control Arm Bushing	511560
	2016.01-	Rear Axle Left & Right Lower Outer	Cabriolet RWD 274920		Control Arm Bushing	512252
	2016.01-	Front Axle Left	Cabriolet RWD 274920		Tie Rod End	S070284
	2016.01-	Front Axle Right	Cabriolet RWD 274920		Tie Rod End	S070285
SLC43 AMG						
3.0 (270 kw)	2016.01-	Front Axle Left & Right Lower Inner	Cabriolet RWD 276822		Control Arm Bushing	518120
	2016.01-	Rear Axle Left & Right Lower	Cabriolet RWD 276822		Control Arm Bushing	511560
	2016.01-	Rear Axle Left & Right Lower Outer	Cabriolet RWD 276822		Control Arm Bushing	512252
	2016.01-	Front Axle Left	Cabriolet RWD 276822		Tie Rod End	S070284
	2016.01-	Front Axle Right	Cabriolet RWD 276822		Tie Rod End	S070285
SLK200						
1.8 (120 kw)	2004.03-2011.02	Front Axle Left Lower Inner	Cabriolet RWD 271944		Track Control Arm	S060219
	2004.03-2011.02	Front Axle Left Lower Outer	Cabriolet RWD 271944		Track Control Arm	S060221
	2004.03-2011.02	Front Axle Right Lower Inner	Cabriolet RWD 271944		Track Control Arm	S060220
	2004.03-2011.02	Front Axle Right Lower Outer	Cabriolet RWD 271944		Track Control Arm	S060222
	2004.03-2011.02	Rear Axle Left & Right Lower Inner	Cabriolet RWD 271944		Track Control Arm	S060217
	2004.03-2011.02	Rear Axle Left & Right Upper Inner	Cabriolet RWD 271944		Track Control Arm	S060216
	2004.03-2011.02	Front Axle Left & Right Lower Inner	Cabriolet RWD 271944		Control Arm Bushing	510565
	2004.03-2011.02	Front Axle Left & Right Lower Outer	Cabriolet RWD 271944		Control Arm Bushing	510491
	2004.03-2011.02	Front Axle Left & Right Lower Outer	Cabriolet RWD 271944		Control Arm Bushing	531450
	2004.03-2011.02	Rear Axle Left & Right Lower	Cabriolet RWD 271944		Control Arm Bushing	511560
	2004.03-2011.02	Rear Axle Left & Right Upper Inner	Cabriolet RWD 271944		Control Arm Bushing	517809
	2004.03-2011.02	Rear Axle Left & Right Lower Outer	Cabriolet RWD 271944		Control Arm Bushing	512252
	2004.03-2011.02	Front Axle	Cabriolet RWD 271944	for vehicles without sports suspension	Suspension Repair Kit	S990006SK
	2004.03-2011.02	Front Axle	Cabriolet RWD 271944		Suspension Repair Kit	S990034SK
	2004.03-2011.02	Front Axle Left	Cabriolet RWD 271944		Tie Rod End	S070284
	2004.03-2011.02	Front Axle Right	Cabriolet RWD 271944		Tie Rod End	S070285
	2004.03-2011.02	Rear Axle Left & Right	Cabriolet RWD 271944		Rod/Strut, stabiliser	S100063
	2004.03-2011.02	Front Axle	Cabriolet RWD 271944		Steering Boot	540343
	2004.03-2011.02	Front Axle	Cabriolet RWD 271944	540343S and 541198S different structure	Steering Rack Bellow Kit	540343S
1.8 (135 kw)	2008.01-2011.02	Front Axle Left Lower Inner	Cabriolet RWD 271954		Track Control Arm	S060219
	2008.01-2011.02	Front Axle Left Lower Outer	Cabriolet RWD 271954		Track Control Arm	S060221
	2008.01-2011.02	Front Axle Right Lower Inner	Cabriolet RWD 271954		Track Control Arm	S060220
	2008.01-2011.02	Front Axle Right Lower Outer	Cabriolet RWD 271954		Track Control Arm	S060222
	2008.01-2011.02	Rear Axle Left & Right Lower Inner	Cabriolet RWD 271954		Track Control Arm	S060217
	2008.01-2011.02	Rear Axle Left & Right Upper Inner	Cabriolet RWD 271954		Track Control Arm	S060216
	2008.01-2011.02	Front Axle Left & Right Lower Inner	Cabriolet RWD 271954		Control Arm Bushing	510565
	2008.01-2011.02	Front Axle Left & Right Lower Outer	Cabriolet RWD 271954		Control Arm Bushing	510491
	2008.01-2011.02	Front Axle Left & Right Lower Outer	Cabriolet RWD 271954		Control Arm Bushing	531450
	2008.01-2011.02	Rear Axle Left & Right Lower	Cabriolet RWD 271954		Control Arm Bushing	511560
	2008.01-2011.02	Rear Axle Left & Right Upper Inner	Cabriolet RWD 271954		Control Arm Bushing	517809
	2008.01-2011.02	Rear Axle Left & Right Lower Outer	Cabriolet RWD 271954		Control Arm Bushing	512252
	2008.01-2011.02	Front Axle Left	Cabriolet RWD 271954		Tie Rod End	S070284
	2008.01-2011.02	Front Axle Right	Cabriolet RWD 271954		Tie Rod End	S070285
	2008.01-2011.02	Rear Axle Left & Right	Cabriolet RWD 271954		Rod/Strut, stabiliser	S100063



	 YEAR	FITTING POSITION	BODY STYLE & DRIVE TYPE & ENGINE	REMARKS	PRODUCT	GSP Ref.
MERCEDES-BENZ						
SLK200						
1.8 (135 kw)	2008.01-2011.02	Front Axle	Cabriolet RWD 271954		Steering Boot	540343
	2008.01-2011.02	Front Axle	Cabriolet RWD 271954	540343S and 541198S different structure	Steering Rack Bellow Kit	540343S
	2011.01-	Front Axle Left Lower Inner	Cabriolet RWD 271861		Track Control Arm	S060262
	2011.01-	Front Axle Left Lower Outer	Cabriolet RWD 271861		Track Control Arm	S060221
	2011.01-	Front Axle Right Lower Inner	Cabriolet RWD 271861		Track Control Arm	S060263
	2011.01-	Front Axle Right Lower Outer	Cabriolet RWD 271861		Track Control Arm	S060222
	2011.01-	Front Axle Left & Right Lower Inner	Cabriolet RWD 271861		Control Arm Bushing	517969
	2011.01-	Front Axle Left & Right Lower Outer	Cabriolet RWD 271861		Control Arm Bushing	510491
	2011.01-	Front Axle Left & Right Lower Outer	Cabriolet RWD 271861		Control Arm Bushing	531450
	2011.01-	Rear Axle Left & Right Lower	Cabriolet RWD 271861		Control Arm Bushing	511560
	2011.01-	Rear Axle Left & Right Lower Outer	Cabriolet RWD 271861		Control Arm Bushing	512252
	2011.01-	Front Axle Left	Cabriolet RWD 271861		Tie Rod End	S070284
	2011.01-	Front Axle Right	Cabriolet RWD 271861		Tie Rod End	S070285
	2011.01-	Front Axle Left	Cabriolet RWD 271861		Steering Rack Bellow Kit	540204S
2011.01-	Front Axle Right	Cabriolet RWD 271861	for right-hand drive vehicles	Steering Rack Bellow Kit	540204S	
SLK230						
2.3 (142 kw)	1996.09-2000.12	Front Axle Left Lower	Cabriolet RWD 111973		Track Control Arm	S060575
	1996.09-2000.12	Front Axle Left Upper	Cabriolet RWD 111973		Track Control Arm	S060214
	1996.09-2000.12	Front Axle Right Lower	Cabriolet RWD 111973		Track Control Arm	S060576
	1996.09-2000.12	Front Axle Right Upper	Cabriolet RWD 111973		Track Control Arm	S060215
	1996.09-2000.12	Rear Axle Left & Right Lower Inner	Cabriolet RWD 111973		Track Control Arm	S060217
	1996.09-2000.12	Rear Axle Left & Right Upper Inner	Cabriolet RWD 111973	Chassis no.from:F 056942	Track Control Arm	S060216
	1996.09-2000.12	Rear Axle Left & Right Lower Outer	Cabriolet RWD 111973		Track Control Arm	S051055
	1996.09-2000.12	Rear Axle Left & Right Upper Outer	Cabriolet RWD 111973		Track Control Arm	S060218
	1996.09-2000.12	Front Axle Left & Right Lower	Cabriolet RWD 111973		Ball Joint	S080143
	1996.09-2000.12	Front Axle Left & Right Lower	Cabriolet RWD 111973		Control Arm Bushing	510468
	1996.09-2000.12	Front Axle Left & Right Lower	Cabriolet RWD 111973		Control Arm Bushing	510517
	1996.09-2000.12	Front Axle Left & Right Upper	Cabriolet RWD 111973		Control Arm Bushing	510456
	1996.09-2000.12	Rear Axle Left & Right Lower	Cabriolet RWD 111973		Control Arm Bushing	511560
	1996.09-2000.12	Rear Axle Left & Right Upper Inner	Cabriolet RWD 111973		Control Arm Bushing	517809
	1996.09-2000.12	Rear Axle Left & Right Lower Outer	Cabriolet RWD 111973		Control Arm Bushing	510431
	1996.09-2000.12	Rear Axle Left & Right Lower Outer	Cabriolet RWD 111973		Control Arm Bushing	512252
	1996.09-2000.12	Rear Axle Left & Right Upper Outer	Cabriolet RWD 111973		Control Arm Bushing	510430
	1996.09-2000.12	Rear Axle	Cabriolet RWD 111973		Suspension Repair Kit	S990038SK
	1996.09-2000.12	Front Axle Left & Right Inner	Cabriolet RWD 111973		Stabiliser Bushing	512609
	1996.09-2000.12	Front Axle Left & Right Outer	Cabriolet RWD 111973		Stabiliser Bushing	511553
2.3 (145 kw)	1999.10-2004.01	Front Axle Left Lower	Cabriolet RWD 111983		Track Control Arm	S060575
	1999.10-2004.01	Front Axle Left Upper	Cabriolet RWD 111983		Track Control Arm	S060214
	1999.10-2004.01	Front Axle Right Lower	Cabriolet RWD 111983		Track Control Arm	S060576
	1999.10-2004.01	Front Axle Right Upper	Cabriolet RWD 111983		Track Control Arm	S060215
	1999.10-2004.01	Rear Axle Left & Right Lower Inner	Cabriolet RWD 111983		Track Control Arm	S060217
	1999.10-2004.01	Rear Axle Left & Right Upper Inner	Cabriolet RWD 111983		Track Control Arm	S060216
	1999.10-2004.01	Rear Axle Left & Right Lower Outer	Cabriolet RWD 111983		Track Control Arm	S051055
	1999.10-2004.01	Rear Axle Left & Right Upper Outer	Cabriolet RWD 111983		Track Control Arm	S060218
	1999.10-2004.01	Front Axle Left & Right Lower	Cabriolet RWD 111983		Ball Joint	S080143
	1999.10-2004.01	Front Axle Left & Right Lower	Cabriolet RWD 111983		Control Arm Bushing	510517
	1999.10-2004.01	Front Axle Left & Right Upper	Cabriolet RWD 111983		Control Arm Bushing	510456
	1999.10-2004.01	Rear Axle Left & Right Lower	Cabriolet RWD 111983		Control Arm Bushing	511560
	1999.10-2004.01	Rear Axle Left & Right Upper Inner	Cabriolet RWD 111983		Control Arm Bushing	517809
	1999.10-2004.01	Rear Axle Left & Right Lower Outer	Cabriolet RWD 111983		Control Arm Bushing	510431
	1999.10-2004.01	Rear Axle Left & Right Lower Outer	Cabriolet RWD 111983		Control Arm Bushing	512252
	1999.10-2004.01	Rear Axle Left & Right Upper Outer	Cabriolet RWD 111983		Control Arm Bushing	510430
	1999.10-2004.01	Rear Axle	Cabriolet RWD 111983		Suspension Repair Kit	S990038SK
	1999.10-2004.01	Front Axle Left & Right	Cabriolet RWD 111983		Tie Rod End	S070309
	1999.10-2004.01	Rear Axle Left & Right	Cabriolet RWD 111983		Rod/Strut, stabiliser	S100063
	1999.10-2004.01	Front Axle Left & Right Outer	Cabriolet RWD 111983		Stabiliser Bushing	511553
1999.10-2004.01	Rear Axle	Cabriolet RWD 111983		Stabiliser Bushing	517269	
SLK250						
1.8 (150 kw)	2011.02-	Front Axle Left Lower Inner	Cabriolet RWD 271861		Track Control Arm	S060262
	2011.02-	Front Axle Left Lower Outer	Cabriolet RWD 271861		Track Control Arm	S060221
	2011.02-	Front Axle Right Lower Inner	Cabriolet RWD 271861		Track Control Arm	S060263
	2011.02-	Front Axle Right Lower Outer	Cabriolet RWD 271861		Track Control Arm	S060222
	2011.02-	Front Axle Left & Right Lower Inner	Cabriolet RWD 271861		Control Arm Bushing	517969
	2011.02-	Front Axle Left & Right Lower Outer	Cabriolet RWD 271861		Control Arm Bushing	510491



	 YEAR	FITTING POSITION	BODY STYLE & DRIVE TYPE & ENGINE	REMARKS	PRODUCT	GSP Ref.
MERCEDES-BENZ						
SLK250						
1.8 (150 kw)	2011.02-	Front Axle Left & Right Lower Outer	Cabriolet RWD 271861		Control Arm Bushing	531450
	2011.02-	Rear Axle Left & Right Lower	Cabriolet RWD 271861		Control Arm Bushing	511560
	2011.02-	Rear Axle Left & Right Lower Outer	Cabriolet RWD 271861		Control Arm Bushing	512252
	2011.02-	Front Axle Left	Cabriolet RWD 271861		Tie Rod End	S070284
	2011.02-	Front Axle Right	Cabriolet RWD 271861		Tie Rod End	S070285
	2011.02-	Front Axle Left	Cabriolet RWD 271861		Steering Rack Bellow Kit	540204S
	2011.02-	Front Axle Right	Cabriolet RWD 271861	for right-hand drive vehicles	Steering Rack Bellow Kit	540204S
SLK300						
2.0 (180 kw)	2015.07-	Front Axle Left Lower Inner	Cabriolet RWD 274920		Track Control Arm	S060262
	2015.07-	Front Axle Left Lower Outer	Cabriolet RWD 274920		Track Control Arm	S060221
	2015.07-	Front Axle Right Lower Inner	Cabriolet RWD 274920		Track Control Arm	S060263
	2015.07-	Front Axle Right Lower Outer	Cabriolet RWD 274920		Track Control Arm	S060222
	2015.07-	Front Axle Left & Right Lower Inner	Cabriolet RWD 274920		Control Arm Bushing	517969
	2015.07-	Front Axle Left & Right Lower Outer	Cabriolet RWD 274920		Control Arm Bushing	510491
	2015.07-	Front Axle Left & Right Lower Outer	Cabriolet RWD 274920		Control Arm Bushing	531450
	2015.07-	Rear Axle Left & Right Lower	Cabriolet RWD 274920		Control Arm Bushing	511560
	2015.07-	Rear Axle Left & Right Lower Outer	Cabriolet RWD 274920		Control Arm Bushing	512252
	2015.07-	Front Axle Left	Cabriolet RWD 274920		Tie Rod End	S070284
	2015.07-	Front Axle Right	Cabriolet RWD 274920		Tie Rod End	S070285
	2015.07-	Front Axle	Cabriolet RWD 274920	for left-hand drive vehicles,for right-hand drive vehicles	Steering Rack Bellow Kit	540204S
SLK32 AMG						
3.2 (260 kw)	2000.04-2004.01	Front Axle Left Lower	Cabriolet RWD 112960		Track Control Arm	S060575
	2000.04-2004.01	Front Axle Left Upper	Cabriolet RWD 112960		Track Control Arm	S060214
	2000.04-2004.01	Front Axle Right Lower	Cabriolet RWD 112960		Track Control Arm	S060576
	2000.04-2004.01	Front Axle Right Upper	Cabriolet RWD 112960		Track Control Arm	S060215
	2000.04-2004.01	Rear Axle Left & Right Lower Inner	Cabriolet RWD 112960		Track Control Arm	S060217
	2000.04-2004.01	Rear Axle Left & Right Upper Inner	Cabriolet RWD 112960		Track Control Arm	S060216
	2000.04-2004.01	Rear Axle Left & Right Lower Outer	Cabriolet RWD 112960		Track Control Arm	S051055
	2000.04-2004.01	Front Axle Left & Right Lower	Cabriolet RWD 112960		Ball Joint	S080143
	2000.04-2004.01	Front Axle Left & Right Upper	Cabriolet RWD 112960		Control Arm Bushing	510456
	2000.04-2004.01	Rear Axle Left & Right Lower	Cabriolet RWD 112960		Control Arm Bushing	511560
	2000.04-2004.01	Rear Axle Left & Right Upper Inner	Cabriolet RWD 112960		Control Arm Bushing	517809
	2000.04-2004.01	Rear Axle Left & Right Lower Outer	Cabriolet RWD 112960		Control Arm Bushing	512252
	2000.04-2004.01	Rear Axle	Cabriolet RWD 112960		Suspension Repair Kit	S990038SK
	2000.04-2004.01	Front Axle Left & Right	Cabriolet RWD 112960		Tie Rod End	S070309
	2000.04-2004.01	Rear Axle Left & Right	Cabriolet RWD 112960		Rod/Strut, stabiliser	S100063
	2000.04-2004.01	Front Axle Left & Right Outer	Cabriolet RWD 112960		Stabiliser Bushing	511553
	2000.04-2004.01	Rear Axle	Cabriolet RWD 112960		Stabiliser Bushing	517269
SLK320						
3.2 (160 kw)	1999.10-2004.01	Front Axle Left Lower	Cabriolet RWD 112947		Track Control Arm	S060575
	1999.10-2004.01	Front Axle Left Upper	Cabriolet RWD 112947		Track Control Arm	S060214
	1999.10-2004.01	Front Axle Right Lower	Cabriolet RWD 112947		Track Control Arm	S060576
	1999.10-2004.01	Front Axle Right Upper	Cabriolet RWD 112947		Track Control Arm	S060215
	1999.10-2004.01	Rear Axle Left & Right Lower Inner	Cabriolet RWD 112947		Track Control Arm	S060217
	1999.10-2004.01	Rear Axle Left & Right Upper Inner	Cabriolet RWD 112947		Track Control Arm	S060216
	1999.10-2004.01	Rear Axle Left & Right Lower Outer	Cabriolet RWD 112947		Track Control Arm	S051055
	1999.10-2004.01	Front Axle Left & Right Lower	Cabriolet RWD 112947		Ball Joint	S080143
	1999.10-2004.01	Front Axle Left & Right Upper	Cabriolet RWD 112947		Control Arm Bushing	510456
	1999.10-2004.01	Rear Axle Left & Right Lower	Cabriolet RWD 112947		Control Arm Bushing	511560
	1999.10-2004.01	Rear Axle Left & Right Upper Inner	Cabriolet RWD 112947		Control Arm Bushing	517809
	1999.10-2004.01	Rear Axle Left & Right Lower Outer	Cabriolet RWD 112947		Control Arm Bushing	512252
	1999.10-2004.01	Rear Axle	Cabriolet RWD 112947		Suspension Repair Kit	S990038SK
	1999.10-2004.01	Front Axle Left & Right	Cabriolet RWD 112947		Tie Rod End	S070309
	1999.10-2004.01	Rear Axle Left & Right	Cabriolet RWD 112947		Rod/Strut, stabiliser	S100063
	1999.10-2004.01	Front Axle Left & Right	Cabriolet RWD 112947		Stabiliser Bushing	530744
	1999.10-2004.01	Front Axle Left & Right Outer	Cabriolet RWD 112947		Stabiliser Bushing	511553
1999.10-2004.01	Rear Axle	Cabriolet RWD 112947		Stabiliser Bushing	517269	
SLK350						
3.5 (200 kw)	2004.06-2011.02	Front Axle Left Lower Inner	Cabriolet RWD 272963		Track Control Arm	S060219
	2004.06-2011.02	Front Axle Left Lower Outer	Cabriolet RWD 272963		Track Control Arm	S060221
	2004.06-2011.02	Front Axle Right Lower Inner	Cabriolet RWD 272963		Track Control Arm	S060220
	2004.06-2011.02	Front Axle Right Lower Outer	Cabriolet RWD 272963		Track Control Arm	S060222
	2004.06-2011.02	Rear Axle Left & Right Lower Inner	Cabriolet RWD 272963		Track Control Arm	S060217
	2004.06-2011.02	Rear Axle Left & Right Upper Inner	Cabriolet RWD 272963		Track Control Arm	S060216



	 YEAR	FITTING POSITION	BODY STYLE & DRIVE TYPE & ENGINE	REMARKS	PRODUCT	GSP Ref.
MERCEDES-BENZ						
SLK350						
3.5 (200 kw)	2004.06-2011.02	Front Axle Left & Right Lower Inner	Cabriolet RWD 272963		Control Arm Bushing	510565
	2004.06-2011.02	Front Axle Left & Right Lower Outer	Cabriolet RWD 272963		Control Arm Bushing	510491
	2004.06-2011.02	Front Axle Left & Right Lower Outer	Cabriolet RWD 272963		Control Arm Bushing	531450
	2004.06-2011.02	Rear Axle Left & Right Lower	Cabriolet RWD 272963		Control Arm Bushing	511560
	2004.06-2011.02	Rear Axle Left & Right Upper Inner	Cabriolet RWD 272963		Control Arm Bushing	517809
	2004.06-2011.02	Rear Axle Left & Right Lower Outer	Cabriolet RWD 272963		Control Arm Bushing	512252
	2004.06-2011.02	Front Axle	Cabriolet RWD 272963	for vehicles without sports suspension	Suspension Repair Kit	S990006SK
	2004.06-2011.02	Front Axle	Cabriolet RWD 272963		Suspension Repair Kit	S990034SK
	2004.06-2011.02	Front Axle Left	Cabriolet RWD 272963		Tie Rod End	S070284
	2004.06-2011.02	Front Axle Right	Cabriolet RWD 272963		Tie Rod End	S070285
	2004.06-2011.02	Rear Axle Left & Right	Cabriolet RWD 272963		Rod/Strut, stabiliser	S100063
	2004.06-2011.02	Front Axle	Cabriolet RWD 272963		Steering Boot	540343
	2004.06-2011.02	Front Axle	Cabriolet RWD 272963	540343S and 541198S different structure	Steering Rack Bellow Kit	540343S
3.5 (224 kw)	2008.01-2011.02	Front Axle Left Lower Inner	Cabriolet RWD 272969		Track Control Arm	S060219
	2008.01-2011.02	Front Axle Left Lower Outer	Cabriolet RWD 272969		Track Control Arm	S060221
	2008.01-2011.02	Front Axle Right Lower Inner	Cabriolet RWD 272969		Track Control Arm	S060220
	2008.01-2011.02	Front Axle Right Lower Outer	Cabriolet RWD 272969		Track Control Arm	S060222
	2008.01-2011.02	Rear Axle Left & Right Lower Inner	Cabriolet RWD 272969		Track Control Arm	S060217
	2008.01-2011.02	Rear Axle Left & Right Upper Inner	Cabriolet RWD 272969		Track Control Arm	S060216
	2008.01-2011.02	Front Axle Left & Right Lower Inner	Cabriolet RWD 272969		Control Arm Bushing	510565
	2008.01-2011.02	Front Axle Left & Right Lower Outer	Cabriolet RWD 272969		Control Arm Bushing	510491
	2008.01-2011.02	Front Axle Left & Right Lower Outer	Cabriolet RWD 272969		Control Arm Bushing	531450
	2008.01-2011.02	Rear Axle Left & Right Lower	Cabriolet RWD 272969		Control Arm Bushing	511560
	2008.01-2011.02	Rear Axle Left & Right Upper Inner	Cabriolet RWD 272969		Control Arm Bushing	517809
	2008.01-2011.02	Rear Axle Left & Right Lower Outer	Cabriolet RWD 272969		Control Arm Bushing	512252
	2008.01-2011.02	Front Axle Left	Cabriolet RWD 272969		Tie Rod End	S070284
	2008.01-2011.02	Front Axle Right	Cabriolet RWD 272969		Tie Rod End	S070285
	2008.01-2011.02	Rear Axle Left & Right	Cabriolet RWD 272969		Rod/Strut, stabiliser	S100063
	2008.01-2011.02	Front Axle	Cabriolet RWD 272969		Steering Boot	540343
	2008.01-2011.02	Front Axle	Cabriolet RWD 272969	540343S and 541198S different structure	Steering Rack Bellow Kit	540343S
	3.5 (225 kw)	2011.01-	Front Axle Left Lower Inner	Cabriolet RWD 276956		Track Control Arm
2011.01-		Front Axle Left Lower Outer	Cabriolet RWD 276956		Track Control Arm	S060221
2011.01-		Front Axle Right Lower Inner	Cabriolet RWD 276956		Track Control Arm	S060263
2011.01-		Front Axle Right Lower Outer	Cabriolet RWD 276956		Track Control Arm	S060222
2011.01-		Front Axle Left & Right Lower Inner	Cabriolet RWD 276956		Control Arm Bushing	517969
2011.01-		Front Axle Left & Right Lower Outer	Cabriolet RWD 276956		Control Arm Bushing	510491
2011.01-		Front Axle Left & Right Lower Outer	Cabriolet RWD 276956		Control Arm Bushing	531450
2011.01-		Rear Axle Left & Right Lower	Cabriolet RWD 276956		Control Arm Bushing	511560
2011.01-		Rear Axle Left & Right Lower Outer	Cabriolet RWD 276956		Control Arm Bushing	512252
2011.01-		Front Axle Left	Cabriolet RWD 276956		Tie Rod End	S070284
2011.01-		Front Axle Right	Cabriolet RWD 276956		Tie Rod End	S070285
2011.01-		Front Axle Left	Cabriolet RWD 276956		Steering Rack Bellow Kit	540204S
2011.01-	Front Axle Right	Cabriolet RWD 276956	for right-hand drive vehicles	Steering Rack Bellow Kit	540204S	
SLK55 AMG						
5.4 (265 kw)	2004.06-2011.12	Front Axle Left Lower Inner	Cabriolet RWD 113989		Track Control Arm	S060219
	2004.06-2011.12	Front Axle Left Lower Outer	Cabriolet RWD 113989		Track Control Arm	S060221
	2004.06-2011.12	Front Axle Right Lower Inner	Cabriolet RWD 113989		Track Control Arm	S060220
	2004.06-2011.12	Front Axle Right Lower Outer	Cabriolet RWD 113989		Track Control Arm	S060222
	2004.06-2011.12	Rear Axle Left & Right Lower Inner	Cabriolet RWD 113989		Track Control Arm	S060217
	2004.06-2011.12	Rear Axle Left & Right Upper Inner	Cabriolet RWD 113989		Track Control Arm	S060216
	2004.06-2011.12	Front Axle Left & Right Lower Inner	Cabriolet RWD 113989		Control Arm Bushing	510565
	2004.06-2011.12	Front Axle Left & Right Lower Outer	Cabriolet RWD 113989		Control Arm Bushing	510491
	2004.06-2011.12	Front Axle Left & Right Lower Outer	Cabriolet RWD 113989		Control Arm Bushing	518120
	2004.06-2011.12	Front Axle Left & Right Lower Outer	Cabriolet RWD 113989		Control Arm Bushing	531450
	2004.06-2011.12	Rear Axle Left & Right Lower	Cabriolet RWD 113989		Control Arm Bushing	511560
	2004.06-2011.12	Rear Axle Left & Right Upper Inner	Cabriolet RWD 113989		Control Arm Bushing	517809
	2004.06-2011.12	Rear Axle Left & Right Lower Outer	Cabriolet RWD 113989		Control Arm Bushing	512252
	2004.06-2011.12	Front Axle	Cabriolet RWD 113989		Suspension Repair Kit	S990034SK
	2004.06-2011.12	Front Axle Left	Cabriolet RWD 113989		Tie Rod End	S070284
	2004.06-2011.12	Front Axle Right	Cabriolet RWD 113989		Tie Rod End	S070285
	2004.06-2011.12	Rear Axle Left & Right	Cabriolet RWD 113989		Rod/Strut, stabiliser	S100063
	2004.06-2011.12	Front Axle	Cabriolet RWD 113989		Steering Boot	540343
	2004.06-2011.12	Front Axle	Cabriolet RWD 113989	540343S and 541198S different structure	Steering Rack Bellow Kit	540343S



	 YEAR	FITTING POSITION	BODY STYLE & DRIVE TYPE & ENGINE	REMARKS	PRODUCT	GSP Ref.
MERCEDES-BENZ SLK55 AMG						
5.5 (310 kw)	2012.01-	Front Axle Left Lower Inner	Cabriolet RWD 152980		Track Control Arm	S060262
	2012.01-	Front Axle Right Lower Inner	Cabriolet RWD 152980		Track Control Arm	S060263
	2012.01-	Front Axle Left & Right Lower Inner	Cabriolet RWD 152980		Control Arm Bushing	517969
	2012.01-	Front Axle Left & Right Lower Inner	Cabriolet RWD 152980		Control Arm Bushing	518120
	2012.01-	Rear Axle Left & Right Lower	Cabriolet RWD 152980		Control Arm Bushing	511560
	2012.01-	Rear Axle Left & Right Lower Outer	Cabriolet RWD 152980		Control Arm Bushing	512252
	2012.01-	Front Axle Left	Cabriolet RWD 152980		Tie Rod End	S070284
	2012.01-	Front Axle Right	Cabriolet RWD 152980		Tie Rod End	S070285
	2012.01-	Front Axle Left	Cabriolet RWD 152980		Steering Rack Bellow Kit	540204S
	2012.01-	Front Axle Right	Cabriolet RWD 152980	for right-hand drive vehicles	Steering Rack Bellow Kit	540204S
SLS AMG						
6.2 (420 kw)	2010.03-	Front Axle Left	Coupe RWD 159980		Tie Rod End	S070284
	2010.03-	Front Axle Right	Coupe RWD 159980		Tie Rod End	S070285
Sprinter 311D						
2.2 (80 kw)	2000.04-2006.05	Front Axle Left & Right Lower	BUS RWD 611981		Ball Joint	S080144
	2000.04-2006.05	Front Axle Left & Right Lower	VAN RWD 611981		Ball Joint	S080144
	2000.04-2006.05	Front Axle Left & Right Lower	BUS RWD 611981		Control Arm Bushing	516244
	2000.04-2006.05	Front Axle Left & Right Lower	VAN RWD 611981		Control Arm Bushing	516244
	2000.04-2006.05	Front Axle Left & Right	BUS RWD 611981		Tie Rod Axle Joint	S030175
	2000.04-2006.05	Front Axle Left & Right	VAN RWD 611981		Tie Rod Axle Joint	S030175
	2000.04-2006.05	Front Axle Left & Right	BUS RWD 611981		Tie Rod End	S070315
	2000.04-2006.05	Front Axle Left & Right	VAN RWD 611981		Tie Rod End	S070315
	2000.04-2006.05	Front Axle Left	BUS RWD 611981		Rod/Strut, stabiliser	512580
	2000.04-2006.05	Front Axle Left	VAN RWD 611981		Rod/Strut, stabiliser	512580
	2000.04-2006.05	Front Axle Right	BUS RWD 611981		Rod/Strut, stabiliser	512581
	2000.04-2006.05	Front Axle Right	VAN RWD 611981		Rod/Strut, stabiliser	512581
	2000.04-2006.05	Rear Axle Left & Right	BUS RWD 611981		Rod/Strut, stabiliser	S050276
	2000.04-2006.05	Rear Axle Left & Right	VAN RWD 611981		Rod/Strut, stabiliser	S050276
	2000.04-2006.05	Rear Axle Left & Right	BUS RWD 611981	Equipment Vart.:For Brake Adjustment	Rod/Strut, stabiliser	S050308
	2000.04-2006.05	Rear Axle Left & Right	VAN RWD 611981	Equipment Vart.:For Brake Adjustment	Rod/Strut, stabiliser	S050308
	2000.04-2006.05	Front Axle	BUS RWD 611981		Stabiliser Bushing	511550
	2000.04-2006.05	Front Axle	VAN RWD 611981		Stabiliser Bushing	511550
	2000.04-2006.05	Front Axle	BUS RWD 611981		Stabiliser Bushing	511551
	2000.04-2006.05	Front Axle	VAN RWD 611981		Stabiliser Bushing	511551
	2000.04-2006.05	Front Axle	BUS RWD 611981		Stabiliser Bushing	512317
	2000.04-2006.05	Front Axle	VAN RWD 611981		Stabiliser Bushing	512317
	2000.04-2006.05	Front Axle	BUS RWD 611981		Stabiliser Bushing	512317
	2000.04-2006.05	Front Axle	VAN RWD 611981		Stabiliser Bushing	512317
	2000.04-2006.05	Rear Axle	BUS RWD 611981		Stabiliser Bushing	518072
	2000.04-2006.05	Rear Axle	VAN RWD 611981		Stabiliser Bushing	518072
	2000.04-2006.12	Front Axle Left & Right Lower	Platform/Chassis RWD 611981		Ball Joint	S080144
	2000.04-2006.12	Front Axle Left & Right Lower	Platform/Chassis RWD 611981		Control Arm Bushing	516244
	2000.04-2006.12	Front Axle Left & Right	Platform/Chassis RWD 611981		Rod Assembly	S100401
	2000.04-2006.12	Front Axle Left & Right	Platform/Chassis RWD 611981		Tie Rod Axle Joint	S030175
	2000.04-2006.12	Front Axle Left & Right	Platform/Chassis RWD 611981		Tie Rod End	S070315
	2000.04-2006.12	Front Axle Left	Platform/Chassis RWD 611981		Rod/Strut, stabiliser	512580
	2000.04-2006.12	Front Axle Right	Platform/Chassis RWD 611981		Rod/Strut, stabiliser	512581
	2000.04-2006.12	Rear Axle Left & Right	Platform/Chassis RWD 611981		Rod/Strut, stabiliser	S050276
	2000.04-2006.12	Rear Axle Left & Right	Platform/Chassis RWD 611981	Equipment Vart.:For Brake Adjustment	Rod/Strut, stabiliser	S050308
	2000.04-2006.12	Front Axle	Platform/Chassis RWD 611981		Stabiliser Bushing	511550
	2000.04-2006.12	Front Axle	Platform/Chassis RWD 611981		Stabiliser Bushing	511551
	2000.04-2006.12	Front Axle	Platform/Chassis RWD 611981		Stabiliser Bushing	512317
	2000.04-2006.12	Rear Axle	Platform/Chassis RWD 611981		Stabiliser Bushing	518072
2.2 (84 kw)	2016.04-	Front Axle Left Lower	VAN RWD 651955/651956		Track Control Arm	S060854
	2016.04-	Front Axle Right Lower	VAN RWD 651955/651956		Track Control Arm	S060855
	2016.04-	Front Axle Left & Right Lower	VAN RWD 651955/651956		Ball Joint	S080695
	2016.04-	Front Axle Left & Right Lower	VAN RWD 651955/651956		Control Arm Bushing	517996
	2016.04-	Front Axle Left & Right	VAN RWD 651955/651956		Tie Rod Axle Joint	S030168
	2016.04-	Front Axle Left & Right	VAN RWD 651955/651956		Tie Rod End	S070146
	2016.04-	Front Axle Left	VAN RWD 651955/651956		Rod/Strut, stabiliser	S050295
	2016.04-	Front Axle Right	VAN RWD 651955/651956		Rod/Strut, stabiliser	S050296
	2016.04-	Rear Axle Left & Right	VAN RWD 651955/651956		Rod/Strut, stabiliser	S050301
	2016.04-	Rear Axle Left & Right	VAN RWD 651955/651956	Equipment Vart. For Brake Adjustment, for vehicles with Xenon light	Rod/Strut, stabiliser	S050308
	2016.04-	Front Axle	VAN RWD 651955/651956		Stabiliser Bushing	518059
	2016.04-	Front Axle	VAN RWD 651955/651956		Stabiliser Bushing	530131
	2016.04-	Rear Axle	VAN RWD 651955/651956		Stabiliser Bushing	531459



	 YEAR	FITTING POSITION	BODY STYLE & DRIVE TYPE & ENGINE	REMARKS	PRODUCT	GSP Ref.
MERCEDES-BENZ						
Sprinter 313D						
2.2 (95 kw)						
	2009.03-	Front Axle Right	VAN RWD 651955/651956		Rod/Strut,stabiliser	S050296
	2009.03-	Rear Axle Left & Right	VAN RWD 651955/651956		Rod/Strut,stabiliser	S050301
	2009.03-	Rear Axle Left & Right	VAN RWD 651955/651956	Equipment Vari: For Brake Adjustment for vehicles with Xenon light	Rod/Strut,stabiliser	S050308
	2009.03-	Front Axle	VAN RWD 651955/651956		Stabiliser Bushing	518059
	2009.03-	Front Axle	VAN RWD 651955/651956		Stabiliser Bushing	530131
	2009.03-	Rear Axle	VAN RWD 651955/651956	VIN to: E 074955, S 727201	Stabiliser Bushing	511548
	2009.03-	Rear Axle	VAN RWD 651955/651956		Stabiliser Bushing	511548
	2009.03-	Rear Axle	VAN RWD 651955/651956		Stabiliser Bushing	531459
	2009.03-	Front Axle	VAN RWD 651955/651956		Steering Boot	540209
	2009.03-	Front Axle	VAN RWD 651955/651956		Steering Rack Bellow Kit	540209S
	2011.08-	Front Axle Left Lower	BUS RWD 651955/651956/651957		Track Control Arm	S060854
	2011.08-	Front Axle Right Lower	BUS RWD 651955/651956/651957		Track Control Arm	S060855
	2011.08-	Front Axle Left & Right Lower	BUS RWD 651955/651956/651957		Ball Joint	S080695
	2011.08-	Front Axle Left & Right Lower	BUS RWD 651955/651956/651957		Control Arm Bushing	517996
	2011.08-	Front Axle Left & Right	BUS RWD 651955/651956/651957		Tie Rod Axle Joint	S030168
	2011.08-	Front Axle Left & Right	BUS RWD 651955/651956/651957		Tie Rod End	S070146
	2011.08-	Front Axle Left	BUS RWD 651955/651956/651957		Rod/Strut,stabiliser	S050295
	2011.08-	Front Axle Right	BUS RWD 651955/651956/651957		Rod/Strut,stabiliser	S050296
	2011.08-	Rear Axle Left & Right	BUS RWD 651955/651956/651957		Rod/Strut,stabiliser	S050301
	2011.08-	Rear Axle Left & Right	BUS RWD 651955/651956/651957	Equipment Vari: For Brake Adjustment for vehicles with Xenon light	Rod/Strut,stabiliser	S050308
	2011.08-	Front Axle	BUS RWD 651955/651956/651957		Stabiliser Bushing	518059
	2011.08-	Front Axle	BUS RWD 651955/651956/651957		Stabiliser Bushing	530131
	2011.08-	Rear Axle	BUS RWD 651955/651956/651957		Stabiliser Bushing	511548
	2011.08-	Rear Axle	BUS RWD 651955/651956/651957		Stabiliser Bushing	531459
	2011.08-	Front Axle	BUS RWD 651955/651956/651957		Steering Boot	540209
	2011.08-	Front Axle	BUS RWD 651955/651956/651957		Steering Rack Bellow Kit	540209S
Sprinter 314D						
2.2 (105 kw)						
	2018.02-	Front Axle Left Lower	VAN RWD 651958		Track Control Arm	S060854
	2018.02-	Front Axle Left Lower	Platform/Chassis RWD 651958		Track Control Arm	S060854
	2018.02-	Front Axle Right Lower	VAN RWD 651958		Track Control Arm	S060855
	2018.02-	Front Axle Right Lower	Platform/Chassis RWD 651958		Track Control Arm	S060855
	2018.02-	Front Axle Left & Right Lower	VAN RWD 651958		Ball Joint	S080695
	2018.02-	Front Axle Left & Right Lower	VAN RWD 651958		Control Arm Bushing	517996
	2018.02-	Front Axle Left & Right Lower	Platform/Chassis RWD 651958		Control Arm Bushing	517996
	2018.02-	Front Axle Left	VAN RWD 651958		Rod/Strut,stabiliser	S050295
	2018.02-	Front Axle Left	Platform/Chassis RWD 651958		Rod/Strut,stabiliser	S050295
	2018.02-	Front Axle Right	VAN RWD 651958		Rod/Strut,stabiliser	S050296
	2018.02-	Front Axle Right	Platform/Chassis RWD 651958		Rod/Strut,stabiliser	S050296
	2018.02-	Front Axle	VAN RWD 651958		Stabiliser Bushing	518059
	2018.02-	Front Axle	Platform/Chassis RWD 651958		Stabiliser Bushing	518059
	2018.02-	Front Axle	VAN RWD 651958		Stabiliser Bushing	530131
	2018.02-	Front Axle	Platform/Chassis RWD 651958		Stabiliser Bushing	530131
Sprinter 413D						
2.2 (95 kw)						
	2000.04-2006.05	Front Axle Left & Right Lower	VAN RWD 611981		Ball Joint	S080144
	2000.04-2006.05	Front Axle Left & Right Lower	Platform/Chassis RWD 611981		Ball Joint	S080144
	2000.04-2006.05	Front Axle Left & Right Lower	BUS RWD 611981		Ball Joint	S080144
	2000.04-2006.05	Front Axle Left & Right Lower	VAN RWD 611981		Control Arm Bushing	516244
	2000.04-2006.05	Front Axle Left & Right Lower	Platform/Chassis RWD 611981		Control Arm Bushing	516244
	2000.04-2006.05	Front Axle Left & Right Lower	BUS RWD 611981		Control Arm Bushing	516244
	2000.04-2006.05	Front Axle Left & Right	VAN RWD 611981		Rod Assembly	S100401
	2000.04-2006.05	Front Axle Left & Right	Platform/Chassis RWD 611981		Rod Assembly	S100401
	2000.04-2006.05	Front Axle Left & Right	VAN RWD 611981		Tie Rod Axle Joint	S030175
	2000.04-2006.05	Front Axle Left & Right	Platform/Chassis RWD 611981		Tie Rod Axle Joint	S030175
	2000.04-2006.05	Front Axle Left & Right	VAN RWD 611981		Tie Rod End	S070315
	2000.04-2006.05	Front Axle Left & Right	Platform/Chassis RWD 611981		Tie Rod End	S070315
	2000.04-2006.05	Front Axle Left	VAN RWD 611981		Rod/Strut,stabiliser	512580
	2000.04-2006.05	Front Axle Left	Platform/Chassis RWD 611981		Rod/Strut,stabiliser	512580
	2000.04-2006.05	Front Axle Right	VAN RWD 611981		Rod/Strut,stabiliser	512581
	2000.04-2006.05	Front Axle Right	Platform/Chassis RWD 611981		Rod/Strut,stabiliser	512581
	2000.04-2006.05	Rear Axle Left & Right	VAN RWD 611981	Equipment Vari.: For Brake Adjustment	Rod/Strut,stabiliser	S050308
	2000.04-2006.05	Rear Axle Left & Right	Platform/Chassis RWD 611981	Equipment Vari.: For Brake Adjustment	Rod/Strut,stabiliser	S050308
	2000.04-2006.05	Rear Axle Left & Right	BUS RWD 611981		Rod/Strut,stabiliser	S050308
	2000.04-2006.05	Rear Axle Left & Right	VAN RWD 611981		Rod/Strut,stabiliser	S050314
	2000.04-2006.05	Rear Axle Left & Right	Platform/Chassis RWD 611981		Rod/Strut,stabiliser	S050314



	 YEAR	FITTING POSITION	BODY STYLE & DRIVE TYPE & ENGINE	REMARKS	PRODUCT	GSP Ref.
MERCEDES-BENZ						
Sprinter 413D						
2.2 (95 kw)	2000.04-2006.05	Front Axle	VAN RWD 611981		Stabiliser Bushing	511550
	2000.04-2006.05	Front Axle	Platform/Chassis RWD 611981		Stabiliser Bushing	511550
	2000.04-2006.05	Front Axle	VAN RWD 611981		Stabiliser Bushing	512317
	2000.04-2006.05	Front Axle	Platform/Chassis RWD 611981		Stabiliser Bushing	512317
	2000.04-2006.05	Front Axle	BUS RWD 611981		Stabiliser Bushing	512317
	2000.04-2006.05	Rear Axle Left & Right Inner	VAN RWD 611981		Stabiliser Bushing	512319
	2000.04-2006.05	Rear Axle Left & Right Inner	Platform/Chassis RWD 611981		Stabiliser Bushing	512319
	2000.04-2006.05	Rear Axle	VAN RWD 611981		Stabiliser Bushing	530236
	2000.04-2006.05	Rear Axle	Platform/Chassis RWD 611981		Stabiliser Bushing	530236
	2000.04-2006.05	Rear Axle	BUS RWD 611981		Stabiliser Bushing	530236
	2000.04-2006.05	Front Axle	BUS RWD 611981		Steering Rack Bellow Kit	540183S
	2006.06-	Front Axle Left Lower	VAN RWD 651955/651956		Track Control Arm	S060854
	2006.06-	Front Axle Right Lower	VAN RWD 651955/651956		Track Control Arm	S060855
	2006.06-	Front Axle Left & Right Lower	VAN RWD 651955/651956	not for campers, for vehicles with standard suspension	Ball Joint	S080695
	2006.06-	Front Axle Left & Right Lower	VAN RWD 651955/651956	for vehicles with heavy duty suspension	Ball Joint	S080695
	2006.06-	Front Axle Left & Right Lower	VAN RWD 651955/651956		Control Arm Bushing	517996
	2006.06-	Front Axle Left & Right	VAN RWD 651955/651956		Tie Rod Axle Joint	S030168
	2006.06-	Front Axle Left & Right	VAN RWD 651955/651956		Tie Rod End	S070146
	2006.06-	Front Axle Left	VAN RWD 651955/651956		Rod/Strut, stabiliser	S050295
	2006.06-	Front Axle Right	VAN RWD 651955/651956		Rod/Strut, stabiliser	S050296
	2006.06-	Rear Axle Left & Right	VAN RWD 651955/651956		Rod/Strut, stabiliser	S050301
	2006.06-	Rear Axle Left & Right	VAN RWD 651955/651956	Equipment Vari: For Brake Adjustment for vehicles with Xenon light	Rod/Strut, stabiliser	S050308
	2006.06-	Rear Axle Left & Right	VAN RWD 651955/651956	For Brake Adjustment, for vehicles with Xenon light	Rod/Strut, stabiliser	S050308
	2006.06-	Front Axle	VAN RWD 651955/651956		Stabiliser Bushing	518059
	2006.06-	Front Axle	VAN RWD 651955/651956		Stabiliser Bushing	530131
	2006.06-	Rear Axle	VAN RWD 651955/651956		Stabiliser Bushing	511548
	2006.06-	Rear Axle	VAN RWD 651955/651956		Stabiliser Bushing	531459
	2006.06-	Front Axle	VAN RWD 651955/651956		Steering Boot	540209
	2006.06-	Front Axle	VAN RWD 651955/651956		Steering Rack Bellow Kit	540209S
Sprinter 416D						
2.2 (120 kw)	2018.02-	Front Axle Left & Right Lower	VAN RWD 651958		Ball Joint	S080695
	2018.02-	Front Axle Left & Right Lower	Platform/Chassis RWD 651958		Ball Joint	S080695
	2018.02-	Front Axle Left & Right Lower	VAN RWD 651958		Control Arm Bushing	517996
	2018.02-	Front Axle Left & Right Lower	Platform/Chassis RWD 651958		Control Arm Bushing	517996
	2018.02-	Front Axle Left	VAN RWD 651958		Rod/Strut, stabiliser	S050295
	2018.02-	Front Axle Left	Platform/Chassis RWD 651958		Rod/Strut, stabiliser	S050295
	2018.02-	Front Axle Right	VAN RWD 651958		Rod/Strut, stabiliser	S050296
	2018.02-	Front Axle Right	Platform/Chassis RWD 651958		Rod/Strut, stabiliser	S050296
Sprinter 516D						
2.2 (120 kw)	2018.02-	Front Axle Left Lower	VAN RWD 651958		Track Control Arm	S060854
	2018.02-	Front Axle Left Lower	Platform/Chassis RWD 651958		Track Control Arm	S060854
	2018.02-	Front Axle Right Lower	VAN RWD 651958		Track Control Arm	S060855
	2018.02-	Front Axle Right Lower	Platform/Chassis RWD 651958		Track Control Arm	S060855
	2018.02-	Front Axle Left & Right Lower	VAN RWD 651958		Ball Joint	S080695
	2018.02-	Front Axle Left & Right Lower	Platform/Chassis RWD 651958		Ball Joint	S080695
	2018.02-	Front Axle Left & Right Lower	VAN RWD 651958		Control Arm Bushing	517996
	2018.02-	Front Axle Left & Right Lower	Platform/Chassis RWD 651958		Control Arm Bushing	517996
	2018.02-	Front Axle Left	VAN RWD 651958		Rod/Strut, stabiliser	S050295
	2018.02-	Front Axle Left	Platform/Chassis RWD 651958		Rod/Strut, stabiliser	S050295
	2018.02-	Front Axle Right	VAN RWD 651958		Rod/Strut, stabiliser	S050296
	2018.02-	Front Axle Right	Platform/Chassis RWD 651958		Rod/Strut, stabiliser	S050296
	2018.02-	Front Axle	VAN RWD 651958		Stabiliser Bushing	518059
	2018.02-	Front Axle	Platform/Chassis RWD 651958		Stabiliser Bushing	518059
	2018.02-	Front Axle	VAN RWD 651958		Stabiliser Bushing	530131
	2018.02-	Front Axle	Platform/Chassis RWD 651958		Stabiliser Bushing	530131
Vito 111						
1.6 (84 kw)	2014.09-	Front Axle Left & Right	VAN FWD 622951		Rod/Strut, stabiliser	S051481
	2014.09-	Rear Axle Left & Right	VAN FWD 622951		Rod/Strut, stabiliser	S051434
	2014.09-	Rear Axle Left & Right	VAN FWD 622951	for pneumatic suspension vehicles	Rod/Strut, stabiliser	S051434
MINI						
Mini Clubman						
1.6 (128 kw)	2007.08-2010.07	Front Axle Left Lower	Estate FWD N14B16A/N14B16AB		Track Control Arm	S060809
	2007.08-2010.07	Front Axle Right Lower	Estate FWD N14B16A/N14B16AB		Track Control Arm	S060810
	2007.08-2010.07	Front Axle Left Lower	Estate FWD N14B16A/N14B16AB		Ball Joint	S080286



	 YEAR	FITTING POSITION	BODY STYLE & DRIVE TYPE & ENGINE	REMARKS	PRODUCT	GSP Ref.
MINI						
Mini Clubman						
1.6 (128 kw)	2007.08-2010.07	Front Axle Right Lower	Estate FWD N14B16A/N14B16AB		Ball Joint	S080287
	2007.08-2010.07	Front Axle Left Lower	Estate FWD N14B16A/N14B16AB		Control Arm Bushing	535142
	2007.08-2010.07	Front Axle Right Lower	Estate FWD N14B16A/N14B16AB		Control Arm Bushing	535143
	2007.08-2010.07	Front Axle Left	Estate FWD N14B16A/N14B16AB		Tie Rod End	S070552
	2007.08-2010.07	Front Axle Right	Estate FWD N14B16A/N14B16AB		Tie Rod End	S070553
	2007.08-2010.07	Front Axle Left & Right	Estate FWD N14B16A/N14B16AB		Rod/Strut, stabiliser	S050475
	2007.08-2010.07	Rear Axle Left & Right	Estate FWD N14B16A/N14B16AB		Rod/Strut, stabiliser	S050476
	2007.08-2010.07	Front Axle	Estate FWD N14B16A/N14B16AB		Steering Boot	541033
	2007.08-2010.07	Front Axle	Estate FWD N14B16A/N14B16AB	The main part is 541033	Steering Rack Bellow Kit	541033S
1.6 (135 kw)	2010.03-2014.06	Front Axle Left Lower	Estate FWD N18B16A		Track Control Arm	S060809
	2010.03-2014.06	Front Axle Right Lower	Estate FWD N18B16A		Track Control Arm	S060810
	2010.03-2014.06	Front Axle Left Lower	Estate FWD N18B16A		Ball Joint	S080286
	2010.03-2014.06	Front Axle Right Lower	Estate FWD N18B16A		Ball Joint	S080287
	2010.03-2014.06	Front Axle Left Lower	Estate FWD N18B16A		Control Arm Bushing	535142
	2010.03-2014.06	Front Axle Right Lower	Estate FWD N18B16A		Control Arm Bushing	535143
	2010.03-2014.06	Front Axle Left	Estate FWD N18B16A		Tie Rod End	S070552
	2010.03-2014.06	Front Axle Right	Estate FWD N18B16A		Tie Rod End	S070553
	2010.03-2014.06	Front Axle Left & Right	Estate FWD N18B16A		Rod/Strut, stabiliser	S050475
	2010.03-2014.06	Rear Axle Left & Right	Estate FWD N18B16A		Rod/Strut, stabiliser	S050476
	2010.03-2014.06	Front Axle	Estate FWD N18B16A		Steering Boot	541033
2010.03-2014.06	Front Axle	Estate FWD N18B16A	The main part is 541033	Steering Rack Bellow Kit	541033S	
2.0 (141 kw)	2014.11-	Rear Axle Left & Right Lower	Estate FWD B46A20A/B48A20A/B48A20F		Track Control Arm	S062800
	2014.11-	Rear Axle Left & Right Upper	Estate FWD B46A20A/B48A20A/B48A20F		Track Control Arm	S063055
	2014.11-	Front Axle Left	Estate FWD B46A20A/B48A20A/B48A20F		Rod Assembly	S100410
	2014.11-	Front Axle Right	Estate FWD B46A20A/B48A20A/B48A20F		Rod Assembly	S100409
	2014.11-	Front Axle Left & Right	Estate FWD B46A20A/B48A20A/B48A20F		Tie Rod Axle Joint	S030988
	2014.11-	Front Axle Left & Right	Estate FWD B46A20A/B48A20A/B48A20F		Rod/Strut, stabiliser	S051334
	2014.11-	Rear Axle Left & Right	Estate FWD B46A20A/B48A20A/B48A20F		Rod/Strut, stabiliser	S051243
2.0 (225 kw)	2019.07-	Rear Axle Left & Right Lower	Estate 4WD B48A20E		Track Control Arm	S062800
	2019.07-	Front Axle Left	Estate 4WD B48A20E		Rod Assembly	S100410
	2019.07-	Front Axle Right	Estate 4WD B48A20E		Rod Assembly	S100409
	2019.07-	Front Axle Left & Right	Estate 4WD B48A20E		Tie Rod Axle Joint	S030988
	2019.07-	Front Axle Left & Right	Estate 4WD B48A20E		Rod/Strut, stabiliser	S051334
2019.07-	Rear Axle Left & Right	Estate 4WD B48A20E		Rod/Strut, stabiliser	S051243	
Mini Cooper						
1.5 (100 kw)	2013.12-	Front Axle Left Lower	Hatchback FWD B38A15A		Track Control Arm	S063044
	2013.12-	Front Axle Right Lower	Hatchback FWD B38A15A		Track Control Arm	S063045
	2013.12-	Rear Axle Left & Right Lower	Hatchback FWD B38A15A		Track Control Arm	S062800
	2013.12-	Rear Axle Left & Right Upper	Hatchback FWD B38A15A		Track Control Arm	S063055
	2013.12-	Front Axle Left	Hatchback FWD B38A15A		Rod Assembly	S100407
	2013.12-	Front Axle Right	Hatchback FWD B38A15A		Rod Assembly	S100408
	2013.12-	Front Axle Left & Right	Hatchback FWD B38A15A		Tie Rod Axle Joint	S030951
	2013.12-	Front Axle Left & Right	Hatchback FWD B38A15A	Date from:2013.12	Tie Rod Axle Joint	S030951
	2013.12-	Front Axle Left	Hatchback FWD B38A15A		Tie Rod End	S071652
	2013.12-	Front Axle Right	Hatchback FWD B38A15A		Tie Rod End	S071651
	2013.12-	Front Axle Left & Right	Hatchback FWD B38A15A		Rod/Strut, stabiliser	S051242
	2013.12-	Rear Axle Left & Right	Hatchback FWD B38A15A		Rod/Strut, stabiliser	S051243
	1.6 (88 kw)	2006.11-2012.02	Front Axle Left Lower	Hatchback FWD N12B16A		Track Control Arm
2006.11-2012.02		Front Axle Right Lower	Hatchback FWD N12B16A		Track Control Arm	S060810
2006.11-2012.02		Front Axle Left Lower	Hatchback FWD N12B16A		Ball Joint	S080286
2006.11-2012.02		Front Axle Right Lower	Hatchback FWD N12B16A		Ball Joint	S080287
2006.11-2012.02		Front Axle Left Lower	Hatchback FWD N12B16A		Control Arm Bushing	535142
2006.11-2012.02		Front Axle Right Lower	Hatchback FWD N12B16A		Control Arm Bushing	535143
2006.11-2012.02		Front Axle Left	Hatchback FWD N12B16A		Tie Rod End	S070552
2006.11-2012.02		Front Axle Right	Hatchback FWD N12B16A		Tie Rod End	S070553
2006.11-2012.02		Front Axle Left & Right	Hatchback FWD N12B16A		Rod/Strut, stabiliser	S050475
2006.11-2012.02		Rear Axle Left & Right	Hatchback FWD N12B16A		Rod/Strut, stabiliser	S050476
2006.11-2012.02		Front Axle	Hatchback FWD N12B16A		Steering Boot	541033
2006.11-2012.02		Front Axle	Hatchback FWD N12B16A	The main part is 541033	Steering Rack Bellow Kit	541033S
2008.12-2010.07		Front Axle Left Lower	Cabriolet FWD N12B16A		Track Control Arm	S060809
2008.12-2010.07		Front Axle Right Lower	Cabriolet FWD N12B16A		Track Control Arm	S060810
2008.12-2010.07		Front Axle Left Lower	Cabriolet FWD N12B16A		Ball Joint	S080286
2008.12-2010.07		Front Axle Right Lower	Cabriolet FWD N12B16A		Ball Joint	S080287
2008.12-2010.07		Front Axle Left Lower	Cabriolet FWD N12B16A		Control Arm Bushing	535142



	 YEAR	FITTING POSITION	BODY STYLE & DRIVE TYPE & ENGINE	REMARKS	PRODUCT	GSP Ref.	
MINI							
Mini Cooper							
1.6 (88 kw)	2008.12-2010.07	Front Axle Right Lower	Cabriolet FWD N12B16A		Control Arm Bushing	535143	
	2008.12-2010.07	Front Axle Left	Cabriolet FWD N12B16A		Tie Rod End	S070552	
	2008.12-2010.07	Front Axle Right	Cabriolet FWD N12B16A		Tie Rod End	S070553	
	2008.12-2010.07	Front Axle Left & Right	Cabriolet FWD N12B16A		Rod/Strut, stabiliser	S050475	
	2008.12-2010.07	Rear Axle Left & Right	Cabriolet FWD N12B16A		Rod/Strut, stabiliser	S050476	
	2008.12-2010.07	Front Axle	Cabriolet FWD N12B16A		Steering Boot	541033	
	2008.12-2010.07	Front Axle	Cabriolet FWD N12B16A	The main part is 541033	Steering Rack Bellow Kit	541033S	
1.6 (128 kw)	2006.11-2011.01	Front Axle Left Lower	Hatchback FWD N14B16A/N14B16AB		Track Control Arm	S060809	
	2006.11-2011.01	Front Axle Right Lower	Hatchback FWD N14B16A/N14B16AB		Track Control Arm	S060810	
	2006.11-2011.01	Front Axle Left Lower	Hatchback FWD N14B16A/N14B16AB		Ball Joint	S080286	
	2006.11-2011.01	Front Axle Right Lower	Hatchback FWD N14B16A/N14B16AB		Ball Joint	S080287	
	2006.11-2011.01	Front Axle Left Lower	Hatchback FWD N14B16A/N14B16AB		Control Arm Bushing	535142	
	2006.11-2011.01	Front Axle Right Lower	Hatchback FWD N14B16A/N14B16AB		Control Arm Bushing	535143	
	2006.11-2011.01	Front Axle Left	Hatchback FWD N14B16A/N14B16AB		Tie Rod End	S070552	
	2006.11-2011.01	Front Axle Right	Hatchback FWD N14B16A/N14B16AB		Tie Rod End	S070553	
	2006.11-2011.01	Front Axle Left & Right	Hatchback FWD N14B16A/N14B16AB		Rod/Strut, stabiliser	S050475	
	2006.11-2011.01	Rear Axle Left & Right	Hatchback FWD N14B16A/N14B16AB		Rod/Strut, stabiliser	S050476	
	2006.11-2011.01	Front Axle	Hatchback FWD N14B16A/N14B16AB		Steering Boot	541033	
	2006.11-2011.01	Front Axle	Hatchback FWD N14B16A/N14B16AB	The main part is 541033	Steering Rack Bellow Kit	541033S	
	1.6 (135 kw)	2010.03-2013.11	Front Axle Left Lower	Hatchback FWD N18B16A		Track Control Arm	S060809
2010.03-2013.11		Front Axle Right Lower	Hatchback FWD N18B16A		Track Control Arm	S060810	
2010.03-2013.11		Front Axle Left Lower	Hatchback FWD N18B16A		Ball Joint	S080286	
2010.03-2013.11		Front Axle Right Lower	Hatchback FWD N18B16A		Ball Joint	S080287	
2010.03-2013.11		Front Axle Left Lower	Hatchback FWD N18B16A		Control Arm Bushing	535142	
2010.03-2013.11		Front Axle Right Lower	Hatchback FWD N18B16A		Control Arm Bushing	535143	
2010.03-2013.11		Front Axle Left	Hatchback FWD N18B16A		Tie Rod End	S070552	
2010.03-2013.11		Front Axle Right	Hatchback FWD N18B16A		Tie Rod End	S070553	
2010.03-2013.11		Front Axle Left & Right	Hatchback FWD N18B16A		Rod/Strut, stabiliser	S050475	
2010.03-2013.11		Rear Axle Left & Right	Hatchback FWD N18B16A		Rod/Strut, stabiliser	S050476	
2010.03-2013.11		Front Axle	Hatchback FWD N18B16A		Steering Boot	541033	
2010.03-2013.11		Front Axle	Hatchback FWD N18B16A	The main part is 541033	Steering Rack Bellow Kit	541033S	
2010.03-2014.12		Front Axle Left Lower	Cabriolet FWD N18B16A		Track Control Arm	S060809	
2010.03-2014.12		Front Axle Right Lower	Cabriolet FWD N18B16A		Track Control Arm	S060810	
2010.03-2014.12		Front Axle Left Lower	Cabriolet FWD N18B16A		Ball Joint	S080286	
2010.03-2014.12		Front Axle Right Lower	Cabriolet FWD N18B16A		Ball Joint	S080287	
2010.03-2014.12		Front Axle Left Lower	Cabriolet FWD N18B16A		Control Arm Bushing	535142	
2010.03-2014.12		Front Axle Right Lower	Cabriolet FWD N18B16A		Control Arm Bushing	535143	
2010.03-2014.12		Front Axle Left	Cabriolet FWD N18B16A		Tie Rod End	S070552	
2010.03-2014.12		Front Axle Right	Cabriolet FWD N18B16A		Tie Rod End	S070553	
2010.03-2014.12		Front Axle Left & Right	Cabriolet FWD N18B16A		Rod/Strut, stabiliser	S050475	
2010.03-2014.12		Rear Axle Left & Right	Cabriolet FWD N18B16A		Rod/Strut, stabiliser	S050476	
2010.03-2014.12	Front Axle	Cabriolet FWD N18B16A		Steering Boot	541033		
2010.03-2014.12	Front Axle	Cabriolet FWD N18B16A	The main part is 541033	Steering Rack Bellow Kit	541033S		
1.6 (155 kw)	2008.03-2013.11	Front Axle Left Lower	Hatchback FWD N14B16C/N18B16C		Track Control Arm	S060809	
	2008.03-2013.11	Front Axle Right Lower	Hatchback FWD N14B16C/N18B16C		Track Control Arm	S060810	
	2008.03-2013.11	Front Axle Left Lower	Hatchback FWD N14B16C/N18B16C		Ball Joint	S080286	
	2008.03-2013.11	Front Axle Right Lower	Hatchback FWD N14B16C/N18B16C		Ball Joint	S080287	
	2008.03-2013.11	Front Axle Left & Right Lower	Hatchback FWD N14B16C/N18B16C		Control Arm Bushing	519364	
	2008.03-2013.11	Front Axle Left	Hatchback FWD N14B16C/N18B16C		Tie Rod End	S070552	
	2008.03-2013.11	Front Axle Right	Hatchback FWD N14B16C/N18B16C		Tie Rod End	S070553	
	2008.03-2013.11	Front Axle Left & Right	Hatchback FWD N14B16C/N18B16C		Rod/Strut, stabiliser	S050475	
	2008.03-2013.11	Rear Axle Left & Right	Hatchback FWD N14B16C/N18B16C		Rod/Strut, stabiliser	S050476	
	2008.03-2013.11	Front Axle	Hatchback FWD N14B16C/N18B16C		Steering Boot	541033	
	2008.03-2013.11	Front Axle	Hatchback FWD N14B16C/N18B16C	The main part is 541033	Steering Rack Bellow Kit	541033S	
	2.0 (141 kw)	2013.12-	Front Axle Left Lower	Hatchback FWD B46A20A/B48A20A		Track Control Arm	S063044
		2013.12-	Front Axle Right Lower	Hatchback FWD B46A20A/B48A20A		Track Control Arm	S063045
2013.12-		Rear Axle Left & Right Lower	Hatchback FWD B46A20A/B48A20A		Track Control Arm	S062800	
2013.12-		Rear Axle Left & Right Upper	Hatchback FWD B46A20A/B48A20A		Track Control Arm	S063055	
2013.12-		Front Axle Left	Hatchback FWD B46A20A/B48A20A		Rod Assembly	S100407	
2013.12-		Front Axle Right	Hatchback FWD B46A20A/B48A20A	Engine Code: B46 A20 A	Rod Assembly	S100408	
2013.12-		Front Axle Right	Hatchback FWD B46A20A/B48A20A		Rod Assembly	S100408	
2013.12-		Front Axle Left & Right	Hatchback FWD B46A20A/B48A20A		Tie Rod Axle Joint	S030951	
2013.12-		Front Axle Left & Right	Hatchback FWD B46A20A/B48A20A	Date from:2013.12	Tie Rod Axle Joint	S030951	
2013.12-		Front Axle Left	Hatchback FWD B46A20A/B48A20A		Tie Rod End	S071652	



	 YEAR	FITTING POSITION	BODY STYLE & DRIVE TYPE & ENGINE	REMARKS	PRODUCT	GSP Ref.	
MINI							
Mini Cooper							
2.0 (141 kw)	2013.12-	Front Axle Right	Hatchback FWD B46A20A/B48A20A		Tie Rod End	S071651	
	2013.12-	Front Axle Left & Right	Hatchback FWD B46A20A/B48A20A		Rod/Strut, stabiliser	S051242	
	2013.12-	Rear Axle Left & Right	Hatchback FWD B46A20A/B48A20A		Rod/Strut, stabiliser	S051243	
	2015.11-	Front Axle Left Lower	Cabriolet FWD B46A20A/B48A20A		Track Control Arm	S063044	
	2015.11-	Front Axle Right Lower	Cabriolet FWD B46A20A/B48A20A		Track Control Arm	S063045	
	2015.11-	Rear Axle Left & Right Lower	Cabriolet FWD B46A20A/B48A20A		Track Control Arm	S062800	
	2015.11-	Rear Axle Left & Right Upper	Cabriolet FWD B46A20A/B48A20A		Track Control Arm	S063055	
	2015.11-	Front Axle Left	Cabriolet FWD B46A20A/B48A20A		Rod Assembly	S100407	
	2015.11-	Front Axle Right	Cabriolet FWD B46A20A/B48A20A		Rod Assembly	S100408	
	2015.11-	Front Axle Left & Right	Cabriolet FWD B46A20A/B48A20A		Tie Rod Axle Joint	S030951	
	2015.11-	Front Axle Left	Cabriolet FWD B46A20A/B48A20A		Tie Rod End	S071652	
	2015.11-	Front Axle Right	Cabriolet FWD B46A20A/B48A20A		Tie Rod End	S071651	
	2015.11-	Front Axle Left & Right	Cabriolet FWD B46A20A/B48A20A		Rod/Strut, stabiliser	S051242	
	2015.11-	Rear Axle Left & Right	Cabriolet FWD B46A20A/B48A20A		Rod/Strut, stabiliser	S051243	
2.0 (170 kw)	2015.03-	Front Axle Left Lower	Hatchback FWD B46A20B/B48A20B		Track Control Arm	S063044	
	2015.03-	Front Axle Right Lower	Hatchback FWD B46A20B/B48A20B		Track Control Arm	S063045	
	2015.03-	Rear Axle Left & Right Lower	Hatchback FWD B46A20B/B48A20B		Track Control Arm	S062800	
	2015.03-	Rear Axle Left & Right Upper	Hatchback FWD B46A20B/B48A20B		Track Control Arm	S063055	
	2015.03-	Front Axle Left	Hatchback FWD B46A20B/B48A20B		Rod Assembly	S100407	
	2015.03-	Front Axle Right	Hatchback FWD B46A20B/B48A20B		Rod Assembly	S100408	
	2015.03-	Front Axle Left & Right	Hatchback FWD B46A20B/B48A20B		Tie Rod Axle Joint	S030951	
	2015.03-	Front Axle Left	Hatchback FWD B46A20B/B48A20B		Tie Rod End	S071652	
	2015.03-	Front Axle Right	Hatchback FWD B46A20B/B48A20B	Engine code: B48 A20 B	Tie Rod End	S071651	
	2015.03-	Front Axle Right	Hatchback FWD B46A20B/B48A20B		Tie Rod End	S071651	
	2015.03-	Front Axle Left & Right	Hatchback FWD B46A20B/B48A20B		Rod/Strut, stabiliser	S051242	
	2015.03-	Rear Axle Left & Right	Hatchback FWD B46A20B/B48A20B		Rod/Strut, stabiliser	S051243	
	Mini Countryman						
	1.5 (100 kw)	2016.10-	Rear Axle Left & Right Upper	Estate FWD B36A15A/B38A15A/B38A15F		Track Control Arm	S063055
2016.10-		Front Axle Left & Right	Estate FWD B36A15A/B38A15A/B38A15F		Tie Rod Axle Joint	S030988	
2016.10-		Front Axle Left & Right	Estate FWD B36A15A/B38A15A/B38A15F		Rod/Strut, stabiliser	S051334	
2016.10-		Rear Axle Left & Right	Estate FWD B36A15A/B38A15A/B38A15F		Rod/Strut, stabiliser	S051243	
2017.01-		Rear Axle Left & Right Upper	Estate 4WD B38A15A		Track Control Arm	S063055	
2017.01-		Front Axle Left	Estate 4WD B38A15A		Rod Assembly	S100410	
2017.01-		Front Axle Right	Estate 4WD B38A15A		Rod Assembly	S100409	
2017.01-		Front Axle Left & Right	Estate 4WD B38A15A		Tie Rod Axle Joint	S030988	
2017.01-		Front Axle Left & Right	Estate 4WD B38A15A		Rod/Strut, stabiliser	S051334	
2017.01-		Rear Axle Left & Right	Estate 4WD B38A15A		Rod/Strut, stabiliser	S051243	
1.6 (88 kw)	2010.08-2016.10	Front Axle Left Lower	Estate FWD N16B16A		Track Control Arm	S062068	
	2010.08-2016.10	Front Axle Right Lower	Estate FWD N16B16A		Track Control Arm	S062069	
	2010.08-2016.10	Front Axle Left	Estate FWD N16B16A		Rod Assembly	S100390	
	2010.08-2016.10	Front Axle Right	Estate FWD N16B16A		Rod Assembly	S100391	
	2010.08-2016.10	Front Axle	Estate FWD N16B16A		Steering Boot	541033	
	2010.08-2016.10	Front Axle	Estate FWD N16B16A	The main part is 541033	Steering Rack Bellow Kit	541033S	
1.6 (135 kw)	2010.08-2016.10	Front Axle Left Lower	Estate 4WD N18B16A		Track Control Arm	S062068	
	2010.08-2016.10	Front Axle Left Lower	Estate FWD N18B16A		Track Control Arm	S062068	
	2010.08-2016.10	Front Axle Right Lower	Estate 4WD N18B16A		Track Control Arm	S062069	
	2010.08-2016.10	Front Axle Right Lower	Estate FWD N18B16A		Track Control Arm	S062069	
	2010.08-2016.10	Front Axle Left	Estate 4WD N18B16A		Rod Assembly	S100390	
	2010.08-2016.10	Front Axle Left	Estate FWD N18B16A		Rod Assembly	S100390	
	2010.08-2016.10	Front Axle Right	Estate 4WD N18B16A		Rod Assembly	S100391	
	2010.08-2016.10	Front Axle Right	Estate FWD N18B16A		Rod Assembly	S100391	
	2010.08-2016.10	Front Axle	Estate 4WD N18B16A		Steering Boot	541033	
	2010.08-2016.10	Front Axle	Estate FWD N18B16A		Steering Boot	541033	
	2010.08-2016.10	Front Axle	Estate 4WD N18B16A	The main part is 541033	Steering Rack Bellow Kit	541033S	
	2010.08-2016.10	Front Axle	Estate FWD N18B16A	The main part is 541033	Steering Rack Bellow Kit	541033S	
1.6 (160 kw)	2012.11-2016.10	Front Axle Left Lower	Estate 4WD N18B16C		Track Control Arm	S062068	
	2012.11-2016.10	Front Axle Right Lower	Estate 4WD N18B16C		Track Control Arm	S062069	
	2012.11-2016.10	Front Axle	Estate 4WD N18B16C		Steering Boot	541033	
	2012.11-2016.10	Front Axle	Estate 4WD N18B16C	The main part is 541033	Steering Rack Bellow Kit	541033S	
2.0 (141 kw)	2016.10-	Rear Axle Left & Right Upper	Estate FWD B46A20A/B48A20A		Track Control Arm	S063055	
	2016.10-	Rear Axle Left & Right Upper	Estate 4WD B46A20A/B48A20A		Track Control Arm	S063055	
	2016.10-	Front Axle Left & Right	Estate FWD B46A20A/B48A20A		Tie Rod Axle Joint	S030988	
	2016.10-	Front Axle Left & Right	Estate 4WD B46A20A/B48A20A		Tie Rod Axle Joint	S030988	
	2016.10-	Front Axle Left & Right	Estate FWD B46A20A/B48A20A		Rod/Strut, stabiliser	S051334	

	 YEAR	FITTING POSITION	BODY STYLE & DRIVE TYPE & ENGINE	REMARKS	PRODUCT	GSP Ref.	
MINI							
Mini Countryman							
2.0 (141 kw)	2016.10-	Front Axle Left & Right	Estate 4WD B46A20A/B48A20A		Rod/Strut, stabiliser	S051334	
	2016.10-	Rear Axle Left & Right	Estate FWD B46A20A/B48A20A		Rod/Strut, stabiliser	S051243	
	2016.10-	Rear Axle Left & Right	Estate 4WD B46A20A/B48A20A		Rod/Strut, stabiliser	S051243	
2.0 (170 kw)	2017.01-2019.06	Rear Axle Left & Right Upper	Estate 4WD B48A20B		Track Control Arm	S063055	
	2017.01-2019.06	Front Axle Left	Estate 4WD B48A20B		Rod Assembly	S100410	
	2017.01-2019.06	Front Axle Right	Estate 4WD B48A20B		Rod Assembly	S100409	
	2017.01-2019.06	Front Axle Left & Right	Estate 4WD B48A20B		Tie Rod Axle Joint	S030988	
	2017.01-2019.06	Front Axle Left & Right	Estate 4WD B48A20B		Rod/Strut, stabiliser	S051334	
	2017.01-2019.06	Rear Axle Left & Right	Estate 4WD B48A20B		Rod/Strut, stabiliser	S051243	
Mini Coupe							
1.6 (135 kw)	2011.09-	Front Axle Left Lower	Coupe FWD N18B16A		Track Control Arm	S060809	
	2011.09-	Front Axle Right Lower	Coupe FWD N18B16A		Track Control Arm	S060810	
	2011.09-	Front Axle Left Lower	Coupe FWD N18B16A		Ball Joint	S080286	
	2011.09-	Front Axle Left Lower	Coupe FWD N18B16A		Control Arm Bushing	535142	
	2011.09-	Front Axle Right Lower	Coupe FWD N18B16A		Control Arm Bushing	535143	
	2011.09-	Front Axle Left	Coupe FWD N18B16A		Tie Rod End	S070552	
	2011.09-	Front Axle Right	Coupe FWD N18B16A		Tie Rod End	S070553	
	2011.09-	Front Axle Left & Right	Coupe FWD N18B16A		Rod/Strut, stabiliser	S050475	
	2011.09-	Rear Axle Left & Right	Coupe FWD N18B16A		Rod/Strut, stabiliser	S050476	
	2011.09-	Front Axle	Coupe FWD N18B16A		Steering Boot	541033	
	2011.09-	Front Axle	Coupe FWD N18B16A	The main part is 541033	Steering Rack Bellow Kit	541033S	
Mini One							
1.2 (75 kw)	2014.03-2017.10	Front Axle Left Lower	Hatchback FWD B38A12A		Track Control Arm	S063044	
	2014.03-2017.10	Front Axle Right Lower	Hatchback FWD B38A12A		Track Control Arm	S063045	
	2014.03-2017.10	Rear Axle Left & Right Lower	Hatchback FWD B38A12A		Track Control Arm	S062800	
	2014.03-2017.10	Rear Axle Left & Right Upper	Hatchback FWD B38A12A		Track Control Arm	S063055	
	2014.03-2017.10	Front Axle Left	Hatchback FWD B38A12A		Rod Assembly	S100407	
	2014.03-2017.10	Front Axle Right	Hatchback FWD B38A12A		Rod Assembly	S100408	
	2014.03-2017.10	Front Axle Left & Right	Hatchback FWD B38A12A		Tie Rod Axle Joint	S030951	
	2014.03-2017.10	Front Axle Left	Hatchback FWD B38A12A		Tie Rod End	S071652	
	2014.03-2017.10	Front Axle Right	Hatchback FWD B38A12A		Tie Rod End	S071651	
	2014.03-2017.10	Front Axle Left & Right	Hatchback FWD B38A12A		Rod/Strut, stabiliser	S051242	
	2014.03-2017.10	Rear Axle Left & Right	Hatchback FWD B38A12A		Rod/Strut, stabiliser	S051243	
	1.6 (72 kw)	2010.03-2013.11	Front Axle Left Lower	Hatchback FWD N16B16A		Track Control Arm	S060809
		2010.03-2013.11	Front Axle Right Lower	Hatchback FWD N16B16A		Track Control Arm	S060810
		2010.03-2013.11	Front Axle Left Lower	Hatchback FWD N16B16A		Ball Joint	S080286
2010.03-2013.11		Front Axle Right Lower	Hatchback FWD N16B16A		Ball Joint	S080287	
2010.03-2013.11		Front Axle Left Lower	Hatchback FWD N16B16A		Control Arm Bushing	535142	
2010.03-2013.11		Front Axle Right Lower	Hatchback FWD N16B16A		Control Arm Bushing	535143	
2010.03-2013.11		Front Axle Left	Hatchback FWD N16B16A		Tie Rod End	S070552	
2010.03-2013.11		Front Axle Right	Hatchback FWD N16B16A		Tie Rod End	S070553	
2010.03-2013.11		Front Axle Left & Right	Hatchback FWD N16B16A		Rod/Strut, stabiliser	S050475	
2010.03-2013.11		Rear Axle Left & Right	Hatchback FWD N16B16A		Rod/Strut, stabiliser	S050476	
	2010.03-2013.11	Front Axle	Hatchback FWD N16B16A		Steering Boot	541033	
	2010.03-2013.11	Front Axle	Hatchback FWD N16B16A	The main part is 541033	Steering Rack Bellow Kit	541033S	
Mini Paceman							
1.6 (135 kw)	2012.11-2016.10	Front Axle Left Lower	Coupe FWD N18B16A		Track Control Arm	S062068	
	2012.11-2016.10	Front Axle Right Lower	Coupe FWD N18B16A		Track Control Arm	S062069	
	2012.11-2016.10	Front Axle	Coupe FWD N18B16A		Steering Boot	541033	
	2012.11-2016.10	Front Axle	Coupe FWD N18B16A	The main part is 541033	Steering Rack Bellow Kit	541033S	
	2013.01-2016.09	Front Axle Left Lower	Coupe 4WD N18B16A		Track Control Arm	S062068	
	2013.01-2016.09	Front Axle Right Lower	Coupe 4WD N18B16A		Track Control Arm	S062069	
	2013.01-2016.09	Front Axle	Coupe 4WD N18B16A		Steering Boot	541033	
	2013.01-2016.09	Front Axle	Coupe 4WD N18B16A	The main part is 541033	Steering Rack Bellow Kit	541033S	
1.6 (160 kw)	2013.01-2016.10	Front Axle Left Lower	Coupe 4WD N18B16C		Track Control Arm	S062068	
	2013.01-2016.10	Front Axle Right Lower	Coupe 4WD N18B16C		Track Control Arm	S062069	
	2013.01-2016.10	Front Axle	Coupe 4WD N18B16C		Steering Boot	541033	
	2013.01-2016.10	Front Axle	Coupe 4WD N18B16C	The main part is 541033	Steering Rack Bellow Kit	541033S	
Mini Roadster							
1.6 (135 kw)	2012.02-	Front Axle Left Lower	Cabriolet FWD N18B16A		Track Control Arm	S060809	
	2012.02-	Front Axle Right Lower	Cabriolet FWD N18B16A		Track Control Arm	S060810	
	2012.02-	Front Axle Left Lower	Cabriolet FWD N18B16A		Ball Joint	S080286	
	2012.02-	Front Axle Left Lower	Cabriolet FWD N18B16A		Control Arm Bushing	535142	
	2012.02-	Front Axle Right Lower	Cabriolet FWD N18B16A		Control Arm Bushing	535143	



	 YEAR	FITTING POSITION	BODY STYLE & DRIVE TYPE & ENGINE	REMARKS	PRODUCT	GSP Ref.
MINI Mini Roadster						
1.6 (135 kw)	2012.02-	Front Axle Left	Cabriolet FWD N18B16A		Tie Rod End	S070552
	2012.02-	Front Axle Right	Cabriolet FWD N18B16A		Tie Rod End	S070553
	2012.02-	Front Axle Left & Right	Cabriolet FWD N18B16A		Rod/Strut, stabiliser	S050475
	2012.02-	Rear Axle Left & Right	Cabriolet FWD N18B16A		Rod/Strut, stabiliser	S050476
	2012.02-	Front Axle	Cabriolet FWD N18B16A		Steering Boot	541033
	2012.02-	Front Axle	Cabriolet FWD N18B16A	The main part is 541033	Steering Rack Bellow Kit	541033S
MITSUBISHI 3000 GT						
3.0 (210 kw)	1992.06-1999.06	Front Axle Left & Right	Coupe 4WD 6G72DOHCT		Tie Rod Axle Joint	S030590
	1992.06-1999.06	Front Axle Right	Coupe 4WD 6G72DOHCT		Tie Rod End	S071686
	1992.06-1999.06	Front Axle Left & Right	Coupe 4WD 6G72DOHCT		Tie Rod End	S070210
	1992.06-1999.06	Front Axle Left & Right	Coupe 4WD 6G72DOHCT		Rod/Strut, stabiliser	S050225
	1992.06-1999.06	Front Axle	Coupe 4WD 6G72DOHCT		Steering Boot	540178
Challenger						
2.8 (92 kw)	1996.07-2003.10	Front Axle Left Lower	Terrain cab wagon closed 4WD 4M40T		Track Control Arm	S061763
	1996.07-2003.10	Front Axle Left Upper	Terrain cab wagon closed 4WD 4M40T		Track Control Arm	S060956
	1996.07-2003.10	Front Axle Right Lower	Terrain cab wagon closed 4WD 4M40T		Track Control Arm	S061764
	1996.07-2003.10	Front Axle Right Upper	Terrain cab wagon closed 4WD 4M40T		Track Control Arm	S060957
	1996.07-2003.10	Front Axle Left & Right Upper	Terrain cab wagon closed 4WD 4M40T		Control Arm Bushing	512260
	1996.07-2003.10	Rear Axle Left & Right Lower Inner	Terrain cab wagon closed 4WD 4M40T		Control Arm Bushing	516017
	1996.07-2003.10	Front Axle	Terrain cab wagon closed 4WD 4M40T		Pitman Arm	S010013
	1996.07-2003.10	Front Axle	Terrain cab wagon closed 4WD 4M40T		Idler Arm	S010041
	1996.07-2003.10	Front Axle Left & Right	Terrain cab wagon closed 4WD 4M40T		Tie Rod End	S070231
	1996.07-2003.10	Front Axle Left & Right	Terrain cab wagon closed 4WD 4M40T		Rod/Strut, stabiliser	S051371
	1996.07-2003.10	Front Axle	Terrain cab wagon closed 4WD 4M40T		Stabiliser Bushing	512847
	1996.07-2003.10	Front Axle	Terrain cab wagon closed 4WD 4M40T		Stabiliser Bushing	513074
	1996.07-2003.10	Front Axle	Terrain cab wagon closed 4WD 4M40T		Stabiliser Bushing	530787
	1996.07-2003.10	Rear Axle	Terrain cab wagon closed 4WD 4M40T		Stabiliser Bushing	513334
3.0 (130 kw)	1998.03-2000.10	Front Axle Left Lower	Terrain cab wagon closed 4WD 6G72DOHC		Track Control Arm	S061763
	1998.03-2000.10	Front Axle Left Upper	Terrain cab wagon closed 4WD 6G72DOHC		Track Control Arm	S060956
	1998.03-2000.10	Front Axle Right Lower	Terrain cab wagon closed 4WD 6G72DOHC		Track Control Arm	S061764
	1998.03-2000.10	Front Axle Right Upper	Terrain cab wagon closed 4WD 6G72DOHC		Track Control Arm	S060957
	1998.03-2000.10	Front Axle Left Lower	Terrain cab wagon closed 4WD 6G72DOHC		Ball Joint	S080152
	1998.03-2000.10	Front Axle Right Lower	Terrain cab wagon closed 4WD 6G72DOHC		Ball Joint	S080151
	1998.03-2000.10	Front Axle Left & Right Upper	Terrain cab wagon closed 4WD 6G72DOHC		Ball Joint	S080153
	1998.03-2000.10	Front Axle Left & Right Lower	Terrain cab wagon closed 4WD 6G72DOHC		Control Arm Bushing	511275
	1998.03-2000.10	Front Axle Left & Right Lower	Terrain cab wagon closed 4WD 6G72DOHC		Control Arm Bushing	512853
	1998.03-2000.10	Front Axle Left & Right Upper	Terrain cab wagon closed 4WD 6G72DOHC		Control Arm Bushing	512260
	1998.03-2000.10	Front Axle Left & Right Upper	Terrain cab wagon closed 4WD 6G72DOHC	MT,AT,Date to:2003.07	Control Arm Bushing	516611
	1998.03-2000.10	Rear Axle Left & Right Lower Inner	Terrain cab wagon closed 4WD 6G72DOHC		Control Arm Bushing	516017
	1998.03-2000.10	Rear Axle Left & Right Lower Inner	Terrain cab wagon closed 4WD 6G72DOHC	for left-hand drive vehicles,MT,AT,Data from-to:1999.06-2011.03	Control Arm Bushing	516018
	1998.03-2000.10	Rear Axle Left & Right Lower Outer	Terrain cab wagon closed 4WD 6G72DOHC	for left-hand drive vehicles,MT,AT,Data from-to:1999.06-2011.03	Control Arm Bushing	511260
	1998.03-2000.10	Front Axle	Terrain cab wagon closed 4WD 6G72DOHC		Pitman Arm	S010013
	1998.03-2000.10	Front Axle	Terrain cab wagon closed 4WD 6G72DOHC	For Left-Hand Drive Vehicles	Idler Arm	S010010
	1998.03-2000.10	Front Axle	Terrain cab wagon closed 4WD 6G72DOHC	For Right-Hand Drive Vehicles	Idler Arm	S010041
	1998.03-2000.10	Front Axle Left & Right	Terrain cab wagon closed 4WD 6G72DOHC		Tie Rod End	S070317
	1998.03-2000.10	Front Axle Left & Right Inner	Terrain cab wagon closed 4WD 6G72DOHC		Tie Rod End	S070231
	1998.03-2000.10	Front Axle Left & Right Outer	Terrain cab wagon closed 4WD 6G72DOHC		Tie Rod End	S070316
	1998.03-2000.10	Front Axle Left & Right	Terrain cab wagon closed 4WD 6G72DOHC		Rod/Strut, stabiliser	S051371
	1998.03-2000.10	Rear Axle Left & Right	Terrain cab wagon closed 4WD 6G72DOHC		Rod/Strut, stabiliser	520376
	1998.03-2000.10	Front Axle Left & Right Outer	Terrain cab wagon closed 4WD 6G72DOHC		Stabiliser Bushing	512847
	1998.03-2000.10	Front Axle	Terrain cab wagon closed 4WD 6G72DOHC		Stabiliser Bushing	513074
	1998.03-2000.10	Front Axle	Terrain cab wagon closed 4WD 6G72DOHC		Stabiliser Bushing	513327
	1998.03-2000.10	Front Axle	Terrain cab wagon closed 4WD 6G72DOHC		Stabiliser Bushing	516838
	1998.03-2000.10	Front Axle	Terrain cab wagon closed 4WD 6G72DOHC		Stabiliser Bushing	530787
	1998.03-2000.10	Rear Axle	Terrain cab wagon closed 4WD 6G72DOHC		Stabiliser Bushing	513334
Colt						
1.6 (66 kw)	1996.05-2000.09	Front Axle Left Lower	Hatchback FWD 4G92		Track Control Arm	S061053
	1996.05-2000.09	Front Axle Right Lower	Hatchback FWD 4G92		Track Control Arm	S061052
	1996.05-2000.09	Rear Axle Left Lower	Hatchback FWD 4G92		Track Control Arm	S061088
	1996.05-2000.09	Rear Axle Left Upper Outer	Hatchback FWD 4G92		Track Control Arm	S060617
	1996.05-2000.09	Rear Axle Right Lower	Hatchback FWD 4G92		Track Control Arm	S061087
	1996.05-2000.09	Rear Axle Right Upper Outer	Hatchback FWD 4G92		Track Control Arm	S060618
	1996.05-2000.09	Front Axle Left Lower	Hatchback FWD 4G92		Control Arm Bushing	511844



	 YEAR	FITTING POSITION	BODY STYLE & DRIVE TYPE & ENGINE	REMARKS	PRODUCT	GSP Ref.
MITSUBISHI						
Colt						
1.6 (66 kw)	1996.05-2000.09	Front Axle Right Lower	Hatchback FWD 4G92		Control Arm Bushing	516607
	1996.05-2000.09	Front Axle Left & Right Lower	Hatchback FWD 4G92	for article no.:SCA-5640,SCA-5639	Control Arm Bushing	514925
	1996.05-2000.09	Front Axle Left & Right Lower	Hatchback FWD 4G92		Control Arm Bushing	516080
	1996.05-2000.09	Front Axle Left & Right Lower	Hatchback FWD 4G92		Control Arm Bushing	516165
	1996.05-2000.09	Front Axle Left & Right Lower	Hatchback FWD 4G92		Control Arm Bushing	531494
	1996.05-2000.09	Rear Axle Left & Right Centre	Hatchback FWD 4G92		Control Arm Bushing	516606
	1996.05-2000.09	Rear Axle Left & Right Lower	Hatchback FWD 4G92	for OE No.MR491347,for OE No.MR491345	Control Arm Bushing	514839
	1996.05-2000.09	Rear Axle Left & Right Upper	Hatchback FWD 4G92		Control Arm Bushing	516617
	1996.05-2000.09	Rear Axle Left & Right Lower Outer	Hatchback FWD 4G92		Control Arm Bushing	513770
	1996.05-2000.09	Front Axle Left & Right	Hatchback FWD 4G92		Tie Rod Axle Joint	S030186
	1996.05-2000.09	Front Axle Left & Right	Hatchback FWD 4G92		Tie Rod End	S070321
	1996.05-2000.09	Front Axle Left & Right	Hatchback FWD 4G92		Tie Rod End	S070695
	1996.05-2000.09	Front Axle Left & Right	Hatchback FWD 4G92		Rod/Strut, stabiliser	514869
	1996.05-2000.09	Front Axle	Hatchback FWD 4G92		Stabiliser Bushing	517672
	1996.05-2000.09	Front Axle	Hatchback FWD 4G92		Stabiliser Bushing	532780
	1996.05-2000.09	Front	Hatchback FWD 4G92		Stabiliser Bushing	514974
	1996.05-2000.09	Front Axle	Hatchback FWD 4G92		Steering Boot	540163
	1996.05-2000.09	Front Axle	Hatchback FWD 4G92		Steering Boot	540178
	1996.05-2000.09	Front Axle	Hatchback FWD 4G92		Steering Boot	540231
1.6 (83 kw)	1992.04-1996.04	Front Axle Left Lower	Hatchback FWD 4G92		Track Control Arm	S060608
	1992.04-1996.04	Front Axle Right Lower	Hatchback FWD 4G92		Track Control Arm	S060607
	1992.04-1996.04	Rear Axle Left Lower	Hatchback FWD 4G92		Track Control Arm	S061088
	1992.04-1996.04	Rear Axle Left Lower Inner	Hatchback FWD 4G92		Track Control Arm	S060955
	1992.04-1996.04	Rear Axle Left Upper Outer	Hatchback FWD 4G92		Track Control Arm	S060617
	1992.04-1996.04	Rear Axle Right Lower	Hatchback FWD 4G92		Track Control Arm	S061087
	1992.04-1996.04	Rear Axle Right Lower Inner	Hatchback FWD 4G92		Track Control Arm	S060954
	1992.04-1996.04	Rear Axle Right Upper Outer	Hatchback FWD 4G92		Track Control Arm	S060618
	1992.04-1996.04	Front Axle Left Lower	Hatchback FWD 4G92		Control Arm Bushing	511844
	1992.04-1996.04	Front Axle Right Lower	Hatchback FWD 4G92		Control Arm Bushing	516607
	1992.04-1996.04	Front Axle Left & Right Lower	Hatchback FWD 4G92	Equipment Vart.:ALL EXC. 1.8 GTI	Control Arm Bushing	516080
	1992.04-1996.04	Front Axle Left & Right Lower	Hatchback FWD 4G92		Control Arm Bushing	516165
	1992.04-1996.04	Front Axle Left & Right Lower	Hatchback FWD 4G92		Control Arm Bushing	516610
	1992.04-1996.04	Front Axle Left & Right Lower	Hatchback FWD 4G92		Control Arm Bushing	531494
	1992.04-1996.04	Rear Axle Left & Right Centre	Hatchback FWD 4G92		Control Arm Bushing	516606
	1992.04-1996.04	Rear Axle Left & Right Lower	Hatchback FWD 4G92	for OE No.MR491347,for OE No.MR491345	Control Arm Bushing	514839
	1992.04-1996.04	Rear Axle Left & Right Upper	Hatchback FWD 4G92		Control Arm Bushing	516617
	1992.04-1996.04	Rear Axle Left & Right Lower Outer	Hatchback FWD 4G92	Date from:1995.08	Control Arm Bushing	513770
	1992.04-1996.04	Front Axle Left & Right	Hatchback FWD 4G92		Tie Rod Axle Joint	S030186
	1992.04-1996.04	Front Axle Left & Right	Hatchback FWD 4G92		Tie Rod End	S070321
	1992.04-1996.04	Front Axle Left & Right	Hatchback FWD 4G92		Tie Rod End	S070695
	1992.04-1996.04	Rear Axle Left & Right	Hatchback FWD 4G92		Rod/Strut, stabiliser	S050319
	1992.04-1996.04	Front Axle	Hatchback FWD 4G92		Steering Boot	540163
	1992.04-1996.04	Front Axle	Hatchback FWD 4G92		Steering Boot	540178
	1992.04-1996.04	Front Axle	Hatchback FWD 4G92		Steering Boot	540231
1.8 (103 kw)	1991.12-1995.08	Front Axle Left Lower	Hatchback FWD 4G93DOHC		Track Control Arm	S060608
	1991.12-1995.08	Front Axle Right Lower	Hatchback FWD 4G93DOHC		Track Control Arm	S060607
	1991.12-1995.08	Rear Axle Left Lower	Hatchback FWD 4G93DOHC		Track Control Arm	S061088
	1991.12-1995.08	Rear Axle Left Lower Inner	Hatchback FWD 4G93DOHC		Track Control Arm	S060955
	1991.12-1995.08	Rear Axle Left Upper Outer	Hatchback FWD 4G93DOHC		Track Control Arm	S060617
	1991.12-1995.08	Rear Axle Right Lower	Hatchback FWD 4G93DOHC		Track Control Arm	S061087
	1991.12-1995.08	Rear Axle Right Lower Inner	Hatchback FWD 4G93DOHC		Track Control Arm	S060954
	1991.12-1995.08	Rear Axle Right Upper Outer	Hatchback FWD 4G93DOHC		Track Control Arm	S060618
	1991.12-1995.08	Front Axle Left Lower	Hatchback FWD 4G93DOHC		Control Arm Bushing	511844
	1991.12-1995.08	Front Axle Left & Right Lower	Hatchback FWD 4G93DOHC		Control Arm Bushing	516165
	1991.12-1995.08	Front Axle Left & Right Lower	Hatchback FWD 4G93DOHC		Control Arm Bushing	516610
	1991.12-1995.08	Front Axle Left & Right Lower	Hatchback FWD 4G93DOHC		Control Arm Bushing	531494
	1991.12-1995.08	Rear Axle Left & Right Centre	Hatchback FWD 4G93DOHC		Control Arm Bushing	516606
	1991.12-1995.08	Rear Axle Left & Right Lower	Hatchback FWD 4G93DOHC	MT,Date from-to:1993.06-1994.11	Control Arm Bushing	514839
	1991.12-1995.08	Rear Axle Left & Right Upper	Hatchback FWD 4G93DOHC		Control Arm Bushing	516617
	1991.12-1995.08	Rear Axle Left & Right Lower Outer	Hatchback FWD 4G93DOHC		Control Arm Bushing	513770
	1991.12-1995.08	Front Axle Left & Right	Hatchback FWD 4G93DOHC		Tie Rod Axle Joint	S030186
	1991.12-1995.08	Front Axle Left & Right	Hatchback FWD 4G93DOHC		Tie Rod End	S070321
	1991.12-1995.08	Front Axle Left & Right	Hatchback FWD 4G93DOHC		Tie Rod End	S070695
	1991.12-1995.08	Rear Axle Left & Right	Hatchback FWD 4G93DOHC		Rod/Strut, stabiliser	S050319



	 YEAR	FITTING POSITION	BODY STYLE & DRIVE TYPE & ENGINE	REMARKS	PRODUCT	GSP Ref.	
MITSUBISHI							
Colt							
1.8 (103 kw)	1991.12-1995.08	Front Axle	Hatchback FWD 4G93DOHC		Steering Boot	540163	
	1991.12-1995.08	Front Axle	Hatchback FWD 4G93DOHC		Steering Boot	540178	
	1991.12-1995.08	Front Axle	Hatchback FWD 4G93DOHC		Steering Boot	540231	
Eclipse							
2.0 (110 kw)	1991.04-1994.08	Front Axle Left & Right Upper	Coupe 4WD 4G63DOHC		Ball Joint	S080935	
	1991.04-1994.08	Front Axle Right	Coupe 4WD 4G63DOHC		Tie Rod End	S071686	
	1991.04-1994.08	Front Axle Left & Right	Coupe 4WD 4G63DOHC		Tie Rod End	S070690	
	1991.04-1994.08	Front Axle Left & Right	Coupe 4WD 4G63DOHC		Rod/Strut, stabiliser	S050225	
2.0 (157 kw)	1995.08-1999.04	Front Axle Left Upper	Coupe FWD 4G63DOHC		Track Control Arm	S060610	
	1995.08-1999.04	Front Axle Left Lower Outer	Coupe FWD 4G63DOHC		Track Control Arm	S060613	
	1995.08-1999.04	Front Axle Right Upper	Coupe FWD 4G63DOHC		Track Control Arm	S060609	
	1995.08-1999.04	Front Axle Right Lower Outer	Coupe FWD 4G63DOHC		Track Control Arm	S060614	
	1995.08-1999.04	Front Axle Left & Right Upper	Coupe FWD 4G63DOHC		Ball Joint	S080935	
	1995.08-1999.04	Front Axle Left & Right Lower	Coupe FWD 4G63DOHC		Control Arm Bushing	516044	
	1995.08-1999.04	Front Axle Left & Right Lower Inner	Coupe FWD 4G63DOHC		Control Arm Bushing	516082	
	1995.08-1999.04	Rear Axle Left & Right Lower	Coupe FWD 4G63DOHC		Control Arm Bushing	516259	
	1995.08-1999.04	Rear Axle Left & Right Upper	Coupe FWD 4G63DOHC		Control Arm Bushing	516339	
	1995.08-1999.04	Rear Axle Left & Right Upper	Coupe FWD 4G63DOHC	for OE No.MB914432	Control Arm Bushing	516357	
	1995.08-1999.04	Rear Axle Left & Right Lower Centre	Coupe FWD 4G63DOHC		Control Arm Bushing	516422	
	1995.08-1999.04	Front Axle Left & Right Upper	Coupe FWD 4G63DOHC		Control Arm Bushing Kit	516618	
	1995.08-1999.04	Front Axle Left & Right	Coupe FWD 4G63DOHC		Tie Rod Axle Joint	S030181	
	1995.08-1999.04	Front Axle Right	Coupe FWD 4G63DOHC		Tie Rod End	S071686	
	1995.08-1999.04	Front Axle Left & Right	Coupe FWD 4G63DOHC		Tie Rod End	S070690	
	1995.08-1999.04	Front Axle Left & Right	Coupe FWD 4G63DOHC		Rod/Strut, stabiliser	S050225	
	1995.08-1999.04	Rear Axle Left & Right	Coupe FWD 4G63DOHC		Rod/Strut, stabiliser	S050317	
	1995.08-1999.04	Front Axle	Coupe FWD 4G63DOHC		Stabiliser Bushing	532746	
	1995.08-1999.04	Front Axle	Coupe FWD 4G63DOHC		Steering Rack Bellow Kit	540178S	
	1995.12-1999.04	Front Axle Left & Right Lower	Coupe 4WD 4G63DOHC		Control Arm Bushing	516044	
	1995.12-1999.04	Front Axle Left & Right Lower Inner	Coupe 4WD 4G63DOHC		Control Arm Bushing	516082	
	1995.12-1999.04	Rear Axle Left & Right Upper	Coupe 4WD 4G63DOHC		Control Arm Bushing	516357	
	1995.12-1999.04	Front Axle Left & Right Upper	Coupe 4WD 4G63DOHC		Control Arm Bushing Kit	516618	
	1995.12-1999.04	Front Axle Right	Coupe 4WD 4G63DOHC		Tie Rod End	S071686	
	1995.12-1999.04	Front Axle Left & Right	Coupe 4WD 4G63DOHC		Tie Rod End	S070690	
	1995.12-1999.04	Rear Axle Left & Right	Coupe 4WD 4G63DOHC		Rod/Strut, stabiliser	S050317	
	1995.12-1999.04	Front Axle	Coupe 4WD 4G63DOHC		Stabiliser Bushing	532746	
	2.4 (120 kw)	2005.04-2012.12	Front Axle Left & Right Lower	Coupe FWD 4G69		Control Arm Bushing	516069
		2005.04-2012.12	Rear Axle Left & Right Upper	Coupe FWD 4G69		Control Arm Bushing	516617
	3.0 (149 kw)	1999.05-2005.03	Front Axle Left Lower	Coupe FWD 6G72SOHC		Control Arm Bushing	514504
		1999.05-2005.03	Front Axle Right Lower	Coupe FWD 6G72SOHC		Control Arm Bushing	514502
		1999.05-2005.03	Front Axle Left & Right Lower	Coupe FWD 6G72SOHC		Control Arm Bushing	516331
1999.05-2005.03		Rear Axle Left & Right Lower Inner	Coupe FWD 6G72SOHC		Control Arm Bushing	516617	
1999.05-2005.03		Rear Axle Left & Right Lower Outer	Coupe FWD 6G72SOHC		Control Arm Bushing	516609	
1999.05-2005.03	Front Axle Left & Right	Coupe FWD 6G72SOHC		Tie Rod Axle Joint	S030747		
3.8 (196 kw)	2007.01-2007.12	Front Axle Left & Right Lower	Cabriolet FWD 6G75		Control Arm Bushing	516069	
	2007.01-2007.12	Rear Axle Left & Right Upper	Cabriolet FWD 6G75		Control Arm Bushing	516617	
Expo							
2.4 (101 kw)	1992.01-1995.12	Front Axle Left & Right Lower	MPV FWD 4G64S		Control Arm Bushing	516045	
	1992.01-1995.12	Rear Axle Left & Right Lower	MPV FWD 4G64S		Control Arm Bushing	517762	
G-Wagon							
2.8 (92 kw)	1997.11-2001.09	Front Axle Left Lower	Terrain cab wagon closed 4WD 4M40T		Track Control Arm	S061763	
	1997.11-2001.09	Front Axle Left Upper	Terrain cab wagon closed 4WD 4M40T		Track Control Arm	S060956	
	1997.11-2001.09	Front Axle Right Lower	Terrain cab wagon closed 4WD 4M40T		Track Control Arm	S061764	
	1997.11-2001.09	Front Axle Right Upper	Terrain cab wagon closed 4WD 4M40T		Track Control Arm	S060957	
	1997.11-2001.09	Front Axle Left & Right Upper	Terrain cab wagon closed 4WD 4M40T		Control Arm Bushing	512260	
	1997.11-2001.09	Rear Axle Left & Right Lower Inner	Terrain cab wagon closed 4WD 4M40T		Control Arm Bushing	516017	
	1997.11-2001.09	Front Axle	Terrain cab wagon closed 4WD 4M40T		Pitman Arm	S010013	
	1997.11-2001.09	Front Axle	Terrain cab wagon closed 4WD 4M40T		Idler Arm	S010041	
	1997.11-2001.09	Front Axle Left & Right	Terrain cab wagon closed 4WD 4M40T		Tie Rod End	S070231	
	1997.11-2001.09	Front Axle Left & Right	Terrain cab wagon closed 4WD 4M40T		Rod/Strut, stabiliser	S051371	
	1997.11-2001.09	Front Axle Left & Right Outer	Terrain cab wagon closed 4WD 4M40T		Stabiliser Bushing	512847	
	1997.11-2001.09	Front Axle	Terrain cab wagon closed 4WD 4M40T		Stabiliser Bushing	512847	
	1997.11-2001.09	Front Axle	Terrain cab wagon closed 4WD 4M40T		Stabiliser Bushing	513074	
	1997.11-2001.09	Front Axle	Terrain cab wagon closed 4WD 4M40T		Stabiliser Bushing	530787	
	1997.11-2001.09	Rear Axle	Terrain cab wagon closed 4WD 4M40T		Stabiliser Bushing	513334	



	 YEAR	FITTING POSITION	BODY STYLE & DRIVE TYPE & ENGINE	REMARKS	PRODUCT	GSP Ref.
MITSUBISHI Galant						
2.0 (100 kw)						
	1992.11-1996.09	Front Axle Left Upper	Saloon FWD 4G63S		Track Control Arm	S060610
	1992.11-1996.09	Front Axle Left Lower Inner	Saloon FWD 4G63S		Track Control Arm	S060615
	1992.11-1996.09	Front Axle Left Lower Outer	Saloon FWD 4G63S		Track Control Arm	S060613
	1992.11-1996.09	Front Axle Right Upper	Saloon FWD 4G63S		Track Control Arm	S060609
	1992.11-1996.09	Front Axle Right Lower Inner	Saloon FWD 4G63S		Track Control Arm	S060616
	1992.11-1996.09	Front Axle Right Lower Outer	Saloon FWD 4G63S		Track Control Arm	S060614
	1992.11-1996.09	Front Axle Left & Right Upper	Saloon FWD 4G63S		Ball Joint	S080935
	1992.11-1996.09	Front Axle Left & Right Lower	Saloon FWD 4G63S		Control Arm Bushing	516044
	1992.11-1996.09	Front Axle Left & Right Lower Inner	Saloon FWD 4G63S		Control Arm Bushing	516082
	1992.11-1996.09	Rear Axle Left & Right Lower	Saloon FWD 4G63S		Control Arm Bushing	516259
	1992.11-1996.09	Rear Axle Left & Right Upper	Saloon FWD 4G63S	for OE No.MB914432	Control Arm Bushing	516357
	1992.11-1996.09	Rear Axle Left & Right Upper	Saloon FWD 4G63S		Control Arm Bushing	532745
	1992.11-1996.09	Rear Axle Left & Right Lower Centre	Saloon FWD 4G63S		Control Arm Bushing	516422
	1992.11-1996.09	Front Axle Left & Right Upper	Saloon FWD 4G63S		Control Arm Bushing Kit	516618
	1992.11-1996.09	Front Axle Left & Right	Saloon FWD 4G63S		Tie Rod Axle Joint	S030181
	1992.11-1996.09	Front Axle Left & Right	Saloon FWD 4G63S		Tie Rod End	S070690
	1992.11-1996.09	Front Axle Left & Right	Saloon FWD 4G63S		Rod/Strut, stabiliser	S050225
	1992.11-1996.09	Rear Axle Left & Right	Saloon FWD 4G63S		Rod/Strut, stabiliser	S050317
	1992.11-1996.09	Front Axle	Saloon FWD 4G63S		Stabiliser Bushing	532746
2.5 (118 kw)						
	1996.10-2004.10	Front Axle Left Upper	Saloon FWD 6A13DOHC		Track Control Arm	S060610
	1996.10-2004.10	Front Axle Left Lower Outer	Saloon FWD 6A13DOHC		Track Control Arm	S060613
	1996.10-2004.10	Front Axle Right Upper	Saloon FWD 6A13DOHC		Track Control Arm	S060609
	1996.10-2004.10	Front Axle Right Lower Outer	Saloon FWD 6A13DOHC		Track Control Arm	S060614
	1996.10-2004.10	Front Axle Left & Right Upper	Saloon FWD 6A13DOHC		Ball Joint	S080935
	1996.10-2004.10	Front Axle Left & Right Lower	Saloon FWD 6A13DOHC		Control Arm Bushing	516044
	1996.10-2004.10	Front Axle Left & Right Lower Inner	Saloon FWD 6A13DOHC		Control Arm Bushing	516082
	1996.10-2004.10	Rear Axle Left & Right Lower	Saloon FWD 6A13DOHC		Control Arm Bushing	516259
	1996.10-2004.10	Rear Axle Left & Right Upper	Saloon FWD 6A13DOHC		Control Arm Bushing	516339
	1996.10-2004.10	Rear Axle Left & Right Upper	Saloon FWD 6A13DOHC	MT,Date to:2003.05	Control Arm Bushing	516357
	1996.10-2004.10	Rear Axle Left & Right Lower Inner	Saloon FWD 6A13DOHC		Control Arm Bushing	516617
	1996.10-2004.10	Rear Axle Left & Right Lower Outer	Saloon FWD 6A13DOHC		Control Arm Bushing	516609
	1996.10-2004.10	Front Axle Left & Right Upper	Saloon FWD 6A13DOHC		Control Arm Bushing Kit	516618
	1996.10-2004.10	Front Axle Left & Right	Saloon FWD 6A13DOHC		Tie Rod Axle Joint	S030181
	1996.10-2004.10	Front Axle Right	Saloon FWD 6A13DOHC		Tie Rod End	S071686
	1996.10-2004.10	Front Axle Left & Right	Saloon FWD 6A13DOHC		Tie Rod End	S070690
	1996.10-2004.10	Rear Axle Left & Right	Saloon FWD 6A13DOHC		Rod/Strut, stabiliser	S050198
	1996.10-2004.10	Rear Axle Left & Right	Saloon FWD 6A13DOHC		Rod/Strut, stabiliser	S050317
	1996.10-2004.10	Front Axle	Saloon FWD 6A13DOHC		Stabiliser Bushing	517569
	1996.10-2004.10	Rear Axle	Saloon FWD 6A13DOHC		Stabiliser Bushing	517328
	1996.10-2004.10	Front Axle	Saloon FWD 6A13DOHC		Steering Boot	540178
	1996.10-2004.10	Front Axle	Saloon FWD 6A13DOHC		Steering Boot	540223
	1996.10-2004.10	Front Axle	Saloon FWD 6A13DOHC	For OE.no.MR151976	Steering Rack Bellow Kit	540223S
Grandis						
2.4 (121 kw)						
	2003.06-2011.12	Front Axle Left Lower	MPV FWD 4G69		Track Control Arm	S062886
	2003.06-2011.12	Front Axle Right Lower	MPV FWD 4G69		Track Control Arm	S062887
	2003.06-2011.12	Front Axle Left & Right Lower	MPV FWD 4G69		Ball Joint	S081026
	2003.06-2011.12	Front Axle Left & Right Lower	MPV FWD 4G69	Date to:2010.12	Control Arm Bushing	516059
	2003.06-2011.12	Front Axle Left & Right Lower	MPV FWD 4G69	AT,Date to:2010.12	Control Arm Bushing	516095
	2003.06-2011.12	Rear Axle Left & Right Lower	MPV FWD 4G69	for left-hand drive vehicles,AT,Date to:2010.11	Control Arm Bushing	516388
	2003.06-2011.12	Rear Axle Left & Right Lower	MPV FWD 4G69	AT,Date to:2010.12	Control Arm Bushing	517762
	2003.06-2011.12	Front Axle Left & Right	MPV FWD 4G69		Tie Rod Axle Joint	S030644
	2003.06-2011.12	Front Axle Left & Right	MPV FWD 4G69		Tie Rod End	S070763
	2003.06-2011.12	Front Axle Right	MPV FWD 4G69		Rod/Strut, stabiliser	S050825
GTO						
3.0 (210 kw)						
	1990.01-2000.12	Front Axle Left & Right	Coupe 4WD 6G72DOHCT		Tie Rod Axle Joint	S030590
	1990.01-2000.12	Front Axle Right	Coupe 4WD 6G72DOHCT		Tie Rod End	S071686
	1990.01-2000.12	Front Axle Left & Right	Coupe 4WD 6G72DOHCT		Tie Rod End	S070210
	1990.01-2000.12	Front Axle Left & Right	Coupe 4WD 6G72DOHCT		Rod/Strut, stabiliser	S050225
	1990.01-2000.12	Front Axle	Coupe 4WD 6G72DOHCT		Steering Boot	540178
L200						
2.5 (73 kw)						
	1996.09-2007.12	Front Axle Left Lower	Pick up 4WD 4D56		Track Control Arm	S061763
	1996.09-2007.12	Front Axle Left Upper	Pick up 4WD 4D56		Track Control Arm	S060956
	1996.09-2007.12	Front Axle Right Lower	Pick up 4WD 4D56		Track Control Arm	S061764
	1996.09-2007.12	Front Axle Right Upper	Pick up 4WD 4D56		Track Control Arm	S060957



	 YEAR	FITTING POSITION	BODY STYLE & DRIVE TYPE & ENGINE	REMARKS	PRODUCT	GSP Ref.
MITSUBISHI L200						
2.5 (73 kw)	1996.09-2007.12	Front Axle Left Lower	Pick up 4WD 4D56		Ball Joint	S080152
	1996.09-2007.12	Front Axle Right Lower	Pick up 4WD 4D56		Ball Joint	S080151
	1996.09-2007.12	Front Axle Left & Right Upper	Pick up 4WD 4D56		Ball Joint	S080153
	1996.09-2007.12	Front Axle Left & Right Upper	Pick up 4WD 4D56		Ball Joint	S080154
	1996.09-2007.12	Front Axle Left & Right Lower	Pick up 4WD 4D56		Control Arm Bushing	511275
	1996.09-2007.12	Front Axle Left & Right Lower	Pick up 4WD 4D56		Control Arm Bushing	512853
	1996.09-2007.12	Front Axle Left & Right Upper	Pick up 4WD 4D56		Control Arm Bushing	512260
	1996.09-2007.12	Front Axle	Pick up 4WD 4D56		Pitman Arm	S010013
	1996.09-2007.12	Front Axle	Pick up 4WD 4D56	For Left-Hand Drive Vehicles	Idler Arm	S010010
	1996.09-2007.12	Front Axle	Pick up 4WD 4D56	For Right-Hand Drive Vehicles	Idler Arm	S010041
	1996.09-2007.12	Front Axle Left & Right Inner	Pick up 4WD 4D56		Tie Rod End	S070231
	1996.09-2007.12	Front Axle Left & Right Outer	Pick up 4WD 4D56		Tie Rod End	S070316
	1996.09-2007.12	Front Axle Left	Pick up 4WD 4D56		Rod/Strut, stabiliser	S050627
	1996.09-2007.12	Front Axle Right	Pick up 4WD 4D56		Rod/Strut, stabiliser	S050626
	1996.09-2007.12	Front Axle Left & Right	Pick up 4WD 4D56		Rod/Strut, stabiliser	S051371
	1996.09-2007.12	Front Axle Left & Right Inner	Pick up 4WD 4D56		Stabiliser Bushing	517554
	1996.09-2007.12	Front Axle Left & Right Inner	Pick up 4WD 4D56		Stabiliser Bushing	532779
	1996.09-2007.12	Front Axle Left & Right Outer	Pick up 4WD 4D56		Stabiliser Bushing	512847
	1996.09-2007.12	Front Axle	Pick up 4WD 4D56		Stabiliser Bushing	513074
	1996.09-2007.12	Front Axle	Pick up 4WD 4D56		Stabiliser Bushing	513327
	1996.09-2007.12	Front Axle	Pick up 4WD 4D56		Stabiliser Bushing	530787
L200/Triton/Hunter						
3.5 (147 kw)	2007.05-2015.12	Front Axle Left Lower	Pick up AWD 6G74(SOHC 24V)		Track Control Arm	S061952
	2007.05-2015.12	Front Axle Left Upper	Pick up AWD 6G74(SOHC 24V)		Track Control Arm	S061321
	2007.05-2015.12	Front Axle Right Lower	Pick up AWD 6G74(SOHC 24V)		Track Control Arm	S061953
	2007.05-2015.12	Front Axle Right Upper	Pick up AWD 6G74(SOHC 24V)		Track Control Arm	S061322
	2007.05-2015.12	Rear Axle Left & Right Upper	Pick up AWD 6G74(SOHC 24V)		Control Arm Bushing	516253
3.5 (151 kw)	2009.08-2016.12	Front Axle Left Lower	Pick up AWD 6G74(SOHC 24V)		Track Control Arm	S061952
	2009.08-2016.12	Front Axle Left Upper	Pick up AWD 6G74(SOHC 24V)		Track Control Arm	S061321
	2009.08-2016.12	Front Axle Right Lower	Pick up AWD 6G74(SOHC 24V)		Track Control Arm	S061953
	2009.08-2016.12	Front Axle Right Upper	Pick up AWD 6G74(SOHC 24V)		Track Control Arm	S061322
	2009.08-2016.12	Rear Axle Left & Right Upper	Pick up AWD 6G74(SOHC 24V)		Control Arm Bushing	516253
L300						
2.5 (51 kw)	1986.11-2006.02	Front Axle Left Lower	VAN RWD 4D56		Track Control Arm	S060207
	1986.11-2006.02	Front Axle Right Lower	VAN RWD 4D56		Track Control Arm	S060206
	1986.11-2006.02	Front Axle Left Lower	VAN RWD 4D56		Ball Joint	S080155
	1986.11-2006.02	Front Axle Right Lower	VAN RWD 4D56		Ball Joint	S080156
	1986.11-2006.02	Front Axle Left & Right Lower	VAN RWD 4D56		Ball Joint	S080097
	1986.11-2006.02	Front Axle Left & Right Upper	VAN RWD 4D56	Date to: 2003.12	Ball Joint	S080084
	1986.11-2006.02	Front Axle Left & Right Upper	VAN RWD 4D56	Engine code: 4D56(RV) Date to: 2003.12 Engine code: 4D56(RV)	Ball Joint	S080147
	1986.11-2006.02	Front Axle Left & Right Lower	VAN RWD 4D56		Control Arm Bushing	511843
	1986.11-2006.02	Front Axle Left & Right Upper	VAN RWD 4D56		Control Arm Bushing	512849
	1986.11-2006.02	Front Axle Left & Right Upper	VAN RWD 4D56		Control Arm Bushing	512850
	1986.11-2006.02	Front Axle Left & Right	VAN RWD 4D56	for vehicles without power steering	Tie Rod Axle Joint	S030180
	1986.11-2006.02	Front Axle Left & Right	VAN RWD 4D56	for vehicles without power steering	Tie Rod Axle Joint	S030182
	1986.11-2006.02	Front Axle Left & Right	VAN RWD 4D56	Engine code: 4D56(RV) Date to: 2003.12 Engine code: 4D56(RV)	Tie Rod End	S070210
	1986.11-2006.02	Front Axle Left & Right	VAN RWD 4D56	Date to: 1996.12	Tie Rod End	S070691
	1986.11-2006.02	Front Axle Left & Right	VAN RWD 4D56		Rod/Strut, stabiliser	513357
	1986.11-2006.02	Front Axle Left & Right	VAN RWD 4D56		Rod/Strut, stabiliser	S050330
	1986.11-2006.02	Rear Axle	VAN RWD 4D56		Stabiliser Bushing	517674
	1986.11-2006.02	Front Axle	VAN RWD 4D56		Steering Boot	540178
Lancer						
1.6 (83 kw)	1992.06-1995.08	Front Axle Left Lower	Saloon FWD 4G92		Track Control Arm	S060608
	1992.06-1995.08	Front Axle Right Lower	Saloon FWD 4G92		Track Control Arm	S060607
	1992.06-1995.08	Rear Axle Left Lower	Saloon FWD 4G92		Track Control Arm	S061088
	1992.06-1995.08	Rear Axle Left Lower Inner	Saloon FWD 4G92		Track Control Arm	S060955
	1992.06-1995.08	Rear Axle Left Upper Outer	Saloon FWD 4G92		Track Control Arm	S060617
	1992.06-1995.08	Rear Axle Right Lower	Saloon FWD 4G92		Track Control Arm	S061087
	1992.06-1995.08	Rear Axle Right Lower Inner	Saloon FWD 4G92		Track Control Arm	S060954
	1992.06-1995.08	Rear Axle Right Upper Outer	Saloon FWD 4G92		Track Control Arm	S060618
	1992.06-1995.08	Front Axle Left Lower	Saloon FWD 4G92		Control Arm Bushing	511844
	1992.06-1995.08	Front Axle Right Lower	Saloon FWD 4G92		Control Arm Bushing	516607
	1992.06-1995.08	Front Axle Left & Right Lower	Saloon FWD 4G92		Control Arm Bushing	516080
	1992.06-1995.08	Front Axle Left & Right Lower	Saloon FWD 4G92		Control Arm Bushing	516165



	 YEAR	FITTING POSITION	BODY STYLE & DRIVE TYPE & ENGINE	REMARKS	PRODUCT	GSP Ref.
MITSUBISHI						
Lancer						
1.6 (83 kw)	1992.06-1995.08	Front Axle Left & Right Lower	Saloon FWD 4G92		Control Arm Bushing	531494
	1992.06-1995.08	Rear Axle Left & Right Lower	Saloon FWD 4G92	for OE No.MR491347,for OE No.MR491345	Control Arm Bushing	514839
	1992.06-1995.08	Rear Axle Left & Right Upper	Saloon FWD 4G92		Control Arm Bushing	516617
	1992.06-1995.08	Rear Axle Left & Right Lower Outer	Saloon FWD 4G92		Control Arm Bushing	513770
	1992.06-1995.08	Front Axle Left & Right	Saloon FWD 4G92		Tie Rod Axle Joint	S030186
	1992.06-1995.08	Front Axle Left & Right	Saloon FWD 4G92		Tie Rod End	S070321
	1992.06-1995.08	Front Axle Left & Right	Saloon FWD 4G92		Tie Rod End	S070695
	1992.06-1995.08	Rear Axle Left & Right	Saloon FWD 4G92		Rod/Strut,stabiliser	S050319
	1992.06-1995.08	Front Axle	Saloon FWD 4G92		Steering Boot	540163
	1992.06-1995.08	Front Axle	Saloon FWD 4G92		Steering Boot	540178
	1992.06-1995.08	Front Axle	Saloon FWD 4G92		Steering Boot	540231
	1992.06-1995.08	Front Axle	Saloon FWD 4G92		Steering Rack Bellow Kit	540178S
Lancer Evolution						
2.0 (206 kw)	2000.12-2005.03	Front Axle Left Lower	Saloon 4WD 4G63DOHC		Track Control Arm	S061057
	2000.12-2005.03	Front Axle Right Lower	Saloon 4WD 4G63DOHC		Track Control Arm	S061056
	2000.12-2005.03	Front Axle Left Lower	Saloon 4WD 4G63DOHC		Control Arm Bushing	511844
	2000.12-2005.03	Front Axle Left & Right Lower	Saloon 4WD 4G63DOHC		Control Arm Bushing	531494
	2000.12-2005.03	Rear Axle Left & Right Upper	Saloon 4WD 4G63DOHC	MT	Control Arm Bushing	516357
	2000.12-2005.03	Rear Axle Left & Right Upper	Saloon 4WD 4G63DOHC		Control Arm Bushing	516615
	2000.12-2005.03	Rear Axle Left & Right Lower Outer	Saloon 4WD 4G63DOHC		Control Arm Bushing	513770
	2000.12-2005.03	Rear Axle Left & Right Upper	Saloon 4WD 4G63DOHC		Control Arm Bushing Kit	514909S
	2000.12-2005.03	Front Axle Left & Right	Saloon 4WD 4G63DOHC		Tie Rod End	S070690
	2000.12-2005.03	Front Axle Left & Right	Saloon 4WD 4G63DOHC		Tie Rod End	S070695
	2000.12-2005.03	Front Axle Left	Saloon 4WD 4G63DOHC		Rod/Strut,stabiliser	S050191
	2000.12-2005.03	Front Axle Left & Right	Saloon 4WD 4G63DOHC		Rod/Strut,stabiliser	S050195
	2000.12-2005.03	Front Axle	Saloon 4WD 4G63DOHC		Steering Boot	540178
	2000.12-2005.03	Rear	Saloon 4WD 4G63DOHC		Steering Bushing	517596
2.0 (213 kw)	2005.08-2007.09	Front Axle Left & Right Lower	Saloon 4WD 4G63DOHC		Control Arm Bushing	516175
	2005.08-2007.09	Rear Axle Left & Right Centre	Saloon 4WD 4G63DOHC		Control Arm Bushing	514945
	2005.08-2007.09	Rear Axle Left & Right Upper	Saloon 4WD 4G63DOHC	MT	Control Arm Bushing	516357
	2005.08-2007.09	Rear Axle Left & Right Lower Outer	Saloon 4WD 4G63DOHC		Control Arm Bushing	513770
	2005.08-2007.09	Rear Axle Left & Right Upper	Saloon 4WD 4G63DOHC		Control Arm Bushing Kit	514909S
	2005.08-2007.09	Front Axle Left & Right	Saloon 4WD 4G63DOHC		Tie Rod End	S070695
	2005.08-2007.09	Front Axle Left & Right	Saloon 4WD 4G63DOHC		Tie Rod End	S070763
	2005.08-2007.09	Front Axle Left	Saloon 4WD 4G63DOHC		Rod/Strut,stabiliser	S050191
	2005.08-2007.09	Front Axle Left	Saloon 4WD 4G63DOHC		Rod/Strut,stabiliser	S050195
	2005.08-2007.09	Front Axle Left	Saloon 4WD 4G63DOHC		Rod/Strut,stabiliser	S050195
2.0 (217 kw)	2007.08-2015.12	Rear Axle Left & Right Lower Inner	Saloon 4WD 4B11		Track Control Arm	S062634
	2007.08-2015.12	Rear Axle Left & Right Centre	Saloon 4WD 4B11		Control Arm Bushing	514945
	2007.08-2015.12	Front Axle Left & Right	Saloon 4WD 4B11		Tie Rod End	S070695
	2007.08-2015.12	Front Axle Left	Saloon 4WD 4B11		Rod/Strut,stabiliser	S050191
	2007.08-2015.12	Front Axle Left	Saloon 4WD 4B11		Rod/Strut,stabiliser	S050195
	2007.08-2015.12	Front Axle	Saloon 4WD 4B11		Stabiliser Bushing	517369
2007.08-2015.12	Front Axle	Saloon 4WD 4B11		Steering Boot	540266	
Lancer Sportback						
2.0 (177 kw)	2008.06-	Front Axle Left Lower	Hatchback 4WD 4B11		Track Control Arm	S060886
	2008.06-	Front Axle Right Lower	Hatchback 4WD 4B11		Track Control Arm	S060887
	2008.06-	Rear Axle Left & Right Lower Inner	Hatchback 4WD 4B11		Track Control Arm	S062634
	2008.06-	Front Axle Left & Right Lower	Hatchback 4WD 4B11		Ball Joint	S080475
	2008.06-	Front Axle Left & Right Lower	Hatchback 4WD 4B11		Control Arm Bushing	512851
	2008.06-	Front Axle Left & Right Lower	Hatchback 4WD 4B11	Date to:2015.03	Control Arm Bushing	513670
	2008.06-	Rear Axle Left & Right Centre	Hatchback 4WD 4B11		Control Arm Bushing	516155
	2008.06-	Rear Axle Left & Right Lower	Hatchback 4WD 4B11		Control Arm Bushing	517761
	2008.06-	Rear Axle Left & Right Upper	Hatchback 4WD 4B11		Control Arm Bushing	516170
	2008.06-	Rear Axle Left & Right Lower Inner	Hatchback 4WD 4B11		Control Arm Bushing	516617
	2008.06-	Rear Axle Left & Right Lower Outer	Hatchback 4WD 4B11		Control Arm Bushing	514930
	2008.06-	Front Axle Left & Right	Hatchback 4WD 4B11		Tie Rod Axle Joint	S030397
	2008.06-	Front Axle Left & Right	Hatchback 4WD 4B11		Tie Rod End	S070109
	2008.06-	Front Axle Left & Right	Hatchback 4WD 4B11		Rod/Strut,stabiliser	S050118
	2008.06-	Rear Axle Left & Right	Hatchback 4WD 4B11		Rod/Strut,stabiliser	S050117
	2008.06-	Front Axle	Hatchback 4WD 4B11		Stabiliser Bushing	517368
	2008.06-	Front Axle	Hatchback 4WD 4B11		Stabiliser Bushing	517369
	2008.06-	Front Axle	Hatchback 4WD 4B11		Steering Boot	540266



	 YEAR	FITTING POSITION	BODY STYLE & DRIVE TYPE & ENGINE	REMARKS	PRODUCT	GSP Ref.
MITSUBISHI						
Montero						
2.5 (73 kw)	1991.03-2000.04	Front Axle Left Lower	Terrain cab wagon closed 4WD 4D56		Track Control Arm	S061948
	1991.03-2000.04	Front Axle Left Upper	Terrain cab wagon closed 4WD 4D56		Track Control Arm	S060956
	1991.03-2000.04	Front Axle Right Lower	Terrain cab wagon closed 4WD 4D56		Track Control Arm	S061949
	1991.03-2000.04	Front Axle Right Upper	Terrain cab wagon closed 4WD 4D56		Track Control Arm	S060957
	1991.03-2000.04	Front Axle Left Lower	Terrain cab wagon closed 4WD 4D56		Ball Joint	S080152
	1991.03-2000.04	Front Axle Right Lower	Terrain cab wagon closed 4WD 4D56		Ball Joint	S080151
	1991.03-2000.04	Front Axle Left & Right Upper	Terrain cab wagon closed 4WD 4D56		Ball Joint	S080153
	1991.03-2000.04	Front Axle Left & Right Lower	Terrain cab wagon closed 4WD 4D56		Control Arm Bushing	511275
	1991.03-2000.04	Front Axle Left & Right Lower	Terrain cab wagon closed 4WD 4D56		Control Arm Bushing	512853
	1991.03-2000.04	Front Axle Left & Right Lower	Terrain cab wagon closed 4WD 4D56		Control Arm Bushing	512861
	1991.03-2000.04	Front Axle Left & Right Upper	Terrain cab wagon closed 4WD 4D56	Date from:1996.06	Control Arm Bushing	512260
	1991.03-2000.04	Front Axle Left & Right Upper	Terrain cab wagon closed 4WD 4D56		Control Arm Bushing	512260
	1991.03-2000.04	Rear Axle Left & Right Lower	Terrain cab wagon closed 4WD 4D56		Control Arm Bushing	511259
	1991.03-2000.04	Rear Axle Left & Right Lower	Terrain cab wagon closed 4WD 4D56	Quantity:2	Control Arm Bushing	512857
	1991.03-2000.04	Rear Axle Left & Right Lower	Terrain cab wagon closed 4WD 4D56		Control Arm Bushing	512857
	1991.03-2000.04	Rear Axle Left & Right Lower Outer	Terrain cab wagon closed 4WD 4D56	Date to:1997.03	Control Arm Bushing	511260
	1991.03-2000.04	Front Axle	Terrain cab wagon closed 4WD 4D56		Pitman Arm	S010003
	1991.03-2000.04	Front Axle	Terrain cab wagon closed 4WD 4D56		Idler Arm	S010002
	1991.03-2000.04	Front Axle Left & Right	Terrain cab wagon closed 4WD 4D56		Tie Rod End	S070317
	1991.03-2000.04	Front Axle Left & Right Outer	Terrain cab wagon closed 4WD 4D56		Tie Rod End	S070316
	1991.03-2000.04	Front Axle Left	Terrain cab wagon closed 4WD 4D56		Rod/Strut,stabiliser	S050327
	1991.03-2000.04	Front Axle Right	Terrain cab wagon closed 4WD 4D56		Rod/Strut,stabiliser	S050328
	1991.03-2000.04	Front Axle Left & Right	Terrain cab wagon closed 4WD 4D56		Rod/Strut,stabiliser	513353
	1991.03-2000.04	Front Axle Left & Right	Terrain cab wagon closed 4WD 4D56		Rod/Strut,stabiliser	S050329
	1991.03-2000.04	Rear Axle Left & Right	Terrain cab wagon closed 4WD 4D56		Rod/Strut,stabiliser	513355
	1991.03-2000.04	Rear Axle Left & Right	Terrain cab wagon closed 4WD 4D56		Rod/Strut,stabiliser	520376
	1991.03-2000.04	Front Axle	Terrain cab wagon closed 4WD 4D56		Stabiliser Bushing	512843
	1991.03-2000.04	Front Axle	Terrain cab wagon closed 4WD 4D56		Stabiliser Bushing	512844
	1991.03-2000.04	Front Axle	Terrain cab wagon closed 4WD 4D56		Stabiliser Bushing	513074
	1991.03-2000.04	Front Axle	Terrain cab wagon closed 4WD 4D56		Stabiliser Bushing	513074
	1991.03-2000.04	Front Axle	Terrain cab wagon closed 4WD 4D56		Stabiliser Bushing	513327
	1991.03-2000.04	Front Axle	Terrain cab wagon closed 4WD 4D56		Stabiliser Bushing	513612
	1991.03-2000.04	Front Axle	Terrain cab wagon closed 4WD 4D56		Stabiliser Bushing	517552
	1991.03-2000.04	Front Axle	Terrain cab wagon closed 4WD 4D56		Stabiliser Bushing	517673
	1991.03-2000.04	Front Axle Left	Terrain cab wagon closed 4WD 4D56		Steering Rack Bellow Kit	541014S
	1991.03-2000.04	Front Axle	Terrain cab wagon closed 4WD 4D56		Stabiliser Bushing Kit	513354S
3.0 (110 kw)	1991.03-1997.10	Front Axle Left Lower	Terrain cab wagon closed 4WD 6G72		Track Control Arm	S061948
	1991.03-1997.10	Front Axle Left Upper	Terrain cab wagon closed 4WD 6G72		Track Control Arm	S060956
	1991.03-1997.10	Front Axle Right Lower	Terrain cab wagon closed 4WD 6G72		Track Control Arm	S061949
	1991.03-1997.10	Front Axle Right Upper	Terrain cab wagon closed 4WD 6G72		Track Control Arm	S060957
	1991.03-1997.10	Front Axle Left Lower	Terrain cab wagon closed 4WD 6G72		Ball Joint	S080152
	1991.03-1997.10	Front Axle Right Lower	Terrain cab wagon closed 4WD 6G72		Ball Joint	S080151
	1991.03-1997.10	Front Axle Left & Right Upper	Terrain cab wagon closed 4WD 6G72		Ball Joint	S080153
	1991.03-1997.10	Front Axle Left & Right Lower	Terrain cab wagon closed 4WD 6G72		Control Arm Bushing	511275
	1991.03-1997.10	Front Axle Left & Right Lower	Terrain cab wagon closed 4WD 6G72		Control Arm Bushing	512853
	1991.03-1997.10	Front Axle Left & Right Lower	Terrain cab wagon closed 4WD 6G72		Control Arm Bushing	512861
	1991.03-1997.10	Front Axle Left & Right Upper	Terrain cab wagon closed 4WD 6G72		Control Arm Bushing	512260
	1991.03-1997.10	Rear Axle Left & Right Lower	Terrain cab wagon closed 4WD 6G72		Control Arm Bushing	511259
	1991.03-1997.10	Rear Axle Left & Right Lower	Terrain cab wagon closed 4WD 6G72		Control Arm Bushing	512857
	1991.03-1997.10	Rear Axle Left & Right Lower Outer	Terrain cab wagon closed 4WD 6G72		Control Arm Bushing	511260
	1991.03-1997.10	Front Axle	Terrain cab wagon closed 4WD 6G72		Pitman Arm	S010003
	1991.03-1997.10	Front Axle	Terrain cab wagon closed 4WD 6G72		Idler Arm	S010002
	1991.03-1997.10	Front Axle Left & Right	Terrain cab wagon closed 4WD 6G72		Tie Rod End	S070317
	1991.03-1997.10	Front Axle Left & Right Outer	Terrain cab wagon closed 4WD 6G72		Tie Rod End	S070316
	1991.03-1997.10	Front Axle Left	Terrain cab wagon closed 4WD 6G72		Rod/Strut,stabiliser	S050327
	1991.03-1997.10	Front Axle Right	Terrain cab wagon closed 4WD 6G72		Rod/Strut,stabiliser	S050328
	1991.03-1997.10	Front Axle Left & Right	Terrain cab wagon closed 4WD 6G72		Rod/Strut,stabiliser	513353
	1991.03-1997.10	Front Axle Left & Right	Terrain cab wagon closed 4WD 6G72		Rod/Strut,stabiliser	S050329
	1991.03-1997.10	Rear Axle Left & Right	Terrain cab wagon closed 4WD 6G72		Rod/Strut,stabiliser	513355
	1991.03-1997.10	Rear Axle Left & Right	Terrain cab wagon closed 4WD 6G72		Rod/Strut,stabiliser	520376
	1991.03-1997.10	Front Axle	Terrain cab wagon closed 4WD 6G72		Stabiliser Bushing	512843
	1991.03-1997.10	Front Axle	Terrain cab wagon closed 4WD 6G72		Stabiliser Bushing	512844
	1991.03-1997.10	Front Axle	Terrain cab wagon closed 4WD 6G72		Stabiliser Bushing	513074
	1991.03-1997.10	Front Axle	Terrain cab wagon closed 4WD 6G72		Stabiliser Bushing	513327
	1991.03-1997.10	Front Axle	Terrain cab wagon closed 4WD 6G72		Stabiliser Bushing	513612



	 YEAR	FITTING POSITION	BODY STYLE & DRIVE TYPE & ENGINE	REMARKS	PRODUCT	GSP Ref.	
MITSUBISHI							
Montero							
3.0 (110 kw)	1991.03-1997.10	Front Axle	Terrain cab wagon closed 4WD 6G72		Stabiliser Bushing	517552	
	1991.03-1997.10	Front Axle	Terrain cab wagon closed 4WD 6G72		Stabiliser Bushing	517673	
	1991.03-1997.10	Rear Axle	Terrain cab wagon closed 4WD 6G72		Stabiliser Bushing	513328	
	1991.03-1997.10	Front Axle Left	Terrain cab wagon closed 4WD 6G72		Steering Rack Bellow Kit	541014S	
	1991.03-1997.10	Front Axle	Terrain cab wagon closed 4WD 6G72		Stabiliser Bushing Kit	513354S	
3.2 (121 kw)	2007.02-	Rear Axle Left & Right Upper Inner	Terrain cab wagon closed 4WD 4M41R		Track Control Arm	S061698	
	2007.02-	Front Axle Left & Right Lower	Terrain cab wagon closed 4WD 4M41R		Ball Joint	S080980	
	2007.02-	Front Axle Left & Right Lower	Terrain cab wagon closed 4WD 4M41R	for left-hand drive vehicles,MT,AT,Date to:2013.05	Control Arm Bushing	516304	
	2007.02-	Front Axle Left & Right Lower	Terrain cab wagon closed 4WD 4M41R	for left-hand drive vehicles,MT,AT,Date to:2013.05	Control Arm Bushing	516612	
	2007.02-	Front Axle Left & Right Upper	Terrain cab wagon closed 4WD 4M41R		Control Arm Bushing	516294	
	2007.02-	Rear Axle Left & Right Lower	Terrain cab wagon closed 4WD 4M41R		Control Arm Bushing	512860	
	2007.02-	Rear Axle Left & Right Upper	Terrain cab wagon closed 4WD 4M41R	for left-hand drive vehicles,MT,Date to:2013.05	Control Arm Bushing	516556	
	2007.02-	Rear Axle Left & Right Upper	Terrain cab wagon closed 4WD 4M41R	for left-hand drive vehicles,MT,Date to:2013.05	Control Arm Bushing	516613	
	2007.02-	Rear Axle Left & Right Lower Inner	Terrain cab wagon closed 4WD 4M41R		Control Arm Bushing	530005	
	2007.02-	Rear Axle Left & Right Lower Outer	Terrain cab wagon closed 4WD 4M41R		Control Arm Bushing	516220	
	2007.02-	Front Axle	Terrain cab wagon closed 4WD 4M41R		Stabiliser Bushing	530502	
	3.2 (147 kw)	2009.01-	Front Axle Left Upper	Terrain cab wagon closed 4WD 4M41R		Track Control Arm	S061063
		2009.01-	Front Axle Right Upper	Terrain cab wagon closed 4WD 4M41R		Track Control Arm	S061064
2009.01-		Rear Axle Left & Right Upper Inner	Terrain cab wagon closed 4WD 4M41R		Track Control Arm	S061698	
2009.01-		Front Axle Left & Right Lower	Terrain cab wagon closed 4WD 4M41R		Ball Joint	S080158	
2009.01-		Front Axle Left & Right Lower	Terrain cab wagon closed 4WD 4M41R		Ball Joint	S080980	
2009.01-		Front Axle Left & Right Upper	Terrain cab wagon closed 4WD 4M41R		Ball Joint	S080157	
2009.01-		Rear Axle Left & Right Upper	Terrain cab wagon closed 4WD 4M41R		Ball Joint	S080159	
2009.01-		Front Axle Left & Right Lower	Terrain cab wagon closed 4WD 4M41R	for left-hand drive vehicles,MT,AT,Date to:2013.05	Control Arm Bushing	516304	
2009.01-		Front Axle Left & Right Lower	Terrain cab wagon closed 4WD 4M41R	for left-hand drive vehicles,MT,AT,Date to:2013.05	Control Arm Bushing	516612	
2009.01-		Front Axle Left & Right Upper	Terrain cab wagon closed 4WD 4M41R		Control Arm Bushing	516294	
2009.01-		Rear Axle Left & Right Lower	Terrain cab wagon closed 4WD 4M41R		Control Arm Bushing	512859	
2009.01-		Rear Axle Left & Right Lower	Terrain cab wagon closed 4WD 4M41R	for left-hand drive vehicles,MT,Date to:2013.05	Control Arm Bushing	512860	
2009.01-		Rear Axle Left & Right Upper	Terrain cab wagon closed 4WD 4M41R		Control Arm Bushing	516029	
2009.01-		Rear Axle Left & Right Upper	Terrain cab wagon closed 4WD 4M41R	for left-hand drive vehicles,MT,Date to:2013.05	Control Arm Bushing	516556	
2009.01-		Rear Axle Left & Right Upper	Terrain cab wagon closed 4WD 4M41R	for left-hand drive vehicles,MT,Date to:2013.05	Control Arm Bushing	516613	
2009.01-		Rear Axle Left & Right Lower Inner	Terrain cab wagon closed 4WD 4M41R		Control Arm Bushing	530005	
2009.01-		Rear Axle Left & Right Lower Outer	Terrain cab wagon closed 4WD 4M41R	for left-hand drive vehicles,MT,AT,Date to:2013.05	Control Arm Bushing	516220	
2009.01-		Rear Axle Left & Right Lower Outer	Terrain cab wagon closed 4WD 4M41R		Control Arm Bushing	516222	
2009.01-		Front Axle Left & Right	Terrain cab wagon closed 4WD 4M41R		Tie Rod Axle Joint	S030626	
2009.01-		Front Axle Left	Terrain cab wagon closed 4WD 4M41R		Tie Rod End	S070324	
2009.01-		Front Axle Right	Terrain cab wagon closed 4WD 4M41R		Tie Rod End	S070325	
2009.01-		Front Axle Left	Terrain cab wagon closed 4WD 4M41R		Rod/Strut, stabiliser	S050334	
2009.01-		Front Axle Right	Terrain cab wagon closed 4WD 4M41R		Rod/Strut, stabiliser	S050335	
2009.01-		Rear Axle Left	Terrain cab wagon closed 4WD 4M41R		Rod/Strut, stabiliser	S050325	
2009.01-		Rear Axle Right	Terrain cab wagon closed 4WD 4M41R		Rod/Strut, stabiliser	S050326	
2009.01-		Front Axle	Terrain cab wagon closed 4WD 4M41R		Stabiliser Bushing	517633	
2009.01-		Front Axle	Terrain cab wagon closed 4WD 4M41R		Stabiliser Bushing	530502	
2009.01-		Front Axle Left	Terrain cab wagon closed 4WD 4M41R		Steering Boot	541014	
2009.01-		Rear	Terrain cab wagon closed 4WD 4M41R		Steering Bushing	517596	
3.5 (149 kw)		2000.04-2007.01	Front Axle Left Lower	Terrain cab wagon closed 4WD 6G74DOHC		Track Control Arm	S062001
		2000.04-2007.01	Front Axle Left Upper	Terrain cab wagon closed 4WD 6G74DOHC		Track Control Arm	S061063
		2000.04-2007.01	Front Axle Right Lower	Terrain cab wagon closed 4WD 6G74DOHC		Track Control Arm	S062002
		2000.04-2007.01	Front Axle Right Upper	Terrain cab wagon closed 4WD 6G74DOHC		Track Control Arm	S061064
	2000.04-2007.01	Rear Axle Left & Right Upper Inner	Terrain cab wagon closed 4WD 6G74DOHC		Track Control Arm	S061698	
	2000.04-2007.01	Front Axle Left & Right Lower	Terrain cab wagon closed 4WD 6G74DOHC		Ball Joint	S080158	
	2000.04-2007.01	Front Axle Left & Right Lower	Terrain cab wagon closed 4WD 6G74DOHC		Ball Joint	S080980	
	2000.04-2007.01	Front Axle Left & Right Upper	Terrain cab wagon closed 4WD 6G74DOHC		Ball Joint	S080157	
	2000.04-2007.01	Rear Axle Left & Right Upper	Terrain cab wagon closed 4WD 6G74DOHC		Ball Joint	S080159	
	2000.04-2007.01	Front Axle Left & Right Lower	Terrain cab wagon closed 4WD 6G74DOHC	for OE No.MR496795,Date to:2006.08	Control Arm Bushing	516304	
	2000.04-2007.01	Front Axle Left & Right Lower	Terrain cab wagon closed 4WD 6G74DOHC	Date to:2006.08	Control Arm Bushing	516612	
	2000.04-2007.01	Front Axle Left & Right Lower	Terrain cab wagon closed 4WD 6G74DOHC		Control Arm Bushing	532420	
	2000.04-2007.01	Front Axle Left & Right Upper	Terrain cab wagon closed 4WD 6G74DOHC		Control Arm Bushing	516294	
	2000.04-2007.01	Rear Axle Left & Right Lower	Terrain cab wagon closed 4WD 6G74DOHC		Control Arm Bushing	512859	
	2000.04-2007.01	Rear Axle Left & Right Lower	Terrain cab wagon closed 4WD 6G74DOHC	Date to:2004.11	Control Arm Bushing	512860	
	2000.04-2007.01	Rear Axle Left & Right Upper	Terrain cab wagon closed 4WD 6G74DOHC		Control Arm Bushing	516029	
	2000.04-2007.01	Rear Axle Left & Right Upper	Terrain cab wagon closed 4WD 6G74DOHC	Date to:2006.08	Control Arm Bushing	516556	
	2000.04-2007.01	Rear Axle Left & Right Upper	Terrain cab wagon closed 4WD 6G74DOHC	Date to:2006.08	Control Arm Bushing	516613	
	2000.04-2007.01	Rear Axle Left & Right Lower Inner	Terrain cab wagon closed 4WD 6G74DOHC		Control Arm Bushing	530005	



	 YEAR	FITTING POSITION	BODY STYLE & DRIVE TYPE & ENGINE	REMARKS	PRODUCT	GSP Ref.
MITSUBISHI						
Montero						
3.5 (149 kw)	2000.04-2007.01	Rear Axle Left & Right Lower Outer	Terrain cab wagon closed 4WD 6G74DOHC	Date to:2006.08	Control Arm Bushing	516220
	2000.04-2007.01	Rear Axle Left & Right Lower Outer	Terrain cab wagon closed 4WD 6G74DOHC		Control Arm Bushing	516222
	2000.04-2007.01	Front Axle Left & Right	Terrain cab wagon closed 4WD 6G74DOHC		Tie Rod Axle Joint	S030187
	2000.04-2007.01	Front Axle Left	Terrain cab wagon closed 4WD 6G74DOHC		Tie Rod End	S070322
	2000.04-2007.01	Front Axle Right	Terrain cab wagon closed 4WD 6G74DOHC		Tie Rod End	S070323
	2000.04-2007.01	Front Axle Left	Terrain cab wagon closed 4WD 6G74DOHC		Rod/Strut,stabiliser	S050323
	2000.04-2007.01	Front Axle Right	Terrain cab wagon closed 4WD 6G74DOHC		Rod/Strut,stabiliser	S050324
	2000.04-2007.01	Rear Axle Left	Terrain cab wagon closed 4WD 6G74DOHC		Rod/Strut,stabiliser	S050325
	2000.04-2007.01	Rear Axle Right	Terrain cab wagon closed 4WD 6G74DOHC		Rod/Strut,stabiliser	S050326
	2000.04-2007.01	Front Axle	Terrain cab wagon closed 4WD 6G74DOHC		Stabiliser Bushing	512846
	2000.04-2007.01	Front Axle	Terrain cab wagon closed 4WD 6G74DOHC		Stabiliser Bushing	517633
	2000.04-2007.01	Front Axle Left	Terrain cab wagon closed 4WD 6G74DOHC		Steering Boot	541014
	2000.04-2007.01	Front Axle Left	Terrain cab wagon closed 4WD 6G74DOHC		Steering Rack Bellow Kit	541014S
	2000.04-2007.01	Rear	Terrain cab wagon closed 4WD 6G74DOHC		Steering Bushing	517596
3.8 (184 kw)	2006.11-	Front Axle Left Upper	Terrain cab wagon closed 4WD 6G75		Track Control Arm	S061063
	2006.11-	Front Axle Right Upper	Terrain cab wagon closed 4WD 6G75		Track Control Arm	S061064
	2006.11-	Rear Axle Left & Right Upper Inner	Terrain cab wagon closed 4WD 6G75		Track Control Arm	S061698
	2006.11-	Front Axle Left & Right Lower	Terrain cab wagon closed 4WD 6G75		Ball Joint	S080158
	2006.11-	Front Axle Left & Right Lower	Terrain cab wagon closed 4WD 6G75		Ball Joint	S080980
	2006.11-	Front Axle Left & Right Upper	Terrain cab wagon closed 4WD 6G75		Ball Joint	S080157
	2006.11-	Rear Axle Left & Right Upper	Terrain cab wagon closed 4WD 6G75		Ball Joint	S080159
	2006.11-	Front Axle Left & Right Lower	Terrain cab wagon closed 4WD 6G75	MT,for OE No.MR496795,AT,Date to:201607	Control Arm Bushing	516304
	2006.11-	Front Axle Left & Right Lower	Terrain cab wagon closed 4WD 6G75	MT,AT,Date to:2013.02	Control Arm Bushing	516612
	2006.11-	Front Axle Left & Right Upper	Terrain cab wagon closed 4WD 6G75		Control Arm Bushing	512854
	2006.11-	Front Axle Left & Right Upper	Terrain cab wagon closed 4WD 6G75	MT,AT,Date to:2013.02	Control Arm Bushing	516294
	2006.11-	Rear Axle Left & Right Lower	Terrain cab wagon closed 4WD 6G75		Control Arm Bushing	512859
	2006.11-	Rear Axle Left & Right Lower	Terrain cab wagon closed 4WD 6G75	MT,AT,Date from-to:2007.07-2013.02	Control Arm Bushing	512860
	2006.11-	Rear Axle Left & Right Upper	Terrain cab wagon closed 4WD 6G75		Control Arm Bushing	516029
	2006.11-	Rear Axle Left & Right Upper	Terrain cab wagon closed 4WD 6G75	MT,AT,Date to:2013.02	Control Arm Bushing	516556
	2006.11-	Rear Axle Left & Right Upper	Terrain cab wagon closed 4WD 6G75	MT,AT,Date to:2013.02	Control Arm Bushing	516613
	2006.11-	Rear Axle Left & Right Lower Inner	Terrain cab wagon closed 4WD 6G75		Control Arm Bushing	530005
	2006.11-	Rear Axle Left & Right Lower Outer	Terrain cab wagon closed 4WD 6G75	MT,AT,Date to:2013.02	Control Arm Bushing	516220
	2006.11-	Rear Axle Left & Right Lower Outer	Terrain cab wagon closed 4WD 6G75		Control Arm Bushing	516222
	2006.11-	Front Axle Left & Right	Terrain cab wagon closed 4WD 6G75		Tie Rod Axle Joint	S030626
	2006.11-	Front Axle Left	Terrain cab wagon closed 4WD 6G75		Tie Rod End	S070324
	2006.11-	Front Axle Right	Terrain cab wagon closed 4WD 6G75		Tie Rod End	S070325
	2006.11-	Front Axle Left	Terrain cab wagon closed 4WD 6G75		Rod/Strut,stabiliser	S050334
	2006.11-	Front Axle Right	Terrain cab wagon closed 4WD 6G75		Rod/Strut,stabiliser	S050335
	2006.11-	Rear Axle Left	Terrain cab wagon closed 4WD 6G75		Rod/Strut,stabiliser	S050325
	2006.11-	Rear Axle Right	Terrain cab wagon closed 4WD 6G75		Rod/Strut,stabiliser	S050326
	2006.11-	Front Axle	Terrain cab wagon closed 4WD 6G75		Stabiliser Bushing	517633
	2006.11-	Front Axle	Terrain cab wagon closed 4WD 6G75		Stabiliser Bushing	530502
	2006.11-	Front Axle Left	Terrain cab wagon closed 4WD 6G75		Steering Boot	541014
	2006.11-	Rear	Terrain cab wagon closed 4WD 6G75		Steering Bushing	517596
Montero Sport						
3.0 (130 kw)	1998.11-2001.09	Front Axle Left Lower	Terrain cab wagon closed 4WD 6G72DOHC		Track Control Arm	S061763
	1998.11-2001.09	Front Axle Left Upper	Terrain cab wagon closed 4WD 6G72DOHC		Track Control Arm	S060956
	1998.11-2001.09	Front Axle Right Lower	Terrain cab wagon closed 4WD 6G72DOHC		Track Control Arm	S061764
	1998.11-2001.09	Front Axle Right Upper	Terrain cab wagon closed 4WD 6G72DOHC		Track Control Arm	S060957
	1998.11-2001.09	Front Axle Left Lower	Terrain cab wagon closed 4WD 6G72DOHC		Ball Joint	S080152
	1998.11-2001.09	Front Axle Right Lower	Terrain cab wagon closed 4WD 6G72DOHC		Ball Joint	S080151
	1998.11-2001.09	Front Axle Left & Right Upper	Terrain cab wagon closed 4WD 6G72DOHC		Ball Joint	S080153
	1998.11-2001.09	Front Axle Left & Right Lower	Terrain cab wagon closed 4WD 6G72DOHC		Control Arm Bushing	511275
	1998.11-2001.09	Front Axle Left & Right Lower	Terrain cab wagon closed 4WD 6G72DOHC		Control Arm Bushing	512853
	1998.11-2001.09	Front Axle Left & Right Upper	Terrain cab wagon closed 4WD 6G72DOHC		Control Arm Bushing	512260
	1998.11-2001.09	Front Axle Left & Right Upper	Terrain cab wagon closed 4WD 6G72DOHC	MT,AT,Date to:1999.08	Control Arm Bushing	516611
	1998.11-2001.09	Rear Axle Left & Right Lower Inner	Terrain cab wagon closed 4WD 6G72DOHC		Control Arm Bushing	516017
	1998.11-2001.09	Rear Axle Left & Right Lower Inner	Terrain cab wagon closed 4WD 6G72DOHC	for left-hand drive vehicles.MT,AT,Date from-to:1999.06-2011.03	Control Arm Bushing	516018
	1998.11-2001.09	Rear Axle Left & Right Lower Outer	Terrain cab wagon closed 4WD 6G72DOHC	for left-hand drive vehicles.MT,AT,Date from-to:1999.06-2011.03	Control Arm Bushing	511260
	1998.11-2001.09	Front Axle	Terrain cab wagon closed 4WD 6G72DOHC		Pitman Arm	S010013
	1998.11-2001.09	Front Axle	Terrain cab wagon closed 4WD 6G72DOHC	For Left-Hand Drive Vehicles	Idler Arm	S010010
	1998.11-2001.09	Front Axle	Terrain cab wagon closed 4WD 6G72DOHC	For Right-Hand Drive Vehicles	Idler Arm	S010041
	1998.11-2001.09	Front Axle Left & Right	Terrain cab wagon closed 4WD 6G72DOHC		Tie Rod End	S070317
	1998.11-2001.09	Front Axle Left & Right Inner	Terrain cab wagon closed 4WD 6G72DOHC		Tie Rod End	S070231



	 YEAR	FITTING POSITION	BODY STYLE & DRIVE TYPE & ENGINE	REMARKS	PRODUCT	GSP Ref.
MITSUBISHI						
Montero Sport						
3.0 (130 kw)	1998.11-2001.09	Front Axle Left & Right Outer	Terrain cab wagon closed 4WD 6G72DOHC		Tie Rod End	S070316
	1998.11-2001.09	Front Axle Left & Right	Terrain cab wagon closed 4WD 6G72DOHC		Rod/Strut,stabiliser	S051371
	1998.11-2001.09	Rear Axle Left & Right	Terrain cab wagon closed 4WD 6G72DOHC		Rod/Strut,stabiliser	520376
	1998.11-2001.09	Front Axle Left & Right Outer	Terrain cab wagon closed 4WD 6G72DOHC		Stabiliser Bushing	512847
	1998.11-2001.09	Front Axle	Terrain cab wagon closed 4WD 6G72DOHC		Stabiliser Bushing	513074
	1998.11-2001.09	Front Axle	Terrain cab wagon closed 4WD 6G72DOHC		Stabiliser Bushing	513327
	1998.11-2001.09	Front Axle	Terrain cab wagon closed 4WD 6G72DOHC		Stabiliser Bushing	516838
	1998.11-2001.09	Front Axle	Terrain cab wagon closed 4WD 6G72DOHC		Stabiliser Bushing	530787
	1998.11-2001.09	Rear Axle	Terrain cab wagon closed 4WD 6G72DOHC		Stabiliser Bushing	513334
3.5 (147 kw)	1999.01-2003.12	Front Axle Left & Right	Terrain cab wagon closed 4WD 6G74DOHC		Rod/Strut,stabiliser	S051371
Outlander						
2.4 (118 kw)	2003.09-2007.09	Front Axle Left Lower	SUV 4WD 4G69		Track Control Arm	S061079
	2003.09-2007.09	Front Axle Right Lower	SUV 4WD 4G69		Track Control Arm	S061080
	2003.09-2007.09	Rear Axle Left & Right Upper	SUV 4WD 4G69		Track Control Arm	S062328
	2003.09-2007.09	Rear Axle Left & Right Lower Inner	SUV 4WD 4G69		Track Control Arm	S051070
	2003.09-2007.09	Front Axle Left & Right Lower	SUV 4WD 4G69	for article no.:SCA-5585	Control Arm Bushing	514925
	2003.09-2007.09	Front Axle Left & Right Lower	SUV 4WD 4G69	for OE No.MR961392	Control Arm Bushing	516175
	2003.09-2007.09	Rear Axle Left & Right Centre	SUV 4WD 4G69	Date to:2004.05	Control Arm Bushing	514945
	2003.09-2007.09	Rear Axle Left & Right Centre	SUV 4WD 4G69		Control Arm Bushing	516606
	2003.09-2007.09	Rear Axle Left & Right Lower	SUV 4WD 4G69		Control Arm Bushing	517761
	2003.09-2007.09	Rear Axle Left & Right Upper	SUV 4WD 4G69	for OE No.MN100086	Control Arm Bushing	514934
	2003.09-2007.09	Rear Axle Left & Right Upper	SUV 4WD 4G69	Date to:2004.05	Control Arm Bushing	516339
	2003.09-2007.09	Rear Axle Left & Right Lower Inner	SUV 4WD 4G69	for left-hand drive vehicles,AT,Date from:2006.06	Control Arm Bushing	516334
	2003.09-2007.09	Rear Axle Left & Right Lower Inner	SUV 4WD 4G69		Control Arm Bushing	516617
	2003.09-2007.09	Rear Axle Left & Right Lower Outer	SUV 4WD 4G69		Control Arm Bushing	514930
	2003.09-2007.09	Front Axle Left & Right	SUV 4WD 4G69		Tie Rod Axle Joint	S030569
	2003.09-2007.09	Front Axle Left & Right	SUV 4WD 4G69		Tie Rod End	S070763
	2003.09-2007.09	Front Axle Left & Right	SUV 4WD 4G69		Rod/Strut,stabiliser	S050735
	2003.09-2007.09	Rear Axle Left & Right	SUV 4WD 4G69		Rod/Strut,stabiliser	S050195
	2003.09-2007.09	Front Axle	SUV 4WD 4G69		Stabiliser Bushing	513332
	2003.09-2007.09	-	SUV 4WD 4G69		Stabiliser Bushing Kit	516875S
	2003.09-2007.09	Front Axle	SUV 4WD 4G69		Steering Bushing	514968
2.4 (125 kw)	2006.11-2013.12	Front Axle Left Lower	SUV 4WD 4B12		Track Control Arm	S060886
	2006.11-2013.12	Front Axle Right Lower	SUV 4WD 4B12		Track Control Arm	S060887
	2006.11-2013.12	Rear Axle Left & Right Upper	SUV 4WD 4B12		Track Control Arm	S061658
	2006.11-2013.12	Rear Axle Left & Right Lower Inner	SUV 4WD 4B12		Track Control Arm	S062634
	2006.11-2013.12	Front Axle Left & Right Lower	SUV 4WD 4B12		Control Arm Bushing	512851
	2006.11-2013.12	Front Axle Left & Right Lower	SUV 4WD 4B12	for left-hand drive vehicles,for right-hand drive vehicles,MT,AT	Control Arm Bushing	513670
	2006.11-2013.12	Rear Axle Left & Right Centre	SUV 4WD 4B12		Control Arm Bushing	516155
	2006.11-2013.12	Rear Axle Left & Right Upper	SUV 4WD 4B12		Control Arm Bushing	516170
	2006.11-2013.12	Rear Axle Left & Right Lower Inner	SUV 4WD 4B12		Control Arm Bushing	516617
	2006.11-2013.12	Rear Axle Left & Right Lower Outer	SUV 4WD 4B12		Control Arm Bushing	514930
	2006.11-2013.12	Front Axle Left & Right	SUV 4WD 4B12		Tie Rod Axle Joint	S030397
	2006.11-2013.12	Front Axle Left & Right	SUV 4WD 4B12		Tie Rod End	S070109
	2006.11-2013.12	Front Axle Left & Right	SUV 4WD 4B12		Rod/Strut,stabiliser	S050118
	2006.11-2013.12	Rear Axle Left	SUV 4WD 4B12		Rod/Strut,stabiliser	S050116
	2006.11-2013.12	Rear Axle Right	SUV 4WD 4B12		Rod/Strut,stabiliser	S050117
	2006.11-2013.12	Front Axle	SUV 4WD 4B12		Stabiliser Bushing	517368
	2006.11-2013.12	Rear Axle	SUV 4WD 4B12		Stabiliser Bushing	517370
	2006.11-2013.12	Front Axle	SUV 4WD 4B12		Steering Boot	540266
	2006.11-2013.12	Front Axle	SUV 4WD 4B12		Steering Rack Bellow Kit	540266S
3.0 (162 kw)	2006.11-2013.08	Front Axle Left Lower	SUV 4WD 6B31		Track Control Arm	S060886
	2006.11-2013.08	Front Axle Right Lower	SUV 4WD 6B31		Track Control Arm	S060887
	2006.11-2013.08	Rear Axle Left & Right Upper	SUV 4WD 6B31		Track Control Arm	S061658
	2006.11-2013.08	Rear Axle Left & Right Lower Inner	SUV 4WD 6B31		Track Control Arm	S062634
	2006.11-2013.08	Front Axle Left & Right Lower	SUV 4WD 6B31		Ball Joint	S080475
	2006.11-2013.08	Front Axle Left & Right Lower	SUV 4WD 6B31		Control Arm Bushing	512851
	2006.11-2013.08	Front Axle Left & Right Lower	SUV 4WD 6B31	AT	Control Arm Bushing	513670
	2006.11-2013.08	Rear Axle Left & Right Centre	SUV 4WD 6B31		Control Arm Bushing	516155
	2006.11-2013.08	Rear Axle Left & Right Upper	SUV 4WD 6B31		Control Arm Bushing	516170
	2006.11-2013.08	Rear Axle Left & Right Lower Inner	SUV 4WD 6B31		Control Arm Bushing	516617
	2006.11-2013.08	Rear Axle Left & Right Lower Outer	SUV 4WD 6B31		Control Arm Bushing	514930
	2006.11-2013.08	Front Axle Left & Right	SUV 4WD 6B31		Tie Rod Axle Joint	S030397
	2006.11-2013.08	Front Axle Left & Right	SUV 4WD 6B31		Tie Rod End	S070109



	 YEAR	FITTING POSITION	BODY STYLE & DRIVE TYPE & ENGINE	REMARKS	PRODUCT	GSP Ref.
MITSUBISHI						
Outlander						
3.0 (162 kw)	2006.11-2013.08	Front Axle Left & Right	SUV 4WD 6B31		Rod/Strut, stabiliser	S050118
	2006.11-2013.08	Rear Axle Left	SUV 4WD 6B31		Rod/Strut, stabiliser	S050116
	2006.11-2013.08	Rear Axle Right	SUV 4WD 6B31		Rod/Strut, stabiliser	S050117
	2006.11-2013.08	Front Axle	SUV 4WD 6B31		Stabiliser Bushing	517368
	2006.11-2013.08	Rear Axle	SUV 4WD 6B31		Stabiliser Bushing	517370
	2006.11-2013.08	Front Axle	SUV 4WD 6B31		Steering Rack Bellow Kit	540266S
Pajero						
2.5 (73 kw)	1990.12-1999.10	Front Axle Left Lower	Terrain cab wagon closed 4WD 4D56		Track Control Arm	S061948
	1990.12-1999.10	Front Axle Left Upper	Terrain cab wagon closed 4WD 4D56		Track Control Arm	S060956
	1990.12-1999.10	Front Axle Right Lower	Terrain cab wagon closed 4WD 4D56		Track Control Arm	S061949
	1990.12-1999.10	Front Axle Right Upper	Terrain cab wagon closed 4WD 4D56		Track Control Arm	S060957
	1990.12-1999.10	Front Axle Left Lower	Terrain cab wagon closed 4WD 4D56		Ball Joint	S080152
	1990.12-1999.10	Front Axle Right Lower	Terrain cab wagon closed 4WD 4D56		Ball Joint	S080151
	1990.12-1999.10	Front Axle Left & Right Upper	Terrain cab wagon closed 4WD 4D56		Ball Joint	S080153
	1990.12-1999.10	Front Axle Left & Right Lower	Terrain cab wagon closed 4WD 4D56		Control Arm Bushing	511275
	1990.12-1999.10	Front Axle Left & Right Lower	Terrain cab wagon closed 4WD 4D56		Control Arm Bushing	512853
	1990.12-1999.10	Front Axle Left & Right Lower	Terrain cab wagon closed 4WD 4D56		Control Arm Bushing	512861
	1990.12-1999.10	Front Axle Left & Right Upper	Terrain cab wagon closed 4WD 4D56	Date from: 1996.06	Control Arm Bushing	512260
	1990.12-1999.10	Front Axle Left & Right Upper	Terrain cab wagon closed 4WD 4D56		Control Arm Bushing	512260
	1990.12-1999.10	Rear Axle Left & Right Lower	Terrain cab wagon closed 4WD 4D56		Control Arm Bushing	511259
	1990.12-1999.10	Rear Axle Left & Right Lower	Terrain cab wagon closed 4WD 4D56	Quantity:2	Control Arm Bushing	512857
	1990.12-1999.10	Rear Axle Left & Right Lower	Terrain cab wagon closed 4WD 4D56		Control Arm Bushing	512857
	1990.12-1999.10	Rear Axle Left & Right Lower Outer	Terrain cab wagon closed 4WD 4D56	Date to: 1997.03	Control Arm Bushing	511260
	1990.12-1999.10	Front Axle	Terrain cab wagon closed 4WD 4D56		Pitman Arm	S010003
	1990.12-1999.10	Front Axle	Terrain cab wagon closed 4WD 4D56		Idler Arm	S010002
	1990.12-1999.10	Front Axle Left & Right	Terrain cab wagon closed 4WD 4D56		Tie Rod End	S070317
	1990.12-1999.10	Front Axle Left & Right Outer	Terrain cab wagon closed 4WD 4D56		Tie Rod End	S070316
	1990.12-1999.10	Front Axle Left	Terrain cab wagon closed 4WD 4D56		Rod/Strut, stabiliser	S050327
	1990.12-1999.10	Front Axle Right	Terrain cab wagon closed 4WD 4D56		Rod/Strut, stabiliser	S050328
	1990.12-1999.10	Front Axle Left & Right	Terrain cab wagon closed 4WD 4D56		Rod/Strut, stabiliser	513353
	1990.12-1999.10	Front Axle Left & Right	Terrain cab wagon closed 4WD 4D56		Rod/Strut, stabiliser	S050329
	1990.12-1999.10	Rear Axle Left & Right	Terrain cab wagon closed 4WD 4D56		Rod/Strut, stabiliser	513355
	1990.12-1999.10	Rear Axle Left & Right	Terrain cab wagon closed 4WD 4D56		Rod/Strut, stabiliser	520376
	1990.12-1999.10	Front Axle	Terrain cab wagon closed 4WD 4D56		Stabiliser Bushing	512843
	1990.12-1999.10	Front Axle	Terrain cab wagon closed 4WD 4D56		Stabiliser Bushing	512844
	1990.12-1999.10	Front Axle	Terrain cab wagon closed 4WD 4D56		Stabiliser Bushing	513074
	1990.12-1999.10	Front Axle	Terrain cab wagon closed 4WD 4D56		Stabiliser Bushing	513327
	1990.12-1999.10	Front Axle	Terrain cab wagon closed 4WD 4D56		Stabiliser Bushing	513612
	1990.12-1999.10	Front Axle	Terrain cab wagon closed 4WD 4D56		Stabiliser Bushing	517552
	1990.12-1999.10	Front Axle	Terrain cab wagon closed 4WD 4D56		Stabiliser Bushing	517673
	1990.12-1999.10	Front Axle Left	Terrain cab wagon closed 4WD 4D56		Steering Rack Bellow Kit	541014S
	1990.12-1999.10	Front Axle	Terrain cab wagon closed 4WD 4D56		Stabiliser Bushing Kit	513354S
2.8 (92 kw)	1993.11-2000.04	Front Axle Left Lower	Terrain cab wagon closed 4WD 4M40T		Track Control Arm	S061948
	1993.11-2000.04	Front Axle Left Upper	Terrain cab wagon closed 4WD 4M40T		Track Control Arm	S060956
	1993.11-2000.04	Front Axle Right Lower	Terrain cab wagon closed 4WD 4M40T		Track Control Arm	S061949
	1993.11-2000.04	Front Axle Right Upper	Terrain cab wagon closed 4WD 4M40T		Track Control Arm	S060957
	1993.11-2000.04	Front Axle Left Lower	Terrain cab wagon closed 4WD 4M40T		Ball Joint	S080152
	1993.11-2000.04	Front Axle Right Lower	Terrain cab wagon closed 4WD 4M40T		Ball Joint	S080151
	1993.11-2000.04	Front Axle Left & Right Upper	Terrain cab wagon closed 4WD 4M40T		Ball Joint	S080153
	1993.11-2000.04	Front Axle Left & Right Lower	Terrain cab wagon closed 4WD 4M40T		Control Arm Bushing	511275
	1993.11-2000.04	Front Axle Left & Right Lower	Terrain cab wagon closed 4WD 4M40T		Control Arm Bushing	512853
	1993.11-2000.04	Front Axle Left & Right Lower	Terrain cab wagon closed 4WD 4M40T		Control Arm Bushing	512861
	1993.11-2000.04	Front Axle Left & Right Upper	Terrain cab wagon closed 4WD 4M40T		Control Arm Bushing	512260
	1993.11-2000.04	Front Axle Left & Right Upper	Terrain cab wagon closed 4WD 4M40T	Date from-to: 1997.04-1997.11	Control Arm Bushing	516611
	1993.11-2000.04	Rear Axle Left & Right Lower	Terrain cab wagon closed 4WD 4M40T		Control Arm Bushing	512857
	1993.11-2000.04	Rear Axle Left & Right Lower Outer	Terrain cab wagon closed 4WD 4M40T		Control Arm Bushing	511260
	1993.11-2000.04	Front Axle	Terrain cab wagon closed 4WD 4M40T		Pitman Arm	S010003
	1993.11-2000.04	Front Axle	Terrain cab wagon closed 4WD 4M40T		Idler Arm	S010002
	1993.11-2000.04	Front Axle Left & Right	Terrain cab wagon closed 4WD 4M40T		Tie Rod End	S070317
	1993.11-2000.04	Front Axle Left & Right Outer	Terrain cab wagon closed 4WD 4M40T		Tie Rod End	S070316
	1993.11-2000.04	Front Axle Left	Terrain cab wagon closed 4WD 4M40T		Rod/Strut, stabiliser	S050327
	1993.11-2000.04	Front Axle Right	Terrain cab wagon closed 4WD 4M40T		Rod/Strut, stabiliser	S050328
	1993.11-2000.04	Front Axle Left & Right	Terrain cab wagon closed 4WD 4M40T		Rod/Strut, stabiliser	513353
	1993.11-2000.04	Rear Axle Left & Right	Terrain cab wagon closed 4WD 4M40T		Rod/Strut, stabiliser	513355



	 YEAR	FITTING POSITION	BODY STYLE & DRIVE TYPE & ENGINE	REMARKS	PRODUCT	GSP Ref.
MITSUBISHI Pajero						
2.8 (92 kw)	1993.11-2000.04	Rear Axle Left & Right	Terrain cab wagon closed 4WD 4M40T		Rod/Strut, stabiliser	520376
	1993.11-2000.04	Front Axle	Terrain cab wagon closed 4WD 4M40T		Stabiliser Bushing	512844
	1993.11-2000.04	Front Axle	Terrain cab wagon closed 4WD 4M40T		Stabiliser Bushing	513074
	1993.11-2000.04	Front Axle	Terrain cab wagon closed 4WD 4M40T		Stabiliser Bushing	513327
	1993.11-2000.04	Front Axle	Terrain cab wagon closed 4WD 4M40T		Stabiliser Bushing	513612
	1993.11-2000.04	Front Axle	Terrain cab wagon closed 4WD 4M40T		Stabiliser Bushing	517552
	1993.11-2000.04	Front Axle	Terrain cab wagon closed 4WD 4M40T		Stabiliser Bushing	517673
	1993.11-2000.04	Rear Axle	Terrain cab wagon closed 4WD 4M40T		Stabiliser Bushing	513328
	1993.11-2000.04	Rear Axle	Terrain cab wagon closed 4WD 4M40T		Stabiliser Bushing	517571
	1993.11-2000.04	Front Axle Left	Terrain cab wagon closed 4WD 4M40T		Steering Rack Bellow Kit	541014S
3.0 (110 kw)	1990.12-1995.12	Front Axle Left Lower	Terrain cab wagon closed 4WD 6G72		Track Control Arm	S061948
	1990.12-1995.12	Front Axle Left Upper	Terrain cab wagon closed 4WD 6G72		Track Control Arm	S060956
	1990.12-1995.12	Front Axle Right Lower	Terrain cab wagon closed 4WD 6G72		Track Control Arm	S061949
	1990.12-1995.12	Front Axle Right Upper	Terrain cab wagon closed 4WD 6G72		Track Control Arm	S060957
	1990.12-1995.12	Front Axle Left Lower	Terrain cab wagon closed 4WD 6G72		Ball Joint	S080152
	1990.12-1995.12	Front Axle Right Lower	Terrain cab wagon closed 4WD 6G72		Ball Joint	S080151
	1990.12-1995.12	Front Axle Left & Right Upper	Terrain cab wagon closed 4WD 6G72		Ball Joint	S080153
	1990.12-1995.12	Front Axle Left & Right Lower	Terrain cab wagon closed 4WD 6G72		Control Arm Bushing	511275
	1990.12-1995.12	Front Axle Left & Right Lower	Terrain cab wagon closed 4WD 6G72		Control Arm Bushing	512853
	1990.12-1995.12	Front Axle Left & Right Lower	Terrain cab wagon closed 4WD 6G72		Control Arm Bushing	512861
	1990.12-1995.12	Front Axle Left & Right Upper	Terrain cab wagon closed 4WD 6G72		Control Arm Bushing	512260
	1990.12-1995.12	Rear Axle Left & Right Lower	Terrain cab wagon closed 4WD 6G72		Control Arm Bushing	511259
	1990.12-1995.12	Rear Axle Left & Right Lower	Terrain cab wagon closed 4WD 6G72		Control Arm Bushing	512857
	1990.12-1995.12	Rear Axle Left & Right Lower Outer	Terrain cab wagon closed 4WD 6G72		Control Arm Bushing	511260
	1990.12-1995.12	Front Axle	Terrain cab wagon closed 4WD 6G72		Pitman Arm	S010003
	1990.12-1995.12	Front Axle	Terrain cab wagon closed 4WD 6G72		Idler Arm	S010002
	1990.12-1995.12	Front Axle Left & Right	Terrain cab wagon closed 4WD 6G72		Tie Rod End	S070317
	1990.12-1995.12	Front Axle Left & Right Outer	Terrain cab wagon closed 4WD 6G72		Tie Rod End	S070316
	1990.12-1995.12	Front Axle Left	Terrain cab wagon closed 4WD 6G72		Rod/Strut, stabiliser	S050327
	1990.12-1995.12	Front Axle Right	Terrain cab wagon closed 4WD 6G72		Rod/Strut, stabiliser	S050328
	1990.12-1995.12	Front Axle Left & Right	Terrain cab wagon closed 4WD 6G72		Rod/Strut, stabiliser	513353
	1990.12-1995.12	Front Axle Left & Right	Terrain cab wagon closed 4WD 6G72		Rod/Strut, stabiliser	S050329
	1990.12-1995.12	Rear Axle Left & Right	Terrain cab wagon closed 4WD 6G72		Rod/Strut, stabiliser	513355
	1990.12-1995.12	Rear Axle Left & Right	Terrain cab wagon closed 4WD 6G72		Rod/Strut, stabiliser	520376
	1990.12-1995.12	Front Axle	Terrain cab wagon closed 4WD 6G72		Stabiliser Bushing	512843
	1990.12-1995.12	Front Axle	Terrain cab wagon closed 4WD 6G72		Stabiliser Bushing	512844
	1990.12-1995.12	Front Axle	Terrain cab wagon closed 4WD 6G72		Stabiliser Bushing	513074
	1990.12-1995.12	Front Axle	Terrain cab wagon closed 4WD 6G72		Stabiliser Bushing	513327
	1990.12-1995.12	Front Axle	Terrain cab wagon closed 4WD 6G72		Stabiliser Bushing	513612
	1990.12-1995.12	Front Axle	Terrain cab wagon closed 4WD 6G72		Stabiliser Bushing	517552
	1990.12-1995.12	Front Axle	Terrain cab wagon closed 4WD 6G72		Stabiliser Bushing	517673
	1990.12-1995.12	Rear Axle	Terrain cab wagon closed 4WD 6G72		Stabiliser Bushing	513328
	1990.12-1995.12	Front Axle Left	Terrain cab wagon closed 4WD 6G72		Steering Rack Bellow Kit	541014S
	1990.12-1995.12	Front Axle	Terrain cab wagon closed 4WD 6G72		Stabiliser Bushing Kit	513354S
3.5 (149 kw)	2000.04-2007.01	Front Axle Left Lower	Terrain cab wagon closed 4WD 6G74DOHC		Track Control Arm	S062001
	2000.04-2007.01	Front Axle Left Upper	Terrain cab wagon closed 4WD 6G74DOHC		Track Control Arm	S061063
	2000.04-2007.01	Front Axle Right Lower	Terrain cab wagon closed 4WD 6G74DOHC		Track Control Arm	S062002
	2000.04-2007.01	Front Axle Right Upper	Terrain cab wagon closed 4WD 6G74DOHC		Track Control Arm	S061064
	2000.04-2007.01	Rear Axle Left & Right Upper Inner	Terrain cab wagon closed 4WD 6G74DOHC		Track Control Arm	S061698
	2000.04-2007.01	Front Axle Left & Right Lower	Terrain cab wagon closed 4WD 6G74DOHC		Ball Joint	S080158
	2000.04-2007.01	Front Axle Left & Right Lower	Terrain cab wagon closed 4WD 6G74DOHC		Ball Joint	S080980
	2000.04-2007.01	Front Axle Left & Right Upper	Terrain cab wagon closed 4WD 6G74DOHC		Ball Joint	S080157
	2000.04-2007.01	Rear Axle Left & Right Upper	Terrain cab wagon closed 4WD 6G74DOHC		Ball Joint	S080159
	2000.04-2007.01	Front Axle Left & Right Lower	Terrain cab wagon closed 4WD 6G74DOHC	for OE No. MR496795. Date to: 2006.08	Control Arm Bushing	516304
	2000.04-2007.01	Front Axle Left & Right Lower	Terrain cab wagon closed 4WD 6G74DOHC	Date to: 2006.08	Control Arm Bushing	516612
	2000.04-2007.01	Front Axle Left & Right Lower	Terrain cab wagon closed 4WD 6G74DOHC		Control Arm Bushing	532420
	2000.04-2007.01	Front Axle Left & Right Upper	Terrain cab wagon closed 4WD 6G74DOHC		Control Arm Bushing	516294
	2000.04-2007.01	Rear Axle Left & Right Lower	Terrain cab wagon closed 4WD 6G74DOHC		Control Arm Bushing	512859
	2000.04-2007.01	Rear Axle Left & Right Lower	Terrain cab wagon closed 4WD 6G74DOHC	Date to: 2004.11	Control Arm Bushing	512860
	2000.04-2007.01	Rear Axle Left & Right Upper	Terrain cab wagon closed 4WD 6G74DOHC		Control Arm Bushing	516029
	2000.04-2007.01	Rear Axle Left & Right Upper	Terrain cab wagon closed 4WD 6G74DOHC	Date to: 2006.08	Control Arm Bushing	516556
	2000.04-2007.01	Rear Axle Left & Right Upper	Terrain cab wagon closed 4WD 6G74DOHC	Date to: 2006.08	Control Arm Bushing	516613
	2000.04-2007.01	Rear Axle Left & Right Lower Inner	Terrain cab wagon closed 4WD 6G74DOHC		Control Arm Bushing	530005
	2000.04-2007.01	Rear Axle Left & Right Lower Outer	Terrain cab wagon closed 4WD 6G74DOHC	Date to: 2006.08	Control Arm Bushing	516220



	 YEAR	FITTING POSITION	BODY STYLE & DRIVE TYPE & ENGINE	REMARKS	PRODUCT	GSP Ref.
MITSUBISHI						
Pajero						
3.5 (149 kw)	2000.04-2007.01	Rear Axle Left & Right Lower Outer	Terrain cab wagon closed 4WD 6G74DOHC		Control Arm Bushing	516222
	2000.04-2007.01	Front Axle Left & Right	Terrain cab wagon closed 4WD 6G74DOHC		Tie Rod Axle Joint	S030187
	2000.04-2007.01	Front Axle Left	Terrain cab wagon closed 4WD 6G74DOHC		Tie Rod End	S070322
	2000.04-2007.01	Front Axle Right	Terrain cab wagon closed 4WD 6G74DOHC		Tie Rod End	S070323
	2000.04-2007.01	Front Axle Left	Terrain cab wagon closed 4WD 6G74DOHC		Rod/Strut,stabiliser	S050323
	2000.04-2007.01	Front Axle Right	Terrain cab wagon closed 4WD 6G74DOHC		Rod/Strut,stabiliser	S050324
	2000.04-2007.01	Rear Axle Left	Terrain cab wagon closed 4WD 6G74DOHC		Rod/Strut,stabiliser	S050325
	2000.04-2007.01	Rear Axle Right	Terrain cab wagon closed 4WD 6G74DOHC		Rod/Strut,stabiliser	S050326
	2000.04-2007.01	Front Axle	Terrain cab wagon closed 4WD 6G74DOHC		Stabiliser Bushing	512846
	2000.04-2007.01	Front Axle	Terrain cab wagon closed 4WD 6G74DOHC		Stabiliser Bushing	517633
	2000.04-2007.01	Front Axle Left	Terrain cab wagon closed 4WD 6G74DOHC		Steering Boot	541014
	2000.04-2007.01	Front Axle Left	Terrain cab wagon closed 4WD 6G74DOHC		Steering Rack Bellow Kit	541014S
	2000.04-2007.01	Rear	Terrain cab wagon closed 4WD 6G74DOHC		Steering Bushing	517596
Pajero Sport						
3.0 (130 kw)	1998.11-2001.09	Front Axle Left Lower	Terrain cab wagon closed 4WD 6G72DOHC		Track Control Arm	S061763
	1998.11-2001.09	Front Axle Left Upper	Terrain cab wagon closed 4WD 6G72DOHC		Track Control Arm	S060956
	1998.11-2001.09	Front Axle Right Lower	Terrain cab wagon closed 4WD 6G72DOHC		Track Control Arm	S061764
	1998.11-2001.09	Front Axle Right Upper	Terrain cab wagon closed 4WD 6G72DOHC		Track Control Arm	S060957
	1998.11-2001.09	Front Axle Left Lower	Terrain cab wagon closed 4WD 6G72DOHC		Ball Joint	S080152
	1998.11-2001.09	Front Axle Right Lower	Terrain cab wagon closed 4WD 6G72DOHC		Ball Joint	S080151
	1998.11-2001.09	Front Axle Left & Right Upper	Terrain cab wagon closed 4WD 6G72DOHC		Ball Joint	S080153
	1998.11-2001.09	Front Axle Left & Right Lower	Terrain cab wagon closed 4WD 6G72DOHC		Control Arm Bushing	511275
	1998.11-2001.09	Front Axle Left & Right Lower	Terrain cab wagon closed 4WD 6G72DOHC		Control Arm Bushing	512853
	1998.11-2001.09	Front Axle Left & Right Upper	Terrain cab wagon closed 4WD 6G72DOHC		Control Arm Bushing	512260
	1998.11-2001.09	Front Axle Left & Right Upper	Terrain cab wagon closed 4WD 6G72DOHC	MT,AT,Date to:1999.08	Control Arm Bushing	516611
	1998.11-2001.09	Rear Axle Left & Right Lower Inner	Terrain cab wagon closed 4WD 6G72DOHC		Control Arm Bushing	516017
	1998.11-2001.09	Rear Axle Left & Right Lower Inner	Terrain cab wagon closed 4WD 6G72DOHC	for left-hand drive vehicles,MT,AT,Date from-to:1999.06-2011.03	Control Arm Bushing	516018
	1998.11-2001.09	Rear Axle Left & Right Lower Outer	Terrain cab wagon closed 4WD 6G72DOHC	for left-hand drive vehicles,MT,AT,Date from-to:1999.06-2011.03	Control Arm Bushing	511260
	1998.11-2001.09	Front Axle	Terrain cab wagon closed 4WD 6G72DOHC		Pitman Arm	S010013
	1998.11-2001.09	Front Axle	Terrain cab wagon closed 4WD 6G72DOHC	For Left-Hand Drive Vehicles	Idler Arm	S010010
	1998.11-2001.09	Front Axle	Terrain cab wagon closed 4WD 6G72DOHC	For Right-Hand Drive Vehicles	Idler Arm	S010041
	1998.11-2001.09	Front Axle Left & Right	Terrain cab wagon closed 4WD 6G72DOHC		Tie Rod End	S070317
	1998.11-2001.09	Front Axle Left & Right Inner	Terrain cab wagon closed 4WD 6G72DOHC		Tie Rod End	S070231
	1998.11-2001.09	Front Axle Left & Right Outer	Terrain cab wagon closed 4WD 6G72DOHC		Tie Rod End	S070316
	1998.11-2001.09	Front Axle Left & Right	Terrain cab wagon closed 4WD 6G72DOHC		Rod/Strut,stabiliser	S051371
	1998.11-2001.09	Rear Axle Left & Right	Terrain cab wagon closed 4WD 6G72DOHC		Rod/Strut,stabiliser	520376
	1998.11-2001.09	Front Axle Left & Right Outer	Terrain cab wagon closed 4WD 6G72DOHC		Stabiliser Bushing	512847
	1998.11-2001.09	Front Axle	Terrain cab wagon closed 4WD 6G72DOHC		Stabiliser Bushing	513074
	1998.11-2001.09	Front Axle	Terrain cab wagon closed 4WD 6G72DOHC		Stabiliser Bushing	513327
	1998.11-2001.09	Front Axle	Terrain cab wagon closed 4WD 6G72DOHC		Stabiliser Bushing	516838
	1998.11-2001.09	Front Axle	Terrain cab wagon closed 4WD 6G72DOHC		Stabiliser Bushing	530787
	1998.11-2001.09	Rear Axle	Terrain cab wagon closed 4WD 6G72DOHC		Stabiliser Bushing	513334
3.2 (121 kw)	2008.01-2015.12	Front Axle Left & Right Lower	Terrain cab wagon closed 4WD 4M41R		Ball Joint	S080980
	2008.01-2015.12	Rear Axle Left & Right Upper	Terrain cab wagon closed 4WD 4M41R		Control Arm Bushing	516253
	2008.01-2015.12	Rear Axle Left & Right Lower Inner	Terrain cab wagon closed 4WD 4M41R		Control Arm Bushing	516017
	2008.01-2015.12	Rear Axle Left & Right Lower Inner	Terrain cab wagon closed 4WD 4M41R	for left-hand drive vehicles,AT,Date to:2014.09,Date to:2012.09	Control Arm Bushing	516018
	2008.01-2015.12	Rear Axle Left & Right Lower Outer	Terrain cab wagon closed 4WD 4M41R	for left-hand drive vehicles,AT,Date to:2012.09	Control Arm Bushing	511260
	2008.01-2015.12	Front Axle Left & Right	Terrain cab wagon closed 4WD 4M41R		Tie Rod Axle Joint	S030579
	2008.01-2015.12	Front Axle Left	Terrain cab wagon closed 4WD 4M41R		Rod/Strut,stabiliser	S050627
	2008.01-2015.12	Front Axle Right	Terrain cab wagon closed 4WD 4M41R		Rod/Strut,stabiliser	S050626
Shogun						
2.5 (73 kw)	1991.03-2000.04	Front Axle Left Lower	Terrain cab wagon closed 4WD 4D56		Track Control Arm	S061948
	1991.03-2000.04	Front Axle Left Upper	Terrain cab wagon closed 4WD 4D56		Track Control Arm	S060956
	1991.03-2000.04	Front Axle Right Lower	Terrain cab wagon closed 4WD 4D56		Track Control Arm	S061949
	1991.03-2000.04	Front Axle Right Upper	Terrain cab wagon closed 4WD 4D56		Track Control Arm	S060957
	1991.03-2000.04	Front Axle Left Lower	Terrain cab wagon closed 4WD 4D56		Ball Joint	S080152
	1991.03-2000.04	Front Axle Right Lower	Terrain cab wagon closed 4WD 4D56		Ball Joint	S080151
	1991.03-2000.04	Front Axle Left & Right Upper	Terrain cab wagon closed 4WD 4D56		Ball Joint	S080153
	1991.03-2000.04	Front Axle Left & Right Lower	Terrain cab wagon closed 4WD 4D56		Control Arm Bushing	511275
	1991.03-2000.04	Front Axle Left & Right Lower	Terrain cab wagon closed 4WD 4D56		Control Arm Bushing	512853
	1991.03-2000.04	Front Axle Left & Right Lower	Terrain cab wagon closed 4WD 4D56		Control Arm Bushing	512861
	1991.03-2000.04	Front Axle Left & Right Upper	Terrain cab wagon closed 4WD 4D56	Date from:1996.06	Control Arm Bushing	512260
	1991.03-2000.04	Front Axle Left & Right Upper	Terrain cab wagon closed 4WD 4D56		Control Arm Bushing	512260
	1991.03-2000.04	Rear Axle Left & Right Lower	Terrain cab wagon closed 4WD 4D56		Control Arm Bushing	511259



	 YEAR	FITTING POSITION	BODY STYLE & DRIVE TYPE & ENGINE	REMARKS	PRODUCT	GSP Ref.
MITSUBISHI Shogun						
2.5 (73 kw)	1991.03-2000.04	Rear Axle Left & Right Lower	Terrain cab wagon closed 4WD 4D56	Quantity:2	Control Arm Bushing	512857
	1991.03-2000.04	Rear Axle Left & Right Lower	Terrain cab wagon closed 4WD 4D56		Control Arm Bushing	512857
	1991.03-2000.04	Rear Axle Left & Right Lower Outer	Terrain cab wagon closed 4WD 4D56	Date to:1997.03	Control Arm Bushing	511260
	1991.03-2000.04	Front Axle	Terrain cab wagon closed 4WD 4D56		Pitman Arm	S010003
	1991.03-2000.04	Front Axle	Terrain cab wagon closed 4WD 4D56		Idler Arm	S010002
	1991.03-2000.04	Front Axle Left & Right	Terrain cab wagon closed 4WD 4D56		Tie Rod End	S070317
	1991.03-2000.04	Front Axle Left & Right Outer	Terrain cab wagon closed 4WD 4D56		Tie Rod End	S070316
	1991.03-2000.04	Front Axle Left	Terrain cab wagon closed 4WD 4D56		Rod/Strut, stabiliser	S050327
	1991.03-2000.04	Front Axle Right	Terrain cab wagon closed 4WD 4D56		Rod/Strut, stabiliser	S050328
	1991.03-2000.04	Front Axle Left & Right	Terrain cab wagon closed 4WD 4D56		Rod/Strut, stabiliser	513353
	1991.03-2000.04	Front Axle Left & Right	Terrain cab wagon closed 4WD 4D56		Rod/Strut, stabiliser	S050329
	1991.03-2000.04	Rear Axle Left & Right	Terrain cab wagon closed 4WD 4D56		Rod/Strut, stabiliser	513355
	1991.03-2000.04	Rear Axle Left & Right	Terrain cab wagon closed 4WD 4D56		Rod/Strut, stabiliser	520376
	1991.03-2000.04	Front Axle	Terrain cab wagon closed 4WD 4D56		Stabiliser Bushing	512843
	1991.03-2000.04	Front Axle	Terrain cab wagon closed 4WD 4D56		Stabiliser Bushing	512844
	1991.03-2000.04	Front Axle	Terrain cab wagon closed 4WD 4D56		Stabiliser Bushing	513074
	1991.03-2000.04	Front Axle	Terrain cab wagon closed 4WD 4D56		Stabiliser Bushing	513327
	1991.03-2000.04	Front Axle	Terrain cab wagon closed 4WD 4D56		Stabiliser Bushing	513327
	1991.03-2000.04	Front Axle	Terrain cab wagon closed 4WD 4D56		Stabiliser Bushing	513612
	1991.03-2000.04	Front Axle	Terrain cab wagon closed 4WD 4D56		Stabiliser Bushing	517552
	1991.03-2000.04	Front Axle	Terrain cab wagon closed 4WD 4D56		Stabiliser Bushing	517673
	1991.03-2000.04	Front Axle Left	Terrain cab wagon closed 4WD 4D56		Steering Rack Bellow Kit	541014S
	1991.03-2000.04	Front Axle	Terrain cab wagon closed 4WD 4D56		Stabiliser Bushing Kit	513354S
2.8 (92 kw)	1994.06-2000.04	Front Axle Left Lower	Terrain cab wagon closed 4WD 4M40T		Track Control Arm	S061948
	1994.06-2000.04	Front Axle Left Upper	Terrain cab wagon closed 4WD 4M40T		Track Control Arm	S060956
	1994.06-2000.04	Front Axle Right Lower	Terrain cab wagon closed 4WD 4M40T		Track Control Arm	S061949
	1994.06-2000.04	Front Axle Right Upper	Terrain cab wagon closed 4WD 4M40T		Track Control Arm	S060957
	1994.06-2000.04	Front Axle Left Lower	Terrain cab wagon closed 4WD 4M40T		Ball Joint	S080152
	1994.06-2000.04	Front Axle Right Lower	Terrain cab wagon closed 4WD 4M40T		Ball Joint	S080151
	1994.06-2000.04	Front Axle Left & Right Upper	Terrain cab wagon closed 4WD 4M40T		Ball Joint	S080153
	1994.06-2000.04	Front Axle Left & Right Lower	Terrain cab wagon closed 4WD 4M40T		Control Arm Bushing	511275
	1994.06-2000.04	Front Axle Left & Right Lower	Terrain cab wagon closed 4WD 4M40T		Control Arm Bushing	512853
	1994.06-2000.04	Front Axle Left & Right Lower	Terrain cab wagon closed 4WD 4M40T		Control Arm Bushing	512861
	1994.06-2000.04	Front Axle Left & Right Upper	Terrain cab wagon closed 4WD 4M40T	Date from:1996.06 for vehicles without heavy duty suspension	Control Arm Bushing	512260
	1994.06-2000.04	Front Axle Left & Right Upper	Terrain cab wagon closed 4WD 4M40T		Control Arm Bushing	512260
	1994.06-2000.04	Front Axle Left & Right Upper	Terrain cab wagon closed 4WD 4M40T	Date from-to:1997.04-1997.11	Control Arm Bushing	516611
	1994.06-2000.04	Rear Axle Left & Right Lower	Terrain cab wagon closed 4WD 4M40T	Quantity:2	Control Arm Bushing	512857
	1994.06-2000.04	Rear Axle Left & Right Lower	Terrain cab wagon closed 4WD 4M40T		Control Arm Bushing	512857
	1994.06-2000.04	Rear Axle Left & Right Lower Outer	Terrain cab wagon closed 4WD 4M40T		Control Arm Bushing	511260
	1994.06-2000.04	Front Axle	Terrain cab wagon closed 4WD 4M40T		Pitman Arm	S010003
	1994.06-2000.04	Front Axle	Terrain cab wagon closed 4WD 4M40T		Idler Arm	S010002
	1994.06-2000.04	Front Axle Left & Right	Terrain cab wagon closed 4WD 4M40T	For Modelcode:V26W	Tie Rod End	S070317
	1994.06-2000.04	Front Axle Left & Right	Terrain cab wagon closed 4WD 4M40T		Tie Rod End	S070317
	1994.06-2000.04	Front Axle Left & Right Outer	Terrain cab wagon closed 4WD 4M40T		Tie Rod End	S070316
	1994.06-2000.04	Front Axle Left	Terrain cab wagon closed 4WD 4M40T		Rod/Strut, stabiliser	S050327
	1994.06-2000.04	Front Axle Right	Terrain cab wagon closed 4WD 4M40T		Rod/Strut, stabiliser	S050328
	1994.06-2000.04	Front Axle Left & Right	Terrain cab wagon closed 4WD 4M40T		Rod/Strut, stabiliser	513353
	1994.06-2000.04	Rear Axle Left & Right	Terrain cab wagon closed 4WD 4M40T		Rod/Strut, stabiliser	513355
	1994.06-2000.04	Rear Axle Left & Right	Terrain cab wagon closed 4WD 4M40T		Rod/Strut, stabiliser	520376
	1994.06-2000.04	Front Axle	Terrain cab wagon closed 4WD 4M40T		Stabiliser Bushing	512844
	1994.06-2000.04	Front Axle	Terrain cab wagon closed 4WD 4M40T		Stabiliser Bushing	513074
	1994.06-2000.04	Front Axle	Terrain cab wagon closed 4WD 4M40T		Stabiliser Bushing	513327
	1994.06-2000.04	Front Axle	Terrain cab wagon closed 4WD 4M40T		Stabiliser Bushing	513612
	1994.06-2000.04	Front Axle	Terrain cab wagon closed 4WD 4M40T		Stabiliser Bushing	517552
	1994.06-2000.04	Front Axle	Terrain cab wagon closed 4WD 4M40T		Stabiliser Bushing	517673
	1994.06-2000.04	Rear Axle	Terrain cab wagon closed 4WD 4M40T		Stabiliser Bushing	513328
	1994.06-2000.04	Rear Axle	Terrain cab wagon closed 4WD 4M40T		Stabiliser Bushing	517571
	1994.06-2000.04	Front Axle Left	Terrain cab wagon closed 4WD 4M40T		Steering Rack Bellow Kit	541014S
3.0 (110 kw)	1991.03-1997.10	Front Axle Left Lower	Terrain cab wagon closed 4WD 6G72		Track Control Arm	S061948
	1991.03-1997.10	Front Axle Left Upper	Terrain cab wagon closed 4WD 6G72		Track Control Arm	S060956
	1991.03-1997.10	Front Axle Right Lower	Terrain cab wagon closed 4WD 6G72		Track Control Arm	S061949
	1991.03-1997.10	Front Axle Right Upper	Terrain cab wagon closed 4WD 6G72		Track Control Arm	S060957
	1991.03-1997.10	Front Axle Left Lower	Terrain cab wagon closed 4WD 6G72		Ball Joint	S080152
	1991.03-1997.10	Front Axle Right Lower	Terrain cab wagon closed 4WD 6G72		Ball Joint	S080151
	1991.03-1997.10	Front Axle Left & Right Upper	Terrain cab wagon closed 4WD 6G72		Ball Joint	S080153



	 YEAR	FITTING POSITION	BODY STYLE & DRIVE TYPE & ENGINE	REMARKS	PRODUCT	GSP Ref.
MITSUBISHI Shogun						
3.0 (110 kw)	1991.03-1997.10	Front Axle Left & Right Lower	Terrain cab wagon closed 4WD 6G72		Control Arm Bushing	511275
	1991.03-1997.10	Front Axle Left & Right Lower	Terrain cab wagon closed 4WD 6G72		Control Arm Bushing	512853
	1991.03-1997.10	Front Axle Left & Right Lower	Terrain cab wagon closed 4WD 6G72		Control Arm Bushing	512861
	1991.03-1997.10	Front Axle Left & Right Upper	Terrain cab wagon closed 4WD 6G72		Control Arm Bushing	512260
	1991.03-1997.10	Rear Axle Left & Right Lower	Terrain cab wagon closed 4WD 6G72		Control Arm Bushing	511259
	1991.03-1997.10	Rear Axle Left & Right Lower	Terrain cab wagon closed 4WD 6G72		Control Arm Bushing	512857
	1991.03-1997.10	Rear Axle Left & Right Lower Outer	Terrain cab wagon closed 4WD 6G72		Control Arm Bushing	511260
	1991.03-1997.10	Front Axle	Terrain cab wagon closed 4WD 6G72		Pitman Arm	S010003
	1991.03-1997.10	Front Axle	Terrain cab wagon closed 4WD 6G72		Idler Arm	S010002
	1991.03-1997.10	Front Axle Left & Right	Terrain cab wagon closed 4WD 6G72		Tie Rod End	S070317
	1991.03-1997.10	Front Axle Left & Right Outer	Terrain cab wagon closed 4WD 6G72		Tie Rod End	S070316
	1991.03-1997.10	Front Axle Left	Terrain cab wagon closed 4WD 6G72		Rod/Strut, stabiliser	S050327
	1991.03-1997.10	Front Axle Right	Terrain cab wagon closed 4WD 6G72		Rod/Strut, stabiliser	S050328
	1991.03-1997.10	Front Axle Left & Right	Terrain cab wagon closed 4WD 6G72		Rod/Strut, stabiliser	513353
	1991.03-1997.10	Front Axle Left & Right	Terrain cab wagon closed 4WD 6G72		Rod/Strut, stabiliser	S050329
	1991.03-1997.10	Rear Axle Left & Right	Terrain cab wagon closed 4WD 6G72		Rod/Strut, stabiliser	513355
	1991.03-1997.10	Rear Axle Left & Right	Terrain cab wagon closed 4WD 6G72		Rod/Strut, stabiliser	520376
	1991.03-1997.10	Front Axle	Terrain cab wagon closed 4WD 6G72		Stabiliser Bushing	512843
	1991.03-1997.10	Front Axle	Terrain cab wagon closed 4WD 6G72		Stabiliser Bushing	512844
	1991.03-1997.10	Front Axle	Terrain cab wagon closed 4WD 6G72		Stabiliser Bushing	513074
	1991.03-1997.10	Front Axle	Terrain cab wagon closed 4WD 6G72		Stabiliser Bushing	513327
	1991.03-1997.10	Front Axle	Terrain cab wagon closed 4WD 6G72		Stabiliser Bushing	513612
	1991.03-1997.10	Front Axle	Terrain cab wagon closed 4WD 6G72		Stabiliser Bushing	517552
	1991.03-1997.10	Front Axle	Terrain cab wagon closed 4WD 6G72		Stabiliser Bushing	517673
	1991.03-1997.10	Rear Axle	Terrain cab wagon closed 4WD 6G72		Stabiliser Bushing	513328
	1991.03-1997.10	Front Axle Left	Terrain cab wagon closed 4WD 6G72		Steering Rack Bellow Kit	541014S
	1991.03-1997.10	Front Axle	Terrain cab wagon closed 4WD 6G72		Stabiliser Bushing Kit	513354S
3.5 (149 kw)	2000.04-2007.01	Front Axle Left Lower	Terrain cab wagon closed 4WD 6G74DOHC		Track Control Arm	S062001
	2000.04-2007.01	Front Axle Left Upper	Terrain cab wagon closed 4WD 6G74DOHC		Track Control Arm	S061063
	2000.04-2007.01	Front Axle Right Lower	Terrain cab wagon closed 4WD 6G74DOHC		Track Control Arm	S062002
	2000.04-2007.01	Front Axle Right Upper	Terrain cab wagon closed 4WD 6G74DOHC		Track Control Arm	S061064
	2000.04-2007.01	Rear Axle Left & Right Upper Inner	Terrain cab wagon closed 4WD 6G74DOHC		Track Control Arm	S061698
	2000.04-2007.01	Front Axle Left & Right Lower	Terrain cab wagon closed 4WD 6G74DOHC		Ball Joint	S080158
	2000.04-2007.01	Front Axle Left & Right Lower	Terrain cab wagon closed 4WD 6G74DOHC		Ball Joint	S080980
	2000.04-2007.01	Front Axle Left & Right Upper	Terrain cab wagon closed 4WD 6G74DOHC		Ball Joint	S080157
	2000.04-2007.01	Rear Axle Left & Right Upper	Terrain cab wagon closed 4WD 6G74DOHC		Ball Joint	S080159
	2000.04-2007.01	Front Axle Left & Right Lower	Terrain cab wagon closed 4WD 6G74DOHC	Date to:2006.08	Control Arm Bushing	516304
	2000.04-2007.01	Front Axle Left & Right Lower	Terrain cab wagon closed 4WD 6G74DOHC	Date to:2006.08	Control Arm Bushing	516612
	2000.04-2007.01	Front Axle Left & Right Lower	Terrain cab wagon closed 4WD 6G74DOHC		Control Arm Bushing	532420
	2000.04-2007.01	Front Axle Left & Right Upper	Terrain cab wagon closed 4WD 6G74DOHC		Control Arm Bushing	516294
	2000.04-2007.01	Rear Axle Left & Right Lower	Terrain cab wagon closed 4WD 6G74DOHC		Control Arm Bushing	512859
	2000.04-2007.01	Rear Axle Left & Right Lower	Terrain cab wagon closed 4WD 6G74DOHC	Date to:2004.11	Control Arm Bushing	512860
	2000.04-2007.01	Rear Axle Left & Right Upper	Terrain cab wagon closed 4WD 6G74DOHC		Control Arm Bushing	516029
	2000.04-2007.01	Rear Axle Left & Right Upper	Terrain cab wagon closed 4WD 6G74DOHC	Date to:2006.08	Control Arm Bushing	516556
	2000.04-2007.01	Rear Axle Left & Right Upper	Terrain cab wagon closed 4WD 6G74DOHC	Date to:2006.08	Control Arm Bushing	516613
	2000.04-2007.01	Rear Axle Left & Right Lower Inner	Terrain cab wagon closed 4WD 6G74DOHC		Control Arm Bushing	530005
	2000.04-2007.01	Rear Axle Left & Right Lower Outer	Terrain cab wagon closed 4WD 6G74DOHC	Date to:2006.08	Control Arm Bushing	516220
	2000.04-2007.01	Rear Axle Left & Right Lower Outer	Terrain cab wagon closed 4WD 6G74DOHC		Control Arm Bushing	516222
	2000.04-2007.01	Front Axle Left & Right	Terrain cab wagon closed 4WD 6G74DOHC		Tie Rod Axle Joint	S030187
	2000.04-2007.01	Front Axle Left	Terrain cab wagon closed 4WD 6G74DOHC		Tie Rod End	S070322
	2000.04-2007.01	Front Axle Right	Terrain cab wagon closed 4WD 6G74DOHC		Tie Rod End	S070323
	2000.04-2007.01	Front Axle Left	Terrain cab wagon closed 4WD 6G74DOHC		Rod/Strut, stabiliser	S050323
	2000.04-2007.01	Front Axle Right	Terrain cab wagon closed 4WD 6G74DOHC		Rod/Strut, stabiliser	S050324
	2000.04-2007.01	Rear Axle Left	Terrain cab wagon closed 4WD 6G74DOHC		Rod/Strut, stabiliser	S050325
	2000.04-2007.01	Rear Axle Right	Terrain cab wagon closed 4WD 6G74DOHC		Rod/Strut, stabiliser	S050326
	2000.04-2007.01	Front Axle	Terrain cab wagon closed 4WD 6G74DOHC		Stabiliser Bushing	512846
	2000.04-2007.01	Front Axle	Terrain cab wagon closed 4WD 6G74DOHC		Stabiliser Bushing	517633
	2000.04-2007.01	Front Axle Left	Terrain cab wagon closed 4WD 6G74DOHC		Steering Boot	541014
	2000.04-2007.01	Front Axle Left	Terrain cab wagon closed 4WD 6G74DOHC		Steering Rack Bellow Kit	541014S
	2000.04-2007.01	Rear	Terrain cab wagon closed 4WD 6G74DOHC		Steering Bushing	517596
Space Wagon						
2.0 (98 kw)	1992.06-2000.11	Front Axle Left & Right Lower	MPV FWD 4G63S		Control Arm Bushing	516045
	1992.06-2000.11	Rear Axle Left & Right Lower	MPV FWD 4G63S		Control Arm Bushing	514907
	1992.06-2000.11	Rear Axle Left & Right Lower	MPV FWD 4G63S	Date to:1998.07	Control Arm Bushing	517762



	 YEAR	FITTING POSITION	BODY STYLE & DRIVE TYPE & ENGINE	REMARKS	PRODUCT	GSP Ref.
MITSUBISHI						
Space Wagon						
2.0 (98 kw)	1992.06-2000.11	Front Axle Right	MPV FWD 4G63S		Tie Rod End	S071686
	1992.06-2000.11	Front Axle Left & Right	MPV FWD 4G63S		Tie Rod End	S070690
	1992.06-2000.11	Front Axle Left	MPV FWD 4G63S		Rod/Strut, stabiliser	S050321
	1992.06-2000.11	Front Axle Right	MPV FWD 4G63S		Rod/Strut, stabiliser	S050322
	1992.06-2000.11	Front Axle	MPV FWD 4G63S		Stabiliser Bushing	516842
	1992.06-2000.11	Rear Axle	MPV FWD 4G63S		Stabiliser Bushing	516839
	1992.06-2000.11	Rear Axle	MPV FWD 4G63S		Stabiliser Bushing	517564
2.4 (102 kw)	1992.02-1998.10	Front Axle Left & Right Lower	MPV FWD 4G64S		Control Arm Bushing	516045
	1992.02-1998.10	Rear Axle Left & Right Lower	MPV FWD 4G64S		Control Arm Bushing	514907
	1992.02-1998.10	Rear Axle Left & Right Lower	MPV FWD 4G64S	AT,Date from-to:1993.03-1997.09	Control Arm Bushing	517762
2.4 (110 kw)	1998.07-2004.01	Front Axle Left Lower	MPV FWD 4G64DOHCB		Track Control Arm	S062050
	1998.07-2004.01	Front Axle Right Lower	MPV FWD 4G64DOHCB		Track Control Arm	S062049
	1998.07-2004.01	Front Axle Left & Right Lower	MPV FWD 4G64DOHCB		Control Arm Bushing	517760
	1998.07-2004.01	Front Axle Left & Right Lower Outer	MPV FWD 4G64DOHCB		Control Arm Bushing	516300
	1998.07-2004.01	Rear Axle Left & Right	MPV FWD 4G64DOHCB		Control Arm Bushing	516614
	1998.07-2004.01	Rear Axle Left & Right Lower	MPV FWD 4G64DOHCB		Control Arm Bushing	516135
	1998.07-2004.01	Rear Axle Left & Right Lower	MPV FWD 4G64DOHCB	Date to:2004.04	Control Arm Bushing	517762
	1998.07-2004.01	Front Axle Left & Right	MPV FWD 4G64DOHCB	For right-hand drive vehicles	Tie Rod Axle Joint	S030569
	1998.07-2004.01	Front Axle Left & Right	MPV FWD 4G64DOHCB	Date to:2004.04	Tie Rod Axle Joint	S030837
	1998.07-2004.01	Front Axle Right	MPV FWD 4G64DOHCB		Tie Rod End	S071686
	1998.07-2004.01	Front Axle Left & Right	MPV FWD 4G64DOHCB		Tie Rod End	S070690
	1998.07-2004.01	Front Axle Left	MPV FWD 4G64DOHCB		Rod/Strut, stabiliser	S051427
	1998.07-2004.01	Front Axle Right	MPV FWD 4G64DOHCB		Rod/Strut, stabiliser	S051426
	1998.07-2004.01	Rear Axle Left & Right	MPV FWD 4G64DOHCB		Rod/Strut, stabiliser	S050823
	1998.07-2004.01	Front Axle	MPV FWD 4G64DOHCB		Stabiliser Bushing	517567
	1998.07-2004.01	Rear Axle	MPV FWD 4G64DOHCB		Stabiliser Bushing	516839
	1998.07-2004.01	Rear Axle	MPV FWD 4G64DOHCB		Stabiliser Bushing	517564
	1998.07-2004.01	Rear	MPV FWD 4G64DOHCB		Steering Bushing	517596
	2.4 (121 kw)	2004.10-2013.12	Front Axle Left Lower	MPV FWD 4G69		Track Control Arm
2004.10-2013.12		Front Axle Right Lower	MPV FWD 4G69		Track Control Arm	S062887
2004.10-2013.12		Front Axle Left & Right Lower	MPV FWD 4G69		Ball Joint	S081026
2004.10-2013.12		Front Axle Left & Right Lower	MPV FWD 4G69	AT,Date to:2010.12	Control Arm Bushing	516059
2004.10-2013.12		Front Axle Left & Right Lower	MPV FWD 4G69	AT,Date to:2010.12	Control Arm Bushing	516095
2004.10-2013.12		Rear Axle Left & Right Lower	MPV FWD 4G69	for left-hand drive vehicles,AT,Date to:2010.11	Control Arm Bushing	516388
2004.10-2013.12		Rear Axle Left & Right Lower	MPV FWD 4G69	AT,Date to:2010.12	Control Arm Bushing	517762
2004.10-2013.12		Front Axle Left & Right	MPV FWD 4G69		Tie Rod Axle Joint	S030644
2004.10-2013.12		Front Axle Left & Right	MPV FWD 4G69		Tie Rod End	S070763
2004.10-2013.12	Front Axle Right	MPV FWD 4G69		Rod/Strut, stabiliser	S050825	
NISSAN						
350Z						
3.5 (206 kw)	2003.10-2007.12	Front Axle Left Lower	Cabriolet RWD VQ35DE		Track Control Arm	S061852
	2003.10-2007.12	Front Axle Left Lower Inner	Cabriolet RWD VQ35DE		Track Control Arm	S062747
	2003.10-2007.12	Front Axle Left Lower Outer	Cabriolet RWD VQ35DE		Track Control Arm	S061656
	2003.10-2007.12	Front Axle Right Lower	Cabriolet RWD VQ35DE		Track Control Arm	S061853
	2003.10-2007.12	Front Axle Right Lower Inner	Cabriolet RWD VQ35DE		Track Control Arm	S062746
	2003.10-2007.12	Front Axle Right Lower Outer	Cabriolet RWD VQ35DE		Track Control Arm	S061657
	2003.10-2007.12	Front Axle Left & Right Upper	Cabriolet RWD VQ35DE		Control Arm Bushing	516108
	2003.10-2007.12	Front Axle Left & Right Lower Inner	Cabriolet RWD VQ35DE		Control Arm Bushing	516093
	2003.10-2007.12	Front Axle Left & Right Lower Outer	Cabriolet RWD VQ35DE		Control Arm Bushing	516094
	2003.10-2007.12	Rear Axle Left & Right Lower	Cabriolet RWD VQ35DE		Control Arm Bushing	516197
	2003.10-2007.12	Rear Axle Left & Right Upper	Cabriolet RWD VQ35DE		Control Arm Bushing	516174
	2003.10-2007.12	Rear Axle Left & Right Lower Centre	Cabriolet RWD VQ35DE		Control Arm Bushing	516489
	2003.10-2007.12	Rear Axle Left & Right Lower Outer	Cabriolet RWD VQ35DE	Date to:2007.06	Control Arm Bushing	516100
	2003.10-2007.12	Front Axle Left & Right	Cabriolet RWD VQ35DE		Tie Rod Axle Joint	S030732
	2003.10-2007.12	Front Axle Left	Cabriolet RWD VQ35DE		Tie Rod End	S071106
	2003.10-2007.12	Front Axle Right	Cabriolet RWD VQ35DE		Tie Rod End	S071107
	2003.10-2007.12	Front Axle Left	Cabriolet RWD VQ35DE		Rod/Strut, stabiliser	S050957
	2003.10-2007.12	Front Axle Right	Cabriolet RWD VQ35DE		Rod/Strut, stabiliser	S050728
	2003.10-2007.12	Rear Axle Left	Cabriolet RWD VQ35DE		Rod/Strut, stabiliser	S051245
	2003.10-2007.12	Rear Axle Right	Cabriolet RWD VQ35DE		Rod/Strut, stabiliser	S050726
	2003.10-2007.12	Front Axle	Cabriolet RWD VQ35DE		Stabiliser Bushing	535451
3.5 (230 kw)	2005.09-2009.12	Front Axle Left Lower	Coupe RWD VQ35HR		Track Control Arm	S061852
	2005.09-2009.12	Front Axle Left Lower Inner	Coupe RWD VQ35HR		Track Control Arm	S062747



	 YEAR	FITTING POSITION	BODY STYLE & DRIVE TYPE & ENGINE	REMARKS	PRODUCT	GSP Ref.
NISSAN						
350Z						
3.5 (230 kw)	2005.09-2009.12	Front Axle Left Lower Outer	Coupe RWD VQ35HR		Track Control Arm	S061656
	2005.09-2009.12	Front Axle Right Lower	Coupe RWD VQ35HR		Track Control Arm	S061853
	2005.09-2009.12	Front Axle Right Lower Inner	Coupe RWD VQ35HR		Track Control Arm	S062746
	2005.09-2009.12	Front Axle Right Lower Outer	Coupe RWD VQ35HR		Track Control Arm	S061657
	2005.09-2009.12	Front Axle Left & Right Upper	Coupe RWD VQ35HR		Control Arm Bushing	516108
	2005.09-2009.12	Front Axle Left & Right Lower Inner	Coupe RWD VQ35HR		Control Arm Bushing	516093
	2005.09-2009.12	Front Axle Left & Right Lower Outer	Coupe RWD VQ35HR		Control Arm Bushing	516094
	2005.09-2009.12	Rear Axle Left & Right Lower	Coupe RWD VQ35HR		Control Arm Bushing	516197
	2005.09-2009.12	Rear Axle Left & Right Upper	Coupe RWD VQ35HR		Control Arm Bushing	516174
	2005.09-2009.12	Rear Axle Left & Right Lower Centre	Coupe RWD VQ35HR		Control Arm Bushing	516489
	2005.09-2009.12	Rear Axle Left & Right Lower Outer	Coupe RWD VQ35HR	Date from:2006.11	Control Arm Bushing	516100
	2005.09-2009.12	Front Axle Left	Coupe RWD VQ35HR		Tie Rod End	S071106
	2005.09-2009.12	Front Axle Right	Coupe RWD VQ35HR		Tie Rod End	S071107
	2005.09-2009.12	Front Axle Left	Coupe RWD VQ35HR		Rod/Strut, stabiliser	S050957
	2005.09-2009.12	Front Axle Right	Coupe RWD VQ35HR		Rod/Strut, stabiliser	S050728
	2005.09-2009.12	Rear Axle Left	Coupe RWD VQ35HR		Rod/Strut, stabiliser	S051245
	2005.09-2009.12	Rear Axle Right	Coupe RWD VQ35HR		Rod/Strut, stabiliser	S050726
	2005.09-2009.12	Front Axle	Coupe RWD VQ35HR		Stabiliser Bushing	535451
370Z						
3.7 (243 kw)	2009.01-	Front Axle Left Lower	Coupe RWD VQ37VHR		Track Control Arm	S062118
	2009.01-	Front Axle Right Lower	Coupe RWD VQ37VHR		Track Control Arm	S062119
	2009.01-	Front Axle Left	Coupe RWD VQ37VHR		Tie Rod End	S071672
	2009.01-	Rear Axle Left	Coupe RWD VQ37VHR		Rod/Strut, stabiliser	S051245
	2009.01-	Rear Axle Right	Coupe RWD VQ37VHR		Rod/Strut, stabiliser	S050726
Altima						
2.5 (134 kw)	2012.06-	Front Axle Left & Right Lower	Saloon FWD QR25DE	AT	Control Arm Bushing	516502
	2012.06-	Front Axle Left & Right Lower	Saloon FWD QR25DE	AT	Control Arm Bushing	532407
	2012.06-	Front Axle Left	Saloon FWD QR25DE		Rod/Strut, stabiliser	S051275
	2012.06-	Front Axle Right	Saloon FWD QR25DE		Rod/Strut, stabiliser	S051274
Frontier						
2.5 (76 kw)	1998.05-2001.10	Front Axle Left & Right Upper	Pick up 4WD TD25TI		Control Arm Bushing	531191
2.8 (101 kw)	2002.05-2007.12	Front Axle Left & Right	Pick up RWD WM28DTI/WM28TI		Rod/Strut, stabiliser	S051329
Leaf						
ET (110 kw)	2017.08-	Front Axle Left & Right Lower	Hatchback FWD EM57		Ball Joint	S081021
	2017.08-	Front Axle Left & Right	Hatchback FWD EM57		Tie Rod Axle Joint	S031067
	2017.08-	Front Axle Left	Hatchback FWD EM57		Tie Rod End	S070940
	2017.08-	Front Axle Right	Hatchback FWD EM57		Tie Rod End	S070941
	2017.08-	Front Axle Left & Right	Hatchback FWD EM57		Rod/Strut, stabiliser	S050742
Maxima						
3.0 (128 kw)	1988.10-1994.06	Rear Axle Left & Right Lower Outer	Saloon FWD VG30E		Control Arm Bushing	516555
Maxima QX						
3.0 (142 kw)	1994.10-1999.12	Front Axle Left Lower	Saloon FWD VQ30DE		Track Control Arm	S060939
	1994.10-1999.12	Front Axle Right Lower	Saloon FWD VQ30DE		Track Control Arm	S060940
	1994.10-1999.12	Rear Axle Left & Right	Saloon FWD VQ30DE		Track Control Arm	520379
	1994.10-1999.12	Front Axle Left & Right Lower	Saloon FWD VQ30DE		Ball Joint	S080393
	1994.10-1999.12	Front Axle Left & Right Lower	Saloon FWD VQ30DE		Control Arm Bushing	511209
	1994.10-1999.12	Rear Axle Left & Right Centre	Saloon FWD VQ30DE		Control Arm Bushing	516032
	1994.10-1999.12	Rear Axle Left & Right Centre	Saloon FWD VQ30DE		Control Arm Bushing	516652
	1994.10-1999.12	Front Axle Left & Right	Saloon FWD VQ30DE		Tie Rod Axle Joint	S030199
	1994.10-1999.12	Front Axle Left & Right	Saloon FWD VQ30DE		Tie Rod End	S070340
	1994.10-1999.12	Front Axle Left & Right	Saloon FWD VQ30DE		Rod/Strut, stabiliser	S050343
	1994.10-1999.12	Front Axle	Saloon FWD VQ30DE		Stabiliser Bushing	513290
3.0 (147 kw)	2000.01-2003.08	Front Axle Left Lower	Saloon FWD VQ30DE		Track Control Arm	S060953
	2000.01-2003.08	Front Axle Right Lower	Saloon FWD VQ30DE		Track Control Arm	S060952
	2000.01-2003.08	Rear Axle Left & Right	Saloon FWD VQ30DE		Track Control Arm	520473
	2000.01-2003.08	Front Axle Left & Right Lower	Saloon FWD VQ30DE		Control Arm Bushing	511196
	2000.01-2003.08	Front Axle Left & Right Lower	Saloon FWD VQ30DE		Control Arm Bushing	516648
	2000.01-2003.08	Rear Axle Left & Right Lower	Saloon FWD VQ30DE		Control Arm Bushing	514953
	2000.01-2003.08	Rear Axle Left & Right Lower	Saloon FWD VQ30DE		Control Arm Bushing	514967
	2000.01-2003.08	Front Axle Left & Right	Saloon FWD VQ30DE		Tie Rod Axle Joint	S030199
	2000.01-2003.08	Front Axle Left & Right	Saloon FWD VQ30DE		Tie Rod End	S070340
	2000.01-2003.08	Front Axle Left	Saloon FWD VQ30DE		Rod/Strut, stabiliser	S050569
	2000.01-2003.08	Front Axle Right	Saloon FWD VQ30DE		Rod/Strut, stabiliser	S050568
	2000.01-2003.08	Front Axle	Saloon FWD VQ30DE		Stabiliser Bushing	512866



	 YEAR	FITTING POSITION	BODY STYLE & DRIVE TYPE & ENGINE	REMARKS	PRODUCT	GSP Ref.
NISSAN						
Murano						
3.5 (172 kw)	2004.09-2009.12	Front Axle Left Lower	SUV 4WD VQ35DE		Track Control Arm	S061118
	2004.09-2009.12	Front Axle Right Lower	SUV 4WD VQ35DE		Track Control Arm	S061119
	2004.09-2009.12	Front Axle Right Lower	SUV 4WD VQ35DE		Control Arm Bushing	535223
	2004.09-2009.12	Front Axle Left & Right Lower	SUV 4WD VQ35DE		Control Arm Bushing	511231
	2004.09-2009.12	Front Axle Left & Right Lower	SUV 4WD VQ35DE		Control Arm Bushing	514363
	2004.09-2009.12	Rear Axle Left & Right Upper	SUV 4WD VQ35DE		Control Arm Bushing	516230
	2004.09-2009.12	Rear Axle Left & Right Lower Centre	SUV 4WD VQ35DE		Control Arm Bushing	516228
	2004.09-2009.12	Rear Axle Left & Right Lower Inner	SUV 4WD VQ35DE	AT	Control Arm Bushing	516235
	2004.09-2009.12	Rear Axle Left & Right Lower Outer	SUV 4WD VQ35DE		Control Arm Bushing	516290
	2004.09-2009.12	Front Axle Left & Right	SUV 4WD VQ35DE		Tie Rod Axle Joint	S030201
	2004.09-2009.12	Front Axle Left & Right	SUV 4WD VQ35DE		Tie Rod Axle Joint	S030783
	2004.09-2009.12	Front Axle Left & Right	SUV 4WD VQ35DE		Tie Rod End	S070348
	2004.09-2009.12	Front Axle Left & Right	SUV 4WD VQ35DE		Tie Rod End	S071263
	2004.09-2009.12	Front Axle Left	SUV 4WD VQ35DE		Rod/Strut, stabiliser	S050367
	2004.09-2009.12	Front Axle Right	SUV 4WD VQ35DE		Rod/Strut, stabiliser	S050648
	2004.09-2009.12	Rear Axle Left	SUV 4WD VQ35DE		Rod/Strut, stabiliser	S050664
	2004.09-2009.12	Rear Axle Right	SUV 4WD VQ35DE		Rod/Strut, stabiliser	S050674
	2004.09-2009.12	Front Axle	SUV 4WD VQ35DE		Stabiliser Bushing	517824
	2004.09-2009.12	Rear Axle	SUV 4WD VQ35DE		Stabiliser Bushing	517823
	2004.09-2009.12	Front Axle	SUV 4WD VQ35DE		Steering Rack Bellow Kit	540211K
	2004.09-2009.12	Front Axle	SUV 4WD VQ35DE		Steering Bushing	516147
Navara						
2.5 (76 kw)	1998.05-2001.10	Front Axle Left & Right Upper	Pick up 4WD TD25TI		Control Arm Bushing	531191
2.5 (106 kw)	2005.07-	Front Axle Left Lower	Pick up RWD YD25DDTI		Track Control Arm	S061345
	2005.07-	Front Axle Left Lower	Pick up RWD YD25DDTI		Track Control Arm	S061706
	2005.07-	Front Axle Left Lower	Pick up RWD YD25DDTI		Track Control Arm	S061841
	2005.07-	Front Axle Left Upper	Pick up RWD YD25DDTI		Track Control Arm	S061339
	2005.07-	Front Axle Right Lower	Pick up RWD YD25DDTI		Track Control Arm	S061344
	2005.07-	Front Axle Right Lower	Pick up RWD YD25DDTI	Date from-to:2006.09-2010.10	Track Control Arm	S061707
	2005.07-	Front Axle Right Lower	Pick up RWD YD25DDTI		Track Control Arm	S061840
	2005.07-	Front Axle Right Upper	Pick up RWD YD25DDTI		Track Control Arm	S061338
	2005.07-	Front Axle Right Upper	Pick up RWD YD25DDTI		Track Control Arm	S062098
	2005.07-	Front Axle Left & Right Lower	Pick up RWD YD25DDTI		Ball Joint	S080845
	2005.07-	Front Axle Left & Right Lower	Pick up RWD YD25DDTI		Ball Joint	S080856
	2005.07-	Front Axle Left & Right Upper	Pick up RWD YD25DDTI		Ball Joint	S080648
	2005.07-	Front Axle Left & Right Upper	Pick up RWD YD25DDTI		Ball Joint	S080706
	2005.07-	Front Axle Left & Right Lower	Pick up RWD YD25DDTI	Date to:2010.09	Control Arm Bushing	516207
	2005.07-	Front Axle Left & Right Lower	Pick up RWD YD25DDTI		Control Arm Bushing	531525
	2005.07-	Front Axle Left & Right Upper	Pick up RWD YD25DDTI		Control Arm Bushing	516181
	2005.07-	Rear Axle Left & Right Upper	Pick up RWD YD25DDTI		Control Arm Bushing	530518
	2005.07-	Front Axle Left & Right	Pick up RWD YD25DDTI		Tie Rod Axle Joint	S030202
	2005.07-	Front Axle Left & Right	Pick up RWD YD25DDTI		Tie Rod Axle Joint	S030577
	2005.07-	Front Axle Left	Pick up RWD YD25DDTI		Tie Rod End	S070346
	2005.07-	Front Axle Left	Pick up RWD YD25DDTI		Tie Rod End	S070682
	2005.07-	Front Axle Left	Pick up RWD YD25DDTI		Tie Rod End	S070927
	2005.07-	Front Axle Right	Pick up RWD YD25DDTI		Tie Rod End	S070347
	2005.07-	Front Axle Right	Pick up RWD YD25DDTI		Tie Rod End	S070681
	2005.07-	Front Axle Right	Pick up RWD YD25DDTI		Tie Rod End	S070928
	2005.07-	Front Axle Left	Pick up RWD YD25DDTI		Rod/Strut, stabiliser	S050354
	2005.07-	Front Axle Right	Pick up RWD YD25DDTI		Rod/Strut, stabiliser	S050353
	2005.07-	Front Axle Left & Right	Pick up RWD YD25DDTI		Rod/Strut, stabiliser	S050695
	2005.07-	Front Axle Left & Right	Pick up RWD YD25DDTI		Rod/Strut, stabiliser	S051316
	2005.07-	Rear Axle Left	Pick up RWD YD25DDTI		Rod/Strut, stabiliser	S050675
	2005.07-	Rear Axle Right	Pick up RWD YD25DDTI		Rod/Strut, stabiliser	S050531
	2005.07-	Front Axle	Pick up RWD YD25DDTI		Stabiliser Bushing	532749
	2006.12-	Front Axle Left Lower	Pick up 4WD YD25DDTI		Track Control Arm	S061345
	2006.12-	Front Axle Left Lower	Pick up 4WD YD25DDTI		Track Control Arm	S061706
	2006.12-	Front Axle Left Upper	Pick up 4WD YD25DDTI		Track Control Arm	S061339
	2006.12-	Front Axle Right Lower	Pick up 4WD YD25DDTI		Track Control Arm	S061344
	2006.12-	Front Axle Right Lower	Pick up 4WD YD25DDTI		Track Control Arm	S061707
	2006.12-	Front Axle Right Upper	Pick up 4WD YD25DDTI		Track Control Arm	S061338
	2006.12-	Front Axle Left & Right Lower	Pick up 4WD YD25DDTI		Ball Joint	S080845
	2006.12-	Front Axle Left & Right Upper	Pick up 4WD YD25DDTI		Ball Joint	S080648
	2006.12-	Front Axle Left & Right Upper	Pick up 4WD YD25DDTI		Ball Joint	S080706



	 YEAR	FITTING POSITION	BODY STYLE & DRIVE TYPE & ENGINE	REMARKS	PRODUCT	GSP Ref.
NISSAN Navara						
2.5 (106 kw)	2006.12-	Front Axle Left & Right Lower	Pick up 4WD YD25DDTI		Control Arm Bushing	516207
	2006.12-	Front Axle Left & Right Upper	Pick up 4WD YD25DDTI		Control Arm Bushing	516181
	2006.12-	Rear Axle Left & Right Upper	Pick up 4WD YD25DDTI		Control Arm Bushing	530518
	2006.12-	Front Axle Left & Right	Pick up 4WD YD25DDTI		Tie Rod Axle Joint	S030202
	2006.12-	Front Axle Left & Right	Pick up 4WD YD25DDTI		Tie Rod Axle Joint	S030577
	2006.12-	Front Axle Left	Pick up 4WD YD25DDTI		Tie Rod End	S070346
	2006.12-	Front Axle Left	Pick up 4WD YD25DDTI		Tie Rod End	S070682
	2006.12-	Front Axle Left	Pick up 4WD YD25DDTI	<small>Engine code YD25DDTI;Not for country:can,model:Europe;Engine code YD25DDTI</small>	Tie Rod End	S070927
	2006.12-	Front Axle Right	Pick up 4WD YD25DDTI		Tie Rod End	S070347
	2006.12-	Front Axle Right	Pick up 4WD YD25DDTI		Tie Rod End	S070681
	2006.12-	Front Axle Left	Pick up 4WD YD25DDTI		Rod/Strut,stabiliser	S050354
	2006.12-	Front Axle Right	Pick up 4WD YD25DDTI		Rod/Strut,stabiliser	S050353
	2006.12-	Front Axle Left & Right	Pick up 4WD YD25DDTI		Rod/Strut,stabiliser	S050695
	2006.12-	Rear Axle Left	Pick up 4WD YD25DDTI		Rod/Strut,stabiliser	S050675
2006.12-	Rear Axle Right	Pick up 4WD YD25DDTI		Rod/Strut,stabiliser	S050531	
2.5 (120 kw)	2007.08-	Front Axle Left Lower	Pick up RWD YD25DDTI		Track Control Arm	S061345
	2007.08-	Front Axle Left Lower	Pick up RWD YD25DDTI		Track Control Arm	S061706
	2007.08-	Front Axle Left Upper	Pick up RWD YD25DDTI		Track Control Arm	S061339
	2007.08-	Front Axle Right Lower	Pick up RWD YD25DDTI		Track Control Arm	S061344
	2007.08-	Front Axle Right Lower	Pick up RWD YD25DDTI		Track Control Arm	S061707
	2007.08-	Front Axle Right Upper	Pick up RWD YD25DDTI		Track Control Arm	S061338
	2007.08-	Front Axle Left & Right Lower	Pick up RWD YD25DDTI		Ball Joint	S080845
	2007.08-	Front Axle Left & Right Lower	Pick up RWD YD25DDTI		Ball Joint	S080856
	2007.08-	Front Axle Left & Right Upper	Pick up RWD YD25DDTI		Ball Joint	S080648
	2007.08-	Front Axle Left & Right Upper	Pick up RWD YD25DDTI		Ball Joint	S080706
	2007.08-	Front Axle Left & Right Lower	Pick up RWD YD25DDTI		Control Arm Bushing	516207
	2007.08-	Front Axle Left & Right Upper	Pick up RWD YD25DDTI		Control Arm Bushing	516181
	2007.08-	Rear Axle Left & Right Upper	Pick up RWD YD25DDTI		Control Arm Bushing	530518
	2007.08-	Front Axle Left & Right	Pick up RWD YD25DDTI		Tie Rod Axle Joint	S030202
	2007.08-	Front Axle Left & Right	Pick up RWD YD25DDTI		Tie Rod Axle Joint	S030577
	2007.08-	Front Axle Left	Pick up RWD YD25DDTI		Tie Rod End	S070346
	2007.08-	Front Axle Left	Pick up RWD YD25DDTI		Tie Rod End	S070682
	2007.08-	Front Axle Left	Pick up RWD YD25DDTI	<small>Engine code YD25DDTI;Not for country:can,model:Europe;Engine code YD25DDTI</small>	Tie Rod End	S070927
	2007.08-	Front Axle Right	Pick up RWD YD25DDTI		Tie Rod End	S070347
	2007.08-	Front Axle Right	Pick up RWD YD25DDTI		Tie Rod End	S070681
	2007.08-	Front Axle Left	Pick up RWD YD25DDTI		Rod/Strut,stabiliser	S050354
	2007.08-	Front Axle Right	Pick up RWD YD25DDTI		Rod/Strut,stabiliser	S050353
	2007.08-	Front Axle Left & Right	Pick up RWD YD25DDTI		Rod/Strut,stabiliser	S050695
	2007.08-	Rear Axle Left	Pick up RWD YD25DDTI		Rod/Strut,stabiliser	S050675
2007.08-	Rear Axle Right	Pick up RWD YD25DDTI		Rod/Strut,stabiliser	S050531	
2.5 (126 kw)	2006.10-	Front Axle Left Lower	Pick up 4WD YD25DDTI		Track Control Arm	S061345
	2006.10-	Front Axle Left Lower	Pick up 4WD YD25DDTI		Track Control Arm	S061706
	2006.10-	Front Axle Left Lower	Pick up 4WD YD25DDTI		Track Control Arm	S061841
	2006.10-	Front Axle Left Upper	Pick up 4WD YD25DDTI		Track Control Arm	S061339
	2006.10-	Front Axle Right Lower	Pick up 4WD YD25DDTI		Track Control Arm	S061344
	2006.10-	Front Axle Right Lower	Pick up 4WD YD25DDTI		Track Control Arm	S061707
	2006.10-	Front Axle Right Lower	Pick up 4WD YD25DDTI		Track Control Arm	S061840
	2006.10-	Front Axle Right Upper	Pick up 4WD YD25DDTI		Track Control Arm	S061338
	2006.10-	Front Axle Left & Right Lower	Pick up 4WD YD25DDTI		Ball Joint	S080845
	2006.10-	Front Axle Left & Right Lower	Pick up 4WD YD25DDTI		Ball Joint	S080856
	2006.10-	Front Axle Left & Right Upper	Pick up 4WD YD25DDTI		Ball Joint	S080648
	2006.10-	Front Axle Left & Right Upper	Pick up 4WD YD25DDTI		Ball Joint	S080706
	2006.10-	Front Axle Left & Right Lower	Pick up 4WD YD25DDTI	Date to:2010.09	Control Arm Bushing	516207
	2006.10-	Front Axle Left & Right Lower	Pick up 4WD YD25DDTI		Control Arm Bushing	531525
	2006.10-	Front Axle Left & Right Upper	Pick up 4WD YD25DDTI		Control Arm Bushing	516181
	2006.10-	Rear Axle Left & Right Upper	Pick up 4WD YD25DDTI		Control Arm Bushing	530518
	2006.10-	Front Axle Left & Right	Pick up 4WD YD25DDTI		Tie Rod Axle Joint	S030202
	2006.10-	Front Axle Left & Right	Pick up 4WD YD25DDTI		Tie Rod Axle Joint	S030577
	2006.10-	Front Axle Left	Pick up 4WD YD25DDTI		Tie Rod End	S070346
	2006.10-	Front Axle Left	Pick up 4WD YD25DDTI		Tie Rod End	S070682
	2006.10-	Front Axle Left	Pick up 4WD YD25DDTI	<small>Engine code YD25DDTI;Not for country:can,model:Europe;Engine code YD25DDTI</small>	Tie Rod End	S070927
	2006.10-	Front Axle Right	Pick up 4WD YD25DDTI		Tie Rod End	S070347
	2006.10-	Front Axle Right	Pick up 4WD YD25DDTI		Tie Rod End	S070681
	2006.10-	Front Axle Right	Pick up 4WD YD25DDTI		Tie Rod End	S070928



	 YEAR	FITTING POSITION	BODY STYLE & DRIVE TYPE & ENGINE	REMARKS	PRODUCT	GSP Ref.
NISSAN						
Navara						
2.5 (126 kw)	2006.10-	Front Axle Left	Pick up 4WD YD25DDTI		Rod/Strut,stabiliser	S050354
	2006.10-	Front Axle Right	Pick up 4WD YD25DDTI		Rod/Strut,stabiliser	S050353
	2006.10-	Front Axle Left & Right	Pick up 4WD YD25DDTI		Rod/Strut,stabiliser	S050695
	2006.10-	Rear Axle Left	Pick up 4WD YD25DDTI		Rod/Strut,stabiliser	S050675
	2006.10-	Rear Axle Right	Pick up 4WD YD25DDTI		Rod/Strut,stabiliser	S050531
	2006.10-	Front Axle	Pick up 4WD YD25DDTI		Stabiliser Bushing	531998
2.5 (140 kw)	2009.12-	Front Axle Left Lower	Pick up 4WD YD25DDTI		Track Control Arm	S061345
	2009.12-	Front Axle Left Lower	Pick up 4WD YD25DDTI		Track Control Arm	S061706
	2009.12-	Front Axle Left Upper	Pick up 4WD YD25DDTI		Track Control Arm	S061339
	2009.12-	Front Axle Right Lower	Pick up 4WD YD25DDTI		Track Control Arm	S061344
	2009.12-	Front Axle Right Lower	Pick up 4WD YD25DDTI		Track Control Arm	S061707
	2009.12-	Front Axle Right Upper	Pick up 4WD YD25DDTI		Track Control Arm	S061338
	2009.12-	Front Axle Left & Right Lower	Pick up 4WD YD25DDTI		Ball Joint	S080845
	2009.12-	Front Axle Left & Right Lower	Pick up 4WD YD25DDTI		Ball Joint	S080856
	2009.12-	Front Axle Left & Right Upper	Pick up 4WD YD25DDTI		Ball Joint	S080648
	2009.12-	Front Axle Left & Right Upper	Pick up 4WD YD25DDTI		Ball Joint	S080706
	2009.12-	Front Axle Left & Right Lower	Pick up 4WD YD25DDTI		Control Arm Bushing	516207
	2009.12-	Front Axle Left & Right Upper	Pick up 4WD YD25DDTI		Control Arm Bushing	516181
	2009.12-	Rear Axle Left & Right Upper	Pick up 4WD YD25DDTI		Control Arm Bushing	530518
	2009.12-	Front Axle Left & Right	Pick up 4WD YD25DDTI		Tie Rod Axle Joint	S030202
	2009.12-	Front Axle Left & Right	Pick up 4WD YD25DDTI		Tie Rod Axle Joint	S030577
	2009.12-	Front Axle Left	Pick up 4WD YD25DDTI		Tie Rod End	S070346
	2009.12-	Front Axle Left	Pick up 4WD YD25DDTI		Tie Rod End	S070682
	2009.12-	Front Axle Left	Pick up 4WD YD25DDTI	Engine code YD25DDTI,Not for quality spec, model Europe,Engine code YD25DDTI	Tie Rod End	S070927
	2009.12-	Front Axle Right	Pick up 4WD YD25DDTI		Tie Rod End	S070347
	2009.12-	Front Axle Right	Pick up 4WD YD25DDTI		Tie Rod End	S070681
	2009.12-	Front Axle Right	Pick up 4WD YD25DDTI		Tie Rod End	S070928
	2009.12-	Front Axle Left	Pick up 4WD YD25DDTI		Rod/Strut,stabiliser	S050354
	2009.12-	Front Axle Right	Pick up 4WD YD25DDTI		Rod/Strut,stabiliser	S050353
	2009.12-	Front Axle Left & Right	Pick up 4WD YD25DDTI		Rod/Strut,stabiliser	S050695
	2009.12-	Rear Axle Left	Pick up 4WD YD25DDTI		Rod/Strut,stabiliser	S050675
	2009.12-	Rear Axle Right	Pick up 4WD YD25DDTI		Rod/Strut,stabiliser	S050531
	2009.12-	Front Axle	Pick up 4WD YD25DDTI		Stabiliser Bushing	531998
	2014.07-	Front Axle Left & Right Lower	Pick up 4WD YD25DDTI		Control Arm Bushing	516207
	2014.07-	Front Axle Left & Right Lower	Pick up 4WD YD25DDTI	Date from:2015.02	Control Arm Bushing	516944
	2014.07-	Front Axle Left & Right Lower	Pick up 4WD YD25DDTI		Control Arm Bushing	516944
	2014.07-	Front Axle Left & Right Upper	Pick up 4WD YD25DDTI		Control Arm Bushing	516181
Navara/Frontier/Skystar/Datsun						
3.2 (76 kw)	1998.01-2001.10	Front Axle Left & Right Upper	Pick up AWD QD32		Ball Joint	S080391
	1998.01-2001.10	Front Axle Left & Right Upper	Pick up AWD QD32		Control Arm Bushing	531191
NP300 Frontier						
2.5 (140 kw)	2014.11-	Front Axle Left & Right Lower	Pick up 4WD YD25DDTI		Control Arm Bushing	516207
	2014.11-	Front Axle Left & Right Lower	Pick up 4WD YD25DDTI		Control Arm Bushing	516944
	2014.11-	Front Axle Left & Right Upper	Pick up 4WD YD25DDTI		Control Arm Bushing	516181
NP300 Navara						
2.3 (118 kw)	2019.01-	Front Axle Left	Pick up AWD YS23DDT		Rod/Strut,stabiliser	S051488
	2019.01-	Front Axle Right	Pick up AWD YS23DDT		Rod/Strut,stabiliser	S051489
	2019.01-	Rear Axle Left & Right	Pick up AWD YS23DDT		Rod/Strut,stabiliser	S051429
2.3 (140 kw)	2015.11-	Front Axle Left & Right Lower	Pick up 4WD YS23DDTT		Control Arm Bushing	516944
	2015.11-	Front Axle Left	Pick up 4WD YS23DDTT		Rod/Strut,stabiliser	S051488
	2015.11-	Front Axle Right	Pick up 4WD YS23DDTT		Rod/Strut,stabiliser	S051489
	2015.11-	Rear Axle Left & Right	Pick up 4WD YS23DDTT		Rod/Strut,stabiliser	S051429
2.5 (120 kw)	2012.02-2016.12	Front Axle Left	Pick up AWD YD25DDTi		Rod/Strut,stabiliser	S051488
	2012.02-2016.12	Front Axle Right	Pick up AWD YD25DDTi		Rod/Strut,stabiliser	S051489
2.5 (140 kw)	2014.07-	Front Axle Left & Right Lower	Pick up 4WD YD25DDTI		Control Arm Bushing	516207
	2014.07-	Front Axle Left & Right Lower	Pick up 4WD YD25DDTI		Control Arm Bushing	516944
	2014.07-	Front Axle Left & Right Upper	Pick up 4WD YD25DDTI		Control Arm Bushing	516181
Pathfinder						
2.5 (128 kw)	2005.01-2010.06	Front Axle Left Lower	SUV 4WD YD25DDTI		Track Control Arm	S061345
	2005.01-2010.06	Front Axle Left Lower	SUV 4WD YD25DDTI		Track Control Arm	S061706
	2005.01-2010.06	Front Axle Left Upper	SUV 4WD YD25DDTI		Track Control Arm	S061339
	2005.01-2010.06	Front Axle Right Lower	SUV 4WD YD25DDTI		Track Control Arm	S061344
	2005.01-2010.06	Front Axle Right Lower	SUV 4WD YD25DDTI		Track Control Arm	S061707
	2005.01-2010.06	Front Axle Right Upper	SUV 4WD YD25DDTI		Track Control Arm	S061338



	 YEAR	FITTING POSITION	BODY STYLE & DRIVE TYPE & ENGINE	REMARKS	PRODUCT	GSP Ref.
NISSAN Pathfinder 2.5 (128 kw)	2005.01-2010.06	Front Axle Right Upper	SUV 4WD YD25DDTI		Track Control Arm	S062098
	2005.01-2010.06	Rear Axle Left Lower	SUV 4WD YD25DDTI		Track Control Arm	S061480
	2005.01-2010.06	Rear Axle Left Upper	SUV 4WD YD25DDTI		Track Control Arm	S062869
	2005.01-2010.06	Rear Axle Right Lower	SUV 4WD YD25DDTI		Track Control Arm	S061481
	2005.01-2010.06	Rear Axle Right Upper	SUV 4WD YD25DDTI		Track Control Arm	S061703
	2005.01-2010.06	Front Axle Left & Right Lower	SUV 4WD YD25DDTI		Ball Joint	S080845
	2005.01-2010.06	Front Axle Left & Right Upper	SUV 4WD YD25DDTI		Ball Joint	S080856
	2005.01-2010.06	Front Axle Left & Right Upper	SUV 4WD YD25DDTI		Ball Joint	S080648
	2005.01-2010.06	Front Axle Left & Right Upper	SUV 4WD YD25DDTI		Ball Joint	S080706
	2005.01-2010.06	Front Axle Left & Right Lower	SUV 4WD YD25DDTI	Date from-to:2006.07-2010.09	Control Arm Bushing	516207
	2005.01-2010.06	Front Axle Left & Right Lower	SUV 4WD YD25DDTI		Control Arm Bushing	531525
	2005.01-2010.06	Front Axle Left & Right Upper	SUV 4WD YD25DDTI		Control Arm Bushing	516181
	2005.01-2010.06	Front Axle Left & Right Upper	SUV 4WD YD25DDTI	Date to:2013.11	Control Arm Bushing	516198
	2005.01-2010.06	Rear Axle Left & Right Lower	SUV 4WD YD25DDTI	for model code:R51M	Control Arm Bushing	516192
	2005.01-2010.06	Rear Axle Left & Right Lower	SUV 4WD YD25DDTI		Control Arm Bushing	516199
	2005.01-2010.06	Rear Axle Left & Right Upper	SUV 4WD YD25DDTI		Control Arm Bushing	516208
	2005.01-2010.06	Rear Axle Left & Right Lower Outer	SUV 4WD YD25DDTI		Control Arm Bushing	516200
	2005.01-2010.06	Front Axle Left & Right	SUV 4WD YD25DDTI		Tie Rod Axle Joint	S030202
	2005.01-2010.06	Front Axle Left	SUV 4WD YD25DDTI		Tie Rod End	S070346
	2005.01-2010.06	Front Axle Left	SUV 4WD YD25DDTI		Tie Rod End	S070682
	2005.01-2010.06	Front Axle Left	SUV 4WD YD25DDTI		Tie Rod End	S071288
	2005.01-2010.06	Front Axle Right	SUV 4WD YD25DDTI		Tie Rod End	S070347
	2005.01-2010.06	Front Axle Right	SUV 4WD YD25DDTI		Tie Rod End	S070681
	2005.01-2010.06	Front Axle Right	SUV 4WD YD25DDTI		Tie Rod End	S071289
	2005.01-2010.06	Front Axle Left	SUV 4WD YD25DDTI		Rod/Strut,stabiliser	S050354
	2005.01-2010.06	Front Axle Right	SUV 4WD YD25DDTI		Rod/Strut,stabiliser	S050353
	2005.01-2010.06	Front Axle Left & Right	SUV 4WD YD25DDTI		Rod/Strut,stabiliser	S050695
	2005.01-2010.06	Rear Axle Left	SUV 4WD YD25DDTI		Rod/Strut,stabiliser	S050675
	2005.01-2010.06	Rear Axle Right	SUV 4WD YD25DDTI		Rod/Strut,stabiliser	S050531
	2005.01-2010.06	Front Axle	SUV 4WD YD25DDTI		Stabiliser Bushing	513298
	2005.01-2010.06	Rear Axle	SUV 4WD YD25DDTI		Stabiliser Bushing	513299
	3.3 (125 kw)	1995.12-2005.07	Front Axle Left Lower	Terrain cab wagon closed 4WD VG33E		Track Control Arm
1995.12-2005.07		Front Axle Right Lower	Terrain cab wagon closed 4WD VG33E		Track Control Arm	S061045
1995.12-2005.07		Front Axle Left & Right Lower	Terrain cab wagon closed 4WD VG33E		Ball Joint	S080387
1995.12-2005.07		Front Axle Left & Right Lower	Terrain cab wagon closed 4WD VG33E		Control Arm Bushing	513287
1995.12-2005.07		Front Axle Left & Right Lower	Terrain cab wagon closed 4WD VG33E		Control Arm Bushing	513811
1995.12-2005.07		Front Axle Left & Right Lower	Terrain cab wagon closed 4WD VG33E		Control Arm Bushing	517333
1995.12-2005.07		Front Axle Left & Right Upper	Terrain cab wagon closed 4WD VG33E		Control Arm Bushing	512081
1995.12-2005.07		Rear Axle Left & Right Lower	Terrain cab wagon closed 4WD VG33E		Control Arm Bushing	513602
1995.12-2005.07		Rear Axle Left & Right Upper	Terrain cab wagon closed 4WD VG33E	for article no.:SCA-6614	Control Arm Bushing	516024
1995.12-2005.07		Rear Axle Left & Right Upper	Terrain cab wagon closed 4WD VG33E		Control Arm Bushing	516024
1995.12-2005.07		Rear Axle Left & Right Upper	Terrain cab wagon closed 4WD VG33E	Date to:1999.02	Control Arm Bushing	516269
1995.12-2005.07		Front Axle Left & Right	Terrain cab wagon closed 4WD VG33E		Tie Rod Axle Joint	S030459
1995.12-2005.07		Front Axle Left & Right	Terrain cab wagon closed 4WD VG33E		Rod/Strut,stabiliser	S050570
1995.12-2005.07		Rear Axle Left & Right	Terrain cab wagon closed 4WD VG33E		Rod/Strut,stabiliser	517214S
1995.12-2005.07		Rear Axle	Terrain cab wagon closed 4WD VG33E		Stabiliser Bushing	513291
3.5 (162 kw)		2000.02-2004.12	Front Axle Left Lower	Terrain cab wagon closed 4WD VQ35DE		Track Control Arm
	2000.02-2004.12	Front Axle Right Lower	Terrain cab wagon closed 4WD VQ35DE		Track Control Arm	S061045
	2000.02-2004.12	Front Axle Left & Right Lower	Terrain cab wagon closed 4WD VQ35DE		Ball Joint	S080387
	2000.02-2004.12	Front Axle Left & Right Lower	Terrain cab wagon closed 4WD VQ35DE		Control Arm Bushing	513287
	2000.02-2004.12	Front Axle Left & Right Lower	Terrain cab wagon closed 4WD VQ35DE		Control Arm Bushing	513811
	2000.02-2004.12	Front Axle Left & Right Lower	Terrain cab wagon closed 4WD VQ35DE		Control Arm Bushing	517333
	2000.02-2004.12	Rear Axle Left & Right Lower	Terrain cab wagon closed 4WD VQ35DE		Control Arm Bushing	513602
	2000.02-2004.12	Rear Axle Left & Right Upper	Terrain cab wagon closed 4WD VQ35DE		Control Arm Bushing	516024
	2000.02-2004.12	Front Axle Left & Right	Terrain cab wagon closed 4WD VQ35DE		Tie Rod Axle Joint	S030459
	2000.02-2004.12	Front Axle Left & Right	Terrain cab wagon closed 4WD VQ35DE		Rod/Strut,stabiliser	S050570
2000.02-2004.12	Rear Axle Left & Right	Terrain cab wagon closed 4WD VQ35DE		Rod/Strut,stabiliser	517214S	
4.0 (198 kw)	2005.01-2014.08	Front Axle Left Lower	SUV 4WD VQ40DE		Track Control Arm	S061345
	2005.01-2014.08	Front Axle Left Lower	SUV 4WD VQ40DE		Track Control Arm	S061706
	2005.01-2014.08	Front Axle Left Upper	SUV 4WD VQ40DE		Track Control Arm	S061339
	2005.01-2014.08	Front Axle Right Lower	SUV 4WD VQ40DE		Track Control Arm	S061344
	2005.01-2014.08	Front Axle Right Lower	SUV 4WD VQ40DE		Track Control Arm	S061707
	2005.01-2014.08	Front Axle Right Upper	SUV 4WD VQ40DE		Track Control Arm	S061338
	2005.01-2014.08	Rear Axle Left Lower	SUV 4WD VQ40DE		Track Control Arm	S061480



	 YEAR	FITTING POSITION	BODY STYLE & DRIVE TYPE & ENGINE	REMARKS	PRODUCT	GSP Ref.
NISSAN Pathfinder						
4.0 (198 kw)	2005.01-2014.08	Rear Axle Left Upper	SUV 4WD VQ40DE		Track Control Arm	S062869
	2005.01-2014.08	Rear Axle Right Lower	SUV 4WD VQ40DE		Track Control Arm	S061481
	2005.01-2014.08	Rear Axle Right Upper	SUV 4WD VQ40DE		Track Control Arm	S061703
	2005.01-2014.08	Front Axle Left & Right Lower	SUV 4WD VQ40DE		Ball Joint	S080845
	2005.01-2014.08	Front Axle Left & Right Lower	SUV 4WD VQ40DE		Ball Joint	S080856
	2005.01-2014.08	Front Axle Left & Right Upper	SUV 4WD VQ40DE		Ball Joint	S080594
	2005.01-2014.08	Front Axle Left & Right Upper	SUV 4WD VQ40DE		Ball Joint	S080648
	2005.01-2014.08	Front Axle Left & Right Upper	SUV 4WD VQ40DE		Ball Joint	S080706
	2005.01-2014.08	Front Axle Left & Right Lower	SUV 4WD VQ40DE	Date from-to:2006.07-2010.09	Control Arm Bushing	516207
	2005.01-2014.08	Front Axle Left & Right Lower	SUV 4WD VQ40DE	AT	Control Arm Bushing	516944
	2005.01-2014.08	Front Axle Left & Right Upper	SUV 4WD VQ40DE		Control Arm Bushing	516181
	2005.01-2014.08	Front Axle Left & Right Upper	SUV 4WD VQ40DE	Date to:2013.11	Control Arm Bushing	516198
	2005.01-2014.08	Rear Axle Left & Right Lower	SUV 4WD VQ40DE	AT,for model code:R51M	Control Arm Bushing	516192
	2005.01-2014.08	Rear Axle Left & Right Lower	SUV 4WD VQ40DE		Control Arm Bushing	516199
	2005.01-2014.08	Rear Axle Left & Right Upper	SUV 4WD VQ40DE		Control Arm Bushing	516208
	2005.01-2014.08	Rear Axle Left & Right Lower Outer	SUV 4WD VQ40DE		Control Arm Bushing	516200
	2005.01-2014.08	Rear Axle Left & Right Lower Outer	SUV 4WD VQ40DE		Control Arm Bushing	516401
	2005.01-2014.08	Front Axle Left & Right	SUV 4WD VQ40DE		Tie Rod Axle Joint	S030202
	2005.01-2014.08	Front Axle Left	SUV 4WD VQ40DE		Tie Rod End	S070346
	2005.01-2014.08	Front Axle Left	SUV 4WD VQ40DE		Tie Rod End	S070682
	2005.01-2014.08	Front Axle Left	SUV 4WD VQ40DE		Tie Rod End	S071288
	2005.01-2014.08	Front Axle Right	SUV 4WD VQ40DE		Tie Rod End	S070347
	2005.01-2014.08	Front Axle Right	SUV 4WD VQ40DE		Tie Rod End	S070681
	2005.01-2014.08	Front Axle Right	SUV 4WD VQ40DE		Tie Rod End	S071289
	2005.01-2014.08	Front Axle Left	SUV 4WD VQ40DE		Rod/Strut,stabiliser	S050354
	2005.01-2014.08	Front Axle Right	SUV 4WD VQ40DE		Rod/Strut,stabiliser	S050353
	2005.01-2014.08	Front Axle Left & Right	SUV 4WD VQ40DE		Rod/Strut,stabiliser	S050695
	2005.01-2014.08	Rear Axle Left	SUV 4WD VQ40DE		Rod/Strut,stabiliser	S050675
	2005.01-2014.08	Rear Axle Right	SUV 4WD VQ40DE		Rod/Strut,stabiliser	S050531
	2005.01-2014.08	Front Axle	SUV 4WD VQ40DE		Stabiliser Bushing	513298
	2005.01-2014.08	Rear Axle	SUV 4WD VQ40DE		Stabiliser Bushing	513299
QX						
3.0 (142 kw)	1994.10-1999.12	Front Axle Left Lower	Saloon FWD VQ30DE		Track Control Arm	S060939
	1994.10-1999.12	Front Axle Right Lower	Saloon FWD VQ30DE		Track Control Arm	S060940
	1994.10-1999.12	Rear Axle Left & Right	Saloon FWD VQ30DE		Track Control Arm	520379
	1994.10-1999.12	Front Axle Left & Right Lower	Saloon FWD VQ30DE		Ball Joint	S080393
	1994.10-1999.12	Front Axle Left & Right Lower	Saloon FWD VQ30DE		Control Arm Bushing	511209
	1994.10-1999.12	Rear Axle Left & Right Centre	Saloon FWD VQ30DE		Control Arm Bushing	516032
	1994.10-1999.12	Rear Axle Left & Right Centre	Saloon FWD VQ30DE		Control Arm Bushing	516652
	1994.10-1999.12	Front Axle Left & Right	Saloon FWD VQ30DE		Tie Rod Axle Joint	S030199
	1994.10-1999.12	Front Axle Left & Right	Saloon FWD VQ30DE		Tie Rod End	S070340
	1994.10-1999.12	Front Axle Left & Right	Saloon FWD VQ30DE		Rod/Strut,stabiliser	S050343
	1994.10-1999.12	Front Axle	Saloon FWD VQ30DE		Stabiliser Bushing	513290
Sentra (USA)						
2.0 (104 kw)	2006.09-2012.12	Front Axle Left & Right Lower	Saloon FWD MR20DE	distance from ball pin end face to arc:15.5	Ball Joint	S080593
	2006.09-2012.12	Front Axle Left & Right Lower	Saloon FWD MR20DE	distance from ball pin end face to arc:17	Ball Joint	S081021
	2006.09-2012.12	Front Axle Left & Right Lower	Saloon FWD MR20DE		Control Arm Bushing	516188
	2006.09-2012.12	Front Axle Left & Right	Saloon FWD MR20DE		Tie Rod Axle Joint	S030529
	2006.09-2012.12	Front Axle Left	Saloon FWD MR20DE		Tie Rod End	S071288
	2006.09-2012.12	Front Axle Right	Saloon FWD MR20DE		Tie Rod End	S071289
Terrano (Pick Up)						
2.5 (76 kw)	1998.05-2001.10	Front Axle Left & Right Upper	Pick up 4WD TD25TI		Control Arm Bushing	531191
Terrano II						
2.7 (74 kw)	1993.02-2002.02	Front Axle Left & Right Lower	Terrain cab wagon closed 4WD TD27T	center distance:70	Ball Joint	S080067
	1993.02-2002.02	Front Axle Left & Right Lower	Terrain cab wagon closed 4WD TD27T	Date from:1996.05	Ball Joint	S081016
	1993.02-2002.02	Front Axle Left & Right Upper	Terrain cab wagon closed 4WD TD27T		Ball Joint	S080066
	1993.02-2002.02	Front Axle Left & Right Lower	Terrain cab wagon closed 4WD TD27T	Date to:1996.05	Control Arm Bushing	511888
	1993.02-2002.02	Front Axle Left & Right Lower	Terrain cab wagon closed 4WD TD27T		Control Arm Bushing	517590
	1993.02-2002.02	Front Axle Left & Right Lower	Terrain cab wagon closed 4WD TD27T		Control Arm Bushing	519041
	1993.02-2002.02	Front Axle Left & Right Upper	Terrain cab wagon closed 4WD TD27T		Control Arm Bushing	511194
	1993.02-2002.02	Rear Axle Left & Right Lower	Terrain cab wagon closed 4WD TD27T		Control Arm Bushing	513602
	1993.02-2002.02	Rear Axle Left & Right Lower	Terrain cab wagon closed 4WD TD27T		Control Arm Bushing	516676
	1993.02-2002.02	Rear Axle Left & Right Upper	Terrain cab wagon closed 4WD TD27T		Control Arm Bushing	516269
	1993.02-2002.02	Rear Axle Left & Right Lower Outer	Terrain cab wagon closed 4WD TD27T		Control Arm Bushing	516298



	 YEAR	FITTING POSITION	BODY STYLE & DRIVE TYPE & ENGINE	REMARKS	PRODUCT	GSP Ref.
NISSAN Terrano II						
2.7 (74 kw)	1993.02-2002.02	Rear Axle Left & Right Upper Outer	Terrain cab wagon closed 4WD TD27T		Control Arm Bushing	516268
	1993.02-2002.02	Front Axle Left & Right	Terrain cab wagon closed 4WD TD27T		Rod Assembly	S100054
	1993.02-2002.02	Front Axle Left & Right	Terrain cab wagon closed 4WD TD27T		Tie Rod End	S070183
	1993.02-2002.02	Front Axle Left & Right	Terrain cab wagon closed 4WD TD27T		Tie Rod End	S071337
	1993.02-2002.02	Front Axle Left & Right	Terrain cab wagon closed 4WD TD27T		Rod/Strut,stabiliser	S050155
	1993.02-2002.02	Rear Axle Left & Right	Terrain cab wagon closed 4WD TD27T		Rod/Strut,stabiliser	S050147
	1993.02-2002.02	Front Axle	Terrain cab wagon closed 4WD TD27T		Stabiliser Bushing	517516
	1993.02-2002.02	Rear Axle	Terrain cab wagon closed 4WD TD27T		Stabiliser Bushing	511206
	1993.02-2002.02	Rear Axle	Terrain cab wagon closed 4WD TD27T		Stabiliser Bushing	516829
2.7 (92 kw)	1996.01-2006.12	Front Axle Left & Right Lower	Terrain cab wagon closed 4WD TD27T/TD27TI		Ball Joint	S081016
	1996.01-2006.12	Front Axle Left & Right Upper	Terrain cab wagon closed 4WD TD27T/TD27TI		Ball Joint	S080066
	1996.01-2006.12	Front Axle Left & Right Lower	Terrain cab wagon closed 4WD TD27T/TD27TI	Date to:1996.05	Control Arm Bushing	511888
	1996.01-2006.12	Front Axle Left & Right Lower	Terrain cab wagon closed 4WD TD27T/TD27TI		Control Arm Bushing	517590
	1996.01-2006.12	Front Axle Left & Right Lower	Terrain cab wagon closed 4WD TD27T/TD27TI		Control Arm Bushing	519041
	1996.01-2006.12	Front Axle Left & Right Upper	Terrain cab wagon closed 4WD TD27T/TD27TI		Control Arm Bushing	511194
	1996.01-2006.12	Rear Axle Left & Right Lower	Terrain cab wagon closed 4WD TD27T/TD27TI		Control Arm Bushing	513602
	1996.01-2006.12	Rear Axle Left & Right Lower	Terrain cab wagon closed 4WD TD27T/TD27TI		Control Arm Bushing	516676
	1996.01-2006.12	Rear Axle Left & Right Upper	Terrain cab wagon closed 4WD TD27T/TD27TI		Control Arm Bushing	516269
	1996.01-2006.12	Rear Axle Left & Right Lower Outer	Terrain cab wagon closed 4WD TD27T/TD27TI		Control Arm Bushing	516298
	1996.01-2006.12	Rear Axle Left & Right Upper Outer	Terrain cab wagon closed 4WD TD27T/TD27TI		Control Arm Bushing	516268
	1996.01-2006.12	Front Axle Left & Right	Terrain cab wagon closed 4WD TD27T/TD27TI		Rod Assembly	S100054
	1996.01-2006.12	Front Axle Left & Right	Terrain cab wagon closed 4WD TD27T/TD27TI		Tie Rod End	S070183
	1996.01-2006.12	Front Axle Left & Right	Terrain cab wagon closed 4WD TD27T/TD27TI		Tie Rod End	S071337
	1996.01-2006.12	Front Axle Left & Right	Terrain cab wagon closed 4WD TD27T/TD27TI		Rod/Strut,stabiliser	S050155
	1996.01-2006.12	Rear Axle Left & Right	Terrain cab wagon closed 4WD TD27T/TD27TI		Rod/Strut,stabiliser	S050147
	1996.01-2006.12	Front Axle	Terrain cab wagon closed 4WD TD27T/TD27TI		Stabiliser Bushing	517516
	1996.01-2006.12	Rear Axle	Terrain cab wagon closed 4WD TD27T/TD27TI		Stabiliser Bushing	511206
	1996.01-2006.12	Rear Axle	Terrain cab wagon closed 4WD TD27T/TD27TI		Stabiliser Bushing	516829
X-Trail						
2.0 (101 kw)	2007.06-2013.11	Front Axle Left Lower	SUV 4WD MR20DE		Track Control Arm	S060864
	2007.06-2013.11	Front Axle Right Lower	SUV 4WD MR20DE		Track Control Arm	S060865
	2007.06-2013.11	Rear Axle Left Lower	SUV 4WD MR20DE		Track Control Arm	S063148
	2007.06-2013.11	Rear Axle Right Lower	SUV 4WD MR20DE		Track Control Arm	S063149
	2007.06-2013.11	Front Axle Left & Right Lower	SUV 4WD MR20DE		Ball Joint	S080825
	2007.06-2013.11	Front Axle Left & Right Lower	SUV 4WD MR20DE		Control Arm Bushing	516186
	2007.06-2013.11	Front Axle Left & Right Lower	SUV 4WD MR20DE	Date to:2011.02	Control Arm Bushing	516188
	2007.06-2013.11	Rear Axle Left & Right Centre	SUV 4WD MR20DE		Control Arm Bushing	516270
	2007.06-2013.11	Rear Axle Left & Right Lower	SUV 4WD MR20DE		Control Arm Bushing	516272
	2007.06-2013.11	Rear Axle Left & Right Upper	SUV 4WD MR20DE		Control Arm Bushing	516250
	2007.06-2013.11	Front Axle Left & Right	SUV 4WD MR20DE		Tie Rod Axle Joint	S030392
	2007.06-2013.11	Front Axle Left	SUV 4WD MR20DE		Tie Rod End	S070350
	2007.06-2013.11	Front Axle Right	SUV 4WD MR20DE		Tie Rod End	S070351
	2007.06-2013.11	Front Axle Left	SUV 4WD MR20DE		Rod/Strut,stabiliser	S050356
	2007.06-2013.11	Front Axle Right	SUV 4WD MR20DE		Rod/Strut,stabiliser	S050357
	2007.06-2013.11	Rear Axle Left	SUV 4WD MR20DE		Rod/Strut,stabiliser	S050361
	2007.06-2013.11	Rear Axle Right	SUV 4WD MR20DE		Rod/Strut,stabiliser	S050360
	2007.06-2013.11	Front Axle	SUV 4WD MR20DE		Stabiliser Bushing	517307
	2007.06-2013.11	Rear Axle	SUV 4WD MR20DE		Stabiliser Bushing	516216
	2007.06-2013.11	Front Axle	SUV 4WD MR20DE		Steering Boot	540268
2.5 (132 kw)	2002.09-2008.12	Rear Axle Left Upper Inner	SUV 4WD QR25DE		Track Control Arm	S061692
	2002.09-2008.12	Rear Axle Right Upper Inner	SUV 4WD QR25DE		Track Control Arm	S061693
	2002.09-2008.12	Front Axle Left & Right Lower	SUV 4WD QR25DE		Control Arm Bushing	514954
	2002.09-2008.12	Front Axle Left & Right Lower	SUV 4WD QR25DE	Date to:2007.01	Control Arm Bushing	514972
	2002.09-2008.12	Rear Axle Left & Right Lower	SUV 4WD QR25DE		Control Arm Bushing	532433
	2002.09-2008.12	Rear Axle Left & Right Lower	SUV 4WD QR25DE		Control Arm Bushing	512871
	2002.09-2008.12	Rear Axle Left & Right Lower	SUV 4WD QR25DE	Date to:2003.09	Control Arm Bushing	514854
	2002.09-2008.12	Front Axle Left	SUV 4WD QR25DE		Rod/Strut,stabiliser	S050349
	2002.09-2008.12	Front Axle Right	SUV 4WD QR25DE		Rod/Strut,stabiliser	S050350
PEUGEOT 106						
1.0 (33 kw)	1991.09-1996.04	Front Axle Left Lower	Hatchback FWD TU9		Track Control Arm	S060397
	1991.09-1996.04	Front Axle Right Lower	Hatchback FWD TU9		Track Control Arm	S060396
	1991.09-1996.04	Front Axle Left & Right Lower	Hatchback FWD TU9		Ball Joint	S080045
	1991.09-1996.04	Front Axle Left & Right Lower	Hatchback FWD TU9		Control Arm Bushing	510713



	 YEAR	FITTING POSITION	BODY STYLE & DRIVE TYPE & ENGINE	REMARKS	PRODUCT	GSP Ref.
PEUGEOT						
106						
1.0 (33 kw)	1991.09-1996.04	Front Axle Left & Right Lower	Hatchback FWD TU9		Control Arm Bushing	510716
	1991.09-1996.04	Front Axle Left	Hatchback FWD TU9		Tie Rod End	S070105
	1991.09-1996.04	Front Axle Right	Hatchback FWD TU9		Tie Rod End	S070106
	1991.09-1996.04	Front Axle Left & Right Inner	Hatchback FWD TU9		Stabiliser Bushing	512499
	1991.09-1996.04	Front Axle Left & Right Outer	Hatchback FWD TU9		Stabiliser Bushing	533443
	1991.09-1996.04	Front Axle Left & Right Outer	Hatchback FWD TU9		Stabiliser Bushing	533444
	1996.04-1999.10	Front Axle Left Lower	Hatchback FWD TU9M		Track Control Arm	S060397
	1996.04-1999.10	Front Axle Right Lower	Hatchback FWD TU9M		Track Control Arm	S060396
	1996.04-1999.10	Front Axle Left & Right Lower	Hatchback FWD TU9M		Ball Joint	S080045
	1996.04-1999.10	Front Axle Left & Right Lower	Hatchback FWD TU9M		Control Arm Bushing	510713
	1996.04-1999.10	Front Axle Left & Right Lower	Hatchback FWD TU9M		Control Arm Bushing	510716
	1996.04-1999.10	Front Axle Left & Right	Hatchback FWD TU9M		Tie Rod Axle Joint	S030623
	1996.04-1999.10	Front Axle Left	Hatchback FWD TU9M		Tie Rod End	S070105
	1996.04-1999.10	Front Axle Right	Hatchback FWD TU9M		Tie Rod End	S070106
	1996.04-1999.10	Front Axle Left & Right	Hatchback FWD TU9M		Rod/Strut, stabiliser	S100043
	1996.04-1999.10	Front Axle Left & Right Inner	Hatchback FWD TU9M		Stabiliser Bushing	512499
	1996.04-1999.10	Front Axle Left & Right Outer	Hatchback FWD TU9M		Stabiliser Bushing	533443
	1996.04-1999.10	Front Axle Left & Right Outer	Hatchback FWD TU9M		Stabiliser Bushing	533444
1.0 (37 kw)	1991.08-1996.03	Front Axle Left Lower	Hatchback FWD TU9M		Track Control Arm	S060397
	1991.08-1996.03	Front Axle Right Lower	Hatchback FWD TU9M		Track Control Arm	S060396
	1991.08-1996.03	Front Axle Left & Right Lower	Hatchback FWD TU9M		Ball Joint	S080045
	1991.08-1996.03	Front Axle Left & Right Lower	Hatchback FWD TU9M		Control Arm Bushing	510713
	1991.08-1996.03	Front Axle Left & Right Lower	Hatchback FWD TU9M		Control Arm Bushing	510716
	1991.08-1996.03	Front Axle Left	Hatchback FWD TU9M		Tie Rod End	S070105
	1991.08-1996.03	Front Axle Right	Hatchback FWD TU9M		Tie Rod End	S070106
	1991.08-1996.03	Front Axle Left & Right Inner	Hatchback FWD TU9M		Stabiliser Bushing	512499
	1991.08-1996.03	Front Axle Left & Right Outer	Hatchback FWD TU9M		Stabiliser Bushing	533444
	1996.04-2001.03	Front Axle Left Lower	Hatchback FWD TU9M		Track Control Arm	S060397
	1996.04-2001.03	Front Axle Right Lower	Hatchback FWD TU9M		Track Control Arm	S060396
	1996.04-2001.03	Front Axle Left & Right Lower	Hatchback FWD TU9M		Ball Joint	S080045
	1996.04-2001.03	Front Axle Left & Right Lower	Hatchback FWD TU9M		Control Arm Bushing	510713
	1996.04-2001.03	Front Axle Left & Right Lower	Hatchback FWD TU9M		Control Arm Bushing	510716
	1996.04-2001.03	Front Axle Left & Right	Hatchback FWD TU9M		Tie Rod Axle Joint	S030623
	1996.04-2001.03	Front Axle Left	Hatchback FWD TU9M		Tie Rod End	S070105
	1996.04-2001.03	Front Axle Right	Hatchback FWD TU9M		Tie Rod End	S070106
	1996.04-2001.03	Front Axle Left & Right	Hatchback FWD TU9M		Rod/Strut, stabiliser	S100043
	1996.04-2001.03	Front Axle Left & Right Inner	Hatchback FWD TU9M		Stabiliser Bushing	512499
	1996.04-2001.03	Front Axle Left & Right Outer	Hatchback FWD TU9M		Stabiliser Bushing	533443
	1996.04-2001.03	Front Axle Left & Right Outer	Hatchback FWD TU9M		Stabiliser Bushing	533444
205						
1.4 (55 kw)	1988.07-1998.09	Front Axle Left Lower	Hatchback FWD TU32/TU3M/TU3MC		Track Control Arm	S060149
	1988.07-1998.09	Front Axle Right Lower	Hatchback FWD TU32/TU3M/TU3MC		Track Control Arm	S060150
	1988.07-1998.09	Front Axle Left & Right Lower	Hatchback FWD TU32/TU3M/TU3MC		Control Arm Bushing	510719
	1988.07-1998.09	Front Axle Left & Right Lower	Hatchback FWD TU32/TU3M/TU3MC		Control Arm Bushing	512784
	1988.07-1998.09	Front Axle Left & Right	Hatchback FWD TU32/TU3M/TU3MC		Tie Rod Axle Joint	S030033
	1988.07-1998.09	Front Axle Left & Right	Hatchback FWD TU32/TU3M/TU3MC	Engine code:KDY(TU3M)	Tie Rod Axle Joint	S030396
	1988.07-1998.09	Front Axle Left & Right	Hatchback FWD TU32/TU3M/TU3MC		Tie Rod Axle Joint	S030396
	1988.07-1998.09	Front Axle Left & Right	Hatchback FWD TU32/TU3M/TU3MC		Tie Rod End	S070104
	1988.07-1998.09	Front Axle Left & Right	Hatchback FWD TU32/TU3M/TU3MC	Engine code:KDY(TU3M)	Tie Rod End	S070104
	1988.07-1998.09	Front Axle	Hatchback FWD TU32/TU3M/TU3MC		Steering Boot	540332
	1988.07-1998.09	Front Axle	Hatchback FWD TU32/TU3M/TU3MC		Steering Boot	540414
	1988.07-1998.09	Front Axle	Hatchback FWD TU32/TU3M/TU3MC		Steering Boot	540448
206						
1.0 (52 kw)	2001.06-2005.12	Front Axle Left & Right Lower	Hatchback FWD D4D		Control Arm Bushing	510680
1.4 (55 kw)	1998.08-2012.12	Front Axle Left Lower	Hatchback FWD TU3A/TU3JP	Engine code:KFX(TU3JP),Org.No.to:09440	Track Control Arm	S060290
	1998.08-2012.12	Front Axle Left Lower	Hatchback FWD TU3A/TU3JP	Engine code:KFX(TU3JP)	Track Control Arm	S060879
	1998.08-2012.12	Front Axle Right Lower	Hatchback FWD TU3A/TU3JP	Engine code:KFX(TU3JP),Org.No.to:09440	Track Control Arm	S060289
	1998.08-2012.12	Front Axle Right Lower	Hatchback FWD TU3A/TU3JP	Engine code:KFW(TU3A)	Track Control Arm	S060880
	1998.08-2012.12	Front Axle Left & Right Lower	Hatchback FWD TU3A/TU3JP		Control Arm Bushing	510680
	1998.08-2012.12	Front Axle Left & Right Lower	Hatchback FWD TU3A/TU3JP		Control Arm Bushing	510681
	1998.08-2012.12	Front Axle Left & Right Lower	Hatchback FWD TU3A/TU3JP		Control Arm Bushing	510682
	1998.08-2012.12	Front Axle Left & Right Lower	Hatchback FWD TU3A/TU3JP		Control Arm Bushing	510735
	1998.08-2012.12	Front Axle	Hatchback FWD TU3A/TU3JP		Suspension Repair Kit	S990015SK
	1998.08-2012.12	Front Axle	Hatchback FWD TU3A/TU3JP		Suspension Repair Kit	S990040SK



	 YEAR	FITTING POSITION	BODY STYLE & DRIVE TYPE & ENGINE	REMARKS	PRODUCT	GSP Ref.	
PEUGEOT 206							
1.4 (55 kw)	1998.08-2012.12	Front Axle Left & Right	Hatchback FWD TU3A/TU3JP		Tie Rod Axle Joint	S030231	
	1998.08-2012.12	Front Axle Left	Hatchback FWD TU3A/TU3JP		Tie Rod End	S070106	
	1998.08-2012.12	Front Axle Right	Hatchback FWD TU3A/TU3JP		Tie Rod End	S070105	
	1998.08-2012.12	Front Axle Left & Right	Hatchback FWD TU3A/TU3JP		Rod/Strut, stabiliser	S050111	
	1998.08-2012.12	Front Axle	Hatchback FWD TU3A/TU3JP		Stabiliser Bushing	530899	
	1998.08-2012.12	Front Axle	Hatchback FWD TU3A/TU3JP		Steering Boot	540190	
	1998.08-2012.12	Front Axle	Hatchback FWD TU3A/TU3JP		Steering Rack Bellow Kit	540190S	
1.6 (65 kw)	1998.09-2004.09	Front Axle Left Lower	Hatchback FWD TU5JP	Org.No.to:09439	Track Control Arm	S060290	
	1998.09-2004.09	Front Axle Right Lower	Hatchback FWD TU5JP	Org.No.to:09439	Track Control Arm	S060289	
	1998.09-2004.09	Front Axle Right Lower	Hatchback FWD TU5JP	Org.No.from:09440	Track Control Arm	S060880	
	1998.09-2004.09	Front Axle Left & Right Lower	Hatchback FWD TU5JP		Control Arm Bushing	510680	
	1998.09-2004.09	Front Axle Left & Right Lower	Hatchback FWD TU5JP		Control Arm Bushing	510681	
	1998.09-2004.09	Front Axle Left & Right Lower	Hatchback FWD TU5JP		Control Arm Bushing	510682	
	1998.09-2004.09	Front Axle	Hatchback FWD TU5JP		Suspension Repair Kit	S990015SK	
	1998.09-2004.09	Front Axle Left & Right	Hatchback FWD TU5JP		Tie Rod Axle Joint	S030231	
	1998.09-2004.09	Front Axle Left	Hatchback FWD TU5JP		Tie Rod End	S070106	
	1998.09-2004.09	Front Axle Right	Hatchback FWD TU5JP		Tie Rod End	S070105	
	1998.09-2004.09	Front Axle Left & Right	Hatchback FWD TU5JP		Rod/Strut, stabiliser	S050111	
	1998.09-2004.09	Front Axle	Hatchback FWD TU5JP		Stabiliser Bushing	530899	
	1998.09-2004.09	Front Axle	Hatchback FWD TU5JP		Steering Boot	540190	
	1998.09-2004.09	Front Axle	Hatchback FWD TU5JP		Steering Rack Bellow Kit	540190S	
1.6 (80 kw)	2000.07-2009.04	Front Axle Left	Hatchback FWD TU5JP4		Tie Rod End	S070106	
	2000.07-2009.04	Front Axle Right	Hatchback FWD TU5JP4		Tie Rod End	S070105	
	2000.07-2009.04	Front Axle Left & Right	Hatchback FWD TU5JP4		Rod/Strut, stabiliser	S050111	
206 CC							
1.6 (80 kw)	2000.07-2007.02	Front Axle Left Lower	Cabriolet FWD TU5JP4		Track Control Arm	S060879	
	2000.07-2007.02	Front Axle Right Lower	Cabriolet FWD TU5JP4		Track Control Arm	S060880	
	2000.07-2007.02	Front Axle Left & Right Lower	Cabriolet FWD TU5JP4		Control Arm Bushing	510680	
	2000.07-2007.02	Front Axle Left & Right Lower	Cabriolet FWD TU5JP4		Control Arm Bushing	510681	
	2000.07-2007.02	Front Axle Left & Right Lower	Cabriolet FWD TU5JP4		Control Arm Bushing	510682	
	2000.07-2007.02	Front Axle Left & Right Lower	Cabriolet FWD TU5JP4		Control Arm Bushing	510735	
	2000.07-2007.02	Front Axle Left & Right	Cabriolet FWD TU5JP4		Tie Rod Axle Joint	S030231	
	2000.07-2007.02	Front Axle Right	Cabriolet FWD TU5JP4		Tie Rod End	S070105	
	2000.07-2007.02	Front Axle Right	Cabriolet FWD TU5JP4		Tie Rod End	S070106	
	2000.07-2007.02	Front Axle Left & Right	Cabriolet FWD TU5JP4		Rod/Strut, stabiliser	S050111	
	2000.07-2007.02	Front Axle	Cabriolet FWD TU5JP4		Stabiliser Bushing	530899	
	2000.07-2007.02	Front Axle	Cabriolet FWD TU5JP4		Steering Boot	540190	
	2000.07-2007.02	Front Axle	Cabriolet FWD TU5JP4		Steering Rack Bellow Kit	540190S	
206 SW							
1.4 (55 kw)	2002.07-2007.02	Front Axle Left Lower	Estate FWD TU3A/TU3JP		Track Control Arm	S060290	
	2002.07-2007.02	Front Axle Right Lower	Estate FWD TU3A/TU3JP	Engine code:KFW(TU3JP),Org.No.to:09440	Track Control Arm	S060289	
	2002.07-2007.02	Front Axle Right Lower	Estate FWD TU3A/TU3JP		Track Control Arm	S060880	
	2002.07-2007.02	Front Axle Left & Right Lower	Estate FWD TU3A/TU3JP		Control Arm Bushing	510680	
	2002.07-2007.02	Front Axle Left & Right Lower	Estate FWD TU3A/TU3JP		Control Arm Bushing	510681	
	2002.07-2007.02	Front Axle Left & Right Lower	Estate FWD TU3A/TU3JP		Control Arm Bushing	510682	
	2002.07-2007.02	Front Axle	Estate FWD TU3A/TU3JP		Suspension Repair Kit	S990015SK	
	2002.07-2007.02	Front Axle	Estate FWD TU3A/TU3JP		Suspension Repair Kit	S990040SK	
	2002.07-2007.02	Front Axle Left & Right	Estate FWD TU3A/TU3JP		Tie Rod Axle Joint	S030231	
	2002.07-2007.02	Front Axle Left	Estate FWD TU3A/TU3JP		Tie Rod End	S070106	
	2002.07-2007.02	Front Axle Right	Estate FWD TU3A/TU3JP		Tie Rod End	S070105	
	2002.07-2007.02	Front Axle Left & Right	Estate FWD TU3A/TU3JP		Rod/Strut, stabiliser	S050111	
	2002.07-2007.02	Front Axle	Estate FWD TU3A/TU3JP		Steering Boot	540190	
	2002.07-2007.02	Front Axle	Estate FWD TU3A/TU3JP		Steering Rack Bellow Kit	540190S	
	1.6 (80 kw)	2002.07-2007.02	Front Axle Left Lower	Estate FWD TU5JP4		Track Control Arm	S060879
		2002.07-2007.02	Front Axle Right Lower	Estate FWD TU5JP4		Track Control Arm	S060880
		2002.07-2007.02	Front Axle Left & Right Lower	Estate FWD TU5JP4	RPO no.from:09452	Control Arm Bushing	510680
2002.07-2007.02		Front Axle Left & Right Lower	Estate FWD TU5JP4		Control Arm Bushing	510681	
2002.07-2007.02		Front Axle Left & Right Lower	Estate FWD TU5JP4		Control Arm Bushing	510735	
2002.07-2007.02		Front Axle	Estate FWD TU5JP4		Suspension Repair Kit	S990015SK	
2002.07-2007.02		Front Axle	Estate FWD TU5JP4		Suspension Repair Kit	S990040SK	
2002.07-2007.02		Front Axle Left & Right	Estate FWD TU5JP4		Tie Rod Axle Joint	S030231	
2002.07-2007.02		Front Axle Left	Estate FWD TU5JP4		Tie Rod End	S070106	
2002.07-2007.02		Front Axle Right	Estate FWD TU5JP4		Tie Rod End	S070105	
2002.07-2007.02		Front Axle Left & Right	Estate FWD TU5JP4		Rod/Strut, stabiliser	S050111	



	 YEAR	FITTING POSITION	BODY STYLE & DRIVE TYPE & ENGINE	REMARKS	PRODUCT	GSP Ref.
PEUGEOT						
206 SW						
1.6 (80 kw)	2002.07-2007.02	Front Axle	Estate FWD TU5JP4		Steering Boot	540190
	2002.07-2007.02	Front Axle	Estate FWD TU5JP4		Steering Rack Bellow Kit	540190S
207						
1.4 (60 kw)	2008.11-2014.12	Front Axle Left & Right	Saloon FWD TU3JP		Tie Rod End	S070824
	2008.11-2014.12	Front Axle Left & Right	Saloon FWD TU3JP		Tie Rod End	S070866
1.6 (83 kw)	2008.01-2013.12	Front Axle Left & Right	Saloon FWD TU5JP4		Tie Rod End	S070824
	2008.01-2013.12	Front Axle Left & Right	Saloon FWD TU5JP4		Tie Rod End	S070866
	2008.01-2013.12	Front Axle	Saloon FWD TU5JP4	The main part is 541034	Steering Rack Bellow Kit	541034S
	2008.08-2013.12	Front Axle	Hatchback FWD TU5JP4	The main part is 541034	Steering Rack Bellow Kit	541034S
207 SW						
1.6 (83 kw)	2008.08-2013.12	Front Axle	Estate FWD TU5JP4	The main part is 541034	Steering Rack Bellow Kit	541034S
3008						
1.6 (115 kw)	2009.06-2016.08	Front Axle Left Lower	MPV FWD EP6CDT		Track Control Arm	S060884
	2009.06-2016.08	Front Axle Right Lower	MPV FWD EP6CDT		Track Control Arm	S060883
	2009.06-2016.08	Front Axle Left & Right Lower	MPV FWD EP6CDT		Ball Joint	S080040
	2009.06-2016.08	Front Axle Left & Right Lower	MPV FWD EP6CDT		Control Arm Bushing	510682
	2009.06-2016.08	Front Axle Left & Right Lower	MPV FWD EP6CDT		Control Arm Bushing	511919
	2009.06-2016.08	Front Axle	MPV FWD EP6CDT		Suspension Repair Kit	S990063SK
	2009.06-2016.08	Front Axle Left & Right	MPV FWD EP6CDT		Tie Rod Axle Joint	S030236
	2009.06-2016.08	Front Axle Left	MPV FWD EP6CDT		Tie Rod End	S070107
	2009.06-2016.08	Front Axle Right	MPV FWD EP6CDT		Tie Rod End	S070108
	2009.06-2016.08	Front Axle Left & Right	MPV FWD EP6CDT		Rod/Strut, stabiliser	S050109
1.6 (121 kw)	2014.05-2016.08	Front Axle Left Lower	MPV FWD EP6CDTM/EP6FDT		Track Control Arm	S060884
	2014.05-2016.08	Front Axle Right Lower	MPV FWD EP6CDTM/EP6FDT		Track Control Arm	S060883
	2014.05-2016.08	Front Axle Left & Right Lower	MPV FWD EP6CDTM/EP6FDT		Ball Joint	S080040
	2014.05-2016.08	Front Axle Left & Right Lower	MPV FWD EP6CDTM/EP6FDT		Control Arm Bushing	510682
	2014.05-2016.08	Front Axle Left & Right Lower	MPV FWD EP6CDTM/EP6FDT		Control Arm Bushing	511919
	2014.05-2016.08	Front Axle Left & Right	MPV FWD EP6CDTM/EP6FDT		Tie Rod Axle Joint	S030236
	2014.05-2016.08	Front Axle Left	MPV FWD EP6CDTM/EP6FDT		Tie Rod End	S070107
	2014.05-2016.08	Front Axle Right	MPV FWD EP6CDTM/EP6FDT		Tie Rod End	S070108
	2014.05-2016.08	Front Axle Left & Right	MPV FWD EP6CDTM/EP6FDT		Rod/Strut, stabiliser	S050109
	2016.05-	Front Axle Left & Right Lower	SUV FWD EP6FDT/EP6FDTM		Ball Joint	S080988
	2016.05-	Front Axle Left & Right Lower	SUV FWD EP6FDT/EP6FDTM		Control Arm Bushing	533520
	2016.05-	Front Axle Left & Right	SUV FWD EP6FDT/EP6FDTM		Tie Rod Axle Joint	S030709
	2016.05-	Front Axle Left	SUV FWD EP6FDT/EP6FDTM		Tie Rod End	S071654
	2016.05-	Front Axle Right	SUV FWD EP6FDT/EP6FDTM		Tie Rod End	S071639
	2016.05-	Front Axle Left & Right	SUV FWD EP6FDT/EP6FDTM		Rod/Strut, stabiliser	S050109
306						
1.4 (55 kw)	1996.03-2001.07	Front Axle Left Lower	Hatchback van FWD TU3JP	RPO no.to:7969	Track Control Arm	S060375
	1996.03-2001.07	Front Axle Left Lower	Hatchback van FWD TU3JP	Org.No.from:7970	Track Control Arm	S063014
	1996.03-2001.07	Front Axle Right Lower	Hatchback van FWD TU3JP	RPO no.to:7969	Track Control Arm	S060374
	1996.03-2001.07	Front Axle Right Lower	Hatchback van FWD TU3JP	Org.No.from:7970	Track Control Arm	S063015
	1996.03-2001.07	Front Axle Left & Right Lower	Hatchback van FWD TU3JP		Ball Joint	S080187
	1996.03-2001.07	Front Axle Left & Right	Hatchback van FWD TU3JP		Rod/Strut, stabiliser	S050110
1.6 (66 kw)	1993.01-2001.05	Front Axle Left Lower	Hatchback FWD TU5JP	RPO no.to:7969	Track Control Arm	S060375
	1993.01-2001.05	Front Axle Left Lower	Hatchback FWD TU5JP	Org.No.from:7970	Track Control Arm	S063014
	1993.01-2001.05	Front Axle Right Lower	Hatchback FWD TU5JP	RPO no.to:7969	Track Control Arm	S060374
	1993.01-2001.05	Front Axle Right Lower	Hatchback FWD TU5JP	Org.No.from:7970	Track Control Arm	S063015
	1993.01-2001.05	Front Axle Left & Right Lower	Hatchback FWD TU5JP		Ball Joint	S080191
	1993.01-2001.05	Front Axle Left & Right Lower	Hatchback FWD TU5JP		Control Arm Bushing	510689
	1993.01-2001.05	Front Axle Left & Right Lower	Hatchback FWD TU5JP		Control Arm Bushing	510690
	1993.01-2001.05	Front Axle Left & Right	Hatchback FWD TU5JP		Tie Rod Axle Joint	S030235
	1993.01-2001.05	Front Axle Left & Right	Hatchback FWD TU5JP		Tie Rod End	S070104
	1993.01-2001.05	Front Axle Left & Right	Hatchback FWD TU5JP		Rod/Strut, stabiliser	S050115
	1993.01-2001.05	Front Axle Left & Right	Hatchback FWD TU5JP		Rod/Strut, stabiliser	S100044
	1993.01-2001.05	Front Axle	Hatchback FWD TU5JP		Stabiliser Bushing	510701
	1993.01-2001.05	Front Axle	Hatchback FWD TU5JP		Stabiliser Bushing	512500
	1993.01-2001.05	Front Axle	Hatchback FWD TU5JP		Stabiliser Bushing	512800
	1993.01-2001.05	Front Axle	Hatchback FWD TU5JP		Steering Boot	540061
	1993.01-2001.05	Front Axle	Hatchback FWD TU5JP		Steering Boot	540332
	1993.01-2001.05	Front Axle	Hatchback FWD TU5JP		Steering Boot	540414
	1993.01-2001.05	Front Axle Left	Hatchback FWD TU5JP	for org. no.08657 for vehicles without power steering	Steering Rack Bellow Kit	540061S
1.8 (74 kw)	1993.05-2001.05	Front Axle Left Lower	Hatchback FWD XU7JP	RPO no.to:7969	Track Control Arm	S060375
	1993.05-2001.05	Front Axle Left Lower	Hatchback FWD XU7JP	Org.No.from:7970	Track Control Arm	S063014



	 YEAR	FITTING POSITION	BODY STYLE & DRIVE TYPE & ENGINE	REMARKS	PRODUCT	GSP Ref.
PEUGEOT						
306						
1.8 (74 kw)	1993.05-2001.05	Front Axle Right Lower	Hatchback FWD XU7JP	RPO no.to:7969	Track Control Arm	S060374
	1993.05-2001.05	Front Axle Right Lower	Hatchback FWD XU7JP	Org.No.from:7970	Track Control Arm	S063015
	1993.05-2001.05	Front Axle Left & Right Lower	Hatchback FWD XU7JP		Ball Joint	S080187
	1993.05-2001.05	Front Axle Left & Right Lower	Hatchback FWD XU7JP		Ball Joint	S080191
	1993.05-2001.05	Front Axle Left & Right Lower	Hatchback FWD XU7JP		Control Arm Bushing	510689
	1993.05-2001.05	Front Axle Left & Right Lower	Hatchback FWD XU7JP		Control Arm Bushing	510690
	1993.05-2001.05	Front Axle Left & Right	Hatchback FWD XU7JP		Tie Rod Axle Joint	S030235
	1993.05-2001.05	Front Axle Left & Right	Hatchback FWD XU7JP		Tie Rod End	S070104
	1993.05-2001.05	Front Axle Left & Right	Hatchback FWD XU7JP	Date to:1994.09	Rod/Strut,stabiliser	S050115
	1993.05-2001.05	Front Axle Left & Right	Hatchback FWD XU7JP	Date from:1994.09	Rod/Strut,stabiliser	S100044
	1993.05-2001.05	Front Axle	Hatchback FWD XU7JP		Stabiliser Bushing	510701
	1993.05-2001.05	Front Axle	Hatchback FWD XU7JP		Stabiliser Bushing	512500
	1993.05-2001.05	Front Axle	Hatchback FWD XU7JP		Stabiliser Bushing	512800
	1993.05-2001.05	Front Axle	Hatchback FWD XU7JP		Stabiliser Bushing	512801
	1993.05-2001.05	Front Axle	Hatchback FWD XU7JP		Steering Boot	540061
	1993.05-2001.05	Front Axle	Hatchback FWD XU7JP		Steering Boot	540332
	1993.05-2001.05	Front Axle	Hatchback FWD XU7JP		Steering Boot	540414
	1993.05-2001.05	Front Axle Left	Hatchback FWD XU7JP	for Org.No. 06657 for vehicles without power steering	Steering Rack Bellow Kit	540061S
	1994.06-2003.10	Front Axle Left Lower	Saloon FWD XU7JP	RPO no.to:7969	Track Control Arm	S060375
	1994.06-2003.10	Front Axle Left Lower	Saloon FWD XU7JP	Org.No.from:7970	Track Control Arm	S063014
	1994.06-2003.10	Front Axle Right Lower	Saloon FWD XU7JP	RPO no.to:7969	Track Control Arm	S060374
	1994.06-2003.10	Front Axle Right Lower	Saloon FWD XU7JP	Org.No.from:7970	Track Control Arm	S063015
	1994.06-2003.10	Front Axle Left & Right Lower	Saloon FWD XU7JP	Date from:1994.09	Ball Joint	S080187
	1994.06-2003.10	Front Axle Left & Right Lower	Saloon FWD XU7JP		Ball Joint	S080191
	1994.06-2003.10	Front Axle Left & Right Lower	Saloon FWD XU7JP		Control Arm Bushing	510689
	1994.06-2003.10	Front Axle Left & Right Lower	Saloon FWD XU7JP		Control Arm Bushing	510690
	1994.06-2003.10	Front Axle Left & Right	Saloon FWD XU7JP		Tie Rod Axle Joint	S030235
	1994.06-2003.10	Front Axle Left & Right	Saloon FWD XU7JP		Tie Rod End	S070104
	1994.06-2003.10	Front Axle Left & Right	Saloon FWD XU7JP	Not f Modelcode:7BLFZ4	Rod/Strut,stabiliser	S050110
	1994.06-2003.10	Front Axle Left & Right	Saloon FWD XU7JP	Date to:1994.09	Rod/Strut,stabiliser	S050115
	1994.06-2003.10	Front Axle Left & Right	Saloon FWD XU7JP		Rod/Strut,stabiliser	S100044
	1994.06-2003.10	Front Axle	Saloon FWD XU7JP		Stabiliser Bushing	510701
	1994.06-2003.10	Front Axle	Saloon FWD XU7JP		Stabiliser Bushing	512500
	1994.06-2003.10	Front Axle	Saloon FWD XU7JP		Stabiliser Bushing	512800
	1994.06-2003.10	Front Axle	Saloon FWD XU7JP		Stabiliser Bushing	512801
	1994.06-2003.10	Front Axle	Saloon FWD XU7JP		Steering Boot	540061
	1994.06-2003.10	Front Axle	Saloon FWD XU7JP		Steering Boot	540332
	1994.06-2003.10	Front Axle	Saloon FWD XU7JP		Steering Boot	540414
	1994.06-2003.10	Front Axle Left	Saloon FWD XU7JP	for vehicles without power steering	Steering Rack Bellow Kit	540061S
1.8 (81 kw)	1997.03-2001.05	Front Axle Left Lower	Saloon FWD XU7JP4	RPO no.to:7969	Track Control Arm	S060375
	1997.03-2001.05	Front Axle Left Lower	Saloon FWD XU7JP4	Org.No.from:7970	Track Control Arm	S063014
	1997.03-2001.05	Front Axle Right Lower	Saloon FWD XU7JP4	RPO no.to:7969	Track Control Arm	S060374
	1997.03-2001.05	Front Axle Right Lower	Saloon FWD XU7JP4	Org.No.from:7970	Track Control Arm	S063015
	1997.03-2001.05	Front Axle Left & Right Lower	Saloon FWD XU7JP4	Org.No.from:07906	Ball Joint	S080187
	1997.03-2001.05	Front Axle Left & Right Lower	Saloon FWD XU7JP4	Org.No.to:07905	Ball Joint	S080191
	1997.03-2001.05	Front Axle Left & Right Lower	Saloon FWD XU7JP4		Control Arm Bushing	510689
	1997.03-2001.05	Front Axle Left & Right Lower	Saloon FWD XU7JP4		Control Arm Bushing	510690
	1997.03-2001.05	Front Axle Left & Right	Saloon FWD XU7JP4		Tie Rod Axle Joint	S030235
	1997.03-2001.05	Front Axle Left & Right	Saloon FWD XU7JP4		Tie Rod End	S070104
	1997.03-2001.05	Front Axle Left & Right	Saloon FWD XU7JP4		Rod/Strut,stabiliser	S100044
	1997.03-2001.05	Front Axle	Saloon FWD XU7JP4		Stabiliser Bushing	510701
	1997.03-2001.05	Front Axle	Saloon FWD XU7JP4		Stabiliser Bushing	512500
	1997.03-2001.05	Front Axle	Saloon FWD XU7JP4		Stabiliser Bushing	512801
	1997.03-2001.05	Front Axle	Saloon FWD XU7JP4		Steering Boot	540061
	1997.03-2001.05	Front Axle	Saloon FWD XU7JP4		Steering Boot	540414
	1997.03-2001.05	Front Axle Left	Saloon FWD XU7JP4	Fitting Position: Driver side	Steering Rack Bellow Kit	540061S
	1997.05-2002.04	Front Axle Left Lower	Estate FWD XU7JP4	RPO no.to:7969	Track Control Arm	S060375
	1997.05-2002.04	Front Axle Left Lower	Estate FWD XU7JP4	Org.No.from:7970	Track Control Arm	S063014
	1997.05-2002.04	Front Axle Right Lower	Estate FWD XU7JP4	RPO no.to:7969	Track Control Arm	S060374
	1997.05-2002.04	Front Axle Right Lower	Estate FWD XU7JP4	Org.No.from:7970	Track Control Arm	S063015
	1997.05-2002.04	Front Axle Left & Right Lower	Estate FWD XU7JP4	Org.No.from:07906	Ball Joint	S080187
	1997.05-2002.04	Front Axle Left & Right Lower	Estate FWD XU7JP4	Org.No.to:07905	Ball Joint	S080191
	1997.05-2002.04	Front Axle Left & Right Lower	Estate FWD XU7JP4		Control Arm Bushing	510689
	1997.05-2002.04	Front Axle Left & Right Lower	Estate FWD XU7JP4		Control Arm Bushing	510690



	 YEAR	FITTING POSITION	BODY STYLE & DRIVE TYPE & ENGINE	REMARKS	PRODUCT	GSP Ref.
PEUGEOT						
306						
1.8 (81 kw)	1997.05-2002.04	Front Axle Left & Right	Estate FWD XU7JP4		Tie Rod Axle Joint	S030235
	1997.05-2002.04	Front Axle Left & Right	Estate FWD XU7JP4		Tie Rod End	S070104
	1997.05-2002.04	Front Axle Left & Right	Estate FWD XU7JP4		Rod/Strut,stabiliser	S100044
	1997.05-2002.04	Front Axle	Estate FWD XU7JP4		Stabiliser Bushing	510701
	1997.05-2002.04	Front Axle	Estate FWD XU7JP4		Stabiliser Bushing	512500
	1997.05-2002.04	Front Axle	Estate FWD XU7JP4		Stabiliser Bushing	512800
	1997.05-2002.04	Front Axle	Estate FWD XU7JP4		Stabiliser Bushing	512801
	1997.05-2002.04	Front Axle	Estate FWD XU7JP4		Steering Boot	540061
	1997.05-2002.04	Front Axle	Estate FWD XU7JP4		Steering Boot	540414
	1997.05-2002.04	Front Axle Left	Estate FWD XU7JP4	Fitting Position: Driver side	Steering Rack Bellow Kit	540061S
	1997.05-2003.10	Front Axle Left Lower	Hatchback FWD XU7JP4	RPO no.to:7969	Track Control Arm	S060375
	1997.05-2003.10	Front Axle Left Lower	Hatchback FWD XU7JP4	Org.No.from:7970	Track Control Arm	S063014
	1997.05-2003.10	Front Axle Right Lower	Hatchback FWD XU7JP4	RPO no.to:7969	Track Control Arm	S060374
	1997.05-2003.10	Front Axle Right Lower	Hatchback FWD XU7JP4	Org.No.from:7970	Track Control Arm	S063015
	1997.05-2003.10	Front Axle Left & Right Lower	Hatchback FWD XU7JP4	Org.No.from:07906	Ball Joint	S080187
	1997.05-2003.10	Front Axle Left & Right Lower	Hatchback FWD XU7JP4	Org.No.to:07905	Ball Joint	S080191
	1997.05-2003.10	Front Axle Left & Right Lower	Hatchback FWD XU7JP4		Control Arm Bushing	510689
	1997.05-2003.10	Front Axle Left & Right Lower	Hatchback FWD XU7JP4		Control Arm Bushing	510690
	1997.05-2003.10	Front Axle Left & Right	Hatchback FWD XU7JP4		Tie Rod Axle Joint	S030235
	1997.05-2003.10	Front Axle Left & Right	Hatchback FWD XU7JP4		Tie Rod End	S070104
	1997.05-2003.10	Front Axle Left & Right	Hatchback FWD XU7JP4		Rod/Strut,stabiliser	S100044
	1997.05-2003.10	Front Axle	Hatchback FWD XU7JP4		Stabiliser Bushing	510701
	1997.05-2003.10	Front Axle	Hatchback FWD XU7JP4		Stabiliser Bushing	512500
	1997.05-2003.10	Front Axle	Hatchback FWD XU7JP4		Stabiliser Bushing	512801
	1997.05-2003.10	Front Axle	Hatchback FWD XU7JP4		Steering Boot	540061
	1997.05-2003.10	Front Axle	Hatchback FWD XU7JP4		Steering Boot	540414
	1997.05-2003.10	Front Axle Left	Hatchback FWD XU7JP4	Fitting Position: Driver side	Steering Rack Bellow Kit	540061S
1.8 (82 kw)	1997.03-2003.10	Front Axle Left Lower	Hatchback FWD XU7JP4	RPO no.to:7969	Track Control Arm	S060375
	1997.03-2003.10	Front Axle Left Lower	Hatchback FWD XU7JP4	Org.No.from:7970	Track Control Arm	S063014
	1997.03-2003.10	Front Axle Right Lower	Hatchback FWD XU7JP4	RPO no.to:7969	Track Control Arm	S060374
	1997.03-2003.10	Front Axle Right Lower	Hatchback FWD XU7JP4	Org.No.from:7970	Track Control Arm	S063015
	1997.03-2003.10	Front Axle Left & Right Lower	Hatchback FWD XU7JP4	Org.No.from:07906	Ball Joint	S080187
	1997.03-2003.10	Front Axle Left & Right Lower	Hatchback FWD XU7JP4	Org.No.to:07905	Ball Joint	S080191
	1997.03-2003.10	Front Axle Left & Right Lower	Hatchback FWD XU7JP4		Control Arm Bushing	510689
	1997.03-2003.10	Front Axle Left & Right Lower	Hatchback FWD XU7JP4		Control Arm Bushing	510690
	1997.03-2003.10	Front Axle Left & Right	Hatchback FWD XU7JP4		Tie Rod Axle Joint	S030235
	1997.03-2003.10	Front Axle Left & Right	Hatchback FWD XU7JP4		Tie Rod End	S070104
	1997.03-2003.10	Front Axle Left & Right	Hatchback FWD XU7JP4		Rod/Strut,stabiliser	S100044
	1997.03-2003.10	Front Axle	Hatchback FWD XU7JP4		Stabiliser Bushing	510701
	1997.03-2003.10	Front Axle	Hatchback FWD XU7JP4		Stabiliser Bushing	512500
	1997.03-2003.10	Front Axle	Hatchback FWD XU7JP4		Steering Boot	540061
	1997.03-2003.10	Front Axle	Hatchback FWD XU7JP4		Steering Boot	540414
	1997.03-2003.10	Front Axle Left	Hatchback FWD XU7JP4		Steering Rack Bellow Kit	540061S
2.0 (89 kw)	1993.05-2001.05	Front Axle Left Lower	Hatchback FWD XU10J2	RPO no.to:7969	Track Control Arm	S060375
	1993.05-2001.05	Front Axle Left Lower	Hatchback FWD XU10J2	Org.No.from:7970	Track Control Arm	S063014
	1993.05-2001.05	Front Axle Right Lower	Hatchback FWD XU10J2	RPO no.to:7969	Track Control Arm	S060374
	1993.05-2001.05	Front Axle Right Lower	Hatchback FWD XU10J2	Org.No.from:7970	Track Control Arm	S063015
	1993.05-2001.05	Front Axle Left & Right Lower	Hatchback FWD XU10J2		Ball Joint	S080187
	1993.05-2001.05	Front Axle Left & Right Lower	Hatchback FWD XU10J2		Ball Joint	S080191
	1993.05-2001.05	Front Axle Left & Right Lower	Hatchback FWD XU10J2		Control Arm Bushing	510689
	1993.05-2001.05	Front Axle Left & Right Lower	Hatchback FWD XU10J2		Control Arm Bushing	510690
	1993.05-2001.05	Front Axle Left & Right	Hatchback FWD XU10J2		Tie Rod Axle Joint	S030235
	1993.05-2001.05	Front Axle Left & Right	Hatchback FWD XU10J2		Tie Rod End	S070104
	1993.05-2001.05	Front Axle Left & Right	Hatchback FWD XU10J2		Rod/Strut,stabiliser	S050110
	1993.05-2001.05	Front Axle Left & Right	Hatchback FWD XU10J2	Date to:1994.09	Rod/Strut,stabiliser	S050115
	1993.05-2001.05	Front Axle Left & Right	Hatchback FWD XU10J2	Date from:1994.09	Rod/Strut,stabiliser	S100044
	1993.05-2001.05	Front Axle	Hatchback FWD XU10J2		Stabiliser Bushing	510701
	1993.05-2001.05	Front Axle	Hatchback FWD XU10J2		Stabiliser Bushing	512500
	1993.05-2001.05	Front Axle	Hatchback FWD XU10J2		Stabiliser Bushing	512800
	1993.05-2001.05	Front Axle	Hatchback FWD XU10J2		Stabiliser Bushing	512801
	1993.05-2001.05	Front Axle	Hatchback FWD XU10J2		Steering Boot	540061
	1993.05-2001.05	Front Axle	Hatchback FWD XU10J2		Steering Boot	540332
	1993.05-2001.05	Front Axle	Hatchback FWD XU10J2		Steering Boot	540414
	1993.05-2001.05	Front Axle Left	Hatchback FWD XU10J2	for Org.No. 09657 for vehicles without power steering	Steering Rack Bellow Kit	540061S



	 YEAR	FITTING POSITION	BODY STYLE & DRIVE TYPE & ENGINE	REMARKS	PRODUCT	GSP Ref.
PEUGEOT						
306						
2.0 (110 kw)	1994.06-2001.05	Front Axle Left Lower	Hatchback FWD XU10J4	RPO no.to:7969	Track Control Arm	S060375
	1994.06-2001.05	Front Axle Left Lower	Hatchback FWD XU10J4	Org.No.from:7970	Track Control Arm	S063014
	1994.06-2001.05	Front Axle Right Lower	Hatchback FWD XU10J4	RPO no.to:7969	Track Control Arm	S060374
	1994.06-2001.05	Front Axle Right Lower	Hatchback FWD XU10J4	Org.No.from:7970	Track Control Arm	S063015
	1994.06-2001.05	Front Axle Left & Right Lower	Hatchback FWD XU10J4		Ball Joint	S080187
	1994.06-2001.05	Front Axle Left & Right Lower	Hatchback FWD XU10J4		Ball Joint	S080191
	1994.06-2001.05	Front Axle Left & Right Lower	Hatchback FWD XU10J4		Control Arm Bushing	510689
	1994.06-2001.05	Front Axle Left & Right Lower	Hatchback FWD XU10J4		Control Arm Bushing	510690
	1994.06-2001.05	Front Axle Left & Right	Hatchback FWD XU10J4		Tie Rod Axle Joint	S030235
	1994.06-2001.05	Front Axle Left & Right	Hatchback FWD XU10J4		Tie Rod End	S070104
	1994.06-2001.05	Front Axle Left & Right	Hatchback FWD XU10J4		Tie Rod End	S070824
	1994.06-2001.05	Front Axle Left & Right	Hatchback FWD XU10J4		Tie Rod End	S070866
	1994.06-2001.05	Front Axle Left & Right	Hatchback FWD XU10J4		Rod/Strut,stabiliser	S050110
	1994.06-2001.05	Front Axle Left & Right	Hatchback FWD XU10J4	Date to:1994.09	Rod/Strut,stabiliser	S050115
	1994.06-2001.05	Front Axle Left & Right	Hatchback FWD XU10J4	Date from:1994.09	Rod/Strut,stabiliser	S100044
	1994.06-2001.05	Front Axle	Hatchback FWD XU10J4		Stabiliser Bushing	510701
	1994.06-2001.05	Front Axle	Hatchback FWD XU10J4		Stabiliser Bushing	512500
	1994.06-2001.05	Front Axle	Hatchback FWD XU10J4		Stabiliser Bushing	512800
	1994.06-2001.05	Front Axle	Hatchback FWD XU10J4		Stabiliser Bushing	512801
	1994.06-2001.05	Front Axle	Hatchback FWD XU10J4		Steering Boot	540061
	1994.06-2001.05	Front Axle	Hatchback FWD XU10J4		Steering Boot	540332
	1994.06-2001.05	Front Axle	Hatchback FWD XU10J4		Steering Boot	540414
	1994.06-2001.05	Front Axle Left	Hatchback FWD XU10J4	for org no. 06657 for vehicles without power steering	Steering Rack Bellow Kit	540061S
306 Cabrio						
2.0 (89 kw)	1994.03-1997.04	Front Axle Left Lower	Cabriolet FWD XU10J2	RPO no.to:7969	Track Control Arm	S060375
	1994.03-1997.04	Front Axle Left Lower	Cabriolet FWD XU10J2	Org.No.from:7970	Track Control Arm	S063014
	1994.03-1997.04	Front Axle Right Lower	Cabriolet FWD XU10J2	RPO no.to:7969	Track Control Arm	S060374
	1994.03-1997.04	Front Axle Right Lower	Cabriolet FWD XU10J2	Org.No.from:7970	Track Control Arm	S063015
	1994.03-1997.04	Front Axle Left & Right Lower	Cabriolet FWD XU10J2		Ball Joint	S080191
	1994.03-1997.04	Front Axle Left & Right Lower	Cabriolet FWD XU10J2		Control Arm Bushing	510689
	1994.03-1997.04	Front Axle Left & Right Lower	Cabriolet FWD XU10J2		Control Arm Bushing	510690
	1994.03-1997.04	Front Axle Left & Right	Cabriolet FWD XU10J2		Tie Rod Axle Joint	S030235
	1994.03-1997.04	Front Axle Left & Right	Cabriolet FWD XU10J2		Tie Rod End	S070104
	1994.03-1997.04	Front Axle Left & Right	Cabriolet FWD XU10J2		Rod/Strut,stabiliser	S050110
	1994.03-1997.04	Front Axle Left & Right	Cabriolet FWD XU10J2	Date to:1994.09	Rod/Strut,stabiliser	S050115
	1994.03-1997.04	Front Axle Left & Right	Cabriolet FWD XU10J2	Date from:1994.09	Rod/Strut,stabiliser	S100044
	1994.03-1997.04	Front Axle	Cabriolet FWD XU10J2		Stabiliser Bushing	510701
	1994.03-1997.04	Front Axle	Cabriolet FWD XU10J2		Stabiliser Bushing	512500
	1994.03-1997.04	Front Axle	Cabriolet FWD XU10J2		Stabiliser Bushing	512800
	1994.03-1997.04	Front Axle	Cabriolet FWD XU10J2		Stabiliser Bushing	512801
	1994.03-1997.04	Front Axle	Cabriolet FWD XU10J2		Steering Boot	540061
	1994.03-1997.04	Front Axle	Cabriolet FWD XU10J2		Steering Boot	540332
	1994.03-1997.04	Front Axle	Cabriolet FWD XU10J2		Steering Boot	540414
	1994.03-1997.04	Front Axle Left	Cabriolet FWD XU10J2	for Org.No. 06657 for vehicles without power steering	Steering Rack Bellow Kit	540061S
307						
1.6 (80 kw)	2000.08-2007.11	Front Axle Left Lower	Hatchback FWD TU5JP4		Track Control Arm	S060146
	2000.08-2007.11	Front Axle Right Lower	Hatchback FWD TU5JP4		Track Control Arm	S060145
	2000.08-2007.11	Front Axle Left & Right Lower	Hatchback FWD TU5JP4		Ball Joint	S080040
	2000.08-2007.11	Front Axle Left & Right Lower	Hatchback FWD TU5JP4		Control Arm Bushing	510682
	2000.08-2007.11	Front Axle Left & Right Lower	Hatchback FWD TU5JP4		Control Arm Bushing	511919
	2000.08-2007.11	Front Axle Left & Right	Hatchback FWD TU5JP4	Org.No.from:10311	Tie Rod Axle Joint	S030022
	2000.08-2007.11	Front Axle Left & Right	Hatchback FWD TU5JP4	Org.No.to:10310	Tie Rod Axle Joint	S030229
	2000.08-2007.11	Front Axle Left	Hatchback FWD TU5JP4		Tie Rod End	S070106
	2000.08-2007.11	Front Axle Right	Hatchback FWD TU5JP4		Tie Rod End	S070105
	2000.08-2007.11	Front Axle Left & Right	Hatchback FWD TU5JP4		Tie Rod End	S070104
	2000.08-2007.11	Front Axle Left & Right	Hatchback FWD TU5JP4		Rod/Strut,stabiliser	S050109
	2000.08-2007.11	Front Axle	Hatchback FWD TU5JP4		Stabiliser Bushing	530846
	2000.08-2007.11	Front Axle	Hatchback FWD TU5JP4		Steering Boot	540190
	2000.08-2007.11	Front Axle	Hatchback FWD TU5JP4		Steering Rack Bellow Kit	540190S
2.0 (100 kw)	2001.03-2005.06	Front Axle Left Lower	Hatchback FWD EW10J4		Track Control Arm	S060146
	2001.03-2005.06	Front Axle Right Lower	Hatchback FWD EW10J4		Track Control Arm	S060145
	2001.03-2005.06	Front Axle Left & Right Lower	Hatchback FWD EW10J4		Ball Joint	S080040
	2001.03-2005.06	Front Axle Left & Right Lower	Hatchback FWD EW10J4		Control Arm Bushing	510682
	2001.03-2005.06	Front Axle Left & Right Lower	Hatchback FWD EW10J4		Control Arm Bushing	511919

	 YEAR	FITTING POSITION	BODY STYLE & DRIVE TYPE & ENGINE	REMARKS	PRODUCT	GSP Ref.
PEUGEOT 307						
2.0 (100 kw)	2001.03-2005.06	Front Axle Left & Right	Hatchback FWD EW10J4	Org.No.from:10311	Tie Rod Axle Joint	S030022
	2001.03-2005.06	Front Axle Left & Right	Hatchback FWD EW10J4	Org.No.to:10310	Tie Rod Axle Joint	S030229
	2001.03-2005.06	Front Axle Left	Hatchback FWD EW10J4		Tie Rod End	S070106
	2001.03-2005.06	Front Axle Right	Hatchback FWD EW10J4		Tie Rod End	S070105
	2001.03-2005.06	Front Axle Left & Right	Hatchback FWD EW10J4		Tie Rod End	S070104
	2001.03-2005.06	Front Axle Left & Right	Hatchback FWD EW10J4		Rod/Strut,stabiliser	S050109
	2001.03-2005.06	Front Axle	Hatchback FWD EW10J4		Stabiliser Bushing	530846
	2001.03-2005.06	Front Axle	Hatchback FWD EW10J4		Steering Boot	540190
	2001.03-2005.06	Front Axle	Hatchback FWD EW10J4		Steering Rack Bellow Kit	540190S
2.0 (105 kw)	2006.08-2011.12	Front Axle Left Lower	Hatchback FWD EW10A		Track Control Arm	S060146
	2006.08-2011.12	Front Axle Right Lower	Hatchback FWD EW10A		Track Control Arm	S060145
	2006.08-2011.12	Front Axle Left & Right Lower	Hatchback FWD EW10A		Ball Joint	S080040
	2006.08-2011.12	Front Axle Left & Right Lower	Hatchback FWD EW10A		Control Arm Bushing	510682
	2006.08-2011.12	Front Axle Left & Right Lower	Hatchback FWD EW10A		Control Arm Bushing	511919
	2006.08-2011.12	Front Axle Left & Right	Hatchback FWD EW10A		Tie Rod Axle Joint	S030022
	2006.08-2011.12	Front Axle Left & Right	Hatchback FWD EW10A		Tie Rod End	S070104
	2006.08-2011.12	Front Axle Left & Right	Hatchback FWD EW10A		Rod/Strut,stabiliser	S050109
	2006.08-2011.12	Front Axle	Hatchback FWD EW10A		Stabiliser Bushing	530846
	2006.08-2011.12	Front Axle	Hatchback FWD EW10A		Steering Boot	540190
2006.08-2011.12	Front Axle	Hatchback FWD EW10A		Steering Rack Bellow Kit	540190S	
307 CC						
2.0 (100 kw)	2003.10-2005.06	Front Axle Left Lower	Cabriolet FWD EW10J4		Track Control Arm	S060146
	2003.10-2005.06	Front Axle Right Lower	Cabriolet FWD EW10J4		Track Control Arm	S060145
	2003.10-2005.06	Front Axle Left & Right Lower	Cabriolet FWD EW10J4		Ball Joint	S080040
	2003.10-2005.06	Front Axle Left & Right Lower	Cabriolet FWD EW10J4		Control Arm Bushing	510682
	2003.10-2005.06	Front Axle Left & Right Lower	Cabriolet FWD EW10J4		Control Arm Bushing	511919
	2003.10-2005.06	Front Axle Left & Right	Cabriolet FWD EW10J4	Org.No.from:10311	Tie Rod Axle Joint	S030022
	2003.10-2005.06	Front Axle Left & Right	Cabriolet FWD EW10J4	Org.No.to:10310	Tie Rod Axle Joint	S030229
	2003.10-2005.06	Front Axle Left	Cabriolet FWD EW10J4		Tie Rod End	S070106
	2003.10-2005.06	Front Axle Right	Cabriolet FWD EW10J4		Tie Rod End	S070105
	2003.10-2005.06	Front Axle Left & Right	Cabriolet FWD EW10J4		Tie Rod End	S070104
	2003.10-2005.06	Front Axle Left & Right	Cabriolet FWD EW10J4		Rod/Strut,stabiliser	S050109
	2003.10-2005.06	Front Axle	Cabriolet FWD EW10J4		Stabiliser Bushing	530846
	2003.10-2005.06	Front Axle	Cabriolet FWD EW10J4		Steering Boot	540190
	2003.10-2005.06	Front Axle	Cabriolet FWD EW10J4		Steering Rack Bellow Kit	540190S
2.0 (103 kw)	2005.01-2009.04	Front Axle Left Lower	Cabriolet FWD EW10A		Track Control Arm	S060146
	2005.01-2009.04	Front Axle Right Lower	Cabriolet FWD EW10A		Track Control Arm	S060145
	2005.01-2009.04	Front Axle Left & Right Lower	Cabriolet FWD EW10A		Ball Joint	S080040
	2005.01-2009.04	Front Axle Left & Right Lower	Cabriolet FWD EW10A		Control Arm Bushing	510682
	2005.01-2009.04	Front Axle Left & Right Lower	Cabriolet FWD EW10A		Control Arm Bushing	511919
	2005.01-2009.04	Front Axle Left & Right	Cabriolet FWD EW10A	Org.No.from:10311	Tie Rod Axle Joint	S030022
	2005.01-2009.04	Front Axle Left & Right	Cabriolet FWD EW10A	Org.No.to:10310	Tie Rod Axle Joint	S030229
	2005.01-2009.04	Front Axle Left	Cabriolet FWD EW10A		Tie Rod End	S070106
	2005.01-2009.04	Front Axle Right	Cabriolet FWD EW10A		Tie Rod End	S070105
	2005.01-2009.04	Front Axle Left & Right	Cabriolet FWD EW10A		Tie Rod End	S070104
	2005.01-2009.04	Front Axle Left & Right	Cabriolet FWD EW10A		Rod/Strut,stabiliser	S050109
	2005.01-2009.04	Front Axle	Cabriolet FWD EW10A		Stabiliser Bushing	530846
	2005.01-2009.04	Front Axle	Cabriolet FWD EW10A		Steering Boot	540190
	2005.01-2009.04	Front Axle	Cabriolet FWD EW10A		Steering Rack Bellow Kit	540190S
307 SW						
2.0 (100 kw)	2002.04-2005.06	Front Axle Left Lower	Estate FWD EW10J4		Track Control Arm	S060146
	2002.04-2005.06	Front Axle Right Lower	Estate FWD EW10J4		Track Control Arm	S060145
	2002.04-2005.06	Front Axle Left & Right Lower	Estate FWD EW10J4		Ball Joint	S080040
	2002.04-2005.06	Front Axle Left & Right Lower	Estate FWD EW10J4		Control Arm Bushing	510682
	2002.04-2005.06	Front Axle Left & Right Lower	Estate FWD EW10J4		Control Arm Bushing	511919
	2002.04-2005.06	Front Axle Left & Right	Estate FWD EW10J4	Org.No.from:10311	Tie Rod Axle Joint	S030022
	2002.04-2005.06	Front Axle Left & Right	Estate FWD EW10J4	Org.No.to:10310	Tie Rod Axle Joint	S030229
	2002.04-2005.06	Front Axle Left	Estate FWD EW10J4		Tie Rod End	S070106
	2002.04-2005.06	Front Axle Right	Estate FWD EW10J4		Tie Rod End	S070105
	2002.04-2005.06	Front Axle Left & Right	Estate FWD EW10J4		Tie Rod End	S070104
	2002.04-2005.06	Front Axle Left & Right	Estate FWD EW10J4		Rod/Strut,stabiliser	S050109
	2002.04-2005.06	Front Axle	Estate FWD EW10J4		Stabiliser Bushing	530846
	2002.04-2005.06	Front Axle	Estate FWD EW10J4		Steering Boot	540190
	2002.04-2005.06	Front Axle	Estate FWD EW10J4		Steering Rack Bellow Kit	540190S



	 YEAR	FITTING POSITION	BODY STYLE & DRIVE TYPE & ENGINE	REMARKS	PRODUCT	GSP Ref.
PEUGEOT						
307 SW						
2.0 (103 kw)	2005.03-2008.04	Front Axle Left Lower	Estate FWD EW10A		Track Control Arm	S060146
	2005.03-2008.04	Front Axle Right Lower	Estate FWD EW10A		Track Control Arm	S060145
	2005.03-2008.04	Front Axle Left & Right Lower	Estate FWD EW10A		Ball Joint	S080040
	2005.03-2008.04	Front Axle Left & Right Lower	Estate FWD EW10A		Control Arm Bushing	510682
	2005.03-2008.04	Front Axle Left & Right Lower	Estate FWD EW10A		Control Arm Bushing	511919
	2005.03-2008.04	Front Axle Left & Right	Estate FWD EW10A		Tie Rod Axle Joint	S030022
	2005.03-2008.04	Front Axle Left & Right	Estate FWD EW10A		Tie Rod End	S070104
	2005.03-2008.04	Front Axle Left & Right	Estate FWD EW10A		Rod/Strut, stabiliser	S050109
	2005.03-2008.04	Front Axle	Estate FWD EW10A		Stabiliser Bushing	530846
	2005.03-2008.04	Front Axle	Estate FWD EW10A		Steering Boot	540190
	2005.03-2008.04	Front Axle	Estate FWD EW10A		Steering Rack Bellow Kit	540190S
405						
1.8 (74 kw)	1992.08-1995.10	Front Axle Left Lower	Saloon FWD XU7JP	Chassis no.from:71358280	Track Control Arm	S060285
	1992.08-1995.10	Front Axle Right Lower	Saloon FWD XU7JP	Chassis no.from:71358280	Track Control Arm	S060286
	1992.08-1995.10	Front Axle Left & Right Lower	Saloon FWD XU7JP	Chassis no.from:71358276	Ball Joint	S080044
	1992.08-1995.10	Front Axle Left & Right Lower	Saloon FWD XU7JP	Chassis no.to:71358275	Ball Joint	S080048
	1992.08-1995.10	Front Axle Left & Right Lower	Saloon FWD XU7JP	Date to:1994.07;To Production:71358279	Ball Joint	S080749
	1992.08-1995.10	Front Axle Left & Right Lower	Saloon FWD XU7JP		Control Arm Bushing	510685
	1992.08-1995.10	Front Axle Left & Right Lower	Saloon FWD XU7JP		Control Arm Bushing	510686
	1992.08-1995.10	Front Axle Left & Right	Saloon FWD XU7JP		Tie Rod Axle Joint	S030234
	1992.08-1995.10	Front Axle Left	Saloon FWD XU7JP		Tie Rod End	S070381
	1992.08-1995.10	Front Axle Right	Saloon FWD XU7JP		Tie Rod End	S070382
	1992.08-1995.10	Front Axle Left & Right	Saloon FWD XU7JP		Rod/Strut, stabiliser	S050385
	1992.08-1995.10	Front Axle	Saloon FWD XU7JP		Stabiliser Bushing	510698
	1992.08-1995.10	Front Axle	Saloon FWD XU7JP	Date from:1993.01,for vehicles with power steering	Steering Boot	540346
	1992.08-1995.10	Front Axle	Saloon FWD XU7JP		Steering Rack Bellow Kit	540256S
2.0 (89 kw)	1992.08-1996.03	Front Axle Left Lower	Saloon FWD XU10J2	Chassis no.from:71358280	Track Control Arm	S060285
	1992.08-1996.03	Front Axle Right Lower	Saloon FWD XU10J2	Chassis no.from:71358280	Track Control Arm	S060286
	1992.08-1996.03	Front Axle Left & Right Lower	Saloon FWD XU10J2	Chassis no.from:71358276	Ball Joint	S080044
	1992.08-1996.03	Front Axle Left & Right Lower	Saloon FWD XU10J2	Chassis no.to:71358275	Ball Joint	S080048
	1992.08-1996.03	Front Axle Left & Right Lower	Saloon FWD XU10J2	Date to:1994.07	Ball Joint	S080749
	1992.08-1996.03	Front Axle Left & Right Lower	Saloon FWD XU10J2		Control Arm Bushing	510685
	1992.08-1996.03	Front Axle Left & Right Lower	Saloon FWD XU10J2		Control Arm Bushing	510686
	1992.08-1996.03	Front Axle Left & Right	Saloon FWD XU10J2		Tie Rod Axle Joint	S030234
	1992.08-1996.03	Front Axle Left	Saloon FWD XU10J2		Tie Rod End	S070381
	1992.08-1996.03	Front Axle Right	Saloon FWD XU10J2		Tie Rod End	S070382
	1992.08-1996.03	Front Axle Left & Right	Saloon FWD XU10J2		Rod/Strut, stabiliser	S050385
	1992.08-1996.03	Front Axle	Saloon FWD XU10J2		Stabiliser Bushing	510698
	1992.08-1996.03	Front Axle	Saloon FWD XU10J2	Date from:1993.01,for vehicles with power steering	Steering Boot	540346
	1992.08-1996.03	Front Axle	Saloon FWD XU10J2		Steering Rack Bellow Kit	540256S
406						
2.0 (99 kw)	1997.02-2000.10	Front Axle Left Lower	Estate FWD EW10J4		Track Control Arm	S060287
	1997.02-2000.10	Front Axle Right Lower	Estate FWD EW10J4		Track Control Arm	S060288
	1997.02-2000.10	Front Axle Left & Right Lower	Estate FWD EW10J4		Ball Joint	S080044
	1997.02-2000.10	Front Axle Left & Right Lower	Estate FWD EW10J4		Control Arm Bushing	510687
	1997.02-2000.10	Front Axle Left & Right Lower	Estate FWD EW10J4		Control Arm Bushing	510688
	1997.02-2000.10	Front Axle Left & Right	Estate FWD EW10J4	For Vehicles Without Switchable Power Steering (City Mode)	Tie Rod Axle Joint	S030027
	1997.02-2000.10	Front Axle Left & Right	Estate FWD EW10J4		Tie Rod Axle Joint	S030228
	1997.02-2000.10	Front Axle Left	Estate FWD EW10J4		Tie Rod End	S070378
	1997.02-2000.10	Front Axle Right	Estate FWD EW10J4		Tie Rod End	S070377
	1997.02-2000.10	Front Axle Left & Right	Estate FWD EW10J4	Org. No.from:07665	Rod/Strut, stabiliser	S050107
	1997.02-2000.10	Front Axle Left & Right	Estate FWD EW10J4	Org. No.to:07664	Rod/Strut, stabiliser	S100043
	1997.02-2000.10	Rear Axle Left & Right	Estate FWD EW10J4		Rod/Strut, stabiliser	S050384
	1997.02-2000.10	Rear Axle Left & Right	Estate FWD EW10J4		Rod/Strut, stabiliser	S100086
	1997.02-2000.10	Rear Axle	Estate FWD EW10J4		Stabiliser Bushing	512389
	1997.02-2000.10	Front Axle Left	Estate FWD EW10J4	for left-hand drive vehicles, for vehicles without servobreak steering	Steering Rack Bellow Kit	541029S
	1997.02-2000.10	Front Axle Right	Estate FWD EW10J4		Steering Rack Bellow Kit	540256S
2.0 (100 kw)	1999.04-2004.05	Front Axle Left Lower	Saloon FWD EW10J4		Track Control Arm	S060287
	1999.04-2004.05	Front Axle Right Lower	Saloon FWD EW10J4		Track Control Arm	S060288
	1999.04-2004.05	Front Axle Left & Right Lower	Saloon FWD EW10J4		Ball Joint	S080044
	1999.04-2004.05	Front Axle Left & Right Lower	Saloon FWD EW10J4		Control Arm Bushing	510687
	1999.04-2004.05	Front Axle Left & Right Lower	Saloon FWD EW10J4		Control Arm Bushing	510688
	1999.04-2004.05	Front Axle Left & Right	Saloon FWD EW10J4	For Vehicles Without Switchable Power Steering (City Mode)	Tie Rod Axle Joint	S030027
	1999.04-2004.05	Front Axle Left & Right	Saloon FWD EW10J4		Tie Rod Axle Joint	S030228

	 YEAR	FITTING POSITION	BODY STYLE & DRIVE TYPE & ENGINE	REMARKS	PRODUCT	GSP Ref.	
PEUGEOT 406							
2.0 (100 kw)	1999.04-2004.05	Front Axle Left	Saloon FWD EW10J4		Tie Rod End	S070378	
	1999.04-2004.05	Front Axle Right	Saloon FWD EW10J4		Tie Rod End	S070377	
	1999.04-2004.05	Front Axle Left & Right	Saloon FWD EW10J4	Org. No.from:07665	Rod/Strut,stabiliser	S050107	
	1999.04-2004.05	Front Axle Left & Right	Saloon FWD EW10J4		Rod/Strut,stabiliser	S051229	
	1999.04-2004.05	Front Axle Left & Right	Saloon FWD EW10J4	Org. No.to:07664	Rod/Strut,stabiliser	S100043	
	1999.04-2004.05	Rear Axle Left & Right	Saloon FWD EW10J4		Rod/Strut,stabiliser	S050384	
	1999.04-2004.05	Rear Axle Left & Right	Saloon FWD EW10J4		Rod/Strut,stabiliser	S100086	
	1999.04-2004.05	Rear Axle	Saloon FWD EW10J4		Stabiliser Bushing	512389	
	1999.04-2004.05	Front Axle Left	Saloon FWD EW10J4	for left-hand drive vehicles, for vehicles without servobronic steering	Steering Rack Bellow Kit	541029S	
	1999.04-2004.05	Front Axle Right	Saloon FWD EW10J4		Steering Rack Bellow Kit	540256S	
	3.0 (140 kw)	1995.08-2004.05	Front Axle Left Lower	Saloon FWD ES9J4		Track Control Arm	S060287
		1995.08-2004.05	Front Axle Right Lower	Saloon FWD ES9J4		Track Control Arm	S060288
		1995.08-2004.05	Front Axle Left & Right Lower	Saloon FWD ES9J4		Ball Joint	S080044
		1995.08-2004.05	Front Axle Left & Right Lower	Saloon FWD ES9J4		Control Arm Bushing	510687
		1995.08-2004.05	Front Axle Left & Right Lower	Saloon FWD ES9J4		Control Arm Bushing	510688
		1995.08-2004.05	Front Axle Left & Right	Saloon FWD ES9J4	For Vehicles Without Switchable Power Steering (City Mode)	Tie Rod Axle Joint	S030027
		1995.08-2004.05	Front Axle Left & Right	Saloon FWD ES9J4		Tie Rod Axle Joint	S030228
		1995.08-2004.05	Front Axle Left	Saloon FWD ES9J4		Tie Rod End	S070378
		1995.08-2004.05	Front Axle Right	Saloon FWD ES9J4		Tie Rod End	S070377
1995.08-2004.05		Front Axle Left & Right	Saloon FWD ES9J4	Org. No.from:07665	Rod/Strut,stabiliser	S050107	
1995.08-2004.05		Front Axle Left & Right	Saloon FWD ES9J4		Rod/Strut,stabiliser	S051229	
1995.08-2004.05		Front Axle Left & Right	Saloon FWD ES9J4	Org. No.to:07664	Rod/Strut,stabiliser	S100043	
1995.08-2004.05		Rear Axle Left & Right	Saloon FWD ES9J4		Rod/Strut,stabiliser	S050384	
1995.08-2004.05		Rear Axle Left & Right	Saloon FWD ES9J4		Rod/Strut,stabiliser	S100086	
1995.08-2004.05		Rear Axle	Saloon FWD ES9J4		Stabiliser Bushing	512389	
1995.08-2004.05		Front Axle Left	Saloon FWD ES9J4	for left-hand drive vehicles, for vehicles without servobronic steering	Steering Rack Bellow Kit	541029S	
1995.08-2004.05		Front Axle Right	Saloon FWD ES9J4		Steering Rack Bellow Kit	540256S	
406 Coupe							
3.0 (140 kw)		1997.03-2005.02	Front Axle Left Lower	Coupe FWD ES9J4		Track Control Arm	S060287
	1997.03-2005.02	Front Axle Right Lower	Coupe FWD ES9J4		Track Control Arm	S060288	
	1997.03-2005.02	Front Axle Left & Right Lower	Coupe FWD ES9J4		Ball Joint	S080044	
	1997.03-2005.02	Front Axle Left & Right Lower	Coupe FWD ES9J4		Control Arm Bushing	510687	
	1997.03-2005.02	Front Axle Left & Right Lower	Coupe FWD ES9J4		Control Arm Bushing	510688	
	1997.03-2005.02	Front Axle Left & Right	Coupe FWD ES9J4	For Vehicles Without Switchable Power Steering (City Mode)	Tie Rod Axle Joint	S030027	
	1997.03-2005.02	Front Axle Left & Right	Coupe FWD ES9J4	for vehicles with servobronic steering/for vehicles without servobronic steering	Tie Rod Axle Joint	S030228	
	1997.03-2005.02	Front Axle Left	Coupe FWD ES9J4		Tie Rod End	S070378	
	1997.03-2005.02	Front Axle Right	Coupe FWD ES9J4		Tie Rod End	S070377	
	1997.03-2005.02	Front Axle Left & Right	Coupe FWD ES9J4	Org. No.from:07665	Rod/Strut,stabiliser	S050107	
	1997.03-2005.02	Front Axle Left & Right	Coupe FWD ES9J4	Org. No.to:07664	Rod/Strut,stabiliser	S100043	
	1997.03-2005.02	Rear Axle Left & Right	Coupe FWD ES9J4		Rod/Strut,stabiliser	S050384	
	1997.03-2005.02	Rear Axle Left & Right	Coupe FWD ES9J4		Rod/Strut,stabiliser	S100086	
	1997.03-2005.02	Front Axle Left	Coupe FWD ES9J4	for left-hand drive vehicles, for vehicles without servobronic steering	Steering Rack Bellow Kit	541029S	
	1997.03-2005.02	Front Axle Right	Coupe FWD ES9J4		Steering Rack Bellow Kit	540256S	
	407						
	2.0 (100 kw)	2004.03-2005.07	Rear Axle Left & Right Lower Inner	Saloon FWD EW10J4		Track Control Arm	S062950
2004.03-2005.07		Rear Axle Left & Right Lower Outer	Saloon FWD EW10J4		Track Control Arm	S062954	
2004.03-2005.07		Front Axle Left & Right Lower	Saloon FWD EW10J4		Ball Joint	S080042	
2004.03-2005.07		Front Axle Left & Right Upper	Saloon FWD EW10J4		Ball Joint	S080043	
2004.03-2005.07		Front Axle Left & Right Lower	Saloon FWD EW10J4	for RPO No. (vehicle manufacturing date) up to: 11801	Control Arm Bushing	510724	
2004.03-2005.07		Front Axle Left & Right Lower	Saloon FWD EW10J4	for vehicles without height-adjustable suspension/for vehicles with height-adjustable suspension	Control Arm Bushing	517484	
2004.03-2005.07		Rear Axle Left & Right Upper	Saloon FWD EW10J4		Control Arm Bushing	532978	
2004.03-2005.07		Front Axle Left & Right	Saloon FWD EW10J4		Tie Rod Axle Joint	S030029	
2004.03-2005.07		Front Axle Left	Saloon FWD EW10J4	Org.No.to:10597	Tie Rod End	S070102	
2004.03-2005.07		Front Axle Left	Saloon FWD EW10J4	Org.No.from:10598	Tie Rod End	S070594	
2004.03-2005.07		Front Axle Right	Saloon FWD EW10J4	Org.No.to:10597	Tie Rod End	S070101	
2004.03-2005.07		Front Axle Right	Saloon FWD EW10J4	Org.No.from:10598	Tie Rod End	S070595	
2004.03-2005.07		Front Axle Left	Saloon FWD EW10J4		Rod/Strut,stabiliser	S050112	
2004.03-2005.07		Front Axle Right	Saloon FWD EW10J4		Rod/Strut,stabiliser	S050113	
2004.03-2005.07		Rear Axle Left & Right	Saloon FWD EW10J4		Rod/Strut,stabiliser	S050114	
2.0 (103 kw)		2005.08-2010.12	Rear Axle Left & Right Lower Inner	Saloon FWD EW10A		Track Control Arm	S062950
		2005.08-2010.12	Rear Axle Left & Right Lower Outer	Saloon FWD EW10A		Track Control Arm	S062954
		2005.08-2010.12	Front Axle Left & Right Lower	Saloon FWD EW10A		Ball Joint	S080042
		2005.08-2010.12	Front Axle Left & Right Upper	Saloon FWD EW10A		Ball Joint	S080043
	2005.08-2010.12	Front Axle Left & Right Lower	Saloon FWD EW10A	for RPO No. (vehicle manufacturing date) up to: 11801	Control Arm Bushing	510724	



	 YEAR	FITTING POSITION	BODY STYLE & DRIVE TYPE & ENGINE	REMARKS	PRODUCT	GSP Ref.	
PEUGEOT 407							
2.0 (103 kw)	2005.08-2010.12	Front Axle Left & Right Lower	Saloon FWD EW10A	<small>Date to:2007.01 for RPO No (vehicle manufacturing date) until 11039</small>	Control Arm Bushing	517484	
	2005.08-2010.12	Rear Axle Left & Right Upper	Saloon FWD EW10A		Control Arm Bushing	532978	
	2005.08-2010.12	Front Axle Left & Right	Saloon FWD EW10A		Tie Rod Axle Joint	S030029	
	2005.08-2010.12	Front Axle Left	Saloon FWD EW10A	Org.No.to:10597	Tie Rod End	S070102	
	2005.08-2010.12	Front Axle Left	Saloon FWD EW10A	Org.No.from:10598	Tie Rod End	S070594	
	2005.08-2010.12	Front Axle Right	Saloon FWD EW10A	Org.No.to:10597	Tie Rod End	S070101	
	2005.08-2010.12	Front Axle Right	Saloon FWD EW10A	Org.No.from:10598	Tie Rod End	S070595	
	2005.08-2010.12	Front Axle Left	Saloon FWD EW10A		Rod/Strut,stabiliser	S050112	
	2005.08-2010.12	Front Axle Right	Saloon FWD EW10A		Rod/Strut,stabiliser	S050113	
	2005.08-2010.12	Rear Axle Left & Right	Saloon FWD EW10A		Rod/Strut,stabiliser	S050114	
	3.0 (155 kw)	2004.03-2010.12	Rear Axle Left & Right Lower Inner	Saloon FWD ES9A		Track Control Arm	S062950
		2004.03-2010.12	Rear Axle Left & Right Lower Outer	Saloon FWD ES9A		Track Control Arm	S062954
		2004.03-2010.12	Front Axle Left & Right Lower	Saloon FWD ES9A		Ball Joint	S080042
		2004.03-2010.12	Front Axle Left & Right Upper	Saloon FWD ES9A		Ball Joint	S080043
2004.03-2010.12		Front Axle Left & Right Lower	Saloon FWD ES9A	<small>for RPO No (vehicle manufacturing date) until 11801</small>	Control Arm Bushing	510724	
2004.03-2010.12		Front Axle Left & Right Lower	Saloon FWD ES9A	<small>Date to:2007.01 for RPO No (vehicle manufacturing date) until 11039</small>	Control Arm Bushing	517484	
2004.03-2010.12		Rear Axle Left & Right Upper	Saloon FWD ES9A		Control Arm Bushing	532978	
2004.03-2010.12		Front Axle Left & Right	Saloon FWD ES9A		Tie Rod Axle Joint	S030029	
2004.03-2010.12		Front Axle Left	Saloon FWD ES9A	Org.No.to:10597	Tie Rod End	S070102	
2004.03-2010.12		Front Axle Left	Saloon FWD ES9A	Org.No.from:10598	Tie Rod End	S070594	
2004.03-2010.12		Front Axle Right	Saloon FWD ES9A	Org.No.to:10597	Tie Rod End	S070101	
2004.03-2010.12		Front Axle Right	Saloon FWD ES9A	Org.No.from:10598	Tie Rod End	S070595	
2004.03-2010.12		Front Axle Left	Saloon FWD ES9A		Rod/Strut,stabiliser	S050112	
2004.03-2010.12		Front Axle Right	Saloon FWD ES9A		Rod/Strut,stabiliser	S050113	
2004.03-2010.12	Rear Axle Left & Right	Saloon FWD ES9A		Rod/Strut,stabiliser	S050114		
407 SW							
2.0 (100 kw)	2004.08-2005.07	Rear Axle Left & Right Lower Inner	Estate FWD EW10J4		Track Control Arm	S062950	
	2004.08-2005.07	Rear Axle Left & Right Lower Outer	Estate FWD EW10J4		Track Control Arm	S062954	
	2004.08-2005.07	Front Axle Left & Right Lower	Estate FWD EW10J4		Ball Joint	S080042	
	2004.08-2005.07	Front Axle Left & Right Upper	Estate FWD EW10J4		Ball Joint	S080043	
	2004.08-2005.07	Front Axle Left & Right Lower	Estate FWD EW10J4	<small>for RPO No (vehicle manufacturing date) until 11801</small>	Control Arm Bushing	510724	
	2004.08-2005.07	Front Axle Left & Right Lower	Estate FWD EW10J4	Date from:2004.08	Control Arm Bushing	517484	
	2004.08-2005.07	Rear Axle Left & Right Upper	Estate FWD EW10J4		Control Arm Bushing	532978	
	2004.08-2005.07	Front Axle Left & Right	Estate FWD EW10J4		Tie Rod Axle Joint	S030029	
	2004.08-2005.07	Front Axle Left	Estate FWD EW10J4	Org.No.to:10597	Tie Rod End	S070102	
	2004.08-2005.07	Front Axle Left	Estate FWD EW10J4	Org.No.from:10598	Tie Rod End	S070594	
	2004.08-2005.07	Front Axle Right	Estate FWD EW10J4	Org.No.to:10597	Tie Rod End	S070101	
	2004.08-2005.07	Front Axle Right	Estate FWD EW10J4	Org.No.from:10598	Tie Rod End	S070595	
	2004.08-2005.07	Front Axle Left	Estate FWD EW10J4		Rod/Strut,stabiliser	S050112	
	2004.08-2005.07	Front Axle Right	Estate FWD EW10J4		Rod/Strut,stabiliser	S050113	
	2004.08-2005.07	Rear Axle Left & Right	Estate FWD EW10J4		Rod/Strut,stabiliser	S050114	
	2.0 (103 kw)	2005.08-2010.12	Rear Axle Left & Right Lower Inner	Estate FWD EW10A		Track Control Arm	S062950
		2005.08-2010.12	Rear Axle Left & Right Lower Outer	Estate FWD EW10A		Track Control Arm	S062954
		2005.08-2010.12	Front Axle Left & Right Lower	Estate FWD EW10A	Date from:2007.01	Ball Joint	S080042
		2005.08-2010.12	Front Axle Left & Right Upper	Estate FWD EW10A		Ball Joint	S080043
2005.08-2010.12		Front Axle Left & Right Lower	Estate FWD EW10A	<small>for RPO No (vehicle manufacturing date) until 11801</small>	Control Arm Bushing	510724	
2005.08-2010.12		Front Axle Left & Right Lower	Estate FWD EW10A	<small>Date to:2007.01 for RPO No (vehicle manufacturing date) until 11039</small>	Control Arm Bushing	517484	
2005.08-2010.12		Rear Axle Left & Right Upper	Estate FWD EW10A		Control Arm Bushing	532978	
2005.08-2010.12		Front Axle Left & Right	Estate FWD EW10A		Tie Rod Axle Joint	S030029	
2005.08-2010.12		Front Axle Left	Estate FWD EW10A		Tie Rod End	S070102	
2005.08-2010.12		Front Axle Left	Estate FWD EW10A	Org.No.to:10597	Tie Rod End	S070102	
2005.08-2010.12		Front Axle Left	Estate FWD EW10A	Date from:2005.11	Tie Rod End	S070594	
2005.08-2010.12		Front Axle Left	Estate FWD EW10A	Org.No.from:10598	Tie Rod End	S070594	
2005.08-2010.12		Front Axle Right	Estate FWD EW10A		Tie Rod End	S070101	
2005.08-2010.12		Front Axle Right	Estate FWD EW10A	Org.No.to:10597	Tie Rod End	S070101	
2005.08-2010.12		Front Axle Right	Estate FWD EW10A	Date from:2005.11	Tie Rod End	S070595	
2005.08-2010.12		Front Axle Right	Estate FWD EW10A	Org.No.from:10598	Tie Rod End	S070595	
2005.08-2010.12		Front Axle Left	Estate FWD EW10A		Rod/Strut,stabiliser	S050112	
2005.08-2010.12		Front Axle Right	Estate FWD EW10A		Rod/Strut,stabiliser	S050113	
2005.08-2010.12		Rear Axle Left & Right	Estate FWD EW10A		Rod/Strut,stabiliser	S050114	
3.0 (155 kw)	2004.08-2010.12	Rear Axle Left & Right Lower Inner	Estate FWD ES9A		Track Control Arm	S062950	
	2004.08-2010.12	Rear Axle Left & Right Lower Outer	Estate FWD ES9A		Track Control Arm	S062954	
	2004.08-2010.12	Front Axle Left & Right Lower	Estate FWD ES9A		Ball Joint	S080042	
	2004.08-2010.12	Front Axle Left & Right Upper	Estate FWD ES9A		Ball Joint	S080043	



	 YEAR	FITTING POSITION	BODY STYLE & DRIVE TYPE & ENGINE	REMARKS	PRODUCT	GSP Ref.
PEUGEOT						
407 SW						
3.0 (155 kw)	2004.08-2010.12	Front Axle Left & Right Lower	Estate FWD ES9A	<small>for RPD No.(vehicle manufacturing date)up until 11801</small>	Control Arm Bushing	510724
	2004.08-2010.12	Front Axle Left & Right Lower	Estate FWD ES9A	Date from:2004.08	Control Arm Bushing	517484
	2004.08-2010.12	Rear Axle Left & Right Upper	Estate FWD ES9A		Control Arm Bushing	532978
	2004.08-2010.12	Front Axle Left & Right	Estate FWD ES9A		Tie Rod Axle Joint	S030029
	2004.08-2010.12	Front Axle Left	Estate FWD ES9A	Org.No.to:10597	Tie Rod End	S070102
	2004.08-2010.12	Front Axle Left	Estate FWD ES9A	Org.No.from:10598	Tie Rod End	S070594
	2004.08-2010.12	Front Axle Right	Estate FWD ES9A	Org.No.to:10597	Tie Rod End	S070101
	2004.08-2010.12	Front Axle Right	Estate FWD ES9A	Org.No.from:10598	Tie Rod End	S070595
	2004.08-2010.12	Front Axle Left	Estate FWD ES9A		Rod/Strut,stabiliser	S050112
	2004.08-2010.12	Front Axle Right	Estate FWD ES9A		Rod/Strut,stabiliser	S050113
	2004.08-2010.12	Rear Axle Left & Right	Estate FWD ES9A		Rod/Strut,stabiliser	S050114
5008						
1.6 (121 kw)	2016.12-	Front Axle Left & Right Lower	MPV FWD EP6FDT/EP6FDTM		Ball Joint	S080988
	2016.12-	Front Axle Left & Right	MPV FWD EP6FDT/EP6FDTM		Tie Rod Axle Joint	S030709
	2016.12-	Front Axle Left	MPV FWD EP6FDT/EP6FDTM		Tie Rod End	S071654
	2016.12-	Front Axle Right	MPV FWD EP6FDT/EP6FDTM		Tie Rod End	S071639
	2016.12-	Front Axle Left & Right	MPV FWD EP6FDT/EP6FDTM		Rod/Strut,stabiliser	S050109
508						
1.6 (121 kw)	2011.09-2018.12	Rear Axle Left & Right Lower Inner	Saloon FWD EP6FDT		Track Control Arm	S062950
	2011.09-2018.12	Front Axle Left & Right Lower	Saloon FWD EP6FDT		Control Arm Bushing	517484
	2011.09-2018.12	Front Axle Left & Right Lower	Saloon FWD EP6FDT		Control Arm Bushing	533897
	2011.09-2018.12	Rear Axle Left & Right Upper	Saloon FWD EP6FDT		Control Arm Bushing	532978
	2011.09-2018.12	Front Axle Left & Right	Saloon FWD EP6FDT	Axle Vers.:VH10	Tie Rod Axle Joint	S030360
	2011.09-2018.12	Front Axle Left & Right	Saloon FWD EP6FDT		Tie Rod Axle Joint	S030955
	2011.09-2018.12	Front Axle Left	Saloon FWD EP6FDT		Tie Rod End	S071668
	2011.09-2018.12	Front Axle Right	Saloon FWD EP6FDT		Tie Rod End	S071669
	2011.09-2018.12	Front Axle Left & Right	Saloon FWD EP6FDT		Rod/Strut,stabiliser	S051257
	2011.09-2018.12	Rear Axle Left & Right	Saloon FWD EP6FDT		Rod/Strut,stabiliser	S050114
605						
2.0 (89 kw)	1989.06-1999.09	Front Axle Left & Right Lower	Saloon FWD XU10J2		Ball Joint	S080044
	1989.06-1999.09	Front Axle Left & Right Lower	Saloon FWD XU10J2		Control Arm Bushing	511909
	1989.06-1999.09	Front Axle Left & Right Lower	Saloon FWD XU10J2		Control Arm Bushing	512284
	1989.06-1999.09	Front Axle Left & Right	Saloon FWD XU10J2		Tie Rod Axle Joint	S030035
	1989.06-1999.09	Front Axle Left	Saloon FWD XU10J2		Tie Rod End	S070100
	1989.06-1999.09	Front Axle Left	Saloon FWD XU10J2	Date to:1994.07	Tie Rod End	S070105
	1989.06-1999.09	Front Axle Right	Saloon FWD XU10J2		Tie Rod End	S070099
	1989.06-1999.09	Front Axle Right	Saloon FWD XU10J2	Date to:1994.07	Tie Rod End	S070106
	1989.06-1999.09	Rear Axle Left	Saloon FWD XU10J2		Rod/Strut,stabiliser	S100090
	1989.06-1999.09	Rear Axle Right	Saloon FWD XU10J2		Rod/Strut,stabiliser	S100091
	1989.06-1999.09	Front Axle Left	Saloon FWD XU10J2		Steering Rack Bellow Kit	541029S
	1989.06-1999.09	Front Axle	Saloon FWD XU10J2		Steering Rack Bellow Kit	540256S
3.0 (123 kw)	1989.10-1999.09	Front Axle Left & Right Lower	Saloon FWD ZPJUKZ		Ball Joint	S080044
	1989.10-1999.09	Front Axle Left & Right Lower	Saloon FWD ZPJUKZ		Control Arm Bushing	511909
	1989.10-1999.09	Front Axle Left & Right Lower	Saloon FWD ZPJUKZ		Control Arm Bushing	512284
	1989.10-1999.09	Front Axle Left & Right	Saloon FWD ZPJUKZ	for vehicles with power steering	Tie Rod Axle Joint	S030035
	1989.10-1999.09	Front Axle Left & Right	Saloon FWD ZPJUKZ	Date to:1994.12,For Vehicles With Power Steering	Tie Rod Axle Joint	S030035
	1989.10-1999.09	Front Axle Left	Saloon FWD ZPJUKZ		Tie Rod End	S070100
	1989.10-1999.09	Front Axle Left	Saloon FWD ZPJUKZ		Tie Rod End	S070105
	1989.10-1999.09	Front Axle Left	Saloon FWD ZPJUKZ	Date to:1994.07	Tie Rod End	S070105
	1989.10-1999.09	Front Axle Right	Saloon FWD ZPJUKZ		Tie Rod End	S070099
	1989.10-1999.09	Front Axle Right	Saloon FWD ZPJUKZ		Tie Rod End	S070106
	1989.10-1999.09	Front Axle Right	Saloon FWD ZPJUKZ	Date to:1994.07	Tie Rod End	S070106
	1989.10-1999.09	Rear Axle Left	Saloon FWD ZPJUKZ		Rod/Strut,stabiliser	S100090
	1989.10-1999.09	Rear Axle Right	Saloon FWD ZPJUKZ		Rod/Strut,stabiliser	S100091
	1989.10-1999.09	Front Axle Left	Saloon FWD ZPJUKZ		Steering Rack Bellow Kit	541029S
607						
3.0 (152 kw)	1999.12-2004.07	Front Axle Left & Right Lower	Saloon FWD ES9J4S		Ball Joint	S080044
	1999.12-2004.07	Front Axle Left & Right Lower	Saloon FWD ES9J4S		Control Arm Bushing	511909
	1999.12-2004.07	Front Axle Left & Right Lower	Saloon FWD ES9J4S		Control Arm Bushing	512284
	1999.12-2004.07	Front Axle Left	Saloon FWD ES9J4S		Tie Rod End	S070100
	1999.12-2004.07	Front Axle Right	Saloon FWD ES9J4S		Tie Rod End	S070099
	1999.12-2004.07	Front Axle Left & Right	Saloon FWD ES9J4S		Rod/Strut,stabiliser	S050107
	1999.12-2004.07	Front Axle Left & Right	Saloon FWD ES9J4S		Rod/Strut,stabiliser	S051229
	1999.12-2004.07	Rear Axle Left	Saloon FWD ES9J4S		Rod/Strut,stabiliser	S100090



 YEAR	FITTING POSITION	BODY STYLE & DRIVE TYPE & ENGINE	REMARKS	PRODUCT	GSP Ref.
PEUGEOT 607					
3.0 (152 kw)	1999.12-2004.07	Rear Axle Right	Saloon FWD ES9J4S		Rod/Strut, stabiliser S100091
	1999.12-2004.07	Front Axle	Saloon FWD ES9J4S		Steering Boot 540205
	1999.12-2004.07	Front Axle	Saloon FWD ES9J4S		Steering Rack Bellow Kit 541149S
3.0 (155 kw)	2004.08-2011.07	Front Axle Left & Right Lower	Saloon FWD ES9A		Ball Joint S080044
	2004.08-2011.07	Front Axle Left & Right Lower	Saloon FWD ES9A		Control Arm Bushing 512284
	2004.08-2011.07	Front Axle Left	Saloon FWD ES9A		Tie Rod End S070100
	2004.08-2011.07	Front Axle Right	Saloon FWD ES9A		Tie Rod End S070099
	2004.08-2011.07	Front Axle Left & Right	Saloon FWD ES9A		Rod/Strut, stabiliser S050107
	2004.08-2011.07	Front Axle Left & Right	Saloon FWD ES9A		Rod/Strut, stabiliser S051229
	2004.08-2011.07	Rear Axle Left	Saloon FWD ES9A		Rod/Strut, stabiliser S100090
	2004.08-2011.07	Rear Axle Right	Saloon FWD ES9A		Rod/Strut, stabiliser S100091
	2004.08-2011.07	Front Axle	Saloon FWD ES9A		Steering Boot 540205
	2004.08-2011.07	Front Axle	Saloon FWD ES9A		Steering Rack Bellow Kit 541149S
806					
2.0 (108 kw)	1994.08-2000.05	Front Axle Left Lower	MPV FWD XU10J2TE		Track Control Arm S060143
	1994.08-2000.05	Front Axle Right Lower	MPV FWD XU10J2TE		Track Control Arm S060144
	1994.08-2000.05	Front Axle Left & Right	MPV FWD XU10J2TE		Tie Rod Axle Joint S030032
	1994.08-2000.05	Front Axle Left & Right	MPV FWD XU10J2TE		Tie Rod End S070103
	1994.08-2000.05	Front Axle Left & Right	MPV FWD XU10J2TE		Tie Rod End S070824
	1994.08-2000.05	Front Axle Left & Right	MPV FWD XU10J2TE		Tie Rod End S070866
	1994.08-2000.05	Front Axle Left & Right	MPV FWD XU10J2TE		Rod/Strut, stabiliser S050110
	1994.08-2000.05	Front Axle	MPV FWD XU10J2TE		Steering Boot 540443
1994.08-2000.05	Front Axle	MPV FWD XU10J2TE		Steering Rack Bellow Kit 540416S	
807					
2.0 (100 kw)	2002.08-2005.08	Front Axle Left Lower	MPV FWD EW10J4		Track Control Arm S060378
	2002.08-2005.08	Front Axle Right Lower	MPV FWD EW10J4		Track Control Arm S060379
	2002.08-2005.08	Front Axle Left & Right	MPV FWD EW10J4		Tie Rod Axle Joint S030020
	2002.08-2005.08	Front Axle Left & Right	MPV FWD EW10J4		Tie Rod Axle Joint S030024
	2002.08-2005.08	Front Axle Left & Right	MPV FWD EW10J4		Tie Rod End S070085
	2002.08-2005.08	Front Axle Left & Right	MPV FWD EW10J4		Rod/Strut, stabiliser S050099
	2002.08-2005.08	Front Axle	MPV FWD EW10J4		Steering Boot 540207
	2002.08-2005.08	Front Axle	MPV FWD EW10J4		Steering Rack Bellow Kit 540207S
Boxer					
2.0 (96 kw)	2016.03-2019.09	Front Axle Left Lower	VAN FWD DW10FUD		Track Control Arm S060135
	2016.03-2019.09	Front Axle Right Lower	VAN FWD DW10FUD		Track Control Arm S060136
	2016.03-2019.09	Front Axle Left & Right	VAN FWD DW10FUD		Tie Rod Axle Joint S030946
	2016.03-2019.09	Front Axle Left	VAN FWD DW10FUD		Tie Rod End S070090
	2016.03-2019.09	Front Axle Right	VAN FWD DW10FUD		Tie Rod End S070091
	2016.03-2019.09	Front Axle Left & Right	VAN FWD DW10FUD		Rod/Strut, stabiliser S050105
2.8 (64 kw)	1999.01-2002.09	Front Axle Left Lower	VAN FWD 814063		Track Control Arm S060383
	1999.01-2002.09	Front Axle Left Lower	VAN FWD 814063	Payload[kg]:1800	Track Control Arm S060385
	1999.01-2002.09	Front Axle Right Lower	VAN FWD 814063		Track Control Arm S060382
	1999.01-2002.09	Front Axle Right Lower	VAN FWD 814063	Payload[kg]:1800	Track Control Arm S060384
	1999.01-2002.09	Front Axle Left & Right Lower	VAN FWD 814063	Date from:2001.02	Ball Joint S080038
	1999.01-2002.09	Front Axle Left & Right Lower	VAN FWD 814063	Equipment Vari.:1.8 T	Ball Joint S080039
	1999.01-2002.09	Front Axle Left & Right Lower	VAN FWD 814063	Equipment Vari.:1.0-1.4 T	Ball Joint S081034
	1999.01-2002.09	Front Axle Left & Right Lower	VAN FWD 814063		Control Arm Bushing 510714
	1999.01-2002.09	Front Axle Left & Right	VAN FWD 814063		Tie Rod Axle Joint S030026
	1999.01-2002.09	Front Axle Left & Right	VAN FWD 814063		Tie Rod End S070098
	1999.01-2002.09	Front Axle Left & Right	VAN FWD 814063		Rod/Strut, stabiliser S050100
	1999.01-2002.09	Front Axle Right	VAN FWD 814063	Equipment Vari.: 4X4 DANGEL for vehicles with power steering	Steering Rack Bellow Kit 540189S
	1999.01-2002.09	Front Axle	VAN FWD 814063	for vehicles with power steering	Steering Rack Bellow Kit 540194S
Partner					
1.6 (80 kw)	2000.09-2002.10	Front Axle Left Lower	MPV Van FWD TU5JP4	Org.No.to:7973	Track Control Arm S060372
	2000.09-2002.10	Front Axle Left Lower	MPV FWD TU5JP4	Org.No.to:7973	Track Control Arm S060372
	2000.09-2002.10	Front Axle Left Lower	MPV Van FWD TU5JP4		Track Control Arm S060372B
	2000.09-2002.10	Front Axle Left Lower	MPV FWD TU5JP4	for vehicles with heavy duty suspension	Track Control Arm S060376
	2000.09-2002.10	Front Axle Left Lower	MPV Van FWD TU5JP4	D4:18 mm	Track Control Arm S063016
	2000.09-2002.10	Front Axle Left Lower	MPV FWD TU5JP4	D4:18 mm	Track Control Arm S063016
	2000.09-2002.10	Front Axle Right Lower	MPV Van FWD TU5JP4		Track Control Arm S060373
	2000.09-2002.10	Front Axle Right Lower	MPV FWD TU5JP4		Track Control Arm S060373
	2000.09-2002.10	Front Axle Right Lower	MPV FWD TU5JP4		Track Control Arm S060373B
	2000.09-2002.10	Front Axle Right Lower	MPV FWD TU5JP4	for vehicles with heavy duty suspension	Track Control Arm S060377
	2000.09-2002.10	Front Axle Right Lower	MPV Van FWD TU5JP4	D4:18 mm	Track Control Arm S063017



	 YEAR	FITTING POSITION	BODY STYLE & DRIVE TYPE & ENGINE	REMARKS	PRODUCT	GSP Ref.
PEUGEOT						
Partner						
1.6 (80 kw)	2000.09-2002.10	Front Axle Right Lower	MPV FWD TU5JP4	D4:18 mm	Track Control Arm	S063017
	2000.09-2002.10	Front Axle Left & Right Lower	MPV FWD TU5JP4	<small>Org.No.from:07973,for vehicles with standard suspension</small>	Ball Joint	S080031
	2000.09-2002.10	Front Axle Left & Right Lower	MPV FWD TU5JP4	<small>Org.No.to:07972,for vehicles with standard suspension</small>	Ball Joint	S080033
	2000.09-2002.10	Front Axle Left & Right Lower	MPV FWD TU5JP4		Control Arm Bushing	510689
	2000.09-2002.10	Front Axle Left & Right Lower	MPV FWD TU5JP4		Control Arm Bushing	510690
	2000.09-2002.10	Front Axle Left & Right Lower	MPV FWD TU5JP4		Control Arm Bushing	511908
	2000.09-2002.10	Front Axle Left & Right	MPV FWD TU5JP4		Tie Rod Axle Joint	S030021
	2000.09-2002.10	Front Axle Left & Right	MPV FWD TU5JP4		Tie Rod End	S070104
	2000.09-2002.10	Front Axle Left & Right	MPV FWD TU5JP4		Rod/Strut,stabiliser	S050115
	2000.09-2002.10	Front Axle	MPV FWD TU5JP4		Stabiliser Bushing	512500
	2000.09-2002.10	Front Axle	MPV FWD TU5JP4		Steering Boot	540061
	2000.09-2002.10	Front Axle	MPV FWD TU5JP4		Steering Boot	540332
	2000.09-2002.10	Front Axle	MPV FWD TU5JP4		Steering Boot	540414
	2000.09-2002.10	Front Axle Left	MPV FWD TU5JP4	<small>for vehicles without power steering</small>	Steering Rack Bellow Kit	540061S
1.8 (66 kw)	1997.03-2003.12	Front Axle Left Lower	MPV Van FWD XU7JB	Org.No.to:7973	Track Control Arm	S060372
	1997.03-2003.12	Front Axle Left Lower	MPV Van FWD XU7JB		Track Control Arm	S060372B
	1997.03-2003.12	Front Axle Left Lower	MPV Van FWD XU7JB	<small>for vehicles with heavy duty suspension</small>	Track Control Arm	S060376
	1997.03-2003.12	Front Axle Left Lower	MPV Van FWD XU7JB	D4:18 mm	Track Control Arm	S063016
	1997.03-2003.12	Front Axle Right Lower	MPV Van FWD XU7JB		Track Control Arm	S060373
	1997.03-2003.12	Front Axle Right Lower	MPV Van FWD XU7JB	<small>for vehicles with heavy duty suspension</small>	Track Control Arm	S060377
	1997.03-2003.12	Front Axle Right Lower	MPV Van FWD XU7JB	D4:18 mm	Track Control Arm	S063017
	1997.03-2003.12	Front Axle Left & Right Lower	MPV Van FWD XU7JB	<small>Org.No.from:07973,for vehicles with standard suspension</small>	Ball Joint	S080031
	1997.03-2003.12	Front Axle Left & Right Lower	MPV Van FWD XU7JB	<small>Org.No.to:07972,for vehicles with standard suspension</small>	Ball Joint	S080033
	1997.03-2003.12	Front Axle Left & Right Lower	MPV Van FWD XU7JB		Control Arm Bushing	510689
	1997.03-2003.12	Front Axle Left & Right Lower	MPV Van FWD XU7JB		Control Arm Bushing	510690
	1997.03-2003.12	Front Axle Left & Right Lower	MPV Van FWD XU7JB		Control Arm Bushing	511908
	1997.03-2003.12	Front Axle Left & Right	MPV Van FWD XU7JB		Tie Rod Axle Joint	S030021
	1997.03-2003.12	Front Axle Left & Right	MPV Van FWD XU7JB		Tie Rod End	S070104
	1997.03-2003.12	Front Axle Left & Right	MPV Van FWD XU7JB		Rod/Strut,stabiliser	S050115
	1997.03-2003.12	Front Axle	MPV Van FWD XU7JB		Stabiliser Bushing	512500
	1997.03-2003.12	Front Axle	MPV Van FWD XU7JB		Steering Boot	540061
	1997.03-2003.12	Front Axle	MPV Van FWD XU7JB		Steering Boot	540332
	1997.03-2003.12	Front Axle	MPV Van FWD XU7JB		Steering Boot	540414
	1997.03-2003.12	Front Axle Left	MPV Van FWD XU7JB	<small>for vehicles without power steering</small>	Steering Rack Bellow Kit	540061S
PORSCHE						
718 Boxster						
2.0 (220 kw)	2016.04-	Front Axle Left & Right	Cabriolet RWD MDDPB		Tie Rod End	S070383
2.5 (257 kw)	2016.04-	Front Axle Left & Right	Cabriolet RWD MDDNC		Tie Rod End	S070383
2.5 (269 kw)	2017.10-	Front Axle Left & Right	Cabriolet RWD MDJUA/MDJUB		Tie Rod End	S070383
718 Cayman						
2.0 (220 kw)	2016.04-	Front Axle Left & Right	Coupe RWD MDDPB		Tie Rod End	S070383
2.5 (257 kw)	2016.04-	Front Axle Left & Right	Coupe RWD MDDNC		Tie Rod End	S070383
2.5 (269 kw)	2017.10-	Front Axle Left & Right	Coupe RWD MDJUA/MDJUB		Tie Rod End	S070383
911						
3.0 (272 kw)	2015.11-	Front Axle Left & Right	Coupe RWD DCKA/MDCKA		Tie Rod End	S070383
	2015.11-2019.12	Front Axle Left & Right	Cabriolet RWD DCKA/MDCKA		Tie Rod End	S070383
	2015.11-2019.12	Front Axle Left & Right	Cabriolet 4WD DCKA/MDCKA		Tie Rod End	S070383
	2015.11-2019.12	Front Axle Left & Right	Coupe 4WD DCKA/MDCKA		Tie Rod End	S070383
	2015.11-2019.12	Front Axle Left & Right	Targa 4WD DCKA/MDCKA		Tie Rod End	S070383
3.0 (309 kw)	2015.11-2019.12	Front Axle Left & Right	Cabriolet RWD DCHA/MDCHA		Tie Rod End	S070383
	2015.11-2019.12	Front Axle Left & Right	Coupe 4WD DCHA/MDCHA		Tie Rod End	S070383
	2015.11-2019.12	Front Axle Left & Right	Cabriolet 4WD DCHA/MDCHA		Tie Rod End	S070383
	2015.11-2019.12	Front Axle Left & Right	Coupe RWD DCHA/MDCHA		Tie Rod End	S070383
	2015.11-2019.12	Front Axle Left & Right	Targa 4WD DCHA/MDCHA		Tie Rod End	S070383
3.0 (331 kw)	2016.04-2019.12	Front Axle Left & Right	Coupe RWD MDCHA/MDCJA		Tie Rod End	S070383
	2016.04-2019.12	Front Axle Left & Right	Targa 4WD MDCHA/MDCJA		Tie Rod End	S070383
	2016.04-2019.12	Front Axle Left & Right	Cabriolet RWD MDCHA/MDCJA		Tie Rod End	S070383
	2016.04-2019.12	Front Axle Left & Right	Coupe 4WD MDCHA/MDCJA		Tie Rod End	S070383
	2016.04-2019.12	Front Axle Left & Right	Cabriolet 4WD MDCHA/MDCJA		Tie Rod End	S070383
3.4 (257 kw)	2011.12-2019.12	Front Axle Left & Right	Coupe RWD MA104/MAB04		Tie Rod End	S070383
	2011.12-2019.12	Front Axle Left & Right	Cabriolet RWD MA104/MAB04		Tie Rod End	S070383
	2012.10-2019.12	Front Axle Left & Right	Coupe 4WD MA104		Tie Rod End	S070383
3.6 (254 kw)	2008.09-2012.09	Front Axle Left & Right Lower	Coupe RWD MA102		Track Control Arm	S063043
	2008.09-2012.09	Rear Axle Left & Right Lower Inner	Coupe RWD MA102		Track Control Arm	S061358



	 YEAR	FITTING POSITION	BODY STYLE & DRIVE TYPE & ENGINE	REMARKS	PRODUCT	GSP Ref.
PORSCHE						
911						
3.6 (254 kw)	2008.09-2012.09	Front Axle Left & Right	Coupe RWD MA102		Tie Rod End	S070383
3.8 (261 kw)	2004.08-2008.12	Front Axle Left & Right Lower	Coupe RWD M9701		Track Control Arm	S063043
	2004.08-2008.12	Rear Axle Left & Right Lower Inner	Coupe RWD M9701		Track Control Arm	S061358
	2004.08-2008.12	Front Axle Left & Right	Coupe RWD M9701		Tie Rod End	S070383
	2005.04-2008.12	Front Axle Left & Right Lower	Cabriolet RWD M9701		Track Control Arm	S063043
	2005.04-2008.12	Rear Axle Left & Right Lower Inner	Cabriolet RWD M9701		Track Control Arm	S061358
	2005.04-2008.12	Front Axle Left & Right	Cabriolet RWD M9701		Tie Rod End	S070383
3.8 (283 kw)	2008.06-2012.09	Front Axle Left & Right Lower	Cabriolet 4WD MA101		Track Control Arm	S063043
	2008.06-2012.09	Front Axle Left & Right	Cabriolet 4WD MA101		Tie Rod End	S070383
	2008.09-2012.09	Front Axle Left & Right Lower	Cabriolet RWD MA101		Track Control Arm	S063043
	2008.09-2012.09	Front Axle Left & Right	Cabriolet RWD MA101		Tie Rod End	S070383
3.8 (294 kw)	2011.12-2019.12	Front Axle Left & Right	Coupe RWD MA103/MAB03		Tie Rod End	S070383
	2011.12-2019.12	Front Axle Left & Right	Cabriolet RWD MA103/MAB03		Tie Rod End	S070383
	2012.10-2019.12	Front Axle Left & Right	Coupe 4WD MA103		Tie Rod End	S070383
911 GT2						
3.8 (515 kw)	2017.06-2020.05	Front Axle Left & Right	Coupe RWD MDHNA		Tie Rod End	S070383
911 GT3						
3.6 (265 kw)	1999.06-2002.07	Rear Axle Left & Right Lower Inner	Coupe RWD M9676		Track Control Arm	S061358
	1999.06-2002.07	Front Axle Left & Right	Coupe RWD M9676		Tie Rod End	S070383
3.6 (280 kw)	2003.10-2005.09	Rear Axle Left & Right Lower Inner	Coupe RWD M9679		Track Control Arm	S061358
	2003.10-2005.09	Front Axle Left & Right	Coupe RWD M9679		Tie Rod End	S070383
3.8 (350 kw)	2013.03-2017.05	Front Axle Left & Right	Coupe RWD MA175		Tie Rod End	S070383
4.0 (368 kw)	2015.04-	Front Axle Left & Right	Coupe RWD MA176/MDGGA		Tie Rod End	S070383
911 R						
4.0 (368 kw)	2016.03-	Front Axle Left & Right	Coupe RWD MA176		Tie Rod End	S070383
911 Turbo						
3.8 (397 kw)	2015.12-2020.05	Front Axle Left & Right	Cabriolet 4WD MDABA		Tie Rod End	S070383
	2015.12-2020.05	Front Axle Left & Right	Coupe 4WD MDABA		Tie Rod End	S070383
3.8 (426 kw)	2016.01-2020.05	Front Axle Left & Right	Coupe 4WD MDBCA		Tie Rod End	S070383
	2016.01-2020.05	Front Axle Left & Right	Cabriolet 4WD MDBCA		Tie Rod End	S070383
968						
3.0 (176 kw)	1991.06-1995.11	Front Axle	Coupe RWD M4443/M4444		Steering Boot	540016
Boxster						
2.7 (195 kw)	2012.04-	Front Axle Left & Right	Cabriolet RWD MA122		Tie Rod End	S070383
2.9 (188 kw)	2009.02-2012.03	Front Axle Left & Right Lower	Cabriolet RWD MA120		Track Control Arm	S063043
	2009.02-2012.03	Rear Axle Left & Right Lower Inner	Cabriolet RWD MA120		Track Control Arm	S061358
	2009.02-2012.03	Front Axle Left & Right	Cabriolet RWD MA120		Tie Rod End	S070383
3.2 (185 kw)	1999.08-2004.07	Rear Axle Left & Right Lower Inner	Cabriolet RWD M9621		Track Control Arm	S061358
	1999.08-2004.07	Front Axle Left & Right	Cabriolet RWD M9621		Tie Rod End	S070383
3.4 (228 kw)	2009.02-2012.03	Front Axle Left & Right Lower	Cabriolet RWD MA121		Track Control Arm	S063043
	2009.02-2012.03	Rear Axle Left & Right Lower Inner	Cabriolet RWD MA121		Track Control Arm	S061358
	2009.02-2012.03	Front Axle Left & Right	Cabriolet RWD MA121		Tie Rod End	S070383
3.4 (243 kw)	2014.02-	Front Axle Left & Right	Cabriolet RWD MA123		Tie Rod End	S070383
Cayenne						
2.9 (324 kw)	2017.05-	Front Axle Left & Right	SUV 4WD DCAB/MDCAB		Tie Rod End	S071841
	2017.05-	Front Axle Left & Right	SUV 4WD DCAB/MDCAB		Rod/Strut, stabiliser	S051258
	2017.05-	Rear Axle Left & Right	SUV 4WD DCAB/MDCAB		Rod/Strut, stabiliser	S051432
3.0 (245 kw)	2010.06-	Front Axle Left Lower	SUV AWD M 06.EC/MCG.E/MCG.EA/MCG.FA		Track Control Arm	S060043
	2010.06-	Front Axle Right Lower	SUV AWD M 06.EC/MCG.E/MCG.EA/MCG.FA		Track Control Arm	S060044
	2010.06-	Rear Axle Left Upper Outer	SUV AWD M 06.EC/MCG.E/MCG.EA/MCG.FA		Track Control Arm	S060045
	2010.06-	Rear Axle Right Upper Outer	SUV AWD M 06.EC/MCG.E/MCG.EA/MCG.FA		Track Control Arm	S060024
	2010.06-	Rear Axle Left & Right Upper Inner	SUV AWD M 06.EC/MCG.E/MCG.EA/MCG.FA		Track Control Arm	S060808
	2010.06-	Front Axle Left & Right Lower	SUV AWD M 06.EC/MCG.E/MCG.EA/MCG.FA		Control Arm Bushing	516054
	2010.06-	Front Axle Left & Right Lower	SUV AWD M 06.EC/MCG.E/MCG.EA/MCG.FA		Control Arm Bushing	517469
	2010.06-	Front Axle Left & Right Upper	SUV AWD M 06.EC/MCG.E/MCG.EA/MCG.FA		Control Arm Bushing	533398
	2010.06-	Rear Axle Left & Right Outer	SUV AWD M 06.EC/MCG.E/MCG.EA/MCG.FA		Control Arm Bushing	516121
	2010.06-	Front Axle; Rear Axle Left & Right Lower	SUV AWD M 06.EC/MCG.E/MCG.EA/MCG.FA		Control Arm Bushing	516090
	2010.06-	Front Axle Left	SUV AWD M 06.EC/MCG.E/MCG.EA/MCG.FA		Rod Assembly	S100263
	2010.06-	Front Axle Right	SUV AWD M 06.EC/MCG.E/MCG.EA/MCG.FA		Rod Assembly	S100264
	2010.06-	Front Axle Left & Right	SUV AWD M 06.EC/MCG.E/MCG.EA/MCG.FA		Tie Rod Axle Joint	S030010
	2010.06-	Front Axle Left	SUV AWD M 06.EC/MCG.E/MCG.EA/MCG.FA		Tie Rod End	S070036
	2010.06-	Front Axle Right	SUV AWD M 06.EC/MCG.E/MCG.EA/MCG.FA		Tie Rod End	S070037
	2010.06-	Front Axle Left & Right	SUV AWD M 06.EC/MCG.E/MCG.EA/MCG.FA		Rod/Strut, stabiliser	S050047
2010.06-	Rear Axle Left	SUV AWD M 06.EC/MCG.E/MCG.EA/MCG.FA		Rod/Strut, stabiliser	S050049	



	 YEAR	FITTING POSITION	BODY STYLE & DRIVE TYPE & ENGINE	REMARKS	PRODUCT	GSP Ref.
PORSCHE						
Cayenne						
3.0 (245 kw)	2010.06-	Rear Axle Right	SUV AWD M 06.EC/MCG.E/MCG.EA/MCG.FA		Rod/Strut,stabiliser	S050050
	2010.06-	Rear Axle	SUV AWD M 06.EC/MCG.E/MCG.EA/MCG.FA		Stabiliser Bushing	518122
	2010.06-	Front Axle	SUV AWD M 06.EC/MCG.E/MCG.EA/MCG.FA		Steering Boot	540440
3.0 (250 kw)	2017.05-	Front Axle Left & Right	SUV 4WD DCBE/MDCBE		Tie Rod End	S071841
	2017.05-	Front Axle Left & Right	SUV 4WD DCBE/MDCBE		Rod/Strut,stabiliser	S051258
	2017.05-	Rear Axle Left & Right	SUV 4WD DCBE/MDCBE		Rod/Strut,stabiliser	S051432
3.2 (184 kw)	2003.10-2006.12	Front Axle Left Lower	SUV 4WD M022Y		Track Control Arm	S060347
	2003.10-2006.12	Front Axle Right Lower	SUV 4WD M022Y		Track Control Arm	S060348
	2003.10-2006.12	Front Axle Left & Right Upper	SUV 4WD M022Y		Track Control Arm	S060349
	2003.10-2006.12	Rear Axle Left Lower Inner	SUV 4WD M022Y		Track Control Arm	S062095
	2003.10-2006.12	Rear Axle Left Upper Outer	SUV 4WD M022Y		Track Control Arm	S060045
	2003.10-2006.12	Rear Axle Right Lower Inner	SUV 4WD M022Y		Track Control Arm	S062784
	2003.10-2006.12	Rear Axle Right Upper Outer	SUV 4WD M022Y		Track Control Arm	S060024
	2003.10-2006.12	Rear Axle Left & Right Upper Inner	SUV 4WD M022Y		Track Control Arm	S060808
	2003.10-2006.12	Rear Axle Left & Right Lower Outer	SUV 4WD M022Y		Track Control Arm	510395
	2003.10-2006.12	Front Axle Left & Right Lower	SUV 4WD M022Y		Control Arm Bushing	511490
	2003.10-2006.12	Front Axle Left & Right Lower	SUV 4WD M022Y		Control Arm Bushing	516054
	2003.10-2006.12	Front Axle Left & Right Upper	SUV 4WD M022Y		Control Arm Bushing	510362
	2003.10-2006.12	Rear Axle Left & Right Lower Inner	SUV 4WD M022Y		Control Arm Bushing	516063
	2003.10-2006.12	Rear Axle Left & Right Outer	SUV 4WD M022Y		Control Arm Bushing	516121
	2003.10-2006.12	Front Axle;Rear Axle Left & Right Lower	SUV 4WD M022Y		Control Arm Bushing	516090
	2003.10-2006.12	Front Axle Left	SUV 4WD M022Y		Rod Assembly	S100263
	2003.10-2006.12	Front Axle Right	SUV 4WD M022Y		Rod Assembly	S100264
	2003.10-2006.12	Front Axle Left & Right	SUV 4WD M022Y		Tie Rod Axle Joint	S030010
	2003.10-2006.12	Front Axle Left	SUV 4WD M022Y		Tie Rod End	S070036
	2003.10-2006.12	Front Axle Right	SUV 4WD M022Y		Tie Rod End	S070037
	2003.10-2006.12	Front Axle Left & Right	SUV 4WD M022Y		Tie Rod End	S070866
	2003.10-2006.12	Front Axle Left & Right	SUV 4WD M022Y		Rod/Strut,stabiliser	S050047
	2003.10-2006.12	Rear Axle Left	SUV 4WD M022Y		Rod/Strut,stabiliser	S050049
	2003.10-2006.12	Rear Axle Right	SUV 4WD M022Y		Rod/Strut,stabiliser	S050050
	2003.10-2006.12	Rear Axle	SUV 4WD M022Y		Stabiliser Bushing	518122
	2003.10-2006.12	Front Axle	SUV 4WD M022Y		Steering Boot	540440
	3.6 (213 kw)	2007.02-2010.05	Front Axle Left Lower	SUV 4WD M5501		Track Control Arm
2007.02-2010.05		Front Axle Right Lower	SUV 4WD M5501		Track Control Arm	S060348
2007.02-2010.05		Front Axle Left & Right Upper	SUV 4WD M5501		Track Control Arm	S060349
2007.02-2010.05		Rear Axle Left Lower Inner	SUV 4WD M5501		Track Control Arm	S062095
2007.02-2010.05		Rear Axle Left Upper Outer	SUV 4WD M5501		Track Control Arm	S060045
2007.02-2010.05		Rear Axle Right Lower Inner	SUV 4WD M5501		Track Control Arm	S062784
2007.02-2010.05		Rear Axle Right Upper Outer	SUV 4WD M5501		Track Control Arm	S060024
2007.02-2010.05		Rear Axle Left & Right Upper Inner	SUV 4WD M5501		Track Control Arm	S060808
2007.02-2010.05		Rear Axle Left & Right Lower Outer	SUV 4WD M5501		Track Control Arm	510395
2007.02-2010.05		Front Axle Left & Right Lower	SUV 4WD M5501		Control Arm Bushing	511490
2007.02-2010.05		Front Axle Left & Right Lower	SUV 4WD M5501		Control Arm Bushing	516054
2007.02-2010.05		Front Axle Left & Right Lower	SUV 4WD M5501		Control Arm Bushing	517469
2007.02-2010.05		Front Axle Left & Right Upper	SUV 4WD M5501		Control Arm Bushing	510362
2007.02-2010.05		Rear Axle Left & Right Lower Inner	SUV 4WD M5501		Control Arm Bushing	516063
2007.02-2010.05		Rear Axle Left & Right Outer	SUV 4WD M5501		Control Arm Bushing	516121
2007.02-2010.05		Front Axle;Rear Axle Left & Right Lower	SUV 4WD M5501		Control Arm Bushing	516090
2007.02-2010.05		Front Axle Left	SUV 4WD M5501		Rod Assembly	S100263
2007.02-2010.05		Front Axle Right	SUV 4WD M5501		Rod Assembly	S100264
2007.02-2010.05		Front Axle Left & Right	SUV 4WD M5501		Tie Rod Axle Joint	S030010
2007.02-2010.05		Front Axle Left	SUV 4WD M5501		Tie Rod End	S070036
2007.02-2010.05		Front Axle Right	SUV 4WD M5501		Tie Rod End	S070037
2007.02-2010.05		Front Axle Left & Right	SUV 4WD M5501		Rod/Strut,stabiliser	S050047
2007.02-2010.05		Rear Axle Left	SUV 4WD M5501		Rod/Strut,stabiliser	S050049
2007.02-2010.05		Rear Axle Right	SUV 4WD M5501		Rod/Strut,stabiliser	S050050
2007.02-2010.05		Rear Axle	SUV 4WD M5501		Stabiliser Bushing	518122
2007.02-2010.05		Front Axle	SUV 4WD M5501		Steering Boot	540440
3.6 (220 kw)		2010.06-	Front Axle Left Lower	SUV 4WD M5502/MCEYA		Track Control Arm
	2010.06-	Front Axle Right Lower	SUV 4WD M5502/MCEYA		Track Control Arm	S060044
	2010.06-	Rear Axle Left & Right Upper Inner	SUV 4WD M5502/MCEYA		Track Control Arm	S060808
	2010.06-	Front Axle Left & Right Lower	SUV 4WD M5502/MCEYA		Control Arm Bushing	516054
	2010.06-	Front Axle Left & Right Lower	SUV 4WD M5502/MCEYA		Control Arm Bushing	517469
	2010.06-	Front Axle Left & Right Upper	SUV 4WD M5502/MCEYA		Control Arm Bushing	533398



	 YEAR	FITTING POSITION	BODY STYLE & DRIVE TYPE & ENGINE	REMARKS	PRODUCT	GSP Ref.	
PORSCHE Cayenne							
3.6 (220 kw)	2010.06-	Rear Axle Left & Right Outer	SUV 4WD M5502/MCEYA		Control Arm Bushing	516121	
	2010.06-	Front Axle;Rear Axle Left & Right Lower	SUV 4WD M5502/MCEYA		Control Arm Bushing	516090	
	2010.06-	Front Axle Left	SUV 4WD M5502/MCEYA		Rod Assembly	S100263	
	2010.06-	Front Axle Right	SUV 4WD M5502/MCEYA		Rod Assembly	S100264	
	2010.06-	Front Axle Left & Right	SUV 4WD M5502/MCEYA		Tie Rod Axle Joint	S030010	
	2010.06-	Front Axle Left	SUV 4WD M5502/MCEYA		Tie Rod End	S070036	
	2010.06-	Front Axle Right	SUV 4WD M5502/MCEYA		Tie Rod End	S070037	
	2010.06-	Front Axle Left & Right	SUV 4WD M5502/MCEYA		Rod/Strut,stabiliser	S050047	
	2010.06-	Rear Axle Left	SUV 4WD M5502/MCEYA		Rod/Strut,stabiliser	S050049	
	2010.06-	Rear Axle Right	SUV 4WD M5502/MCEYA		Rod/Strut,stabiliser	S050050	
	2010.06-	Rear Axle	SUV 4WD M5502/MCEYA		Stabiliser Bushing	518122	
	2010.06-	Front Axle	SUV 4WD M5502/MCEYA		Steering Boot	540440	
	3.6 (309 kw)	2014.10-	Rear Axle Left & Right Upper Inner	SUV 4WD MCURA		Track Control Arm	S060808
2014.10-		Front Axle Left & Right Lower	SUV 4WD MCURA	Date from:2015.01	Control Arm Bushing	516054	
2014.10-		Front Axle Left & Right Lower	SUV 4WD MCURA		Control Arm Bushing	517469	
2014.10-		Front Axle Left & Right Upper	SUV 4WD MCURA		Control Arm Bushing	533398	
2014.10-		Rear Axle Left & Right Outer	SUV 4WD MCURA		Control Arm Bushing	516121	
2014.10-		Front Axle;Rear Axle Left & Right Lower	SUV 4WD MCURA		Control Arm Bushing	516090	
2014.10-		Front Axle Left	SUV 4WD MCURA		Tie Rod End	S070036	
2014.10-		Front Axle Right	SUV 4WD MCURA		Tie Rod End	S070037	
2014.10-		Front Axle Left & Right	SUV 4WD MCURA		Rod/Strut,stabiliser	S050047	
2014.10-		Rear Axle Left	SUV 4WD MCURA		Rod/Strut,stabiliser	S050049	
2014.10-		Rear Axle Right	SUV 4WD MCURA		Rod/Strut,stabiliser	S050050	
2014.10-		Rear Axle	SUV 4WD MCURA		Stabiliser Bushing	518122	
3.6 (324 kw)		2015.02-	Rear Axle Left & Right Upper Inner	SUV 4WD MCXZA		Track Control Arm	S060808
	2015.02-	Front Axle Left & Right Lower	SUV 4WD MCXZA	Date from:2015.01	Control Arm Bushing	516054	
	2015.02-	Front Axle Left & Right Lower	SUV 4WD MCXZA		Control Arm Bushing	517469	
	2015.02-	Front Axle Left & Right Upper	SUV 4WD MCXZA		Control Arm Bushing	533398	
	2015.02-	Rear Axle Left & Right Outer	SUV 4WD MCXZA		Control Arm Bushing	516121	
	2015.02-	Front Axle Left	SUV 4WD MCXZA		Tie Rod End	S070036	
	2015.02-	Front Axle Right	SUV 4WD MCXZA		Tie Rod End	S070037	
	2015.02-	Front Axle Left & Right	SUV 4WD MCXZA		Rod/Strut,stabiliser	S050047	
	2015.02-	Rear Axle Left	SUV 4WD MCXZA		Rod/Strut,stabiliser	S050049	
	2015.02-	Rear Axle Right	SUV 4WD MCXZA		Rod/Strut,stabiliser	S050050	
	2015.02-	Rear Axle	SUV 4WD MCXZA		Stabiliser Bushing	518122	
	4.0 (404 kw)	2017.05-	Front Axle Left & Right	SUV 4WD DCUA/MDCUA		Tie Rod End	S071841
		2017.05-	Front Axle Left & Right	SUV 4WD DCUA/MDCUA		Rod/Strut,stabiliser	S051258
2017.05-		Rear Axle Left & Right	SUV 4WD DCUA/MDCUA		Rod/Strut,stabiliser	S051432	
4.5 (331 kw)	2002.08-2006.12	Front Axle Left & Right Upper	SUV 4WD M4850		Track Control Arm	S060349	
	2002.08-2006.12	Rear Axle Left Lower Inner	SUV 4WD M4850		Track Control Arm	S062095	
	2002.08-2006.12	Rear Axle Right Lower Inner	SUV 4WD M4850		Track Control Arm	S062784	
	2002.08-2006.12	Rear Axle Left & Right Upper Inner	SUV 4WD M4850		Track Control Arm	S060808	
	2002.08-2006.12	Rear Axle Left & Right Lower Outer	SUV 4WD M4850		Track Control Arm	510395	
	2002.08-2006.12	Front Axle Left & Right Lower	SUV 4WD M4850		Control Arm Bushing	511490	
	2002.08-2006.12	Front Axle Left & Right Lower	SUV 4WD M4850		Control Arm Bushing	516054	
	2002.08-2006.12	Front Axle Left & Right Upper	SUV 4WD M4850		Control Arm Bushing	510362	
	2002.08-2006.12	Rear Axle Left & Right Lower Inner	SUV 4WD M4850		Control Arm Bushing	516063	
	2002.08-2006.12	Rear Axle Left & Right Outer	SUV 4WD M4850		Control Arm Bushing	516121	
	2002.08-2006.12	Front Axle;Rear Axle Left & Right Lower	SUV 4WD M4850		Control Arm Bushing	516090	
	2002.08-2006.12	Front Axle Left	SUV 4WD M4850		Rod Assembly	S100263	
	2002.08-2006.12	Front Axle Right	SUV 4WD M4850		Rod Assembly	S100264	
	2002.08-2006.12	Front Axle Left & Right	SUV 4WD M4850		Tie Rod Axle Joint	S030010	
	2002.08-2006.12	Front Axle Left	SUV 4WD M4850		Tie Rod End	S070036	
	2002.08-2006.12	Front Axle Right	SUV 4WD M4850		Tie Rod End	S070037	
	2002.08-2006.12	Front Axle Left & Right	SUV 4WD M4850		Rod/Strut,stabiliser	S050047	
	2002.08-2006.12	Rear Axle Left	SUV 4WD M4850		Rod/Strut,stabiliser	S050049	
	2002.08-2006.12	Rear Axle Right	SUV 4WD M4850		Rod/Strut,stabiliser	S050050	
2002.08-2006.12	Rear Axle	SUV 4WD M4850		Stabiliser Bushing	518122		
2002.08-2006.12	Front Axle	SUV 4WD M4850		Steering Boot	540440		
4.5 (383 kw)	2006.03-2010.05	Front Axle Left & Right Upper	SUV 4WD M4850T		Track Control Arm	S060349	
	2006.03-2010.05	Rear Axle Left Lower Inner	SUV 4WD M4850T		Track Control Arm	S062095	
	2006.03-2010.05	Rear Axle Right Lower Inner	SUV 4WD M4850T		Track Control Arm	S062784	
	2006.03-2010.05	Rear Axle Left & Right Upper Inner	SUV 4WD M4850T		Track Control Arm	S060808	
	2006.03-2010.05	Front Axle Left & Right Lower	SUV 4WD M4850T		Control Arm Bushing	516054	



	 YEAR	FITTING POSITION	BODY STYLE & DRIVE TYPE & ENGINE	REMARKS	PRODUCT	GSP Ref.
PORSCHE						
Cayenne						
4.5 (383 kw)	2006.03-2010.05	Front Axle Left & Right Upper	SUV 4WD M4850T		Control Arm Bushing	510362
	2006.03-2010.05	Rear Axle Left & Right Lower Inner	SUV 4WD M4850T		Control Arm Bushing	516063
	2006.03-2010.05	Rear Axle Left & Right Outer	SUV 4WD M4850T		Control Arm Bushing	516121
	2006.03-2010.05	Front Axle;Rear Axle Left & Right Lower	SUV 4WD M4850T		Control Arm Bushing	516090
	2006.03-2010.05	Front Axle Left	SUV 4WD M4850T		Rod Assembly	S100263
	2006.03-2010.05	Front Axle Right	SUV 4WD M4850T		Rod Assembly	S100264
	2006.03-2010.05	Front Axle Left & Right	SUV 4WD M4850T		Rod/Strut,stabiliser	S050047
	2006.03-2010.05	Rear Axle Left	SUV 4WD M4850T		Rod/Strut,stabiliser	S050049
	2006.03-2010.05	Rear Axle Right	SUV 4WD M4850T		Rod/Strut,stabiliser	S050050
	2006.03-2010.05	Rear Axle	SUV 4WD M4850T		Stabiliser Bushing	518122
	2006.03-2010.05	Front Axle	SUV 4WD M4850T		Steering Boot	540440
4.8 (283 kw)	2007.02-2010.12	Front Axle Left Lower	SUV 4WD M4801		Track Control Arm	S060347
	2007.02-2010.12	Front Axle Right Lower	SUV 4WD M4801		Track Control Arm	S060348
	2007.02-2010.12	Front Axle Left & Right Upper	SUV 4WD M4801		Track Control Arm	S060349
	2007.02-2010.12	Rear Axle Left Lower Inner	SUV 4WD M4801		Track Control Arm	S062095
	2007.02-2010.12	Rear Axle Right Lower Inner	SUV 4WD M4801		Track Control Arm	S062784
	2007.02-2010.12	Rear Axle Left & Right Upper Inner	SUV 4WD M4801		Track Control Arm	S060808
	2007.02-2010.12	Rear Axle Left & Right Lower Outer	SUV 4WD M4801		Track Control Arm	S10395
	2007.02-2010.12	Front Axle Left & Right Lower	SUV 4WD M4801		Control Arm Bushing	511490
	2007.02-2010.12	Front Axle Left & Right Lower	SUV 4WD M4801		Control Arm Bushing	516054
	2007.02-2010.12	Front Axle Left & Right Lower	SUV 4WD M4801		Control Arm Bushing	517469
	2007.02-2010.12	Front Axle Left & Right Upper	SUV 4WD M4801		Control Arm Bushing	510362
	2007.02-2010.12	Rear Axle Left & Right Lower Inner	SUV 4WD M4801		Control Arm Bushing	516063
	2007.02-2010.12	Rear Axle Left & Right Outer	SUV 4WD M4801		Control Arm Bushing	516121
	2007.02-2010.12	Front Axle;Rear Axle Left & Right Lower	SUV 4WD M4801		Control Arm Bushing	516090
	2007.02-2010.12	Front Axle Left	SUV 4WD M4801		Rod Assembly	S100263
	2007.02-2010.12	Front Axle Right	SUV 4WD M4801		Rod Assembly	S100264
	2007.02-2010.12	Front Axle Left & Right	SUV 4WD M4801		Tie Rod Axle Joint	S030010
	2007.02-2010.12	Front Axle Left	SUV 4WD M4801		Tie Rod End	S070036
	2007.02-2010.12	Front Axle Right	SUV 4WD M4801		Tie Rod End	S070037
	2007.02-2010.12	Front Axle Left & Right	SUV 4WD M4801		Rod/Strut,stabiliser	S050047
	2007.02-2010.12	Rear Axle Left	SUV 4WD M4801		Rod/Strut,stabiliser	S050049
	2007.02-2010.12	Rear Axle Right	SUV 4WD M4801		Rod/Strut,stabiliser	S050050
	2007.02-2010.12	Rear Axle	SUV 4WD M4801		Stabiliser Bushing	518122
	2007.02-2010.12	Front Axle	SUV 4WD M4801		Steering Boot	540440
4.8 (298 kw)	2007.10-2010.12	Rear Axle Left Lower Inner	SUV 4WD M4801		Track Control Arm	S062095
	2007.10-2010.12	Rear Axle Right Lower Inner	SUV 4WD M4801		Track Control Arm	S062784
	2007.10-2010.12	Rear Axle Left & Right Upper Inner	SUV 4WD M4801		Track Control Arm	S060808
	2007.10-2010.12	Rear Axle Left & Right Lower Outer	SUV 4WD M4801		Track Control Arm	510395
	2007.10-2010.12	Front Axle Left & Right Lower	SUV 4WD M4801		Control Arm Bushing	511490
	2007.10-2010.12	Front Axle Left & Right Lower	SUV 4WD M4801		Control Arm Bushing	516054
	2007.10-2010.12	Front Axle Left & Right Lower	SUV 4WD M4801		Control Arm Bushing	517469
	2007.10-2010.12	Front Axle Left & Right Upper	SUV 4WD M4801		Control Arm Bushing	510362
	2007.10-2010.12	Rear Axle Left & Right Lower Inner	SUV 4WD M4801		Control Arm Bushing	516063
	2007.10-2010.12	Rear Axle Left & Right Outer	SUV 4WD M4801		Control Arm Bushing	516121
	2007.10-2010.12	Front Axle;Rear Axle Left & Right Lower	SUV 4WD M4801		Control Arm Bushing	516090
	2007.10-2010.12	Front Axle Left	SUV 4WD M4801		Rod Assembly	S100263
	2007.10-2010.12	Front Axle Right	SUV 4WD M4801		Rod Assembly	S100264
	2007.10-2010.12	Front Axle Left & Right	SUV 4WD M4801		Tie Rod Axle Joint	S030010
	2007.10-2010.12	Front Axle Left	SUV 4WD M4801		Tie Rod End	S070036
	2007.10-2010.12	Front Axle Right	SUV 4WD M4801		Tie Rod End	S070037
	2007.10-2010.12	Front Axle Left & Right	SUV 4WD M4801		Rod/Strut,stabiliser	S050047
	2007.10-2010.12	Rear Axle Left	SUV 4WD M4801		Rod/Strut,stabiliser	S050049
	2007.10-2010.12	Rear Axle	SUV 4WD M4801		Stabiliser Bushing	518122
	2007.10-2010.12	Front Axle	SUV 4WD M4801		Steering Boot	540440
4.8 (309 kw)	2012.06-2014.09	Rear Axle Left & Right Upper Inner	SUV 4WD M4802		Track Control Arm	S060808
	2012.06-2014.09	Front Axle Left & Right Lower	SUV 4WD M4802		Control Arm Bushing	516054
	2012.06-2014.09	Front Axle Left & Right Lower	SUV 4WD M4802		Control Arm Bushing	517469
	2012.06-2014.09	Front Axle Left & Right Upper	SUV 4WD M4802		Control Arm Bushing	533398
	2012.06-2014.09	Rear Axle Left & Right Outer	SUV 4WD M4802		Control Arm Bushing	516121
	2012.06-2014.09	Front Axle;Rear Axle Left & Right Lower	SUV 4WD M4802		Control Arm Bushing	516090
	2012.06-2014.09	Front Axle Left & Right	SUV 4WD M4802		Tie Rod Axle Joint	S030010
	2012.06-2014.09	Front Axle Left	SUV 4WD M4802		Tie Rod End	S070036
	2012.06-2014.09	Front Axle Right	SUV 4WD M4802		Tie Rod End	S070037



	 YEAR	FITTING POSITION	BODY STYLE & DRIVE TYPE & ENGINE	REMARKS	PRODUCT	GSP Ref.
PORSCHE						
Cayenne						
4.8 (309 kw)	2012.06-2014.09	Front Axle Left & Right	SUV 4WD M4802		Rod/Strut, stabiliser	S050047
	2012.06-2014.09	Rear Axle Left	SUV 4WD M4802		Rod/Strut, stabiliser	S050049
	2012.06-2014.09	Rear Axle Right	SUV 4WD M4802		Rod/Strut, stabiliser	S050050
	2012.06-2014.09	Rear Axle	SUV 4WD M4802		Stabiliser Bushing	518122
4.8 (368 kw)	2006.12-2010.05	Front Axle Left & Right Upper	SUV 4WD M4851		Track Control Arm	S060349
	2006.12-2010.05	Rear Axle Left Lower Inner	SUV 4WD M4851		Track Control Arm	S062095
	2006.12-2010.05	Rear Axle Right Lower Inner	SUV 4WD M4851		Track Control Arm	S062784
	2006.12-2010.05	Rear Axle Left & Right Upper Inner	SUV 4WD M4851		Track Control Arm	S060808
	2006.12-2010.05	Rear Axle Left & Right Lower Outer	SUV 4WD M4851		Track Control Arm	510395
	2006.12-2010.05	Front Axle Left & Right Lower	SUV 4WD M4851		Control Arm Bushing	511490
	2006.12-2010.05	Front Axle Left & Right Lower	SUV 4WD M4851		Control Arm Bushing	516054
	2006.12-2010.05	Front Axle Left & Right Lower	SUV 4WD M4851		Control Arm Bushing	517469
	2006.12-2010.05	Front Axle Left & Right Upper	SUV 4WD M4851		Control Arm Bushing	510362
	2006.12-2010.05	Rear Axle Left & Right Lower Inner	SUV 4WD M4851		Control Arm Bushing	516063
	2006.12-2010.05	Rear Axle Left & Right Outer	SUV 4WD M4851		Control Arm Bushing	516121
	2006.12-2010.05	Front Axle; Rear Axle Left & Right Lower	SUV 4WD M4851		Control Arm Bushing	516090
	2006.12-2010.05	Front Axle Left	SUV 4WD M4851		Tie Rod End	S070036
	2006.12-2010.05	Front Axle Right	SUV 4WD M4851		Tie Rod End	S070037
	2006.12-2010.05	Front Axle Left & Right	SUV 4WD M4851		Rod/Strut, stabiliser	S050047
	2006.12-2010.05	Rear Axle Left	SUV 4WD M4851		Rod/Strut, stabiliser	S050049
	2006.12-2010.05	Rear Axle Right	SUV 4WD M4851		Rod/Strut, stabiliser	S050050
	2006.12-2010.05	Rear Axle	SUV 4WD M4851		Stabiliser Bushing	518122
	2006.12-2010.05	Front Axle	SUV 4WD M4851		Steering Boot	540440
	2010.06-2014.09	Front Axle Left Lower	SUV 4WD M4852		Track Control Arm	S060043
	2010.06-2014.09	Front Axle Right Lower	SUV 4WD M4852		Track Control Arm	S060044
	2010.06-2014.09	Rear Axle Left Upper Outer	SUV 4WD M4852		Track Control Arm	S060045
	2010.06-2014.09	Rear Axle Right Upper Outer	SUV 4WD M4852		Track Control Arm	S060024
	2010.06-2014.09	Rear Axle Left & Right Upper Inner	SUV 4WD M4852		Track Control Arm	S060808
	2010.06-2014.09	Front Axle Left & Right Lower	SUV 4WD M4852		Control Arm Bushing	516054
	2010.06-2014.09	Front Axle Left & Right Lower	SUV 4WD M4852		Control Arm Bushing	517469
	2010.06-2014.09	Front Axle Left & Right Upper	SUV 4WD M4852		Control Arm Bushing	533398
	2010.06-2014.09	Rear Axle Left & Right Outer	SUV 4WD M4852		Control Arm Bushing	516121
	2010.06-2014.09	Front Axle; Rear Axle Left & Right Lower	SUV 4WD M4852		Control Arm Bushing	516090
	2010.06-2014.09	Front Axle Left	SUV 4WD M4852		Rod Assembly	S100263
	2010.06-2014.09	Front Axle Right	SUV 4WD M4852		Rod Assembly	S100264
	2010.06-2014.09	Front Axle Left & Right	SUV 4WD M4852		Tie Rod Axle Joint	S030010
	2010.06-2014.09	Front Axle Left	SUV 4WD M4852		Tie Rod End	S070036
	2010.06-2014.09	Front Axle Right	SUV 4WD M4852		Tie Rod End	S070037
2010.06-2014.09	Front Axle Left & Right	SUV 4WD M4852		Rod/Strut, stabiliser	S050047	
2010.06-2014.09	Rear Axle Left	SUV 4WD M4852		Rod/Strut, stabiliser	S050049	
2010.06-2014.09	Rear Axle Right	SUV 4WD M4852		Rod/Strut, stabiliser	S050050	
2010.06-2014.09	Rear Axle	SUV 4WD M4852		Stabiliser Bushing	518122	
2010.06-2014.09	Front Axle	SUV 4WD M4852		Steering Boot	540440	
4.8 (382 kw)	2014.10-	Rear Axle Left & Right Upper Inner	SUV 4WD MCFTB		Track Control Arm	S060808
	2014.10-	Front Axle Left & Right Lower	SUV 4WD MCFTB		Control Arm Bushing	516054
	2014.10-	Front Axle Left & Right Lower	SUV 4WD MCFTB		Control Arm Bushing	517469
	2014.10-	Front Axle Left & Right Upper	SUV 4WD MCFTB		Control Arm Bushing	533398
	2014.10-	Rear Axle Left & Right Outer	SUV 4WD MCFTB		Control Arm Bushing	516121
	2014.10-	Front Axle; Rear Axle Left & Right Lower	SUV 4WD MCFTB		Control Arm Bushing	516090
	2014.10-	Front Axle Left	SUV 4WD MCFTB		Tie Rod End	S070036
	2014.10-	Front Axle Right	SUV 4WD MCFTB		Tie Rod End	S070037
	2014.10-	Front Axle Left & Right	SUV 4WD MCFTB		Rod/Strut, stabiliser	S050047
	2014.10-	Rear Axle Left	SUV 4WD MCFTB		Rod/Strut, stabiliser	S050049
2014.10-	Rear Axle Right	SUV 4WD MCFTB		Rod/Strut, stabiliser	S050050	
2014.10-	Rear Axle	SUV 4WD MCFTB		Stabiliser Bushing	518122	
4.8 (405 kw)	2012.10-2014.09	Rear Axle Left & Right Upper Inner	SUV 4WD M4852		Track Control Arm	S060808
	2012.10-2014.09	Front Axle Left & Right Lower	SUV 4WD M4852		Control Arm Bushing	516054
	2012.10-2014.09	Front Axle Left & Right Lower	SUV 4WD M4852		Control Arm Bushing	517469
	2012.10-2014.09	Front Axle Left & Right Upper	SUV 4WD M4852		Control Arm Bushing	533398
	2012.10-2014.09	Rear Axle Left & Right Outer	SUV 4WD M4852		Control Arm Bushing	516121
	2012.10-2014.09	Front Axle; Rear Axle Left & Right Lower	SUV 4WD M4852		Control Arm Bushing	516090
	2012.10-2014.09	Front Axle Left & Right	SUV 4WD M4852		Tie Rod Axle Joint	S030010
	2012.10-2014.09	Front Axle Left	SUV 4WD M4852		Tie Rod End	S070036
2012.10-2014.09	Front Axle Right	SUV 4WD M4852		Tie Rod End	S070037	



	 YEAR	FITTING POSITION	BODY STYLE & DRIVE TYPE & ENGINE	REMARKS	PRODUCT	GSP Ref.
PORSCHE						
Cayenne						
4.8 (405 kw)	2012.10-2014.09	Front Axle Left & Right	SUV 4WD M4852		Rod/Strut,stabiliser	S050047
	2012.10-2014.09	Rear Axle Left	SUV 4WD M4852		Rod/Strut,stabiliser	S050049
	2012.10-2014.09	Rear Axle Right	SUV 4WD M4852		Rod/Strut,stabiliser	S050050
	2012.10-2014.09	Rear Axle	SUV 4WD M4852		Stabiliser Bushing	518122
4.8 (419 kw)	2015.01-	Rear Axle Left & Right Upper Inner	SUV 4WD MCYXA		Track Control Arm	S060808
	2015.01-	Front Axle Left & Right Lower	SUV 4WD MCYXA		Control Arm Bushing	516054
	2015.01-	Front Axle Left & Right Lower	SUV 4WD MCYXA		Control Arm Bushing	517469
	2015.01-	Front Axle Left & Right Upper	SUV 4WD MCYXA		Control Arm Bushing	533398
	2015.01-	Rear Axle Left & Right Outer	SUV 4WD MCYXA		Control Arm Bushing	516121
	2015.01-	Front Axle Left	SUV 4WD MCYXA		Tie Rod End	S070036
	2015.01-	Front Axle Right	SUV 4WD MCYXA		Tie Rod End	S070037
	2015.01-	Front Axle Left & Right	SUV 4WD MCYXA		Rod/Strut,stabiliser	S050047
	2015.01-	Rear Axle Left	SUV 4WD MCYXA		Rod/Strut,stabiliser	S050049
	2015.01-	Rear Axle Right	SUV 4WD MCYXA		Rod/Strut,stabiliser	S050050
	2015.01-	Rear Axle	SUV 4WD MCYXA		Stabiliser Bushing	518122
Cayman						
2.7 (202 kw)	2013.03-	Front Axle Left & Right	Coupe RWD MA122		Tie Rod End	S070383
2.9 (195 kw)	2009.02-2012.12	Front Axle Left & Right Lower	Coupe RWD MA120		Track Control Arm	S063043
	2009.02-2012.12	Front Axle Left & Right	Coupe RWD MA120		Tie Rod End	S070383
3.4 (239 kw)	2013.03-	Front Axle Left & Right	Coupe RWD MA123		Tie Rod End	S070383
3.4 (250 kw)	2014.02-	Front Axle Left & Right	Coupe RWD MA123		Tie Rod End	S070383
3.8 (283 kw)	2015.01-	Front Axle Left & Right	Coupe RWD MDBXA		Tie Rod End	S070383
Macan						
2.0 (174 kw)	2014.07-2018.09	Front Axle Left Upper Inner	SUV 4WD MCNCC		Track Control Arm	S060804
	2014.07-2018.09	Front Axle Right Upper Inner	SUV 4WD MCNCC		Track Control Arm	S060805
	2014.07-2018.09	Rear Axle Left Upper	SUV 4WD MCNCC		Track Control Arm	S061397
	2014.07-2018.09	Rear Axle Right Upper	SUV 4WD MCNCC		Track Control Arm	S061398
	2014.07-2018.09	Rear Axle Left & Right Lower Inner	SUV 4WD MCNCC		Track Control Arm	S062964
	2014.07-2018.09	Front Axle Left & Right Lower Outer	SUV 4WD MCNCC		Ball Joint	S080987
	2014.07-2018.09	Rear Axle Left & Right Lower Inner	SUV 4WD MCNCC		Control Arm Bushing	533477
	2014.07-2018.09	Front Axle Left & Right	SUV 4WD MCNCC		Tie Rod Axle Joint	S030654
	2014.07-2018.09	Front Axle Left	SUV 4WD MCNCC		Tie Rod End	S070024
	2014.07-2018.09	Front Axle Right	SUV 4WD MCNCC		Tie Rod End	S070025
	2014.07-2018.09	Front Axle Left & Right	SUV 4WD MCNCC		Rod/Strut,stabiliser	S051258
	2014.07-2018.09	Front Axle	SUV 4WD MCNCC		Stabiliser Bushing	517806
	3.0 (250 kw)	2014.02-2018.09	Front Axle Left Upper Inner	SUV 4WD MCTMA		Track Control Arm
2014.02-2018.09		Front Axle Right Upper Inner	SUV 4WD MCTMA		Track Control Arm	S060805
2014.02-2018.09		Rear Axle Left Upper	SUV 4WD MCTMA		Track Control Arm	S061397
2014.02-2018.09		Rear Axle Right Upper	SUV 4WD MCTMA		Track Control Arm	S061398
2014.02-2018.09		Rear Axle Left & Right Lower Inner	SUV 4WD MCTMA		Track Control Arm	S062964
2014.02-2018.09		Front Axle Left & Right Lower Outer	SUV 4WD MCTMA		Ball Joint	S080987
2014.02-2018.09		Rear Axle Left & Right Lower Inner	SUV 4WD MCTMA		Control Arm Bushing	533477
2014.02-2018.09		Front Axle Left & Right	SUV 4WD MCTMA		Tie Rod Axle Joint	S030654
2014.02-2018.09		Front Axle Left	SUV 4WD MCTMA		Tie Rod End	S070024
2014.02-2018.09		Front Axle Right	SUV 4WD MCTMA		Tie Rod End	S070025
2014.02-2018.09		Front Axle Left & Right	SUV 4WD MCTMA		Rod/Strut,stabiliser	S051258
2014.02-2018.09		Front Axle	SUV 4WD MCTMA		Stabiliser Bushing	517806
3.0 (265 kw)		2015.11-2018.09	Front Axle Left Upper Inner	SUV 4WD MDCNA		Track Control Arm
	2015.11-2018.09	Front Axle Right Upper Inner	SUV 4WD MDCNA		Track Control Arm	S060805
	2015.11-2018.09	Rear Axle Left Upper	SUV 4WD MDCNA		Track Control Arm	S061397
	2015.11-2018.09	Rear Axle Right Upper	SUV 4WD MDCNA		Track Control Arm	S061398
	2015.11-2018.09	Rear Axle Left & Right Lower Inner	SUV 4WD MDCNA		Track Control Arm	S062964
	2015.11-2018.09	Front Axle Left & Right Lower Outer	SUV 4WD MDCNA		Ball Joint	S080987
	2015.11-2018.09	Rear Axle Left & Right Lower Inner	SUV 4WD MDCNA		Control Arm Bushing	533477
	2015.11-2018.09	Front Axle Left & Right	SUV 4WD MDCNA		Tie Rod Axle Joint	S030654
	2015.11-2018.09	Front Axle Left	SUV 4WD MDCNA		Tie Rod End	S070024
	2015.11-2018.09	Front Axle Right	SUV 4WD MDCNA		Tie Rod End	S070025
	2015.11-2018.09	Front Axle Left & Right	SUV 4WD MDCNA		Rod/Strut,stabiliser	S051258
	2015.11-2018.09	Front Axle	SUV 4WD MDCNA		Stabiliser Bushing	517806
	3.6 (294 kw)	2014.02-2018.09	Front Axle Left Upper Inner	SUV 4WD MCTLA		Track Control Arm
2014.02-2018.09		Front Axle Right Upper Inner	SUV 4WD MCTLA		Track Control Arm	S060805
2014.02-2018.09		Rear Axle Left Upper	SUV 4WD MCTLA		Track Control Arm	S061397
2014.02-2018.09		Rear Axle Right Upper	SUV 4WD MCTLA		Track Control Arm	S061398
2014.02-2018.09		Rear Axle Left & Right Lower Inner	SUV 4WD MCTLA		Track Control Arm	S062964
2014.02-2018.09		Front Axle Left & Right Lower Outer	SUV 4WD MCTLA		Ball Joint	S080987
2014.02-2018.09		Rear Axle Left & Right Lower Inner	SUV 4WD MCTLA		Control Arm Bushing	533477
2014.02-2018.09		Front Axle Left & Right	SUV 4WD MCTLA		Tie Rod Axle Joint	S030654



	 YEAR	FITTING POSITION	BODY STYLE & DRIVE TYPE & ENGINE	REMARKS	PRODUCT	GSP Ref.
PORSCHE						
Macan						
3.6 (294 kw)	2014.02-2018.09	Front Axle Left & Right	SUV 4WD MCTLA		Tie Rod Axle Joint	S030654
	2014.02-2018.09	Front Axle Left	SUV 4WD MCTLA		Tie Rod End	S070024
	2014.02-2018.09	Front Axle Right	SUV 4WD MCTLA		Tie Rod End	S070025
	2014.02-2018.09	Front Axle Left & Right	SUV 4WD MCTLA		Rod/Strut, stabiliser	S051258
Panamera						
3.0 (184 kw)	2011.08-2016.10	Front Axle Left Lower	Hatchback RWD MCRC/MCRCC		Track Control Arm	S063038
	2011.08-2016.10	Front Axle Right Lower	Hatchback RWD MCRC/MCRCC		Track Control Arm	S063039
	2011.08-2016.10	Rear Axle Left & Right Centre	Hatchback RWD MCRC/MCRCC		Track Control Arm	S063036
	2011.08-2016.10	Rear Axle Left & Right Upper	Hatchback RWD MCRC/MCRCC		Track Control Arm	S063035
	2011.08-2016.10	Front Axle Left & Right Upper	Hatchback RWD MCRC/MCRCC		Control Arm Bushing	510362
	2011.08-2016.10	Front Axle Left	Hatchback RWD MCRC/MCRCC		Tie Rod End	S071843
	2011.08-2016.10	Front Axle Right	Hatchback RWD MCRC/MCRCC		Tie Rod End	S071842
3.0 (309 kw)	2013.08-2016.10	Front Axle Left Lower	Hatchback RWD MCWDA		Track Control Arm	S063038
	2013.08-2016.10	Front Axle Right Lower	Hatchback RWD MCWDA		Track Control Arm	S063039
	2013.08-2016.10	Rear Axle Left & Right Centre	Hatchback RWD MCWDA		Track Control Arm	S063036
	2013.08-2016.10	Rear Axle Left & Right Upper	Hatchback RWD MCWDA		Track Control Arm	S063035
	2013.08-2016.10	Front Axle Left & Right Upper	Hatchback RWD MCWDA		Control Arm Bushing	510362
	2013.08-2016.10	Front Axle Left & Right Lower Inner	Hatchback RWD MCWDA		Control Arm Bushing	531929
	2013.08-2016.10	Front Axle Left	Hatchback RWD MCWDA		Tie Rod End	S071843
	2013.08-2016.10	Front Axle Right	Hatchback RWD MCWDA		Tie Rod End	S071842
3.6 (220 kw)	2010.04-2013.07	Front Axle Left Lower	Hatchback 4WD M4640		Track Control Arm	S063038
	2010.04-2013.07	Front Axle Right Lower	Hatchback 4WD M4640		Track Control Arm	S063039
	2010.04-2013.07	Rear Axle Left & Right Centre	Hatchback 4WD M4640		Track Control Arm	S063036
	2010.04-2013.07	Rear Axle Left & Right Upper	Hatchback 4WD M4640		Track Control Arm	S063035
	2010.04-2013.07	Front Axle Left & Right Upper	Hatchback 4WD M4640		Control Arm Bushing	510362
	2010.04-2013.07	Front Axle Left	Hatchback 4WD M4640		Tie Rod End	S071843
	2010.04-2013.07	Front Axle Right	Hatchback 4WD M4640		Tie Rod End	S071842
	2010.05-2013.07	Front Axle Left Lower	Hatchback RWD M4620		Track Control Arm	S063038
	2010.05-2013.07	Front Axle Right Lower	Hatchback RWD M4620		Track Control Arm	S063039
	2010.05-2013.07	Rear Axle Left & Right Centre	Hatchback RWD M4620		Track Control Arm	S063036
	2010.05-2013.07	Rear Axle Left & Right Upper	Hatchback RWD M4620		Track Control Arm	S063035
	2010.05-2013.07	Front Axle Left & Right Upper	Hatchback RWD M4620		Control Arm Bushing	510362
	2010.05-2013.07	Front Axle Left	Hatchback RWD M4620		Tie Rod End	S071843
	2010.05-2013.07	Front Axle Right	Hatchback RWD M4620		Tie Rod End	S071842
4.8 (294 kw)	2009.09-2013.07	Front Axle Left Lower	Hatchback RWD M4820		Track Control Arm	S063038
	2009.09-2013.07	Front Axle Right Lower	Hatchback RWD M4820		Track Control Arm	S063039
	2009.09-2013.07	Rear Axle Left & Right Centre	Hatchback RWD M4820		Track Control Arm	S063036
	2009.09-2013.07	Rear Axle Left & Right Upper	Hatchback RWD M4820		Track Control Arm	S063035
	2009.09-2013.07	Front Axle Left & Right Upper	Hatchback RWD M4820		Control Arm Bushing	510362
	2009.09-2013.07	Front Axle Left	Hatchback RWD M4820		Tie Rod End	S071843
	2009.09-2013.07	Front Axle Right	Hatchback RWD M4820		Tie Rod End	S071842
4.8 (316 kw)	2012.01-2016.10	Front Axle Left Lower	Hatchback 4WD M4840/MCXRA		Track Control Arm	S063038
	2012.01-2016.10	Front Axle Right Lower	Hatchback 4WD M4840/MCXRA		Track Control Arm	S063039
	2012.01-2016.10	Rear Axle Left & Right Centre	Hatchback 4WD M4840/MCXRA		Track Control Arm	S063036
	2012.01-2016.10	Rear Axle Left & Right Upper	Hatchback 4WD M4840/MCXRA		Track Control Arm	S063035
	2012.01-2016.10	Front Axle Left & Right Upper	Hatchback 4WD M4840/MCXRA		Control Arm Bushing	510362
	2012.01-2016.10	Front Axle Left	Hatchback 4WD M4840/MCXRA		Tie Rod End	S071843
	2012.01-2016.10	Front Axle Right	Hatchback 4WD M4840/MCXRA		Tie Rod End	S071842
4.8 (324 kw)	2013.08-2016.10	Front Axle Left Lower	Hatchback 4WD MCXPA/MCXRA		Track Control Arm	S063038
	2013.08-2016.10	Front Axle Right Lower	Hatchback 4WD MCXPA/MCXRA		Track Control Arm	S063039
	2013.08-2016.10	Rear Axle Left & Right Centre	Hatchback 4WD MCXPA/MCXRA		Track Control Arm	S063036
	2013.08-2016.10	Rear Axle Left & Right Upper	Hatchback 4WD MCXPA/MCXRA		Track Control Arm	S063035
	2013.08-2016.10	Front Axle Left & Right Upper	Hatchback 4WD MCXPA/MCXRA		Control Arm Bushing	510362
	2013.08-2016.10	Front Axle Left & Right Lower Inner	Hatchback 4WD MCXPA/MCXRA		Control Arm Bushing	531929
	2013.08-2016.10	Front Axle Left	Hatchback 4WD MCXPA/MCXRA		Tie Rod End	S071843
2013.08-2016.10	Front Axle Right	Hatchback 4WD MCXPA/MCXRA		Tie Rod End	S071842	
4.8 (368 kw)	2009.09-2013.12	Front Axle Left Lower	Hatchback 4WD M4870		Track Control Arm	S063038
	2009.09-2013.12	Front Axle Right Lower	Hatchback 4WD M4870		Track Control Arm	S063039
	2009.09-2013.12	Rear Axle Left & Right Centre	Hatchback 4WD M4870		Track Control Arm	S063036
	2009.09-2013.12	Rear Axle Left & Right Upper	Hatchback 4WD M4870		Track Control Arm	S063035
	2009.09-2013.12	Front Axle Left & Right Upper	Hatchback 4WD M4870		Control Arm Bushing	510362
	2009.09-2013.12	Front Axle Left	Hatchback 4WD M4870		Tie Rod End	S071843
	2009.09-2013.12	Front Axle Right	Hatchback 4WD M4870		Tie Rod End	S071842



	 YEAR	FITTING POSITION	BODY STYLE & DRIVE TYPE & ENGINE	REMARKS	PRODUCT	GSP Ref.
PORSCHE Panamera						
4.8 (382 kw)	2013.04-2016.10	Front Axle Left Lower	Hatchback 4WD MCWBA		Track Control Arm	S063038
	2013.04-2016.10	Front Axle Right Lower	Hatchback 4WD MCWBA		Track Control Arm	S063039
	2013.04-2016.10	Rear Axle Left & Right Centre	Hatchback 4WD MCWBA		Track Control Arm	S063036
	2013.04-2016.10	Rear Axle Left & Right Upper	Hatchback 4WD MCWBA		Track Control Arm	S063035
	2013.04-2016.10	Front Axle Left & Right Upper	Hatchback 4WD MCWBA		Control Arm Bushing	510362
	2013.04-2016.10	Front Axle Left & Right Lower Inner	Hatchback 4WD MCWBA		Control Arm Bushing	531929
	2013.04-2016.10	Front Axle Left	Hatchback 4WD MCWBA		Tie Rod End	S071843
	2013.04-2016.10	Front Axle Right	Hatchback 4WD MCWBA		Tie Rod End	S071842
RENAULT 19						
1.8 (101 kw)	1992.05-1995.12	Front Axle Left & Right Lower	Cabriolet FWD F7P704		Ball Joint	S080197
	1992.05-1995.12	Front Axle Left & Right Lower	Cabriolet FWD F7P704		Control Arm Bushing	532335
	1992.05-1995.12	Front Axle Left & Right	Cabriolet FWD F7P704		Tie Rod Axle Joint	S030259
	1992.05-1995.12	Front Axle Left	Cabriolet FWD F7P704		Tie Rod End	S070399
	1992.05-1995.12	Front Axle Right	Cabriolet FWD F7P704		Tie Rod End	S070400
	1992.05-1995.12	Front Axle	Cabriolet FWD F7P704		Steering Boot	540335
	1992.05-1995.12	Front Axle	Cabriolet FWD F7P704		Steering Rack Bellow Kit	540335S
21						
2.0 (76 kw)	1988.04-1989.06	Front Axle Left & Right Lower	Saloon FWD J6R792		Ball Joint	S080207
	1988.04-1989.06	Front Axle Left & Right	Saloon FWD J6R792		Tie Rod End	S070401
Clio						
1.0 (43 kw)	1999.09-2006.12	Front Axle Left Lower	Hatchback FWD D7D 760		Track Control Arm	S060646
	1999.09-2006.12	Front Axle Right Lower	Hatchback FWD D7D 760		Track Control Arm	S060645
	1999.09-2006.12	Front Axle Left & Right Lower	Hatchback FWD D7D 760		Ball Joint	S080174
	1999.09-2006.12	Front Axle Left & Right Lower	Hatchback FWD D7D 760		Control Arm Bushing	510761
	1999.09-2006.12	Front Axle Left & Right	Hatchback FWD D7D 760	Engine Code D7D 760:Date from 1999.12 for vehicles with power steering	Tie Rod Axle Joint	S030203
	1999.09-2006.12	Front Axle Left & Right	Hatchback FWD D7D 760	Engine Code D7D 760:Date from 1999.12 for vehicles without power steering	Tie Rod Axle Joint	S030206
	1999.09-2006.12	Front Axle Left & Right	Hatchback FWD D7D 760	Date to:1999.12 for vehicles without power steering	Tie Rod Axle Joint	S030242
	1999.09-2006.12	Front Axle Left & Right	Hatchback FWD D7D 760	Date to:1999.12 for vehicles with power steering	Tie Rod Axle Joint	S030243
	1999.09-2006.12	Front Axle Left & Right	Hatchback FWD D7D 760	Date to:1999.12 for vehicles with power steering	Tie Rod Axle Joint	S030247
	1999.09-2006.12	Front Axle Left & Right	Hatchback FWD D7D 760	Engine Code D7D 760:Date from 1999.12 for vehicles with power steering	Tie Rod Axle Joint	S030252
	1999.09-2006.12	Front Axle Left	Hatchback FWD D7D 760	Engine Code D7D 760:Date from 1999.12:Engine Code D7D 760	Tie Rod End	S070352
	1999.09-2006.12	Front Axle Left	Hatchback FWD D7D 760	Date to:1999.12	Tie Rod End	S070388
	1999.09-2006.12	Front Axle Right	Hatchback FWD D7D 760	Engine Code D7D 760:Date from 1999.12:Engine Code D7D 760	Tie Rod End	S070353
	1999.09-2006.12	Front Axle Right	Hatchback FWD D7D 760	Date to:1999.12	Tie Rod End	S070387
	1999.09-2006.12	Front Axle Left & Right	Hatchback FWD D7D 760		Rod/Strut,stabiliser	S050685
	1999.09-2006.12	Front Axle Left & Right Inner	Hatchback FWD D7D 760		Stabiliser Bushing	513713
	1999.09-2006.12	Front Axle Left & Right Inner	Hatchback FWD D7D 760		Stabiliser Bushing	513955
	1999.09-2006.12	Front Axle Left & Right Outer	Hatchback FWD D7D 760		Stabiliser Bushing	513956
	1999.09-2006.12	Front Axle	Hatchback FWD D7D 760	for vehicles with power steering, not for steering gear manufacturer TRW	Steering Rack Bellow Kit	540220S
1.6 (66 kw)	1998.09-2006.07	Front Axle Left Lower	Hatchback FWD K7M744/K7M745/K7M746		Track Control Arm	S060646
	1998.09-2006.07	Front Axle Right Lower	Hatchback FWD K7M744/K7M745/K7M746		Track Control Arm	S060645
	1998.09-2006.07	Front Axle Left & Right Lower	Hatchback FWD K7M744/K7M745/K7M746	Engine code K7M 745/K7M 746:Date to:2002.08:Engine code K7M 745/K7M 746	Ball Joint	S080174
	1998.09-2006.07	Front Axle Left & Right Lower	Hatchback FWD K7M744/K7M745/K7M746		Ball Joint	S080197
	1998.09-2006.07	Front Axle Left & Right Lower	Hatchback FWD K7M744/K7M745/K7M746		Control Arm Bushing	510761
	1998.09-2006.07	Front Axle Left & Right	Hatchback FWD K7M744/K7M745/K7M746		Tie Rod Axle Joint	S030203
	1998.09-2006.07	Front Axle Left & Right	Hatchback FWD K7M744/K7M745/K7M746	Date from:1999.12 for vehicles without power steering	Tie Rod Axle Joint	S030206
	1998.09-2006.07	Front Axle Left & Right	Hatchback FWD K7M744/K7M745/K7M746	Date to:1999.12 for vehicles without power steering	Tie Rod Axle Joint	S030242
	1998.09-2006.07	Front Axle Left & Right	Hatchback FWD K7M744/K7M745/K7M746	Date to:1999.12 for vehicles with power steering	Tie Rod Axle Joint	S030243
	1998.09-2006.07	Front Axle Left & Right	Hatchback FWD K7M744/K7M745/K7M746	Engine code K7M 745/K7M 746:Date from 1999.12 for vehicles with power steering	Tie Rod Axle Joint	S030247
	1998.09-2006.07	Front Axle Left & Right	Hatchback FWD K7M744/K7M745/K7M746	Engine code K7M 745/K7M 746:Date from 2000.01 for vehicles with power steering	Tie Rod Axle Joint	S030252
	1998.09-2006.07	Front Axle Left	Hatchback FWD K7M744/K7M745/K7M746	Engine code K7M 745/K7M 746:Date from 2000.01 for vehicles with power steering	Tie Rod End	S070352
	1998.09-2006.07	Front Axle Left	Hatchback FWD K7M744/K7M745/K7M746	Date to:1999.12	Tie Rod End	S070388
	1998.09-2006.07	Front Axle Right	Hatchback FWD K7M744/K7M745/K7M746	Engine code K7M 745/K7M 746:Date from 1999.12 for vehicles with power steering	Tie Rod End	S070353
	1998.09-2006.07	Front Axle Right	Hatchback FWD K7M744/K7M745/K7M746	Date to:1999.12	Tie Rod End	S070387
	1998.09-2006.07	Front Axle Left & Right	Hatchback FWD K7M744/K7M745/K7M746		Rod/Strut,stabiliser	510748
	1998.09-2006.07	Front Axle Left & Right	Hatchback FWD K7M744/K7M745/K7M746		Rod/Strut,stabiliser	S050685
	1998.09-2006.07	Front Axle Left & Right Inner	Hatchback FWD K7M744/K7M745/K7M746		Stabiliser Bushing	513713
	1998.09-2006.07	Front Axle Left & Right Inner	Hatchback FWD K7M744/K7M745/K7M746		Stabiliser Bushing	513955
	1998.09-2006.07	Front Axle Left & Right Outer	Hatchback FWD K7M744/K7M745/K7M746		Stabiliser Bushing	513956
	1998.09-2006.07	Front Axle Right	Hatchback FWD K7M744/K7M745/K7M746		Steering Boot	540333
	1998.09-2006.07	Front Axle Left	Hatchback FWD K7M744/K7M745/K7M746		Steering Rack Bellow Kit	540337S
	1998.09-2006.07	Front Axle	Hatchback FWD K7M744/K7M745/K7M746		Steering Rack Bellow Kit	540220S

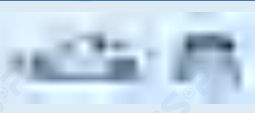

	 YEAR	FITTING POSITION	BODY STYLE & DRIVE TYPE & ENGINE	REMARKS	PRODUCT	GSP Ref.	
RENAULT							
Clio							
1.6 (73 kw)	1999.06-2003.04	Front Axle Left Lower	Hatchback FWD K7M 746		Track Control Arm	S060646	
	1999.06-2003.04	Front Axle Right Lower	Hatchback FWD K7M 746		Track Control Arm	S060645	
	1999.06-2003.04	Front Axle Left & Right Lower	Hatchback FWD K7M 746		Ball Joint	S080174	
	1999.06-2003.04	Front Axle Left & Right Lower	Hatchback FWD K7M 746		Control Arm Bushing	510761	
	1999.06-2003.04	Front Axle Left & Right	Hatchback FWD K7M 746	Date from: 1999.12, for vehicles with power steering	Tie Rod Axle Joint	S030203	
	1999.06-2003.04	Front Axle Left & Right	Hatchback FWD K7M 746	Date from: 1999.12, for vehicles without power steering	Tie Rod Axle Joint	S030206	
	1999.06-2003.04	Front Axle Left & Right	Hatchback FWD K7M 746	Date to: 1999.12, for vehicles without power steering	Tie Rod Axle Joint	S030242	
	1999.06-2003.04	Front Axle Left & Right	Hatchback FWD K7M 746	Date to: 1999.12, for vehicles with power steering	Tie Rod Axle Joint	S030243	
	1999.06-2003.04	Front Axle Left & Right	Hatchback FWD K7M 746	Date to: 1999.12, for vehicles with power steering	Tie Rod Axle Joint	S030247	
	1999.06-2003.04	Front Axle Left & Right	Hatchback FWD K7M 746	Date from: 1999.12, for vehicles with power steering	Tie Rod Axle Joint	S030252	
	1999.06-2003.04	Front Axle Left	Hatchback FWD K7M 746	Date from: 1999.12	Tie Rod End	S070352	
	1999.06-2003.04	Front Axle Left	Hatchback FWD K7M 746	Date to: 1999.12	Tie Rod End	S070388	
	1999.06-2003.04	Front Axle Right	Hatchback FWD K7M 746	Date from: 1999.12	Tie Rod End	S070353	
	1999.06-2003.04	Front Axle Right	Hatchback FWD K7M 746	Date to: 1999.12	Tie Rod End	S070387	
	1999.06-2003.04	Front Axle Left & Right	Hatchback FWD K7M 746		Rod/Strut, stabiliser	S050685	
	1999.06-2003.04	Front Axle Left & Right Inner	Hatchback FWD K7M 746		Stabiliser Bushing	513713	
	1999.06-2003.04	Front Axle Left & Right Inner	Hatchback FWD K7M 746		Stabiliser Bushing	513955	
	1999.06-2003.04	Front Axle Left & Right Outer	Hatchback FWD K7M 746		Stabiliser Bushing	513956	
	1999.06-2003.04	Front Axle	Hatchback FWD K7M 746	for vehicles with power steering, not for steering gear manufacturer TRW	Steering Rack Bellow Kit	540220S	
	1.6 (81 kw)	1999.06-2009.10	Front Axle Left Lower	Hatchback FWD K4M740		Track Control Arm	S060646
1999.06-2009.10		Front Axle Right Lower	Hatchback FWD K4M740		Track Control Arm	S060645	
1999.06-2009.10		Front Axle Left & Right Lower	Hatchback FWD K4M740		Ball Joint	S080174	
1999.06-2009.10		Front Axle Left & Right Lower	Hatchback FWD K4M740		Ball Joint	S080197	
1999.06-2009.10		Front Axle Left & Right Lower	Hatchback FWD K4M740		Control Arm Bushing	510761	
1999.06-2009.10		Front Axle Left & Right	Hatchback FWD K4M740	for vehicles with power steering	Tie Rod Axle Joint	S030203	
1999.06-2009.10		Front Axle Left & Right	Hatchback FWD K4M740	for vehicles without power steering	Tie Rod Axle Joint	S030206	
1999.06-2009.10		Front Axle Left & Right	Hatchback FWD K4M740	for vehicles without power steering	Tie Rod Axle Joint	S030242	
1999.06-2009.10		Front Axle Left & Right	Hatchback FWD K4M740	for vehicles with power steering	Tie Rod Axle Joint	S030243	
1999.06-2009.10		Front Axle Left & Right	Hatchback FWD K4M740	for vehicles with power steering	Tie Rod Axle Joint	S030247	
1999.06-2009.10		Front Axle Left & Right	Hatchback FWD K4M740	for vehicles with power steering	Tie Rod Axle Joint	S030252	
1999.06-2009.10		Front Axle Left	Hatchback FWD K4M740		Tie Rod End	S070352	
1999.06-2009.10		Front Axle Left	Hatchback FWD K4M740		Tie Rod End	S070388	
1999.06-2009.10		Front Axle Right	Hatchback FWD K4M740		Tie Rod End	S070353	
1999.06-2009.10		Front Axle Right	Hatchback FWD K4M740		Tie Rod End	S070387	
1999.06-2009.10		Front Axle Left & Right	Hatchback FWD K4M740		Rod/Strut, stabiliser	510748	
1999.06-2009.10		Front Axle Left & Right	Hatchback FWD K4M740		Rod/Strut, stabiliser	S050685	
1999.06-2009.10		Front Axle Left & Right	Hatchback FWD K4M740	Date to: 2008.09	Rod/Strut, stabiliser	S050685	
1999.06-2009.10		Front Axle Left & Right Inner	Hatchback FWD K4M740		Stabiliser Bushing	513713	
1999.06-2009.10		Front Axle Left & Right Inner	Hatchback FWD K4M740		Stabiliser Bushing	513955	
1999.06-2009.10		Front Axle Left & Right Outer	Hatchback FWD K4M740		Stabiliser Bushing	513956	
1999.06-2009.10		Front Axle Right	Hatchback FWD K4M740		Steering Boot	540333	
1999.06-2009.10		Front Axle	Hatchback FWD K4M740	for vehicles with power steering, not for steering gear manufacturer TRW	Steering Rack Bellow Kit	540220S	
Clio II/Lutecia							
1.0 (59 kw)		2012.11-2016.12	Front Axle Left Lower	Hatchback FWD D4D 752/D4D 754		Track Control Arm	S060646
		2012.11-2016.12	Front Axle Right Lower	Hatchback FWD D4D 752/D4D 754		Track Control Arm	S060645
		2012.11-2016.12	Front Axle Left & Right Lower	Hatchback FWD D4D 752/D4D 754		Ball Joint	S080174
	2012.11-2016.12	Front Axle Left & Right Lower	Hatchback FWD D4D 752/D4D 754		Control Arm Bushing	510761	
	2012.11-2016.12	Front Axle Left & Right	Hatchback FWD D4D 752/D4D 754	for vehicles with power steering	Tie Rod Axle Joint	S030203	
	2012.11-2016.12	Front Axle Left & Right	Hatchback FWD D4D 752/D4D 754	for vehicles without power steering	Tie Rod Axle Joint	S030206	
	2012.11-2016.12	Front Axle Left & Right	Hatchback FWD D4D 752/D4D 754	for vehicles with power steering	Tie Rod Axle Joint	S030252	
	2012.11-2016.12	Front Axle Left	Hatchback FWD D4D 752/D4D 754		Tie Rod End	S070352	
	2012.11-2016.12	Front Axle Right	Hatchback FWD D4D 752/D4D 754		Tie Rod End	S070353	
	2012.11-2016.12	Front Axle Left & Right	Hatchback FWD D4D 752/D4D 754		Rod/Strut, stabiliser	S050685	
	2012.11-2016.12	Front Axle Left & Right Inner	Hatchback FWD D4D 752/D4D 754		Stabiliser Bushing	513713	
	2012.11-2016.12	Front Axle Left & Right Inner	Hatchback FWD D4D 752/D4D 754		Stabiliser Bushing	513955	
	2012.11-2016.12	Front Axle Left & Right Outer	Hatchback FWD D4D 752/D4D 754		Stabiliser Bushing	513956	
	2012.11-2016.12	Front Axle Right	Hatchback FWD D4D 752/D4D 754		Steering Boot	540333	
	2012.11-2016.12	Front Axle	Hatchback FWD D4D 752/D4D 754	for vehicles with power steering, not for steering gear manufacturer TRW	Steering Rack Bellow Kit	540220S	
Clio Symbol							
1.6 (86 kw)	2004.04-2009.02	Front Axle Left & Right Lower	Saloon FWD K4M742/K4M743		Ball Joint	S080197	
	2004.04-2009.02	Front Axle Left & Right	Saloon FWD K4M742/K4M743		Tie Rod Axle Joint	S030203	
	2004.04-2009.02	Front Axle Left & Right	Saloon FWD K4M742/K4M743		Rod/Strut, stabiliser	S050685	
	2004.04-2009.02	Front Axle	Saloon FWD K4M742/K4M743		Steering Boot	540333	



	 YEAR	FITTING POSITION	BODY STYLE & DRIVE TYPE & ENGINE	REMARKS	PRODUCT	GSP Ref.
RENAULT						
Fluence						
ET (70 kw)	2012.02-	Front Axle Left Lower	Saloon FWD 5AM400		Track Control Arm	S060709
	2012.02-	Front Axle Right Lower	Saloon FWD 5AM400		Track Control Arm	S060708
	2012.02-	Front Axle Left & Right Lower	Saloon FWD 5AM400		Ball Joint	S080210
	2012.02-	Front Axle Left & Right Lower	Saloon FWD 5AM400		Control Arm Bushing	530889
	2012.02-	Front Axle Left & Right Lower	Saloon FWD 5AM400		Control Arm Bushing	530890
	2012.02-	Front Axle Left & Right	Saloon FWD 5AM400		Tie Rod Axle Joint	S030262
	2012.02-	Front Axle Left	Saloon FWD 5AM400		Tie Rod End	S070415
	2012.02-	Front Axle Right	Saloon FWD 5AM400		Tie Rod End	S070414
	2012.02-	Front Axle Left & Right	Saloon FWD 5AM400		Rod/Strut, stabiliser	S050917
	2012.02-	Front Axle	Saloon FWD 5AM400		Steering Boot	540285
	2012.02-	Front Axle	Saloon FWD 5AM400		Steering Rack Bellow Kit	540285S
Kangoo						
1.0 (50 kw)	2002.01-2007.01	Front Axle Left & Right Lower	MPV FWD D4D700/D4D720		Ball Joint	S080197
	2002.01-2007.01	Front Axle Left & Right	MPV FWD D4D700/D4D720		Tie Rod Axle Joint	S030935
1.6 (66 kw)	1999.09-2001.06	Front Axle Left Lower	MPV FWD K7M746		Track Control Arm	S060646
	1999.09-2001.06	Front Axle Right Lower	MPV FWD K7M746		Track Control Arm	S060645
	1999.09-2001.06	Front Axle Left & Right Lower	MPV FWD K7M746		Ball Joint	S080174
	1999.09-2001.06	Front Axle Left & Right Lower	MPV FWD K7M746		Ball Joint	S080197
	1999.09-2001.06	Front Axle Left & Right Lower	MPV FWD K7M746		Control Arm Bushing	510761
	1999.09-2001.06	Front Axle Left & Right	MPV FWD K7M746	for vehicles with power steering	Tie Rod Axle Joint	S030203
	1999.09-2001.06	Front Axle Left & Right	MPV FWD K7M746	for vehicles without power steering	Tie Rod Axle Joint	S030206
	1999.09-2001.06	Front Axle Left	MPV FWD K7M746		Tie Rod End	S070352
	1999.09-2001.06	Front Axle Right	MPV FWD K7M746		Tie Rod End	S070353
	1999.09-2001.06	Front Axle Left & Right	MPV FWD K7M746		Rod/Strut, stabiliser	S050685
	1999.09-2001.06	Front Axle Left & Right Inner	MPV FWD K7M746		Stabiliser Bushing	513955
Kangoo Express						
1.0 (43 kw)	2002.01-2007.01	Front Axle Left & Right Lower	MPV Van FWD D7D700		Ball Joint	S080197
	2002.01-2007.01	Front Axle Left & Right	MPV Van FWD D7D700		Tie Rod Axle Joint	S030935
1.0 (50 kw)	2002.01-2007.01	Front Axle Left & Right Lower	MPV Van FWD D4D700/D4D720		Ball Joint	S080197
	2002.01-2007.01	Front Axle Left & Right	MPV Van FWD D4D700/D4D720		Tie Rod Axle Joint	S030935
Laguna						
2.0 (102 kw)	1995.06-2001.03	Front Axle Left Lower	Hatchback FWD N7Q704		Track Control Arm	S060675
	1995.06-2001.03	Front Axle Right Lower	Hatchback FWD N7Q704		Track Control Arm	S060676
	1995.06-2001.03	Front Axle Left & Right Lower	Hatchback FWD N7Q704		Ball Joint	S080208
	1995.06-2001.03	Front Axle Left & Right Lower	Hatchback FWD N7Q704		Control Arm Bushing	511937
	1995.06-2001.03	Front Axle Left & Right Lower	Hatchback FWD N7Q704		Control Arm Bushing	512425
	1995.06-2001.03	Front Axle Left & Right	Hatchback FWD N7Q704		Tie Rod Axle Joint	S030261
	1995.06-2001.03	Front Axle Left	Hatchback FWD N7Q704		Tie Rod End	S070408
	1995.06-2001.03	Front Axle Right	Hatchback FWD N7Q704		Tie Rod End	S070409
	1995.06-2001.03	Front Axle Left & Right	Hatchback FWD N7Q704		Rod/Strut, stabiliser	S100112
	1995.09-2001.02	Front Axle Left & Right Lower	Hatchback FWD F4R780		Ball Joint	S080208
	1995.09-2001.02	Front Axle Left & Right Lower	Hatchback FWD F4R780		Control Arm Bushing	511937
	1995.09-2001.02	Front Axle Left & Right Lower	Hatchback FWD F4R780		Control Arm Bushing	512425
	1995.09-2001.02	Front Axle Left	Hatchback FWD F4R780		Tie Rod End	S070408
	1995.09-2001.02	Front Axle Left & Right	Hatchback FWD F4R780		Rod/Strut, stabiliser	S100112
2.9 (140 kw)	1997.04-2001.03	Front Axle Left Lower	Hatchback FWD L7X700/L7X701		Track Control Arm	S060675
	1997.04-2001.03	Front Axle Right Lower	Hatchback FWD L7X700/L7X701		Track Control Arm	S060676
	1997.04-2001.03	Front Axle Left & Right Lower	Hatchback FWD L7X700/L7X701		Ball Joint	S080208
	1997.04-2001.03	Front Axle Left & Right Lower	Hatchback FWD L7X700/L7X701		Control Arm Bushing	511937
	1997.04-2001.03	Front Axle Left & Right Lower	Hatchback FWD L7X700/L7X701		Control Arm Bushing	512425
	1997.04-2001.03	Front Axle Left & Right	Hatchback FWD L7X700/L7X701		Tie Rod Axle Joint	S030261
	1997.04-2001.03	Front Axle Left	Hatchback FWD L7X700/L7X701		Tie Rod End	S070408
	1997.04-2001.03	Front Axle Right	Hatchback FWD L7X700/L7X701		Tie Rod End	S070409
	1997.04-2001.03	Front Axle Left & Right	Hatchback FWD L7X700/L7X701		Rod/Strut, stabiliser	S100112
2.9 (152 kw)	2001.03-2007.08	Front Axle Left Lower	Hatchback FWD L7X731		Track Control Arm	S060693
	2001.03-2007.08	Front Axle Right Lower	Hatchback FWD L7X731		Track Control Arm	S060692
	2001.03-2007.08	Front Axle Left & Right Lower	Hatchback FWD L7X731		Ball Joint	S080173
	2001.03-2007.08	Front Axle Left & Right Lower	Hatchback FWD L7X731		Control Arm Bushing	510740
	2001.03-2007.08	Front Axle Left & Right Lower	Hatchback FWD L7X731		Control Arm Bushing	510741
	2001.03-2007.08	Front Axle	Hatchback FWD L7X731		Suspension Repair Kit	S990060SK
	2001.03-2007.08	Front Axle Left & Right	Hatchback FWD L7X731		Tie Rod Axle Joint	S030246
	2001.03-2007.08	Front Axle Left	Hatchback FWD L7X731		Tie Rod End	S070357
	2001.03-2007.08	Front Axle Right	Hatchback FWD L7X731		Tie Rod End	S070356
	2001.03-2007.08	Front Axle Left & Right	Hatchback FWD L7X731		Rod/Strut, stabiliser	S050365



	 YEAR	FITTING POSITION	BODY STYLE & DRIVE TYPE & ENGINE	REMARKS	PRODUCT	GSP Ref.	
RENAULT Laguna							
2.9 (152 kw)	2001.03-2007.08	Front Axle	Hatchback FWD L7X731		Steering Boot	540202	
	2001.03-2007.08	Front Axle	Hatchback FWD L7X731	Engine Code:L7X 731	Steering Rack Bellow Kit	540202S	
3.0 (123 kw)	1993.11-2001.03	Front Axle Left Lower	Hatchback FWD Z7X760/Z7X765/Z7X767		Track Control Arm	S060675	
	1993.11-2001.03	Front Axle Right Lower	Hatchback FWD Z7X760/Z7X765/Z7X767		Track Control Arm	S060676	
	1993.11-2001.03	Front Axle Left & Right Lower	Hatchback FWD Z7X760/Z7X765/Z7X767		Ball Joint	S080208	
	1993.11-2001.03	Front Axle Left & Right Lower	Hatchback FWD Z7X760/Z7X765/Z7X767		Control Arm Bushing	511937	
	1993.11-2001.03	Front Axle Left & Right Lower	Hatchback FWD Z7X760/Z7X765/Z7X767		Control Arm Bushing	512425	
	1993.11-2001.03	Front Axle Left & Right	Hatchback FWD Z7X760/Z7X765/Z7X767		Tie Rod Axle Joint	S030261	
	1993.11-2001.03	Front Axle Left	Hatchback FWD Z7X760/Z7X765/Z7X767		Tie Rod End	S070408	
	1993.11-2001.03	Front Axle Right	Hatchback FWD Z7X760/Z7X765/Z7X767		Tie Rod End	S070409	
	1993.11-2001.03	Front Axle Left & Right	Hatchback FWD Z7X760/Z7X765/Z7X767		Rod/Strut, stabiliser	S100112	
3.5 (177 kw)	2008.09-2011.12	Front Axle Left & Right	Coupe FWD V4Y 713		Tie Rod Axle Joint	S031111	
Laguna Estate/Break							
2.0 (102 kw)	1995.06-2001.02	Front Axle Left Lower	Estate FWD N7Q700/N7Q704		Track Control Arm	S060675	
	1995.06-2001.02	Front Axle Right Lower	Estate FWD N7Q700/N7Q704		Track Control Arm	S060676	
	1995.06-2001.02	Front Axle Left & Right Lower	Estate FWD N7Q700/N7Q704		Ball Joint	S080208	
	1995.06-2001.02	Front Axle Left & Right Lower	Estate FWD N7Q700/N7Q704		Control Arm Bushing	511937	
	1995.06-2001.02	Front Axle Left & Right Lower	Estate FWD N7Q700/N7Q704		Control Arm Bushing	512425	
	1995.06-2001.02	Front Axle Left & Right	Estate FWD N7Q700/N7Q704		Tie Rod Axle Joint	S030261	
	1995.06-2001.02	Front Axle Left	Estate FWD N7Q700/N7Q704		Tie Rod End	S070408	
	1995.06-2001.02	Front Axle Right	Estate FWD N7Q700/N7Q704		Tie Rod End	S070409	
	1995.06-2001.02	Front Axle Left & Right	Estate FWD N7Q700/N7Q704		Rod/Strut, stabiliser	S100112	
2.9 (152 kw)	2001.03-2007.12	Front Axle Left Lower	Estate FWD L7X731/L7X733		Track Control Arm	S060693	
	2001.03-2007.12	Front Axle Right Lower	Estate FWD L7X731/L7X733		Track Control Arm	S060692	
	2001.03-2007.12	Front Axle Left & Right Lower	Estate FWD L7X731/L7X733		Ball Joint	S080173	
	2001.03-2007.12	Front Axle Left & Right Lower	Estate FWD L7X731/L7X733		Control Arm Bushing	510740	
	2001.03-2007.12	Front Axle Left & Right Lower	Estate FWD L7X731/L7X733		Control Arm Bushing	510741	
	2001.03-2007.12	Front Axle	Estate FWD L7X731/L7X733		Suspension Repair Kit	S990060SK	
	2001.03-2007.12	Front Axle Left & Right	Estate FWD L7X731/L7X733		Tie Rod Axle Joint	S030246	
	2001.03-2007.12	Front Axle Left	Estate FWD L7X731/L7X733		Tie Rod End	S070357	
	2001.03-2007.12	Front Axle Right	Estate FWD L7X731/L7X733		Tie Rod End	S070356	
	2001.03-2007.12	Front Axle Left & Right	Estate FWD L7X731/L7X733		Rod/Strut, stabiliser	S050365	
	2001.03-2007.12	Front Axle	Estate FWD L7X731/L7X733		Steering Boot	540202	
2001.03-2007.12	Front Axle	Estate FWD L7X731/L7X733	Engine Code:L7X 731	Steering Rack Bellow Kit	540202S		
Master T28							
2.3 (96 kw)	2015.07-	Front Axle Left Lower	VAN FWD M9T704		Track Control Arm	S063224	
	2015.07-	Front Axle Right Lower	VAN FWD M9T704		Track Control Arm	S063223	
	2015.07-	Front Axle Left Lower	VAN FWD M9T704		Ball Joint	S080650	
	2015.07-	Front Axle Right Lower	VAN FWD M9T704		Ball Joint	S080666	
	2015.07-	Front Axle Left	VAN FWD M9T704		Tie Rod End	S071053	
	2015.07-	Front Axle Right	VAN FWD M9T704		Tie Rod End	S071054	
	2015.07-	Front Axle Left & Right	VAN FWD M9T704		Rod/Strut, stabiliser	S050796	
	2015.07-	Rear Axle Left & Right	VAN FWD M9T704		Rod/Strut, stabiliser	S051255	
2.5 (84 kw)	2001.10-2007.09	Front Axle Left Lower	VAN FWD G9U720/G9U724/G9U750	Engine code:G9U 720, G9U 724, G9U 750, Date to:2007, Engine code:G9U 720, G9U 724, G9U 750	Track Control Arm	S060647	
	2001.10-2007.09	Front Axle Left Lower	VAN FWD G9U720/G9U724/G9U750	Engine Code:G9U 720, G9U 724, G9U 750, Date to:2007, Engine Code:G9U 720, G9U 724, G9U 750	Track Control Arm	S060873	
	2001.10-2007.09	Front Axle Right Lower	VAN FWD G9U720/G9U724/G9U750	Date to:2007.09	Track Control Arm	S060648	
	2001.10-2007.09	Front Axle Right Lower	VAN FWD G9U720/G9U724/G9U750	Date from:2007.09	Track Control Arm	S060874	
	2001.10-2007.09	Front Axle Left & Right Lower	VAN FWD G9U720/G9U724/G9U750	Engine code:G9U 720, G9U 724, G9U 750, Engine code:G9U 720, G9U 724, G9U 750, Date to:2007.09	Ball Joint	S080171	
	2001.10-2007.09	Front Axle Left & Right Lower	VAN FWD G9U720/G9U724/G9U750	Engine code:G9U 724, Engine code:G9U 750, Date from:2007.09	Ball Joint	S080176	
	2001.10-2007.09	Front Axle Left & Right Upper	VAN FWD G9U720/G9U724/G9U750		Ball Joint	S080172	
	2001.10-2007.09	Front Axle Left & Right Upper	VAN FWD G9U720/G9U724/G9U750		Ball Joint	S080334	
	2001.10-2007.09	Front Axle Left & Right Lower	VAN FWD G9U720/G9U724/G9U750		Control Arm Bushing	511223	
	2001.10-2007.09	Front Axle Left & Right Lower	VAN FWD G9U720/G9U724/G9U750		Control Arm Bushing	511224	
	2001.10-2007.09	Front Axle	VAN FWD G9U720/G9U724/G9U750		Suspension Repair Kit	S990048SK	
	2001.10-2007.09	Front Axle Left & Right	VAN FWD G9U720/G9U724/G9U750		Tie Rod Axle Joint	S030204	
	2001.10-2007.09	Front Axle Left	VAN FWD G9U720/G9U724/G9U750		Tie Rod End	S070354	
	2001.10-2007.09	Front Axle Right	VAN FWD G9U720/G9U724/G9U750		Tie Rod End	S070355	
	2001.10-2007.09	Front Axle Left	VAN FWD G9U720/G9U724/G9U750		Rod/Strut, stabiliser	S050363	
	2001.10-2007.09	Front Axle Right	VAN FWD G9U720/G9U724/G9U750		Rod/Strut, stabiliser	S050364	
	2001.10-2007.09	Front Axle	VAN FWD G9U720/G9U724/G9U750		Steering Boot	540075	
	2001.10-2007.09	Front Axle	VAN FWD G9U720/G9U724/G9U750		Steering Rack Bellow Kit	540075S	
	2.8 (84 kw)	1998.07-2001.10	Front Axle Left Lower	VAN FWD S9W700/S9W702		Track Control Arm	S060647
		1998.07-2001.10	Front Axle Left Lower	VAN FWD S9W700/S9W702		Track Control Arm	S060873
1998.07-2001.10		Front Axle Right Lower	VAN FWD S9W700/S9W702		Track Control Arm	S060648	



	 YEAR	FITTING POSITION	BODY STYLE & DRIVE TYPE & ENGINE	REMARKS	PRODUCT	GSP Ref.	
RENAULT Master T28 2.8 (84 kw)	1998.07-2001.10	Front Axle Left & Right Lower	VAN FWD S9W700/S9W702		Ball Joint	S080171	
	1998.07-2001.10	Front Axle Left & Right Upper	VAN FWD S9W700/S9W702		Ball Joint	S080172	
	1998.07-2001.10	Front Axle Left & Right Upper	VAN FWD S9W700/S9W702		Ball Joint	S080334	
	1998.07-2001.10	Front Axle Left & Right Lower	VAN FWD S9W700/S9W702		Control Arm Bushing	511223	
	1998.07-2001.10	Front Axle Left & Right Lower	VAN FWD S9W700/S9W702		Control Arm Bushing	511224	
	1998.07-2001.10	Front Axle Left & Right	VAN FWD S9W700/S9W702		Tie Rod Axle Joint	S030204	
	1998.07-2001.10	Front Axle Left	VAN FWD S9W700/S9W702		Tie Rod End	S070354	
	1998.07-2001.10	Front Axle Right	VAN FWD S9W700/S9W702		Tie Rod End	S070355	
	1998.07-2001.10	Front Axle Left	VAN FWD S9W700/S9W702		Rod/Strut, stabiliser	S050363	
	1998.07-2001.10	Front Axle Right	VAN FWD S9W700/S9W702		Rod/Strut, stabiliser	S050364	
	1998.07-2001.10	Front Axle	VAN FWD S9W700/S9W702		Steering Rack Bellow Kit	540075S	
	1998.07-2002.09	Front Axle Left Lower	BUS FWD S9W700		Track Control Arm	S060647	
	1998.07-2002.09	Front Axle Left Lower	BUS FWD S9W700		Track Control Arm	S060873	
	1998.07-2002.09	Front Axle Right Lower	BUS FWD S9W700		Track Control Arm	S060648	
	1998.07-2002.09	Front Axle Left & Right Lower	BUS FWD S9W700		Ball Joint	S080171	
	1998.07-2002.09	Front Axle Left & Right Upper	BUS FWD S9W700		Ball Joint	S080172	
	1998.07-2002.09	Front Axle Left & Right Upper	BUS FWD S9W700		Ball Joint	S080334	
	1998.07-2002.09	Front Axle Left & Right Lower	BUS FWD S9W700		Control Arm Bushing	511223	
	1998.07-2002.09	Front Axle Left & Right Lower	BUS FWD S9W700		Control Arm Bushing	511224	
	1998.07-2002.09	Front Axle Left & Right	BUS FWD S9W700		Tie Rod Axle Joint	S030204	
	1998.07-2002.09	Front Axle Left	BUS FWD S9W700		Tie Rod End	S070354	
	1998.07-2002.09	Front Axle Right	BUS FWD S9W700		Tie Rod End	S070355	
	1998.07-2002.09	Front Axle Left & Right	BUS FWD S9W700		Tie Rod End	S070824	
	1998.07-2002.09	Front Axle Left & Right	BUS FWD S9W700		Tie Rod End	S070866	
	1998.07-2002.09	Front Axle Left	BUS FWD S9W700		Rod/Strut, stabiliser	S050363	
	1998.07-2002.09	Front Axle Right	BUS FWD S9W700		Rod/Strut, stabiliser	S050364	
	1998.07-2002.09	Front Axle	BUS FWD S9W700		Steering Rack Bellow Kit	540075S	
	Master T33 2.3 (96 kw)	2015.07-	Front Axle Left Lower	VAN FWD M9T704		Track Control Arm	S063224
		2015.07-	Front Axle Right Lower	VAN FWD M9T704		Track Control Arm	S063223
		2015.07-	Front Axle Left Lower	VAN FWD M9T704		Ball Joint	S080650
		2015.07-	Front Axle Right Lower	VAN FWD M9T704		Ball Joint	S080666
		2015.07-	Front Axle Left	VAN FWD M9T704		Tie Rod End	S071053
		2015.07-	Front Axle Right	VAN FWD M9T704		Tie Rod End	S071054
		2015.07-	Front Axle Left & Right	VAN FWD M9T704		Rod/Strut, stabiliser	S050796
		2015.07-	Rear Axle Left & Right	VAN FWD M9T704		Rod/Strut, stabiliser	S051255
2.5 (84 kw)	2001.10-2007.09	Front Axle Left Lower	VAN FWD G9U720/G9U724/G9U750	<small>Engine code: 59U 705, 59U 706, 59U 708, 59U 709, 59U 710, 59U 711, 59U 712, 59U 713, 59U 714, 59U 715, 59U 716, 59U 717, 59U 718, 59U 719, 59U 720, 59U 721, 59U 722, 59U 723, 59U 724, 59U 725, 59U 726, 59U 727, 59U 728, 59U 729, 59U 730, 59U 731, 59U 732, 59U 733, 59U 734, 59U 735, 59U 736, 59U 737, 59U 738, 59U 739, 59U 740, 59U 741, 59U 742, 59U 743, 59U 744, 59U 745, 59U 746, 59U 747, 59U 748, 59U 749, 59U 750</small>	Track Control Arm	S060647	
	2001.10-2007.09	Front Axle Left Lower	VAN FWD G9U720/G9U724/G9U750	<small>Engine Code: 59U 705, 59U 706, 59U 708, 59U 709, 59U 710, 59U 711, 59U 712, 59U 713, 59U 714, 59U 715, 59U 716, 59U 717, 59U 718, 59U 719, 59U 720, 59U 721, 59U 722, 59U 723, 59U 724, 59U 725, 59U 726, 59U 727, 59U 728, 59U 729, 59U 730, 59U 731, 59U 732, 59U 733, 59U 734, 59U 735, 59U 736, 59U 737, 59U 738, 59U 739, 59U 740, 59U 741, 59U 742, 59U 743, 59U 744, 59U 745, 59U 746, 59U 747, 59U 748, 59U 749, 59U 750</small>	Track Control Arm	S060873	
	2001.10-2007.09	Front Axle Right Lower	VAN FWD G9U720/G9U724/G9U750	Date to: 2007.09	Track Control Arm	S060648	
	2001.10-2007.09	Front Axle Right Lower	VAN FWD G9U720/G9U724/G9U750	Date from: 2007.09	Track Control Arm	S060874	
	2001.10-2007.09	Front Axle Left & Right Lower	VAN FWD G9U720/G9U724/G9U750	<small>Engine code: 59U 705, 59U 706, 59U 708, 59U 709, 59U 710, 59U 711, 59U 712, 59U 713, 59U 714, 59U 715, 59U 716, 59U 717, 59U 718, 59U 719, 59U 720, 59U 721, 59U 722, 59U 723, 59U 724, 59U 725, 59U 726, 59U 727, 59U 728, 59U 729, 59U 730, 59U 731, 59U 732, 59U 733, 59U 734, 59U 735, 59U 736, 59U 737, 59U 738, 59U 739, 59U 740, 59U 741, 59U 742, 59U 743, 59U 744, 59U 745, 59U 746, 59U 747, 59U 748, 59U 749, 59U 750</small>	Ball Joint	S080171	
	2001.10-2007.09	Front Axle Left & Right Lower	VAN FWD G9U720/G9U724/G9U750	<small>Engine code: 59U 724. Engine code: 59U 750. Date from: 2007.09</small>	Ball Joint	S080176	
	2001.10-2007.09	Front Axle Left & Right Upper	VAN FWD G9U720/G9U724/G9U750		Ball Joint	S080172	
	2001.10-2007.09	Front Axle Left & Right Upper	VAN FWD G9U720/G9U724/G9U750		Ball Joint	S080334	
	2001.10-2007.09	Front Axle Left & Right Lower	VAN FWD G9U720/G9U724/G9U750		Control Arm Bushing	511223	
	2001.10-2007.09	Front Axle Left & Right Lower	VAN FWD G9U720/G9U724/G9U750		Control Arm Bushing	511224	
	2001.10-2007.09	Front Axle	VAN FWD G9U720/G9U724/G9U750		Suspension Repair Kit	S990048SK	
	2001.10-2007.09	Front Axle Left & Right	VAN FWD G9U720/G9U724/G9U750		Tie Rod Axle Joint	S030204	
	2001.10-2007.09	Front Axle Left	VAN FWD G9U720/G9U724/G9U750		Tie Rod End	S070354	
	2001.10-2007.09	Front Axle Right	VAN FWD G9U720/G9U724/G9U750		Tie Rod End	S070355	
	2001.10-2007.09	Front Axle Left	VAN FWD G9U720/G9U724/G9U750		Rod/Strut, stabiliser	S050363	
	2001.10-2007.09	Front Axle Right	VAN FWD G9U720/G9U724/G9U750		Rod/Strut, stabiliser	S050364	
	2001.10-2007.09	Front Axle	VAN FWD G9U720/G9U724/G9U750		Steering Boot	540075	
	2001.10-2007.09	Front Axle	VAN FWD G9U720/G9U724/G9U750		Steering Rack Bellow Kit	540075S	
	2.8 (84 kw)	1998.07-2001.10	Front Axle Left Lower	VAN FWD S9W700/S9W702		Track Control Arm	S060647
		1998.07-2001.10	Front Axle Left Lower	VAN FWD S9W700/S9W702		Track Control Arm	S060873
		1998.07-2001.10	Front Axle Right Lower	VAN FWD S9W700/S9W702		Track Control Arm	S060648
		1998.07-2001.10	Front Axle Left & Right Lower	VAN FWD S9W700/S9W702		Ball Joint	S080171
		1998.07-2001.10	Front Axle Left & Right Upper	VAN FWD S9W700/S9W702		Ball Joint	S080172
1998.07-2001.10		Front Axle Left & Right Upper	VAN FWD S9W700/S9W702		Ball Joint	S080334	
1998.07-2001.10		Front Axle Left & Right Lower	VAN FWD S9W700/S9W702		Control Arm Bushing	511223	
1998.07-2001.10		Front Axle Left & Right Lower	VAN FWD S9W700/S9W702		Control Arm Bushing	511224	
1998.07-2001.10		Front Axle Left & Right	VAN FWD S9W700/S9W702		Tie Rod Axle Joint	S030204	
1998.07-2001.10		Front Axle Left	VAN FWD S9W700/S9W702		Tie Rod End	S070354	



	 YEAR	FITTING POSITION	BODY STYLE & DRIVE TYPE & ENGINE	REMARKS	PRODUCT	GSP Ref.	
RENAULT							
Master T33							
2.8 (84 kw)	1998.07-2001.10	Front Axle Right	VAN FWD S9W700/S9W702		Tie Rod End	S070355	
	1998.07-2001.10	Front Axle Left	VAN FWD S9W700/S9W702		Rod/Strut,stabiliser	S050363	
	1998.07-2001.10	Front Axle Right	VAN FWD S9W700/S9W702		Rod/Strut,stabiliser	S050364	
	1998.07-2001.10	Front Axle	VAN FWD S9W700/S9W702		Steering Rack Bellow Kit	540075S	
Master T35							
2.3 (96 kw)	2015.07-	Front Axle Left Lower	VAN FWD M9T704		Track Control Arm	S063224	
	2015.07-	Front Axle Right Lower	VAN FWD M9T704		Track Control Arm	S063223	
	2015.07-	Front Axle Left Lower	VAN FWD M9T704		Ball Joint	S080650	
	2015.07-	Front Axle Right Lower	VAN FWD M9T704		Ball Joint	S080666	
	2015.07-	Front Axle Left	VAN FWD M9T704		Tie Rod End	S071053	
	2015.07-	Front Axle Right	VAN FWD M9T704		Tie Rod End	S071054	
	2015.07-	Front Axle Left & Right	VAN FWD M9T704		Rod/Strut,stabiliser	S050796	
	2015.07-	Rear Axle Left & Right	VAN FWD M9T704		Rod/Strut,stabiliser	S051255	
2.5 (84 kw)	2001.10-2013.12	Front Axle Left Lower	VAN FWD G9U720/G9U724/G9U750	<small>Engine code: G9U 720, G9U 724, G9U 750, G9U 724, G9U 750, G9U 724, G9U 750</small>	Track Control Arm	S060647	
	2001.10-2013.12	Front Axle Left Lower	VAN FWD G9U720/G9U724/G9U750	<small>Engine Code: G9U 720, G9U 724, G9U 750, G9U 724, G9U 750, G9U 724, G9U 750</small>	Track Control Arm	S060873	
	2001.10-2013.12	Front Axle Right Lower	VAN FWD G9U720/G9U724/G9U750	<small>Date to:2007.09</small>	Track Control Arm	S060648	
	2001.10-2013.12	Front Axle Right Lower	VAN FWD G9U720/G9U724/G9U750	<small>Date from:2007.09</small>	Track Control Arm	S060874	
	2001.10-2013.12	Front Axle Left & Right Lower	VAN FWD G9U720/G9U724/G9U750	<small>Engine code: G9U 720, G9U 724, G9U 750, G9U 724, G9U 750, G9U 724, G9U 750</small>	Ball Joint	S080171	
	2001.10-2013.12	Front Axle Left & Right Lower	VAN FWD G9U720/G9U724/G9U750	<small>Engine code: G9U 724, G9U 750, G9U 724, G9U 750, G9U 724, G9U 750</small>	Ball Joint	S080176	
	2001.10-2013.12	Front Axle Left & Right Upper	VAN FWD G9U720/G9U724/G9U750	<small>Engine code: G9U 724, G9U 750, G9U 724, G9U 750, G9U 724, G9U 750</small>	Ball Joint	S080172	
	2001.10-2013.12	Front Axle Left & Right Upper	VAN FWD G9U720/G9U724/G9U750	<small>Engine code: G9U 724, G9U 750, G9U 724, G9U 750, G9U 724, G9U 750</small>	Ball Joint	S080334	
	2001.10-2013.12	Front Axle Left & Right Lower	VAN FWD G9U720/G9U724/G9U750		Control Arm Bushing	511223	
	2001.10-2013.12	Front Axle Left & Right Lower	VAN FWD G9U720/G9U724/G9U750		Control Arm Bushing	511224	
	2001.10-2013.12	Front Axle	VAN FWD G9U720/G9U724/G9U750		Suspension Repair Kit	S990048SK	
	2001.10-2013.12	Front Axle Left & Right	VAN FWD G9U720/G9U724/G9U750		Tie Rod Axle Joint	S030204	
	2001.10-2013.12	Front Axle Left	VAN FWD G9U720/G9U724/G9U750		Tie Rod End	S070354	
	2001.10-2013.12	Front Axle Right	VAN FWD G9U720/G9U724/G9U750		Tie Rod End	S070355	
	2001.10-2013.12	Front Axle Left	VAN FWD G9U720/G9U724/G9U750		Rod/Strut,stabiliser	S050363	
	2001.10-2013.12	Front Axle Right	VAN FWD G9U720/G9U724/G9U750		Rod/Strut,stabiliser	S050364	
	2001.10-2013.12	Front Axle	VAN FWD G9U720/G9U724/G9U750		Steering Boot	540075	
	2001.10-2013.12	Front Axle	VAN FWD G9U720/G9U724/G9U750		Steering Rack Bellow Kit	540075S	
	2.8 (84 kw)	1998.07-2001.10	Front Axle Left Lower	Platform/Chassis FWD S9W700/S9W702		Track Control Arm	S060647
		1998.07-2001.10	Front Axle Left Lower	VAN FWD S9W700/S9W702		Track Control Arm	S060647
1998.07-2001.10		Front Axle Left Lower	Platform/Chassis FWD S9W700/S9W702		Track Control Arm	S060873	
1998.07-2001.10		Front Axle Left Lower	VAN FWD S9W700/S9W702		Track Control Arm	S060873	
1998.07-2001.10		Front Axle Right Lower	Platform/Chassis FWD S9W700/S9W702		Track Control Arm	S060648	
1998.07-2001.10		Front Axle Right Lower	VAN FWD S9W700/S9W702		Track Control Arm	S060648	
1998.07-2001.10		Front Axle Left & Right Lower	Platform/Chassis FWD S9W700/S9W702		Ball Joint	S080171	
1998.07-2001.10		Front Axle Left & Right Lower	VAN FWD S9W700/S9W702		Ball Joint	S080171	
1998.07-2001.10		Front Axle Left & Right Upper	Platform/Chassis FWD S9W700/S9W702		Ball Joint	S080172	
1998.07-2001.10		Front Axle Left & Right Upper	VAN FWD S9W700/S9W702		Ball Joint	S080172	
1998.07-2001.10		Front Axle Left & Right Upper	Platform/Chassis FWD S9W700/S9W702		Ball Joint	S080334	
1998.07-2001.10		Front Axle Left & Right Upper	VAN FWD S9W700/S9W702		Ball Joint	S080334	
1998.07-2001.10		Front Axle Left & Right Lower	Platform/Chassis FWD S9W700/S9W702		Control Arm Bushing	511223	
1998.07-2001.10		Front Axle Left & Right Lower	VAN FWD S9W700/S9W702		Control Arm Bushing	511223	
1998.07-2001.10		Front Axle Left & Right Lower	Platform/Chassis FWD S9W700/S9W702		Control Arm Bushing	511224	
1998.07-2001.10		Front Axle Left & Right Lower	VAN FWD S9W700/S9W702		Control Arm Bushing	511224	
1998.07-2001.10		Front Axle Left & Right	Platform/Chassis FWD S9W700/S9W702		Tie Rod Axle Joint	S030204	
1998.07-2001.10		Front Axle Left & Right	VAN FWD S9W700/S9W702		Tie Rod Axle Joint	S030204	
1998.07-2001.10		Front Axle Left	Platform/Chassis FWD S9W700/S9W702		Tie Rod End	S070354	
1998.07-2001.10		Front Axle Left	VAN FWD S9W700/S9W702		Tie Rod End	S070354	
1998.07-2001.10		Front Axle Right	Platform/Chassis FWD S9W700/S9W702		Tie Rod End	S070355	
1998.07-2001.10		Front Axle Right	VAN FWD S9W700/S9W702		Tie Rod End	S070355	
1998.07-2001.10		Front Axle Left	Platform/Chassis FWD S9W700/S9W702		Rod/Strut,stabiliser	S050363	
1998.07-2001.10		Front Axle Left	VAN FWD S9W700/S9W702		Rod/Strut,stabiliser	S050363	
1998.07-2001.10		Front Axle Right	Platform/Chassis FWD S9W700/S9W702		Rod/Strut,stabiliser	S050364	
1998.07-2001.10		Front Axle Right	VAN FWD S9W700/S9W702		Rod/Strut,stabiliser	S050364	
1998.07-2001.10		Front Axle	Platform/Chassis FWD S9W700/S9W702		Steering Rack Bellow Kit	540075S	
1998.07-2001.10		Front Axle	VAN FWD S9W700/S9W702		Steering Rack Bellow Kit	540075S	
1998.07-2002.09		Front Axle Left Lower	BUS FWD S9W700		Track Control Arm	S060647	
1998.07-2002.09		Front Axle Left Lower	BUS FWD S9W700		Track Control Arm	S060873	
1998.07-2002.09		Front Axle Right Lower	BUS FWD S9W700		Track Control Arm	S060648	
1998.07-2002.09		Front Axle Left & Right Lower	BUS FWD S9W700		Ball Joint	S080171	
1998.07-2002.09		Front Axle Left & Right Upper	BUS FWD S9W700		Ball Joint	S080172	



	 YEAR	FITTING POSITION	BODY STYLE & DRIVE TYPE & ENGINE	REMARKS	PRODUCT	GSP Ref.
RENAULT						
Master T35						
2.8 (84 kw)	1998.07-2002.09	Front Axle Left & Right Upper	BUS FWD S9W700		Ball Joint	S080334
	1998.07-2002.09	Front Axle Left & Right Lower	BUS FWD S9W700		Control Arm Bushing	511223
	1998.07-2002.09	Front Axle Left & Right Lower	BUS FWD S9W700		Control Arm Bushing	511224
	1998.07-2002.09	Front Axle Left & Right	BUS FWD S9W700		Tie Rod Axle Joint	S030204
	1998.07-2002.09	Front Axle Left	BUS FWD S9W700		Tie Rod End	S070354
	1998.07-2002.09	Front Axle Right	BUS FWD S9W700		Tie Rod End	S070355
	1998.07-2002.09	Front Axle Left & Right	BUS FWD S9W700		Tie Rod End	S070824
	1998.07-2002.09	Front Axle Left & Right	BUS FWD S9W700		Tie Rod End	S070866
	1998.07-2002.09	Front Axle Left	BUS FWD S9W700		Rod/Strut,stabiliser	S050363
	1998.07-2002.09	Front Axle Right	BUS FWD S9W700		Rod/Strut,stabiliser	S050364
	1998.07-2002.09	Front Axle	BUS FWD S9W700		Steering Rack Bellow Kit	540075S
Master T39						
2.8 (84 kw)	1998.07-2002.09	Front Axle Left Lower	BUS FWD S9W700		Track Control Arm	S060647
	1998.07-2002.09	Front Axle Left Lower	BUS FWD S9W700		Track Control Arm	S060873
	1998.07-2002.09	Front Axle Right Lower	BUS FWD S9W700		Track Control Arm	S060648
	1998.07-2002.09	Front Axle Left & Right Lower	BUS FWD S9W700		Ball Joint	S080171
	1998.07-2002.09	Front Axle Left & Right Upper	BUS FWD S9W700		Ball Joint	S080172
	1998.07-2002.09	Front Axle Left & Right Upper	BUS FWD S9W700		Ball Joint	S080334
	1998.07-2002.09	Front Axle Left & Right Lower	BUS FWD S9W700		Control Arm Bushing	511223
	1998.07-2002.09	Front Axle Left & Right Lower	BUS FWD S9W700		Control Arm Bushing	511224
	1998.07-2002.09	Front Axle Left & Right	BUS FWD S9W700		Tie Rod Axle Joint	S030204
	1998.07-2002.09	Front Axle Left	BUS FWD S9W700		Tie Rod End	S070354
	1998.07-2002.09	Front Axle Right	BUS FWD S9W700		Tie Rod End	S070355
	1998.07-2002.09	Front Axle Left & Right	BUS FWD S9W700		Tie Rod End	S070824
	1998.07-2002.09	Front Axle Left & Right	BUS FWD S9W700		Tie Rod End	S070866
	1998.07-2002.09	Front Axle Left	BUS FWD S9W700		Rod/Strut,stabiliser	S050363
	1998.07-2002.09	Front Axle Right	BUS FWD S9W700		Rod/Strut,stabiliser	S050364
	1998.07-2002.09	Front Axle	BUS FWD S9W700		Steering Rack Bellow Kit	540075S
Megane						
1.6 (66 kw)	1995.08-1999.03	Front Axle Left Lower	Hatchback FWD K7M703		Track Control Arm	S060703
	1995.08-1999.03	Front Axle Right Lower	Hatchback FWD K7M703		Track Control Arm	S060702
	1995.08-1999.03	Front Axle Left & Right Lower	Hatchback FWD K7M703		Ball Joint	S080174
	1995.08-1999.03	Front Axle Left & Right Lower	Hatchback FWD K7M703	Date from:1997.10	Ball Joint	S080197
	1995.08-1999.03	Front Axle Left & Right	Hatchback FWD K7M703		Control Arm Bushing	510758
	1995.08-1999.03	Front Axle Left & Right Lower	Hatchback FWD K7M703		Control Arm Bushing	510756
	1995.08-1999.03	Front Axle Left & Right	Hatchback FWD K7M703	Date to:1998.08,for vehicles with power steering	Tie Rod Axle Joint	S030240
	1995.08-1999.03	Front Axle Left & Right	Hatchback FWD K7M703	Date to:1999.02,for vehicles with power steering	Tie Rod Axle Joint	S030241
	1995.08-1999.03	Front Axle Left & Right	Hatchback FWD K7M703	Date from:1999.02,for vehicles with power steering	Tie Rod Axle Joint	S030244
	1995.08-1999.03	Front Axle Left & Right	Hatchback FWD K7M703	Date from:1999.02,for vehicles with power steering	Tie Rod Axle Joint	S030245
	1995.08-1999.03	Front Axle Left & Right	Hatchback FWD K7M703	for vehicles without power steering	Tie Rod Axle Joint	S030261
	1995.08-1999.03	Front Axle Left & Right	Hatchback FWD K7M703	Date from-to:1998.08-1999.02	Tie Rod Axle Joint	S030614
	1995.08-1999.03	Front Axle Left	Hatchback FWD K7M703	Date from:1999.02	Tie Rod End	S070352
	1995.08-1999.03	Front Axle Left	Hatchback FWD K7M703	Date to:1999.02	Tie Rod End	S070406
	1995.08-1999.03	Front Axle Right	Hatchback FWD K7M703	Date from:1999.02	Tie Rod End	S070353
	1995.08-1999.03	Front Axle Right	Hatchback FWD K7M703	Date to:1999.02	Tie Rod End	S070407
	1995.08-1999.03	Front Axle Left & Right Inner	Hatchback FWD K7M703		Stabiliser Bushing	513713
	1995.08-1999.03	Front Axle Left & Right Inner	Hatchback FWD K7M703		Stabiliser Bushing	513955
	1995.08-1999.03	Front Axle Left & Right Outer	Hatchback FWD K7M703		Stabiliser Bushing	511539
	1995.08-1999.03	Front Axle Left & Right Outer	Hatchback FWD K7M703		Stabiliser Bushing	513956
	1995.08-1999.03	Front Axle	Hatchback FWD K7M703		Steering Boot	540333
	1995.08-1999.03	Front Axle	Hatchback FWD K7M703		Steering Boot	540335
	1995.08-1999.03	Front Axle	Hatchback FWD K7M703	for vehicles with power steering	Steering Rack Bellow Kit	540220S
	1995.08-1999.03	Front Axle	Hatchback FWD K7M703	for vehicles without power steering	Steering Rack Bellow Kit	540335S
1.6 (81 kw)	1997.09-2008.09	Front Axle Left & Right Lower	Saloon FWD K4M700/K4M701		Ball Joint	S080197
	2001.11-2004.12	Front Axle Left Lower	Hatchback FWD K4M700		Track Control Arm	S060703
	2001.11-2004.12	Front Axle Right Lower	Hatchback FWD K4M700		Track Control Arm	S060702
	2001.11-2004.12	Front Axle Left & Right Lower	Hatchback FWD K4M700		Ball Joint	S080174
	2001.11-2004.12	Front Axle Left & Right Lower	Hatchback FWD K4M700		Ball Joint	S080197
	2001.11-2004.12	Front Axle Left & Right Lower	Hatchback FWD K4M700		Control Arm Bushing	510756
	2001.11-2004.12	Front Axle Left & Right	Hatchback FWD K4M700	for vehicles with power steering	Tie Rod Axle Joint	S030244
	2001.11-2004.12	Front Axle Left & Right	Hatchback FWD K4M700	for vehicles with power steering	Tie Rod Axle Joint	S030245
	2001.11-2004.12	Front Axle Left & Right	Hatchback FWD K4M700	for vehicles without power steering	Tie Rod Axle Joint	S030261
	2001.11-2004.12	Front Axle Left	Hatchback FWD K4M700		Tie Rod End	S070352
	2001.11-2004.12	Front Axle Right	Hatchback FWD K4M700		Tie Rod End	S070353



	 YEAR	FITTING POSITION	BODY STYLE & DRIVE TYPE & ENGINE	REMARKS	PRODUCT	GSP Ref.
RENAULT Megane						
1.6 (81 kw)	2001.11-2004.12	Front Axle Left & Right Outer	Hatchback FWD K4M700		Stabiliser Bushing	511539
	2001.11-2004.12	Front Axle Left & Right Outer	Hatchback FWD K4M700		Stabiliser Bushing	513969
	2001.11-2004.12	Front Axle	Hatchback FWD K4M700		Steering Boot	540333
	2001.11-2004.12	Front Axle	Hatchback FWD K4M700		Steering Boot	540335
	2001.11-2004.12	Front Axle	Hatchback FWD K4M700		Steering Rack Bellow Kit	540335S
2.0 (84 kw)	1996.01-2003.08	Front Axle Left Lower	Hatchback FWD F3R750F3R751F3R791F3R796F3R797F3R798		Track Control Arm	S060703
	1996.01-2003.08	Front Axle Right Lower	Hatchback FWD F3R750F3R751F3R791F3R796F3R797F3R798		Track Control Arm	S060702
	1996.01-2003.08	Front Axle Left & Right Lower	Hatchback FWD F3R750F3R751F3R791F3R796F3R797F3R798		Ball Joint	S080174
	1996.01-2003.08	Front Axle Left & Right Lower	Hatchback FWD F3R750F3R751F3R791F3R796F3R797F3R798		Control Arm Bushing	510756
	1996.01-2003.08	Front Axle Left & Right	Hatchback FWD F3R750F3R751F3R791F3R796F3R797F3R798	Date to:1998.08,for vehicles with power steering	Tie Rod Axle Joint	S030240
	1996.01-2003.08	Front Axle Left & Right	Hatchback FWD F3R750F3R751F3R791F3R796F3R797F3R798	Date to:1999.02,for vehicles with power steering	Tie Rod Axle Joint	S030241
	1996.01-2003.08	Front Axle Left & Right	Hatchback FWD F3R750F3R751F3R791F3R796F3R797F3R798	Date from:1999.02,for vehicles with power steering	Tie Rod Axle Joint	S030244
	1996.01-2003.08	Front Axle Left & Right	Hatchback FWD F3R750F3R751F3R791F3R796F3R797F3R798	Date from:1999.02,for vehicles with power steering	Tie Rod Axle Joint	S030245
	1996.01-2003.08	Front Axle Left & Right	Hatchback FWD F3R750F3R751F3R791F3R796F3R797F3R798	for vehicles without power steering	Tie Rod Axle Joint	S030261
	1996.01-2003.08	Front Axle Left & Right	Hatchback FWD F3R750F3R751F3R791F3R796F3R797F3R798	Engine code:F3R 797 F3R 791,Date from-to:1998.08-1999.02	Tie Rod Axle Joint	S030614
	1996.01-2003.08	Front Axle Left & Right	Hatchback FWD F3R750F3R751F3R791F3R796F3R797F3R798	Date from-to:1998.08-1999.02	Tie Rod Axle Joint	S030614
	1996.01-2003.08	Front Axle Left	Hatchback FWD F3R750F3R751F3R791F3R796F3R797F3R798	Date from:1999.02	Tie Rod End	S070352
	1996.01-2003.08	Front Axle Left	Hatchback FWD F3R750F3R751F3R791F3R796F3R797F3R798	Date to:1999.02	Tie Rod End	S070406
	1996.01-2003.08	Front Axle Right	Hatchback FWD F3R750F3R751F3R791F3R796F3R797F3R798	Date from:1999.02	Tie Rod End	S070353
	1996.01-2003.08	Front Axle Right	Hatchback FWD F3R750F3R751F3R791F3R796F3R797F3R798	Date to:1999.02	Tie Rod End	S070407
	1996.01-2003.08	Front Axle Left & Right Inner	Hatchback FWD F3R750F3R751F3R791F3R796F3R797F3R798		Stabiliser Bushing	513955
	1996.01-2003.08	Front Axle	Hatchback FWD F3R750F3R751F3R791F3R796F3R797F3R798		Steering Boot	540333
	1996.01-2003.08	Front Axle	Hatchback FWD F3R750F3R751F3R791F3R796F3R797F3R798		Steering Boot	540335
	1996.01-2003.08	Front Axle	Hatchback FWD F3R750F3R751F3R791F3R796F3R797F3R798	for vehicles without power steering	Steering Rack Bellow Kit	540335S
	Megane CC					
2.0 (102 kw)	2003.09-2010.03	Front Axle Left Lower	Cabriolet FWD F4R770		Track Control Arm	S060688
	2003.09-2010.03	Front Axle Right Lower	Cabriolet FWD F4R770		Track Control Arm	S060689
	2003.09-2010.03	Front Axle Left & Right Lower	Cabriolet FWD F4R770		Ball Joint	S080844
	2003.09-2010.03	Front Axle Left & Right Lower	Cabriolet FWD F4R770		Control Arm Bushing	510742
	2003.09-2010.03	Front Axle Left & Right Lower	Cabriolet FWD F4R770		Control Arm Bushing	510743
	2003.09-2010.03	Front Axle Left & Right	Cabriolet FWD F4R770		Tie Rod Axle Joint	S030250
	2003.09-2010.03	Front Axle Left	Cabriolet FWD F4R770		Tie Rod End	S070391
	2003.09-2010.03	Front Axle Right	Cabriolet FWD F4R770		Tie Rod End	S070392
	2003.09-2010.03	Front Axle Left & Right	Cabriolet FWD F4R770		Rod/Strut,stabiliser	S050392
	2003.09-2010.03	Front Axle Left & Right	Cabriolet FWD F4R770		Rod/Strut,stabiliser	S050396
2003.09-2010.03	Front Axle	Cabriolet FWD F4R770		Stabiliser Bushing	517261	
Megane Classic						
2.0 (84 kw)	1996.09-2003.08	Front Axle Left & Right Lower	Saloon FWD F3R750F3R751F3R752F3R791F3R796F3R797F3R798	Quantity:2	Control Arm Bushing	510756
	1996.09-2003.08	Front Axle Left & Right Lower	Saloon FWD F3R750F3R751F3R752F3R791F3R796F3R797F3R798		Control Arm Bushing	510756
	1996.09-2003.08	Front Axle Left	Saloon FWD F3R750F3R751F3R752F3R791F3R796F3R797F3R798		Tie Rod End	S070352
	1996.09-2003.08	Front Axle Left	Saloon FWD F3R750F3R751F3R752F3R791F3R796F3R797F3R798	Date from:1999.02	Tie Rod End	S070352
	1996.09-2003.08	Front Axle Left	Saloon FWD F3R750F3R751F3R752F3R791F3R796F3R797F3R798		Tie Rod End	S070406
	1996.09-2003.08	Front Axle Left	Saloon FWD F3R750F3R751F3R752F3R791F3R796F3R797F3R798	Date to:1999.02	Tie Rod End	S070406
	1996.09-2003.08	Front Axle Right	Saloon FWD F3R750F3R751F3R752F3R791F3R796F3R797F3R798		Tie Rod End	S070353
	1996.09-2003.08	Front Axle Right	Saloon FWD F3R750F3R751F3R752F3R791F3R796F3R797F3R798	Date from:1999.02	Tie Rod End	S070353
	1996.09-2003.08	Front Axle Right	Saloon FWD F3R750F3R751F3R752F3R791F3R796F3R797F3R798		Tie Rod End	S070407
	1996.09-2003.08	Front Axle Right	Saloon FWD F3R750F3R751F3R752F3R791F3R796F3R797F3R798	Date to:1999.02	Tie Rod End	S070407
1996.09-2003.08	Front Axle	Saloon FWD F3R750F3R751F3R752F3R791F3R796F3R797F3R798		Steering Boot	540333	
Megane Estate/Break						
2.0 (102 kw)	2006.12-2011.01	Front Axle Left Lower	Estate FWD F4R770/F4R771		Track Control Arm	S060688
	2006.12-2011.01	Front Axle Right Lower	Estate FWD F4R770/F4R771		Track Control Arm	S060689
	2006.12-2011.01	Front Axle Left & Right Lower	Estate FWD F4R770/F4R771		Ball Joint	S080844
	2006.12-2011.01	Front Axle Left & Right Lower	Estate FWD F4R770/F4R771		Control Arm Bushing	510742
	2006.12-2011.01	Front Axle Left & Right Lower	Estate FWD F4R770/F4R771		Control Arm Bushing	510743
	2006.12-2011.01	Front Axle Left & Right	Estate FWD F4R770/F4R771		Tie Rod Axle Joint	S030250
	2006.12-2011.01	Front Axle Left	Estate FWD F4R770/F4R771		Tie Rod End	S070391
	2006.12-2011.01	Front Axle Right	Estate FWD F4R770/F4R771		Tie Rod End	S070392
	2006.12-2011.01	Front Axle Left & Right	Estate FWD F4R770/F4R771	Engine code:F4R 770	Rod/Strut,stabiliser	S050392
	2006.12-2011.01	Front Axle Left & Right	Estate FWD F4R770/F4R771	Engine code:F4R 770	Rod/Strut,stabiliser	S050396
2006.12-2011.01	Front Axle	Estate FWD F4R770/F4R771		Stabiliser Bushing	517261	
Oroch						
1.6 (82 kw)	2015.09-	Front Axle	Pick up FWD K4M 690		Stabiliser Bushing	517815
	2015.09-	Front Axle	Pick up FWD K4M 690		Steering Rack Bellow Kit	540289S



	 YEAR	FITTING POSITION	BODY STYLE & DRIVE TYPE & ENGINE	REMARKS	PRODUCT	GSP Ref.	
RENAULT							
Oroch							
1.6 (85 kw)	2015.09-2017.09	Front Axle	Pick up FWD K4M 842		Stabiliser Bushing	517815	
1.6 (88 kw)	2017.01-	Front Axle	Pick up FWD H4M 735		Stabiliser Bushing	517815	
	2017.01-	Front Axle	Pick up FWD H4M 735		Steering Rack Bellow Kit	540289S	
2.0 (105 kw)	2015.09-	Rear Axle Left & Right Lower	Pick up FWD F4R 416/F4R 418		Control Arm Bushing	535474	
	2015.09-	Front Axle	Pick up FWD		Stabiliser Bushing	517815	
	2015.09-	Front Axle	Pick up FWD F4R 416/F4R 418		Stabiliser Bushing	517815	
	2015.09-	Front Axle	Pick up AWD		Stabiliser Bushing	517815	
	2015.09-	Front Axle	Pick up FWD		Steering Rack Bellow Kit	540289S	
	2015.09-	Front Axle	Pick up FWD F4R 416/F4R 418		Steering Rack Bellow Kit	540289S	
	2015.09-	Front Axle	Pick up AWD		Steering Rack Bellow Kit	540289S	
Safrane							
2.0 (97 kw)	1992.01-1996.10	Front Axle Left & Right Lower	Hatchback FWD J7R734/J7R735		Ball Joint	S080208	
	1992.01-1996.10	Front Axle Left	Hatchback FWD J7R734/J7R735		Tie Rod End	S070402	
	1992.01-1996.10	Front Axle Right	Hatchback FWD J7R734/J7R735		Tie Rod End	S070403	
	1992.01-1996.10	Front Axle Left & Right	Hatchback FWD J7R734/J7R735		Rod/Strut, stabiliser	S100112	
	1992.01-1996.10	Front Axle	Hatchback FWD J7R734/J7R735		Steering Boot	540195	
	1992.01-1996.10	Front Axle	Hatchback FWD J7R734/J7R735		Steering Boot	540199	
	1992.01-1996.10	Front Axle Left	Hatchback FWD J7R734/J7R735	for left-hand drive vehicles, for vehicles with power steering	Steering Rack Bellow Kit	540199S	
	1992.01-1996.10	Front Axle Right	Hatchback FWD J7R734/J7R735	for left-hand drive vehicles, for vehicles with power steering	Steering Rack Bellow Kit	540195S	
Sandero Stepway							
1.6 (82 kw)	2007.11-2014.06	Front Axle Left Lower	Hatchback FWD K4M694		Track Control Arm	S060398	
	2007.11-2014.06	Front Axle Left Lower	Hatchback FWD K4M694	Date from:2012.10	Track Control Arm	S061681	
	2007.11-2014.06	Front Axle Right Lower	Hatchback FWD K4M694		Track Control Arm	S060399	
	2007.11-2014.06	Front Axle Right Lower	Hatchback FWD K4M694	Date from:2012.10	Track Control Arm	S061682	
	2007.11-2014.06	Front Axle Left & Right Lower	Hatchback FWD K4M694		Ball Joint	S080844	
	2007.11-2014.06	Front Axle Left & Right Lower	Hatchback FWD K4M694		Ball Joint	S080959	
	2007.11-2014.06	Front Axle Left & Right Lower	Hatchback FWD K4M694		Control Arm Bushing	514827	
	2007.11-2014.06	Front Axle	Hatchback FWD K4M694		Suspension Repair Kit	S990009SK	
	2007.11-2014.06	Front Axle Left & Right	Hatchback FWD K4M694		Tie Rod Axle Joint	S030039	
	2007.11-2014.06	Front Axle Left	Hatchback FWD K4M694		Tie Rod End	S070110	
	2007.11-2014.06	Front Axle Right	Hatchback FWD K4M694		Tie Rod End	S070111	
	2007.11-2014.06	Front Axle Left & Right	Hatchback FWD K4M694		Rod/Strut, stabiliser	510748	
	2007.11-2014.06	Front Axle	Hatchback FWD K4M694		Stabiliser Bushing	510776	
Scenic							
1.6 (79 kw)	1999.09-2003.09	Front Axle Left Lower	MPV FWD K4M700/K4M706/K4M707/K4M776		Track Control Arm	S060703	
	1999.09-2003.09	Front Axle Right Lower	MPV FWD K4M700/K4M706/K4M707/K4M776		Track Control Arm	S060702	
	1999.09-2003.09	Front Axle Left & Right Lower	MPV FWD K4M700/K4M706/K4M707/K4M776		Ball Joint	S080197	
	1999.09-2003.09	Front Axle Left & Right Lower	MPV FWD K4M700/K4M706/K4M707/K4M776		Control Arm Bushing	510756	
	1999.09-2003.09	Front Axle Left & Right	MPV FWD K4M700/K4M706/K4M707/K4M776		Tie Rod Axle Joint	S030244	
	1999.09-2003.09	Front Axle Left & Right	MPV FWD K4M700/K4M706/K4M707/K4M776		Tie Rod Axle Joint	S030245	
	1999.09-2003.09	Front Axle Left	MPV FWD K4M700/K4M706/K4M707/K4M776		Tie Rod End	S070352	
	1999.09-2003.09	Front Axle Right	MPV FWD K4M700/K4M706/K4M707/K4M776		Tie Rod End	S070353	
	1999.09-2003.09	Front Axle	MPV FWD K4M700/K4M706/K4M707/K4M776		Steering Rack Bellow Kit	540220S	
	2.0 (101 kw)	2008.02-2009.04	Front Axle Left Lower	MPV FWD F4R771		Track Control Arm	S060688
2008.02-2009.04		Front Axle Right Lower	MPV FWD F4R771		Track Control Arm	S060689	
2008.02-2009.04		Front Axle Left & Right Lower	MPV FWD F4R771		Ball Joint	S080844	
2008.02-2009.04		Front Axle Left & Right	MPV FWD F4R771		Tie Rod Axle Joint	S030250	
2008.02-2009.04		Front Axle Left	MPV FWD F4R771		Tie Rod End	S070391	
2008.02-2009.04		Front Axle Right	MPV FWD F4R771		Tie Rod End	S070392	
2008.02-2009.04		Front Axle Left & Right	MPV FWD F4R771	for vehicles with standard suspension	Rod/Strut, stabiliser	S050392	
2008.02-2009.04		Front Axle Left & Right	MPV FWD F4R771	for vehicles with increased ground clearance	Rod/Strut, stabiliser	S050396	
2.0 (103 kw)	1999.09-2009.07	Front Axle Left Lower	MPV FWD F4R740/F4R741/F4R746/F4R747		Track Control Arm	S060703	
	1999.09-2009.07	Front Axle Right Lower	MPV FWD F4R740/F4R741/F4R746/F4R747		Track Control Arm	S060702	
	1999.09-2009.07	Front Axle Left & Right	MPV FWD F4R740/F4R741/F4R746/F4R747		Control Arm Bushing	510758	
	1999.09-2009.07	Front Axle Left & Right Lower	MPV FWD F4R740/F4R741/F4R746/F4R747		Control Arm Bushing	510756	
	1999.09-2009.07	Front Axle Left & Right	MPV FWD F4R740/F4R741/F4R746/F4R747		Tie Rod Axle Joint	S030244	
	1999.09-2009.07	Front Axle Left & Right	MPV FWD F4R740/F4R741/F4R746/F4R747		Tie Rod Axle Joint	S030245	
	1999.09-2009.07	Front Axle Left	MPV FWD F4R740/F4R741/F4R746/F4R747		Tie Rod End	S070352	
	1999.09-2009.07	Front Axle Right	MPV FWD F4R740/F4R741/F4R746/F4R747		Tie Rod End	S070353	
	1999.09-2009.07	Front Axle	MPV FWD F4R740/F4R741/F4R746/F4R747	for vehicles with power steering	Steering Rack Bellow Kit	540220S	
	Twingo						
	1.2 (40 kw)	1993.03-1997.08	Front Axle Left Lower	Hatchback FWD C3G700/C3G702		Track Control Arm	S060677
1993.03-1997.08		Front Axle Right Lower	Hatchback FWD C3G700/C3G702		Track Control Arm	S060678	
1993.03-1997.08		Front Axle Left & Right Lower	Hatchback FWD C3G700/C3G702		Ball Joint	S080174	



	 YEAR	FITTING POSITION	BODY STYLE & DRIVE TYPE & ENGINE	REMARKS	PRODUCT	GSP Ref.
RENAULT						
Twingo						
1.2 (40 kw)	1993.03-1997.08	Front Axle Left & Right Lower	Hatchback FWD C3G700/C3G702		Control Arm Bushing	530829
	1993.03-1997.08	Front Axle Left & Right Lower	Hatchback FWD C3G700/C3G702		Control Arm Bushing	530830
	1993.03-1997.08	Front Axle Left & Right	Hatchback FWD C3G700/C3G702		Tie Rod Axle Joint	S030257
	1993.03-1997.08	Front Axle Left & Right	Hatchback FWD C3G700/C3G702		Tie Rod Axle Joint	S030260
	1993.03-1997.08	Front Axle Left	Hatchback FWD C3G700/C3G702		Tie Rod End	S070404
	1993.03-1997.08	Front Axle Right	Hatchback FWD C3G700/C3G702		Tie Rod End	S070405
	1993.03-1997.08	Front Axle	Hatchback FWD C3G700/C3G702		Steering Boot	540335
	1993.03-1997.08	Front Axle	Hatchback FWD C3G700/C3G702	for vehicles without power steering	Steering Rack Bellow Kit	540335S
Zoe						
ET (68 kw)	2016.09-	Front Axle Left Lower	Hatchback FWD 5A9Q601		Track Control Arm	S063105
	2016.09-	Front Axle Right Lower	Hatchback FWD 5A9Q601		Track Control Arm	S063106
	2016.09-	Front Axle Left & Right	Hatchback FWD 5A9Q601		Tie Rod Axle Joint	S031060
	2016.09-	Front Axle Left	Hatchback FWD 5A9Q601		Tie Rod End	S071388
	2016.09-	Front Axle Right	Hatchback FWD 5A9Q601		Tie Rod End	S071389
	2016.09-	Front Axle Left & Right	Hatchback FWD 5A9Q601		Rod/Strut, stabiliser	S050366
ROLLS-ROYCE						
Ghost						
6.6 (420 kw)	2009.04-2020.03	Front Axle	Saloon RWD N74B66A		Steering Boot	540440
Phantom						
6.7 (338 kw)	2002.08-2017.07	Front Axle	Saloon RWD N73B68A		Steering Rack Bellow Kit	540342S
Wraith						
6.6 (465 kw)	2013.08-	Front Axle	Coupe RWD N74B66A		Steering Boot	540440
SEAT						
Cordoba						
1.6 (74 kw)	1995.09-2002.10	Front Axle Left & Right Lower	Saloon FWD AEH/AFT/AKL/APF/AUR		Track Control Arm	S060719
	1995.09-2002.10	Front Axle Left & Right Lower	Saloon FWD AEH/AFT/AKL/APF/AUR		Ball Joint	S080211
	1995.09-2002.10	Front Axle Left & Right Lower	Saloon FWD AEH/AFT/AKL/APF/AUR		Control Arm Bushing	510024
	1995.09-2002.10	Front Axle Left & Right Lower	Saloon FWD AEH/AFT/AKL/APF/AUR		Control Arm Bushing	510025
	1995.09-2002.10	Front Axle Left & Right Lower	Saloon FWD AEH/AFT/AKL/APF/AUR		Control Arm Bushing	510084
	1995.09-2002.10	Front Axle Left & Right Lower	Saloon FWD AEH/AFT/AKL/APF/AUR		Control Arm Bushing Kit	510312S
	1995.09-2002.10	Front Axle Left & Right Lower	Saloon FWD AEH/AFT/AKL/APF/AUR		Control Arm Bushing Kit	510313S
	1995.09-2002.10	Front Axle Left	Saloon FWD AEH/AFT/AKL/APF/AUR		Rod Assembly	S100119
	1995.09-2002.10	Front Axle Left	Saloon FWD AEH/AFT/AKL/APF/AUR	for vehicles without power steering	Rod Assembly	S100126
	1995.09-2002.10	Front Axle Right	Saloon FWD AEH/AFT/AKL/APF/AUR		Rod Assembly	S100120
	1995.09-2002.10	Front Axle Right	Saloon FWD AEH/AFT/AKL/APF/AUR	for vehicles without power steering	Rod Assembly	S100123
	1995.09-2002.10	Front Axle Left & Right	Saloon FWD AEH/AFT/AKL/APF/AUR	for vehicles without power steering	Tie Rod Axle Joint	S030265
	1995.09-2002.10	Front Axle Left & Right	Saloon FWD AEH/AFT/AKL/APF/AUR	Engine code AFT/Chassis no. to 95C-17661 913 for vehicles with power steering	Tie Rod Axle Joint	S030575
	1995.09-2002.10	Front Axle Left & Right	Saloon FWD AEH/AFT/AKL/APF/AUR	Engine code AFT/Chassis no. to 95C-17661 913 for vehicles with power steering	Tie Rod Axle Joint	S030729
	1995.09-2002.10	Front Axle Left & Right	Saloon FWD AEH/AFT/AKL/APF/AUR	Engine code AFT/Chassis no. to 95C-17661 913 for vehicles with power steering	Tie Rod Axle Joint	S030848
	1995.09-2002.10	Front Axle Left	Saloon FWD AEH/AFT/AKL/APF/AUR	Chassis no. 95C-000 001-95C-0340 000 for vehicles with power steering	Tie Rod End	S070029
	1995.09-2002.10	Front Axle Left	Saloon FWD AEH/AFT/AKL/APF/AUR		Tie Rod End	S070419
	1995.09-2002.10	Front Axle Right	Saloon FWD AEH/AFT/AKL/APF/AUR	Chassis no. 95C-000 001-95C-0340 000 for vehicles with power steering	Tie Rod End	S070028
	1995.09-2002.10	Front Axle Right	Saloon FWD AEH/AFT/AKL/APF/AUR		Tie Rod End	S070418
	1995.09-2002.10	Front Axle Left & Right	Saloon FWD AEH/AFT/AKL/APF/AUR		Tie Rod End	S070866
	1995.09-2002.10	Front Axle Left & Right	Saloon FWD AEH/AFT/AKL/APF/AUR		Rod/Strut, stabiliser	510028
	1995.09-2002.10	Front Axle Left & Right	Saloon FWD AEH/AFT/AKL/APF/AUR		Rod/Strut, stabiliser	513844
	1995.09-2002.10	Front Axle Left & Right	Saloon FWD AEH/AFT/AKL/APF/AUR	Stabiliser Diameter[mm]: 17	Rod/Strut, stabiliser	S050398
	1995.09-2002.10	Front Axle Left & Right	Saloon FWD AEH/AFT/AKL/APF/AUR		Rod/Strut, stabiliser	S050402
	1995.09-2002.10	Front Axle	Saloon FWD AEH/AFT/AKL/APF/AUR		Stabiliser Bushing	510032
	1995.09-2002.10	Front Axle	Saloon FWD AEH/AFT/AKL/APF/AUR		Stabiliser Bushing	510219
	1995.09-2002.10	Front Axle	Saloon FWD AEH/AFT/AKL/APF/AUR		Steering Boot	540016
	1995.09-2002.10	Front Axle	Saloon FWD AEH/AFT/AKL/APF/AUR		Steering Boot	540384
	1995.09-2002.10	Front Axle	Saloon FWD AEH/AFT/AKL/APF/AUR	for vehicles with power steering	Steering Rack Bellow Kit	541026S
	1995.09-2002.10	Front Axle Left & Right	Saloon FWD AEH/AFT/AKL/APF/AUR		Securing Plate, ball joint	510023S
	1.8 (66 kw)	1993.09-1999.06	Front Axle Left & Right Lower	Saloon FWD ABS/ACC/ADZ		Track Control Arm
1993.09-1999.06		Front Axle Left & Right Lower	Saloon FWD ABS/ACC/ADZ		Ball Joint	S080211
1993.09-1999.06		Front Axle Left & Right Lower	Saloon FWD ABS/ACC/ADZ		Control Arm Bushing	510024
1993.09-1999.06		Front Axle Left & Right Lower	Saloon FWD ABS/ACC/ADZ		Control Arm Bushing	510025
1993.09-1999.06		Front Axle Left & Right Lower	Saloon FWD ABS/ACC/ADZ		Control Arm Bushing	510084
1993.09-1999.06		Front Axle Left & Right Lower	Saloon FWD ABS/ACC/ADZ		Control Arm Bushing Kit	510312S
1993.09-1999.06		Front Axle Left & Right Lower	Saloon FWD ABS/ACC/ADZ		Control Arm Bushing Kit	510313S
1993.09-1999.06		Front Axle Left	Saloon FWD ABS/ACC/ADZ		Rod Assembly	S100119
1993.09-1999.06		Front Axle Left	Saloon FWD ABS/ACC/ADZ	Engine Code ABS/ACC/Chassis no. to 95C-2000 703 for vehicles with power steering	Rod Assembly	S100124
1993.09-1999.06		Front Axle Left	Saloon FWD ABS/ACC/ADZ	for vehicles without power steering	Rod Assembly	S100126



	 YEAR	FITTING POSITION	BODY STYLE & DRIVE TYPE & ENGINE	REMARKS	PRODUCT	GSP Ref.
SEAT						
Cordoba						
1.8 (66 kw)	1993.09-1999.06	Front Axle Right	Saloon FWD ABS/ACC/ADZ		Rod Assembly	S100120
	1993.09-1999.06	Front Axle Right	Saloon FWD ABS/ACC/ADZ	for vehicles without power steering	Rod Assembly	S100123
	1993.09-1999.06	Front Axle Right	Saloon FWD ABS/ACC/ADZ	Engine Code:ZE,Chassis no.to:6V-2R550-750,for vehicles with power steering	Rod Assembly	S100125
	1993.09-1999.06	Front Axle Left & Right	Saloon FWD ABS/ACC/ADZ	for vehicles without power steering	Tie Rod Axle Joint	S030265
	1993.09-1999.06	Front Axle Left & Right	Saloon FWD ABS/ACC/ADZ	Chassis no:from:K000-20000-751,000-750000-910,for vehicles with power steering	Tie Rod Axle Joint	S030575
	1993.09-1999.06	Front Axle Left & Right	Saloon FWD ABS/ACC/ADZ	Engine Code:AEI,Engine code:K22,Chassis no:to:6V-2R550-750,for vehicles with power steering	Tie Rod Axle Joint	S030640
	1993.09-1999.06	Front Axle Left & Right	Saloon FWD ABS/ACC/ADZ	Engine Code:AEI,ACC:02500-710,Chassis no:to:6V-2R550-750,for vehicles with power steering	Tie Rod Axle Joint	S030729
	1993.09-1999.06	Front Axle Left	Saloon FWD ABS/ACC/ADZ	Chassis no:6K-X000-001-6K-X-340-000,for vehicles with power steering	Tie Rod End	S070029
	1993.09-1999.06	Front Axle Left	Saloon FWD ABS/ACC/ADZ		Tie Rod End	S070419
	1993.09-1999.06	Front Axle Right	Saloon FWD ABS/ACC/ADZ	Chassis no:6K-X000-001-6K-X-340-000,for vehicles with power steering	Tie Rod End	S070028
	1993.09-1999.06	Front Axle Right	Saloon FWD ABS/ACC/ADZ		Tie Rod End	S070418
	1993.09-1999.06	Front Axle Left & Right	Saloon FWD ABS/ACC/ADZ	VIN from:6K-ZR040-001;VIN from:6K-ZR550-001	Rod/Strut,stabiliser	510028
	1993.09-1999.06	Front Axle Left & Right	Saloon FWD ABS/ACC/ADZ		Rod/Strut,stabiliser	510030
	1993.09-1999.06	Front Axle Left & Right	Saloon FWD ABS/ACC/ADZ		Rod/Strut,stabiliser	513844
	1993.09-1999.06	Front Axle Left & Right	Saloon FWD ABS/ACC/ADZ	Stabiliser Diameter[mm]:17	Rod/Strut,stabiliser	S050398
	1993.09-1999.06	Front Axle Left & Right	Saloon FWD ABS/ACC/ADZ		Rod/Strut,stabiliser	S050402
	1993.09-1999.06	Front Axle	Saloon FWD ABS/ACC/ADZ		Stabiliser Bushing	510032
	1993.09-1999.06	Front Axle	Saloon FWD ABS/ACC/ADZ		Stabiliser Bushing	510219
	1993.09-1999.06	Front Axle	Saloon FWD ABS/ACC/ADZ		Steering Boot	540016
	1993.09-1999.06	Front Axle	Saloon FWD ABS/ACC/ADZ		Steering Boot	540384
	1993.09-1999.06	Front Axle	Saloon FWD ABS/ACC/ADZ	for vehicles with power steering	Steering Rack Bellow Kit	541026S
	1993.09-1999.06	Front Axle Left & Right	Saloon FWD ABS/ACC/ADZ		Securing Plate,ball joint	510023S
Cordoba Vario						
1.6 (74 kw)	1996.09-2002.08	Front Axle Left & Right Lower	Estate FWD AEH/AFT/AKL/APF/AUR		Track Control Arm	S060719
	1996.09-2002.08	Front Axle Left & Right Lower	Estate FWD AEH/AFT/AKL/APF/AUR		Ball Joint	S080211
	1996.09-2002.08	Front Axle Left & Right Lower	Estate FWD AEH/AFT/AKL/APF/AUR		Control Arm Bushing	510024
	1996.09-2002.08	Front Axle Left & Right Lower	Estate FWD AEH/AFT/AKL/APF/AUR		Control Arm Bushing	510025
	1996.09-2002.08	Front Axle Left & Right Lower	Estate FWD AEH/AFT/AKL/APF/AUR	Engine Code:AEH,AFT,AUR,APF	Control Arm Bushing	510084
	1996.09-2002.08	Front Axle Left & Right Lower	Estate FWD AEH/AFT/AKL/APF/AUR		Control Arm Bushing Kit	510312S
	1996.09-2002.08	Front Axle Left & Right Lower	Estate FWD AEH/AFT/AKL/APF/AUR		Control Arm Bushing Kit	510313S
	1996.09-2002.08	Front Axle Left	Estate FWD AEH/AFT/AKL/APF/AUR		Rod Assembly	S100119
	1996.09-2002.08	Front Axle Left	Estate FWD AEH/AFT/AKL/APF/AUR	Engine Code:AEH,AFT,AUR,APF,for vehicles without power steering	Rod Assembly	S100126
	1996.09-2002.08	Front Axle Right	Estate FWD AEH/AFT/AKL/APF/AUR		Rod Assembly	S100120
	1996.09-2002.08	Front Axle Right	Estate FWD AEH/AFT/AKL/APF/AUR	Engine Code:AEH,AFT,AUR,APF,for vehicles without power steering	Rod Assembly	S100123
	1996.09-2002.08	Front Axle Left & Right	Estate FWD AEH/AFT/AKL/APF/AUR	Engine Code:AEH,AFT,AUR,APF,for vehicles without power steering	Tie Rod Axle Joint	S030265
	1996.09-2002.08	Front Axle Left & Right	Estate FWD AEH/AFT/AKL/APF/AUR	Engine Code:AFT,Chassis no:from:6K-7R100-000,for vehicles with power steering	Tie Rod Axle Joint	S030848
	1996.09-2002.08	Front Axle Left	Estate FWD AEH/AFT/AKL/APF/AUR	Engine Code:AFT,APF,Chassis no:6K-5-000-001-6K-5-000-001,for vehicles with power steering	Tie Rod End	S070029
	1996.09-2002.08	Front Axle Left	Estate FWD AEH/AFT/AKL/APF/AUR		Tie Rod End	S070419
	1996.09-2002.08	Front Axle Right	Estate FWD AEH/AFT/AKL/APF/AUR	Engine Code:AFT,APF,Chassis no:6K-5-000-001-6K-5-000-001,for vehicles with power steering	Tie Rod End	S070028
	1996.09-2002.08	Front Axle Right	Estate FWD AEH/AFT/AKL/APF/AUR		Tie Rod End	S070418
	1996.09-2002.08	Front Axle Left & Right	Estate FWD AEH/AFT/AKL/APF/AUR		Rod/Strut,stabiliser	510028
	1996.09-2002.08	Front Axle Left & Right	Estate FWD AEH/AFT/AKL/APF/AUR		Rod/Strut,stabiliser	513844
	1996.09-2002.08	Front Axle Left & Right	Estate FWD AEH/AFT/AKL/APF/AUR	Stabiliser Diameter[mm]:17	Rod/Strut,stabiliser	S050398
	1996.09-2002.08	Front Axle Left & Right	Estate FWD AEH/AFT/AKL/APF/AUR		Rod/Strut,stabiliser	S050402
	1996.09-2002.08	Front Axle	Estate FWD AEH/AFT/AKL/APF/AUR		Stabiliser Bushing	510032
	1996.09-2002.08	Front Axle	Estate FWD AEH/AFT/AKL/APF/AUR		Stabiliser Bushing	510219
	1996.09-2002.08	Front Axle	Estate FWD AEH/AFT/AKL/APF/AUR		Steering Boot	540016
	1996.09-2002.08	Front Axle	Estate FWD AEH/AFT/AKL/APF/AUR		Steering Boot	540384
	1996.09-2002.08	Front Axle	Estate FWD AEH/AFT/AKL/APF/AUR	Engine Code:AEH,AFT,AUR,APF,for vehicles with power steering	Steering Rack Bellow Kit	541026S
	1996.09-2002.08	Front Axle Left & Right	Estate FWD AEH/AFT/AKL/APF/AUR		Securing Plate,ball joint	510023S
Ibiza						
1.0 (37 kw)	1996.09-2002.05	Front Axle Left & Right Lower	Hatchback FWD AER/ALD/ANV/AUC		Track Control Arm	S060719
	1996.09-2002.05	Front Axle Left & Right Lower	Hatchback FWD AER/ALD/ANV/AUC		Ball Joint	S080211
	1996.09-2002.05	Front Axle Left & Right Lower	Hatchback FWD AER/ALD/ANV/AUC		Control Arm Bushing	510024
	1996.09-2002.05	Front Axle Left & Right Lower	Hatchback FWD AER/ALD/ANV/AUC		Control Arm Bushing	510025
	1996.09-2002.05	Front Axle Left & Right Lower	Hatchback FWD AER/ALD/ANV/AUC		Control Arm Bushing	510084
	1996.09-2002.05	Front Axle Left & Right Lower	Hatchback FWD AER/ALD/ANV/AUC		Control Arm Bushing Kit	510312S
	1996.09-2002.05	Front Axle Left & Right Lower	Hatchback FWD AER/ALD/ANV/AUC		Control Arm Bushing Kit	510313S
	1996.09-2002.05	Front Axle Left	Hatchback FWD AER/ALD/ANV/AUC		Rod Assembly	S100119
	1996.09-2002.05	Front Axle Left	Hatchback FWD AER/ALD/ANV/AUC	for vehicles without power steering	Rod Assembly	S100126
	1996.09-2002.05	Front Axle Right	Hatchback FWD AER/ALD/ANV/AUC		Rod Assembly	S100120
	1996.09-2002.05	Front Axle Right	Hatchback FWD AER/ALD/ANV/AUC	for vehicles without power steering	Rod Assembly	S100123
	1996.09-2002.05	Front Axle Left & Right	Hatchback FWD AER/ALD/ANV/AUC		Tie Rod Axle Joint	S030265
	1996.09-2002.05	Front Axle Left	Hatchback FWD AER/ALD/ANV/AUC	Chassis no:6K-X-000-001-6K-X-340-000,for vehicles with power steering	Tie Rod End	S070029



	 YEAR	FITTING POSITION	BODY STYLE & DRIVE TYPE & ENGINE	REMARKS	PRODUCT	GSP Ref.
SEAT						
Ibiza						
1.0 (37 kw)	1996.09-2002.05	Front Axle Left	Hatchback FWD AER/ALD/ANV/AUC		Tie Rod End	S070419
	1996.09-2002.05	Front Axle Right	Hatchback FWD AER/ALD/ANV/AUC	Chassis no. 6K-A-000 001-6K-A-340 000, for vehicles with power steering	Tie Rod End	S070028
	1996.09-2002.05	Front Axle Right	Hatchback FWD AER/ALD/ANV/AUC		Tie Rod End	S070418
	1996.09-2002.05	Front Axle Left & Right	Hatchback FWD AER/ALD/ANV/AUC		Rod/Strut, stabiliser	510028
	1996.09-2002.05	Front Axle Left & Right	Hatchback FWD AER/ALD/ANV/AUC		Rod/Strut, stabiliser	513844
	1996.09-2002.05	Front Axle Left & Right	Hatchback FWD AER/ALD/ANV/AUC	Chassis no. to 6KZR555000, Chassis no. from 6KZR040000	Rod/Strut, stabiliser	S050398
	1996.09-2002.05	Front Axle Left & Right	Hatchback FWD AER/ALD/ANV/AUC		Rod/Strut, stabiliser	S050402
	1996.09-2002.05	Front Axle	Hatchback FWD AER/ALD/ANV/AUC		Stabiliser Bushing	510032
	1996.09-2002.05	Front Axle	Hatchback FWD AER/ALD/ANV/AUC		Stabiliser Bushing	510219
	1996.09-2002.05	Front Axle	Hatchback FWD AER/ALD/ANV/AUC		Steering Boot	540016
	1996.09-2002.05	Front Axle	Hatchback FWD AER/ALD/ANV/AUC		Steering Boot	540384
	1996.09-2002.05	Front Axle	Hatchback FWD AER/ALD/ANV/AUC	for vehicles with power steering	Steering Rack Bellow Kit	541026S
	1996.09-2002.05	Front Axle Left & Right	Hatchback FWD AER/ALD/ANV/AUC		Securing Plate, ball joint	510023S
1.6 (74 kw)	1996.04-2002.02	Front Axle Left & Right Lower	Hatchback FWD AEH/AFT/AKL/APF/AUR		Track Control Arm	S060719
	1996.04-2002.02	Front Axle Left & Right Lower	Hatchback FWD AEH/AFT/AKL/APF/AUR		Ball Joint	S080211
	1996.04-2002.02	Front Axle Left & Right Lower	Hatchback FWD AEH/AFT/AKL/APF/AUR		Control Arm Bushing	510024
	1996.04-2002.02	Front Axle Left & Right Lower	Hatchback FWD AEH/AFT/AKL/APF/AUR		Control Arm Bushing	510025
	1996.04-2002.02	Front Axle Left & Right Lower	Hatchback FWD AEH/AFT/AKL/APF/AUR		Control Arm Bushing	510084
	1996.04-2002.02	Front Axle Left & Right Lower	Hatchback FWD AEH/AFT/AKL/APF/AUR		Control Arm Bushing Kit	510312S
	1996.04-2002.02	Front Axle Left & Right Lower	Hatchback FWD AEH/AFT/AKL/APF/AUR		Control Arm Bushing Kit	510313S
	1996.04-2002.02	Front Axle Left	Hatchback FWD AEH/AFT/AKL/APF/AUR		Rod Assembly	S100119
	1996.04-2002.02	Front Axle Left	Hatchback FWD AEH/AFT/AKL/APF/AUR	for vehicles without power steering	Rod Assembly	S100126
	1996.04-2002.02	Front Axle Right	Hatchback FWD AEH/AFT/AKL/APF/AUR		Rod Assembly	S100120
	1996.04-2002.02	Front Axle Right	Hatchback FWD AEH/AFT/AKL/APF/AUR	for vehicles without power steering	Rod Assembly	S100123
	1996.04-2002.02	Front Axle Left & Right	Hatchback FWD AEH/AFT/AKL/APF/AUR	for vehicles without power steering	Tie Rod Axle Joint	S030265
	1996.04-2002.02	Front Axle Left & Right	Hatchback FWD AEH/AFT/AKL/APF/AUR	Engine code: FT, Chassis no. to 6K-TR081 919, for vehicles with power steering	Tie Rod Axle Joint	S030575
	1996.04-2002.02	Front Axle Left & Right	Hatchback FWD AEH/AFT/AKL/APF/AUR	Engine code: FT, Chassis no. to 6K-TR081 919, for vehicles with power steering	Tie Rod Axle Joint	S030729
	1996.04-2002.02	Front Axle Left & Right	Hatchback FWD AEH/AFT/AKL/APF/AUR	Engine code: FT, Chassis no. from 6K-TR081 919, for vehicles with power steering	Tie Rod Axle Joint	S030848
	1996.04-2002.02	Front Axle Left	Hatchback FWD AEH/AFT/AKL/APF/AUR	Chassis no. 6K-A-000 001-6K-A-340 000, for vehicles with power steering	Tie Rod End	S070029
	1996.04-2002.02	Front Axle Left	Hatchback FWD AEH/AFT/AKL/APF/AUR		Tie Rod End	S070419
	1996.04-2002.02	Front Axle Right	Hatchback FWD AEH/AFT/AKL/APF/AUR	Chassis no. 6K-A-000 001-6K-A-340 000, for vehicles with power steering	Tie Rod End	S070028
	1996.04-2002.02	Front Axle Right	Hatchback FWD AEH/AFT/AKL/APF/AUR		Tie Rod End	S070418
	1996.04-2002.02	Front Axle Left & Right	Hatchback FWD AEH/AFT/AKL/APF/AUR		Rod/Strut, stabiliser	510028
	1996.04-2002.02	Front Axle Left & Right	Hatchback FWD AEH/AFT/AKL/APF/AUR		Rod/Strut, stabiliser	513844
	1996.04-2002.02	Front Axle Left & Right	Hatchback FWD AEH/AFT/AKL/APF/AUR	Chassis no. to 6KZR555000, Chassis no. from 6KZR040000	Rod/Strut, stabiliser	S050398
	1996.04-2002.02	Front Axle Left & Right	Hatchback FWD AEH/AFT/AKL/APF/AUR		Rod/Strut, stabiliser	S050402
	1996.04-2002.02	Front Axle	Hatchback FWD AEH/AFT/AKL/APF/AUR		Stabiliser Bushing	510032
	1996.04-2002.02	Front Axle	Hatchback FWD AEH/AFT/AKL/APF/AUR		Stabiliser Bushing	510219
	1996.04-2002.02	Front Axle	Hatchback FWD AEH/AFT/AKL/APF/AUR		Steering Boot	540016
	1996.04-2002.02	Front Axle	Hatchback FWD AEH/AFT/AKL/APF/AUR		Steering Boot	540384
	1996.04-2002.02	Front Axle	Hatchback FWD AEH/AFT/AKL/APF/AUR	for vehicles with power steering	Steering Rack Bellow Kit	541026S
	1996.04-2002.02	Front Axle Left & Right	Hatchback FWD AEH/AFT/AKL/APF/AUR		Securing Plate, ball joint	510023S
1.8 (66 kw)	1993.02-1999.08	Front Axle Left & Right Lower	Hatchback FWD ABS/ACC/ADZ		Track Control Arm	S060719
	1993.02-1999.08	Front Axle Left & Right Lower	Hatchback FWD ABS/ACC/ADZ		Ball Joint	S080211
	1993.02-1999.08	Front Axle Left & Right Lower	Hatchback FWD ABS/ACC/ADZ		Control Arm Bushing	510024
	1993.02-1999.08	Front Axle Left & Right Lower	Hatchback FWD ABS/ACC/ADZ		Control Arm Bushing	510025
	1993.02-1999.08	Front Axle Left & Right Lower	Hatchback FWD ABS/ACC/ADZ		Control Arm Bushing	510084
	1993.02-1999.08	Front Axle Left & Right Lower	Hatchback FWD ABS/ACC/ADZ		Control Arm Bushing Kit	510312S
	1993.02-1999.08	Front Axle Left & Right Lower	Hatchback FWD ABS/ACC/ADZ		Control Arm Bushing Kit	510313S
	1993.02-1999.08	Front Axle Left	Hatchback FWD ABS/ACC/ADZ		Rod Assembly	S100119
	1993.02-1999.08	Front Axle Left	Hatchback FWD ABS/ACC/ADZ	Engine Code: ABS, ACC, Chassis no. 6K-2R036 750, for vehicles with power steering	Rod Assembly	S100124
	1993.02-1999.08	Front Axle Left	Hatchback FWD ABS/ACC/ADZ	for vehicles without power steering	Rod Assembly	S100126
	1993.02-1999.08	Front Axle Right	Hatchback FWD ABS/ACC/ADZ		Rod Assembly	S100120
	1993.02-1999.08	Front Axle Right	Hatchback FWD ABS/ACC/ADZ	for vehicles without power steering	Rod Assembly	S100123
	1993.02-1999.08	Front Axle Right	Hatchback FWD ABS/ACC/ADZ	Chassis no. to 6K-2R036 750, for vehicles with power steering	Rod Assembly	S100125
	1993.02-1999.08	Front Axle Left & Right	Hatchback FWD ABS/ACC/ADZ	for vehicles without power steering	Tie Rod Axle Joint	S030265
	1993.02-1999.08	Front Axle Left & Right	Hatchback FWD ABS/ACC/ADZ	Chassis no. to 6K-2R036 750, for vehicles with power steering	Tie Rod Axle Joint	S030575
	1993.02-1999.08	Front Axle Left & Right	Hatchback FWD ABS/ACC/ADZ	Engine code: ABS, ACC, Chassis no. to 6K-2R036 750, for vehicles with power steering	Tie Rod Axle Joint	S030640
	1993.02-1999.08	Front Axle Left & Right	Hatchback FWD ABS/ACC/ADZ	Engine code: ABS, ACC, Chassis no. to 6K-2R036 750, for vehicles with power steering	Tie Rod Axle Joint	S030729
	1993.02-1999.08	Front Axle Left	Hatchback FWD ABS/ACC/ADZ	Chassis no. 6K-A-000 001-6K-A-340 000, for vehicles with power steering	Tie Rod End	S070029
	1993.02-1999.08	Front Axle Left	Hatchback FWD ABS/ACC/ADZ		Tie Rod End	S070419
	1993.02-1999.08	Front Axle Right	Hatchback FWD ABS/ACC/ADZ	Chassis no. 6K-A-000 001-6K-A-340 000, for vehicles with power steering	Tie Rod End	S070028
	1993.02-1999.08	Front Axle Right	Hatchback FWD ABS/ACC/ADZ		Tie Rod End	S070418
	1993.02-1999.08	Front Axle Left & Right	Hatchback FWD ABS/ACC/ADZ	VIN from 6K-ZR040 001, VIN from 6K-ZR550 001	Rod/Strut, stabiliser	510028



	 YEAR	FITTING POSITION	BODY STYLE & DRIVE TYPE & ENGINE	REMARKS	PRODUCT	GSP Ref.
SEAT Ibiza						
1.8 (66 kw)	1993.02-1999.08	Front Axle Left & Right	Hatchback FWD ABS/ACC/ADZ		Rod/Strut, stabiliser	510030
	1993.02-1999.08	Front Axle Left & Right	Hatchback FWD ABS/ACC/ADZ		Rod/Strut, stabiliser	513844
	1993.02-1999.08	Front Axle Left & Right	Hatchback FWD ABS/ACC/ADZ	Chassis no.to:6KZFR555000, Chassis no.from:6KZFR40000	Rod/Strut, stabiliser	S050398
	1993.02-1999.08	Front Axle Left & Right	Hatchback FWD ABS/ACC/ADZ		Rod/Strut, stabiliser	S050402
	1993.02-1999.08	Front Axle	Hatchback FWD ABS/ACC/ADZ		Stabiliser Bushing	510032
	1993.02-1999.08	Front Axle	Hatchback FWD ABS/ACC/ADZ		Stabiliser Bushing	510219
	1993.02-1999.08	Front Axle	Hatchback FWD ABS/ACC/ADZ		Steering Boot	540016
	1993.02-1999.08	Front Axle	Hatchback FWD ABS/ACC/ADZ		Steering Boot	540384
	1993.02-1999.08	Front Axle	Hatchback FWD ABS/ACC/ADZ	for vehicles with power steering	Steering Rack Bellow Kit	541026S
1993.02-1999.08	Front Axle Left & Right	Hatchback FWD ABS/ACC/ADZ		Securing Plate, ball joint	510023S	
Inca						
1.6 (66 kw)	1998.11-2003.11	Front Axle Left & Right Lower	Estate Van FWD AEE		Control Arm Bushing	510084
	1998.11-2003.11	Front Axle	Estate Van FWD AEE		Steering Rack Bellow Kit	541026S
SMART Fortwo Cabrio						
1.0 (62 kw)	2007.01-2014.06	Front Axle Left & Right Lower	Cabriolet RWD 132930		Track Control Arm	S062923
	2007.01-2014.06	Front Axle Left & Right	Cabriolet RWD 132930		Tie Rod End	S070371
Fortwo Coupe						
1.0 (62 kw)	2007.01-2014.06	Front Axle Left & Right Lower	Coupe RWD 132930		Track Control Arm	S062923
	2007.01-2014.06	Front Axle Left & Right	Coupe RWD 132930		Tie Rod End	S070371
1.0 (75 kw)	2010.07-2014.06	Front Axle Left & Right Lower	Coupe RWD 132930		Track Control Arm	S062923
	2010.07-2014.06	Front Axle Left & Right	Coupe RWD 132930		Tie Rod End	S070371
SSANGYONG Actyon						
2.0 (104 kw)	2005.11-2013.06	Front Axle Left Lower	SUV RWD D20DT		Track Control Arm	S061488
	2005.11-2013.06	Front Axle Left Upper	SUV RWD D20DT		Track Control Arm	S061757
	2005.11-2013.06	Front Axle Left Upper	SUV RWD D20DT		Track Control Arm	S062082
	2005.11-2013.06	Front Axle Right Lower	SUV RWD D20DT		Track Control Arm	S061981
	2005.11-2013.06	Front Axle Right Upper	SUV RWD D20DT		Track Control Arm	S061758
	2005.11-2013.06	Front Axle Right Upper	SUV RWD D20DT		Track Control Arm	S062083
	2005.11-2013.06	Front Axle Left & Right Lower	SUV RWD D20DT		Ball Joint	S080691
	2005.11-2013.06	Front Axle Left & Right Lower	SUV RWD D20DT	Date from:2006.03	Control Arm Bushing	516400
	2005.11-2013.06	Front Axle Left & Right Lower	SUV RWD D20DT		Control Arm Bushing	535137
	2005.11-2013.06	Front Axle Left & Right Upper	SUV RWD D20DT		Control Arm Bushing	516395
	2005.11-2013.06	Rear Axle Left & Right Upper	SUV RWD D20DT		Control Arm Bushing	516394
	2005.11-2013.06	Rear Axle Left & Right Lower Outer	SUV RWD D20DT		Control Arm Bushing	516389
	2005.11-2013.06	Front Axle Left	SUV RWD D20DT		Tie Rod End	S071021
	2005.11-2013.06	Front Axle Right	SUV RWD D20DT		Tie Rod End	S071022
	2005.11-2013.06	Front Axle Left	SUV RWD D20DT		Rod/Strut, stabiliser	S051380
	2005.11-2013.06	Front Axle Right	SUV RWD D20DT		Rod/Strut, stabiliser	S051328
	2005.11-2013.06	Rear Axle Left & Right	SUV RWD D20DT		Rod/Strut, stabiliser	S050483
	2005.11-2013.06	Front Axle	SUV RWD D20DT		Stabiliser Bushing Kit	516879S
	2006.04-2013.06	Front Axle Left Lower	SUV 4WD D20DT		Track Control Arm	S061488
	2006.04-2013.06	Front Axle Left Upper	SUV 4WD D20DT		Track Control Arm	S061757
	2006.04-2013.06	Front Axle Left Upper	SUV 4WD D20DT		Track Control Arm	S062082
	2006.04-2013.06	Front Axle Right Lower	SUV 4WD D20DT		Track Control Arm	S061981
	2006.04-2013.06	Front Axle Right Upper	SUV 4WD D20DT		Track Control Arm	S061758
	2006.04-2013.06	Front Axle Right Upper	SUV 4WD D20DT		Track Control Arm	S062083
	2006.04-2013.06	Front Axle Left & Right Lower	SUV 4WD D20DT		Ball Joint	S080691
	2006.04-2013.06	Front Axle Left & Right Lower	SUV 4WD D20DT		Control Arm Bushing	516400
	2006.04-2013.06	Front Axle Left & Right Lower	SUV 4WD D20DT		Control Arm Bushing	535137
	2006.04-2013.06	Front Axle Left & Right Upper	SUV 4WD D20DT		Control Arm Bushing	516395
	2006.04-2013.06	Rear Axle Left & Right Upper	SUV 4WD D20DT		Control Arm Bushing	516394
	2006.04-2013.06	Rear Axle Left & Right Lower Outer	SUV 4WD D20DT		Control Arm Bushing	516389
	2006.04-2013.06	Front Axle Left	SUV 4WD D20DT		Tie Rod End	S071021
	2006.04-2013.06	Front Axle Right	SUV 4WD D20DT		Tie Rod End	S071022
	2006.04-2013.06	Front Axle Left	SUV 4WD D20DT		Rod/Strut, stabiliser	S051380
2006.04-2013.06	Front Axle Right	SUV 4WD D20DT		Rod/Strut, stabiliser	S051328	
2006.04-2013.06	Rear Axle Left & Right	SUV 4WD D20DT		Rod/Strut, stabiliser	S050483	
2.3 (110 kw)	2006.11-	Front Axle Left Lower	SUV 4WD G23D		Track Control Arm	S061488
	2006.11-	Front Axle Left Upper	SUV 4WD G23D		Track Control Arm	S061757
	2006.11-	Front Axle Left Upper	SUV 4WD G23D		Track Control Arm	S062082
	2006.11-	Front Axle Right Lower	SUV 4WD G23D		Track Control Arm	S061981
	2006.11-	Front Axle Right Upper	SUV 4WD G23D		Track Control Arm	S061758



	 YEAR	FITTING POSITION	BODY STYLE & DRIVE TYPE & ENGINE	REMARKS	PRODUCT	GSP Ref.
SSANGYONG						
Actyon						
2.3 (110 kw)	2006.11-	Front Axle Right Upper	SUV 4WD G23D		Track Control Arm	S062083
	2006.11-	Front Axle Left & Right Lower	SUV 4WD G23D		Ball Joint	S080691
	2006.11-	Front Axle Left & Right Lower	SUV 4WD G23D		Control Arm Bushing	516400
	2006.11-	Front Axle Left & Right Lower	SUV 4WD G23D		Control Arm Bushing	535137
	2006.11-	Front Axle Left & Right Upper	SUV 4WD G23D		Control Arm Bushing	516395
	2006.11-	Rear Axle Left & Right Upper	SUV 4WD G23D		Control Arm Bushing	516394
	2006.11-	Rear Axle Left & Right Lower Outer	SUV 4WD G23D		Control Arm Bushing	516389
	2006.11-	Front Axle Left	SUV 4WD G23D		Tie Rod End	S071021
	2006.11-	Front Axle Right	SUV 4WD G23D		Tie Rod End	S071022
	2006.11-	Front Axle Left	SUV 4WD G23D		Rod/Strut, stabiliser	S051380
	2006.11-	Front Axle Right	SUV 4WD G23D		Rod/Strut, stabiliser	S051328
	2006.11-	Rear Axle Left & Right	SUV 4WD G23D		Rod/Strut, stabiliser	S050483
Actyon Sports						
2.0 (104 kw)	2007.04-2013.06	Front Axle Left Lower	Pick up 4WD D20DT		Track Control Arm	S061488
	2007.04-2013.06	Front Axle Left Lower	Pick up RWD D20DT		Track Control Arm	S061488
	2007.04-2013.06	Front Axle Left Upper	Pick up 4WD D20DT		Track Control Arm	S061757
	2007.04-2013.06	Front Axle Left Upper	Pick up RWD D20DT		Track Control Arm	S061757
	2007.04-2013.06	Front Axle Left Upper	Pick up 4WD D20DT		Track Control Arm	S062082
	2007.04-2013.06	Front Axle Left Upper	Pick up RWD D20DT		Track Control Arm	S062082
	2007.04-2013.06	Front Axle Right Lower	Pick up 4WD D20DT		Track Control Arm	S061981
	2007.04-2013.06	Front Axle Right Lower	Pick up RWD D20DT		Track Control Arm	S061981
	2007.04-2013.06	Front Axle Right Upper	Pick up 4WD D20DT		Track Control Arm	S061758
	2007.04-2013.06	Front Axle Right Upper	Pick up RWD D20DT		Track Control Arm	S061758
	2007.04-2013.06	Front Axle Right Upper	Pick up 4WD D20DT		Track Control Arm	S062083
	2007.04-2013.06	Front Axle Right Upper	Pick up RWD D20DT		Track Control Arm	S062083
	2007.04-2013.06	Front Axle Left & Right Lower	Pick up 4WD D20DT		Ball Joint	S080691
	2007.04-2013.06	Front Axle Left & Right Lower	Pick up RWD D20DT		Ball Joint	S080691
	2007.04-2013.06	Front Axle Left & Right Lower	Pick up 4WD D20DT		Control Arm Bushing	516400
	2007.04-2013.06	Front Axle Left & Right Lower	Pick up RWD D20DT		Control Arm Bushing	516400
	2007.04-2013.06	Front Axle Left & Right Lower	Pick up 4WD D20DT		Control Arm Bushing	535137
	2007.04-2013.06	Front Axle Left & Right Lower	Pick up RWD D20DT		Control Arm Bushing	535137
	2007.04-2013.06	Front Axle Left & Right Upper	Pick up 4WD D20DT		Control Arm Bushing	516395
	2007.04-2013.06	Front Axle Left & Right Upper	Pick up RWD D20DT		Control Arm Bushing	516395
	2007.04-2013.06	Rear Axle Left & Right Upper	Pick up 4WD D20DT		Control Arm Bushing	516394
	2007.04-2013.06	Rear Axle Left & Right Upper	Pick up RWD D20DT		Control Arm Bushing	516394
	2007.04-2013.06	Rear Axle Left & Right Lower Outer	Pick up 4WD D20DT		Control Arm Bushing	516389
	2007.04-2013.06	Rear Axle Left & Right Lower Outer	Pick up RWD D20DT		Control Arm Bushing	516389
	2007.04-2013.06	Front Axle Left	Pick up 4WD D20DT		Tie Rod End	S071021
	2007.04-2013.06	Front Axle Left	Pick up RWD D20DT		Tie Rod End	S071021
	2007.04-2013.06	Front Axle Right	Pick up 4WD D20DT		Tie Rod End	S071022
	2007.04-2013.06	Front Axle Right	Pick up RWD D20DT		Tie Rod End	S071022
	2007.04-2013.06	Front Axle Left	Pick up 4WD D20DT		Rod/Strut, stabiliser	S051380
	2007.04-2013.06	Front Axle Left	Pick up RWD D20DT		Rod/Strut, stabiliser	S051380
	2007.04-2013.06	Front Axle Right	Pick up 4WD D20DT		Rod/Strut, stabiliser	S051328
	2007.04-2013.06	Front Axle Right	Pick up RWD D20DT		Rod/Strut, stabiliser	S051328
	2007.04-2013.06	Rear Axle Left & Right	Pick up 4WD D20DT		Rod/Strut, stabiliser	S050483
	2007.04-2013.06	Rear Axle Left & Right	Pick up RWD D20DT		Rod/Strut, stabiliser	S050483
Korando						
2.0 (129 kw)	2010.11-	Front Axle Left & Right Lower	SUV 4WD D20DTF		Ball Joint	S081036
	2010.11-	Rear Axle Left & Right Lower Inner	SUV 4WD D20DTF		Control Arm Bushing	530512
	2010.11-	Rear Axle Left & Right Lower Outer	SUV 4WD D20DTF		Control Arm Bushing	516213
	2010.11-	Front Axle Left & Right	SUV 4WD D20DTF		Tie Rod End	S071823
2.2 (131 kw)	2015.07-	Front Axle Left & Right Lower	SUV 4WD D22DTF		Ball Joint	S081036
	2015.07-	Rear Axle Left & Right Lower Inner	SUV 4WD D22DTF		Control Arm Bushing	530512
	2015.07-	Rear Axle Left & Right Lower Outer	SUV 4WD D22DTF		Control Arm Bushing	516213
	2015.07-	Front Axle Left & Right	SUV 4WD D22DTF		Tie Rod End	S071823
Korando Family						
2.5 (58 kw)	1993.06-1997.05	Rear Axle Left & Right Upper	Terrain cab wagon closed 4WD XD3P		Control Arm Bushing	516394
	1993.06-1997.05	Rear Axle Left & Right Lower Outer	Terrain cab wagon closed 4WD XD3P		Control Arm Bushing	516389
Kyron						
2.0 (101 kw)	2005.05-	Front Axle Left Lower	SUV 4WD D20DT		Track Control Arm	S061488
	2005.05-	Front Axle Left Lower	SUV RWD D20DT		Track Control Arm	S061488
	2005.05-	Front Axle Left Upper	SUV 4WD D20DT		Track Control Arm	S061757
	2005.05-	Front Axle Left Upper	SUV 4WD D20DT		Track Control Arm	S062082



	 YEAR	FITTING POSITION	BODY STYLE & DRIVE TYPE & ENGINE	REMARKS	PRODUCT	GSP Ref.
SSANGYONG						
Kyron						
2.0 (101 kw)	2005.05-	Front Axle Right Lower	SUV 4WD D20DT		Track Control Arm	S061981
	2005.05-	Front Axle Right Lower	SUV RWD D20DT		Track Control Arm	S061981
	2005.05-	Front Axle Right Upper	SUV 4WD D20DT		Track Control Arm	S061758
	2005.05-	Front Axle Right Upper	SUV 4WD D20DT		Track Control Arm	S062083
	2005.05-	Front Axle Left & Right Lower	SUV 4WD D20DT		Ball Joint	S080691
	2005.05-	Front Axle Left & Right Lower	SUV RWD D20DT		Ball Joint	S080691
	2005.05-	Front Axle Left & Right Lower	SUV 4WD D20DT		Control Arm Bushing	516400
	2005.05-	Front Axle Left & Right Lower	SUV 4WD D20DT		Control Arm Bushing	535135
	2005.05-	Front Axle Left & Right Lower	SUV 4WD D20DT		Control Arm Bushing	535136
	2005.05-	Front Axle Left & Right Lower	SUV 4WD D20DT		Control Arm Bushing	535137
	2005.05-	Front Axle Left & Right Upper	SUV 4WD D20DT		Control Arm Bushing	516395
	2005.05-	Rear Axle Left & Right Upper	SUV 4WD D20DT		Control Arm Bushing	516394
	2005.05-	Rear Axle Left & Right Lower Outer	SUV 4WD D20DT		Control Arm Bushing	516389
	2005.05-	Front Axle Left	SUV 4WD D20DT		Tie Rod End	S071021
	2005.05-	Front Axle Left	SUV RWD D20DT		Tie Rod End	S071021
	2005.05-	Front Axle Right	SUV 4WD D20DT		Tie Rod End	S071022
	2005.05-	Front Axle Right	SUV RWD D20DT		Tie Rod End	S071022
	2005.05-	Front Axle Left	SUV 4WD D20DT		Rod/Strut, stabiliser	S051380
	2005.05-	Front Axle Right	SUV 4WD D20DT		Rod/Strut, stabiliser	S051328
	2005.05-	Rear Axle Left & Right	SUV 4WD D20DT		Rod/Strut, stabiliser	S050483
	2005.05-	Rear Axle Left & Right	SUV RWD D20DT		Rod/Strut, stabiliser	S050483
2.7 (121 kw)	2005.05-	Front Axle Left Lower	SUV 4WD D27DT		Track Control Arm	S061488
	2005.05-	Front Axle Left Upper	SUV 4WD D27DT		Track Control Arm	S061757
	2005.05-	Front Axle Left Upper	SUV 4WD D27DT		Track Control Arm	S062082
	2005.05-	Front Axle Right Lower	SUV 4WD D27DT		Track Control Arm	S061981
	2005.05-	Front Axle Right Upper	SUV 4WD D27DT		Track Control Arm	S061758
	2005.05-	Front Axle Right Upper	SUV 4WD D27DT		Track Control Arm	S062083
	2005.05-	Front Axle Left & Right Lower	SUV 4WD D27DT		Ball Joint	S080691
	2005.05-	Front Axle Left & Right Lower	SUV 4WD D27DT		Control Arm Bushing	516400
	2005.05-	Front Axle Left & Right Lower	SUV 4WD D27DT		Control Arm Bushing	535137
	2005.05-	Front Axle Left & Right Upper	SUV 4WD D27DT		Control Arm Bushing	516395
	2005.05-	Rear Axle Left & Right Upper	SUV 4WD D27DT		Control Arm Bushing	516394
	2005.05-	Rear Axle Left & Right Lower Outer	SUV 4WD D27DT		Control Arm Bushing	516389
	2005.05-	Front Axle Left	SUV 4WD D27DT		Tie Rod End	S071021
	2005.05-	Front Axle Right	SUV 4WD D27DT		Tie Rod End	S071022
	2005.05-	Front Axle Left	SUV 4WD D27DT		Rod/Strut, stabiliser	S051380
	2005.05-	Front Axle Right	SUV 4WD D27DT		Rod/Strut, stabiliser	S051328
	2005.05-	Rear Axle Left & Right	SUV 4WD D27DT		Rod/Strut, stabiliser	S050483
Musso						
2.9 (73 kw)	1993.03-1998.11	Front Axle Left & Right Lower	Terrain cab wagon closed 4WD OM662		Ball Joint	S081041
	1993.03-1998.11	Front Axle Left & Right Upper	Terrain cab wagon closed 4WD OM662		Ball Joint	S081033
	1993.03-1998.11	Rear Axle Left & Right Upper	Terrain cab wagon closed 4WD OM662		Control Arm Bushing	516394
	1993.03-1998.11	Rear Axle Left & Right Lower Outer	Terrain cab wagon closed 4WD OM662		Control Arm Bushing	516389
	1993.03-1998.11	Front Axle;Rear Axle Left & Right	Terrain cab wagon closed 4WD OM662		Rod/Strut, stabiliser	S050483
Rexton						
2.7 (121 kw)	2004.05-2006.08	Front Axle Left Lower	SUV 4WD D27DT		Track Control Arm	S061486
	2004.05-2006.08	Front Axle Left Upper	SUV 4WD D27DT		Track Control Arm	S061757
	2004.05-2006.08	Front Axle Left Upper	SUV 4WD D27DT		Track Control Arm	S062082
	2004.05-2006.08	Front Axle Right Lower	SUV 4WD D27DT		Track Control Arm	S061487
	2004.05-2006.08	Front Axle Right Upper	SUV 4WD D27DT		Track Control Arm	S061758
	2004.05-2006.08	Front Axle Right Upper	SUV 4WD D27DT		Track Control Arm	S062083
	2004.05-2006.08	Front Axle Left & Right Lower	SUV 4WD D27DT		Control Arm Bushing	516397
	2004.05-2006.08	Front Axle Left & Right Lower	SUV 4WD D27DT	Date to:2006.02	Control Arm Bushing	516399
	2004.05-2006.08	Front Axle Left & Right Lower	SUV 4WD D27DT	Date from:2006.02-2006.04 for model year:2006	Control Arm Bushing	516400
	2004.05-2006.08	Front Axle Left & Right Lower	SUV 4WD D27DT		Control Arm Bushing	535135
	2004.05-2006.08	Front Axle Left & Right Lower	SUV 4WD D27DT		Control Arm Bushing	535137
	2004.05-2006.08	Front Axle Left & Right Upper	SUV 4WD D27DT		Control Arm Bushing	516395
	2004.05-2006.08	Rear Axle Left & Right Upper	SUV 4WD D27DT		Control Arm Bushing	516394
	2004.05-2006.08	Rear Axle Left & Right Lower Outer	SUV 4WD D27DT		Control Arm Bushing	516389
	2004.05-2006.08	Front Axle Left	SUV 4WD D27DT		Tie Rod End	S071021
	2004.05-2006.08	Front Axle Right	SUV 4WD D27DT		Tie Rod End	S071022
	2004.05-2006.08	Front Axle Left	SUV 4WD D27DT	Date to:2006.02	Rod/Strut, stabiliser	S051347
	2004.05-2006.08	Front Axle Left	SUV 4WD D27DT		Rod/Strut, stabiliser	S051380
	2004.05-2006.08	Front Axle Right	SUV 4WD D27DT	Date from:2006.02	Rod/Strut, stabiliser	S051328



	 YEAR	FITTING POSITION	BODY STYLE & DRIVE TYPE & ENGINE	REMARKS	PRODUCT	GSP Ref.
SSANGYONG						
Rexton						
2.7 (121 kw)	2004.05-2006.08	Front Axle Right	SUV 4WD D27DT	Date to:2006.02	Rod/Strut,stabiliser	S051348
	2004.05-2006.08	Rear Axle Left & Right	SUV 4WD D27DT		Rod/Strut,stabiliser	S050483
	2004.05-2006.08	Front Axle	SUV 4WD D27DT		Stabiliser Bushing	516396
	2014.02-	Front Axle Left Upper	SUV 4WD D27DT		Track Control Arm	S061757
	2014.02-	Front Axle Right Upper	SUV 4WD D27DT		Track Control Arm	S061758
	2014.02-	Front Axle Left & Right Lower	SUV 4WD D27DT		Ball Joint	S080691
	2014.02-	Front Axle Left & Right Lower	SUV 4WD D27DT		Control Arm Bushing	516400
	2014.02-	Front Axle Left & Right Lower	SUV 4WD D27DT		Control Arm Bushing	535137
	2014.02-	Front Axle Left & Right Upper	SUV 4WD D27DT		Control Arm Bushing	516395
	2014.02-	Rear Axle Left & Right Upper	SUV 4WD D27DT		Control Arm Bushing	516394
	2014.02-	Rear Axle Left & Right Lower Outer	SUV 4WD D27DT		Control Arm Bushing	516389
	2014.02-	Front Axle Left	SUV 4WD D27DT		Tie Rod End	S071021
	2014.02-	Front Axle Right	SUV 4WD D27DT		Tie Rod End	S071022
	2014.02-	Front Axle Left	SUV 4WD D27DT		Rod/Strut,stabiliser	S051380
	2014.02-	Front Axle Right	SUV 4WD D27DT		Rod/Strut,stabiliser	S051328
	2014.02-	Rear Axle Left & Right	SUV 4WD D27DT		Rod/Strut,stabiliser	S050483
	2014.02-	Front Axle	SUV 4WD D27DT		Stabiliser Bushing	516396
2.7 (130 kw)	2003.12-2006.08	Front Axle Left Lower	SUV 4WD D27DT		Track Control Arm	S061488
	2003.12-2006.08	Front Axle Right Lower	SUV 4WD D27DT		Track Control Arm	S061981
	2003.12-2006.08	Front Axle Left & Right Lower	SUV 4WD D27DT		Control Arm Bushing	516399
	2003.12-2006.08	Front Axle Left & Right Lower	SUV 4WD D27DT		Control Arm Bushing	516400
	2003.12-2006.08	Rear Axle Left & Right Upper	SUV 4WD D27DT		Control Arm Bushing	516394
	2003.12-2006.08	Rear Axle Left & Right Lower Outer	SUV 4WD D27DT		Control Arm Bushing	516389
2003.12-2006.08	Front Axle	SUV 4WD D27DT		Stabiliser Bushing	516396	
2.9 (88 kw)	2002.04-2006.08	Front Axle Left Lower	SUV 4WD 662925		Track Control Arm	S061486
	2002.04-2006.08	Front Axle Left Lower	SUV 4WD 662925		Track Control Arm	S061488
	2002.04-2006.08	Front Axle Left Upper	SUV 4WD 662925		Track Control Arm	S062082
	2002.04-2006.08	Front Axle Right Lower	SUV 4WD 662925		Track Control Arm	S061487
	2002.04-2006.08	Front Axle Right Lower	SUV 4WD 662925	Date from:2006.03	Track Control Arm	S061981
	2002.04-2006.08	Front Axle Right Upper	SUV 4WD 662925		Track Control Arm	S062083
	2002.04-2006.08	Front Axle Left & Right Lower	SUV 4WD 662925		Control Arm Bushing	516397
	2002.04-2006.08	Front Axle Left & Right Lower	SUV 4WD 662925		Control Arm Bushing	516399
	2002.04-2006.08	Front Axle Left & Right Lower	SUV 4WD 662925	Date from:2006.02 for model year:2006	Control Arm Bushing	516400
	2002.04-2006.08	Rear Axle Left & Right Upper	SUV 4WD 662925		Control Arm Bushing	516394
	2002.04-2006.08	Rear Axle Left & Right Lower Outer	SUV 4WD 662925		Control Arm Bushing	516389
	2002.04-2006.08	Front Axle Left & Right	SUV 4WD 662925		Tie Rod Axle Joint	S030968
	2002.04-2006.08	Front Axle Left	SUV 4WD 662925		Tie Rod End	S071021
	2002.04-2006.08	Front Axle Right	SUV 4WD 662925		Tie Rod End	S071022
	2002.04-2006.08	Front Axle Left	SUV 4WD 662925	Date from-to:2003.12-2006.02	Rod/Strut,stabiliser	S051347
	2002.04-2006.08	Front Axle Left	SUV 4WD 662925	Date from: 2006.03	Rod/Strut,stabiliser	S051380
	2002.04-2006.08	Front Axle Right	SUV 4WD 662925	Date from:2006.03	Rod/Strut,stabiliser	S051328
	2002.04-2006.08	Front Axle Right	SUV 4WD 662925	Date from-to:2003.12-2006.02	Rod/Strut,stabiliser	S051348
	2002.04-2006.08	Rear Axle Left & Right	SUV 4WD 662925		Rod/Strut,stabiliser	S050483
	2002.04-2006.08	Front Axle	SUV 4WD 662925		Stabiliser Bushing	516396
2002.04-2006.08	Front Axle	SUV 4WD 662925		Stabiliser Bushing Kit	516879S	
Rexton II						
2.7 (121 kw)	2006.09-2012.05	Front Axle Left Lower	SUV 4WD D27DT		Track Control Arm	S061486
	2006.09-2012.05	Front Axle Left Upper	SUV 4WD D27DT		Track Control Arm	S061757
	2006.09-2012.05	Front Axle Left Upper	SUV 4WD D27DT		Track Control Arm	S062082
	2006.09-2012.05	Front Axle Right Lower	SUV 4WD D27DT		Track Control Arm	S061487
	2006.09-2012.05	Front Axle Right Upper	SUV 4WD D27DT		Track Control Arm	S061758
	2006.09-2012.05	Front Axle Right Upper	SUV 4WD D27DT		Track Control Arm	S062083
	2006.09-2012.05	Front Axle Left & Right Lower	SUV 4WD D27DT		Control Arm Bushing	516397
	2006.09-2012.05	Front Axle Left & Right Lower	SUV 4WD D27DT	Date to:2006.02	Control Arm Bushing	516399
	2006.09-2012.05	Front Axle Left & Right Lower	SUV 4WD D27DT	Date from-to:2006.02-2006.04 for model year:2006	Control Arm Bushing	516400
	2006.09-2012.05	Front Axle Left & Right Lower	SUV 4WD D27DT		Control Arm Bushing	535135
	2006.09-2012.05	Front Axle Left & Right Lower	SUV 4WD D27DT		Control Arm Bushing	535137
	2006.09-2012.05	Front Axle Left & Right Upper	SUV 4WD D27DT		Control Arm Bushing	516395
	2006.09-2012.05	Rear Axle Left & Right Upper	SUV 4WD D27DT		Control Arm Bushing	516394
	2006.09-2012.05	Rear Axle Left & Right Lower Outer	SUV 4WD D27DT		Control Arm Bushing	516389
	2006.09-2012.05	Front Axle Left	SUV 4WD D27DT		Tie Rod End	S071021
	2006.09-2012.05	Front Axle Right	SUV 4WD D27DT		Tie Rod End	S071022
	2006.09-2012.05	Front Axle Left	SUV 4WD D27DT	Date to:2006.02	Rod/Strut,stabiliser	S051347
	2006.09-2012.05	Front Axle Left	SUV 4WD D27DT		Rod/Strut,stabiliser	S051380



	 YEAR	FITTING POSITION	BODY STYLE & DRIVE TYPE & ENGINE	REMARKS	PRODUCT	GSP Ref.	
SSANGYONG							
Rexton II							
2.7 (121 kw)	2006.09-2012.05	Front Axle Right	SUV 4WD D27DT	Date from:2006.02	Rod/Strut,stabiliser	S051328	
	2006.09-2012.05	Front Axle Right	SUV 4WD D27DT	Date to:2006.02	Rod/Strut,stabiliser	S051348	
	2006.09-2012.05	Rear Axle Left & Right	SUV 4WD D27DT		Rod/Strut,stabiliser	S050483	
	2006.09-2012.05	Front Axle	SUV 4WD D27DT		Stabiliser Bushing	516396	
2.7 (130 kw)	2006.09-2009.12	Front Axle Left Lower	SUV 4WD D27DT		Track Control Arm	S061488	
	2006.09-2009.12	Front Axle Right Lower	SUV 4WD D27DT		Track Control Arm	S061981	
	2006.09-2009.12	Front Axle Left & Right Lower	SUV 4WD D27DT	Date to:2006.02	Control Arm Bushing	516399	
	2006.09-2009.12	Front Axle Left & Right Lower	SUV 4WD D27DT		Control Arm Bushing	516399	
	2006.09-2009.12	Front Axle Left & Right Lower	SUV 4WD D27DT	Date from-to:2006.02-2006.04 for model year:2006	Control Arm Bushing	516400	
	2006.09-2009.12	Front Axle Left & Right Lower	SUV 4WD D27DT		Control Arm Bushing	516400	
	2006.09-2009.12	Rear Axle Left & Right Upper	SUV 4WD D27DT		Control Arm Bushing	516394	
	2006.09-2009.12	Rear Axle Left & Right Lower Outer	SUV 4WD D27DT		Control Arm Bushing	516389	
	2006.09-2009.12	Front Axle	SUV 4WD D27DT		Stabiliser Bushing	516396	
	2.7 (132 kw)	2008.02-2013.04	Front Axle Left Upper	SUV 4WD D27DTP		Track Control Arm	S061757
2008.02-2013.04		Front Axle Right Upper	SUV 4WD D27DTP		Track Control Arm	S061758	
2008.02-2013.04		Front Axle Left & Right Lower	SUV 4WD D27DTP		Ball Joint	S080691	
2008.02-2013.04		Front Axle Left & Right Lower	SUV 4WD D27DTP	Quantity:2	Control Arm Bushing	516397	
2008.02-2013.04		Front Axle Left & Right Lower	SUV 4WD D27DTP	Quantity:2	Control Arm Bushing	516399	
2008.02-2013.04		Front Axle Left & Right Lower	SUV 4WD D27DTP	Quantity:2	Control Arm Bushing	516400	
2008.02-2013.04		Front Axle Left & Right Upper	SUV 4WD D27DTP		Control Arm Bushing	516395	
2008.02-2013.04		Rear Axle Left & Right Upper	SUV 4WD D27DTP		Control Arm Bushing	516394	
2008.02-2013.04		Rear Axle Left & Right Lower Outer	SUV 4WD D27DTP		Control Arm Bushing	516389	
2008.02-2013.04		Front Axle Left	SUV 4WD D27DTP		Tie Rod End	S071021	
2008.02-2013.04		Front Axle Right	SUV 4WD D27DTP		Tie Rod End	S071022	
2008.02-2013.04		Front Axle Left	SUV 4WD D27DTP		Rod/Strut,stabiliser	S051380	
2008.02-2013.04		Front Axle Right	SUV 4WD D27DTP		Rod/Strut,stabiliser	S051328	
2008.02-2013.04		Rear Axle Left & Right	SUV 4WD D27DTP		Rod/Strut,stabiliser	S050483	
2008.02-2013.04		Front Axle	SUV 4WD D27DTP		Stabiliser Bushing	516396	
Rexton W							
2.7 (121 kw)		2012.07-	Front Axle Left Upper	SUV 4WD D27DT		Track Control Arm	S061757
		2012.07-	Front Axle Right Upper	SUV 4WD D27DT		Track Control Arm	S061758
	2012.07-	Front Axle Left & Right Lower	SUV 4WD D27DT		Ball Joint	S080691	
	2012.07-	Front Axle Left & Right Lower	SUV 4WD D27DT		Control Arm Bushing	516400	
	2012.07-	Front Axle Left & Right Lower	SUV 4WD D27DT		Control Arm Bushing	535137	
	2012.07-	Front Axle Left & Right Upper	SUV 4WD D27DT		Control Arm Bushing	516395	
	2012.07-	Rear Axle Left & Right Upper	SUV 4WD D27DT		Control Arm Bushing	516394	
	2012.07-	Rear Axle Left & Right Lower Outer	SUV 4WD D27DT		Control Arm Bushing	516389	
	2012.07-	Front Axle Left	SUV 4WD D27DT		Tie Rod End	S071021	
	2012.07-	Front Axle Right	SUV 4WD D27DT		Tie Rod End	S071022	
	2012.07-	Front Axle Left	SUV 4WD D27DT		Rod/Strut,stabiliser	S051380	
	2012.07-	Front Axle Right	SUV 4WD D27DT		Rod/Strut,stabiliser	S051328	
	2012.07-	Rear Axle Left & Right	SUV 4WD D27DT		Rod/Strut,stabiliser	S050483	
	2012.07-	Front Axle	SUV 4WD D27DT		Stabiliser Bushing	516396	
SUBARU							
Forester							
2.0 (110 kw)	2013.03-	Front Axle Left Lower	SUV 4WD FB20A/FB20B		Track Control Arm	S062907	
	2013.03-	Front Axle Right Lower	SUV 4WD FB20A/FB20B		Track Control Arm	S062908	
	2013.03-	Front Axle Left & Right Lower	SUV 4WD FB20A/FB20B		Ball Joint	S080218	
	2013.03-	Front Axle Left & Right Lower	SUV 4WD FB20A/FB20B		Control Arm Bushing	516151	
	2013.03-	Front Axle Left & Right Lower	SUV 4WD FB20A/FB20B		Control Arm Bushing	516196	
	2013.03-	Rear Axle Left & Right Centre Inner	SUV 4WD FB20A/FB20B		Control Arm Bushing	514982	
	2013.03-	Rear Axle Left & Right Lower Outer	SUV 4WD FB20A/FB20B		Control Arm Bushing	516158	
	2013.03-	Front Axle Left & Right	SUV 4WD FB20A/FB20B		Tie Rod Axle Joint	S031079	
	2013.03-	Front Axle Left & Right	SUV 4WD FB20A/FB20B		Tie Rod End	S070423	
	2013.03-	Front Axle Left & Right	SUV 4WD FB20A/FB20B		Rod/Strut,stabiliser	S050849	
	2013.03-	Rear Axle Left & Right	SUV 4WD FB20A/FB20B		Rod/Strut,stabiliser	S050924	
2.0 (177 kw)	2012.08-	Front Axle Left Lower	SUV 4WD FA20E/FA20F		Track Control Arm	S062907	
	2012.08-	Front Axle Right Lower	SUV 4WD FA20E/FA20F		Track Control Arm	S062908	
	2012.08-	Front Axle Left & Right Lower	SUV 4WD FA20E/FA20F		Ball Joint	S080218	
	2012.08-	Front Axle Left & Right Lower	SUV 4WD FA20E/FA20F		Control Arm Bushing	516151	
	2012.08-	Front Axle Left & Right Lower	SUV 4WD FA20E/FA20F		Control Arm Bushing	516196	
	2012.08-	Rear Axle Left & Right Centre Inner	SUV 4WD FA20E/FA20F		Control Arm Bushing	514982	
	2012.08-	Rear Axle Left & Right Lower Outer	SUV 4WD FA20E/FA20F		Control Arm Bushing	516158	
	2012.08-	Front Axle Left & Right	SUV 4WD FA20E/FA20F		Tie Rod Axle Joint	S031079	

	 YEAR	FITTING POSITION	BODY STYLE & DRIVE TYPE & ENGINE	REMARKS	PRODUCT	GSP Ref.
SUBARU						
Forester						
2.0 (177 kw)	2012.08-	Front Axle Left & Right	SUV 4WD FA20E/FA20F		Tie Rod End	S070423
	2012.08-	Front Axle Left & Right	SUV 4WD FA20E/FA20F		Rod/Strut,stabiliser	S050849
	2012.08-	Rear Axle Left & Right	SUV 4WD FA20E/FA20F		Rod/Strut,stabiliser	S050924
2.5 (126 kw)	2007.12-2013.12	Front Axle Left Lower	SUV FWD EJ253		Track Control Arm	S062921
	2007.12-2013.12	Front Axle Right Lower	SUV FWD EJ253		Track Control Arm	S062922
	2007.12-2013.12	Front Axle Left & Right Lower	SUV FWD EJ253		Control Arm Bushing	535460
2.5 (169 kw)	2008.06-2013.09	Front Axle Left Lower	SUV 4WD EJ255		Track Control Arm	S062921
	2008.06-2013.09	Front Axle Right Lower	SUV 4WD EJ255		Track Control Arm	S062922
	2008.06-2013.09	Front Axle Left & Right Lower	SUV 4WD EJ255		Ball Joint	S080218
	2008.06-2013.09	Front Axle Left & Right Lower	SUV 4WD EJ255		Control Arm Bushing	516196
	2008.06-2013.09	Front Axle Left & Right Lower	SUV 4WD EJ255	Date from:2013.05	Control Arm Bushing	516565
	2008.06-2013.09	Front Axle Left & Right Lower	SUV 4WD EJ255		Control Arm Bushing	535460
	2008.06-2013.09	Front Axle Left & Right Upper	SUV 4WD EJ255		Control Arm Bushing	516321
	2008.06-2013.09	Rear Axle Left & Right Upper	SUV 4WD EJ255	Date to:2012.10	Control Arm Bushing	516316
	2008.06-2013.09	Rear Axle Left & Right Upper	SUV 4WD EJ255	Date to:2012.10	Control Arm Bushing	517763
	2008.06-2013.09	Rear Axle Left & Right Centre Inner	SUV 4WD EJ255		Control Arm Bushing	514982
	2008.06-2013.09	Rear Axle Left & Right Lower Outer	SUV 4WD EJ255		Control Arm Bushing	516158
	2008.06-2013.09	Rear Axle Left & Right Upper	SUV 4WD EJ255		Control Arm Bushing Kit	517763S
	2008.06-2013.09	Rear Axle Left & Right Upper	SUV 4WD EJ255		Control Arm Bushing Kit	532662S
	2008.06-2013.09	Front Axle Left & Right	SUV 4WD EJ255		Tie Rod Axle Joint	S030723
	2008.06-2013.09	Front Axle Left	SUV 4WD EJ255		Tie Rod End	S071785
	2008.06-2013.09	Front Axle Right	SUV 4WD EJ255		Tie Rod End	S071784
	2008.06-2013.09	Front Axle Left & Right	SUV 4WD EJ255		Tie Rod End	S070423
	2008.06-2013.09	Front Axle Left & Right	SUV 4WD EJ255		Rod/Strut,stabiliser	S050550
	2008.06-2013.09	Rear Axle Left & Right	SUV 4WD EJ255		Rod/Strut,stabiliser	S050924
	2008.06-2013.09	Front Axle	SUV 4WD EJ255		Stabiliser Bushing	517273
	2008.06-2013.09	Rear Axle	SUV 4WD EJ255		Stabiliser Bushing	517279
	2008.06-2013.09	Front Axle	SUV 4WD EJ255		Steering Bushing	516319
Impreza						
1.5 (85 kw)	2008.09-2011.12	Front Axle Left & Right Lower	Hatchback 4WD EL154		Control Arm Bushing	535460
2.0 (110 kw)	2011.08-2016.12	Front Axle Left Lower	Saloon 4WD FB20B		Track Control Arm	S062086
	2011.08-2016.12	Front Axle Right Lower	Saloon 4WD FB20B		Track Control Arm	S062087
	2011.08-2016.12	Front Axle Left & Right Lower	Saloon 4WD FB20B		Ball Joint	S080218
	2011.08-2016.12	Front Axle Left & Right Lower	Saloon 4WD FB20B		Control Arm Bushing	516196
	2011.08-2016.12	Front Axle Left & Right Lower	Saloon 4WD FB20B	Date from-to:2013.05-2014.11	Control Arm Bushing	516565
	2011.08-2016.12	Front Axle Left & Right Lower	Saloon 4WD FB20B		Control Arm Bushing	535460
	2011.08-2016.12	Rear Axle Left & Right Upper	Saloon 4WD FB20B	Date from-to:2011.10-2016.10	Control Arm Bushing	516316
	2011.08-2016.12	Rear Axle Left & Right Upper	Saloon 4WD FB20B	Date from-to:2011.10-2016.10	Control Arm Bushing	517763
	2011.08-2016.12	Rear Axle Left & Right Centre Inner	Saloon 4WD FB20B		Control Arm Bushing	514982
	2011.08-2016.12	Rear Axle Left & Right Lower Outer	Saloon 4WD FB20B		Control Arm Bushing	516158
	2011.08-2016.12	Front Axle Left & Right	Saloon 4WD FB20B		Tie Rod End	S070423
	2011.08-2016.12	Front Axle Left & Right	Saloon 4WD FB20B		Rod/Strut,stabiliser	S050550
2.0 (155 kw)	1993.11-1998.08	Front Axle Left Lower	Saloon 4WD EJ20G		Track Control Arm	S060905
	1993.11-1998.08	Front Axle Right Lower	Saloon 4WD EJ20G		Track Control Arm	S060904
	1993.11-1998.08	Front Axle Left & Right Lower	Saloon 4WD EJ20G		Ball Joint	S080218
	1993.11-1998.08	Front Axle Left Lower	Saloon 4WD EJ20G		Control Arm Bushing	516684
	1993.11-1998.08	Front Axle Right Lower	Saloon 4WD EJ20G		Control Arm Bushing	516685
	1993.11-1998.08	Front Axle Left & Right Lower	Saloon 4WD EJ20G		Control Arm Bushing	511477
	1993.11-1998.08	Rear Axle Left & Right Lower	Saloon 4WD EJ20G		Control Arm Bushing	514912
	1993.11-1998.08	Rear Axle Left & Right Lower Inner	Saloon 4WD EJ20G		Control Arm Bushing	511480
	1993.11-1998.08	Rear Axle Left & Right Lower Outer	Saloon 4WD EJ20G		Control Arm Bushing	516420
	1993.11-1998.08	Front Axle Left & Right	Saloon 4WD EJ20G		Tie Rod Axle Joint	S030270
	1993.11-1998.08	Front Axle Left	Saloon 4WD EJ20G		Tie Rod End	S071785
	1993.11-1998.08	Front Axle Right	Saloon 4WD EJ20G		Tie Rod End	S071784
	1993.11-1998.08	Front Axle Left & Right	Saloon 4WD EJ20G		Tie Rod End	S070423
	1993.11-1998.08	Front Axle Left & Right	Saloon 4WD EJ20G		Rod/Strut,stabiliser	511481
	1993.11-1998.08	Rear Axle Left & Right	Saloon 4WD EJ20G		Rod/Strut,stabiliser	511482
	1993.11-1998.08	Rear Axle Left & Right	Saloon 4WD EJ20G		Rod/Strut,stabiliser	519241
	1993.11-1998.08	Front Axle	Saloon 4WD EJ20G		Stabiliser Bushing	517825
	1993.11-1998.08	Rear Axle	Saloon 4WD EJ20G		Stabiliser Bushing	517271
	1993.11-1998.08	Rear Axle	Saloon 4WD EJ20G		Stabiliser Bushing	517272
	1993.11-1998.08	Front Axle	Saloon 4WD EJ20G		Steering Rack Bellow Kit	540211K



	 YEAR	FITTING POSITION	BODY STYLE & DRIVE TYPE & ENGINE	REMARKS	PRODUCT	GSP Ref.
SUBARU						
Impreza Estate/Wagon Plus						
2.0 (85 kw)	1996.09-1998.08	Front Axle Left Lower	Estate FWD EJ20E		Track Control Arm	S060905
	1996.09-1998.08	Front Axle Right Lower	Estate FWD EJ20E		Track Control Arm	S060904
	1996.09-1998.08	Front Axle Left & Right Lower	Estate FWD EJ20E		Ball Joint	S080218
	1996.09-1998.08	Front Axle Right Lower	Estate FWD EJ20E		Control Arm Bushing	514274
	1996.09-1998.08	Front Axle Left & Right Lower	Estate FWD EJ20E		Control Arm Bushing	516479
	1996.09-1998.08	Rear Axle Left & Right Lower	Estate FWD EJ20E		Control Arm Bushing	511478
	1996.09-1998.08	Rear Axle Left & Right Lower	Estate FWD EJ20E		Control Arm Bushing	514912
	1996.09-1998.08	Front Axle Left	Estate FWD EJ20E		Tie Rod End	S071785
	1996.09-1998.08	Front Axle Right	Estate FWD EJ20E		Tie Rod End	S071784
Impreza WRX						
2.5 (169 kw)	2008.01-2013.08	Front Axle Left Lower	Hatchback 4WD EJ255		Track Control Arm	S062086
	2008.01-2013.08	Front Axle Right Lower	Hatchback 4WD EJ255		Track Control Arm	S062087
	2008.01-2013.08	Front Axle Right Lower	Hatchback 4WD EJ255		Track Control Arm	S062922
	2008.01-2013.08	Rear Axle Left Upper	Hatchback 4WD EJ255		Track Control Arm	S061699
	2008.01-2013.08	Rear Axle Right Upper	Hatchback 4WD EJ255		Track Control Arm	S061700
	2008.01-2013.08	Rear Axle Left & Right Lower Outer	Hatchback 4WD EJ255		Track Control Arm	S061701
	2008.01-2013.08	Front Axle Left & Right Lower	Hatchback 4WD EJ255		Ball Joint	S080218
	2008.01-2013.08	Front Axle Left & Right Lower	Hatchback 4WD EJ255		Control Arm Bushing	516196
	2008.01-2013.08	Front Axle Left & Right Lower	Hatchback 4WD EJ255		Control Arm Bushing	535460
	2008.01-2013.08	Rear Axle Left & Right Upper	Hatchback 4WD EJ255	Date to:2010.04	Control Arm Bushing	516316
	2008.01-2013.08	Rear Axle Left & Right Upper	Hatchback 4WD EJ255	Date to:2010.04	Control Arm Bushing	517763
	2008.01-2013.08	Rear Axle Left & Right Centre Inner	Hatchback 4WD EJ255		Control Arm Bushing	514982
	2008.01-2013.08	Rear Axle Left & Right Lower Outer	Hatchback 4WD EJ255		Control Arm Bushing	516158
	2008.01-2013.08	Rear Axle Left & Right Upper	Hatchback 4WD EJ255		Control Arm Bushing Kit	517763S
	2008.01-2013.08	Rear Axle Left & Right Upper	Hatchback 4WD EJ255		Control Arm Bushing Kit	532662S
	2008.01-2013.08	Front Axle Left & Right	Hatchback 4WD EJ255	For Right-Hand Drive Vehicles	Tie Rod Axle Joint	S030723
	2008.01-2013.08	Front Axle Left & Right	Hatchback 4WD EJ255	L:388mm	Tie Rod Axle Joint	S030975
	2008.01-2013.08	Front Axle Left & Right	Hatchback 4WD EJ255		Tie Rod End	S070423
	2008.01-2013.08	Front Axle Left & Right	Hatchback 4WD EJ255		Rod/Strut, stabiliser	S050550
	2008.01-2013.08	Front Axle	Hatchback 4WD EJ255		Stabiliser Bushing	517273
	2008.01-2013.08	Rear Axle	Hatchback 4WD EJ255		Stabiliser Bushing	517278
	2008.01-2013.08	Rear Axle	Hatchback 4WD EJ255		Stabiliser Bushing	517279
	2008.01-2013.08	Front Axle	Hatchback 4WD EJ255		Steering Bushing	516319
2.5 (199 kw)	2008.01-2014.05	Front Axle Left Lower	Saloon 4WD EJ255		Track Control Arm	S062086
	2008.01-2014.05	Front Axle Right Lower	Saloon 4WD EJ255		Track Control Arm	S062087
	2008.01-2014.05	Rear Axle Left Upper	Saloon 4WD EJ255		Track Control Arm	S061699
	2008.01-2014.05	Rear Axle Right Upper	Saloon 4WD EJ255		Track Control Arm	S061700
	2008.01-2014.05	Front Axle Left & Right Lower	Saloon 4WD EJ255		Ball Joint	S080218
	2008.01-2014.05	Front Axle Left & Right Lower	Saloon 4WD EJ255		Control Arm Bushing	516196
	2008.01-2014.05	Front Axle Left & Right Lower	Saloon 4WD EJ255	Date from-to:2013.05-2014.11	Control Arm Bushing	516565
	2008.01-2014.05	Front Axle Left & Right Lower	Saloon 4WD EJ255		Control Arm Bushing	535460
	2008.01-2014.05	Rear Axle Left & Right Upper	Saloon 4WD EJ255	Date to:2014.01	Control Arm Bushing	516316
	2008.01-2014.05	Rear Axle Left & Right Upper	Saloon 4WD EJ255	Date to:2014.01	Control Arm Bushing	517763
	2008.01-2014.05	Rear Axle Left & Right Centre Inner	Saloon 4WD EJ255		Control Arm Bushing	514982
	2008.01-2014.05	Rear Axle Left & Right Lower Outer	Saloon 4WD EJ255		Control Arm Bushing	516158
	2008.01-2014.05	Front Axle Left & Right	Saloon 4WD EJ255		Tie Rod Axle Joint	S030723
	2008.01-2014.05	Front Axle Left & Right	Saloon 4WD EJ255		Tie Rod End	S070423
	2008.01-2014.05	Front Axle Left & Right	Saloon 4WD EJ255		Rod/Strut, stabiliser	S050550
	2008.01-2014.05	Front Axle	Saloon 4WD EJ255		Stabiliser Bushing	517273
2.5 (221 kw)	2008.01-2013.08	Front Axle Left Lower	Hatchback 4WD EJ257		Track Control Arm	S062086
	2008.01-2013.08	Front Axle Right Lower	Hatchback 4WD EJ257		Track Control Arm	S062087
	2008.01-2013.08	Rear Axle Left Upper	Hatchback 4WD EJ257		Track Control Arm	S061699
	2008.01-2013.08	Rear Axle Right Upper	Hatchback 4WD EJ257		Track Control Arm	S061700
	2008.01-2013.08	Rear Axle Left & Right Lower Outer	Hatchback 4WD EJ257		Track Control Arm	S061701
	2008.01-2013.08	Front Axle Left & Right Lower	Hatchback 4WD EJ257		Ball Joint	S080218
	2008.01-2013.08	Front Axle Left & Right Lower	Hatchback 4WD EJ257		Control Arm Bushing	516196
	2008.01-2013.08	Front Axle Left & Right Lower	Hatchback 4WD EJ257	Date from:2013.05	Control Arm Bushing	516565
	2008.01-2013.08	Front Axle Left & Right Lower	Hatchback 4WD EJ257		Control Arm Bushing	535460
	2008.01-2013.08	Rear Axle Left & Right Upper	Hatchback 4WD EJ257		Control Arm Bushing	516316
	2008.01-2013.08	Rear Axle Left & Right Upper	Hatchback 4WD EJ257		Control Arm Bushing	517763
	2008.01-2013.08	Rear Axle Left & Right Centre Inner	Hatchback 4WD EJ257		Control Arm Bushing	514982
	2008.01-2013.08	Rear Axle Left & Right Lower Outer	Hatchback 4WD EJ257		Control Arm Bushing	516158
	2008.01-2013.08	Rear Axle Left & Right Upper	Hatchback 4WD EJ257		Control Arm Bushing Kit	517763S
	2008.01-2013.08	Rear Axle Left & Right Upper	Hatchback 4WD EJ257		Control Arm Bushing Kit	532662S



	 YEAR	FITTING POSITION	BODY STYLE & DRIVE TYPE & ENGINE	REMARKS	PRODUCT	GSP Ref.
SUBARU						
Impreza WRX						
2.5 (221 kw)	2008.01-2013.08	Front Axle Left & Right	Hatchback 4WD EJ257	For Right-Hand Drive Vehicles	Tie Rod Axle Joint	S030723
	2008.01-2013.08	Front Axle Left & Right	Hatchback 4WD EJ257	L:388mm	Tie Rod Axle Joint	S030975
	2008.01-2013.08	Front Axle Left & Right	Hatchback 4WD EJ257		Tie Rod End	S070423
	2008.01-2013.08	Front Axle Left & Right	Hatchback 4WD EJ257		Rod/Strut,stabiliser	S050550
	2008.01-2013.08	Front Axle	Hatchback 4WD EJ257		Stabiliser Bushing	517273
	2008.01-2013.08	Rear Axle	Hatchback 4WD EJ257		Stabiliser Bushing	517278
	2008.01-2013.08	Rear Axle	Hatchback 4WD EJ257		Stabiliser Bushing	517279
2.5 (228 kw)	2010.09-2013.08	Front Axle Left & Right Lower	Hatchback 4WD EJ257		Control Arm Bushing	535460
	2010.09-2015.12	Front Axle Left & Right Lower	Saloon 4WD EJ257		Control Arm Bushing	535460
Legacy						
2.0 (85 kw)	1991.08-1993.12	Front Axle Left Lower	Saloon FWD EJ20E		Track Control Arm	S060905
	1991.08-1993.12	Front Axle Right Lower	Saloon FWD EJ20E		Track Control Arm	S060904
	1991.08-1993.12	Front Axle Left & Right Lower	Saloon FWD EJ20E		Ball Joint	S080218
	1991.08-1993.12	Front Axle Right Lower	Saloon FWD EJ20E		Control Arm Bushing	514274
	1991.08-1993.12	Front Axle Left & Right Lower	Saloon FWD EJ20E		Control Arm Bushing	516479
	1991.08-1993.12	Rear Axle Left & Right Lower	Saloon FWD EJ20E		Control Arm Bushing	511478
	1991.08-1993.12	Rear Axle Left & Right Lower	Saloon FWD EJ20E		Control Arm Bushing	514912
	1991.08-1993.12	Front Axle Left & Right	Saloon FWD EJ20E		Tie Rod End	S070423
	1994.01-1998.09	Front Axle Left Lower	Saloon 4WD EJ20E		Track Control Arm	S060905
	1994.01-1998.09	Front Axle Right Lower	Saloon 4WD EJ20E		Track Control Arm	S060904
	1994.01-1998.09	Front Axle Left & Right Lower	Saloon 4WD EJ20E		Ball Joint	S080218
	1994.01-1998.09	Front Axle Left Lower	Saloon 4WD EJ20E		Control Arm Bushing	516684
	1994.01-1998.09	Front Axle Right Lower	Saloon 4WD EJ20E		Control Arm Bushing	514274
	1994.01-1998.09	Front Axle Right Lower	Saloon 4WD EJ20E		Control Arm Bushing	516685
	1994.01-1998.09	Front Axle Left & Right Lower	Saloon 4WD EJ20E		Control Arm Bushing	511477
	1994.01-1998.09	Front Axle Left & Right Lower	Saloon 4WD EJ20E		Control Arm Bushing	516479
	1994.01-1998.09	Rear Axle Left & Right Lower	Saloon 4WD EJ20E		Control Arm Bushing	511478
	1994.01-1998.09	Rear Axle Left & Right Lower	Saloon 4WD EJ20E		Control Arm Bushing	514912
	1994.01-1998.09	Rear Axle Left & Right Lower Inner	Saloon 4WD EJ20E		Control Arm Bushing	511480
	1994.01-1998.09	Rear Axle Left & Right Lower Outer	Saloon 4WD EJ20E		Control Arm Bushing	516420
	1994.01-1998.09	Front Axle Left & Right	Saloon 4WD EJ20E		Tie Rod Axle Joint	S030270
	1994.01-1998.09	Front Axle Left & Right	Saloon 4WD EJ20E		Tie Rod End	S070423
	1994.01-1998.09	Front Axle Left & Right	Saloon 4WD EJ20E		Rod/Strut,stabiliser	511481
	1994.01-1998.09	Rear Axle Left & Right	Saloon 4WD EJ20E		Rod/Strut,stabiliser	511482
	1994.01-1998.09	Rear Axle Left & Right	Saloon 4WD EJ20E		Rod/Strut,stabiliser	519241
	1994.01-1998.09	Front Axle	Saloon 4WD EJ20E		Stabiliser Bushing	517572
	1994.01-1998.09	Front Axle	Saloon 4WD EJ20E		Stabiliser Bushing	517825
	1994.01-1999.03	Front Axle Left Lower	Saloon FWD EJ20E		Track Control Arm	S060905
	1994.01-1999.03	Front Axle Right Lower	Saloon FWD EJ20E		Track Control Arm	S060904
	1994.01-1999.03	Front Axle Left & Right Lower	Saloon FWD EJ20E		Ball Joint	S080218
	1994.01-1999.03	Front Axle Left Lower	Saloon FWD EJ20E		Control Arm Bushing	516684
	1994.01-1999.03	Front Axle Right Lower	Saloon FWD EJ20E		Control Arm Bushing	514274
	1994.01-1999.03	Front Axle Right Lower	Saloon FWD EJ20E		Control Arm Bushing	516685
	1994.01-1999.03	Front Axle Left & Right Lower	Saloon FWD EJ20E		Control Arm Bushing	511477
	1994.01-1999.03	Front Axle Left & Right Lower	Saloon FWD EJ20E		Control Arm Bushing	516479
	1994.01-1999.03	Rear Axle Left & Right Lower	Saloon FWD EJ20E		Control Arm Bushing	511478
	1994.01-1999.03	Rear Axle Left & Right Lower	Saloon FWD EJ20E		Control Arm Bushing	514912
	1994.01-1999.03	Rear Axle Left & Right Lower Inner	Saloon FWD EJ20E		Control Arm Bushing	511480
	1994.01-1999.03	Rear Axle Left & Right Lower Outer	Saloon FWD EJ20E		Control Arm Bushing	516420
	1994.01-1999.03	Front Axle Left & Right	Saloon FWD EJ20E		Tie Rod Axle Joint	S030270
1994.01-1999.03	Front Axle Left & Right	Saloon FWD EJ20E		Tie Rod End	S070423	
1994.01-1999.03	Front Axle Left & Right	Saloon FWD EJ20E		Rod/Strut,stabiliser	511481	
1994.01-1999.03	Rear Axle Left & Right	Saloon FWD EJ20E		Rod/Strut,stabiliser	511482	
1994.01-1999.03	Front Axle	Saloon FWD EJ20E		Stabiliser Bushing	517572	
2.0 (118 kw)	2009.06-2015.12	Front Axle Left & Right Lower	Saloon 4WD EJ204		Control Arm Bushing	535460
	2009.06-2015.12	Front Axle Left & Right	Saloon 4WD EJ204		Tie Rod Axle Joint	S030690
	2009.06-2015.12	Front Axle Left & Right	Saloon 4WD EJ204		Tie Rod End	S070423
	2009.06-2015.12	Front Axle Left & Right	Saloon 4WD EJ204		Rod/Strut,stabiliser	S051311
2.2 (94 kw)	1994.01-1999.03	Front Axle Left Lower	Saloon 4WD EJ22E		Track Control Arm	S060905
	1994.01-1999.03	Front Axle Right Lower	Saloon 4WD EJ22E		Track Control Arm	S060904
	1994.01-1999.03	Front Axle Left & Right Lower	Saloon 4WD EJ22E		Ball Joint	S080218
	1994.01-1999.03	Front Axle Left Lower	Saloon 4WD EJ22E		Control Arm Bushing	516684
	1994.01-1999.03	Front Axle Right Lower	Saloon 4WD EJ22E		Control Arm Bushing	516685



	 YEAR	FITTING POSITION	BODY STYLE & DRIVE TYPE & ENGINE	REMARKS	PRODUCT	GSP Ref.
SUBARU Legacy						
2.2 (94 kw)	1994.01-1999.03	Front Axle Left & Right Lower	Saloon 4WD EJ22E		Control Arm Bushing	511477
	1994.01-1999.03	Front Axle Left & Right Lower	Saloon 4WD EJ22E		Control Arm Bushing	516479
	1994.01-1999.03	Rear Axle Left & Right Lower	Saloon 4WD EJ22E		Control Arm Bushing	514912
	1994.01-1999.03	Rear Axle Left & Right Lower Inner	Saloon 4WD EJ22E		Control Arm Bushing	511480
	1994.01-1999.03	Rear Axle Left & Right Lower Outer	Saloon 4WD EJ22E		Control Arm Bushing	516420
	1994.01-1999.03	Front Axle Left & Right	Saloon 4WD EJ22E		Tie Rod Axle Joint	S030270
	1994.01-1999.03	Front Axle Left & Right	Saloon 4WD EJ22E		Tie Rod End	S070423
	1994.01-1999.03	Front Axle Left & Right	Saloon 4WD EJ22E		Rod/Strut,stabiliser	511481
	1994.01-1999.03	Rear Axle Left & Right	Saloon 4WD EJ22E		Rod/Strut,stabiliser	511482
	1994.01-1999.03	Rear Axle Left & Right	Saloon 4WD EJ22E		Rod/Strut,stabiliser	519241
	1994.01-1999.03	Front Axle	Saloon 4WD EJ22E		Stabiliser Bushing	517572
	1994.01-1999.03	Front Axle	Saloon 4WD EJ22E		Stabiliser Bushing	517825
2.2 (96 kw)	1994.01-1999.03	Front Axle Left Lower	Saloon 4WD EJ22E		Track Control Arm	S060905
	1994.01-1999.03	Front Axle Right Lower	Saloon 4WD EJ22E		Track Control Arm	S060904
	1994.01-1999.03	Front Axle Left & Right Lower	Saloon 4WD EJ22E		Ball Joint	S080218
	1994.01-1999.03	Front Axle Left Lower	Saloon 4WD EJ22E		Control Arm Bushing	516684
	1994.01-1999.03	Front Axle Right Lower	Saloon 4WD EJ22E		Control Arm Bushing	516685
	1994.01-1999.03	Front Axle Left & Right Lower	Saloon 4WD EJ22E		Control Arm Bushing	511477
	1994.01-1999.03	Front Axle Left & Right Lower	Saloon 4WD EJ22E		Control Arm Bushing	516479
	1994.01-1999.03	Rear Axle Left & Right Lower	Saloon 4WD EJ22E		Control Arm Bushing	514912
	1994.01-1999.03	Rear Axle Left & Right Lower Inner	Saloon 4WD EJ22E		Control Arm Bushing	511480
	1994.01-1999.03	Rear Axle Left & Right Lower Outer	Saloon 4WD EJ22E		Control Arm Bushing	516420
	1994.01-1999.03	Front Axle Left & Right	Saloon 4WD EJ22E		Tie Rod Axle Joint	S030270
	1994.01-1999.03	Front Axle Left & Right	Saloon 4WD EJ22E		Tie Rod End	S070423
	1994.01-1999.03	Front Axle Left & Right	Saloon 4WD EJ22E		Rod/Strut,stabiliser	511481
	1994.01-1999.03	Rear Axle Left & Right	Saloon 4WD EJ22E		Rod/Strut,stabiliser	511482
	1994.01-1999.03	Rear Axle Left & Right	Saloon 4WD EJ22E		Rod/Strut,stabiliser	519241
	1994.01-1999.03	Front Axle	Saloon 4WD EJ22E		Stabiliser Bushing	517572
	1994.01-1999.03	Front Axle	Saloon 4WD EJ22E		Stabiliser Bushing	517825
2.5 (110 kw)	1996.01-1998.12	Front Axle Left Lower	Saloon 4WD EJ25D		Track Control Arm	S060905
	1996.01-1998.12	Front Axle Right Lower	Saloon 4WD EJ25D		Track Control Arm	S060904
	1996.01-1998.12	Front Axle Left & Right Lower	Saloon 4WD EJ25D		Ball Joint	S080218
	1996.01-1998.12	Front Axle Left Lower	Saloon 4WD EJ25D		Control Arm Bushing	516684
	1996.01-1998.12	Front Axle Right Lower	Saloon 4WD EJ25D	Date from:199804	Control Arm Bushing	514274
	1996.01-1998.12	Front Axle Right Lower	Saloon 4WD EJ25D		Control Arm Bushing	516685
	1996.01-1998.12	Front Axle Left & Right Lower	Saloon 4WD EJ25D		Control Arm Bushing	511477
	1996.01-1998.12	Front Axle Left & Right Lower	Saloon 4WD EJ25D	Date from:1998.04	Control Arm Bushing	516479
	1996.01-1998.12	Rear Axle Left & Right Lower	Saloon 4WD EJ25D	Date from:1997.02	Control Arm Bushing	511478
	1996.01-1998.12	Rear Axle Left & Right Lower	Saloon 4WD EJ25D		Control Arm Bushing	514912
	1996.01-1998.12	Rear Axle Left & Right Lower Inner	Saloon 4WD EJ25D		Control Arm Bushing	511480
	1996.01-1998.12	Rear Axle Left & Right Lower Outer	Saloon 4WD EJ25D		Control Arm Bushing	516420
	1996.01-1998.12	Front Axle Left & Right	Saloon 4WD EJ25D		Tie Rod Axle Joint	S030270
	1996.01-1998.12	Front Axle Left & Right	Saloon 4WD EJ25D		Tie Rod End	S070423
	1996.01-1998.12	Front Axle Left & Right	Saloon 4WD EJ25D		Rod/Strut,stabiliser	511481
	1996.01-1998.12	Rear Axle Left & Right	Saloon 4WD EJ25D		Rod/Strut,stabiliser	511482
	1996.01-1998.12	Front Axle	Saloon 4WD EJ25D		Stabiliser Bushing	517572
2.5 (115 kw)	1998.10-2003.08	Front Axle Left Lower	Saloon 4WD EJ251		Track Control Arm	S060905
	1998.10-2003.08	Front Axle Right Lower	Saloon 4WD EJ251		Track Control Arm	S060904
	1998.10-2003.08	Rear Axle Left & Right Lower Outer	Saloon 4WD EJ251		Track Control Arm	S061701
	1998.10-2003.08	Front Axle Left & Right Lower	Saloon 4WD EJ251		Ball Joint	S080218
	1998.10-2003.08	Front Axle Left Lower	Saloon 4WD EJ251		Control Arm Bushing	514273
	1998.10-2003.08	Front Axle Right Lower	Saloon 4WD EJ251		Control Arm Bushing	514274
	1998.10-2003.08	Front Axle Left & Right Lower	Saloon 4WD EJ251		Control Arm Bushing	511477
	1998.10-2003.08	Rear Axle Left & Right Lower	Saloon 4WD EJ251		Control Arm Bushing	514988
	1998.10-2003.08	Rear Axle Left & Right Lower	Saloon 4WD EJ251		Control Arm Bushing	516026
	1998.10-2003.08	Rear Axle Left & Right Centre Inner	Saloon 4WD EJ251		Control Arm Bushing	514982
	1998.10-2003.08	Front Axle Left & Right	Saloon 4WD EJ251	Date to:2000.02.For Right-Hand Drive Vehicles	Tie Rod Axle Joint	S030270
	1998.10-2003.08	Front Axle Left & Right	Saloon 4WD EJ251	Date from:2000.02.For Right-Hand Drive Vehicles	Tie Rod Axle Joint	S030690
	1998.10-2003.08	Front Axle Left & Right	Saloon 4WD EJ251	Date from:2001.12.For Left-Hand Drive Vehicles	Tie Rod Axle Joint	S030738
	1998.10-2003.08	Front Axle Left & Right	Saloon 4WD EJ251		Tie Rod End	S070423
	1998.10-2003.08	Front Axle Left & Right	Saloon 4WD EJ251		Rod/Strut,stabiliser	511481
	1998.10-2003.08	Rear Axle Left & Right	Saloon 4WD EJ251		Rod/Strut,stabiliser	519241
	1998.10-2003.08	Rear Axle Left & Right	Saloon 4WD EJ251		Rod/Strut,stabiliser	S050552
	1998.10-2003.08	Front Axle	Saloon 4WD EJ251		Stabiliser Bushing	517274



	 YEAR	FITTING POSITION	BODY STYLE & DRIVE TYPE & ENGINE	REMARKS	PRODUCT	GSP Ref.	
SUBARU							
Legacy							
2.5 (115 kw)	1998.10-2003.08	Front Axle	Saloon 4WD EJ251		Stabiliser Bushing	517572	
	1998.10-2003.08	Front Axle	Saloon 4WD EJ251		Stabiliser Bushing	517825	
	1998.10-2003.08	Rear Axle	Saloon 4WD EJ251		Stabiliser Bushing	517277	
2.5 (195 kw)	2009.05-2014.12	Front Axle Left Lower	Saloon 4WD EJ255		Track Control Arm	S062911	
	2009.05-2014.12	Front Axle Right Lower	Saloon 4WD EJ255		Track Control Arm	S062912	
	2009.05-2014.12	Rear Axle Left Upper	Saloon 4WD EJ255		Track Control Arm	S061699	
	2009.05-2014.12	Rear Axle Right Upper	Saloon 4WD EJ255		Track Control Arm	S061700	
	2009.05-2014.12	Front Axle Left & Right Lower	Saloon 4WD EJ255		Ball Joint	S080218	
	2009.05-2014.12	Front Axle Left & Right Lower	Saloon 4WD EJ255	Date to:2014.11	Control Arm Bushing	516565	
	2009.05-2014.12	Front Axle Left & Right Lower	Saloon 4WD EJ255		Control Arm Bushing	535460	
	2009.05-2014.12	Rear Axle Left & Right Upper	Saloon 4WD EJ255	Date to:2014.11	Control Arm Bushing	516316	
	2009.05-2014.12	Rear Axle Left & Right Upper	Saloon 4WD EJ255	Date to:2014.11	Control Arm Bushing	517763	
	2009.05-2014.12	Rear Axle Left & Right Centre Inner	Saloon 4WD EJ255		Control Arm Bushing	514982	
	2009.05-2014.12	Rear Axle Left & Right Lower Outer	Saloon 4WD EJ255		Control Arm Bushing	516158	
	2009.05-2014.12	Rear Axle Left & Right Upper	Saloon 4WD EJ255		Control Arm Bushing Kit	517763S	
	2009.05-2014.12	Rear Axle Left & Right Upper	Saloon 4WD EJ255		Control Arm Bushing Kit	532662S	
	2009.05-2014.12	Front Axle Left & Right	Saloon 4WD EJ255		Tie Rod End	S070423	
	2009.05-2014.12	Front Axle Left & Right	Saloon 4WD EJ255		Rod/Strut,stabiliser	S051311	
	2009.05-2014.12	Rear Axle	Saloon 4WD EJ255		Stabiliser Bushing	517279	
	2009.05-2014.12	Front Axle	Saloon 4WD EJ255		Steering Bushing	516319	
3.6 (191 kw)	2015.01-	Front Axle Left Lower	Saloon 4WD EZ36D		Track Control Arm	S062905	
	2015.01-	Front Axle Right Lower	Saloon 4WD EZ36D		Track Control Arm	S062906	
	2015.01-	Front Axle Left & Right Lower	Saloon 4WD EZ36D		Ball Joint	S080218	
	2015.01-	Front Axle Left & Right Lower	Saloon 4WD EZ36D		Control Arm Bushing	535460	
	2015.01-	Rear Axle Left & Right Upper	Saloon 4WD EZ36D		Control Arm Bushing	516316	
	2015.01-	Rear Axle Left & Right Upper	Saloon 4WD EZ36D		Control Arm Bushing	517763	
	2015.01-	Rear Axle Left & Right Centre Inner	Saloon 4WD EZ36D		Control Arm Bushing	514982	
	2015.01-	Rear Axle Left & Right Lower Outer	Saloon 4WD EZ36D		Control Arm Bushing	516158	
	2015.01-	Front Axle Left & Right	Saloon 4WD EZ36D		Tie Rod Axle Joint	S030690	
	2015.01-	Front Axle Left & Right	Saloon 4WD EZ36D		Tie Rod Axle Joint	S030723	
	2015.01-	Front Axle Left & Right	Saloon 4WD EZ36D		Rod/Strut,stabiliser	S051311	
Legacy Estate/Wagon							
2.0 (85 kw)	1994.09-1998.11	Front Axle Left Lower	Estate FWD EJ20E		Track Control Arm	S060905	
	1994.09-1998.11	Front Axle Right Lower	Estate FWD EJ20E		Track Control Arm	S060904	
	1994.09-1998.11	Front Axle Left & Right Lower	Estate FWD EJ20E		Ball Joint	S080218	
	1994.09-1998.11	Front Axle Left Lower	Estate FWD EJ20E		Control Arm Bushing	516684	
	1994.09-1998.11	Front Axle Right Lower	Estate FWD EJ20E		Control Arm Bushing	516685	
	1994.09-1998.11	Front Axle Left & Right Lower	Estate FWD EJ20E		Control Arm Bushing	511477	
	1994.09-1998.11	Front Axle Left & Right Lower	Estate FWD EJ20E		Control Arm Bushing	516479	
	1994.09-1998.11	Rear Axle Left & Right Lower	Estate FWD EJ20E		Control Arm Bushing	514912	
	1994.09-1998.11	Rear Axle Left & Right Lower	Estate FWD EJ20E		Control Arm Bushing	516027	
	1994.09-1998.11	Rear Axle Left & Right Lower Outer	Estate FWD EJ20E		Control Arm Bushing	516420	
	1994.09-1998.11	Front Axle Left & Right	Estate FWD EJ20E		Tie Rod Axle Joint	S030270	
	1994.09-1998.11	Front Axle Left & Right	Estate FWD EJ20E		Tie Rod End	S070423	
	1994.09-1998.11	Front Axle Left & Right	Estate FWD EJ20E		Rod/Strut,stabiliser	511481	
	1994.09-1998.11	Rear Axle Left & Right	Estate FWD EJ20E		Rod/Strut,stabiliser	511482	
	1994.09-1998.11	Rear Axle Left & Right	Estate FWD EJ20E		Rod/Strut,stabiliser	519241	
	1994.09-1998.11	Front Axle	Estate FWD EJ20E		Stabiliser Bushing	517572	
	1994.09-1998.11	Front Axle	Estate FWD EJ20E		Stabiliser Bushing	517825	
	2.5 (110 kw)	1996.01-1998.11	Front Axle Left Lower	Estate 4WD EJ25D		Track Control Arm	S060905
		1996.01-1998.11	Front Axle Right Lower	Estate 4WD EJ25D		Track Control Arm	S060904
1996.01-1998.11		Front Axle Left & Right Lower	Estate 4WD EJ25D		Ball Joint	S080218	
1996.01-1998.11		Front Axle Left Lower	Estate 4WD EJ25D		Control Arm Bushing	516684	
1996.01-1998.11		Front Axle Right Lower	Estate 4WD EJ25D		Control Arm Bushing	514274	
1996.01-1998.11		Front Axle Right Lower	Estate 4WD EJ25D		Control Arm Bushing	516685	
1996.01-1998.11		Front Axle Left & Right Lower	Estate 4WD EJ25D		Control Arm Bushing	511477	
1996.01-1998.11		Front Axle Left & Right Lower	Estate 4WD EJ25D		Control Arm Bushing	516479	
1996.01-1998.11		Rear Axle Left & Right Lower	Estate 4WD EJ25D	Date from:1997.02	Control Arm Bushing	511478	
1996.01-1998.11		Rear Axle Left & Right Lower	Estate 4WD EJ25D		Control Arm Bushing	514912	
1996.01-1998.11		Rear Axle Left & Right Lower Inner	Estate 4WD EJ25D		Control Arm Bushing	511480	
1996.01-1998.11		Rear Axle Left & Right Lower Outer	Estate 4WD EJ25D		Control Arm Bushing	516420	
1996.01-1998.11		Front Axle Left & Right	Estate 4WD EJ25D		Tie Rod Axle Joint	S030270	
1996.01-1998.11		Front Axle Left & Right	Estate 4WD EJ25D		Tie Rod End	S070423	
1996.01-1998.11		Front Axle Left & Right	Estate 4WD EJ25D		Rod/Strut,stabiliser	511481	



	 YEAR	FITTING POSITION	BODY STYLE & DRIVE TYPE & ENGINE	REMARKS	PRODUCT	GSP Ref.
SUBARU						
Legacy Estate/Wagon						
2.5 (110 kw)	1996.01-1998.11	Rear Axle Left & Right	Estate 4WD EJ25D		Rod/Strut, stabiliser	511482
	1996.01-1998.11	Front Axle	Estate 4WD EJ25D		Stabiliser Bushing	517572
Legacy II						
2.2 (94 kw)	1994.07-1998.11	Front Axle Left Lower	Saloon FWD EJ22		Track Control Arm	S060905
	1994.07-1998.11	Front Axle Right Lower	Saloon FWD EJ22		Track Control Arm	S060904
Outback						
2.5 (115 kw)	2000.01-2003.08	Front Axle Left Lower	Estate 4WD EJ251		Track Control Arm	S060905
	2000.01-2003.08	Front Axle Right Lower	Estate 4WD EJ251		Track Control Arm	S060904
	2000.01-2003.08	Rear Axle Left & Right Lower Outer	Estate 4WD EJ251		Track Control Arm	S061701
	2000.01-2003.08	Front Axle Left & Right Lower	Estate 4WD EJ251		Ball Joint	S080218
	2000.01-2003.08	Rear Axle Left & Right Lower	Estate 4WD EJ251		Control Arm Bushing	516026
	2000.01-2003.08	Rear Axle Left & Right Centre Inner	Estate 4WD EJ251		Control Arm Bushing	514982
	2000.01-2003.08	Front Axle Left & Right	Estate 4WD EJ251	Date to:2001.01.For Right-Hand Drive Vehicles	Tie Rod Axle Joint	S030270
	2000.01-2003.08	Front Axle Left & Right	Estate 4WD EJ251	For Right-Hand Drive Vehicles	Tie Rod Axle Joint	S030690
	2000.01-2003.08	Front Axle Left & Right	Estate 4WD EJ251	Date from:2001.12.For Left-Hand Drive Vehicles	Tie Rod Axle Joint	S030738
	2000.01-2003.08	Front Axle Left & Right	Estate 4WD EJ251		Tie Rod End	S070423
	2000.01-2003.08	Front Axle Left & Right	Estate 4WD EJ251		Rod/Strut, stabiliser	S050550
	2000.01-2003.08	Rear Axle Left & Right	Estate 4WD EJ251		Rod/Strut, stabiliser	S050552
	2000.01-2003.08	Rear Axle Left & Right	Estate 4WD EJ251		Rod/Strut, stabiliser	S050632
	2000.01-2003.08	Front Axle	Estate 4WD EJ251		Stabiliser Bushing	517572
3.0 (180 kw)	2003.09-2009.09	Front Axle Left & Right Lower	Estate 4WD 30D/EZ30D/EZ30R		Ball Joint	S080218
	2003.09-2009.09	Front Axle Left & Right Lower	Estate 4WD 30D/EZ30D/EZ30R	Date to:2005.11	Control Arm Bushing	516196
	2003.09-2009.09	Front Axle Left & Right Lower	Estate 4WD 30D/EZ30D/EZ30R		Control Arm Bushing	535460
	2003.09-2009.09	Rear Axle Left & Right Lower	Estate 4WD 30D/EZ30D/EZ30R		Control Arm Bushing	514988
	2003.09-2009.09	Rear Axle Left & Right Lower	Estate 4WD 30D/EZ30D/EZ30R		Control Arm Bushing	516026
	2003.09-2009.09	Rear Axle Left & Right Centre Inner	Estate 4WD 30D/EZ30D/EZ30R		Control Arm Bushing	514982
	2003.09-2009.09	Front Axle Left & Right	Estate 4WD 30D/EZ30D/EZ30R		Tie Rod End	S070423
	2003.09-2009.09	Front Axle Left & Right	Estate 4WD 30D/EZ30D/EZ30R		Rod/Strut, stabiliser	S050550
	2003.09-2009.09	Rear Axle Left & Right	Estate 4WD 30D/EZ30D/EZ30R		Rod/Strut, stabiliser	S050552
3.6 (191 kw)	2009.06-2014.12	Front Axle Left Lower	Estate 4WD EZ36D		Track Control Arm	S062911
	2009.06-2014.12	Front Axle Right Lower	Estate 4WD EZ36D		Track Control Arm	S062912
	2009.06-2014.12	Front Axle Left & Right Lower	Estate 4WD EZ36D		Ball Joint	S080218
	2009.06-2014.12	Front Axle Left & Right Lower	Estate 4WD EZ36D	Date to:2012.03	Control Arm Bushing	516565
	2009.06-2014.12	Front Axle Left & Right Lower	Estate 4WD EZ36D		Control Arm Bushing	535460
	2009.06-2014.12	Rear Axle Left & Right Centre Inner	Estate 4WD EZ36D		Control Arm Bushing	514982
	2009.06-2014.12	Rear Axle Left & Right Lower Outer	Estate 4WD EZ36D		Control Arm Bushing	516158
	2009.06-2014.12	Front Axle Left & Right	Estate 4WD EZ36D		Tie Rod Axle Joint	S030690
	2009.06-2014.12	Front Axle Left & Right	Estate 4WD EZ36D		Tie Rod End	S070423
	2009.06-2014.12	Front Axle Left & Right	Estate 4WD EZ36D		Rod/Strut, stabiliser	S050550
	2009.06-2014.12	Front Axle Left & Right	Estate 4WD EZ36D		Rod/Strut, stabiliser	S050849
	2009.06-2014.12	Rear Axle Left & Right	Estate 4WD EZ36D		Rod/Strut, stabiliser	S050632
	2009.06-2014.12	Rear Axle Left & Right	Estate 4WD EZ36D		Rod/Strut, stabiliser	S050924
	2015.01-	Front Axle Left Lower	Estate 4WD EZ36D		Track Control Arm	S062905
	2015.01-	Front Axle Right Lower	Estate 4WD EZ36D		Track Control Arm	S062906
	2015.01-	Front Axle Left & Right Lower	Estate 4WD EZ36D		Ball Joint	S080218
	2015.01-	Front Axle Left & Right Lower	Estate 4WD EZ36D		Control Arm Bushing	535460
	2015.01-	Rear Axle Left & Right Centre Inner	Estate 4WD EZ36D		Control Arm Bushing	514982
	2015.01-	Front Axle Left & Right	Estate 4WD EZ36D		Tie Rod Axle Joint	S030723
	2015.01-	Rear Axle Left & Right	Estate 4WD EZ36D		Rod/Strut, stabiliser	S050924
SVX						
3.3 (169 kw)	1992.03-1994.01	Rear Axle Left & Right Lower	Coupe 4WD EG33		Control Arm Bushing	511478
Tribeca						
3.6 (190 kw)	2007.09-2014.03	Front Axle Left & Right Lower	SUV 4WD EZ36D		Ball Joint	S081024
	2007.09-2014.03	Front Axle Left & Right Lower	SUV 4WD EZ36D		Control Arm Bushing	516204
	2007.09-2014.03	Front Axle Left & Right Lower	SUV 4WD EZ36D		Control Arm Bushing	535460
	2007.09-2014.03	Rear Axle Left & Right	SUV 4WD EZ36D		Control Arm Bushing	516308
	2007.09-2014.03	Rear Axle Left & Right Lower	SUV 4WD EZ36D		Control Arm Bushing	516320
	2007.09-2014.03	Rear Axle Left & Right Lower Outer	SUV 4WD EZ36D		Control Arm Bushing	516158
	2007.09-2014.03	Front Axle Left & Right	SUV 4WD EZ36D	For OE no.34160XA010	Tie Rod Axle Joint	S030723
	2007.09-2014.03	Front Axle Left & Right	SUV 4WD EZ36D	L:388mm	Tie Rod Axle Joint	S030975
	2007.09-2014.03	Front Axle Left & Right	SUV 4WD EZ36D		Tie Rod End	S070423
	2007.09-2014.03	Front Axle Left & Right	SUV 4WD EZ36D		Rod/Strut, stabiliser	S050849
	2007.09-2014.03	Rear Axle Left	SUV 4WD EZ36D		Rod/Strut, stabiliser	S050982
	2007.09-2014.03	Rear Axle Right	SUV 4WD EZ36D		Rod/Strut, stabiliser	S050983



	 YEAR	FITTING POSITION	BODY STYLE & DRIVE TYPE & ENGINE	REMARKS	PRODUCT	GSP Ref.	
SUBARU							
WRX							
2.0 (197 kw)	2014.06-	Front Axle Left & Right Lower	Saloon 4WD FA20F		Ball Joint	S080218	
	2014.06-	Front Axle Left & Right Lower	Saloon 4WD FA20F		Control Arm Bushing	535460	
	2014.06-	Rear Axle Left & Right Centre Inner	Saloon 4WD FA20F		Control Arm Bushing	514982	
	2014.06-	Front Axle Left & Right	Saloon 4WD FA20F		Tie Rod Axle Joint	S030723	
	2014.06-	Front Axle Left & Right	Saloon 4WD FA20F		Tie Rod End	S070423	
	2014.06-	Front Axle Left & Right	Saloon 4WD FA20F		Rod/Strut,stabiliser	S050849	
2.5 (228 kw)	2016.01-	Front Axle Left & Right Lower	Saloon 4WD EJ257		Control Arm Bushing	535460	
XV							
2.0 (110 kw)	2011.09-	Front Axle Left Lower	SUV 4WD FB20A/FB20B		Track Control Arm	S062909	
	2011.09-	Front Axle Right Lower	SUV 4WD FB20A/FB20B		Track Control Arm	S062910	
	2011.09-	Front Axle Left & Right Lower	SUV 4WD FB20A/FB20B		Ball Joint	S080218	
	2011.09-	Front Axle Left & Right Lower	SUV 4WD FB20A/FB20B		Control Arm Bushing	516196	
	2011.09-	Front Axle Left & Right Lower	SUV 4WD FB20A/FB20B		Control Arm Bushing	535460	
	2011.09-	Rear Axle Left & Right Upper	SUV 4WD FB20A/FB20B	Date to:2017.02	Control Arm Bushing	516316	
	2011.09-	Rear Axle Left & Right Upper	SUV 4WD FB20A/FB20B	Date to:2017.02	Control Arm Bushing	517763	
	2011.09-	Rear Axle Left & Right Centre Inner	SUV 4WD FB20A/FB20B		Control Arm Bushing	514982	
	2011.09-	Rear Axle Left & Right Lower Outer	SUV 4WD FB20A/FB20B		Control Arm Bushing	516158	
	2011.09-	Front Axle Left & Right	SUV 4WD FB20A/FB20B		Tie Rod Axle Joint	S031079	
	2011.09-	Front Axle Left & Right	SUV 4WD FB20A/FB20B		Tie Rod End	S070423	
	2011.09-	Front Axle Left & Right	SUV 4WD FB20A/FB20B		Rod/Strut,stabiliser	S050849	
	2011.09-	Rear Axle Left & Right	SUV 4WD FB20A/FB20B		Rod/Strut,stabiliser	S050924	
	2019.10-	Front Axle Left & Right Lower	SUV 4WD FB20C		Control Arm Bushing	535460	
2019.10-	Front Axle Left & Right	SUV 4WD FB20C		Tie Rod Axle Joint	S031079		
2.0 (115 kw)	2017.04-	Front Axle Left Lower	SUV 4WD FB20C		Track Control Arm	S062909	
	2017.04-	Front Axle Right Lower	SUV 4WD FB20C		Track Control Arm	S062910	
	2017.04-	Front Axle Left & Right Lower	SUV 4WD FB20C		Ball Joint	S080218	
	2017.04-	Front Axle Left & Right Lower	SUV 4WD FB20C		Control Arm Bushing	535460	
	2017.04-	Rear Axle Left & Right Centre Inner	SUV 4WD FB20C		Control Arm Bushing	514982	
	2017.04-	Front Axle Left & Right	SUV 4WD FB20C		Tie Rod Axle Joint	S031079	
2017.04-	Front Axle Left & Right	SUV 4WD FB20C		Tie Rod End	S070423		
SUZUKI							
Baleno Estate/Wagon							
1.6 (73 kw)	1996.08-2002.05	Front Axle Left Lower	Estate FWD G16B		Track Control Arm	S060724	
	1996.08-2002.05	Front Axle Right Lower	Estate FWD G16B		Track Control Arm	S060725	
	1996.08-2002.05	Front Axle Left & Right Lower	Estate FWD G16B		Control Arm Bushing	511284	
	1996.08-2002.05	Front Axle Left & Right Lower	Estate FWD G16B		Control Arm Bushing	514054S	
	1996.08-2002.05	Rear Axle Left & Right	Estate FWD G16B		Control Arm Bushing	516190	
	1996.08-2002.05	Rear Axle Left & Right Centre	Estate FWD G16B		Control Arm Bushing	516178	
	1996.08-2002.05	Front Axle Left & Right	Estate FWD G16B		Tie Rod Axle Joint	S030276	
	1996.08-2002.05	Front Axle Left & Right	Estate FWD G16B		Tie Rod End	S070431	
	1996.08-2002.05	Front Axle Left & Right	Estate FWD G16B		Rod/Strut,stabiliser	S050598	
	1996.08-2002.05	Rear Axle Left	Estate FWD G16B		Rod/Strut,stabiliser	S050403	
	1996.08-2002.05	Rear Axle Right	Estate FWD G16B		Rod/Strut,stabiliser	S050404	
	1996.08-2002.05	Rear Axle	Estate FWD G16B		Stabiliser Bushing	517573	
Escudo							
1.6 (60 kw)	1988.07-1991.12	Rear Axle Left & Right Upper	Terrain cab wagon closed 4WD G16A		Track Control Arm	S062214	
	1988.07-1991.12	Front Axle Left & Right Lower	Terrain cab wagon closed 4WD G16A		Ball Joint	S080352	
	1988.07-1991.12	Front Axle Left & Right	Terrain cab wagon closed 4WD G16A		Control Arm Bushing	516163	
	1988.07-1991.12	Rear Axle Left & Right Upper	Terrain cab wagon closed 4WD G16A		Control Arm Bushing	511293	
	1988.07-1991.12	Front Axle	Terrain cab wagon closed 4WD G16A		Drag Link	S040002	
	1988.07-1991.12	Front Axle	Terrain cab wagon closed 4WD G16A		Idler Arm	S010070	
	1988.07-1991.12	Front Axle Left & Right	Terrain cab wagon closed 4WD G16A		Rod Assembly	S100383	
	1988.07-1991.12	Front Axle Left	Terrain cab wagon closed 4WD G16A		Tie Rod End	S070889	
	1988.07-1991.12	Front Axle Left & Right	Terrain cab wagon closed 4WD G16A		Tie Rod End	S070425	
	1988.07-1991.12	Front Axle Left & Right	Terrain cab wagon closed 4WD G16A		Tie Rod End	S070426	
	1988.07-1991.12	Front Axle Left & Right	Terrain cab wagon closed 4WD G16A		Rod/Strut,stabiliser	S050554	
	1988.07-1991.12	Front Axle	Terrain cab wagon closed 4WD G16A		Stabiliser Bushing	513605	
	1.6 (71 kw)	1990.07-1998.12	Rear Axle Left & Right Upper	Terrain cab wagon closed 4WD G16B		Track Control Arm	S062214
		1990.07-1998.12	Front Axle Left & Right Lower	Terrain cab wagon closed 4WD G16B		Ball Joint	S080352
1990.07-1998.12		Front Axle Left & Right	Terrain cab wagon closed 4WD G16B		Control Arm Bushing	516163	
1990.07-1998.12		Front Axle Left & Right Lower	Terrain cab wagon closed 4WD G16B		Control Arm Bushing	511294	
1990.07-1998.12		Front Axle Left & Right Lower	Terrain cab wagon closed 4WD G16B		Control Arm Bushing	511296	
1990.07-1998.12		Rear Axle Left & Right Lower	Terrain cab wagon closed 4WD G16B		Control Arm Bushing	511295	
1990.07-1998.12		Rear Axle Left & Right Upper	Terrain cab wagon closed 4WD G16B		Control Arm Bushing	511293	



	 YEAR	FITTING POSITION	BODY STYLE & DRIVE TYPE & ENGINE	REMARKS	PRODUCT	GSP Ref.
SUZUKI						
Escudo						
1.6 (71 kw)	1990.07-1998.12	Front Axle	Terrain cab wagon closed 4WD G16B		Drag Link	S040002
	1990.07-1998.12	Front Axle	Terrain cab wagon closed 4WD G16B		Idler Arm	S010070
	1990.07-1998.12	Front Axle Left & Right	Terrain cab wagon closed 4WD G16B		Rod Assembly	S100383
	1990.07-1998.12	Front Axle Left	Terrain cab wagon closed 4WD G16B		Tie Rod End	S070889
	1990.07-1998.12	Front Axle Left & Right	Terrain cab wagon closed 4WD G16B		Tie Rod End	S070425
	1990.07-1998.12	Front Axle Left & Right	Terrain cab wagon closed 4WD G16B		Tie Rod End	S070426
	1990.07-1998.12	Front Axle Left & Right	Terrain cab wagon closed 4WD G16B		Rod/Strut, stabiliser	S050554
2.0 (100 kw)	1990.07-1998.12	Front Axle	Terrain cab wagon closed 4WD G16B		Stabiliser Bushing	513605
	1994.11-1999.12	Front Axle Left & Right	Terrain cab wagon closed 4WD H20A		Control Arm Bushing	516163
	1994.11-1999.12	Front Axle Left & Right Lower	Terrain cab wagon closed 4WD H20A		Control Arm Bushing	511294
	1994.11-1999.12	Front Axle Left & Right Lower	Terrain cab wagon closed 4WD H20A		Control Arm Bushing	511296
	1994.11-1999.12	Rear Axle Left & Right Lower	Terrain cab wagon closed 4WD H20A		Control Arm Bushing	511295
	1994.11-1999.12	Rear Axle Left & Right Upper	Terrain cab wagon closed 4WD H20A		Control Arm Bushing	511293
	1994.11-1999.12	Front Axle	Terrain cab wagon closed 4WD H20A		Drag Link	S040002
	1994.11-1999.12	Front Axle Left & Right	Terrain cab wagon closed 4WD H20A		Tie Rod End	S070425
	1994.11-1999.12	Front Axle Left & Right	Terrain cab wagon closed 4WD H20A		Tie Rod End	S070426
	1994.11-1999.12	Front Axle Left & Right	Terrain cab wagon closed 4WD H20A		Tie Rod End	S070728
Grand Escudo	1994.11-1999.12	Front Axle Left & Right	Terrain cab wagon closed 4WD H20A		Rod/Strut, stabiliser	S050554
	1994.11-1999.12	Front Axle	Terrain cab wagon closed 4WD H20A		Stabiliser Bushing	513605
	2005.09-2011.12	Front Axle Left Lower	Terrain cab wagon closed 4WD J20A		Track Control Arm	S060306
	2005.09-2011.12	Front Axle Right Lower	Terrain cab wagon closed 4WD J20A		Track Control Arm	S060307
	2005.09-2011.12	Front Axle Left & Right Lower	Terrain cab wagon closed 4WD J20A		Control Arm Bushing	516187
	2005.09-2011.12	Front Axle Left & Right Lower	Terrain cab wagon closed 4WD J20A		Control Arm Bushing	516202
	2005.09-2011.12	Rear Axle Left & Right Lower Centre	Terrain cab wagon closed 4WD J20A		Control Arm Bushing	516153
	2005.09-2011.12	Front Axle Left & Right	Terrain cab wagon closed 4WD J20A		Tie Rod Axle Joint	S030279
	2005.09-2011.12	Front Axle Left & Right	Terrain cab wagon closed 4WD J20A		Tie Rod End	S070613
	2005.09-2011.12	Front Axle Left & Right	Terrain cab wagon closed 4WD J20A		Rod/Strut, stabiliser	S050405
	2005.09-2011.12	Front Axle	Terrain cab wagon closed 4WD J20A		Stabiliser Bushing	532786
	2005.09-2011.12	Front Axle	Terrain cab wagon closed 4WD J20A		Steering Boot	540267
	2005.09-2011.12	Front Axle	Terrain cab wagon closed 4WD J20A	Code Grand Vitara, Date to 2011.12, Code Grand Escudo	Steering Rack Bellow Kit	540267S
2005.10-2011.12	Front Axle Left & Right Lower	Terrain cab wagon closed RWD J20A		Control Arm Bushing	516187	
2005.10-2011.12	Front Axle Left & Right	Terrain cab wagon closed RWD J20A		Tie Rod End	S070613	
2005.10-2011.12	Front Axle Left & Right	Terrain cab wagon closed RWD J20A		Rod/Strut, stabiliser	S050405	
Grand Vitara						
1.6 (69 kw)	1998.03-2004.11	Front Axle Left Lower	Terrain cab wagon closed 4WD G16B		Track Control Arm	S060726
	1998.03-2004.11	Front Axle Right Lower	Terrain cab wagon closed 4WD G16B		Track Control Arm	S060727
	1998.03-2004.11	Front Axle Left & Right Lower	Terrain cab wagon closed 4WD G16B		Control Arm Bushing	516687
	1998.03-2004.11	Front Axle Left & Right Lower	Terrain cab wagon closed 4WD G16B		Control Arm Bushing	516688
	1998.03-2004.11	Rear Axle Left & Right Centre	Terrain cab wagon closed 4WD G16B		Control Arm Bushing	516178
	1998.03-2004.11	Rear Axle Left & Right Upper	Terrain cab wagon closed 4WD G16B		Control Arm Bushing	516176
	1998.03-2004.11	Rear Axle Left & Right Lower Inner	Terrain cab wagon closed 4WD G16B		Control Arm Bushing	511295
	1998.03-2004.11	Front Axle Left & Right	Terrain cab wagon closed 4WD G16B		Tie Rod Axle Joint	S030275
	1998.03-2004.11	Front Axle Left	Terrain cab wagon closed 4WD G16B		Tie Rod End	S070434
	1998.03-2004.11	Front Axle Right	Terrain cab wagon closed 4WD G16B		Tie Rod End	S070435
	1998.03-2004.11	Front Axle Left & Right	Terrain cab wagon closed 4WD G16B		Rod/Strut, stabiliser	S050554
	1998.03-2004.11	Front Axle	Terrain cab wagon closed 4WD G16B		Stabiliser Bushing	516781
	2.0 (80 kw)	2001.02-2003.10	Front Axle Left Lower	Terrain cab wagon closed 4WD RHZ		Track Control Arm
2001.02-2003.10		Front Axle Right Lower	Terrain cab wagon closed 4WD RHZ		Track Control Arm	S060727
2001.02-2003.10		Front Axle Left & Right Lower	Terrain cab wagon closed 4WD RHZ		Control Arm Bushing	516687
2001.02-2003.10		Front Axle Left & Right Lower	Terrain cab wagon closed 4WD RHZ		Control Arm Bushing	516688
2001.02-2003.10		Rear Axle Left & Right Centre	Terrain cab wagon closed 4WD RHZ		Control Arm Bushing	516178
2001.02-2003.10		Rear Axle Left & Right Upper	Terrain cab wagon closed 4WD RHZ		Control Arm Bushing	516176
2001.02-2003.10		Front Axle Left & Right	Terrain cab wagon closed 4WD RHZ		Tie Rod Axle Joint	S030275
2001.02-2003.10		Front Axle Left	Terrain cab wagon closed 4WD RHZ		Tie Rod End	S070434
2001.02-2003.10		Front Axle Right	Terrain cab wagon closed 4WD RHZ		Tie Rod End	S070435
2001.02-2003.10		Front Axle Left & Right	Terrain cab wagon closed 4WD RHZ		Rod/Strut, stabiliser	S050554
2001.02-2003.10	Front Axle	Terrain cab wagon closed 4WD RHZ		Stabiliser Bushing	516773	
2.0 (94 kw)	1998.03-2004.11	Front Axle Left Lower	Terrain cab wagon closed 4WD J20A		Track Control Arm	S060726
	1998.03-2004.11	Front Axle Right Lower	Terrain cab wagon closed 4WD J20A		Track Control Arm	S060727
	1998.03-2004.11	Front Axle Left & Right Lower	Terrain cab wagon closed 4WD J20A		Control Arm Bushing	516687
	1998.03-2004.11	Front Axle Left & Right Lower	Terrain cab wagon closed 4WD J20A		Control Arm Bushing	516688
	1998.03-2004.11	Rear Axle Left & Right Centre	Terrain cab wagon closed 4WD J20A		Control Arm Bushing	516178
	1998.03-2004.11	Rear Axle Left & Right Upper	Terrain cab wagon closed 4WD J20A		Control Arm Bushing	516176



	 YEAR	FITTING POSITION	BODY STYLE & DRIVE TYPE & ENGINE	REMARKS	PRODUCT	GSP Ref.	
SUZUKI							
Grand Vitara							
2.0 (94 kw)	1998.03-2004.11	Rear Axle Left & Right Lower Inner	Terrain cab wagon closed 4WD J20A		Control Arm Bushing	511295	
	1998.03-2004.11	Front Axle Left & Right	Terrain cab wagon closed 4WD J20A		Tie Rod Axle Joint	S030275	
	1998.03-2004.11	Front Axle Right	Terrain cab wagon closed 4WD J20A		Tie Rod End	S070435	
	1998.03-2004.11	Front Axle Left & Right	Terrain cab wagon closed 4WD J20A		Rod/Strut, stabiliser	S050554	
	1998.03-2004.11	Front Axle Left & Right	Terrain cab wagon closed 4WD J20A		Rod/Strut, stabiliser	S051121	
	1998.03-2004.11	Front Axle	Terrain cab wagon closed 4WD J20A		Stabiliser Bushing	516773	
2.0 (103 kw)	2005.09-2015.02	Front Axle Left Lower	Terrain cab wagon closed 4WD J20A		Track Control Arm	S060306	
	2005.09-2015.02	Front Axle Right Lower	Terrain cab wagon closed 4WD J20A		Track Control Arm	S060307	
	2005.09-2015.02	Front Axle Left & Right Lower	Terrain cab wagon closed 4WD J20A		Control Arm Bushing	516187	
	2005.09-2015.02	Front Axle Left & Right Lower	Terrain cab wagon closed 4WD J20A		Control Arm Bushing	516202	
	2005.09-2015.02	Rear Axle Left & Right Lower Centre	Terrain cab wagon closed 4WD J20A		Control Arm Bushing	516153	
	2005.09-2015.02	Front Axle Left & Right	Terrain cab wagon closed 4WD J20A		Tie Rod Axle Joint	S030279	
	2005.09-2015.02	Front Axle Left & Right	Terrain cab wagon closed 4WD J20A		Tie Rod End	S070613	
	2005.09-2015.02	Front Axle Left & Right	Terrain cab wagon closed 4WD J20A		Rod/Strut, stabiliser	S050405	
	2005.09-2015.02	Front Axle	Terrain cab wagon closed 4WD J20A		Stabiliser Bushing	532786	
	2005.09-2015.02	Front Axle	Terrain cab wagon closed 4WD J20A		Steering Boot	540267	
	2005.09-2015.02	Front Axle	Terrain cab wagon closed 4WD J20A	Code:Grand Vitara,Date to:2011.12,Code:Grand Escudo	Steering Rack Bellow Kit	540267S	
	2.5 (106 kw)	1998.04-2001.12	Front Axle Left Lower	Terrain cab wagon closed 4WD H25A		Track Control Arm	S060726
1998.04-2001.12		Front Axle Right Lower	Terrain cab wagon closed 4WD H25A		Track Control Arm	S060727	
1998.04-2001.12		Front Axle Left & Right Lower	Terrain cab wagon closed 4WD H25A		Control Arm Bushing	516687	
1998.04-2001.12		Front Axle Left & Right Lower	Terrain cab wagon closed 4WD H25A		Control Arm Bushing	516688	
1998.04-2001.12		Rear Axle Left & Right Centre	Terrain cab wagon closed 4WD H25A		Control Arm Bushing	516178	
1998.04-2001.12		Rear Axle Left & Right Upper	Terrain cab wagon closed 4WD H25A		Control Arm Bushing	516176	
1998.04-2001.12		Front Axle Left & Right	Terrain cab wagon closed 4WD H25A		Tie Rod Axle Joint	S030275	
1998.04-2001.12		Front Axle Left	Terrain cab wagon closed 4WD H25A		Tie Rod End	S070434	
1998.04-2001.12		Front Axle Right	Terrain cab wagon closed 4WD H25A		Tie Rod End	S070435	
1998.04-2001.12		Front Axle Left & Right	Terrain cab wagon closed 4WD H25A		Rod/Strut, stabiliser	S050554	
1998.04-2001.12		Front Axle	Terrain cab wagon closed 4WD H25A		Stabiliser Bushing	516773	
3.2 (171 kw)		2008.06-2015.02	Front Axle Left Lower	Terrain cab wagon closed 4WD N32A		Track Control Arm	S060306
		2008.06-2015.02	Front Axle Right Lower	Terrain cab wagon closed 4WD N32A		Track Control Arm	S060307
		2008.06-2015.02	Front Axle Left & Right Lower	Terrain cab wagon closed 4WD N32A		Control Arm Bushing	516187
	2008.06-2015.02	Front Axle Left & Right	Terrain cab wagon closed 4WD N32A		Tie Rod Axle Joint	S030279	
	2008.06-2015.02	Front Axle Left & Right	Terrain cab wagon closed 4WD N32A		Tie Rod End	S070613	
	2008.06-2015.02	Front Axle Left & Right	Terrain cab wagon closed 4WD N32A		Rod/Strut, stabiliser	S050405	
2008.06-2015.02	Front Axle	Terrain cab wagon closed 4WD N32A		Steering Rack Bellow Kit	540267S		
Ignis							
1.3 (61 kw)	2000.07-2003.09	Front Axle Left & Right Lower	Hatchback 4WD M13A		Track Control Arm	S060308	
	2000.07-2003.09	Front Axle Left & Right Lower	Hatchback 4WD M13A	VIN:JSA	Track Control Arm	S060907	
	2000.07-2003.09	Front Axle Left & Right Lower	Hatchback 4WD M13A		Control Arm Bushing	510897	
	2000.07-2003.09	Front Axle Left & Right Lower	Hatchback 4WD M13A		Control Arm Bushing	516832	
	2000.07-2003.09	Front Axle Left & Right Lower	Hatchback 4WD M13A		Control Arm Bushing Kit	516832S	
	2000.07-2003.09	Front Axle Left & Right	Hatchback 4WD M13A		Tie Rod Axle Joint	S030581	
	2000.07-2003.09	Front Axle Left & Right	Hatchback 4WD M13A	for vehicles with sports package,VIN:JSA	Tie Rod End	S070376	
	2000.07-2003.09	Front Axle Left & Right	Hatchback 4WD M13A	for vehicles with sports package,VIN:JSA	Tie Rod End	S070431	
Jimny							
1.3 (47 kw)	1984.09-1988.10	Front Axle Left	Terrain cab wagon closed 4WD G13A		Rod Assembly	S100406	
	1984.09-1988.10	Front Axle Left	Terrain cab wagon closed 4WD G13A		Tie Rod End	S070889	
1.3 (59 kw)	1998.10-2008.10	Front Axle Left & Right Lower	Terrain cab wagon closed 4WD G13BB		Track Control Arm	S061590	
	1998.10-2008.10	Rear Axle Left & Right Lower Outer	Terrain cab wagon closed 4WD G13BB		Control Arm Bushing	516213	
	1998.10-2008.10	Front Axle;Rear Axle Left & Right Lower	Terrain cab wagon closed 4WD G13BB		Control Arm Bushing	511295	
	1998.10-2008.10	Front Axle Left & Right	Terrain cab wagon closed 4WD G13BB		Tie Rod End	S070425	
	1998.10-2008.10	Front Axle Left & Right	Terrain cab wagon closed 4WD G13BB		Rod/Strut, stabiliser	S050555	
1.3 (62 kw)	2014.05-	Front Axle Left & Right Lower	Terrain cab wagon closed 4WD M13A		Track Control Arm	S061590	
	2014.05-	Rear Axle Left & Right Lower Outer	Terrain cab wagon closed 4WD M13A		Control Arm Bushing	516213	
	2014.05-	Front Axle;Rear Axle Left & Right Lower	Terrain cab wagon closed 4WD M13A		Control Arm Bushing	511295	
	2014.05-	Front Axle Left & Right	Terrain cab wagon closed 4WD M13A		Tie Rod End	S070425	
	2014.05-	Front Axle Left & Right	Terrain cab wagon closed 4WD M13A		Tie Rod End	S070426	
	2014.05-	Front Axle Left & Right	Terrain cab wagon closed 4WD M13A		Rod/Strut, stabiliser	S050555	
1.3 (63 kw)	2000.10-	Front Axle Left & Right Lower	Terrain cab wagon closed 4WD M13A		Track Control Arm	S061590	
	2000.10-	Rear Axle Left & Right Lower Outer	Terrain cab wagon closed 4WD M13A		Control Arm Bushing	516213	
	2000.10-	Front Axle;Rear Axle Left & Right Lower	Terrain cab wagon closed 4WD M13A		Control Arm Bushing	511295	
	2000.10-	Front Axle Left & Right	Terrain cab wagon closed 4WD M13A		Tie Rod End	S070425	
	2000.10-	Front Axle Left & Right	Terrain cab wagon closed 4WD M13A		Tie Rod End	S070426	
	2000.10-	Front Axle Left & Right	Terrain cab wagon closed 4WD M13A		Rod/Strut, stabiliser	S050555	



	 YEAR	FITTING POSITION	BODY STYLE & DRIVE TYPE & ENGINE	REMARKS	PRODUCT	GSP Ref.
SUZUKI						
Jimny						
1.3 (63 kw)	2013.03-	Rear Axle Left & Right Lower	Terrain cab open 4WD M13A		Control Arm Bushing	511295
	2013.03-	Rear Axle Left & Right Lower Outer	Terrain cab open 4WD M13A		Control Arm Bushing	516213
	2013.03-	Front Axle;Rear Axle Left & Right Lower	Terrain cab open 4WD M13A		Control Arm Bushing	516164
	2013.03-	Front Axle Left & Right	Terrain cab open 4WD M13A		Tie Rod End	S070425
	2013.03-	Front Axle Left & Right	Terrain cab open 4WD M13A		Rod/Strut,stabiliser	S050555
Samurai						
1.3 (47 kw)	1988.11-2004.12	Front Axle Left	Terrain cab wagon closed 4WD G13A		Rod Assembly	S100406
	1988.11-2004.12	Front Axle Left	Terrain cab wagon closed 4WD G13A		Tie Rod End	S070889
Sidekick						
1.6 (71 kw)	1989.04-1996.04	Rear Axle Left & Right Upper	Terrain cab wagon closed 4WD G16B		Track Control Arm	S062214
	1989.04-1996.04	Front Axle Left & Right Lower	Terrain cab wagon closed 4WD G16B		Ball Joint	S080352
	1989.04-1996.04	Front Axle Left & Right	Terrain cab wagon closed 4WD G16B		Control Arm Bushing	516163
	1989.04-1996.04	Front Axle Left & Right Lower	Terrain cab wagon closed 4WD G16B		Control Arm Bushing	511294
	1989.04-1996.04	Front Axle Left & Right Lower	Terrain cab wagon closed 4WD G16B		Control Arm Bushing	511296
	1989.04-1996.04	Rear Axle Left & Right Lower	Terrain cab wagon closed 4WD G16B		Control Arm Bushing	511295
	1989.04-1996.04	Rear Axle Left & Right Upper	Terrain cab wagon closed 4WD G16B		Control Arm Bushing	511293
	1989.04-1996.04	Front Axle	Terrain cab wagon closed 4WD G16B		Drag Link	S040002
	1989.04-1996.04	Front Axle	Terrain cab wagon closed 4WD G16B		Idler Arm	S010070
	1989.04-1996.04	Front Axle Left & Right	Terrain cab wagon closed 4WD G16B		Rod Assembly	S100383
	1989.04-1996.04	Front Axle Left	Terrain cab wagon closed 4WD G16B		Tie Rod End	S070889
	1989.04-1996.04	Front Axle Left & Right	Terrain cab wagon closed 4WD G16B		Tie Rod End	S070425
	1989.04-1996.04	Front Axle Left & Right	Terrain cab wagon closed 4WD G16B		Tie Rod End	S070426
	1989.04-1996.04	Front Axle Left & Right	Terrain cab wagon closed 4WD G16B		Rod/Strut,stabiliser	S050554
	1989.04-1996.04	Front Axle	Terrain cab wagon closed 4WD G16B		Stabiliser Bushing	513605
Swift						
1.0 (40 kw)	1989.03-1992.07	Front Axle Left Lower	Hatchback FWD G10A		Track Control Arm	S060792
	1989.03-1992.07	Front Axle Right Lower	Hatchback FWD G10A		Track Control Arm	S060304
	1989.03-1992.07	Front Axle Left & Right	Hatchback FWD G10A		Tie Rod Axle Joint	S030272
	1989.03-1992.07	Front Axle Left & Right	Hatchback FWD G10A	Change no.to:50500000 for vehicles without power steering	Tie Rod Axle Joint	S030273
	1989.03-1992.07	Front Axle Left & Right	Hatchback FWD G10A		Rod/Strut End	S070431
	1989.03-1992.07	Front Axle Left & Right	Hatchback FWD G10A		Rod/Strut,stabiliser	S050598
SX4						
2.0 (107 kw)	2007.01-2015.12	Front Axle Left Lower	Hatchback 4WD J20A		Track Control Arm	S061072
	2007.01-2015.12	Front Axle Right Lower	Hatchback 4WD J20A		Track Control Arm	S061071
	2007.01-2015.12	Front Axle	Hatchback 4WD J20A		Steering Rack Bellow Kit	541119S
SX4 S-Cross						
1.6 (88 kw)	2013.08-	Front Axle Left & Right Lower	Hatchback 4WD M16A		Control Arm Bushing	516509
	2013.08-	Front Axle Left & Right Lower	Hatchback FWD M16A		Control Arm Bushing	516509
	2013.08-	Front Axle Left & Right	Hatchback 4WD M16A		Tie Rod End	S070613
	2013.08-	Front Axle Left & Right	Hatchback FWD M16A		Tie Rod End	S070613
Vitara						
1.6 (55 kw)	1989.06-1993.12	Front Axle Left & Right Lower	Terrain cab wagon closed 4WD G16A		Ball Joint	S080352
	1989.06-1993.12	Front Axle Left & Right Lower	Terrain cab wagon closed 4WD G16A		Control Arm Bushing	511294
	1989.06-1993.12	Front Axle Left & Right Lower	Terrain cab wagon closed 4WD G16A		Control Arm Bushing	511296
	1989.06-1993.12	Rear Axle Left & Right Upper	Terrain cab wagon closed 4WD G16A		Control Arm Bushing	516176
	1989.06-1993.12	Front Axle	Terrain cab wagon closed 4WD G16A		Drag Link	S040002
	1989.06-1993.12	Front Axle Left & Right	Terrain cab wagon closed 4WD G16A		Tie Rod End	S070425
	1989.06-1993.12	Front Axle Left & Right	Terrain cab wagon closed 4WD G16A		Tie Rod End	S070426
	1989.06-1993.12	Front Axle Left & Right	Terrain cab wagon closed 4WD G16A		Rod/Strut,stabiliser	S050554
1.6 (60 kw)	1988.07-1991.12	Rear Axle Left & Right Upper	Terrain cab wagon closed 4WD G16A		Track Control Arm	S062214
	1988.07-1991.12	Front Axle Left & Right Lower	Terrain cab wagon closed 4WD G16A		Ball Joint	S080352
	1988.07-1991.12	Front Axle Left & Right	Terrain cab wagon closed 4WD G16A		Control Arm Bushing	516163
	1988.07-1991.12	Rear Axle Left & Right Upper	Terrain cab wagon closed 4WD G16A		Control Arm Bushing	511293
	1988.07-1991.12	Front Axle	Terrain cab wagon closed 4WD G16A		Drag Link	S040002
	1988.07-1991.12	Front Axle	Terrain cab wagon closed 4WD G16A		Idler Arm	S010070
	1988.07-1991.12	Front Axle Left & Right	Terrain cab wagon closed 4WD G16A		Rod Assembly	S100383
	1988.07-1991.12	Front Axle Left	Terrain cab wagon closed 4WD G16A		Tie Rod End	S070889
	1988.07-1991.12	Front Axle Left & Right	Terrain cab wagon closed 4WD G16A		Tie Rod End	S070425
	1988.07-1991.12	Front Axle Left & Right	Terrain cab wagon closed 4WD G16A		Tie Rod End	S070426
	1988.07-1991.12	Front Axle Left & Right	Terrain cab wagon closed 4WD G16A		Rod/Strut,stabiliser	S050554
	1988.07-1991.12	Front Axle	Terrain cab wagon closed 4WD G16A		Stabiliser Bushing	513605
1.6 (71 kw)	1990.07-1998.12	Rear Axle Left & Right Upper	Terrain cab wagon closed 4WD G16B		Track Control Arm	S062214
	1990.07-1998.12	Front Axle Left & Right Lower	Terrain cab wagon closed 4WD G16B		Ball Joint	S080352
	1990.07-1998.12	Front Axle Left & Right	Terrain cab wagon closed 4WD G16B		Control Arm Bushing	516163



	 YEAR	FITTING POSITION	BODY STYLE & DRIVE TYPE & ENGINE	REMARKS	PRODUCT	GSP Ref.
SUZUKI						
Vitara						
1.6 (71 kw)	1990.07-1998.12	Front Axle Left & Right Lower	Terrain cab wagon closed 4WD G16B		Control Arm Bushing	511294
	1990.07-1998.12	Front Axle Left & Right Lower	Terrain cab wagon closed 4WD G16B		Control Arm Bushing	511296
	1990.07-1998.12	Rear Axle Left & Right Lower	Terrain cab wagon closed 4WD G16B		Control Arm Bushing	511295
	1990.07-1998.12	Rear Axle Left & Right Upper	Terrain cab wagon closed 4WD G16B		Control Arm Bushing	511293
	1990.07-1998.12	Front Axle	Terrain cab wagon closed 4WD G16B		Drag Link	S040002
	1990.07-1998.12	Front Axle	Terrain cab wagon closed 4WD G16B		Idler Arm	S010070
	1990.07-1998.12	Front Axle Left & Right	Terrain cab wagon closed 4WD G16B		Rod Assembly	S100383
	1990.07-1998.12	Front Axle Left	Terrain cab wagon closed 4WD G16B		Tie Rod End	S070889
	1990.07-1998.12	Front Axle Left & Right	Terrain cab wagon closed 4WD G16B		Tie Rod End	S070425
	1990.07-1998.12	Front Axle Left & Right	Terrain cab wagon closed 4WD G16B		Tie Rod End	S070426
	1990.07-1998.12	Front Axle Left & Right	Terrain cab wagon closed 4WD G16B		Rod/Strut,stabiliser	S050554
	1990.07-1998.12	Front Axle	Terrain cab wagon closed 4WD G16B		Stabiliser Bushing	513605
2.0 (100 kw)	1994.11-1998.12	Front Axle Left & Right	Terrain cab wagon closed 4WD H20A		Control Arm Bushing	516163
	1994.11-1998.12	Front Axle Left & Right Lower	Terrain cab wagon closed 4WD H20A		Control Arm Bushing	511294
	1994.11-1998.12	Front Axle Left & Right Lower	Terrain cab wagon closed 4WD H20A		Control Arm Bushing	511296
	1994.11-1998.12	Rear Axle Left & Right Lower	Terrain cab wagon closed 4WD H20A		Control Arm Bushing	511295
	1994.11-1998.12	Rear Axle Left & Right Upper	Terrain cab wagon closed 4WD H20A		Control Arm Bushing	511293
	1994.11-1998.12	Front Axle	Terrain cab wagon closed 4WD H20A		Drag Link	S040002
	1994.11-1998.12	Front Axle Left & Right	Terrain cab wagon closed 4WD H20A		Tie Rod End	S070425
	1994.11-1998.12	Front Axle Left & Right	Terrain cab wagon closed 4WD H20A		Tie Rod End	S070426
	1994.11-1998.12	Front Axle Left & Right	Terrain cab wagon closed 4WD H20A		Tie Rod End	S070728
	1994.11-1998.12	Front Axle Left & Right	Terrain cab wagon closed 4WD H20A		Rod/Strut,stabiliser	S050554
	1994.11-1998.12	Front Axle	Terrain cab wagon closed 4WD H20A		Stabiliser Bushing	513605
TESLA						
Model 3						
ET (258 kw)	2018.06-	Front Axle Left Lower Inner	Saloon 4WD 3DU		Track Control Arm	S063026S
	2018.06-	Front Axle Right Lower Inner	Saloon 4WD 3DU		Track Control Arm	S063027S
	2018.06-	Front Axle Left & Right	Saloon 4WD 3DU		Tie Rod Axle Joint	S031057
	2018.06-	Front Axle Left & Right	Saloon 4WD 3DU		Tie Rod End	S071814
	2018.06-	Front Axle Left	Saloon 4WD 3DU		Rod/Strut,stabiliser	S051414
	2018.06-	Front Axle Right	Saloon 4WD 3DU		Rod/Strut,stabiliser	S051413
Model S P100D						
ET (568 kw)	2016.10-	Front Axle Left Upper	Hatchback 4WD L2S		Track Control Arm	S063025
	2016.10-	Front Axle Left Lower Outer	Hatchback 4WD L2S		Track Control Arm	S063022S
	2016.10-	Front Axle Right Upper	Hatchback 4WD L2S		Track Control Arm	S063024
	2016.10-	Front Axle Right Lower Outer	Hatchback 4WD L2S		Track Control Arm	S063023S
	2016.10-	Front Axle Left & Right Lower Inner	Hatchback 4WD L2S		Track Control Arm	S063020S
	2016.10-	Rear Axle Left & Right Upper Outer	Hatchback 4WD L2S		Track Control Arm	S063028
	2016.10-	Rear Axle Left & Right Upper Outer	Hatchback 4WD L2S		Track Control Arm	S063029
	2016.10-	Front Axle Left & Right	Hatchback 4WD L2S		Tie Rod Axle Joint	S031058
	2016.10-	Front Axle Left & Right	Hatchback 4WD L2S	Alt. Version:1	Tie Rod End	S071812
	2016.10-	Front Axle Left & Right	Hatchback 4WD L2S	Alt. Version:2	Tie Rod End	S071815
	2016.10-	Front Axle Left & Right	Hatchback 4WD L2S		Rod/Strut,stabiliser	S051416
Model S P85D						
ET (568 kw)	2015.09-2016.02	Front Axle Left & Right Lower Outer	Hatchback 4WD L2S		Track Control Arm	S063021S
	2015.09-2016.02	Front Axle Left & Right	Hatchback 4WD L2S		Tie Rod End	S071812
	2015.09-2016.02	Front Axle Left & Right	Hatchback 4WD L2S		Rod/Strut,stabiliser	S051416
Model S P90D						
ET (568 kw)	2015.09-	Front Axle Left & Right Lower Outer	Hatchback 4WD L2S		Track Control Arm	S063021S
	2015.09-	Front Axle Left & Right	Hatchback 4WD L2S		Tie Rod Axle Joint	S031058
	2015.09-	Front Axle Left & Right	Hatchback 4WD L2S	Date to:2016.03	Tie Rod End	S071812
	2015.09-	Front Axle Left & Right	Hatchback 4WD L2S		Tie Rod End	S071815
	2015.09-	Front Axle Left & Right	Hatchback 4WD L2S		Rod/Strut,stabiliser	S051416
Model X P90D						
ET (568 kw)	2015.09-	Front Axle Left & Right Lower Outer	Hatchback 4WD L2S		Track Control Arm	S063021S
	2015.09-	Front Axle Left & Right	Hatchback 4WD L2S		Tie Rod End	S071815
	2015.09-	Front Axle Left & Right	Hatchback 4WD L2S		Rod/Strut,stabiliser	S051415
TOYOTA						
4 Runner/Surf/Hilux Surf						
2.8 (65 kw)	1992.01-1996.08	Front Axle Left & Right Upper	SUV AWD 3L		Control Arm Bushing	511040
	1992.01-1996.08	Rear Axle Left & Right Lower	SUV AWD 3L		Control Arm Bushing	512992
	1992.01-1996.08	Front Axle	SUV AWD 3L		Stabiliser Bushing	513129



	 YEAR	FITTING POSITION	BODY STYLE & DRIVE TYPE & ENGINE	REMARKS	PRODUCT	GSP Ref.
TOYOTA Camry						
2.2 (96 kw)	1996.08-2001.11	Front Axle Left Lower	Saloon FWD 5SFE/5SFNE		Track Control Arm	S060737
	1996.08-2001.11	Front Axle Right Lower	Saloon FWD 5SFE/5SFNE		Track Control Arm	S060738
	1996.08-2001.11	Rear Axle Left Lower Outer	Saloon FWD 5SFE/5SFNE	For OE no.4874033060	Track Control Arm	S063222
	1996.08-2001.11	Rear Axle Right Lower Outer	Saloon FWD 5SFE/5SFNE		Track Control Arm	S062126
	1996.08-2001.11	Front Axle Left & Right Lower	Saloon FWD 5SFE/5SFNE		Ball Joint	S080234
	1996.08-2001.11	Front Axle Left & Right Lower	Saloon FWD 5SFE/5SFNE		Control Arm Bushing	S12072
	1996.08-2001.11	Front Axle Left & Right Lower	Saloon FWD 5SFE/5SFNE		Control Arm Bushing	514892
	1996.08-2001.11	Front Axle Left & Right Lower	Saloon FWD 5SFE/5SFNE		Control Arm Bushing	516689
	1996.08-2001.11	Rear Axle Left & Right Lower	Saloon FWD 5SFE/5SFNE		Control Arm Bushing	514932
	1996.08-2001.11	Rear Axle Left & Right Lower Centre	Saloon FWD 5SFE/5SFNE	Date from:1996.12	Control Arm Bushing	514918
	1996.08-2001.11	Rear Axle Left & Right Lower Centre	Saloon FWD 5SFE/5SFNE	Date from:1996.12	Control Arm Bushing	514922
	1996.08-2001.11	Rear Axle Left & Right Lower Outer	Saloon FWD 5SFE/5SFNE		Control Arm Bushing	513034
	1996.08-2001.11	Rear Axle	Saloon FWD 5SFE/5SFNE		Control Arm Bushing	514024
	1996.08-2001.11	Front Axle Left & Right	Saloon FWD 5SFE/5SFNE		Tie Rod Axle Joint	S030305
	1996.08-2001.11	Front Axle Left & Right	Saloon FWD 5SFE/5SFNE		Tie Rod End	S070470
	1996.08-2001.11	Front Axle Left	Saloon FWD 5SFE/5SFNE		Rod/Strut,stabiliser	S050430
	1996.08-2001.11	Front Axle Right	Saloon FWD 5SFE/5SFNE		Rod/Strut,stabiliser	S050431
	1996.08-2001.11	Rear Axle Left & Right	Saloon FWD 5SFE/5SFNE		Rod/Strut,stabiliser	S050912
	1996.08-2001.11	Front Axle	Saloon FWD 5SFE/5SFNE		Stabiliser Bushing	512939
	1996.08-2001.11	Front Axle	Saloon FWD 5SFE/5SFNE		Stabiliser Bushing	512944
	1996.08-2001.11	Front Axle	Saloon FWD 5SFE/5SFNE		Stabiliser Bushing	517527
	1996.08-2001.11	Rear Axle	Saloon FWD 5SFE/5SFNE		Stabiliser Bushing	512941
	1996.08-2001.11	Rear Axle	Saloon FWD 5SFE/5SFNE		Stabiliser Bushing	512942
	1996.08-2001.11	Rear Axle	Saloon FWD 5SFE/5SFNE		Stabiliser Bushing	512943
	1996.08-2001.11	Front Axle	Saloon FWD 5SFE/5SFNE		Steering Rack Bellow Kit	540211K
2.2 (100 kw)	1991.06-1996.08	Front Axle Left & Right Lower	Saloon FWD 5SFE		Control Arm Bushing	511051
	1991.06-1996.08	Front Axle Left & Right Lower	Saloon FWD 5SFE		Control Arm Bushing	514297
	1991.06-1996.08	Front Axle Left & Right Lower	Saloon FWD 5SFE	Date from:1991.09	Control Arm Bushing	514892
	1991.06-1996.08	Front Axle Left & Right Lower	Saloon FWD 5SFE		Control Arm Bushing	514892
	1991.06-1996.08	Front Axle Left & Right Lower	Saloon FWD 5SFE	Date from:1991.09	Control Arm Bushing	516689
	1991.06-1996.08	Rear Axle Left & Right Lower	Saloon FWD 5SFE		Control Arm Bushing	512038
	1991.06-1996.08	Rear Axle Left & Right Lower Centre	Saloon FWD 5SFE		Control Arm Bushing	514918
	1991.06-1996.08	Rear Axle Left & Right Lower Inner	Saloon FWD 5SFE		Control Arm Bushing	530066
	1991.06-1996.08	Rear Axle Left & Right Lower Outer	Saloon FWD 5SFE		Control Arm Bushing	513034
	1991.06-1996.08	Front Axle Left & Right	Saloon FWD 5SFE		Tie Rod Axle Joint	S030305
	1991.06-1996.08	Front Axle Left & Right	Saloon FWD 5SFE		Tie Rod Axle Joint	S030834
	1991.06-1996.08	Front Axle Left & Right	Saloon FWD 5SFE		Tie Rod End	S070470
	1991.06-1996.08	Front Axle Left & Right	Saloon FWD 5SFE		Rod/Strut,stabiliser	530590S
	1991.06-1996.08	Rear Axle Left & Right	Saloon FWD 5SFE		Rod/Strut,stabiliser	S050912
	1991.06-1996.08	Front Axle	Saloon FWD 5SFE		Stabiliser Bushing	512285
	1991.06-1996.08	Rear Axle	Saloon FWD 5SFE		Stabiliser Bushing	512941
	1991.06-1996.08	Rear Axle	Saloon FWD 5SFE		Stabiliser Bushing	513135
	1991.06-1996.08	Front Axle	Saloon FWD 5SFE		Steering Boot	540034
	1991.06-1996.08	Front Axle	Saloon FWD 5SFE		Steering Rack Bellow Kit	540211K
3.0 (137 kw)	2001.07-2006.11	Front Axle Left Lower	Saloon FWD 1MZFE		Track Control Arm	S061365
	2001.07-2006.11	Front Axle Right Lower	Saloon FWD 1MZFE		Track Control Arm	S061366
	2001.07-2006.11	Rear Axle Left Lower Outer	Saloon FWD 1MZFE		Track Control Arm	517343S
	2001.07-2006.11	Rear Axle Right Lower Outer	Saloon FWD 1MZFE	AT	Track Control Arm	517793S
	2001.07-2006.11	Rear Axle Left & Right Lower Outer	Saloon FWD 1MZFE		Track Control Arm	S062298
	2001.07-2006.11	Front Axle Left Lower	Saloon FWD 1MZFE		Ball Joint	S080236
	2001.07-2006.11	Front Axle Right Lower	Saloon FWD 1MZFE		Ball Joint	S080237
	2001.07-2006.11	Front Axle Left & Right Lower	Saloon FWD 1MZFE		Ball Joint	S080234
	2001.07-2006.11	Front Axle Left & Right Lower	Saloon FWD 1MZFE		Control Arm Bushing	513234
	2001.07-2006.11	Front Axle Left & Right Lower	Saloon FWD 1MZFE	AT	Control Arm Bushing	514296
	2001.07-2006.11	Front Axle Left & Right Lower	Saloon FWD 1MZFE	AT	Control Arm Bushing	516708
	2001.07-2006.11	Rear Axle Left & Right Lower Centre	Saloon FWD 1MZFE		Control Arm Bushing	514918
	2001.07-2006.11	Rear Axle Left & Right Lower Outer	Saloon FWD 1MZFE		Control Arm Bushing	513034
	2001.07-2006.11	Front Axle Left & Right	Saloon FWD 1MZFE	Date to:2006.01	Tie Rod Axle Joint	S030303
	2001.07-2006.11	Front Axle Left & Right	Saloon FWD 1MZFE		Tie Rod Axle Joint	S030305
	2001.07-2006.11	Front Axle Left & Right	Saloon FWD 1MZFE		Tie Rod Axle Joint	S030451
	2001.07-2006.11	Front Axle Left	Saloon FWD 1MZFE	Date to:2003.07	Tie Rod End	S070464
	2001.07-2006.11	Front Axle Left	Saloon FWD 1MZFE		Tie Rod End	S070853
	2001.07-2006.11	Front Axle Right	Saloon FWD 1MZFE	Date to:2003.07	Tie Rod End	S070465
	2001.07-2006.11	Front Axle Right	Saloon FWD 1MZFE		Tie Rod End	S070852



	 YEAR	FITTING POSITION	BODY STYLE & DRIVE TYPE & ENGINE	REMARKS	PRODUCT	GSP Ref.
TOYOTA Camry						
3.0 (137 kw)	2001.07-2006.11	Front Axle Left & Right	Saloon FWD 1MZFE		Tie Rod End	S070470
	2001.07-2006.11	Front Axle Left & Right	Saloon FWD 1MZFE		Tie Rod End	S070862
	2001.07-2006.11	Front Axle Left & Right	Saloon FWD 1MZFE		Rod/Strut, stabiliser	S050419
	2001.07-2006.11	Rear Axle Left & Right	Saloon FWD 1MZFE		Rod/Strut, stabiliser	S050913
	2001.07-2006.11	Front Axle	Saloon FWD 1MZFE		Stabiliser Bushing	512947
	2001.07-2006.11	Rear Axle	Saloon FWD 1MZFE		Stabiliser Bushing	513136
	2001.07-2006.11	Front Axle	Saloon FWD 1MZFE		Steering Rack Bellow Kit	540211K
3.0 (138 kw)	1991.06-1996.08	Front Axle Left & Right Lower	Saloon FWD 3VZFE		Control Arm Bushing	511051
	1991.06-1996.08	Front Axle Left & Right Lower	Saloon FWD 3VZFE		Control Arm Bushing	514297
	1991.06-1996.08	Front Axle Left & Right Lower	Saloon FWD 3VZFE	Date from: 1991.09	Control Arm Bushing	514892
	1991.06-1996.08	Front Axle Left & Right Lower	Saloon FWD 3VZFE		Control Arm Bushing	514892
	1991.06-1996.08	Front Axle Left & Right Lower	Saloon FWD 3VZFE	Date from: 1991.09	Control Arm Bushing	516689
	1991.06-1996.08	Rear Axle Left & Right Lower	Saloon FWD 3VZFE		Control Arm Bushing	512038
	1991.06-1996.08	Rear Axle Left & Right Lower Centre	Saloon FWD 3VZFE		Control Arm Bushing	514918
	1991.06-1996.08	Rear Axle Left & Right Lower Inner	Saloon FWD 3VZFE		Control Arm Bushing	530066
	1991.06-1996.08	Rear Axle Left & Right Lower Outer	Saloon FWD 3VZFE		Control Arm Bushing	513034
	1991.06-1996.08	Front Axle Left & Right	Saloon FWD 3VZFE		Tie Rod Axle Joint	S030305
	1991.06-1996.08	Front Axle Left & Right	Saloon FWD 3VZFE		Tie Rod Axle Joint	S030834
	1991.06-1996.08	Front Axle Left & Right	Saloon FWD 3VZFE		Tie Rod End	S070470
	1991.06-1996.08	Front Axle Left & Right	Saloon FWD 3VZFE		Rod/Strut, stabiliser	530590S
	1991.06-1996.08	Rear Axle Left & Right	Saloon FWD 3VZFE		Rod/Strut, stabiliser	S050912
	1991.06-1996.08	Rear Axle	Saloon FWD 3VZFE		Stabiliser Bushing	512941
	1991.06-1996.08	Rear Axle	Saloon FWD 3VZFE		Stabiliser Bushing	512943
	1991.06-1996.08	Rear Axle	Saloon FWD 3VZFE		Stabiliser Bushing	513135
	1991.06-1996.08	Front Axle	Saloon FWD 3VZFE		Steering Boot	540034
	1991.06-1996.08	Front Axle	Saloon FWD 3VZFE		Steering Rack Bellow Kit	540211K
	3.0 (140 kw)	1996.08-2001.11	Front Axle Left Lower	Saloon FWD 1MZFE		Track Control Arm
1996.08-2001.11		Front Axle Right Lower	Saloon FWD 1MZFE		Track Control Arm	S060738
1996.08-2001.11		Rear Axle Left Lower Outer	Saloon FWD 1MZFE	For OE no.4874033060	Track Control Arm	S063222
1996.08-2001.11		Rear Axle Right Lower Outer	Saloon FWD 1MZFE		Track Control Arm	S062126
1996.08-2001.11		Front Axle Left & Right Lower	Saloon FWD 1MZFE		Ball Joint	S080234
1996.08-2001.11		Front Axle Left & Right Lower	Saloon FWD 1MZFE		Control Arm Bushing	512072
1996.08-2001.11		Front Axle Left & Right Lower	Saloon FWD 1MZFE	AT	Control Arm Bushing	514892
1996.08-2001.11		Front Axle Left & Right Lower	Saloon FWD 1MZFE	AT	Control Arm Bushing	516689
1996.08-2001.11		Rear Axle Left & Right Lower	Saloon FWD 1MZFE		Control Arm Bushing	514932
1996.08-2001.11		Rear Axle Left & Right Lower Outer	Saloon FWD 1MZFE		Control Arm Bushing	513034
1996.08-2001.11		Front Axle Left & Right	Saloon FWD 1MZFE		Tie Rod Axle Joint	S030305
1996.08-2001.11		Front Axle Left & Right	Saloon FWD 1MZFE		Tie Rod End	S070470
1996.08-2001.11		Front Axle Left	Saloon FWD 1MZFE		Rod/Strut, stabiliser	S050430
1996.08-2001.11		Front Axle Right	Saloon FWD 1MZFE		Rod/Strut, stabiliser	S050431
1996.08-2001.11		Rear Axle Left & Right	Saloon FWD 1MZFE		Rod/Strut, stabiliser	S050912
1996.08-2001.11		Front Axle	Saloon FWD 1MZFE		Stabiliser Bushing	512939
1996.08-2001.11		Front Axle	Saloon FWD 1MZFE		Stabiliser Bushing	512944
1996.08-2001.11		Rear Axle	Saloon FWD 1MZFE		Stabiliser Bushing	512941
1996.08-2001.11		Rear Axle	Saloon FWD 1MZFE		Stabiliser Bushing	512942
1996.08-2001.11		Rear Axle	Saloon FWD 1MZFE		Stabiliser Bushing	512943
1996.08-2001.11	Front Axle	Saloon FWD 1MZFE		Steering Rack Bellow Kit	540211K	
3.5 (204 kw)	2011.09-2017.12	Front Axle Left Lower	Saloon FWD 2GRFE		Track Control Arm	S061365
	2011.09-2017.12	Front Axle Right Lower	Saloon FWD 2GRFE		Track Control Arm	S061366
	2011.09-2017.12	Rear Axle Left Lower Outer	Saloon FWD 2GRFE		Track Control Arm	517343S
	2011.09-2017.12	Rear Axle Right Lower Outer	Saloon FWD 2GRFE		Track Control Arm	517793S
	2011.09-2017.12	Rear Axle Left & Right Lower Centre	Saloon FWD 2GRFE		Track Control Arm	S062960
	2011.09-2017.12	Rear Axle Left & Right Lower Inner	Saloon FWD 2GRFE		Track Control Arm	S063261
	2011.09-2017.12	Front Axle Left Lower	Saloon FWD 2GRFE		Ball Joint	S080461
	2011.09-2017.12	Front Axle Right Lower	Saloon FWD 2GRFE		Ball Joint	S080462
	2011.09-2017.12	Front Axle Left & Right Lower	Saloon FWD 2GRFE	AT	Control Arm Bushing	514296
	2011.09-2017.12	Front Axle Left & Right Lower	Saloon FWD 2GRFE	AT	Control Arm Bushing	516708
	2011.09-2017.12	Rear Axle Left & Right Lower	Saloon FWD 2GRFE		Control Arm Bushing	514932
	2011.09-2017.12	Rear Axle Left & Right Lower Centre	Saloon FWD 2GRFE		Control Arm Bushing	514918
	2011.09-2017.12	Rear Axle Left & Right Upper Inner	Saloon FWD 2GRFE		Control Arm Bushing	517771
	2011.09-2017.12	Front Axle Left	Saloon FWD 2GRFE		Tie Rod End	S071733
	2011.09-2017.12	Front Axle Right	Saloon FWD 2GRFE		Tie Rod End	S071766
	2011.09-2017.12	Front Axle Left & Right	Saloon FWD 2GRFE		Rod/Strut, stabiliser	S050564
	2011.09-2017.12	Rear Axle Left & Right	Saloon FWD 2GRFE		Rod/Strut, stabiliser	S050565



	 YEAR	FITTING POSITION	BODY STYLE & DRIVE TYPE & ENGINE	REMARKS	PRODUCT	GSP Ref.
TOYOTA						
Camry						
3.5 (204 kw)	2011.09-2017.12	Front Axle	Saloon FWD 2GRFE		Stabiliser Bushing	512947
Corolla						
1.6 (79 kw)	1997.04-2002.06	Front Axle Left Lower	Saloon FWD 4AFE		Track Control Arm	S060747
	1997.04-2002.06	Front Axle Right Lower	Saloon FWD 4AFE		Track Control Arm	S060735
	1997.04-2002.06	Front Axle Left & Right Lower	Saloon FWD 4AFE	Veh Prd Country:United Kingdom	Ball Joint	S080221
	1997.04-2002.06	Front Axle Left & Right Lower	Saloon FWD 4AFE		Control Arm Bushing	511042
	1997.04-2002.06	Front Axle Left & Right Lower	Saloon FWD 4AFE		Control Arm Bushing	511043
	1997.04-2002.06	Front Axle Left & Right Lower	Saloon FWD 4AFE		Control Arm Bushing	512974
	1997.04-2002.06	Front Axle Left & Right Lower	Saloon FWD 4AFE		Control Arm Bushing	513971
	1997.04-2002.06	Front Axle Left & Right Lower	Saloon FWD 4AFE	AT	Control Arm Bushing	514940
	1997.04-2002.06	Rear Axle Left & Right Lower Centre	Saloon FWD 4AFE		Control Arm Bushing	514922
	1997.04-2002.06	Rear Axle Left & Right Lower Outer	Saloon FWD 4AFE		Control Arm Bushing	516714
	1997.04-2002.06	Front Axle Left & Right	Saloon FWD 4AFE		Tie Rod Axle Joint	S030284
	1997.04-2002.06	Front Axle Left & Right	Saloon FWD 4AFE	VIN:SB1	Tie Rod Axle Joint	S030286
	1997.04-2002.06	Front Axle Left & Right	Saloon FWD 4AFE		Tie Rod End	S070450
	1997.04-2002.06	Front Axle Left & Right	Saloon FWD 4AFE		Rod/Strut,stabiliser	530590S
	1997.04-2002.06	Rear Axle Left & Right	Saloon FWD 4AFE		Rod/Strut,stabiliser	S050410
	1997.04-2002.06	Rear Axle Left & Right	Saloon FWD 4AFE		Rod/Strut,stabiliser	S050922
	1997.04-2002.06	Rear Axle	Saloon FWD 4AFE	for OE No.4881730010	Stabiliser Bushing	512266
	1997.04-2002.06	Rear Axle	Saloon FWD 4AFE		Stabiliser Bushing	513091
	1997.04-2002.06	Rear Axle	Saloon FWD 4AFE		Stabiliser Bushing	513105
	1997.04-2002.06	Rear Axle	Saloon FWD 4AFE		Stabiliser Bushing	513111
	1997.04-2002.06	Rear Axle	Saloon FWD 4AFE		Stabiliser Bushing	517820
	1997.04-2002.06	Front Axle	Saloon FWD 4AFE		Steering Boot	540213
	1997.04-2002.06	Front Axle	Saloon FWD 4AFE	MT	Steering Rack Bellow Kit	540211K
1.6 (81 kw)	2001.10-2008.03	Front Axle Left Lower	Saloon FWD 3ZZFE		Track Control Arm	S060743
	2001.10-2008.03	Front Axle Right Lower	Saloon FWD 3ZZFE		Track Control Arm	S060744
	2001.10-2008.03	Front Axle Left & Right Lower	Saloon FWD 3ZZFE	Veh Prd Country:United Kingdom	Ball Joint	S080221
	2001.10-2008.03	Front Axle Left & Right Lower	Saloon FWD 3ZZFE		Control Arm Bushing	512989
	2001.10-2008.03	Front Axle Left & Right Lower	Saloon FWD 3ZZFE		Control Arm Bushing	514962
	2001.10-2008.03	Front Axle Left & Right Lower	Saloon FWD 3ZZFE	Date to:2002.09	Control Arm Bushing	517363
	2001.10-2008.03	Front Axle Left & Right	Saloon FWD 3ZZFE	Date from:2004.05	Tie Rod Axle Joint	S030297
	2001.10-2008.03	Front Axle Left & Right	Saloon FWD 3ZZFE	Vehicle Production Country(Brazil,Type Corolla,Date to:2006.10	Tie Rod Axle Joint	S030827
	2001.10-2008.03	Front Axle Left	Saloon FWD 3ZZFE	Engine code:3ZZ-FE,Date to:2004.05,Engine code:3ZZ-FE	Tie Rod End	S070455
	2001.10-2008.03	Front Axle Left	Saloon FWD 3ZZFE		Tie Rod End	S070744
	2001.10-2008.03	Front Axle Right	Saloon FWD 3ZZFE	Engine code:3ZZ-FE,Date to:2004.05,Engine code:3ZZ-FE	Tie Rod End	S070456
	2001.10-2008.03	Front Axle Right	Saloon FWD 3ZZFE		Tie Rod End	S070745
	2001.10-2008.03	Front Axle Left & Right	Saloon FWD 3ZZFE		Tie Rod End	S070862
	2001.10-2008.03	Front Axle Left & Right	Saloon FWD 3ZZFE	Country-spec.model:Europe	Rod/Strut,stabiliser	S050416
	2001.10-2008.03	Front Axle Left & Right	Saloon FWD 3ZZFE	Engine code:3ZZ-FE,Country-spec.model:Japan,Engine code:3ZZ-FE	Rod/Strut,stabiliser	S050586
	2001.10-2008.03	Front Axle	Saloon FWD 3ZZFE		Stabiliser Bushing	512965
	2001.10-2008.03	Front Axle	Saloon FWD 3ZZFE		Stabiliser Bushing	516777
	2001.10-2008.03	Front Axle	Saloon FWD 3ZZFE	for vehicles with power steering	Steering Boot	540330
	2001.10-2008.03	Front Axle	Saloon FWD 3ZZFE	For OE.no.GA2A3212X	Steering Rack Bellow Kit	540211K
	2001.10-2008.03	Front Axle	Saloon FWD 3ZZFE	for vehicles with power steering	Steering Rack Bellow Kit	540330S
	2001.10-2008.03	Front Axle	Saloon FWD 3ZZFE		Steering Bushing	516703
	2001.10-2008.03	-	Saloon FWD 3ZZFE		Steering Bushing	516704
1.8 (85 kw)	1997.04-2002.06	Front Axle Left & Right Lower	Saloon FWD 7AFE		Ball Joint	S080221
	1997.04-2002.06	Front Axle Left & Right Lower	Saloon FWD 7AFE		Control Arm Bushing	514940
	1997.04-2002.06	Rear Axle Left & Right Lower Centre	Saloon FWD 7AFE		Control Arm Bushing	514922
	1997.04-2002.06	Rear Axle Left & Right Lower Outer	Saloon FWD 7AFE		Control Arm Bushing	516714
1.8 (100 kw)	2001.12-2008.03	Front Axle Right Lower	Saloon FWD 1ZZFE		Track Control Arm	S060744
	2001.12-2008.03	Front Axle Left & Right Lower	Saloon FWD 1ZZFE		Ball Joint	S080221
	2001.12-2008.03	Front Axle Left	Saloon FWD 1ZZFE		Tie Rod End	S070744
	2001.12-2008.03	Front Axle Right	Saloon FWD 1ZZFE		Tie Rod End	S070745
Corolla Altis						
1.6 (81 kw)	2007.08-2013.06	Front Axle Left & Right	Saloon FWD 3ZZFE		Tie Rod Axle Joint	S030966
	2007.08-2013.06	Front Axle Left & Right	Saloon FWD 3ZZFE		Tie Rod End	S070970
	2007.08-2013.06	Front Axle Left & Right	Saloon FWD 3ZZFE	Date from:2009.01	Tie Rod End	S071698
1.8 (100 kw)	2001.11-2008.03	Front Axle Right Lower	Saloon FWD 1ZZFE		Track Control Arm	S060744
	2001.11-2008.03	Front Axle Left & Right Lower	Saloon FWD 1ZZFE		Ball Joint	S080221
	2001.11-2008.03	Front Axle Left	Saloon FWD 1ZZFE		Tie Rod End	S070744
	2001.11-2008.03	Front Axle Right	Saloon FWD 1ZZFE		Tie Rod End	S070745



	 YEAR	FITTING POSITION	BODY STYLE & DRIVE TYPE & ENGINE	REMARKS	PRODUCT	GSP Ref.
TOYOTA						
Corolla Estate/Wagon						
1.8 (100 kw)	2001.12-2007.12	Front Axle Left Lower	Estate FWD 1ZZFE		Track Control Arm	S060743
	2001.12-2007.12	Front Axle Right Lower	Estate FWD 1ZZFE		Track Control Arm	S060744
	2001.12-2007.12	Front Axle Left & Right Lower	Estate FWD 1ZZFE		Ball Joint	S080221
	2001.12-2007.12	Front Axle Left	Estate FWD 1ZZFE		Tie Rod End	S070744
	2001.12-2007.12	Front Axle Right	Estate FWD 1ZZFE		Tie Rod End	S070745
FJ Cruiser						
4.0 (176 kw)	2005.06-2009.12	Front Axle Left & Right Upper	SUV 4WD 1GRFE		Ball Joint	S080591
	2005.06-2009.12	Front Axle Left & Right Lower	SUV 4WD 1GRFE	Date to:1999.07	Control Arm Bushing	512019
	2005.06-2009.12	Front Axle Left & Right Lower	SUV 4WD 1GRFE	Date from:2009.08	Control Arm Bushing	516536
	2005.06-2009.12	Rear Axle Left & Right Upper	SUV 4WD 1GRFE		Control Arm Bushing	516355
	2005.06-2009.12	Rear Axle Left & Right Lower Inner	SUV 4WD 1GRFE		Control Arm Bushing	516123
	2005.06-2009.12	Rear Axle Left & Right Lower Outer	SUV 4WD 1GRFE		Control Arm Bushing	512057
	2005.06-2009.12	Front Axle Left & Right	SUV 4WD 1GRFE		Tie Rod Axle Joint	S031038
	2005.06-2009.12	Front Axle Left & Right	SUV 4WD 1GRFE	Date to:1999.07	Tie Rod End	S070485
	2005.06-2009.12	Front Axle Left & Right	SUV 4WD 1GRFE		Tie Rod End	S070803
	2005.06-2009.12	Front Axle Right	SUV 4WD 1GRFE		Rod/Strut,stabiliser	S050612
	2005.06-2009.12	Rear Axle Left & Right	SUV 4WD 1GRFE		Rod/Strut,stabiliser	S050437
Fortuner						
2.8 (130 kw)	2015.05-	Front Axle Left & Right Lower	SUV 4WD 1GDFTV		Ball Joint	S080459
	2015.05-	Front Axle Left & Right Upper	SUV 4WD 1GDFTV		Ball Joint	S080374
	2015.05-	Front Axle Left & Right Upper	SUV 4WD 1GDFTV		Control Arm Bushing	532001
	2015.05-	Front Axle Left	SUV 4WD 1GDFTV		Rod/Strut,stabiliser	S050421
	2015.05-	Front Axle Right	SUV 4WD 1GDFTV		Rod/Strut,stabiliser	S050612
	2015.05-	Rear Axle Left & Right	SUV 4WD 1GDFTV		Rod/Strut,stabiliser	S051475
3.0 (120 kw)	2004.06-2015.05	Front Axle Left & Right Upper	SUV 4WD 1KDFTV		Control Arm Bushing	532001
	2004.06-2015.05	Front Axle	SUV 4WD 1KDFTV		Steering Boot	540079
	2004.06-2015.05	Front Axle	SUV 4WD 1KDFTV		Steering Rack Bellow Kit	540224S
3.0 (126 kw)	2009.08-2015.05	Front Axle Left & Right Upper	SUV 4WD 1KDFTV		Control Arm Bushing	532001
	2009.08-2015.05	Front Axle	SUV 4WD 1KDFTV		Steering Boot	540079
	2009.08-2015.05	Front Axle	SUV 4WD 1KDFTV		Steering Rack Bellow Kit	540224S
4.0 (175 kw)	2005.01-2015.05	Front Axle Left & Right Upper	SUV 4WD 1GRFE		Control Arm Bushing	532001
	2015.11-	Front Axle Left & Right Upper	SUV 4WD 1GRFE		Control Arm Bushing	532001
Hilux						
2.5 (75 kw)	2005.03-2015.05	Front Axle Left Lower	Pick up 4WD 2KDFTV		Track Control Arm	S061371
	2005.03-2015.05	Front Axle Left Lower	Pick up RWD 2KDFTV		Track Control Arm	S061371
	2005.03-2015.05	Front Axle Left Lower	Pick up RWD 2KDFTV		Track Control Arm	S061826
	2005.03-2015.05	Front Axle Left Upper	Pick up 4WD 2KDFTV		Track Control Arm	S061451
	2005.03-2015.05	Front Axle Left Upper	Pick up RWD 2KDFTV		Track Control Arm	S061997
	2005.03-2015.05	Front Axle Right Lower	Pick up 4WD 2KDFTV		Track Control Arm	S061372
	2005.03-2015.05	Front Axle Right Lower	Pick up RWD 2KDFTV		Track Control Arm	S061372
	2005.03-2015.05	Front Axle Right Lower	Pick up RWD 2KDFTV		Track Control Arm	S061827
	2005.03-2015.05	Front Axle Right Upper	Pick up 4WD 2KDFTV		Track Control Arm	S061450
	2005.03-2015.05	Front Axle Right Upper	Pick up RWD 2KDFTV		Track Control Arm	S061998
	2005.03-2015.05	Front Axle Left & Right Lower	Pick up 4WD 2KDFTV		Ball Joint	S080459
	2005.03-2015.05	Front Axle Left & Right Lower	Pick up RWD 2KDFTV		Ball Joint	S080459
	2005.03-2015.05	Front Axle Left & Right Upper	Pick up 4WD 2KDFTV		Ball Joint	S080374
	2005.03-2015.05	Front Axle Left & Right Upper	Pick up RWD 2KDFTV		Ball Joint	S080374
	2005.03-2015.05	Front Axle Left & Right Lower	Pick up 4WD 2KDFTV		Control Arm Bushing	512020
	2005.03-2015.05	Front Axle Left & Right Lower	Pick up RWD 2KDFTV		Control Arm Bushing	512020
	2005.03-2015.05	Front Axle Left & Right Lower	Pick up RWD 2KDFTV		Control Arm Bushing	512987
	2005.03-2015.05	Front Axle Left & Right Lower	Pick up 4WD 2KDFTV		Control Arm Bushing	512988
	2005.03-2015.05	Front Axle Left & Right Lower	Pick up RWD 2KDFTV		Control Arm Bushing	513211
	2005.03-2015.05	Front Axle Left & Right Upper	Pick up RWD 2KDFTV		Control Arm Bushing	512986
	2005.03-2015.05	Front Axle Left & Right Upper	Pick up 4WD 2KDFTV		Control Arm Bushing	516311
	2005.03-2015.05	Front Axle Left & Right Upper	Pick up 4WD 2KDFTV		Control Arm Bushing	532001
	2005.03-2015.05	Front Axle Left & Right	Pick up 4WD 2KDFTV		Tie Rod Axle Joint	S030446
	2005.03-2015.05	Front Axle Left & Right	Pick up RWD 2KDFTV		Tie Rod Axle Joint	S030446
	2005.03-2015.05	Front Axle Left & Right	Pick up 4WD 2KDFTV		Tie Rod End	S070647
	2005.03-2015.05	Front Axle Left & Right	Pick up RWD 2KDFTV		Tie Rod End	S070647
	2005.03-2015.05	Front Axle Left & Right	Pick up RWD 2KDFTV	for vehicles with power steering	Tie Rod End	S070648
	2005.03-2015.05	Front Axle Left	Pick up 4WD 2KDFTV		Rod/Strut,stabiliser	S050421
	2005.03-2015.05	Front Axle Left	Pick up RWD 2KDFTV		Rod/Strut,stabiliser	S050421
	2005.03-2015.05	Front Axle Right	Pick up 4WD 2KDFTV		Rod/Strut,stabiliser	S050612
	2005.03-2015.05	Front Axle Right	Pick up RWD 2KDFTV		Rod/Strut,stabiliser	S050612



	 YEAR	FITTING POSITION	BODY STYLE & DRIVE TYPE & ENGINE	REMARKS	PRODUCT	GSP Ref.
TOYOTA Hilux						
2.5 (75 kw)	2005.03-2015.05	Front Axle Left & Right	Pick up RWD 2KDFTV		Rod/Strut,stabiliser	S050615
	2005.03-2015.05	Front Axle	Pick up 4WD 2KDFTV		Stabiliser Bushing	513610
	2005.03-2015.05	Front Axle	Pick up RWD 2KDFTV		Stabiliser Bushing	513610
	2005.03-2015.05	Front Axle	Pick up RWD 2KDFTV		Stabiliser Bushing	532769
	2005.03-2015.05	Front Axle	Pick up 4WD 2KDFTV		Steering Boot	540079
	2005.03-2015.05	Front Axle	Pick up RWD 2KDFTV		Steering Boot	540079
	2005.03-2015.05	Front Axle	Pick up 4WD 2KDFTV	MT	Steering Rack Bellow Kit	540224S
	2005.03-2015.05	Front Axle	Pick up RWD 2KDFTV	MT	Steering Rack Bellow Kit	540224S
	2005.03-2015.05	Front Axle	Pick up 4WD 2KDFTV		Steering Rack Bellow Kit	540249S
	2005.03-2015.05	Front Axle	Pick up RWD 2KDFTV		Steering Rack Bellow Kit	540249S
2.8 (130 kw)	2015.05-	Front Axle Left Upper	Pick up 4WD 1GDFTV		Track Control Arm	S061451
	2015.05-	Front Axle Right Upper	Pick up 4WD 1GDFTV		Track Control Arm	S061450
	2015.05-	Front Axle Left & Right Lower	Pick up 4WD 1GDFTV		Ball Joint	S080459
	2015.05-	Front Axle Left & Right Upper	Pick up 4WD 1GDFTV		Ball Joint	S080374
	2015.05-	Front Axle Left & Right Lower	Pick up 4WD 1GDFTV		Control Arm Bushing	535156
	2015.05-	Front Axle Left & Right Lower	Pick up 4WD 1GDFTV		Control Arm Bushing	535157
	2015.05-	Front Axle Left & Right Upper	Pick up 4WD 1GDFTV		Control Arm Bushing	532001
	2015.05-	Front Axle Left & Right	Pick up 4WD 1GDFTV		Tie Rod End	S071704
	2015.05-	Front Axle Left	Pick up 4WD 1GDFTV		Rod/Strut,stabiliser	S050421
	2015.05-	Front Axle Right	Pick up 4WD 1GDFTV		Rod/Strut,stabiliser	S050612
	2015.05-	Front Axle	Pick up 4WD 1GDFTV		Stabiliser Bushing	535006
2.8 (150 kw)	2020.06-	Front Axle Left & Right Lower	Pick up 4WD 1GDFTV		Control Arm Bushing	535156
	2020.06-	Front Axle Left & Right Lower	Pick up 4WD 1GDFTV		Control Arm Bushing	535157
	2020.06-	Front Axle Left & Right	Pick up 4WD 1GDFTV		Tie Rod End	S071704
3.0 (120 kw)	2005.03-2015.05	Front Axle Left Upper	Pick up 4WD 1KDFTV		Track Control Arm	S061451
	2005.03-2015.05	Front Axle Right Upper	Pick up 4WD 1KDFTV		Track Control Arm	S061450
	2005.03-2015.05	Front Axle Left & Right Lower	Pick up 4WD 1KDFTV		Ball Joint	S080459
	2005.03-2015.05	Front Axle Left & Right Upper	Pick up 4WD 1KDFTV		Ball Joint	S080374
	2005.03-2015.05	Front Axle Left & Right Lower	Pick up 4WD 1KDFTV		Control Arm Bushing	512020
	2005.03-2015.05	Front Axle Left & Right Upper	Pick up 4WD 1KDFTV		Control Arm Bushing	532001
	2005.03-2015.05	Front Axle Left	Pick up 4WD 1KDFTV		Rod/Strut,stabiliser	S050421
	2005.03-2015.05	Front Axle Right	Pick up 4WD 1KDFTV		Rod/Strut,stabiliser	S050612
	2005.03-2015.05	Front Axle	Pick up 4WD 1KDFTV		Steering Boot	540079
	2005.03-2015.05	Front Axle	Pick up 4WD 1KDFTV		Steering Rack Bellow Kit	540224S
3.0 (126 kw)	2006.10-2015.05	Front Axle Left Lower	Pick up 4WD 1KDFTV		Track Control Arm	S061371
	2006.10-2015.05	Front Axle Left Upper	Pick up 4WD 1KDFTV		Track Control Arm	S061451
	2006.10-2015.05	Front Axle Right Lower	Pick up 4WD 1KDFTV		Track Control Arm	S061372
	2006.10-2015.05	Front Axle Right Upper	Pick up 4WD 1KDFTV		Track Control Arm	S061450
	2006.10-2015.05	Front Axle Left & Right Lower	Pick up 4WD 1KDFTV		Ball Joint	S080459
	2006.10-2015.05	Front Axle Left & Right Upper	Pick up 4WD 1KDFTV		Ball Joint	S080374
	2006.10-2015.05	Front Axle Left & Right Lower	Pick up 4WD 1KDFTV		Control Arm Bushing	512020
	2006.10-2015.05	Front Axle Left & Right Lower	Pick up 4WD 1KDFTV		Control Arm Bushing	512988
	2006.10-2015.05	Front Axle Left & Right Upper	Pick up 4WD 1KDFTV		Control Arm Bushing	516311
	2006.10-2015.05	Front Axle Left & Right Upper	Pick up 4WD 1KDFTV		Control Arm Bushing	532001
	2006.10-2015.05	Front Axle Left & Right	Pick up 4WD 1KDFTV		Tie Rod Axle Joint	S030446
	2006.10-2015.05	Front Axle Left & Right	Pick up 4WD 1KDFTV		Tie Rod End	S070647
	2006.10-2015.05	Front Axle Left	Pick up 4WD 1KDFTV		Rod/Strut,stabiliser	S050421
	2006.10-2015.05	Front Axle Right	Pick up 4WD 1KDFTV		Rod/Strut,stabiliser	S050612
	2006.10-2015.05	Front Axle	Pick up 4WD 1KDFTV		Stabiliser Bushing	513610
	2006.10-2015.05	Front Axle	Pick up 4WD 1KDFTV		Steering Boot	540079
	2006.10-2015.05	Front Axle	Pick up 4WD 1KDFTV	MT	Steering Rack Bellow Kit	540224S
	2006.10-2015.05	Front Axle	Pick up 4WD 1KDFTV		Steering Rack Bellow Kit	540249S
4.0 (175 kw)	2015.07-	Front Axle Left Upper	Pick up 4WD 1GRFE		Track Control Arm	S061451
	2015.07-	Front Axle Right Upper	Pick up 4WD 1GRFE		Track Control Arm	S061450
	2015.07-	Front Axle Left & Right Lower	Pick up 4WD 1GRFE		Control Arm Bushing	535156
	2015.07-	Front Axle Left & Right Lower	Pick up 4WD 1GRFE		Control Arm Bushing	535157
	2015.07-	Front Axle Left & Right Upper	Pick up 4WD 1GRFE		Control Arm Bushing	532001
	2015.07-	Front Axle Left & Right	Pick up 4WD 1GRFE		Tie Rod End	S071704
	2015.07-	Front Axle	Pick up 4WD 1GRFE		Stabiliser Bushing	535006
Hilux Surf						
3.0 (112 kw)	1990.01-1995.11	Rear Axle Left & Right Lower	SUV 4WD 3VZE		Control Arm Bushing	512992
Land Cruiser Prado						
3.0 (96 kw)	2003.03-2007.02	Rear Axle Left & Right Upper	Terrain cab wagon closed 4WD 1KZTE		Control Arm Bushing	516355
	2003.03-2007.02	Rear Axle Left & Right Lower Outer	Terrain cab wagon closed 4WD 1KZTE		Control Arm Bushing	512057



	 YEAR	FITTING POSITION	BODY STYLE & DRIVE TYPE & ENGINE	REMARKS	PRODUCT	GSP Ref.
TOYOTA						
Land Cruiser Prado						
3.0 (96 kw)	2003.03-2007.02	Rear Axle Left & Right	Terrain cab wagon closed 4WD 1KZTE		Rod/Strut, stabiliser	S050437
3.0 (120 kw)	2002.09-2009.08	Front Axle Left Lower	Terrain cab wagon closed 4WD 1KDFTV		Track Control Arm	S061448
	2002.09-2009.08	Front Axle Left Upper	Terrain cab wagon closed 4WD 1KDFTV		Track Control Arm	S061369
	2002.09-2009.08	Front Axle Right Lower	Terrain cab wagon closed 4WD 1KDFTV		Track Control Arm	S061449
	2002.09-2009.08	Front Axle Right Upper	Terrain cab wagon closed 4WD 1KDFTV		Track Control Arm	S061370
	2002.09-2009.08	Front Axle Left & Right Lower	Terrain cab wagon closed 4WD 1KDFTV		Ball Joint	S080476
	2002.09-2009.08	Front Axle Left & Right Upper	Terrain cab wagon closed 4WD 1KDFTV		Ball Joint	S080591
	2002.09-2009.08	Front Axle Left & Right Lower	Terrain cab wagon closed 4WD 1KDFTV		Control Arm Bushing	512019
	2002.09-2009.08	Front Axle Left & Right Lower	Terrain cab wagon closed 4WD 1KDFTV		Control Arm Bushing	512020
	2002.09-2009.08	Front Axle Left & Right Upper	Terrain cab wagon closed 4WD 1KDFTV		Control Arm Bushing	512018
	2002.09-2009.08	Rear Axle Left & Right Upper	Terrain cab wagon closed 4WD 1KDFTV		Control Arm Bushing	516355
	2002.09-2009.08	Rear Axle Left & Right Lower Inner	Terrain cab wagon closed 4WD 1KDFTV		Control Arm Bushing	516123
	2002.09-2009.08	Rear Axle Left & Right Lower Outer	Terrain cab wagon closed 4WD 1KDFTV		Control Arm Bushing	512057
	2002.09-2009.08	Front Axle Left & Right	Terrain cab wagon closed 4WD 1KDFTV		Tie Rod Axle Joint	S030306
	2002.09-2009.08	Front Axle Left & Right	Terrain cab wagon closed 4WD 1KDFTV		Tie Rod End	S070485
	2002.09-2009.08	Front Axle Left	Terrain cab wagon closed 4WD 1KDFTV		Rod/Strut, stabiliser	S050421
	2002.09-2009.08	Front Axle Right	Terrain cab wagon closed 4WD 1KDFTV		Rod/Strut, stabiliser	S050612
	2002.09-2009.08	Rear Axle Left & Right	Terrain cab wagon closed 4WD 1KDFTV		Rod/Strut, stabiliser	S050437
	2002.09-2009.08	Front Axle	Terrain cab wagon closed 4WD 1KDFTV		Stabiliser Bushing	512954
	2002.09-2009.08	Rear Axle	Terrain cab wagon closed 4WD 1KDFTV		Stabiliser Bushing	512266
	2002.09-2009.08	Rear Axle	Terrain cab wagon closed 4WD 1KDFTV		Stabiliser Bushing	512952
	2002.09-2009.08	Rear Axle	Terrain cab wagon closed 4WD 1KDFTV		Stabiliser Bushing	513126
	2002.09-2009.08	Front Axle	Terrain cab wagon closed 4WD 1KDFTV		Steering Boot	540134
	2002.09-2009.08	Front Axle	Terrain cab wagon closed 4WD 1KDFTV		Steering Boot	540326
	2002.09-2009.08	Front Axle Left	Terrain cab wagon closed 4WD 1KDFTV		Steering Bushing	516380
	2002.09-2009.08	Front Axle Right	Terrain cab wagon closed 4WD 1KDFTV		Steering Bushing	516377
	2002.09-2009.08	Front Axle Left	Terrain cab wagon closed 4WD 1KDFTV		Steering Bushing Kit	516380S
	2002.09-2009.08	Front Axle Right	Terrain cab wagon closed 4WD 1KDFTV		Steering Bushing Kit	516377S
2002.09-2009.08	Front Axle	Terrain cab wagon closed 4WD 1KDFTV		Steering Bushing Kit	531545S	
Paseo						
1.5 (74 kw)	1991.04-1995.08	Front Axle Left Lower	Coupe FWD 5EFE		Track Control Arm	S061454
	1991.04-1995.08	Front Axle Right Lower	Coupe FWD 5EFE		Track Control Arm	S061453
	1991.04-1995.08	Front Axle Left Lower	Coupe FWD 5EFE		Ball Joint	S080241
	1991.04-1995.08	Front Axle Right Lower	Coupe FWD 5EFE		Ball Joint	S080242
	1991.04-1995.08	Front Axle Left & Right Lower	Coupe FWD 5EFE		Control Arm Bushing	516709
	1991.04-1995.08	Rear Axle Left & Right Centre	Coupe FWD 5EFE		Control Arm Bushing	517450
	1991.04-1995.08	Rear Axle Left & Right Lower	Coupe FWD 5EFE		Control Arm Bushing	516341
	1991.04-1995.08	Front Axle Left & Right	Coupe FWD 5EFE		Tie Rod Axle Joint	S030285
	1991.04-1995.08	Front Axle Left & Right	Coupe FWD 5EFE		Tie Rod End	S070443
	1991.04-1995.08	Front Axle Left & Right	Coupe FWD 5EFE		Rod/Strut, stabiliser	513083
	Previa					
2.4 (97 kw)	1990.05-2000.08	Front Axle Left & Right Lower	MPV RWD 2TZFE		Ball Joint	S080233
	1990.05-2000.08	Front Axle Left & Right Lower	MPV RWD 2TZFE		Control Arm Bushing	512982
	1990.05-2000.08	Rear Axle Left & Right Lower	MPV RWD 2TZFE	For OE no.:4871028071	Control Arm Bushing	512992
	1990.05-2000.08	Rear Axle Left & Right Lower	MPV RWD 2TZFE	Date from-to:1992.01-1999.12	Control Arm Bushing	513014
	1990.05-2000.08	Rear Axle Left & Right Lower	MPV RWD 2TZFE		Control Arm Bushing	514935
	1990.05-2000.08	Rear Axle Left & Right Lower	MPV RWD 2TZFE		Control Arm Bushing	516276
	1990.05-2000.08	Rear Axle Left & Right Lower	MPV RWD 2TZFE		Control Arm Bushing	516421
	1990.05-2000.08	Front Axle Left & Right	MPV RWD 2TZFE		Tie Rod Axle Joint	S030304
	1990.05-2000.08	Front Axle Left	MPV RWD 2TZFE		Tie Rod End	S070468
	1990.05-2000.08	Front Axle Right	MPV RWD 2TZFE		Tie Rod End	S070469
	1990.05-2000.08	Front Axle Left	MPV RWD 2TZFE		Rod/Strut, stabiliser	S050414
	1990.05-2000.08	Front Axle Right	MPV RWD 2TZFE		Rod/Strut, stabiliser	530589S
	1990.05-2000.08	Front Axle Right	MPV RWD 2TZFE		Rod/Strut, stabiliser	S050415
	1990.05-2000.08	Front Axle	MPV RWD 2TZFE		Stabiliser Bushing	511036
Rav 4						
2.0 (94 kw)	1997.12-2000.06	Front Axle Left Lower	SUV 4WD 3SFE		Track Control Arm	S060731
	1997.12-2000.06	Front Axle Right Lower	SUV 4WD 3SFE		Track Control Arm	S060914
	1997.12-2000.06	Rear Axle Left Lower	SUV 4WD 3SFE	MT	Track Control Arm	S063093
	1997.12-2000.06	Rear Axle Left Lower	SUV 4WD 3SFE	MT, for left-hand drive vehicles	Track Control Arm	S063093
	1997.12-2000.06	Front Axle Left & Right Lower	SUV 4WD 3SFE		Ball Joint	S080372
	1997.12-2000.06	Front Axle Left & Right Lower	SUV 4WD 3SFE		Control Arm Bushing	516698
	1997.12-2000.06	Front Axle Left & Right Lower	SUV 4WD 3SFE		Control Arm Bushing	530541
	1997.12-2000.06	Front Axle Left & Right	SUV 4WD 3SFE		Tie Rod End	S070450



	 YEAR	FITTING POSITION	BODY STYLE & DRIVE TYPE & ENGINE	REMARKS	PRODUCT	GSP Ref.
TOYOTA						
Rav 4						
2.0 (94 kw)	1997.12-2000.06	Front Axle Left & Right	SUV 4WD 3SFE		Rod/Strut,stabiliser	530590S
	1997.12-2000.06	Front Axle Left & Right	SUV 4WD 3SFE		Rod/Strut,stabiliser	S050439
	1997.12-2000.06	Front Axle	SUV 4WD 3SFE		Stabiliser Bushing	512960
2.0 (107 kw)	2012.12-	Front Axle Left Lower	SUV 4WD 3ZRFE		Track Control Arm	S060917
	2012.12-	Front Axle Right Lower	SUV 4WD 3ZRFE		Track Control Arm	S060918
	2012.12-	Rear Axle Left Upper Outer	SUV FWD 3ZRFE		Track Control Arm	S062580
	2012.12-	Rear Axle Left Upper Outer	SUV 4WD 3ZRFE		Track Control Arm	S062580
	2012.12-	Rear Axle Right Upper Outer	SUV FWD 3ZRFE		Track Control Arm	S062579
	2012.12-	Rear Axle Right Upper Outer	SUV 4WD 3ZRFE		Track Control Arm	S062579
	2012.12-	Rear Axle Left & Right Lower Inner	SUV FWD 3ZRFE		Track Control Arm	S063196
	2012.12-	Rear Axle Left & Right Lower Inner	SUV 4WD 3ZRFE		Track Control Arm	S063196
	2012.12-	Front Axle Left & Right Lower	SUV FWD 3ZRFE		Ball Joint	S080244
	2012.12-	Front Axle Left & Right Lower	SUV 4WD 3ZRFE		Ball Joint	S080244
	2012.12-	Front Axle Left & Right Lower	SUV FWD 3ZRFE		Control Arm Bushing	516217
	2012.12-	Front Axle Left & Right Lower	SUV 4WD 3ZRFE		Control Arm Bushing	516217
	2012.12-	Rear Axle Left & Right Upper Inner	SUV FWD 3ZRFE		Control Arm Bushing	516214
	2012.12-	Rear Axle Left & Right Upper Inner	SUV FWD 3ZRFE		Control Arm Bushing	516223
	2012.12-	Rear Axle Left & Right Upper Inner	SUV 4WD 3ZRFE		Control Arm Bushing	516223
	2012.12-	Rear Axle Left & Right Lower Outer	SUV FWD 3ZRFE		Control Arm Bushing	516229
	2012.12-	Rear Axle Left & Right Lower Outer	SUV 4WD 3ZRFE		Control Arm Bushing	516229
	2012.12-	Rear Axle Left & Right Upper Outer	SUV FWD 3ZRFE		Control Arm Bushing	516512
	2012.12-	Rear Axle Left & Right Upper Outer	SUV 4WD 3ZRFE		Control Arm Bushing	516512
	2012.12-	Rear Axle Left & Right Upper Inner	SUV FWD 3ZRFE		Control Arm Bushing Kit	516223S
	2012.12-	Front Axle	SUV 4WD 3ZRFE		Pitman Arm	S010037
	2012.12-	Front Axle Left	SUV FWD 3ZRFE		Tie Rod End	S070490
	2012.12-	Front Axle Left	SUV 4WD 3ZRFE		Tie Rod End	S070490
	2012.12-	Front Axle Right	SUV FWD 3ZRFE		Tie Rod End	S070491
	2012.12-	Front Axle Right	SUV 4WD 3ZRFE		Tie Rod End	S070491
	2012.12-	Front Axle Left & Right	SUV FWD 3ZRFE		Rod/Strut,stabiliser	S050440
	2012.12-	Front Axle Left & Right	SUV 4WD 3ZRFE		Rod/Strut,stabiliser	S050440
	2012.12-	Rear Axle Left & Right	SUV 4WD 3ZRFE		Rod/Strut,stabiliser	S050441
	2012.12-	Front Axle Left	SUV 4WD 3ZRFE		Stabiliser Bushing	516811
	2012.12-	Front Axle Right	SUV 4WD 3ZRFE		Stabiliser Bushing	517786
	2012.12-	Rear Axle	SUV FWD 3ZRFE		Stabiliser Bushing	535010
	2012.12-	Rear Axle	SUV 4WD 3ZRFE		Stabiliser Bushing	535010
2.0 (110 kw)	2000.05-2005.11	Front Axle Left Lower	SUV 4WD 1AZFE		Track Control Arm	S060915
	2000.05-2005.11	Front Axle Right Lower	SUV 4WD 1AZFE		Track Control Arm	S060916
	2000.05-2005.11	Rear Axle Left Lower	SUV 4WD 1AZFE		Track Control Arm	S062994
	2000.05-2005.11	Rear Axle Right Lower	SUV 4WD 1AZFE		Track Control Arm	S062995
	2000.05-2005.11	Rear Axle Left & Right Upper	SUV 4WD 1AZFE		Track Control Arm	S061694
	2000.05-2005.11	Front Axle Left & Right Lower	SUV 4WD 1AZFE		Ball Joint	S080221
	2000.05-2005.11	Front Axle Left & Right Lower	SUV 4WD 1AZFE		Control Arm Bushing	516070
	2000.05-2005.11	Front Axle Left & Right Lower	SUV 4WD 1AZFE		Control Arm Bushing	516243
	2000.05-2005.11	Front Axle Left & Right Lower	SUV 4WD 1AZFE		Control Arm Bushing	532431
	2000.05-2005.11	Rear Axle Left & Right Centre	SUV 4WD 1AZFE		Control Arm Bushing	514003
	2000.05-2005.11	Rear Axle Left & Right Lower	SUV 4WD 1AZFE		Control Arm Bushing	530511
	2000.05-2005.11	Front Axle Left & Right	SUV 4WD 1AZFE	Date to:2003.07	Tie Rod Axle Joint	S030299
	2000.05-2005.11	Front Axle Left & Right	SUV 4WD 1AZFE	Date from:2003.07	Tie Rod Axle Joint	S030558
	2000.05-2005.11	Front Axle Left	SUV 4WD 1AZFE		Tie Rod End	S070459
	2000.05-2005.11	Front Axle Right	SUV 4WD 1AZFE		Tie Rod End	S070460
	2000.05-2005.11	Front Axle Left & Right	SUV 4WD 1AZFE		Rod/Strut,stabiliser	S050418
	2000.05-2005.11	Rear Axle Left	SUV 4WD 1AZFE		Rod/Strut,stabiliser	S050427
	2000.05-2005.11	Rear Axle Right	SUV 4WD 1AZFE		Rod/Strut,stabiliser	S050428
	2000.05-2005.11	Front Axle	SUV 4WD 1AZFE		Stabiliser Bushing	512938
	2000.05-2005.11	Front Axle	SUV 4WD 1AZFE		Stabiliser Bushing	513129
	2000.05-2005.11	Rear Axle	SUV 4WD 1AZFE		Stabiliser Bushing	512937
	2000.05-2005.11	Rear Axle	SUV 4WD 1AZFE		Stabiliser Bushing	517330
2.4 (125 kw)	2005.11-2013.06	Rear Axle Left Upper Outer	SUV 4WD 2AZFE		Track Control Arm	S062580
	2005.11-2013.06	Rear Axle Right Upper Outer	SUV 4WD 2AZFE		Track Control Arm	S062579
	2005.11-2013.06	Rear Axle Left & Right Lower Inner	SUV 4WD 2AZFE		Track Control Arm	S063196
	2005.11-2013.06	Front Axle Left & Right Lower	SUV 4WD 2AZFE		Control Arm Bushing	513219
	2005.11-2013.06	Front Axle Left & Right Lower	SUV 4WD 2AZFE		Control Arm Bushing	516217
	2005.11-2013.06	Rear Axle Left & Right Upper Inner	SUV 4WD 2AZFE		Control Arm Bushing	516214
	2005.11-2013.06	Rear Axle Left & Right Upper Inner	SUV 4WD 2AZFE		Control Arm Bushing	516223



	 YEAR	FITTING POSITION	BODY STYLE & DRIVE TYPE & ENGINE	REMARKS	PRODUCT	GSP Ref.
TOYOTA						
Rav 4						
2.4 (125 kw)	2005.11-2013.06	Rear Axle Left & Right Lower Outer	SUV 4WD 2AZFE		Control Arm Bushing	516229
	2005.11-2013.06	Rear Axle Left & Right Upper Outer	SUV 4WD 2AZFE		Control Arm Bushing	516512
	2005.11-2013.06	Rear Axle Left & Right Upper Inner	SUV 4WD 2AZFE		Control Arm Bushing Kit	516223S
	2005.11-2013.06	Front Axle Left	SUV 4WD 2AZFE		Tie Rod End	S070490
	2005.11-2013.06	Front Axle Right	SUV 4WD 2AZFE		Tie Rod End	S070491
	2005.11-2013.06	Front Axle Left & Right	SUV 4WD 2AZFE		Tie Rod End	S070866
	2005.11-2013.06	Front Axle Left & Right	SUV 4WD 2AZFE		Rod/Strut,stabiliser	S050440
	2005.11-2013.12	Front Axle Left Lower	SUV FWD 2AZFE		Track Control Arm	S060917
	2005.11-2013.12	Front Axle Right Lower	SUV FWD 2AZFE		Track Control Arm	S060918
	2005.11-2013.12	Rear Axle Left & Right Lower Inner	SUV FWD 2AZFE		Track Control Arm	S063196
	2005.11-2013.12	Front Axle Left & Right Lower	SUV FWD 2AZFE		Ball Joint	S080244
	2005.11-2013.12	Front Axle Left & Right Lower	SUV FWD 2AZFE		Control Arm Bushing	513219
	2005.11-2013.12	Front Axle Left & Right Lower	SUV FWD 2AZFE		Control Arm Bushing	516217
	2005.11-2013.12	Front Axle Left & Right Lower	SUV FWD 2AZFE		Control Arm Bushing	517364
	2005.11-2013.12	Rear Axle Left & Right Upper Inner	SUV FWD 2AZFE		Control Arm Bushing	516214
	2005.11-2013.12	Rear Axle Left & Right Upper Inner	SUV FWD 2AZFE		Control Arm Bushing	516223
	2005.11-2013.12	Rear Axle Left & Right Lower Outer	SUV FWD 2AZFE		Control Arm Bushing	516229
	2005.11-2013.12	Rear Axle Left & Right Upper Outer	SUV FWD 2AZFE		Control Arm Bushing	516512
	2005.11-2013.12	Rear Axle Left & Right Upper Inner	SUV FWD 2AZFE		Control Arm Bushing Kit	516223S
	2005.11-2013.12	Front Axle Left	SUV FWD 2AZFE		Tie Rod End	S070490
	2005.11-2013.12	Front Axle Right	SUV FWD 2AZFE		Tie Rod End	S070491
	2005.11-2013.12	Front Axle Left & Right	SUV FWD 2AZFE		Tie Rod End	S070840
	2005.11-2013.12	Front Axle Left & Right	SUV FWD 2AZFE		Rod/Strut,stabiliser	S050440
	2005.11-2013.12	Rear Axle Left & Right	SUV FWD 2AZFE		Rod/Strut,stabiliser	S050441
	2005.11-2013.12	Front Axle Left	SUV FWD 2AZFE		Stabiliser Bushing	516811
	2005.11-2013.12	Front Axle Right	SUV FWD 2AZFE		Stabiliser Bushing	517786
	2005.11-2013.12	Front Axle Left & Right	SUV FWD 2AZFE		Stabiliser Bushing	532767
	2005.11-2013.12	Front Axle	SUV FWD 2AZFE		Stabiliser Bushing	513150
	2005.11-2013.12	Front Axle	SUV FWD 2AZFE		Stabiliser Bushing	513152
	2005.11-2013.12	Rear Axle	SUV FWD 2AZFE		Stabiliser Bushing	517794
2.5 (132 kw)	2012.12-	Front Axle Left Lower	SUV 4WD 2ARFE		Track Control Arm	S060917
	2012.12-	Front Axle Right Lower	SUV 4WD 2ARFE		Track Control Arm	S060918
	2012.12-	Rear Axle Left Upper Outer	SUV 4WD 2ARFE		Track Control Arm	S062580
	2012.12-	Rear Axle Right Upper Outer	SUV 4WD 2ARFE		Track Control Arm	S062579
	2012.12-	Rear Axle Left & Right Lower Inner	SUV 4WD 2ARFE		Track Control Arm	S063196
	2012.12-	Front Axle Left & Right Lower	SUV 4WD 2ARFE		Ball Joint	S080244
	2012.12-	Front Axle Left & Right Lower	SUV 4WD 2ARFE		Control Arm Bushing	516217
	2012.12-	Rear Axle Left & Right Upper Inner	SUV 4WD 2ARFE		Control Arm Bushing	516223
	2012.12-	Rear Axle Left & Right Lower Outer	SUV 4WD 2ARFE		Control Arm Bushing	516229
	2012.12-	Rear Axle Left & Right Upper Outer	SUV 4WD 2ARFE		Control Arm Bushing	516512
	2012.12-	Front Axle	SUV 4WD 2ARFE		Pitman Arm	S010037
	2012.12-	Front Axle Left	SUV 4WD 2ARFE		Tie Rod End	S070490
	2012.12-	Front Axle Right	SUV 4WD 2ARFE		Tie Rod End	S070491
	2012.12-	Front Axle Left & Right	SUV 4WD 2ARFE		Rod/Strut,stabiliser	S050440
	2012.12-	Rear Axle Left & Right	SUV 4WD 2ARFE		Rod/Strut,stabiliser	S050441
	2012.12-	Front Axle Left	SUV 4WD 2ARFE		Stabiliser Bushing	516811
	2012.12-	Front Axle Right	SUV 4WD 2ARFE		Stabiliser Bushing	517786
	2012.12-	Rear Axle	SUV 4WD 2ARFE		Stabiliser Bushing	535010
VOLVO						
460						
2.0 (80 kw)	1993.08-1997.08	Front Axle Left & Right Lower	Saloon FWD B20F		Ball Joint	S080269
	1993.08-1997.08	Front Axle Left & Right Lower	Saloon FWD B20F		Control Arm Bushing	530253
	1993.08-1997.08	Front Axle Left	Saloon FWD B20F		Rod/Strut,stabiliser	S050462
	1993.08-1997.08	Front Axle Right	Saloon FWD B20F		Rod/Strut,stabiliser	S050463
850						
2.3 (166 kw)	1993.09-1996.10	Front Axle Left Lower Outer	Saloon FWD B5234FT		Track Control Arm	S060772
	1993.09-1996.10	Front Axle Right Lower Outer	Saloon FWD B5234FT		Track Control Arm	S060771
	1993.09-1996.10	Front Axle Left & Right Lower	Saloon FWD B5234FT		Ball Joint	S080270
	1993.09-1996.10	Rear Axle Right Lower	Saloon FWD B5234FT		Control Arm Bushing	530256
	1993.09-1996.10	Rear Axle Left & Right Lower	Saloon FWD B5234FT		Control Arm Bushing	530257
	1993.09-1996.10	Rear Axle Left Lower	Saloon FWD B5234FT		Control Arm Bushing Kit	530255S
	1993.09-1996.10	Rear Axle Right	Saloon FWD B5234FT		Control Arm Bushing Kit	530256S
	1993.09-1996.10	Front Axle Left & Right	Saloon FWD B5234FT	Suspension code:5	Tie Rod Axle Joint	S030324
	1993.09-1996.10	Front Axle Left & Right	Saloon FWD B5234FT		Tie Rod Axle Joint	S030330



	 YEAR	FITTING POSITION	BODY STYLE & DRIVE TYPE & ENGINE	REMARKS	PRODUCT	GSP Ref.
VOLVO						
850						
2.3 (166 kw)	1993.09-1996.10	Front Axle Left	Saloon FWD B5234FT		Tie Rod End	S070526
	1993.09-1996.10	Front Axle Right	Saloon FWD B5234FT		Tie Rod End	S070525
	1993.09-1996.10	Front Axle Left & Right	Saloon FWD B5234FT		Rod/Strut,stabiliser	S100157
	1993.09-1996.10	Front Axle	Saloon FWD B5234FT		Steering Boot	540197
850 Estate/Combi						
2.4 (103 kw)	1992.08-1997.10	Front Axle Left Lower Outer	Estate FWD B5252FS		Track Control Arm	S060772
	1992.08-1997.10	Front Axle Right Lower Outer	Estate FWD B5252FS		Track Control Arm	S060771
	1992.08-1997.10	Front Axle Left & Right Lower	Estate FWD B5252FS		Ball Joint	S080270
	1992.08-1997.10	Rear Axle Left & Right Lower	Estate FWD B5252FS		Control Arm Bushing	530257
	1992.08-1997.10	Front Axle Left & Right	Estate FWD B5252FS		Tie Rod Axle Joint	S030330
	1992.08-1997.10	Front Axle Left	Estate FWD B5252FS		Tie Rod End	S070526
	1992.08-1997.10	Front Axle Right	Estate FWD B5252FS		Tie Rod End	S070525
	1992.08-1997.10	Front Axle Left & Right	Estate FWD B5252FS		Rod/Strut,stabiliser	S100157
	1992.08-1997.10	Front Axle	Estate FWD B5252FS		Steering Boot	540197
960						
2.9 (150 kw)	1990.09-1996.12	Front Axle Left Lower	Saloon RWD B6304FS/B6304GS		Track Control Arm	S060770
	1990.09-1996.12	Front Axle Right Lower	Saloon RWD B6304FS/B6304GS		Track Control Arm	S060769
	1990.09-1996.12	Front Axle Left & Right Lower	Saloon RWD B6304FS/B6304GS		Ball Joint	S080264
	1990.09-1996.12	Front Axle Left & Right Lower	Saloon RWD B6304FS/B6304GS	Engine code:B 6304 FS,Engine code B 6304 F,Date from:1994.01	Ball Joint	S080264
	1990.09-1996.12	Front Axle Left & Right Lower	Saloon RWD B6304FS/B6304GS		Control Arm Bushing	512190
	1990.09-1996.12	Front Axle Left & Right Lower	Saloon RWD B6304FS/B6304GS		Control Arm Bushing	519279
	1990.09-1996.12	Front Axle Left & Right Lower	Saloon RWD B6304FS/B6304GS		Control Arm Bushing	519558
	1990.09-1996.12	Front Axle Left & Right Lower	Saloon RWD B6304FS/B6304GS		Control Arm Bushing	530254
	1990.09-1996.12	Front Axle Left & Right	Saloon RWD B6304FS/B6304GS	Engine code:B 6304 F,Date to:1993.12	Tie Rod Axle Joint	S030327
	1990.09-1996.12	Front Axle Left & Right	Saloon RWD B6304FS/B6304GS		Tie Rod Axle Joint	S030327
	1990.09-1996.12	Front Axle Left & Right	Saloon RWD B6304FS/B6304GS		Tie Rod Axle Joint	S030328
	1990.09-1996.12	Front Axle Left & Right	Saloon RWD B6304FS/B6304GS		Tie Rod Axle Joint	S030329
	1990.09-1996.12	Front Axle Left	Saloon RWD B6304FS/B6304GS	Engine code:B 6304 FS for Left-Hand Drive Vehicles,Date from:1995	Tie Rod End	S070526
	1990.09-1996.12	Front Axle Left	Saloon RWD B6304FS/B6304GS	for Left-Hand Drive Vehicles,Date from:1995	Tie Rod End	S070526
	1990.09-1996.12	Front Axle Right	Saloon RWD B6304FS/B6304GS	Engine code:B 6304 FS for Left-Hand Drive Vehicles,Date from:1995	Tie Rod End	S070525
	1990.09-1996.12	Front Axle Right	Saloon RWD B6304FS/B6304GS	for Left-Hand Drive Vehicles,Date from:1995	Tie Rod End	S070525
	1990.09-1996.12	Front Axle Left & Right	Saloon RWD B6304FS/B6304GS		Tie Rod End	S070522
	1990.09-1996.12	Front Axle Left & Right	Saloon RWD B6304FS/B6304GS		Tie Rod End	S070866
	1990.09-1996.12	Front Axle Left & Right	Saloon RWD B6304FS/B6304GS		Rod/Strut,stabiliser	S050452
	1990.09-1996.12	Front Axle Left & Right	Saloon RWD B6304FS/B6304GS	Date from:1995.01	Rod/Strut,stabiliser	S050452
	1990.09-1996.12	Front Axle Left & Right	Saloon RWD B6304FS/B6304GS		Rod/Strut,stabiliser	S050454
	1990.09-1996.12	Front Axle Left & Right	Saloon RWD B6304FS/B6304GS	Date to:1994.12	Rod/Strut,stabiliser	S050454
	1990.09-1996.12	Front Axle	Saloon RWD B6304FS/B6304GS		Stabiliser Bushing	530193
	1990.09-1996.12	Front Axle	Saloon RWD B6304FS/B6304GS		Stabiliser Bushing	530201
	1990.09-1996.12	Front Axle	Saloon RWD B6304FS/B6304GS		Stabiliser Bushing	530258
	1990.09-1996.12	Front Axle	Saloon RWD B6304FS/B6304GS		Steering Boot	540192
	1990.09-1996.12	Front Axle	Saloon RWD B6304FS/B6304GS		Steering Boot	540193
C30						
2.0 (107 kw)	2006.10-2013.08	Front Axle Left Lower	Hatchback FWD B4204S3	Chassis no.to:260,for vehicles with standard suspension	Track Control Arm	S060478
	2006.10-2013.08	Front Axle Left Lower	Hatchback FWD B4204S3	Chassis no.from:261,for vehicles with standard suspension	Track Control Arm	S060921
	2006.10-2013.08	Front Axle Right Lower	Hatchback FWD B4204S3	Chassis no.to:260,for vehicles with standard suspension	Track Control Arm	S060479
	2006.10-2013.08	Front Axle Right Lower	Hatchback FWD B4204S3	Chassis no.from:261,for vehicles with standard suspension	Track Control Arm	S060922
	2006.10-2013.08	Rear Axle Left & Right Upper	Hatchback FWD B4204S3		Track Control Arm	S060182
	2006.10-2013.08	Rear Axle Left & Right Lower Inner	Hatchback FWD B4204S3		Track Control Arm	S060183
	2006.10-2013.08	Front Axle Left & Right Lower	Hatchback FWD B4204S3	Chassis no.to:260,for vehicles with standard suspension	Ball Joint	S080069
	2006.10-2013.08	Front Axle Left & Right Lower	Hatchback FWD B4204S3	Chassis no.from:261,for vehicles with standard suspension	Ball Joint	S080070
	2006.10-2013.08	Front Axle Left & Right Lower	Hatchback FWD B4204S3	Date from-to:2007-2011	Control Arm Bushing	514447
	2006.10-2013.08	Front Axle Left & Right Lower	Hatchback FWD B4204S3		Control Arm Bushing	516436
	2006.10-2013.08	Front Axle Left & Right Lower	Hatchback FWD B4204S3	Date from-to:2007-2011	Control Arm Bushing	516567
	2006.10-2013.08	Front Axle Left & Right Lower	Hatchback FWD B4204S3		Control Arm Bushing	517914
	2006.10-2013.08	Rear Axle Left & Right Upper	Hatchback FWD B4204S3	Date from-to:2007-2011	Control Arm Bushing	514889
	2006.10-2013.08	Rear Axle Left & Right Upper	Hatchback FWD B4204S3		Control Arm Bushing	514889
	2006.10-2013.08	Rear Axle Left & Right Lower Inner	Hatchback FWD B4204S3		Control Arm Bushing	514904
	2006.10-2013.08	Rear Axle Left & Right Lower Outer	Hatchback FWD B4204S3	Date from-to:2007-2011	Control Arm Bushing	514949
	2006.10-2013.08	Rear Axle Left & Right Lower Outer	Hatchback FWD B4204S3	Date from-to:2007-2011	Control Arm Bushing	514957
	2006.10-2013.08	Front Axle Left & Right	Hatchback FWD B4204S3		Tie Rod Axle Joint	S030083
	2006.10-2013.08	Front Axle Left	Hatchback FWD B4204S3		Tie Rod End	S070157
	2006.10-2013.08	Front Axle Right	Hatchback FWD B4204S3		Tie Rod End	S070158
	2006.10-2013.08	Front Axle Left & Right	Hatchback FWD B4204S3		Rod/Strut,stabiliser	S050146



	 YEAR	FITTING POSITION	BODY STYLE & DRIVE TYPE & ENGINE	REMARKS	PRODUCT	GSP Ref.
VOLVO						
C30						
2.0 (107 kw)	2006.10-2013.08	Rear Axle Left & Right	Hatchback FWD B4204S3		Rod/Strut, stabiliser	520378
	2006.10-2013.08	Front Axle	Hatchback FWD B4204S3		Stabiliser Bushing	514031
	2006.10-2013.08	Rear Axle	Hatchback FWD B4204S3		Stabiliser Bushing	514033
	2006.10-2013.08	Front Axle	Hatchback FWD B4204S3		Steering Boot	540286
	2006.10-2013.08	Front Axle	Hatchback FWD B4204S3		Steering Rack Bellow Kit	540286S
2.4 (125 kw)	2006.10-2010.12	Front Axle Left Lower	Hatchback FWD B5244S4	Chassis no.to:260,for vehicles with standard suspension	Track Control Arm	S060478
	2006.10-2010.12	Front Axle Left Lower	Hatchback FWD B5244S4	Chassis no.from:261,for vehicles with standard suspension	Track Control Arm	S060921
	2006.10-2010.12	Front Axle Right Lower	Hatchback FWD B5244S4	Chassis no.to:260,for vehicles with standard suspension	Track Control Arm	S060479
	2006.10-2010.12	Front Axle Right Lower	Hatchback FWD B5244S4	Chassis no.from:261,for vehicles with standard suspension	Track Control Arm	S060922
	2006.10-2010.12	Rear Axle Left & Right Upper	Hatchback FWD B5244S4		Track Control Arm	S060182
	2006.10-2010.12	Rear Axle Left & Right Lower Inner	Hatchback FWD B5244S4		Track Control Arm	S060183
	2006.10-2010.12	Front Axle Left & Right Lower	Hatchback FWD B5244S4	Chassis no.to:260,for vehicles with standard suspension	Ball Joint	S080069
	2006.10-2010.12	Front Axle Left & Right Lower	Hatchback FWD B5244S4	Chassis no.from:261,for vehicles with standard suspension	Ball Joint	S080070
	2006.10-2010.12	Front Axle Left & Right Lower	Hatchback FWD B5244S4	Date from-to:2007-2011	Control Arm Bushing	514447
	2006.10-2010.12	Front Axle Left & Right Lower	Hatchback FWD B5244S4		Control Arm Bushing	516436
	2006.10-2010.12	Front Axle Left & Right Lower	Hatchback FWD B5244S4	Date from-to:2007-2011	Control Arm Bushing	516567
	2006.10-2010.12	Front Axle Left & Right Lower	Hatchback FWD B5244S4		Control Arm Bushing	517914
	2006.10-2010.12	Rear Axle Left & Right Upper	Hatchback FWD B5244S4		Control Arm Bushing	514889
	2006.10-2010.12	Rear Axle Left & Right Lower Inner	Hatchback FWD B5244S4		Control Arm Bushing	514904
	2006.10-2010.12	Rear Axle Left & Right Lower Outer	Hatchback FWD B5244S4	Date from-to:2007-2011	Control Arm Bushing	514949
	2006.10-2010.12	Rear Axle Left & Right Lower Outer	Hatchback FWD B5244S4	Date from-to:2007-2011	Control Arm Bushing	514957
	2006.10-2010.12	Front Axle Left & Right	Hatchback FWD B5244S4		Tie Rod Axle Joint	S030083
	2006.10-2010.12	Front Axle Left	Hatchback FWD B5244S4		Tie Rod End	S070157
	2006.10-2010.12	Front Axle Right	Hatchback FWD B5244S4		Tie Rod End	S070158
	2006.10-2010.12	Front Axle Left & Right	Hatchback FWD B5244S4		Rod/Strut, stabiliser	S050146
	2006.10-2010.12	Rear Axle Left & Right	Hatchback FWD B5244S4		Rod/Strut, stabiliser	520378
	2006.10-2010.12	Front Axle	Hatchback FWD B5244S4		Stabiliser Bushing	514025
	2006.10-2010.12	Rear Axle	Hatchback FWD B5244S4		Stabiliser Bushing	514033
	2006.10-2010.12	Front Axle	Hatchback FWD B5244S4		Steering Boot	540286
	2006.10-2010.12	Front Axle	Hatchback FWD B5244S4		Steering Rack Bellow Kit	540286S
2.5 (169 kw)	2007.06-2013.08	Front Axle Left Lower	Hatchback FWD B5254T7	Chassis no.to:260,for vehicles with standard suspension	Track Control Arm	S060478
	2007.06-2013.08	Front Axle Left Lower	Hatchback FWD B5254T7	Chassis no.from:261,for vehicles with standard suspension	Track Control Arm	S060921
	2007.06-2013.08	Front Axle Right Lower	Hatchback FWD B5254T7	Chassis no.to:260,for vehicles with standard suspension	Track Control Arm	S060479
	2007.06-2013.08	Front Axle Right Lower	Hatchback FWD B5254T7	Chassis no.from:261,for vehicles with standard suspension	Track Control Arm	S060922
	2007.06-2013.08	Rear Axle Left & Right Upper	Hatchback FWD B5254T7		Track Control Arm	S060182
	2007.06-2013.08	Rear Axle Left & Right Lower Inner	Hatchback FWD B5254T7		Track Control Arm	S060183
	2007.06-2013.08	Front Axle Left & Right Lower	Hatchback FWD B5254T7	Chassis no.to:260,for vehicles with standard suspension	Ball Joint	S080069
	2007.06-2013.08	Front Axle Left & Right Lower	Hatchback FWD B5254T7	Chassis no.from:261,for vehicles with standard suspension	Ball Joint	S080070
	2007.06-2013.08	Front Axle Left & Right Lower	Hatchback FWD B5254T7	Date to:2011	Control Arm Bushing	514447
	2007.06-2013.08	Front Axle Left & Right Lower	Hatchback FWD B5254T7		Control Arm Bushing	516436
	2007.06-2013.08	Front Axle Left & Right Lower	Hatchback FWD B5254T7	Date to:2011	Control Arm Bushing	516567
	2007.06-2013.08	Front Axle Left & Right Lower	Hatchback FWD B5254T7		Control Arm Bushing	517914
	2007.06-2013.08	Rear Axle Left & Right Upper	Hatchback FWD B5254T7		Control Arm Bushing	514889
	2007.06-2013.08	Rear Axle Left & Right Lower Inner	Hatchback FWD B5254T7		Control Arm Bushing	514904
	2007.06-2013.08	Rear Axle Left & Right Lower Outer	Hatchback FWD B5254T7	Date to:2011	Control Arm Bushing	514949
	2007.06-2013.08	Rear Axle Left & Right Lower Outer	Hatchback FWD B5254T7	Date to:2011	Control Arm Bushing	514957
	2007.06-2013.08	Front Axle Left & Right	Hatchback FWD B5254T7		Tie Rod Axle Joint	S030083
	2007.06-2013.08	Front Axle Left	Hatchback FWD B5254T7		Tie Rod End	S070157
	2007.06-2013.08	Front Axle Right	Hatchback FWD B5254T7		Tie Rod End	S070158
	2007.06-2013.08	Front Axle Left & Right	Hatchback FWD B5254T7		Rod/Strut, stabiliser	S050146
	2007.06-2013.08	Rear Axle Left & Right	Hatchback FWD B5254T7		Rod/Strut, stabiliser	520378
	2007.06-2013.08	Rear Axle Left & Right	Hatchback FWD B5254T7	for vehicles with sports suspension	Rod/Strut, stabiliser	S050145
	2007.06-2013.08	Front Axle	Hatchback FWD B5254T7		Stabiliser Bushing	514025
	2007.06-2013.08	Rear Axle	Hatchback FWD B5254T7		Stabiliser Bushing	514033
	2007.06-2013.08	Front Axle	Hatchback FWD B5254T7		Steering Boot	540286
	2007.06-2013.08	Front Axle	Hatchback FWD B5254T7		Steering Rack Bellow Kit	540286S
C70						
2.5 (169 kw)	2007.03-2013.06	Front Axle Left Lower	Cabriolet FWD B5254T3/B5254T7	Chassis no. to:002742	Track Control Arm	S060478
	2007.03-2013.06	Front Axle Left Lower	Cabriolet FWD B5254T3/B5254T7	Chassis no.from:2743	Track Control Arm	S060921
	2007.03-2013.06	Front Axle Right Lower	Cabriolet FWD B5254T3/B5254T7	Chassis no. to:002742	Track Control Arm	S060479
	2007.03-2013.06	Front Axle Right Lower	Cabriolet FWD B5254T3/B5254T7	Chassis no.from:2743	Track Control Arm	S060922
	2007.03-2013.06	Rear Axle Left & Right Lower Inner	Cabriolet FWD B5254T3/B5254T7		Track Control Arm	S060183
	2007.03-2013.06	Front Axle Left & Right Lower	Cabriolet FWD B5254T3/B5254T7	Chassis no.to:2742	Ball Joint	S080069
	2007.03-2013.06	Front Axle Left & Right Lower	Cabriolet FWD B5254T3/B5254T7	Chassis no.from:002743	Ball Joint	S080070



	 YEAR	FITTING POSITION	BODY STYLE & DRIVE TYPE & ENGINE	REMARKS	PRODUCT	GSP Ref.
VOLVO C70						
2.5 (169 kw)	2007.03-2013.06	Front Axle Left & Right Lower	Cabriolet FWD B5254T3/B5254T7		Control Arm Bushing	516436
	2007.03-2013.06	Rear Axle Left & Right Upper	Cabriolet FWD B5254T3/B5254T7		Control Arm Bushing	514889
	2007.03-2013.06	Rear Axle Left & Right Lower Inner	Cabriolet FWD B5254T3/B5254T7		Control Arm Bushing	514904
	2007.03-2013.06	Front Axle Left & Right	Cabriolet FWD B5254T3/B5254T7		Tie Rod Axle Joint	S030083
	2007.03-2013.06	Front Axle Left	Cabriolet FWD B5254T3/B5254T7		Tie Rod End	S070157
	2007.03-2013.06	Front Axle Right	Cabriolet FWD B5254T3/B5254T7		Tie Rod End	S070158
	2007.03-2013.06	Front Axle Left & Right	Cabriolet FWD B5254T3/B5254T7		Rod/Strut,stabiliser	S050146
	2007.03-2013.06	Rear Axle Left & Right	Cabriolet FWD B5254T3/B5254T7		Rod/Strut,stabiliser	S050145
	2007.03-2013.06	Front Axle	Cabriolet FWD B5254T3/B5254T7		Stabiliser Bushing	514025
	2007.03-2013.06	Front Axle	Cabriolet FWD B5254T3/B5254T7		Steering Boot	540286
	2007.03-2013.06	Front Axle	Cabriolet FWD B5254T3/B5254T7		Steering Rack Bellow Kit	540286S
S40						
1.8 (85 kw)	1995.07-1999.08	Front Axle Left Lower	Saloon FWD B4184S/B4184S3		Track Control Arm	S060621
	1995.07-1999.08	Front Axle Right Lower	Saloon FWD B4184S/B4184S3		Track Control Arm	S060622
	1995.07-1999.08	Rear Axle Left & Right Upper	Saloon FWD B4184S/B4184S3		Track Control Arm	S062207
	1995.07-1999.08	Front Axle Left Lower	Saloon FWD B4184S/B4184S3		Control Arm Bushing	511844
	1995.07-1999.08	Front Axle Right Lower	Saloon FWD B4184S/B4184S3		Control Arm Bushing	516607
	1995.07-1999.08	Front Axle Left & Right Lower	Saloon FWD B4184S/B4184S3		Control Arm Bushing	516080
	1995.07-1999.08	Rear Axle Left & Right Centre	Saloon FWD B4184S/B4184S3		Control Arm Bushing	532161
	1995.07-1999.08	Rear Axle Left & Right Lower	Saloon FWD B4184S/B4184S3		Control Arm Bushing	530259
	1995.07-1999.08	Front Axle Left & Right	Saloon FWD B4184S/B4184S3		Tie Rod End	S070321
	1995.07-1999.08	Front Axle Left & Right	Saloon FWD B4184S/B4184S3		Tie Rod End	S070695
	1995.07-1999.08	Front Axle Left & Right	Saloon FWD B4184S/B4184S3	Engine code:B 4184 S3.Date from:2000	Rod/Strut,stabiliser	S050099
	1995.07-1999.08	Front Axle Left & Right	Saloon FWD B4184S/B4184S3		Rod/Strut,stabiliser	S050336
	1995.07-1999.08	Rear Axle Left & Right	Saloon FWD B4184S/B4184S3		Rod/Strut,stabiliser	S051198
	1995.07-1999.08	Front Axle	Saloon FWD B4184S/B4184S3		Steering Rack Bellow Kit	540196S
	1995.07-1999.08	Front Axle	Saloon FWD B4184S/B4184S3		Stabiliser Bushing Kit	513354S
	1995.07-1999.08	Front Axle	Saloon FWD B4184S/B4184S3		Stabiliser Bushing Kit	513768S
1.8 (90 kw)	2000.10-2004.08	Rear Axle Left & Right Upper	Saloon FWD B4184SJ		Track Control Arm	S062207
	2000.10-2004.08	Front Axle Left Lower	Saloon FWD B4184SJ		Control Arm Bushing	511844
	2000.10-2004.08	Front Axle Right Lower	Saloon FWD B4184SJ		Control Arm Bushing	516607
	2000.10-2004.08	Front Axle Left & Right Lower	Saloon FWD B4184SJ		Control Arm Bushing	516080
	2000.10-2004.08	Rear Axle Left & Right Centre	Saloon FWD B4184SJ		Control Arm Bushing	532161
	2000.10-2004.08	Rear Axle Left & Right Lower	Saloon FWD B4184SJ		Control Arm Bushing	530259
	2000.10-2004.08	Front Axle Left & Right	Saloon FWD B4184SJ		Tie Rod Axle Joint	S031005
	2000.10-2004.08	Front Axle Left	Saloon FWD B4184SJ		Tie Rod End	S070518
	2000.10-2004.08	Front Axle Right	Saloon FWD B4184SJ		Tie Rod End	S070519
	2000.10-2004.08	Front Axle Left & Right	Saloon FWD B4184SJ		Tie Rod End	S070321
	2000.10-2004.08	Front Axle Left & Right	Saloon FWD B4184SJ		Tie Rod End	S070695
	2000.10-2004.08	Front Axle Left & Right	Saloon FWD B4184SJ	Date from:2000	Rod/Strut,stabiliser	S050099
	2000.10-2004.08	Front Axle Left & Right	Saloon FWD B4184SJ		Rod/Strut,stabiliser	S050336
	2000.10-2004.08	Rear Axle Left & Right	Saloon FWD B4184SJ		Rod/Strut,stabiliser	S051198
	2000.10-2004.08	Front Axle	Saloon FWD B4184SJ		Steering Rack Bellow Kit	540196S
	2000.10-2004.08	Front Axle	Saloon FWD B4184SJ		Stabiliser Bushing Kit	513354S
	2000.10-2004.08	Front Axle	Saloon FWD B4184SJ		Stabiliser Bushing Kit	513768S
1.8 (92 kw)	2004.03-2010.09	Front Axle Left Lower	Saloon FWD B4184S11	Chassis no. to:B197552,2209290	Track Control Arm	S060478
	2004.03-2010.09	Front Axle Left Lower	Saloon FWD B4184S11	Chassis no.fromB197553,2209291	Track Control Arm	S060921
	2004.03-2010.09	Front Axle Right Lower	Saloon FWD B4184S11	Chassis no. to:B197552,2209290	Track Control Arm	S060479
	2004.03-2010.09	Front Axle Right Lower	Saloon FWD B4184S11	Chassis no.from:B197553,2209291	Track Control Arm	S060922
	2004.03-2010.09	Rear Axle Left & Right Upper	Saloon FWD B4184S11		Track Control Arm	S060182
	2004.03-2010.09	Rear Axle Left & Right Lower Inner	Saloon FWD B4184S11		Track Control Arm	S060183
	2004.03-2010.09	Rear Axle Left & Right Lower Outer	Saloon FWD B4184S11		Track Control Arm	S061286
	2004.03-2010.09	Front Axle Left & Right Lower	Saloon FWD B4184S11	Chassis no.to:B197552,2209290	Ball Joint	S080069
	2004.03-2010.09	Front Axle Left & Right Lower	Saloon FWD B4184S11	Chassis no.from:B197553,2209291	Ball Joint	S080070
	2004.03-2010.09	Front Axle Left & Right Lower	Saloon FWD B4184S11		Control Arm Bushing	516436
	2004.03-2010.09	Front Axle Left & Right Lower	Saloon FWD B4184S11		Control Arm Bushing	517914
	2004.03-2010.09	Rear Axle Left & Right Upper	Saloon FWD B4184S11		Control Arm Bushing	514889
	2004.03-2010.09	Rear Axle Left & Right Lower Inner	Saloon FWD B4184S11		Control Arm Bushing	514904
	2004.03-2010.09	Front Axle Left & Right	Saloon FWD B4184S11		Tie Rod Axle Joint	S030083
	2004.03-2010.09	Front Axle Left	Saloon FWD B4184S11		Tie Rod End	S070157
	2004.03-2010.09	Front Axle Right	Saloon FWD B4184S11		Tie Rod End	S070158
	2004.03-2010.09	Front Axle Left & Right	Saloon FWD B4184S11		Rod/Strut,stabiliser	S050146
	2004.03-2010.09	Rear Axle Left & Right	Saloon FWD B4184S11		Rod/Strut,stabiliser	520378
	2004.03-2010.09	Rear Axle Left & Right	Saloon FWD B4184S11		Rod/Strut,stabiliser	S050145



	 YEAR	FITTING POSITION	BODY STYLE & DRIVE TYPE & ENGINE	REMARKS	PRODUCT	GSP Ref.
VOLVO S40						
1.8 (92 kw)	2004.03-2010.09	Front Axle	Saloon FWD B4184S11		Stabiliser Bushing	514025
	2004.03-2010.09	Rear Axle	Saloon FWD B4184S11		Stabiliser Bushing	514033
	2004.03-2010.09	Front Axle	Saloon FWD B4184S11		Steering Boot	540286
	2004.03-2010.09	Front Axle	Saloon FWD B4184S11		Steering Rack Bellow Kit	540286S
1.9 (147 kw)	1997.10-2000.12	Front Axle Left Lower	Saloon FWD B4194T/B4194T2		Track Control Arm	S060621
	1997.10-2000.12	Front Axle Right Lower	Saloon FWD B4194T/B4194T2		Track Control Arm	S060622
	1997.10-2000.12	Rear Axle Left & Right Upper	Saloon FWD B4194T/B4194T2		Track Control Arm	S062207
	1997.10-2000.12	Front Axle Left Lower	Saloon FWD B4194T/B4194T2		Control Arm Bushing	511844
	1997.10-2000.12	Front Axle Right Lower	Saloon FWD B4194T/B4194T2		Control Arm Bushing	516607
	1997.10-2000.12	Front Axle Left & Right Lower	Saloon FWD B4194T/B4194T2		Control Arm Bushing	516080
	1997.10-2000.12	Rear Axle Left & Right Centre	Saloon FWD B4194T/B4194T2		Control Arm Bushing	532161
	1997.10-2000.12	Rear Axle Left & Right Lower	Saloon FWD B4194T/B4194T2		Control Arm Bushing	530259
	1997.10-2000.12	Front Axle Left & Right	Saloon FWD B4194T/B4194T2		Tie Rod End	S070321
	1997.10-2000.12	Front Axle Left & Right	Saloon FWD B4194T/B4194T2		Tie Rod End	S070695
	1997.10-2000.12	Front Axle Left & Right	Saloon FWD B4194T/B4194T2	Date from:2000	Rod/Strut,stabiliser	S050099
	1997.10-2000.12	Front Axle Left & Right	Saloon FWD B4194T/B4194T2		Rod/Strut,stabiliser	S050336
	1997.10-2000.12	Rear Axle Left & Right	Saloon FWD B4194T/B4194T2		Rod/Strut,stabiliser	S051198
	1997.10-2000.12	Front Axle	Saloon FWD B4194T/B4194T2		Steering Rack Bellow Kit	540196S
	1997.10-2000.12	Front Axle	Saloon FWD B4194T/B4194T2		Stabiliser Bushing Kit	513354S
	1997.10-2000.12	Front Axle	Saloon FWD B4194T/B4194T2		Stabiliser Bushing Kit	513768S
2.4 (103 kw)	2003.12-2010.07	Front Axle Left Lower	Saloon FWD B5244S5	Chassis no. to:B197552,2209290	Track Control Arm	S060478
	2003.12-2010.07	Front Axle Left Lower	Saloon FWD B5244S5	Chassis no.fromB197553,2209291	Track Control Arm	S060921
	2003.12-2010.07	Front Axle Right Lower	Saloon FWD B5244S5	Chassis no. to:B197552,2209290	Track Control Arm	S060479
	2003.12-2010.07	Front Axle Right Lower	Saloon FWD B5244S5	Chassis no.from:B197553,2209291	Track Control Arm	S060922
	2003.12-2010.07	Rear Axle Left & Right Upper	Saloon FWD B5244S5		Track Control Arm	S060182
	2003.12-2010.07	Rear Axle Left & Right Lower Inner	Saloon FWD B5244S5		Track Control Arm	S060183
	2003.12-2010.07	Rear Axle Left & Right Lower Outer	Saloon FWD B5244S5		Track Control Arm	S061286
	2003.12-2010.07	Front Axle Left & Right Lower	Saloon FWD B5244S5	Chassis no.to:B197552,2209290	Ball Joint	S080069
	2003.12-2010.07	Front Axle Left & Right Lower	Saloon FWD B5244S5	Chassis no.from:B197553,2209291	Ball Joint	S080070
	2003.12-2010.07	Front Axle Left & Right Lower	Saloon FWD B5244S5		Control Arm Bushing	516436
	2003.12-2010.07	Front Axle Left & Right Lower	Saloon FWD B5244S5		Control Arm Bushing	517914
	2003.12-2010.07	Rear Axle Left & Right Upper	Saloon FWD B5244S5		Control Arm Bushing	514889
	2003.12-2010.07	Rear Axle Left & Right Lower Inner	Saloon FWD B5244S5		Control Arm Bushing	514904
	2003.12-2010.07	Front Axle Left & Right	Saloon FWD B5244S5		Tie Rod Axle Joint	S030083
	2003.12-2010.07	Front Axle Left	Saloon FWD B5244S5		Tie Rod End	S070157
	2003.12-2010.07	Front Axle Right	Saloon FWD B5244S5		Tie Rod End	S070158
	2003.12-2010.07	Front Axle Left & Right	Saloon FWD B5244S5		Rod/Strut,stabiliser	S050146
	2003.12-2010.07	Rear Axle Left & Right	Saloon FWD B5244S5		Rod/Strut,stabiliser	520378
	2003.12-2010.07	Rear Axle Left & Right	Saloon FWD B5244S5		Rod/Strut,stabiliser	S050145
	2003.12-2010.07	Front Axle	Saloon FWD B5244S5		Stabiliser Bushing	514025
	2003.12-2010.07	Rear Axle	Saloon FWD B5244S5		Stabiliser Bushing	514033
	2003.12-2010.07	Front Axle	Saloon FWD B5244S5		Steering Boot	540286
	2003.12-2010.07	Front Axle	Saloon FWD B5244S5		Steering Rack Bellow Kit	540286S
	2.5 (162 kw)	2004.04-2008.12	Front Axle Left Lower	Saloon 4WD B5254T3	Chassis no. to:B197552,2209290	Track Control Arm
2004.04-2008.12		Front Axle Left Lower	Saloon 4WD B5254T3	Chassis no.fromB197553,2209291	Track Control Arm	S060921
2004.04-2008.12		Front Axle Right Lower	Saloon 4WD B5254T3	Chassis no. to:B197552,2209290	Track Control Arm	S060479
2004.04-2008.12		Front Axle Right Lower	Saloon 4WD B5254T3	Chassis no.from:B197553,2209291	Track Control Arm	S060922
2004.04-2008.12		Rear Axle Left & Right Upper	Saloon 4WD B5254T3		Track Control Arm	S060182
2004.04-2008.12		Rear Axle Left & Right Lower Inner	Saloon 4WD B5254T3		Track Control Arm	S060183
2004.04-2008.12		Front Axle Left & Right Lower	Saloon 4WD B5254T3	Chassis no.to:B197552,2209290	Ball Joint	S080069
2004.04-2008.12		Front Axle Left & Right Lower	Saloon 4WD B5254T3	Chassis no.from:B197553,2209291	Ball Joint	S080070
2004.04-2008.12		Front Axle Left & Right Lower	Saloon 4WD B5254T3		Control Arm Bushing	516436
2004.04-2008.12		Front Axle Left & Right Lower	Saloon 4WD B5254T3		Control Arm Bushing	517914
2004.04-2008.12		Rear Axle Left & Right Upper	Saloon 4WD B5254T3		Control Arm Bushing	514889
2004.04-2008.12		Rear Axle Left & Right Lower Inner	Saloon 4WD B5254T3		Control Arm Bushing	514904
2004.04-2008.12		Front Axle Left & Right	Saloon 4WD B5254T3		Tie Rod Axle Joint	S030083
2004.04-2008.12		Front Axle Left	Saloon 4WD B5254T3		Tie Rod End	S070157
2004.04-2008.12		Front Axle Right	Saloon 4WD B5254T3		Tie Rod End	S070158
2004.04-2008.12		Front Axle Left & Right	Saloon 4WD B5254T3		Rod/Strut,stabiliser	S050146
2004.04-2008.12		Rear Axle Left & Right	Saloon 4WD B5254T3		Rod/Strut,stabiliser	520378
2004.04-2008.12		Rear Axle Left & Right	Saloon 4WD B5254T3		Rod/Strut,stabiliser	S050145
2004.04-2008.12		Front Axle	Saloon 4WD B5254T3		Stabiliser Bushing	514025
2004.04-2008.12		Rear Axle	Saloon 4WD B5254T3		Stabiliser Bushing	514033
2004.04-2008.12		Front Axle	Saloon 4WD B5254T3		Steering Boot	540286



	 YEAR	FITTING POSITION	BODY STYLE & DRIVE TYPE & ENGINE	REMARKS	PRODUCT	GSP Ref.
VOLVO						
S40						
2.5 (162 kw)	2004.04-2008.12	Front Axle	Saloon 4WD B5254T3		Steering Rack Bellow Kit	540286S
S60						
2.0 (132 kw)	2000.07-2010.03	Front Axle Left Lower	Saloon FWD B5204T5		Track Control Arm	S060767
	2000.07-2010.03	Front Axle Right Lower	Saloon FWD B5204T5		Track Control Arm	S060768
	2000.07-2010.03	Front Axle Left & Right Lower	Saloon FWD B5204T5	Chassis no.from:626502	Ball Joint	S080265
	2000.07-2010.03	Front Axle Left & Right Lower	Saloon FWD B5204T5	Chassis no.to:626501	Ball Joint	S080359
	2000.07-2010.03	Front Axle Left & Right Lower	Saloon FWD B5204T5		Control Arm Bushing	510796
	2000.07-2010.03	Front Axle Left & Right Lower	Saloon FWD B5204T5		Control Arm Bushing	510797
	2000.07-2010.03	Rear Axle Left & Right Lower	Saloon FWD B5204T5		Control Arm Bushing	530847
	2000.07-2010.03	Front Axle Left & Right	Saloon FWD B5204T5	Date from:2004.01	Tie Rod Axle Joint	S030315
	2000.07-2010.03	Front Axle Left & Right	Saloon FWD B5204T5	Date to:2003.12	Tie Rod Axle Joint	S030332
	2000.07-2010.03	Front Axle Left & Right	Saloon FWD B5204T5	Chassis no.to:7320 for vehicles with electric power steering	Tie Rod Axle Joint	S031010
	2000.07-2010.03	Front Axle Left	Saloon FWD B5204T5		Tie Rod End	S070516
	2000.07-2010.03	Front Axle Right	Saloon FWD B5204T5		Tie Rod End	S070517
	2000.07-2010.03	Front Axle Left & Right	Saloon FWD B5204T5		Rod/Strut, stabiliser	S050455
	2000.07-2010.03	Rear Axle Left & Right	Saloon FWD B5204T5		Rod/Strut, stabiliser	S050453
	2000.07-2010.03	Front Axle	Saloon FWD B5204T5		Steering Boot	540197
	2000.07-2010.03	Front Axle	Saloon FWD B5204T5		Steering Rack Bellow Kit	540197S
2.0 (140 kw)	2015.03-2018.05	Front Axle Left Lower	Saloon FWD B4204T19		Track Control Arm	S060472
	2015.03-2018.05	Front Axle Left Lower	Saloon FWD B4204T19	Chassis no.from:76000	Track Control Arm	S062046
	2015.03-2018.05	Front Axle Right Lower	Saloon FWD B4204T19		Track Control Arm	S060473
	2015.03-2018.05	Front Axle Right Lower	Saloon FWD B4204T19	Chassis no.from:76000	Track Control Arm	S062045
	2015.03-2018.05	Front Axle Left & Right Lower	Saloon FWD B4204T19		Ball Joint	S080860
	2015.03-2018.05	Front Axle Left Lower	Saloon FWD B4204T19		Control Arm Bushing	530560
	2015.03-2018.05	Front Axle Right Lower	Saloon FWD B4204T19		Control Arm Bushing	530559
	2015.03-2018.05	Front Axle Left & Right Lower	Saloon FWD B4204T19		Control Arm Bushing	516461
	2015.03-2018.05	Rear Axle Left & Right Centre	Saloon FWD B4204T19		Control Arm Bushing	530569
	2015.03-2018.05	Front Axle Left & Right	Saloon FWD B4204T19		Tie Rod Axle Joint	S030092
	2015.03-2018.05	Front Axle Left & Right	Saloon FWD B4204T19		Rod/Strut, stabiliser	S050017
	2015.03-2018.05	Rear Axle Left & Right	Saloon FWD B4204T19		Rod/Strut, stabiliser	S050151
	2015.03-2018.05	Rear Axle	Saloon FWD B4204T19		Stabiliser Bushing	530508
	2015.03-2018.05	Front Axle	Saloon FWD B4204T19		Steering Rack Bellow Kit	540481S
2.0 (177 kw)	2010.04-2015.12	Front Axle Left Lower	Saloon FWD B4204T7		Track Control Arm	S060472
	2010.04-2015.12	Front Axle Left Lower	Saloon FWD B4204T7	Chassis no.from:76000	Track Control Arm	S062046
	2010.04-2015.12	Front Axle Right Lower	Saloon FWD B4204T7		Track Control Arm	S060473
	2010.04-2015.12	Front Axle Right Lower	Saloon FWD B4204T7	Chassis no.from:76000	Track Control Arm	S062045
	2010.04-2015.12	Rear Axle Left & Right Lower Inner	Saloon FWD B4204T7		Track Control Arm	S061219
	2010.04-2015.12	Front Axle Left & Right Lower	Saloon FWD B4204T7		Ball Joint	S080860
	2010.04-2015.12	Front Axle Left Lower	Saloon FWD B4204T7		Control Arm Bushing	530560
	2010.04-2015.12	Front Axle Right Lower	Saloon FWD B4204T7		Control Arm Bushing	530559
	2010.04-2015.12	Front Axle Left & Right Lower	Saloon FWD B4204T7		Control Arm Bushing	516461
	2010.04-2015.12	Rear Axle Left Centre	Saloon FWD B4204T7		Control Arm Bushing	532625
	2010.04-2015.12	Rear Axle Right Centre	Saloon FWD B4204T7		Control Arm Bushing	532624
	2010.04-2015.12	Rear Axle Left & Right Centre	Saloon FWD B4204T7		Control Arm Bushing	530569
	2010.04-2015.12	Front Axle Left & Right	Saloon FWD B4204T7		Tie Rod Axle Joint	S030092
	2010.04-2015.12	Front Axle Left & Right	Saloon FWD B4204T7		Rod/Strut, stabiliser	S050017
	2010.04-2015.12	Rear Axle Left & Right	Saloon FWD B4204T7		Rod/Strut, stabiliser	S050151
	2010.04-2015.12	Front Axle	Saloon FWD B4204T7		Stabiliser Bushing	517797
	2010.04-2015.12	Rear Axle	Saloon FWD B4204T7		Stabiliser Bushing	530508
	2010.04-2015.12	Front Axle	Saloon FWD B4204T7	for vehicles without electric power steering for vehicles without dynamic steering	Steering Rack Bellow Kit	540481S
2.0 (180 kw)	2013.09-2018.12	Front Axle Left Lower	Saloon FWD B4204T11		Track Control Arm	S060472
	2013.09-2018.12	Front Axle Left Lower	Saloon FWD B4204T11	Chassis no.from:76000	Track Control Arm	S062046
	2013.09-2018.12	Front Axle Right Lower	Saloon FWD B4204T11		Track Control Arm	S060473
	2013.09-2018.12	Front Axle Right Lower	Saloon FWD B4204T11	Chassis no.from:76000	Track Control Arm	S062045
	2013.09-2018.12	Front Axle Left & Right Lower	Saloon FWD B4204T11		Ball Joint	S080860
	2013.09-2018.12	Front Axle Left Lower	Saloon FWD B4204T11		Control Arm Bushing	530560
	2013.09-2018.12	Front Axle Right Lower	Saloon FWD B4204T11		Control Arm Bushing	530559
	2013.09-2018.12	Front Axle Left & Right Lower	Saloon FWD B4204T11		Control Arm Bushing	516461
	2013.09-2018.12	Rear Axle Left Centre	Saloon FWD B4204T11		Control Arm Bushing	532625
	2013.09-2018.12	Rear Axle Right Centre	Saloon FWD B4204T11		Control Arm Bushing	532624
	2013.09-2018.12	Rear Axle Left & Right Centre	Saloon FWD B4204T11		Control Arm Bushing	530569
	2013.09-2018.12	Front Axle Left & Right	Saloon FWD B4204T11		Tie Rod Axle Joint	S030092
	2013.09-2018.12	Front Axle Left & Right	Saloon FWD B4204T11		Rod/Strut, stabiliser	S050017
	2013.09-2018.12	Rear Axle Left & Right	Saloon FWD B4204T11		Rod/Strut, stabiliser	S050151



	 YEAR	FITTING POSITION	BODY STYLE & DRIVE TYPE & ENGINE	REMARKS	PRODUCT	GSP Ref.	
VOLVO S60							
2.0 (180 kw)	2013.09-2018.12	Rear Axle	Saloon FWD B4204T11		Stabiliser Bushing	530508	
	2013.09-2018.12	Front Axle	Saloon FWD B4204T11		Steering Rack Bellow Kit	540481S	
2.5 (154 kw)	2002.06-2010.03	Front Axle Left Lower	Saloon 4WD B5254T2		Track Control Arm	S060767	
	2002.06-2010.03	Front Axle Right Lower	Saloon 4WD B5254T2		Track Control Arm	S060768	
	2002.06-2010.03	Front Axle Left & Right Lower	Saloon 4WD B5254T2	Chassis no.from:626502	Ball Joint	S080265	
	2002.06-2010.03	Front Axle Left & Right Lower	Saloon 4WD B5254T2	Chassis no.to:626501	Ball Joint	S080359	
	2002.06-2010.03	Front Axle Left & Right Lower	Saloon 4WD B5254T2		Control Arm Bushing	510796	
	2002.06-2010.03	Front Axle Left & Right Lower	Saloon 4WD B5254T2		Control Arm Bushing	510797	
	2002.06-2010.03	Rear Axle Left & Right Lower	Saloon 4WD B5254T2		Control Arm Bushing	530847	
	2002.06-2010.03	Front Axle Left & Right	Saloon 4WD B5254T2	Date to:2003.12	Tie Rod Axle Joint	S030332	
	2002.06-2010.03	Front Axle Left & Right	Saloon 4WD B5254T2	Chassis no.to:7320 for vehicles with electric power steering	Tie Rod Axle Joint	S031010	
	2002.06-2010.03	Front Axle Left	Saloon 4WD B5254T2		Tie Rod End	S070516	
	2002.06-2010.03	Front Axle Right	Saloon 4WD B5254T2		Tie Rod End	S070517	
	2002.06-2010.03	Front Axle Left & Right	Saloon 4WD B5254T2		Rod/Strut, stabiliser	S050455	
	2002.06-2010.03	Rear Axle Left & Right	Saloon 4WD B5254T2		Rod/Strut, stabiliser	S050453	
	2002.06-2010.03	Front Axle	Saloon 4WD B5254T2		Steering Boot	540197	
	2002.06-2010.03	Front Axle	Saloon 4WD B5254T2		Steering Rack Bellow Kit	540197S	
3.0 (224 kw)	2010.04-2016.12	Front Axle Left Lower	Saloon 4WD B6304T4		Track Control Arm	S060472	
	2010.04-2016.12	Front Axle Left Lower	Saloon 4WD B6304T4	Chassis no.from:76000	Track Control Arm	S062046	
	2010.04-2016.12	Front Axle Right Lower	Saloon 4WD B6304T4		Track Control Arm	S060473	
	2010.04-2016.12	Front Axle Right Lower	Saloon 4WD B6304T4	Chassis no.from:76000	Track Control Arm	S062045	
	2010.04-2016.12	Rear Axle Left & Right Lower Inner	Saloon 4WD B6304T4		Track Control Arm	S061219	
	2010.04-2016.12	Front Axle Left & Right Lower	Saloon 4WD B6304T4		Ball Joint	S080860	
	2010.04-2016.12	Front Axle Left Lower	Saloon 4WD B6304T4		Control Arm Bushing	530560	
	2010.04-2016.12	Front Axle Right Lower	Saloon 4WD B6304T4		Control Arm Bushing	530559	
	2010.04-2016.12	Front Axle Left & Right Lower	Saloon 4WD B6304T4		Control Arm Bushing	516461	
	2010.04-2016.12	Rear Axle Left Centre	Saloon 4WD B6304T4		Control Arm Bushing	532625	
	2010.04-2016.12	Rear Axle Right Centre	Saloon 4WD B6304T4		Control Arm Bushing	532624	
	2010.04-2016.12	Rear Axle Left & Right Centre	Saloon 4WD B6304T4		Control Arm Bushing	530569	
	2010.04-2016.12	Rear Axle Left & Right Upper	Saloon 4WD B6304T4		Control Arm Bushing	530553	
	2010.04-2016.12	Front Axle Left & Right	Saloon 4WD B6304T4		Tie Rod Axle Joint	S030092	
	2010.04-2016.12	Front Axle Left & Right	Saloon 4WD B6304T4		Rod/Strut, stabiliser	S050017	
	2010.04-2016.12	Rear Axle Left & Right	Saloon 4WD B6304T4		Rod/Strut, stabiliser	S050151	
	2010.04-2016.12	Front Axle	Saloon 4WD B6304T4		Stabiliser Bushing	517797	
	2010.04-2016.12	Rear Axle	Saloon 4WD B6304T4		Stabiliser Bushing	530508	
2010.04-2016.12	Front Axle	Saloon 4WD B6304T4		Steering Rack Bellow Kit	540481S		
S70							
2.3 (176 kw)	1997.01-2000.11	Front Axle Left Lower Outer	Saloon FWD B5234T3		Track Control Arm	S060775	
	1997.01-2000.11	Front Axle Right Lower Outer	Saloon FWD B5234T3		Track Control Arm	S060776	
	1997.01-2000.11	Rear Axle Left Lower	Saloon FWD B5234T3		Control Arm Bushing	530255	
	1997.01-2000.11	Rear Axle Right Lower	Saloon FWD B5234T3		Control Arm Bushing	530256	
	1997.01-2000.11	Rear Axle Left & Right Lower	Saloon FWD B5234T3		Control Arm Bushing	530257	
	1997.01-2000.11	Rear Axle Left Lower	Saloon FWD B5234T3		Control Arm Bushing Kit	530255S	
	1997.01-2000.11	Rear Axle Right	Saloon FWD B5234T3		Control Arm Bushing Kit	530256S	
	1997.01-2000.11	Front Axle Left & Right	Saloon FWD B5234T3		Tie Rod Axle Joint	S030324	
	1997.01-2000.11	Front Axle Left	Saloon FWD B5234T3		Tie Rod End	S070526	
	1997.01-2000.11	Front Axle Right	Saloon FWD B5234T3		Tie Rod End	S070525	
	1997.01-2000.11	Front Axle Left & Right	Saloon FWD B5234T3		Tie Rod End	S070824	
	1997.01-2000.11	Front Axle Left & Right	Saloon FWD B5234T3		Tie Rod End	S070866	
	1997.01-2000.11	Front Axle Left & Right	Saloon FWD B5234T3		Rod/Strut, stabiliser	S100157	
	1997.01-2000.11	Front Axle	Saloon FWD B5234T3		Steering Boot	540076	
	1997.01-2000.11	Front Axle	Saloon FWD B5234T3		Steering Boot	540192	
	1997.01-2000.11	Front Axle	Saloon FWD B5234T3		Steering Boot	540193	
	1997.01-2000.11	Front Axle	Saloon FWD B5234T3		Steering Rack Bellow Kit	540192S	
	1997.01-2000.11	Front Axle	Saloon FWD B5234T3	for manufacturer: TRW	Steering Rack Bellow Kit	540193S	
	2.3 (177 kw)	1996.11-1998.09	Rear Axle Right Lower	Saloon 4WD B5234T3		Control Arm Bushing	530256
		1996.11-1998.09	Front Axle Left & Right	Saloon 4WD B5234T3		Tie Rod Axle Joint	S030330
1996.11-1998.09		Front Axle Left	Saloon 4WD B5234T3		Tie Rod End	S070526	
1996.11-1998.09		Front Axle Right	Saloon 4WD B5234T3		Tie Rod End	S070525	
S80							
2.8 (200 kw)	1998.07-2001.10	Front Axle Left Lower	Saloon FWD B6284T		Track Control Arm	S060777	
	1998.07-2001.10	Front Axle Right Lower	Saloon FWD B6284T		Track Control Arm	S060778	
	1998.07-2001.10	Front Axle Left & Right Lower	Saloon FWD B6284T		Ball Joint	S080359	
	1998.07-2001.10	Front Axle Left & Right Lower	Saloon FWD B6284T		Control Arm Bushing	510796	



	 YEAR	FITTING POSITION	BODY STYLE & DRIVE TYPE & ENGINE	REMARKS	PRODUCT	GSP Ref.
VOLVO S80						
2.8 (200 kw)	1998.07-2001.10	Front Axle Left & Right Lower	Saloon FWD B6284T		Control Arm Bushing	510797
	1998.07-2001.10	Rear Axle Left & Right Lower	Saloon FWD B6284T		Control Arm Bushing	530847
	1998.07-2001.10	Front Axle Left & Right	Saloon FWD B6284T	Date from:2004.01	Tie Rod Axle Joint	S030315
	1998.07-2001.10	Front Axle Left & Right	Saloon FWD B6284T	Date from-to:2000.01-2003.12	Tie Rod Axle Joint	S030332
	1998.07-2001.10	Front Axle Left	Saloon FWD B6284T	Date from:2000	Tie Rod End	S070516
	1998.07-2001.10	Front Axle Left	Saloon FWD B6284T		Tie Rod End	S070520
	1998.07-2001.10	Front Axle Right	Saloon FWD B6284T	Date from:2000	Tie Rod End	S070517
	1998.07-2001.10	Front Axle Right	Saloon FWD B6284T		Tie Rod End	S070521
	1998.07-2001.10	Front Axle Left & Right	Saloon FWD B6284T		Rod/Strut,stabiliser	S050455
	1998.07-2001.10	Rear Axle Left & Right	Saloon FWD B6284T		Rod/Strut,stabiliser	S050453
	1998.07-2001.10	Front Axle	Saloon FWD B6284T		Steering Boot	540197
	1998.07-2001.10	Front Axle	Saloon FWD B6284T		Steering Rack Bellow Kit	540197S
2.9 (200 kw)	2001.10-2006.07	Front Axle Left Lower	Saloon FWD B6294T		Track Control Arm	S060777
	2001.10-2006.07	Front Axle Right Lower	Saloon FWD B6294T		Track Control Arm	S060778
	2001.10-2006.07	Front Axle Left & Right Lower	Saloon FWD B6294T		Ball Joint	S080359
	2001.10-2006.07	Front Axle Left & Right Lower	Saloon FWD B6294T		Control Arm Bushing	510796
	2001.10-2006.07	Front Axle Left & Right Lower	Saloon FWD B6294T		Control Arm Bushing	510797
	2001.10-2006.07	Rear Axle Left & Right Lower	Saloon FWD B6294T		Control Arm Bushing	530847
	2001.10-2006.07	Front Axle Left & Right	Saloon FWD B6294T	Date from:2004.01	Tie Rod Axle Joint	S030315
	2001.10-2006.07	Front Axle Left & Right	Saloon FWD B6294T	Date to:2003.12	Tie Rod Axle Joint	S030332
	2001.10-2006.07	Front Axle Left	Saloon FWD B6294T		Tie Rod End	S070516
	2001.10-2006.07	Front Axle Left	Saloon FWD B6294T		Tie Rod End	S070520
	2001.10-2006.07	Front Axle Right	Saloon FWD B6294T		Tie Rod End	S070517
	2001.10-2006.07	Front Axle Right	Saloon FWD B6294T		Tie Rod End	S070521
	2001.10-2006.07	Front Axle Left & Right	Saloon FWD B6294T		Rod/Strut,stabiliser	S050455
	2001.10-2006.07	Rear Axle Left & Right	Saloon FWD B6294T		Rod/Strut,stabiliser	S050453
	2001.10-2006.07	Front Axle	Saloon FWD B6294T		Steering Boot	540197
	2001.10-2006.07	Front Axle	Saloon FWD B6294T		Steering Rack Bellow Kit	540197S
3.2 (175 kw)	2006.10-2010.03	Front Axle Left Lower	Saloon 4WD B6324S	Chassis no. to:B*999999	Track Control Arm	S060472
	2006.10-2010.03	Front Axle Left Lower	Saloon 4WD B6324S	Chassis no.from:151014	Track Control Arm	S062046
	2006.10-2010.03	Front Axle Right Lower	Saloon 4WD B6324S	Chassis no. to:B*999999	Track Control Arm	S060473
	2006.10-2010.03	Front Axle Right Lower	Saloon 4WD B6324S	Chassis no.from:151014	Track Control Arm	S062045
	2006.10-2010.03	Rear Axle Left & Right Lower Inner	Saloon 4WD B6324S		Track Control Arm	S061219
	2006.10-2010.03	Front Axle Left & Right Lower	Saloon 4WD B6324S		Ball Joint	S080860
	2006.10-2010.03	Front Axle Left Lower	Saloon 4WD B6324S		Control Arm Bushing	530560
	2006.10-2010.03	Front Axle Right Lower	Saloon 4WD B6324S	From Chassis:64877, To Chassis:87000	Control Arm Bushing	530559
	2006.10-2010.03	Front Axle Right Lower	Saloon 4WD B6324S		Control Arm Bushing	530559
	2006.10-2010.03	Front Axle Left & Right Lower	Saloon 4WD B6324S		Control Arm Bushing	516461
	2006.10-2010.03	Rear Axle Left Centre	Saloon 4WD B6324S		Control Arm Bushing	532625
	2006.10-2010.03	Rear Axle Right Centre	Saloon 4WD B6324S		Control Arm Bushing	532624
	2006.10-2010.03	Front Axle Left & Right	Saloon 4WD B6324S		Tie Rod Axle Joint	S030092
	2006.10-2010.03	Front Axle Left & Right	Saloon 4WD B6324S		Rod/Strut,stabiliser	S050017
	2006.10-2010.03	Rear Axle Left & Right	Saloon 4WD B6324S		Rod/Strut,stabiliser	S050151
	2006.10-2010.03	Front Axle	Saloon 4WD B6324S		Stabiliser Bushing	517797
	2006.10-2010.03	Rear Axle	Saloon 4WD B6324S		Stabiliser Bushing	530508
	2006.10-2010.03	Front Axle	Saloon 4WD B6324S	for vehicles without servotronic steering	Steering Rack Bellow Kit	540481S
V40						
1.8 (85 kw)	1995.07-1999.08	Front Axle Left Lower	Estate FWD B4184S/B4184S3		Track Control Arm	S060621
	1995.07-1999.08	Front Axle Right Lower	Estate FWD B4184S/B4184S3		Track Control Arm	S060622
	1995.07-1999.08	Rear Axle Left & Right Upper	Estate FWD B4184S/B4184S3		Track Control Arm	S062207
	1995.07-1999.08	Front Axle Left Lower	Estate FWD B4184S/B4184S3		Control Arm Bushing	511844
	1995.07-1999.08	Front Axle Right Lower	Estate FWD B4184S/B4184S3		Control Arm Bushing	516607
	1995.07-1999.08	Front Axle Left & Right Lower	Estate FWD B4184S/B4184S3		Control Arm Bushing	516080
	1995.07-1999.08	Rear Axle Left & Right Centre	Estate FWD B4184S/B4184S3		Control Arm Bushing	532161
	1995.07-1999.08	Rear Axle Left & Right Lower	Estate FWD B4184S/B4184S3		Control Arm Bushing	530259
	1995.07-1999.08	Front Axle Left & Right	Estate FWD B4184S/B4184S3		Tie Rod End	S070321
	1995.07-1999.08	Front Axle Left & Right	Estate FWD B4184S/B4184S3		Tie Rod End	S070695
	1995.07-1999.08	Front Axle Left & Right	Estate FWD B4184S/B4184S3		Rod/Strut,stabiliser	S050336
	1995.07-1999.08	Rear Axle Left & Right	Estate FWD B4184S/B4184S3		Rod/Strut,stabiliser	S051198
	1995.07-1999.08	Front Axle	Estate FWD B4184S/B4184S3		Steering Rack Bellow Kit	540196S
	1995.07-1999.08	Front Axle	Estate FWD B4184S/B4184S3		Stabiliser Bushing Kit	513354S
	1995.07-1999.08	Front Axle	Estate FWD B4184S/B4184S3		Stabiliser Bushing Kit	513768S
1.8 (90 kw)	1999.03-2004.06	Rear Axle Left & Right Upper	Estate FWD B4184S2		Track Control Arm	S062207
	1999.03-2004.06	Front Axle Left Lower	Estate FWD B4184S2		Control Arm Bushing	511844



	 YEAR	FITTING POSITION	BODY STYLE & DRIVE TYPE & ENGINE	REMARKS	PRODUCT	GSP Ref.	
VOLVO							
V40							
1.8 (90 kw)	1999.03-2004.06	Front Axle Right Lower	Estate FWD B4184S2		Control Arm Bushing	516607	
	1999.03-2004.06	Front Axle Left & Right Lower	Estate FWD B4184S2		Control Arm Bushing	516080	
	1999.03-2004.06	Rear Axle Left & Right Centre	Estate FWD B4184S2		Control Arm Bushing	532161	
	1999.03-2004.06	Rear Axle Left & Right Lower	Estate FWD B4184S2		Control Arm Bushing	530259	
	1999.03-2004.06	Front Axle Left & Right	Estate FWD B4184S2		Tie Rod Axle Joint	S031005	
	1999.03-2004.06	Front Axle Left	Estate FWD B4184S2		Tie Rod End	S070518	
	1999.03-2004.06	Front Axle Right	Estate FWD B4184S2		Tie Rod End	S070519	
	1999.03-2004.06	Front Axle Left & Right	Estate FWD B4184S2	Date to:2000.12	Tie Rod End	S070321	
	1999.03-2004.06	Front Axle Left & Right	Estate FWD B4184S2		Tie Rod End	S070695	
	1999.03-2004.06	Front Axle Left & Right	Estate FWD B4184S2	Date from:2000	Rod/Strut, stabiliser	S050099	
	1999.03-2004.06	Front Axle Left & Right	Estate FWD B4184S2		Rod/Strut, stabiliser	S050336	
	1999.03-2004.06	Rear Axle Left & Right	Estate FWD B4184S2		Rod/Strut, stabiliser	S051198	
	1999.03-2004.06	Front Axle	Estate FWD B4184S2		Steering Rack Bellow Kit	540196S	
	1999.03-2004.06	Front Axle	Estate FWD B4184S2		Stabiliser Bushing Kit	513354S	
2.0 (132 kw)	2013.07-2015.12	Rear Axle Left & Right Upper	Hatchback FWD B5204T8		Track Control Arm	S062629	
	2013.07-2015.12	Rear Axle Left & Right Lower Outer	Hatchback FWD B5204T8		Track Control Arm	S062970	
	2013.07-2015.12	Front Axle Left & Right Lower	Hatchback FWD B5204T8		Control Arm Bushing	517390	
	2013.07-2015.12	Front Axle Left & Right	Hatchback FWD B5204T8		Tie Rod Axle Joint	S030083	
	2013.07-2015.12	Front Axle Left & Right	Hatchback FWD B5204T8		Rod/Strut, stabiliser	S050146	
	2013.07-2015.12	Rear Axle Left & Right	Hatchback FWD B5204T8	for PR no.:Code RA03,for PR no.:Code RA02	Rod/Strut, stabiliser	S050988	
	2013.07-2015.12	Front Axle	Hatchback FWD B5204T8		Steering Boot	540286	
	2013.07-2015.12	Front Axle	Hatchback FWD B5204T8		Steering Rack Bellow Kit	540286S	
2.0 (140 kw)	2015.08-	Rear Axle Left & Right Upper	Hatchback FWD B4204T19		Track Control Arm	S062629	
	2015.08-	Rear Axle Left & Right Lower Outer	Hatchback FWD B4204T19		Track Control Arm	S062970	
	2015.08-	Front Axle Left & Right Lower	Hatchback FWD B4204T19		Control Arm Bushing	517390	
	2015.08-	Front Axle Left & Right	Hatchback FWD B4204T19		Rod/Strut, stabiliser	S050146	
	2015.08-	Rear Axle Left & Right	Hatchback FWD B4204T19	for PR no.:Code RA03,for PR no.:Code RA02	Rod/Strut, stabiliser	S050988	
	2015.08-	Front Axle	Hatchback FWD B4204T19		Steering Boot	540286	
2.0 (180 kw)	2014.05-	Rear Axle Left & Right Upper	Hatchback FWD B4204T11/B4204T41		Track Control Arm	S062629	
	2014.05-	Rear Axle Left & Right Lower Outer	Hatchback FWD B4204T11/B4204T41		Track Control Arm	S062970	
	2014.05-	Front Axle Left & Right Lower	Hatchback FWD B4204T11/B4204T41		Control Arm Bushing	517390	
	2014.05-	Front Axle Left & Right	Hatchback FWD B4204T11/B4204T41		Rod/Strut, stabiliser	S050146	
	2014.05-	Rear Axle Left & Right	Hatchback FWD B4204T11/B4204T41	for PR no.:Code RA03,for PR no.:Code RA02	Rod/Strut, stabiliser	S050988	
	2014.05-	Front Axle	Hatchback FWD B4204T11/B4204T41		Steering Boot	540286	
V40 Cross Country	2014.05-	Front Axle	Hatchback FWD B4204T11/B4204T41		Steering Rack Bellow Kit	540286S	
	2.0 (180 kw)	2014.05-	Rear Axle Left & Right Upper	Hatchback 4WD B4204T11/B4204T41		Track Control Arm	S062629
		2014.05-	Rear Axle Left & Right Lower Outer	Hatchback 4WD B4204T11/B4204T41		Track Control Arm	S062970
		2014.05-	Front Axle Left & Right Lower	Hatchback 4WD B4204T11/B4204T41		Control Arm Bushing	517390
		2014.05-	Front Axle Left & Right	Hatchback 4WD B4204T11/B4204T41		Rod/Strut, stabiliser	S050146
		2014.05-	Rear Axle Left & Right	Hatchback 4WD B4204T11/B4204T41	for PR no.:Code RA03,for PR no.:Code RA02	Rod/Strut, stabiliser	S050988
2014.05-		Front Axle	Hatchback 4WD B4204T11/B4204T41		Steering Boot	540286	
V50	2014.05-	Front Axle	Hatchback 4WD B4204T11/B4204T41		Steering Rack Bellow Kit	540286S	
	1.6 (74 kw)	2004.11-2012.05	Front Axle Left Lower	Estate FWD B4164S3	Chassis no. to:214682	Track Control Arm	S060478
		2004.11-2012.05	Front Axle Left Lower	Estate FWD B4164S3	Chassis no.from:214683	Track Control Arm	S060921
		2004.11-2012.05	Front Axle Right Lower	Estate FWD B4164S3	Chassis no. to:214682	Track Control Arm	S060479
		2004.11-2012.05	Front Axle Right Lower	Estate FWD B4164S3	Chassis no.from:214683	Track Control Arm	S060922
		2004.11-2012.05	Rear Axle Left & Right Upper	Estate FWD B4164S3		Track Control Arm	S060182
2004.11-2012.05		Rear Axle Left & Right Lower Inner	Estate FWD B4164S3		Track Control Arm	S060183	
2004.11-2012.05		Rear Axle Left & Right Lower Outer	Estate FWD B4164S3		Track Control Arm	S061286	
2004.11-2012.05		Front Axle Left & Right Lower	Estate FWD B4164S3	Chassis no.to:214682	Ball Joint	S080069	
2004.11-2012.05		Front Axle Left & Right Lower	Estate FWD B4164S3	Chassis no.from:214683	Ball Joint	S080070	
2004.11-2012.05		Front Axle Left & Right Lower	Estate FWD B4164S3		Control Arm Bushing	514447	
2004.11-2012.05		Front Axle Left & Right Lower	Estate FWD B4164S3		Control Arm Bushing	516436	
2004.11-2012.05		Front Axle Left & Right Lower	Estate FWD B4164S3		Control Arm Bushing	516567	
2004.11-2012.05		Front Axle Left & Right Lower	Estate FWD B4164S3		Control Arm Bushing	517914	
2004.11-2012.05		Rear Axle Left & Right Upper	Estate FWD B4164S3		Control Arm Bushing	514889	
2004.11-2012.05	Rear Axle Left & Right Lower Inner	Estate FWD B4164S3		Control Arm Bushing	514904		
2004.11-2012.05	Rear Axle Left & Right Lower Outer	Estate FWD B4164S3	Date to:2010	Control Arm Bushing	514949		
2004.11-2012.05	Rear Axle Left & Right Lower Outer	Estate FWD B4164S3	Date to:2010	Control Arm Bushing	514957		
2004.11-2012.05	Front Axle Left & Right	Estate FWD B4164S3		Tie Rod Axle Joint	S030083		



	 YEAR	FITTING POSITION	BODY STYLE & DRIVE TYPE & ENGINE	REMARKS	PRODUCT	GSP Ref.	
VOLVO							
V50							
1.6 (74 kw)	2004.11-2012.05	Front Axle Left	Estate FWD B4164S3		Tie Rod End	S070157	
	2004.11-2012.05	Front Axle Right	Estate FWD B4164S3		Tie Rod End	S070158	
	2004.11-2012.05	Front Axle Left & Right	Estate FWD B4164S3		Rod/Strut, stabiliser	S050146	
	2004.11-2012.05	Rear Axle Left & Right	Estate FWD B4164S3		Rod/Strut, stabiliser	520378	
	2004.11-2012.05	Rear Axle Left & Right	Estate FWD B4164S3		Rod/Strut, stabiliser	S050145	
	2004.11-2012.05	Rear Axle	Estate FWD B4164S3		Stabiliser Bushing	514033	
	2004.11-2012.05	Front Axle	Estate FWD B4164S3		Steering Boot	540286	
	2004.11-2012.05	Front Axle	Estate FWD B4164S3		Steering Rack Bellow Kit	540286S	
2.0 (107 kw)	2006.03-2012.05	Front Axle Left Lower	Estate FWD B4204S3	Chassis no. to:214682	Track Control Arm	S060478	
	2006.03-2012.05	Front Axle Left Lower	Estate FWD B4204S3	Chassis no.from:214683	Track Control Arm	S060921	
	2006.03-2012.05	Front Axle Right Lower	Estate FWD B4204S3	Chassis no. to:214682	Track Control Arm	S060479	
	2006.03-2012.05	Front Axle Right Lower	Estate FWD B4204S3	Chassis no.from:214683	Track Control Arm	S060922	
	2006.03-2012.05	Rear Axle Left & Right Upper	Estate FWD B4204S3		Track Control Arm	S060182	
	2006.03-2012.05	Rear Axle Left & Right Lower Inner	Estate FWD B4204S3		Track Control Arm	S060183	
	2006.03-2012.05	Rear Axle Left & Right Lower Outer	Estate FWD B4204S3		Track Control Arm	S061286	
	2006.03-2012.05	Front Axle Left & Right Lower	Estate FWD B4204S3	Chassis no.to:214682	Ball Joint	S080069	
	2006.03-2012.05	Front Axle Left & Right Lower	Estate FWD B4204S3	Chassis no.from:214683	Ball Joint	S080070	
	2006.03-2012.05	Front Axle Left & Right Lower	Estate FWD B4204S3		Control Arm Bushing	514447	
	2006.03-2012.05	Front Axle Left & Right Lower	Estate FWD B4204S3		Control Arm Bushing	516436	
	2006.03-2012.05	Front Axle Left & Right Lower	Estate FWD B4204S3		Control Arm Bushing	516567	
	2006.03-2012.05	Front Axle Left & Right Lower	Estate FWD B4204S3		Control Arm Bushing	517914	
	2006.03-2012.05	Rear Axle Left & Right Upper	Estate FWD B4204S3		Control Arm Bushing	514889	
	2006.03-2012.05	Rear Axle Left & Right Lower Inner	Estate FWD B4204S3		Control Arm Bushing	514904	
	2006.03-2012.05	Rear Axle Left & Right Lower Outer	Estate FWD B4204S3	Date to:2010	Control Arm Bushing	514949	
	2006.03-2012.05	Rear Axle Left & Right Lower Outer	Estate FWD B4204S3	Date to:2010	Control Arm Bushing	514957	
	2006.03-2012.05	Front Axle Left & Right	Estate FWD B4204S3		Tie Rod Axle Joint	S030083	
	2006.03-2012.05	Front Axle Left	Estate FWD B4204S3		Tie Rod End	S070157	
	2006.03-2012.05	Front Axle Right	Estate FWD B4204S3		Tie Rod End	S070158	
	2006.03-2012.05	Front Axle Left & Right	Estate FWD B4204S3		Rod/Strut, stabiliser	S050146	
	2006.03-2012.05	Rear Axle Left & Right	Estate FWD B4204S3		Rod/Strut, stabiliser	520378	
	2006.03-2012.05	Rear Axle Left & Right	Estate FWD B4204S3		Rod/Strut, stabiliser	S050145	
	2006.03-2012.05	Rear Axle	Estate FWD B4204S3		Stabiliser Bushing	514033	
	2006.03-2012.05	Front Axle	Estate FWD B4204S3		Steering Boot	540286	
	2006.03-2012.05	Front Axle	Estate FWD B4204S3		Steering Rack Bellow Kit	540286S	
	2.4 (103 kw)	2003.12-2010.09	Front Axle Left Lower	Estate FWD B5244S5	Chassis no. to:214682	Track Control Arm	S060478
		2003.12-2010.09	Front Axle Left Lower	Estate FWD B5244S5	Chassis no.from:214683	Track Control Arm	S060921
2003.12-2010.09		Front Axle Right Lower	Estate FWD B5244S5	Chassis no. to:214682	Track Control Arm	S060479	
2003.12-2010.09		Front Axle Right Lower	Estate FWD B5244S5	Chassis no.from:214683	Track Control Arm	S060922	
2003.12-2010.09		Rear Axle Left & Right Upper	Estate FWD B5244S5		Track Control Arm	S060182	
2003.12-2010.09		Rear Axle Left & Right Lower Inner	Estate FWD B5244S5		Track Control Arm	S060183	
2003.12-2010.09		Rear Axle Left & Right Lower Outer	Estate FWD B5244S5		Track Control Arm	S061286	
2003.12-2010.09		Front Axle Left & Right Lower	Estate FWD B5244S5	Chassis no.to:214682	Ball Joint	S080069	
2003.12-2010.09		Front Axle Left & Right Lower	Estate FWD B5244S5	Chassis no.from:214683	Ball Joint	S080070	
2003.12-2010.09		Front Axle Left & Right Lower	Estate FWD B5244S5		Control Arm Bushing	516436	
2003.12-2010.09		Front Axle Left & Right Lower	Estate FWD B5244S5		Control Arm Bushing	517914	
2003.12-2010.09		Rear Axle Left & Right Upper	Estate FWD B5244S5		Control Arm Bushing	514889	
2003.12-2010.09		Rear Axle Left & Right Lower Inner	Estate FWD B5244S5		Control Arm Bushing	514904	
2003.12-2010.09		Rear Axle Left & Right Lower Outer	Estate FWD B5244S5		Control Arm Bushing	514949	
2003.12-2010.09		Rear Axle Left & Right Lower Outer	Estate FWD B5244S5		Control Arm Bushing	514957	
2003.12-2010.09		Front Axle Left & Right	Estate FWD B5244S5		Tie Rod Axle Joint	S030083	
2003.12-2010.09		Front Axle Left	Estate FWD B5244S5		Tie Rod End	S070157	
2003.12-2010.09		Front Axle Right	Estate FWD B5244S5		Tie Rod End	S070158	
2003.12-2010.09		Front Axle Left & Right	Estate FWD B5244S5		Rod/Strut, stabiliser	S050146	
2003.12-2010.09		Rear Axle Left & Right	Estate FWD B5244S5		Rod/Strut, stabiliser	520378	
2003.12-2010.09		Rear Axle Left & Right	Estate FWD B5244S5		Rod/Strut, stabiliser	S050145	
2003.12-2010.09		Rear Axle	Estate FWD B5244S5		Stabiliser Bushing	514033	
2003.12-2010.09		Front Axle	Estate FWD B5244S5		Steering Boot	540286	
2003.12-2010.09		Front Axle	Estate FWD B5244S5		Steering Rack Bellow Kit	540286S	
2.4 (125 kw)		2003.12-2010.09	Front Axle Left Lower	Estate FWD B5244S4	Chassis no. to:214682	Track Control Arm	S060478
		2003.12-2010.09	Front Axle Left Lower	Estate FWD B5244S4	Chassis no.from:214683	Track Control Arm	S060921
		2003.12-2010.09	Front Axle Right Lower	Estate FWD B5244S4	Chassis no. to:214682	Track Control Arm	S060479
		2003.12-2010.09	Front Axle Right Lower	Estate FWD B5244S4	Chassis no.from:214683	Track Control Arm	S060922
	2003.12-2010.09	Rear Axle Left & Right Upper	Estate FWD B5244S4		Track Control Arm	S060182	
	2003.12-2010.09	Rear Axle Left & Right Lower Inner	Estate FWD B5244S4		Track Control Arm	S060183	

	 YEAR	FITTING POSITION	BODY STYLE & DRIVE TYPE & ENGINE	REMARKS	PRODUCT	GSP Ref.
VOLVO						
V50						
2.4 (125 kw)	2003.12-2010.09	Rear Axle Left & Right Lower Outer	Estate FWD B5244S4		Track Control Arm	S061286
	2003.12-2010.09	Front Axle Left & Right Lower	Estate FWD B5244S4	Chassis no.to:214682	Ball Joint	S080069
	2003.12-2010.09	Front Axle Left & Right Lower	Estate FWD B5244S4	Chassis no.from:214683	Ball Joint	S080070
	2003.12-2010.09	Front Axle Left & Right Lower	Estate FWD B5244S4		Control Arm Bushing	516436
	2003.12-2010.09	Front Axle Left & Right Lower	Estate FWD B5244S4		Control Arm Bushing	517914
	2003.12-2010.09	Rear Axle Left & Right Upper	Estate FWD B5244S4		Control Arm Bushing	514889
	2003.12-2010.09	Rear Axle Left & Right Lower Inner	Estate FWD B5244S4		Control Arm Bushing	514904
	2003.12-2010.09	Rear Axle Left & Right Lower Outer	Estate FWD B5244S4		Control Arm Bushing	514949
	2003.12-2010.09	Rear Axle Left & Right Lower Outer	Estate FWD B5244S4		Control Arm Bushing	514957
	2003.12-2010.09	Front Axle Left & Right	Estate FWD B5244S4		Tie Rod Axle Joint	S030083
	2003.12-2010.09	Front Axle Left	Estate FWD B5244S4		Tie Rod End	S070157
	2003.12-2010.09	Front Axle Right	Estate FWD B5244S4		Tie Rod End	S070158
	2003.12-2010.09	Front Axle Left & Right	Estate FWD B5244S4		Rod/Strut,stabiliser	S050146
	2003.12-2010.09	Rear Axle Left & Right	Estate FWD B5244S4		Rod/Strut,stabiliser	520378
	2003.12-2010.09	Rear Axle Left & Right	Estate FWD B5244S4		Rod/Strut,stabiliser	S050145
	2003.12-2010.09	Rear Axle	Estate FWD B5244S4		Stabiliser Bushing	514033
	2003.12-2010.09	Front Axle	Estate FWD B5244S4		Steering Boot	540286
	2003.12-2010.09	Front Axle	Estate FWD B5244S4		Steering Rack Bellow Kit	540286S
2.5 (162 kw)	2004.05-2008.12	Front Axle Left Lower	Estate 4WD B5254T3	Chassis no. to:214682	Track Control Arm	S060478
	2004.05-2008.12	Front Axle Left Lower	Estate 4WD B5254T3	Chassis no.from:214683	Track Control Arm	S060921
	2004.05-2008.12	Front Axle Right Lower	Estate 4WD B5254T3	Chassis no. to:214682	Track Control Arm	S060479
	2004.05-2008.12	Front Axle Right Lower	Estate 4WD B5254T3	Chassis no.from:214683	Track Control Arm	S060922
	2004.05-2008.12	Rear Axle Left & Right Lower Inner	Estate 4WD B5254T3		Track Control Arm	S060183
	2004.05-2008.12	Front Axle Left & Right Lower	Estate 4WD B5254T3	Chassis no.to:214682	Ball Joint	S080069
	2004.05-2008.12	Front Axle Left & Right Lower	Estate 4WD B5254T3	Chassis no.from:214683	Ball Joint	S080070
	2004.05-2008.12	Front Axle Left & Right Lower	Estate 4WD B5254T3		Control Arm Bushing	516436
	2004.05-2008.12	Rear Axle Left & Right Upper	Estate 4WD B5254T3		Control Arm Bushing	514889
	2004.05-2008.12	Rear Axle Left & Right Lower Inner	Estate 4WD B5254T3		Control Arm Bushing	514904
	2004.05-2008.12	Rear Axle Left & Right Lower Outer	Estate 4WD B5254T3		Control Arm Bushing	514949
	2004.05-2008.12	Rear Axle Left & Right Lower Outer	Estate 4WD B5254T3		Control Arm Bushing	514957
	2004.05-2008.12	Front Axle Left & Right	Estate 4WD B5254T3		Tie Rod Axle Joint	S030083
	2004.05-2008.12	Front Axle Left	Estate 4WD B5254T3		Tie Rod End	S070157
	2004.05-2008.12	Front Axle Right	Estate 4WD B5254T3		Tie Rod End	S070158
	2004.05-2008.12	Front Axle Left & Right	Estate 4WD B5254T3		Rod/Strut,stabiliser	S050146
	2004.05-2008.12	Rear Axle Left & Right	Estate 4WD B5254T3		Rod/Strut,stabiliser	520378
	2004.05-2008.12	Rear Axle Left & Right	Estate 4WD B5254T3		Rod/Strut,stabiliser	S050145
	2004.05-2008.12	Rear Axle	Estate 4WD B5254T3		Stabiliser Bushing	514033
	2004.05-2008.12	Front Axle	Estate 4WD B5254T3		Steering Boot	540286
	2004.05-2008.12	Front Axle	Estate 4WD B5254T3		Steering Rack Bellow Kit	540286S
2.5 (169 kw)	2007.04-2012.12	Front Axle Left Lower	Estate 4WD B5254T7	Chassis no. to:214682	Track Control Arm	S060478
	2007.04-2012.12	Front Axle Left Lower	Estate 4WD B5254T7	Chassis no.from:214683	Track Control Arm	S060921
	2007.04-2012.12	Front Axle Right Lower	Estate 4WD B5254T7	Chassis no. to:214682	Track Control Arm	S060479
	2007.04-2012.12	Front Axle Right Lower	Estate 4WD B5254T7	Chassis no.from:214683	Track Control Arm	S060922
	2007.04-2012.12	Rear Axle Left & Right Upper	Estate 4WD B5254T7		Track Control Arm	S060182
	2007.04-2012.12	Rear Axle Left & Right Lower Inner	Estate 4WD B5254T7		Track Control Arm	S060183
	2007.04-2012.12	Front Axle Left & Right Lower	Estate 4WD B5254T7	Chassis no.to:214682	Ball Joint	S080069
	2007.04-2012.12	Front Axle Left & Right Lower	Estate 4WD B5254T7	Chassis no.from:214683	Ball Joint	S080070
	2007.04-2012.12	Front Axle Left & Right Lower	Estate 4WD B5254T7		Control Arm Bushing	516436
	2007.04-2012.12	Front Axle Left & Right Lower	Estate 4WD B5254T7		Control Arm Bushing	517914
	2007.04-2012.12	Rear Axle Left & Right Upper	Estate 4WD B5254T7		Control Arm Bushing	514889
	2007.04-2012.12	Rear Axle Left & Right Lower Inner	Estate 4WD B5254T7		Control Arm Bushing	514904
	2007.04-2012.12	Rear Axle Left & Right Lower Outer	Estate 4WD B5254T7		Control Arm Bushing	514949
	2007.04-2012.12	Rear Axle Left & Right Lower Outer	Estate 4WD B5254T7		Control Arm Bushing	514957
	2007.04-2012.12	Front Axle Left & Right	Estate 4WD B5254T7		Tie Rod Axle Joint	S030083
	2007.04-2012.12	Front Axle Left	Estate 4WD B5254T7		Tie Rod End	S070157
	2007.04-2012.12	Front Axle Right	Estate 4WD B5254T7		Tie Rod End	S070158
	2007.04-2012.12	Front Axle Left & Right	Estate 4WD B5254T7		Rod/Strut,stabiliser	S050146
	2007.04-2012.12	Rear Axle Left & Right	Estate 4WD B5254T7		Rod/Strut,stabiliser	520378
	2007.04-2012.12	Rear Axle Left & Right	Estate 4WD B5254T7		Rod/Strut,stabiliser	S050145
	2007.04-2012.12	Rear Axle	Estate 4WD B5254T7		Stabiliser Bushing	514033
	2007.04-2012.12	Front Axle	Estate 4WD B5254T7		Steering Boot	540286
	2007.04-2012.12	Front Axle	Estate 4WD B5254T7		Steering Rack Bellow Kit	540286S



	 YEAR	FITTING POSITION	BODY STYLE & DRIVE TYPE & ENGINE	REMARKS	PRODUCT	GSP Ref.	
VOLVO							
V60							
2.0 (140 kw)	2015.03-2018.05	Front Axle Left Lower	Estate FWD B4204T19		Track Control Arm	S060472	
	2015.03-2018.05	Front Axle Left Lower	Estate FWD B4204T19	Chassis no.from:35001	Track Control Arm	S062046	
	2015.03-2018.05	Front Axle Right Lower	Estate FWD B4204T19		Track Control Arm	S060473	
	2015.03-2018.05	Front Axle Right Lower	Estate FWD B4204T19	Chassis no.from:35001	Track Control Arm	S062045	
	2015.03-2018.05	Front Axle Left & Right Lower	Estate FWD B4204T19		Ball Joint	S080860	
	2015.03-2018.05	Front Axle Left Lower	Estate FWD B4204T19		Control Arm Bushing	530560	
	2015.03-2018.05	Front Axle Right Lower	Estate FWD B4204T19		Control Arm Bushing	530559	
	2015.03-2018.05	Front Axle Left & Right Lower	Estate FWD B4204T19		Control Arm Bushing	516461	
	2015.03-2018.05	Rear Axle Left & Right Centre	Estate FWD B4204T19		Control Arm Bushing	530569	
	2015.03-2018.05	Front Axle Left & Right	Estate FWD B4204T19		Tie Rod Axle Joint	S030092	
	2015.03-2018.05	Front Axle Left & Right	Estate FWD B4204T19		Rod/Strut, stabiliser	S050017	
	2015.03-2018.05	Rear Axle Left & Right	Estate FWD B4204T19		Rod/Strut, stabiliser	S050151	
	2015.03-2018.05	Rear Axle	Estate FWD B4204T19		Stabiliser Bushing	530508	
	2015.03-2018.05	Front Axle	Estate FWD B4204T19		Steering Rack Bellow Kit	540481S	
2.0 (176 kw)	2012.08-2014.07	Front Axle Left Lower	Estate FWD B4204T7		Track Control Arm	S060472	
	2012.08-2014.07	Front Axle Left Lower	Estate FWD B4204T7	Chassis no.from:35001	Track Control Arm	S062046	
	2012.08-2014.07	Front Axle Right Lower	Estate FWD B4204T7		Track Control Arm	S060473	
	2012.08-2014.07	Front Axle Right Lower	Estate FWD B4204T7	Chassis no.from:35001	Track Control Arm	S062045	
	2012.08-2014.07	Front Axle Left & Right Lower	Estate FWD B4204T7		Ball Joint	S080860	
	2012.08-2014.07	Front Axle Left Lower	Estate FWD B4204T7		Control Arm Bushing	530560	
	2012.08-2014.07	Front Axle Right Lower	Estate FWD B4204T7		Control Arm Bushing	530559	
	2012.08-2014.07	Front Axle Left & Right Lower	Estate FWD B4204T7	Date from:2015	Control Arm Bushing	516450	
	2012.08-2014.07	Front Axle Left & Right Lower	Estate FWD B4204T7		Control Arm Bushing	516461	
	2012.08-2014.07	Rear Axle Left & Right Centre	Estate FWD B4204T7		Control Arm Bushing	530569	
	2012.08-2014.07	Rear Axle Left & Right Upper	Estate FWD B4204T7		Control Arm Bushing	530553	
	2012.08-2014.07	Rear Axle Left & Right Lower Inner	Estate FWD B4204T7		Control Arm Bushing	516522	
	2012.08-2014.07	Rear Axle Left & Right Lower Outer	Estate FWD B4204T7		Control Arm Bushing	530523	
	2012.08-2014.07	Rear Axle Left & Right Lower Outer	Estate FWD B4204T7		Control Arm Bushing	530524	
	2012.08-2014.07	Front Axle Left & Right	Estate FWD B4204T7		Tie Rod Axle Joint	S030092	
	2012.08-2014.07	Front Axle Left & Right	Estate FWD B4204T7		Rod/Strut, stabiliser	S050017	
	2012.08-2014.07	Rear Axle	Estate FWD B4204T7		Stabiliser Bushing	530508	
	2012.08-2014.07	Front Axle	Estate FWD B4204T7		Steering Rack Bellow Kit	540481S	
	2.0 (180 kw)	2013.10-2018.05	Front Axle Left Lower	Estate FWD B4204T11/B4204T41	Engine code:B 4204 T11	Track Control Arm	S060472
		2013.10-2018.05	Front Axle Left Lower	Estate FWD B4204T11/B4204T41	Chassis no.from:35001	Track Control Arm	S062046
2013.10-2018.05		Front Axle Right Lower	Estate FWD B4204T11/B4204T41	Engine code:B 4204 T11	Track Control Arm	S060473	
2013.10-2018.05		Front Axle Right Lower	Estate FWD B4204T11/B4204T41	Chassis no.from:35001	Track Control Arm	S062045	
2013.10-2018.05		Front Axle Left & Right Lower	Estate FWD B4204T11/B4204T41		Ball Joint	S080860	
2013.10-2018.05		Front Axle Left Lower	Estate FWD B4204T11/B4204T41		Control Arm Bushing	530560	
2013.10-2018.05		Front Axle Right Lower	Estate FWD B4204T11/B4204T41		Control Arm Bushing	530559	
2013.10-2018.05		Front Axle Left & Right Lower	Estate FWD B4204T11/B4204T41	Date from:2015	Control Arm Bushing	516450	
2013.10-2018.05		Front Axle Left & Right Lower	Estate FWD B4204T11/B4204T41		Control Arm Bushing	516461	
2013.10-2018.05		Rear Axle Left Centre	Estate FWD B4204T11/B4204T41		Control Arm Bushing	532625	
2013.10-2018.05		Rear Axle Left & Right Centre	Estate FWD B4204T11/B4204T41		Control Arm Bushing	530569	
2013.10-2018.05		Rear Axle Left & Right Upper	Estate FWD B4204T11/B4204T41		Control Arm Bushing	530553	
2013.10-2018.05		Rear Axle Left & Right Lower Inner	Estate FWD B4204T11/B4204T41		Control Arm Bushing	516522	
2013.10-2018.05		Rear Axle Left & Right Lower Outer	Estate FWD B4204T11/B4204T41		Control Arm Bushing	530523	
2013.10-2018.05		Rear Axle Left & Right Lower Outer	Estate FWD B4204T11/B4204T41		Control Arm Bushing	530524	
2013.10-2018.05		Front Axle Left & Right	Estate FWD B4204T11/B4204T41		Tie Rod Axle Joint	S030092	
2013.10-2018.05		Front Axle Left & Right	Estate FWD B4204T11/B4204T41		Rod/Strut, stabiliser	S050017	
2013.10-2018.05		Rear Axle Left & Right	Estate FWD B4204T11/B4204T41		Rod/Strut, stabiliser	S050151	
2013.10-2018.05		Rear Axle	Estate FWD B4204T11/B4204T41		Stabiliser Bushing	530508	
2013.10-2018.05		Front Axle	Estate FWD B4204T11/B4204T41		Steering Rack Bellow Kit	540481S	
2.0 (225 kw)		2013.10-2018.12	Front Axle Left Lower	Estate FWD B4204T9		Track Control Arm	S060472
		2013.10-2018.12	Front Axle Left Lower	Estate FWD B4204T9	Chassis no.from:35001	Track Control Arm	S062046
		2013.10-2018.12	Front Axle Right Lower	Estate FWD B4204T9		Track Control Arm	S060473
		2013.10-2018.12	Front Axle Right Lower	Estate FWD B4204T9	Chassis no.from:35001	Track Control Arm	S062045
	2013.10-2018.12	Front Axle Left & Right Lower	Estate FWD B4204T9		Ball Joint	S080860	
	2013.10-2018.12	Front Axle Left Lower	Estate FWD B4204T9		Control Arm Bushing	530560	
	2013.10-2018.12	Front Axle Right Lower	Estate FWD B4204T9		Control Arm Bushing	530559	
	2013.10-2018.12	Front Axle Left & Right Lower	Estate FWD B4204T9	Date from:2015	Control Arm Bushing	516450	
	2013.10-2018.12	Front Axle Left & Right Lower	Estate FWD B4204T9		Control Arm Bushing	516461	
	2013.10-2018.12	Rear Axle Left Centre	Estate FWD B4204T9		Control Arm Bushing	532625	
	2013.10-2018.12	Rear Axle Left & Right Centre	Estate FWD B4204T9		Control Arm Bushing	530569	
	2013.10-2018.12	Rear Axle Left & Right Upper	Estate FWD B4204T9		Control Arm Bushing	530553	



	 YEAR	FITTING POSITION	BODY STYLE & DRIVE TYPE & ENGINE	REMARKS	PRODUCT	GSP Ref.	
VOLVO							
V60							
2.0 (225 kw)	2013.10-2018.12	Rear Axle Left & Right Lower Inner	Estate FWD B4204T9		Control Arm Bushing	516522	
	2013.10-2018.12	Rear Axle Left & Right Lower Outer	Estate FWD B4204T9		Control Arm Bushing	530523	
	2013.10-2018.12	Rear Axle Left & Right Lower Outer	Estate FWD B4204T9		Control Arm Bushing	530524	
	2013.10-2018.12	Front Axle Left & Right	Estate FWD B4204T9		Tie Rod Axle Joint	S030092	
	2013.10-2018.12	Front Axle Left & Right	Estate FWD B4204T9		Rod/Strut,stabiliser	S050017	
	2013.10-2018.12	Rear Axle Left & Right	Estate FWD B4204T9		Rod/Strut,stabiliser	S050151	
	2013.10-2018.12	Rear Axle	Estate FWD B4204T9		Stabiliser Bushing	530508	
	2013.10-2018.12	Front Axle	Estate FWD B4204T9		Steering Rack Bellow Kit	540481S	
3.0 (224 kw)	2010.11-2015.12	Front Axle Left Lower	Estate 4WD B6304T4		Track Control Arm	S060472	
	2010.11-2015.12	Front Axle Left Lower	Estate 4WD B6304T4	Chassis no.from:35001	Track Control Arm	S062046	
	2010.11-2015.12	Front Axle Right Lower	Estate 4WD B6304T4		Track Control Arm	S060473	
	2010.11-2015.12	Front Axle Right Lower	Estate 4WD B6304T4	Chassis no.from:35001	Track Control Arm	S062045	
	2010.11-2015.12	Rear Axle Left & Right Lower Inner	Estate 4WD B6304T4		Track Control Arm	S061219	
	2010.11-2015.12	Front Axle Left & Right Lower	Estate 4WD B6304T4		Ball Joint	S080860	
	2010.11-2015.12	Front Axle Left Lower	Estate 4WD B6304T4		Control Arm Bushing	530560	
	2010.11-2015.12	Front Axle Right Lower	Estate 4WD B6304T4		Control Arm Bushing	530559	
	2010.11-2015.12	Front Axle Left & Right Lower	Estate 4WD B6304T4	Date from:2011	Control Arm Bushing	516450	
	2010.11-2015.12	Front Axle Left & Right Lower	Estate 4WD B6304T4		Control Arm Bushing	516461	
	2010.11-2015.12	Rear Axle Left Centre	Estate 4WD B6304T4		Control Arm Bushing	532625	
	2010.11-2015.12	Rear Axle Right Centre	Estate 4WD B6304T4		Control Arm Bushing	532624	
	2010.11-2015.12	Rear Axle Left & Right Centre	Estate 4WD B6304T4		Control Arm Bushing	530569	
	2010.11-2015.12	Rear Axle Left & Right Upper	Estate 4WD B6304T4		Control Arm Bushing	530553	
	2010.11-2015.12	Rear Axle Left & Right Lower Inner	Estate 4WD B6304T4		Control Arm Bushing	516522	
	2010.11-2015.12	Rear Axle Left & Right Lower Outer	Estate 4WD B6304T4		Control Arm Bushing	530523	
	2010.11-2015.12	Rear Axle Left & Right Lower Outer	Estate 4WD B6304T4		Control Arm Bushing	530524	
	2010.11-2015.12	Front Axle Left & Right	Estate 4WD B6304T4		Tie Rod Axle Joint	S030092	
	2010.11-2015.12	Front Axle Left & Right	Estate 4WD B6304T4		Rod/Strut,stabiliser	S050017	
	2010.11-2015.12	Rear Axle Left & Right	Estate 4WD B6304T4		Rod/Strut,stabiliser	S050151	
	2010.11-2015.12	Front Axle	Estate 4WD B6304T4		Stabiliser Bushing	517797	
	2010.11-2015.12	Rear Axle	Estate 4WD B6304T4		Stabiliser Bushing	530508	
	2010.11-2015.12	Front Axle	Estate 4WD B6304T4	for vehicles without electric power steering for vehicles without dynamic steering	Steering Rack Bellow Kit	540481S	
	V70						
	2.0 (105 kw)	1996.11-1998.09	Rear Axle Right Lower	Estate FWD B5204T2		Control Arm Bushing	530256
		1996.11-1998.09	Rear Axle Left & Right Lower	Estate FWD B5204T2		Control Arm Bushing	530257
		1996.11-1998.09	Front Axle Left & Right	Estate FWD B5204T2		Tie Rod Axle Joint	S030324
		1996.11-1998.09	Front Axle Left	Estate FWD B5204T2		Tie Rod End	S070526
1996.11-1998.09		Front Axle Right	Estate FWD B5204T2		Tie Rod End	S070525	
1996.11-1998.09		Front Axle Left & Right	Estate FWD B5204T2		Tie Rod End	S070824	
1996.11-1998.09		Front Axle Left & Right	Estate FWD B5204T2		Rod/Strut,stabiliser	S100157	
1996.11-1998.09		Front Axle	Estate FWD B5204T2		Steering Boot	540192	
1996.11-1998.09		Front Axle	Estate FWD B5204T2		Steering Boot	540193	
1996.11-1998.09		Front Axle	Estate FWD B5204T2	Date from-to: 1996.11-1998.09	Steering Rack Bellow Kit	540192S	
1996.11-1998.09		Front Axle	Estate FWD B5204T2	Date from-to: 1996.11-1998.09	Steering Rack Bellow Kit	540193S	
2.0 (132 kw)		1997.01-2000.03	Front Axle Left Lower Outer	Estate FWD B5204T2		Track Control Arm	S060775
		1997.01-2000.03	Front Axle Right Lower Outer	Estate FWD B5204T2		Track Control Arm	S060776
	1997.01-2000.03	Rear Axle Left Lower	Estate FWD B5204T2		Control Arm Bushing	530255	
	1997.01-2000.03	Rear Axle Right Lower	Estate FWD B5204T2		Control Arm Bushing	530256	
	1997.01-2000.03	Rear Axle Left & Right Lower	Estate FWD B5204T2		Control Arm Bushing	530257	
	1997.01-2000.03	Front Axle Left & Right	Estate FWD B5204T2		Tie Rod Axle Joint	S030324	
	1997.01-2000.03	Front Axle Left	Estate FWD B5204T2		Tie Rod End	S070526	
	1997.01-2000.03	Front Axle Right	Estate FWD B5204T2		Tie Rod End	S070525	
	1997.01-2000.03	Front Axle Left & Right	Estate FWD B5204T2		Rod/Strut,stabiliser	S100157	
	1997.01-2000.03	Front Axle	Estate FWD B5204T2		Steering Boot	540076	
	1997.01-2000.03	Front Axle	Estate FWD B5204T2		Steering Boot	540192	
	1997.01-2000.03	Front Axle	Estate FWD B5204T2		Steering Boot	540193	
	1997.01-2000.03	Front Axle	Estate FWD B5204T2	for manufacturer: SMI	Steering Rack Bellow Kit	540192S	
	1997.01-2000.03	Front Axle	Estate FWD B5204T2	for manufacturer: TRW	Steering Rack Bellow Kit	540193S	
	2000.03-2007.08	Front Axle Left Lower	Estate FWD B5204T5		Track Control Arm	S060767	
	2000.03-2007.08	Front Axle Right Lower	Estate FWD B5204T5		Track Control Arm	S060768	
	2000.03-2007.08	Front Axle Left & Right Lower	Estate FWD B5204T5	Chassis no.from:645618,647149	Ball Joint	S080265	
	2000.03-2007.08	Front Axle Left & Right Lower	Estate FWD B5204T5	Chassis no.to:645617,647148	Ball Joint	S080359	
	2000.03-2007.08	Front Axle Left & Right Lower	Estate FWD B5204T5		Control Arm Bushing	510796	
	2000.03-2007.08	Front Axle Left & Right Lower	Estate FWD B5204T5		Control Arm Bushing	510797	
	2000.03-2007.08	Front Axle Left & Right Lower	Estate FWD B5204T5	Date to:2004.10,Quantity:2	Control Arm Bushing	530261	



	 YEAR	FITTING POSITION	BODY STYLE & DRIVE TYPE & ENGINE	REMARKS	PRODUCT	GSP Ref.
VOLVO						
V70						
2.0 (132 kw)	2000.03-2007.08	Rear Axle Left & Right Lower	Estate FWD B5204T5		Control Arm Bushing	530847
	2000.03-2007.08	Front Axle Left & Right	Estate FWD B5204T5	Date from:2004.01	Tie Rod Axle Joint	S030315
	2000.03-2007.08	Front Axle Left & Right	Estate FWD B5204T5	Date to:2003.12	Tie Rod Axle Joint	S030332
	2000.03-2007.08	Front Axle Left	Estate FWD B5204T5		Tie Rod End	S070516
	2000.03-2007.08	Front Axle Right	Estate FWD B5204T5		Tie Rod End	S070517
	2000.03-2007.08	Front Axle Left & Right	Estate FWD B5204T5		Rod/Strut,stabiliser	S050455
	2000.03-2007.08	Rear Axle Left & Right	Estate FWD B5204T5		Rod/Strut,stabiliser	S050453
	2000.03-2007.08	Front Axle	Estate FWD B5204T5		Steering Boot	540197
	2000.03-2007.08	Front Axle	Estate FWD B5204T5		Steering Rack Bellow Kit	540197S
2.4 (147 kw)	2000.03-2007.08	Front Axle Left Lower	Estate FWD B5244T3		Track Control Arm	S060767
	2000.03-2007.08	Front Axle Right Lower	Estate FWD B5244T3		Track Control Arm	S060768
	2000.03-2007.08	Front Axle Left & Right Lower	Estate FWD B5244T3	Chassis no.from:645618,647149	Ball Joint	S080265
	2000.03-2007.08	Front Axle Left & Right Lower	Estate FWD B5244T3	Chassis no.to:645617,647148	Ball Joint	S080359
	2000.03-2007.08	Front Axle Left & Right Lower	Estate FWD B5244T3		Control Arm Bushing	510796
	2000.03-2007.08	Front Axle Left & Right Lower	Estate FWD B5244T3		Control Arm Bushing	510797
	2000.03-2007.08	Front Axle Left & Right Lower	Estate FWD B5244T3	Quantity:2	Control Arm Bushing	530261
	2000.03-2007.08	Rear Axle Left & Right Lower	Estate FWD B5244T3		Control Arm Bushing	530847
	2000.03-2007.08	Front Axle Left & Right	Estate FWD B5244T3		Tie Rod Axle Joint	S030315
	2000.03-2007.08	Front Axle Left & Right	Estate FWD B5244T3		Tie Rod Axle Joint	S030332
	2000.03-2007.08	Front Axle Left	Estate FWD B5244T3		Tie Rod End	S070516
	2000.03-2007.08	Front Axle Right	Estate FWD B5244T3		Tie Rod End	S070517
	2000.03-2007.08	Front Axle Left & Right	Estate FWD B5244T3		Rod/Strut,stabiliser	S050455
	2000.03-2007.08	Rear Axle Left & Right	Estate FWD B5244T3		Rod/Strut,stabiliser	S050453
	2000.03-2007.08	Front Axle	Estate FWD B5244T3		Steering Boot	540192
	2000.03-2007.08	Front Axle	Estate FWD B5244T3		Steering Boot	540193
	2000.03-2007.08	Front Axle	Estate FWD B5244T3		Steering Boot	540197
	2000.03-2007.08	Front Axle	Estate FWD B5244T3		Steering Rack Bellow Kit	540197S
2.5 (154 kw)	2002.08-2007.08	Front Axle Left Lower	Estate 4WD B5254T2		Track Control Arm	S060767
	2002.08-2007.08	Front Axle Right Lower	Estate 4WD B5254T2		Track Control Arm	S060768
	2002.08-2007.08	Front Axle Left & Right Lower	Estate 4WD B5254T2	Chassis no.from:645618,647149	Ball Joint	S080265
	2002.08-2007.08	Front Axle Left & Right Lower	Estate 4WD B5254T2	Chassis no.to:645617,647148	Ball Joint	S080359
	2002.08-2007.08	Front Axle Left & Right Lower	Estate 4WD B5254T2		Control Arm Bushing	510796
	2002.08-2007.08	Front Axle Left & Right Lower	Estate 4WD B5254T2	Date to:2004.10,Quantity:2	Control Arm Bushing	530261
	2002.08-2007.08	Front Axle Left & Right	Estate 4WD B5254T2	Date from:2004.01	Tie Rod Axle Joint	S030315
	2002.08-2007.08	Front Axle Left & Right	Estate 4WD B5254T2	Date to:2003.12	Tie Rod Axle Joint	S030332
	2002.08-2007.08	Front Axle Left	Estate 4WD B5254T2		Tie Rod End	S070516
	2002.08-2007.08	Front Axle Right	Estate 4WD B5254T2		Tie Rod End	S070517
	2002.08-2007.08	Front Axle Left & Right	Estate 4WD B5254T2		Rod/Strut,stabiliser	S050455
	2002.08-2007.08	Rear Axle Left & Right	Estate 4WD B5254T2		Rod/Strut,stabiliser	S050453
	2002.08-2007.08	Front Axle	Estate 4WD B5254T2		Steering Boot	540197
	2002.08-2007.08	Front Axle	Estate 4WD B5254T2		Steering Rack Bellow Kit	540197S
XC60						
2.0 (177 kw)	2010.09-2017.02	Front Axle Left Lower	SUV FWD B4204T7		Track Control Arm	S061389
	2010.09-2017.02	Front Axle Right Lower	SUV FWD B4204T7		Track Control Arm	S061390
	2010.09-2017.02	Front Axle Left Lower	SUV FWD B4204T7		Control Arm Bushing	530560
	2010.09-2017.02	Front Axle Right Lower	SUV FWD B4204T7		Control Arm Bushing	530559
	2010.09-2017.02	Front Axle Left & Right Lower	SUV FWD B4204T7	Date to:2015	Control Arm Bushing	516450
	2010.09-2017.02	Front Axle Left & Right Lower	SUV FWD B4204T7		Control Arm Bushing	516461
	2010.09-2017.02	Rear Axle Left Centre	SUV FWD B4204T7		Control Arm Bushing	532625
	2010.09-2017.02	Rear Axle Right Centre	SUV FWD B4204T7		Control Arm Bushing	532624
	2010.09-2017.02	Rear Axle Left & Right Centre	SUV FWD B4204T7		Control Arm Bushing	530569
	2010.09-2017.02	Rear Axle Left & Right Upper	SUV FWD B4204T7		Control Arm Bushing	530553
	2010.09-2017.02	Rear Axle Left & Right Lower Inner	SUV FWD B4204T7		Control Arm Bushing	516522
	2010.09-2017.02	Rear Axle Left & Right Lower Outer	SUV FWD B4204T7		Control Arm Bushing	530523
	2010.09-2017.02	Rear Axle Left & Right Lower Outer	SUV FWD B4204T7		Control Arm Bushing	530524
	2010.09-2017.02	Front Axle Left & Right	SUV FWD B4204T7		Tie Rod Axle Joint	S030092
	2010.09-2017.02	Front Axle Left & Right	SUV FWD B4204T7	for vehicles without servotronic steering	Tie Rod Axle Joint	S030724
	2010.09-2017.02	Front Axle Left & Right	SUV FWD B4204T7	for vehicles with servotronic steering	Tie Rod Axle Joint	S031010
	2010.09-2017.02	Front Axle Left & Right	SUV FWD B4204T7		Rod/Strut,stabiliser	S050017
	2010.09-2017.02	Rear Axle Left & Right	SUV FWD B4204T7		Rod/Strut,stabiliser	S050151
	2010.09-2017.02	Rear Axle	SUV FWD B4204T7		Stabiliser Bushing	530508
	2010.09-2017.02	Front Axle	SUV FWD B4204T7	for vehicles without servotronic steering	Steering Rack Bellow Kit	540481S
2.0 (180 kw)	2011.09-2017.02	Front Axle Left Lower	SUV FWD B4204T11/B4204T41		Track Control Arm	S061389
	2011.09-2017.02	Front Axle Right Lower	SUV FWD B4204T11/B4204T41		Track Control Arm	S061390



	 YEAR	FITTING POSITION	BODY STYLE & DRIVE TYPE & ENGINE	REMARKS	PRODUCT	GSP Ref.
VOLVO XC60						
2.0 (180 kw)	2011.09-2017.02	Front Axle Left Lower	SUV FWD B4204T11/B4204T41		Control Arm Bushing	530560
	2011.09-2017.02	Front Axle Right Lower	SUV FWD B4204T11/B4204T41		Control Arm Bushing	530559
	2011.09-2017.02	Front Axle Left & Right Lower	SUV FWD B4204T11/B4204T41	Date to:2015	Control Arm Bushing	516450
	2011.09-2017.02	Front Axle Left & Right Lower	SUV FWD B4204T11/B4204T41		Control Arm Bushing	516461
	2011.09-2017.02	Rear Axle Left Centre	SUV FWD B4204T11/B4204T41		Control Arm Bushing	532625
	2011.09-2017.02	Rear Axle Right Centre	SUV FWD B4204T11/B4204T41		Control Arm Bushing	532624
	2011.09-2017.02	Rear Axle Left & Right Centre	SUV FWD B4204T11/B4204T41		Control Arm Bushing	530569
	2011.09-2017.02	Rear Axle Left & Right Upper	SUV FWD B4204T11/B4204T41		Control Arm Bushing	530553
	2011.09-2017.02	Rear Axle Left & Right Lower Inner	SUV FWD B4204T11/B4204T41		Control Arm Bushing	516522
	2011.09-2017.02	Rear Axle Left & Right Lower Outer	SUV FWD B4204T11/B4204T41		Control Arm Bushing	530523
	2011.09-2017.02	Rear Axle Left & Right Lower Outer	SUV FWD B4204T11/B4204T41		Control Arm Bushing	530524
	2011.09-2017.02	Front Axle Left & Right	SUV FWD B4204T11/B4204T41		Tie Rod Axle Joint	S030092
	2011.09-2017.02	Front Axle Left & Right	SUV FWD B4204T11/B4204T41	Engine code B 4204 T11 for vehicles without servotronic steering	Tie Rod Axle Joint	S030724
	2011.09-2017.02	Front Axle Left & Right	SUV FWD B4204T11/B4204T41	Engine code B 4204 T11 for vehicles with servotronic steering	Tie Rod Axle Joint	S031010
	2011.09-2017.02	Front Axle Left & Right	SUV FWD B4204T11/B4204T41		Rod/Strut, stabiliser	S050017
	2011.09-2017.02	Rear Axle Left & Right	SUV FWD B4204T11/B4204T41		Rod/Strut, stabiliser	S050151
	2011.09-2017.02	Rear Axle	SUV FWD B4204T11/B4204T41		Stabiliser Bushing	530508
2011.09-2017.02	Front Axle	SUV FWD B4204T11/B4204T41		Steering Rack Bellow Kit	540481S	
2.0 (225 kw)	2013.10-2017.02	Front Axle Left Lower	SUV FWD B4204T9		Track Control Arm	S061389
	2013.10-2017.02	Front Axle Right Lower	SUV FWD B4204T9		Track Control Arm	S061390
	2013.10-2017.02	Front Axle Left Lower	SUV FWD B4204T9		Control Arm Bushing	530560
	2013.10-2017.02	Front Axle Right Lower	SUV FWD B4204T9		Control Arm Bushing	530559
	2013.10-2017.02	Front Axle Left & Right Lower	SUV FWD B4204T9	Date to:2015	Control Arm Bushing	516450
	2013.10-2017.02	Front Axle Left & Right Lower	SUV FWD B4204T9		Control Arm Bushing	516461
	2013.10-2017.02	Rear Axle Left Centre	SUV FWD B4204T9		Control Arm Bushing	532625
	2013.10-2017.02	Rear Axle Right Centre	SUV FWD B4204T9		Control Arm Bushing	532624
	2013.10-2017.02	Rear Axle Left & Right Centre	SUV FWD B4204T9		Control Arm Bushing	530569
	2013.10-2017.02	Rear Axle Left & Right Upper	SUV FWD B4204T9		Control Arm Bushing	530553
	2013.10-2017.02	Rear Axle Left & Right Lower Inner	SUV FWD B4204T9		Control Arm Bushing	516522
	2013.10-2017.02	Rear Axle Left & Right Lower Outer	SUV FWD B4204T9		Control Arm Bushing	530523
	2013.10-2017.02	Rear Axle Left & Right Lower Outer	SUV FWD B4204T9		Control Arm Bushing	530524
	2013.10-2017.02	Front Axle Left & Right	SUV FWD B4204T9		Tie Rod Axle Joint	S030092
	2013.10-2017.02	Front Axle Left & Right	SUV FWD B4204T9	for vehicles without servotronic steering	Tie Rod Axle Joint	S030724
	2013.10-2017.02	Front Axle Left & Right	SUV FWD B4204T9	for vehicles with servotronic steering	Tie Rod Axle Joint	S031010
	2013.10-2017.02	Front Axle Left & Right	SUV FWD B4204T9		Rod/Strut, stabiliser	S050017
	2013.10-2017.02	Rear Axle Left & Right	SUV FWD B4204T9		Rod/Strut, stabiliser	S050151
	2013.10-2017.02	Rear Axle	SUV FWD B4204T9		Stabiliser Bushing	530508
	2013.10-2017.02	Front Axle	SUV FWD B4204T9		Steering Rack Bellow Kit	540481S
2.4 (162 kw)	2015.03-2017.02	Front Axle Left Lower	SUV 4WD D5244T20/D5244T22		Track Control Arm	S061389
	2015.03-2017.02	Front Axle Right Lower	SUV 4WD D5244T20/D5244T22		Track Control Arm	S061390
	2015.03-2017.02	Front Axle Left Lower	SUV 4WD D5244T20/D5244T22		Control Arm Bushing	530560
	2015.03-2017.02	Front Axle Right Lower	SUV 4WD D5244T20/D5244T22		Control Arm Bushing	530559
	2015.03-2017.02	Front Axle Left & Right Lower	SUV 4WD D5244T20/D5244T22		Control Arm Bushing	516461
	2015.03-2017.02	Rear Axle Left & Right Centre	SUV 4WD D5244T20/D5244T22		Control Arm Bushing	530569
	2015.03-2017.02	Rear Axle Left & Right Upper	SUV 4WD D5244T20/D5244T22		Control Arm Bushing	530553
	2015.03-2017.02	Rear Axle Left & Right Lower Inner	SUV 4WD D5244T20/D5244T22		Control Arm Bushing	516522
	2015.03-2017.02	Front Axle Left & Right	SUV 4WD D5244T20/D5244T22		Tie Rod Axle Joint	S030092
	2015.03-2017.02	Front Axle Left & Right	SUV 4WD D5244T20/D5244T22	for vehicles without servotronic steering	Tie Rod Axle Joint	S030724
	2015.03-2017.02	Front Axle Left & Right	SUV 4WD D5244T20/D5244T22	for vehicles with servotronic steering	Tie Rod Axle Joint	S031010
	2015.03-2017.02	Front Axle Left & Right	SUV 4WD D5244T20/D5244T22		Rod/Strut, stabiliser	S050017
	2015.03-2017.02	Rear Axle Left & Right	SUV 4WD D5244T20/D5244T22		Rod/Strut, stabiliser	S050151
2015.03-2017.02	Rear Axle	SUV 4WD D5244T20/D5244T22		Stabiliser Bushing	530508	
2015.03-2017.02	Front Axle	SUV 4WD D5244T20/D5244T22		Steering Rack Bellow Kit	540481S	
3.0 (210 kw)	2008.07-2010.03	Front Axle Left Lower	SUV 4WD B6304T2		Track Control Arm	S061389
	2008.07-2010.03	Front Axle Right Lower	SUV 4WD B6304T2		Track Control Arm	S061390
	2008.07-2010.03	Front Axle Left Lower	SUV 4WD B6304T2		Control Arm Bushing	530560
	2008.07-2010.03	Front Axle Right Lower	SUV 4WD B6304T2		Control Arm Bushing	530559
	2008.07-2010.03	Front Axle Left & Right Lower	SUV 4WD B6304T2	Date from:2009	Control Arm Bushing	516450
	2008.07-2010.03	Front Axle Left & Right Lower	SUV 4WD B6304T2		Control Arm Bushing	516461
	2008.07-2010.03	Rear Axle Left Centre	SUV 4WD B6304T2		Control Arm Bushing	532625
	2008.07-2010.03	Rear Axle Right Centre	SUV 4WD B6304T2		Control Arm Bushing	532624
	2008.07-2010.03	Rear Axle Left & Right Centre	SUV 4WD B6304T2		Control Arm Bushing	530569
	2008.07-2010.03	Rear Axle Left & Right Upper	SUV 4WD B6304T2		Control Arm Bushing	530553
	2008.07-2010.03	Rear Axle Left & Right Lower Inner	SUV 4WD B6304T2		Control Arm Bushing	516522

	 YEAR	FITTING POSITION	BODY STYLE & DRIVE TYPE & ENGINE	REMARKS	PRODUCT	GSP Ref.
VOLVO XC60						
3.0 (210 kw)	2008.07-2010.03	Rear Axle Left & Right Lower Outer	SUV 4WD B6304T2		Control Arm Bushing	530523
	2008.07-2010.03	Rear Axle Left & Right Lower Outer	SUV 4WD B6304T2		Control Arm Bushing	530524
	2008.07-2010.03	Front Axle Left & Right	SUV 4WD B6304T2		Tie Rod Axle Joint	S030092
	2008.07-2010.03	Front Axle Left & Right	SUV 4WD B6304T2	for vehicles without servotronic steering	Tie Rod Axle Joint	S030724
	2008.07-2010.03	Front Axle Left & Right	SUV 4WD B6304T2	for vehicles with servotronic steering	Tie Rod Axle Joint	S031010
	2008.07-2010.03	Front Axle Left & Right	SUV 4WD B6304T2		Rod/Strut,stabiliser	S050017
	2008.07-2010.03	Rear Axle Left & Right	SUV 4WD B6304T2		Rod/Strut,stabiliser	S050151
	2008.07-2010.03	Rear Axle	SUV 4WD B6304T2		Stabiliser Bushing	530508
3.0 (224 kw)	2009.03-2017.02	Front Axle Left Lower	SUV 4WD B6304T4		Track Control Arm	S061389
	2009.03-2017.02	Front Axle Right Lower	SUV 4WD B6304T4		Track Control Arm	S061390
	2009.03-2017.02	Front Axle Left Lower	SUV 4WD B6304T4		Control Arm Bushing	530560
	2009.03-2017.02	Front Axle Right Lower	SUV 4WD B6304T4		Control Arm Bushing	530559
	2009.03-2017.02	Front Axle Left & Right Lower	SUV 4WD B6304T4	Date to:2015	Control Arm Bushing	516450
	2009.03-2017.02	Front Axle Left & Right Lower	SUV 4WD B6304T4		Control Arm Bushing	516461
	2009.03-2017.02	Rear Axle Left Centre	SUV 4WD B6304T4		Control Arm Bushing	532625
	2009.03-2017.02	Rear Axle Right Centre	SUV 4WD B6304T4		Control Arm Bushing	532624
	2009.03-2017.02	Rear Axle Left & Right Centre	SUV 4WD B6304T4		Control Arm Bushing	530569
	2009.03-2017.02	Rear Axle Left & Right Upper	SUV 4WD B6304T4		Control Arm Bushing	530553
	2009.03-2017.02	Rear Axle Left & Right Lower Inner	SUV 4WD B6304T4		Control Arm Bushing	516522
	2009.03-2017.02	Rear Axle Left & Right Lower Outer	SUV 4WD B6304T4		Control Arm Bushing	530523
	2009.03-2017.02	Rear Axle Left & Right Lower Outer	SUV 4WD B6304T4		Control Arm Bushing	530524
	2009.03-2017.02	Front Axle Left & Right	SUV 4WD B6304T4		Tie Rod Axle Joint	S030092
	2009.03-2017.02	Front Axle Left & Right	SUV 4WD B6304T4	for vehicles without servotronic steering	Tie Rod Axle Joint	S030724
	2009.03-2017.02	Front Axle Left & Right	SUV 4WD B6304T4	for vehicles with servotronic steering	Tie Rod Axle Joint	S031010
	2009.03-2017.02	Front Axle Left & Right	SUV 4WD B6304T4		Rod/Strut,stabiliser	S050017
	2009.03-2017.02	Rear Axle Left & Right	SUV 4WD B6304T4		Rod/Strut,stabiliser	S050151
	2009.03-2017.02	Rear Axle	SUV 4WD B6304T4		Stabiliser Bushing	530508
	2009.03-2017.02	Front Axle	SUV 4WD B6304T4		Steering Rack Bellow Kit	540481S
XC70						
2.5 (154 kw)	2002.06-2007.10	Front Axle Left Lower	Estate 4WD B5254T2		Track Control Arm	S060315
	2002.06-2007.10	Front Axle Right Lower	Estate 4WD B5254T2		Track Control Arm	S060316
	2002.06-2007.10	Front Axle Left & Right Lower	Estate 4WD B5254T2	Chassis no.from:269746	Ball Joint	S080265
	2002.06-2007.10	Front Axle Left & Right Lower	Estate 4WD B5254T2	Chassis no.to:269745	Ball Joint	S080359
	2002.06-2007.10	Front Axle Left & Right Lower	Estate 4WD B5254T2		Control Arm Bushing	510796
	2002.06-2007.10	Front Axle Left & Right Lower	Estate 4WD B5254T2	Quantity:2	Control Arm Bushing	530261
	2002.06-2007.10	Rear Axle Left Centre	Estate 4WD B5254T2		Control Arm Bushing	532625
	2002.06-2007.10	Rear Axle Right Centre	Estate 4WD B5254T2		Control Arm Bushing	532624
	2002.06-2007.10	Rear Axle Left & Right Lower	Estate 4WD B5254T2		Control Arm Bushing	530847
	2002.06-2007.10	Front Axle Left & Right	Estate 4WD B5254T2	Date from:2004.01	Tie Rod Axle Joint	S030315
	2002.06-2007.10	Front Axle Left & Right	Estate 4WD B5254T2	Date to:2003.12	Tie Rod Axle Joint	S030332
	2002.06-2007.10	Front Axle Left	Estate 4WD B5254T2		Tie Rod End	S070524
	2002.06-2007.10	Front Axle Right	Estate 4WD B5254T2		Tie Rod End	S070523
	2002.06-2007.10	Front Axle Left & Right	Estate 4WD B5254T2		Rod/Strut,stabiliser	S050455
	2002.06-2007.10	Rear Axle Left & Right	Estate 4WD B5254T2		Rod/Strut,stabiliser	S050453
	2002.06-2007.10	Front Axle	Estate 4WD B5254T2		Steering Boot	540192
	2002.06-2007.10	Front Axle	Estate 4WD B5254T2		Steering Boot	540193
	2002.06-2007.10	Front Axle	Estate 4WD B5254T2		Steering Boot	540197
	2002.06-2007.10	Front Axle	Estate 4WD B5254T2		Steering Rack Bellow Kit	540197S
	3.0 (210 kw)	2008.01-2012.11	Front Axle Left Lower	Estate 4WD B6304T2		Control Arm Bushing
2008.01-2012.11		Front Axle Right Lower	Estate 4WD B6304T2		Control Arm Bushing	530559
2008.01-2012.11		Rear Axle Left & Right Upper	Estate 4WD B6304T2		Control Arm Bushing	530553
2008.01-2012.11		Rear Axle Left & Right Lower Inner	Estate 4WD B6304T2		Control Arm Bushing	516522
2008.01-2012.11		Front Axle Left & Right	Estate 4WD B6304T2		Tie Rod Axle Joint	S030092
2008.01-2012.11		Front Axle Left & Right	Estate 4WD B6304T2		Rod/Strut,stabiliser	S050017
2008.01-2012.11		Rear Axle Left & Right	Estate 4WD B6304T2		Rod/Strut,stabiliser	S050151
2008.01-2012.11		Front Axle	Estate 4WD B6304T2		Stabiliser Bushing	517797
2008.01-2012.11		Rear Axle	Estate 4WD B6304T2		Stabiliser Bushing	530508
2008.01-2012.11	Front Axle	Estate 4WD B6304T2		Steering Rack Bellow Kit	540481S	
XC90						
2.5 (154 kw)	2002.06-2014.12	Front Axle Left Lower	SUV 4WD B5254T2		Track Control Arm	S060313
	2002.06-2014.12	Front Axle Right Lower	SUV 4WD B5254T2		Track Control Arm	S060314
	2002.06-2014.12	Rear Axle Left & Right	SUV 4WD B5254T2		Track Control Arm	517681
	2002.06-2014.12	Front Axle Left & Right Lower	SUV 4WD B5254T2		Ball Joint	S080265



	 YEAR	FITTING POSITION	BODY STYLE & DRIVE TYPE & ENGINE	REMARKS	PRODUCT	GSP Ref.
VOLVO XC90						
2.5 (154 kw)	2002.06-2014.12	Front Axle Left & Right Lower	SUV 4WD B5254T2		Control Arm Bushing	519971
	2002.06-2014.12	Front Axle Left & Right Lower	SUV 4WD B5254T2		Control Arm Bushing	530817
	2002.06-2014.12	Front Axle Left & Right	SUV 4WD B5254T2		Tie Rod Axle Joint	S030315
	2002.06-2014.12	Front Axle Left	SUV 4WD B5254T2		Tie Rod End	S070524
	2002.06-2014.12	Front Axle Right	SUV 4WD B5254T2		Tie Rod End	S070523
	2002.06-2014.12	Front Axle Left & Right	SUV 4WD B5254T2		Rod/Strut, stabiliser	S050455
2.9 (200 kw)	2002.06-2014.12	Rear Axle Left & Right	SUV 4WD B5254T2		Rod/Strut, stabiliser	S050453
	2002.06-2005.08	Front Axle Left Lower	SUV 4WD B6294T		Track Control Arm	S060313
	2002.06-2005.08	Front Axle Right Lower	SUV 4WD B6294T		Track Control Arm	S060314
	2002.06-2005.08	Rear Axle Left & Right	SUV 4WD B6294T		Track Control Arm	517681
	2002.06-2005.08	Front Axle Left & Right Lower	SUV 4WD B6294T		Ball Joint	S080265
	2002.06-2005.08	Front Axle Left & Right Lower	SUV 4WD B6294T		Control Arm Bushing	519971
	2002.06-2005.08	Front Axle Left & Right Lower	SUV 4WD B6294T		Control Arm Bushing	530817
	2002.06-2005.08	Front Axle Left & Right	SUV 4WD B6294T		Tie Rod Axle Joint	S030315
	2002.06-2005.08	Front Axle Left	SUV 4WD B6294T		Tie Rod End	S070524
	2002.06-2005.08	Front Axle Right	SUV 4WD B6294T		Tie Rod End	S070523
	2002.06-2005.08	Front Axle Left & Right	SUV 4WD B6294T		Tie Rod End	S070824
	2002.06-2005.08	Front Axle Left & Right	SUV 4WD B6294T		Tie Rod End	S070866
3.2 (175 kw)	2002.06-2005.08	Front Axle Left & Right	SUV 4WD B6294T		Rod/Strut, stabiliser	S050455
	2002.06-2005.08	Rear Axle Left & Right	SUV 4WD B6294T		Rod/Strut, stabiliser	S050453
	2006.04-2014.12	Front Axle Left Lower	SUV 4WD B6324S		Track Control Arm	S060313
	2006.04-2014.12	Front Axle Right Lower	SUV 4WD B6324S		Track Control Arm	S060314
	2006.04-2014.12	Front Axle Left & Right Lower	SUV 4WD B6324S		Ball Joint	S080265
	2006.04-2014.12	Front Axle Left & Right Lower	SUV 4WD B6324S		Control Arm Bushing	519971
	2006.04-2014.12	Front Axle Left & Right Lower	SUV 4WD B6324S		Control Arm Bushing	530817
	2006.04-2014.12	Front Axle Left	SUV 4WD B6324S		Tie Rod End	S070524
	2006.04-2014.12	Front Axle Right	SUV 4WD B6324S		Tie Rod End	S070523
	2006.04-2014.12	Front Axle Left & Right	SUV 4WD B6324S		Rod/Strut, stabiliser	S050455
	2006.04-2014.12	Rear Axle Left & Right	SUV 4WD B6324S		Rod/Strut, stabiliser	S050453
	3.2 (179 kw)	2011.04-2014.12	Front Axle Left & Right Lower	SUV 4WD B6324S5		Ball Joint
2011.04-2014.12		Front Axle Left & Right Lower	SUV 4WD B6324S5		Control Arm Bushing	519971
2011.04-2014.12		Front Axle Left	SUV 4WD B6324S5		Tie Rod End	S070524
2011.04-2014.12		Front Axle Left & Right	SUV 4WD B6324S5		Rod/Strut, stabiliser	S050455
2011.04-2014.12		Rear Axle Left & Right	SUV 4WD B6324S5		Rod/Strut, stabiliser	S050453
4.4 (232 kw)	2004.09-2011.12	Front Axle Left Lower	SUV 4WD B8444S		Track Control Arm	S060313
	2004.09-2011.12	Front Axle Right Lower	SUV 4WD B8444S		Track Control Arm	S060314
	2004.09-2011.12	Front Axle Left & Right Lower	SUV 4WD B8444S		Ball Joint	S080265
	2004.09-2011.12	Front Axle Left & Right Lower	SUV 4WD B8444S		Control Arm Bushing	519971
	2004.09-2011.12	Front Axle Left & Right Lower	SUV 4WD B8444S		Control Arm Bushing	530817
	2004.09-2011.12	Front Axle Left	SUV 4WD B8444S		Tie Rod End	S070524
	2004.09-2011.12	Front Axle Right	SUV 4WD B8444S		Tie Rod End	S070523
	2004.09-2011.12	Front Axle Left & Right	SUV 4WD B8444S		Rod/Strut, stabiliser	S050455
2004.09-2011.12	Rear Axle Left & Right	SUV 4WD B8444S		Rod/Strut, stabiliser	S050453	
VW Amarok						
2.0 (90 kw)	2010.09-2013.10	Front Axle Left Lower	Pick up RWD CDBA/CNFA		Track Control Arm	S061399
	2010.09-2013.10	Front Axle Left Upper	Pick up RWD CDBA/CNFA		Track Control Arm	S061401
	2010.09-2013.10	Front Axle Right Lower	Pick up RWD CDBA/CNFA		Track Control Arm	S061400
	2010.09-2013.10	Front Axle Right Upper	Pick up RWD CDBA/CNFA		Track Control Arm	S061402
	2010.09-2013.10	Front Axle Left & Right Upper	Pick up RWD CDBA/CNFA		Ball Joint	S080998
	2010.09-2013.10	Front Axle Left & Right Lower	Pick up RWD CDBA/CNFA		Control Arm Bushing	510359
	2010.09-2013.10	Front Axle Left & Right Lower	Pick up RWD CDBA/CNFA		Control Arm Bushing	518087
	2010.09-2013.10	Front Axle Left & Right Lower	Pick up RWD CDBA/CNFA		Control Arm Bushing	518088
	2010.09-2013.10	Front Axle Left & Right Upper	Pick up RWD CDBA/CNFA		Control Arm Bushing	518086
	2010.09-2013.10	Front Axle Left	Pick up RWD CDBA/CNFA		Rod Assembly	S100263
	2010.09-2013.10	Front Axle Right	Pick up RWD CDBA/CNFA		Rod Assembly	S100264
	2010.09-2013.10	Front Axle Left & Right	Pick up RWD CDBA/CNFA		Tie Rod Axle Joint	S030010
	2010.09-2013.10	Front Axle Left	Pick up RWD CDBA/CNFA		Tie Rod End	S070036
	2010.09-2013.10	Front Axle Right	Pick up RWD CDBA/CNFA		Tie Rod End	S070037
2010.09-2013.10	Front Axle Left & Right	Pick up RWD CDBA/CNFA		Rod/Strut, stabiliser	S051273	
2.0 (103 kw)	2010.09-2013.10	Front Axle	Pick up RWD CDBA/CNFA		Steering Boot	540440
	2012.05-	Front Axle Left Lower	Pick up 4WD CNFB		Track Control Arm	S061399
	2012.05-	Front Axle Left Upper	Pick up 4WD CNFB		Track Control Arm	S061401
	2012.05-	Front Axle Right Lower	Pick up 4WD CNFB		Track Control Arm	S061400



	 YEAR	FITTING POSITION	BODY STYLE & DRIVE TYPE & ENGINE	REMARKS	PRODUCT	GSP Ref.
VW						
Amarok						
2.0 (103 kw)	2012.05-	Front Axle Right Upper	Pick up 4WD CNFB		Track Control Arm	S061402
	2012.05-	Front Axle Left & Right Upper	Pick up 4WD CNFB		Ball Joint	S080998
	2012.05-	Front Axle Left & Right Lower	Pick up 4WD CNFB		Control Arm Bushing	510359
	2012.05-	Front Axle Left & Right Lower	Pick up 4WD CNFB		Control Arm Bushing	518087
	2012.05-	Front Axle Left & Right Lower	Pick up 4WD CNFB		Control Arm Bushing	518088
	2012.05-	Front Axle Left & Right Upper	Pick up 4WD CNFB		Control Arm Bushing	518086
	2012.05-	Front Axle Left	Pick up 4WD CNFB		Rod Assembly	S100263
	2012.05-	Front Axle Right	Pick up 4WD CNFB		Rod Assembly	S100264
	2012.05-	Front Axle Left & Right	Pick up 4WD CNFB		Tie Rod Axle Joint	S030010
	2012.05-	Front Axle Left	Pick up 4WD CNFB		Tie Rod End	S070036
	2012.05-	Front Axle Right	Pick up 4WD CNFB		Tie Rod End	S070037
	2012.05-	Front Axle Left & Right	Pick up 4WD CNFB		Rod/Strut, stabiliser	S051273
	2012.05-	Front Axle	Pick up 4WD CNFB		Steering Boot	540440
	2012.06-	Front Axle Left Lower	Pick up RWD CNFB		Track Control Arm	S061399
	2012.06-	Front Axle Left Upper	Pick up RWD CNFB		Track Control Arm	S061401
	2012.06-	Front Axle Right Lower	Pick up RWD CNFB		Track Control Arm	S061400
	2012.06-	Front Axle Right Upper	Pick up RWD CNFB		Track Control Arm	S061402
	2012.06-	Front Axle Left & Right Upper	Pick up RWD CNFB		Ball Joint	S080998
	2012.06-	Front Axle Left & Right Lower	Pick up RWD CNFB		Control Arm Bushing	510359
	2012.06-	Front Axle Left & Right Lower	Pick up RWD CNFB		Control Arm Bushing	518087
	2012.06-	Front Axle Left & Right Lower	Pick up RWD CNFB		Control Arm Bushing	518088
	2012.06-	Front Axle Left & Right Upper	Pick up RWD CNFB		Control Arm Bushing	518086
	2012.06-	Front Axle Left	Pick up RWD CNFB		Rod Assembly	S100263
	2012.06-	Front Axle Right	Pick up RWD CNFB		Rod Assembly	S100264
	2012.06-	Front Axle Left & Right	Pick up RWD CNFB		Tie Rod Axle Joint	S030010
	2012.06-	Front Axle Left	Pick up RWD CNFB		Tie Rod End	S070036
	2012.06-	Front Axle Right	Pick up RWD CNFB		Tie Rod End	S070037
	2012.06-	Front Axle Left & Right	Pick up RWD CNFB		Rod/Strut, stabiliser	S051273
	2012.06-	Front Axle	Pick up RWD CNFB		Steering Boot	540440
2.0 (120 kw)	2009.11-2012.08	Front Axle Left Lower	Pick up 4WD CDCA		Track Control Arm	S061399
	2009.11-2012.08	Front Axle Left Upper	Pick up 4WD CDCA		Track Control Arm	S061401
	2009.11-2012.08	Front Axle Right Lower	Pick up 4WD CDCA		Track Control Arm	S061400
	2009.11-2012.08	Front Axle Right Upper	Pick up 4WD CDCA		Track Control Arm	S061402
	2009.11-2012.08	Front Axle Left & Right Upper	Pick up 4WD CDCA		Ball Joint	S080998
	2009.11-2012.08	Front Axle Left & Right Lower	Pick up 4WD CDCA		Control Arm Bushing	510359
	2009.11-2012.08	Front Axle Left & Right Lower	Pick up 4WD CDCA		Control Arm Bushing	518087
	2009.11-2012.08	Front Axle Left & Right Lower	Pick up 4WD CDCA		Control Arm Bushing	518088
	2009.11-2012.08	Front Axle Left & Right Upper	Pick up 4WD CDCA		Control Arm Bushing	518086
	2009.11-2012.08	Front Axle Left	Pick up 4WD CDCA		Rod Assembly	S100263
	2009.11-2012.08	Front Axle Right	Pick up 4WD CDCA		Rod Assembly	S100264
	2009.11-2012.08	Front Axle Left & Right	Pick up 4WD CDCA		Tie Rod Axle Joint	S030010
	2009.11-2012.08	Front Axle Left	Pick up 4WD CDCA		Tie Rod End	S070036
	2009.11-2012.08	Front Axle Right	Pick up 4WD CDCA		Tie Rod End	S070037
	2009.11-2012.08	Front Axle Left & Right	Pick up 4WD CDCA		Rod/Strut, stabiliser	S051273
	2009.11-2012.08	Front Axle	Pick up 4WD CDCA		Steering Boot	540440
2.0 (132 kw)	2011.11-	Front Axle Left Lower	Pick up 4WD CNEA/CSHA		Track Control Arm	S061399
	2011.11-	Front Axle Left Upper	Pick up 4WD CNEA/CSHA		Track Control Arm	S061401
	2011.11-	Front Axle Right Lower	Pick up 4WD CNEA/CSHA		Track Control Arm	S061400
	2011.11-	Front Axle Right Upper	Pick up 4WD CNEA/CSHA		Track Control Arm	S061402
	2011.11-	Front Axle Left & Right Upper	Pick up 4WD CNEA/CSHA		Ball Joint	S080998
	2011.11-	Front Axle Left & Right Lower	Pick up 4WD CNEA/CSHA		Control Arm Bushing	510359
	2011.11-	Front Axle Left & Right Lower	Pick up 4WD CNEA/CSHA		Control Arm Bushing	518087
	2011.11-	Front Axle Left & Right Lower	Pick up 4WD CNEA/CSHA		Control Arm Bushing	518088
	2011.11-	Front Axle Left & Right Upper	Pick up 4WD CNEA/CSHA		Control Arm Bushing	518086
	2011.11-	Front Axle Left	Pick up 4WD CNEA/CSHA		Rod Assembly	S100263
	2011.11-	Front Axle Right	Pick up 4WD CNEA/CSHA		Rod Assembly	S100264
	2011.11-	Front Axle Left & Right	Pick up 4WD CNEA/CSHA		Tie Rod Axle Joint	S030010
	2011.11-	Front Axle Left	Pick up 4WD CNEA/CSHA		Tie Rod End	S070036
	2011.11-	Front Axle Right	Pick up 4WD CNEA/CSHA		Tie Rod End	S070037
	2011.11-	Front Axle Left & Right	Pick up 4WD CNEA/CSHA		Rod/Strut, stabiliser	S051273
	2011.11-	Front Axle	Pick up 4WD CNEA/CSHA		Steering Boot	540440
3.0 (165 kw)	2016.06-	Front Axle Left Lower	Pick up 4WD DDXC		Track Control Arm	S061399
	2016.06-	Front Axle Left Upper	Pick up 4WD DDXC		Track Control Arm	S061401
	2016.06-	Front Axle Right Lower	Pick up 4WD DDXC		Track Control Arm	S061400



	 YEAR	FITTING POSITION	BODY STYLE & DRIVE TYPE & ENGINE	REMARKS	PRODUCT	GSP Ref.
VW						
Amarok						
3.0 (165 kw)	2016.06-	Front Axle Right Upper	Pick up 4WD DDXC		Track Control Arm	S061402
	2016.06-	Front Axle Left & Right Upper	Pick up 4WD DDXC		Ball Joint	S080998
	2016.06-	Front Axle Left & Right Lower	Pick up 4WD DDXC		Control Arm Bushing	510359
	2016.06-	Front Axle Left & Right Upper	Pick up 4WD DDXC		Control Arm Bushing	518086
	2016.06-	Front Axle Left	Pick up 4WD DDXC		Tie Rod End	S070036
	2016.06-	Front Axle Right	Pick up 4WD DDXC		Tie Rod End	S070037
	2016.06-	Front Axle Left & Right	Pick up 4WD DDXC		Rod/Strut, stabiliser	S051273
3.0 (190 kw)	2018.05-	Front Axle Left Lower	Pick up 4WD DDXE		Track Control Arm	S061399
	2018.05-	Front Axle Right Lower	Pick up 4WD DDXE		Track Control Arm	S061400
	2018.05-	Front Axle Left & Right Upper	Pick up 4WD DDXE		Ball Joint	S080998
	2018.05-	Front Axle Left & Right Lower	Pick up 4WD DDXE		Control Arm Bushing	510359
	2018.05-	Front Axle Left & Right Upper	Pick up 4WD DDXE		Control Arm Bushing	518086
	2018.05-	Front Axle Left	Pick up 4WD DDXE		Tie Rod End	S070036
	2018.05-	Front Axle Right	Pick up 4WD DDXE		Tie Rod End	S070037
2018.05-	Front Axle Left & Right	Pick up 4WD DDXE		Rod/Strut, stabiliser	S051273	
Beetle						
1.5 (32 kw)	1966.08-1970.07	Front Axle Left & Right Lower Outer	Saloon RWD H		Track Control Arm	S060054
	1966.08-1970.07	Front Axle Left & Right Lower	Saloon RWD H		Ball Joint	S080247
	1966.08-1970.07	Front Axle Left & Right Upper	Saloon RWD H		Ball Joint	S080246
	1966.08-1970.07	Front Axle Left	Saloon RWD H		Tie Rod End	S070499
	1966.08-1970.07	Front Axle Left	Saloon RWD H		Tie Rod End	S070732
	1966.08-1970.07	Front Axle Right	Saloon RWD H		Tie Rod End	S070495
	1966.08-1970.07	Front Axle Right	Saloon RWD H		Tie Rod End	S070498
1.8 (125 kw)	2013.12-2016.12	Rear Axle Right Lower Inner	Convertible FWD CPKA/CPRA		Track Control Arm	510350
	2013.12-2016.12	Front Axle Left Lower	Convertible FWD CPKA/CPRA		Ball Joint	S080013
	2013.12-2016.12	Front Axle Left & Right	Convertible FWD CPKA/CPRA		Rod/Strut, stabiliser	S050040
	2013.12-2016.12	Rear Axle Left & Right	Convertible FWD CPKA/CPRA		Rod/Strut, stabiliser	S050035
	2013.12-2016.12	Rear Axle	Convertible FWD CPKA/CPRA		Stabiliser Bushing	530199
	2013.12-2016.12	Front Axle	Convertible FWD CPKA/CPRA		Steering Boot	541209
	2013.12-2016.12	Front Axle	Convertible FWD CPKA/CPRA		Steering Rack Bellow Kit	541209S
	2013.12-2017.07	Rear Axle Right Lower Inner	Hatchback FWD CPKA/CPRA		Track Control Arm	510350
	2013.12-2017.07	Front Axle Left Lower	Hatchback FWD CPKA/CPRA		Ball Joint	S080013
	2013.12-2017.07	Front Axle Left & Right	Hatchback FWD CPKA/CPRA		Rod/Strut, stabiliser	S050040
	2013.12-2017.07	Rear Axle Left & Right	Hatchback FWD CPKA/CPRA		Rod/Strut, stabiliser	S050035
	2013.12-2017.07	Rear Axle	Hatchback FWD CPKA/CPRA		Stabiliser Bushing	530199
	2013.12-2017.07	Front Axle	Hatchback FWD CPKA/CPRA		Steering Boot	541209
2013.12-2017.07	Front Axle	Hatchback FWD CPKA/CPRA		Steering Rack Bellow Kit	541209S	
1.9 (66 kw)	2002.09-2004.06	Front Axle Left Lower	Convertible FWD ALH		Track Control Arm	S060339
	2002.09-2004.06	Front Axle Right Lower	Convertible FWD ALH		Track Control Arm	S060340
	2002.09-2004.06	Front Axle Left & Right Lower	Convertible FWD ALH		Track Control Arm	S061643
	2002.09-2004.06	Front Axle Left & Right Lower	Convertible FWD ALH		Control Arm Bushing	510084
	2002.09-2004.06	Front Axle Left	Convertible FWD ALH		Rod Assembly	S100011
	2002.09-2004.06	Front Axle Left	Convertible FWD ALH		Rod Assembly	S100015
	2002.09-2004.06	Front Axle Right	Convertible FWD ALH		Rod Assembly	S100010
	2002.09-2004.06	Front Axle Right	Convertible FWD ALH		Rod Assembly	S100016
	2002.09-2004.06	Front Axle Left & Right	Convertible FWD ALH		Tie Rod Axle Joint	S030011
	2002.09-2004.06	Front Axle Left	Convertible FWD ALH		Tie Rod End	S070039
	2002.09-2004.06	Front Axle Left	Convertible FWD ALH		Tie Rod End	S071340
	2002.09-2004.06	Front Axle Right	Convertible FWD ALH		Tie Rod End	S070040
	2002.09-2004.06	Front Axle Right	Convertible FWD ALH		Tie Rod End	S071341
	2002.09-2004.06	Front Axle Left & Right	Convertible FWD ALH		Rod/Strut, stabiliser	510068
	2002.09-2004.06	Front Axle Left & Right	Convertible FWD ALH		Rod/Strut, stabiliser	510068S
	2002.09-2004.06	Front Axle	Convertible FWD ALH		Stabiliser Bushing	510066
	2002.09-2004.06	Front Axle	Convertible FWD ALH		Stabiliser Bushing	510232
2002.09-2004.06	Front Axle	Convertible FWD ALH		Stabiliser Bushing	517166	
2.0 (147 kw)	2011.04-2016.07	Front Axle Left Lower	Hatchback FWD CBFA/CCTA/CCZA		Track Control Arm	S061492
	2011.04-2016.07	Front Axle Right Lower	Hatchback FWD CBFA/CCTA/CCZA		Track Control Arm	S061493
	2011.04-2016.07	Rear Axle Left Centre	Hatchback FWD CBFA/CCTA/CCZA		Track Control Arm	S061407
	2011.04-2016.07	Rear Axle Right Centre	Hatchback FWD CBFA/CCTA/CCZA		Track Control Arm	S061408
	2011.04-2016.07	Rear Axle Left & Right Lower Outer	Hatchback FWD CBFA/CCTA/CCZA		Track Control Arm	S061468
	2011.04-2016.07	Front Axle Left Lower	Hatchback FWD CBFA/CCTA/CCZA		Ball Joint	S080013
	2011.04-2016.07	Front Axle Right Lower	Hatchback FWD CBFA/CCTA/CCZA		Ball Joint	S080012
	2011.04-2016.07	Front Axle Left & Right Lower	Hatchback FWD CBFA/CCTA/CCZA		Control Arm Bushing	510361
	2011.04-2016.07	Front Axle Left & Right Lower	Hatchback FWD CBFA/CCTA/CCZA		Control Arm Bushing	531423



	 YEAR	FITTING POSITION	BODY STYLE & DRIVE TYPE & ENGINE	REMARKS	PRODUCT	GSP Ref.
VW Beetle						
2.0 (147 kw)	2011.04-2016.07	Rear Axle Left & Right Upper	Hatchback FWD CBFA/CCTA/CCZA		Control Arm Bushing	516372
	2011.04-2016.07	Rear Axle Left & Right Upper	Hatchback FWD CBFA/CCTA/CCZA		Control Arm Bushing	516408
	2011.04-2016.07	Rear Axle Left & Right Lower Inner	Hatchback FWD CBFA/CCTA/CCZA		Control Arm Bushing	510351
	2011.04-2016.07	Rear Axle Left & Right Lower Inner	Hatchback FWD CBFA/CCTA/CCZA		Control Arm Bushing	510352
	2011.04-2016.07	Rear Axle Left & Right Lower Outer	Hatchback FWD CBFA/CCTA/CCZA		Control Arm Bushing	516370
	2011.04-2016.07	Front Axle Left & Right	Hatchback FWD CBFA/CCTA/CCZA		Tie Rod Axle Joint	S030009
	2011.04-2016.07	Front Axle Left & Right	Hatchback FWD CBFA/CCTA/CCZA		Tie Rod Axle Joint	S030928
	2011.04-2016.07	Front Axle Left	Hatchback FWD CBFA/CCTA/CCZA		Tie Rod End	S070032
	2011.04-2016.07	Front Axle Right	Hatchback FWD CBFA/CCTA/CCZA		Tie Rod End	S070033
	2011.04-2016.07	Front Axle Left & Right	Hatchback FWD CBFA/CCTA/CCZA		Rod/Strut, stabiliser	S050040
	2011.04-2016.07	Rear Axle Left & Right	Hatchback FWD CBFA/CCTA/CCZA		Rod/Strut, stabiliser	S050035
	2011.04-2016.07	Rear Axle	Hatchback FWD CBFA/CCTA/CCZA		Stabiliser Bushing	530199
2.0 (155 kw)	2012.12-2016.07	Front Axle Left Lower	Hatchback FWD CPLA/CPPA		Track Control Arm	S061492
	2012.12-2016.07	Front Axle Right Lower	Hatchback FWD CPLA/CPPA		Track Control Arm	S061493
	2012.12-2016.07	Rear Axle Left Centre	Hatchback FWD CPLA/CPPA		Track Control Arm	S061407
	2012.12-2016.07	Rear Axle Left Lower Inner	Hatchback FWD CPLA/CPPA		Track Control Arm	510349
	2012.12-2016.07	Rear Axle Right Centre	Hatchback FWD CPLA/CPPA		Track Control Arm	S061408
	2012.12-2016.07	Rear Axle Right Lower Inner	Hatchback FWD CPLA/CPPA		Track Control Arm	510350
	2012.12-2016.07	Rear Axle Left & Right Lower Outer	Hatchback FWD CPLA/CPPA		Track Control Arm	S061468
	2012.12-2016.07	Front Axle Left Lower	Hatchback FWD CPLA/CPPA		Ball Joint	S080013
	2012.12-2016.07	Front Axle Right Lower	Hatchback FWD CPLA/CPPA		Ball Joint	S080012
	2012.12-2016.07	Front Axle Left & Right Lower	Hatchback FWD CPLA/CPPA		Control Arm Bushing	510361
	2012.12-2016.07	Front Axle Left & Right Lower	Hatchback FWD CPLA/CPPA		Control Arm Bushing	531423
	2012.12-2016.07	Rear Axle Left & Right Upper	Hatchback FWD CPLA/CPPA		Control Arm Bushing	516372
	2012.12-2016.07	Rear Axle Left & Right Upper	Hatchback FWD CPLA/CPPA		Control Arm Bushing	516408
	2012.12-2016.07	Rear Axle Left & Right Lower Inner	Hatchback FWD CPLA/CPPA		Control Arm Bushing	510351
	2012.12-2016.07	Rear Axle Left & Right Lower Inner	Hatchback FWD CPLA/CPPA		Control Arm Bushing	510352
	2012.12-2016.07	Rear Axle Left & Right Lower Outer	Hatchback FWD CPLA/CPPA		Control Arm Bushing	516370
	2012.12-2016.07	Front Axle Left & Right	Hatchback FWD CPLA/CPPA		Tie Rod Axle Joint	S030009
	2012.12-2016.07	Front Axle Left & Right	Hatchback FWD CPLA/CPPA		Tie Rod Axle Joint	S030928
	2012.12-2016.07	Front Axle Left	Hatchback FWD CPLA/CPPA		Tie Rod End	S070032
	2012.12-2016.07	Front Axle Right	Hatchback FWD CPLA/CPPA		Tie Rod End	S070033
	2012.12-2016.07	Front Axle Left & Right	Hatchback FWD CPLA/CPPA		Rod/Strut, stabiliser	S050040
	2012.12-2016.07	Rear Axle Left & Right	Hatchback FWD CPLA/CPPA		Rod/Strut, stabiliser	S050035
	2012.12-2016.07	Rear Axle	Hatchback FWD CPLA/CPPA		Stabiliser Bushing	530199
	2.0 (157 kw)	2013.01-2016.07	Front Axle Left Lower	Convertible FWD CBFA/CCTA		Ball Joint
2013.01-2016.07		Front Axle Left & Right	Convertible FWD CBFA/CCTA		Rod/Strut, stabiliser	S050040
2013.01-2016.07		Rear Axle Left & Right	Convertible FWD CBFA/CCTA		Rod/Strut, stabiliser	S050035
2013.01-2016.07		Rear Axle	Convertible FWD CBFA/CCTA		Stabiliser Bushing	530199
2013.01-2016.07		Front Axle	Convertible FWD CBFA/CCTA		Steering Boot	541209
2013.01-2016.07		Front Axle	Convertible FWD CBFA/CCTA		Steering Rack Bellow Kit	541209S
Bjalla						
2.0 (147 kw)	2011.04-2016.07	Front Axle Left Lower	Hatchback FWD CBFA/CCTA/CCZA		Track Control Arm	S061492
	2011.04-2016.07	Front Axle Right Lower	Hatchback FWD CBFA/CCTA/CCZA		Track Control Arm	S061493
	2011.04-2016.07	Rear Axle Left Centre	Hatchback FWD CBFA/CCTA/CCZA		Track Control Arm	S061407
	2011.04-2016.07	Rear Axle Right Centre	Hatchback FWD CBFA/CCTA/CCZA		Track Control Arm	S061408
	2011.04-2016.07	Rear Axle Left & Right Lower Outer	Hatchback FWD CBFA/CCTA/CCZA		Track Control Arm	S061468
	2011.04-2016.07	Front Axle Left Lower	Hatchback FWD CBFA/CCTA/CCZA		Ball Joint	S080013
	2011.04-2016.07	Front Axle Right Lower	Hatchback FWD CBFA/CCTA/CCZA		Ball Joint	S080012
	2011.04-2016.07	Front Axle Left & Right Lower	Hatchback FWD CBFA/CCTA/CCZA		Control Arm Bushing	510361
	2011.04-2016.07	Front Axle Left & Right Lower	Hatchback FWD CBFA/CCTA/CCZA		Control Arm Bushing	531423
	2011.04-2016.07	Rear Axle Left & Right Upper	Hatchback FWD CBFA/CCTA/CCZA		Control Arm Bushing	516372
	2011.04-2016.07	Rear Axle Left & Right Upper	Hatchback FWD CBFA/CCTA/CCZA		Control Arm Bushing	516408
	2011.04-2016.07	Rear Axle Left & Right Lower Inner	Hatchback FWD CBFA/CCTA/CCZA		Control Arm Bushing	510351
	2011.04-2016.07	Rear Axle Left & Right Lower Inner	Hatchback FWD CBFA/CCTA/CCZA		Control Arm Bushing	510352
	2011.04-2016.07	Rear Axle Left & Right Lower Outer	Hatchback FWD CBFA/CCTA/CCZA		Control Arm Bushing	516370
	2011.04-2016.07	Front Axle Left & Right	Hatchback FWD CBFA/CCTA/CCZA		Tie Rod Axle Joint	S030009
	2011.04-2016.07	Front Axle Left & Right	Hatchback FWD CBFA/CCTA/CCZA		Tie Rod Axle Joint	S030928
	2011.04-2016.07	Front Axle Left	Hatchback FWD CBFA/CCTA/CCZA		Tie Rod End	S070032
	2011.04-2016.07	Front Axle Right	Hatchback FWD CBFA/CCTA/CCZA		Tie Rod End	S070033
	2011.04-2016.07	Front Axle Left & Right	Hatchback FWD CBFA/CCTA/CCZA		Rod/Strut, stabiliser	S050040
	2011.04-2016.07	Rear Axle Left & Right	Hatchback FWD CBFA/CCTA/CCZA		Rod/Strut, stabiliser	S050035
	2011.04-2016.07	Rear Axle	Hatchback FWD CBFA/CCTA/CCZA		Stabiliser Bushing	530199



	 YEAR	FITTING POSITION	BODY STYLE & DRIVE TYPE & ENGINE	REMARKS	PRODUCT	GSP Ref.
VW						
Bora						
2.0 (85 kw)	1998.09-2014.12	Front Axle Left Lower	Saloon FWD APK/AQY/AZG/AZJ/CBPA	Engine code:ADYAPK,AEI,AGZ,BBW,AZJ,BEV,AVH,AZH	Track Control Arm	S060339
	1998.09-2014.12	Front Axle Left Lower	Saloon FWD APK/AQY/AZG/AZJ/CBPA		Track Control Arm	S060339
	1998.09-2014.12	Front Axle Right Lower	Saloon FWD APK/AQY/AZG/AZJ/CBPA	Engine code:ADYAPK,AEI,AGZ,BBW,AZJ,BEV,AVH,AZH	Track Control Arm	S060340
	1998.09-2014.12	Front Axle Right Lower	Saloon FWD APK/AQY/AZG/AZJ/CBPA		Track Control Arm	S060340
	1998.09-2014.12	Front Axle Left & Right Lower	Saloon FWD APK/AQY/AZG/AZJ/CBPA		Track Control Arm	S061643
	1998.09-2014.12	Front Axle Left & Right Lower	Saloon FWD APK/AQY/AZG/AZJ/CBPA		Track Control Arm	S061643
	1998.09-2014.12	Front Axle Left Lower	Saloon FWD APK/AQY/AZG/AZJ/CBPA		Ball Joint	S080016
	1998.09-2014.12	Front Axle Right Lower	Saloon FWD APK/AQY/AZG/AZJ/CBPA		Ball Joint	S080017
	1998.09-2014.12	Front Axle Left & Right Lower	Saloon FWD APK/AQY/AZG/AZJ/CBPA		Control Arm Bushing	510065
	1998.09-2014.12	Front Axle Left & Right Lower	Saloon FWD APK/AQY/AZG/AZJ/CBPA		Control Arm Bushing	510084
	1998.09-2014.12	Front Axle	Saloon FWD APK/AQY/AZG/AZJ/CBPA		Suspension Repair Kit	S990016SK
	1998.09-2014.12	Front Axle Left	Saloon FWD APK/AQY/AZG/AZJ/CBPA		Rod Assembly	S100011
	1998.09-2014.12	Front Axle Right	Saloon FWD APK/AQY/AZG/AZJ/CBPA		Rod Assembly	S100010
	1998.09-2014.12	Front Axle Left & Right	Saloon FWD APK/AQY/AZG/AZJ/CBPA		Tie Rod Axle Joint	S030011
	1998.09-2014.12	Front Axle Left	Saloon FWD APK/AQY/AZG/AZJ/CBPA		Tie Rod End	S071340
	1998.09-2014.12	Front Axle Right	Saloon FWD APK/AQY/AZG/AZJ/CBPA		Tie Rod End	S071341
	1998.09-2014.12	Front Axle Right	Saloon FWD APK/AQY/AZG/AZJ/CBPA		Rod/Strut, stabiliser	S050036
	1998.09-2014.12	Front Axle Left & Right	Saloon FWD APK/AQY/AZG/AZJ/CBPA	Engine Code:ADYAPK,AEI,AGZ,BBW,AZJ,BEV,AVH,AZH	Rod/Strut, stabiliser	510067
	1998.09-2014.12	Front Axle Left & Right	Saloon FWD APK/AQY/AZG/AZJ/CBPA	Engine Code:ADYAPK,AEI,AGZ,BBW,AZJ,BEV,AVH,AZH	Rod/Strut, stabiliser	510067S
	1998.09-2014.12	Front Axle Left & Right	Saloon FWD APK/AQY/AZG/AZJ/CBPA		Rod/Strut, stabiliser	510068
	1998.09-2014.12	Front Axle Left & Right	Saloon FWD APK/AQY/AZG/AZJ/CBPA		Rod/Strut, stabiliser	510068S
	1998.09-2014.12	Front Axle Left & Right	Saloon FWD APK/AQY/AZG/AZJ/CBPA		Rod/Strut, stabiliser	512249
	1998.09-2014.12	Front Axle Left & Right	Saloon FWD APK/AQY/AZG/AZJ/CBPA	Date from:2000.11	Rod/Strut, stabiliser	S050052
	1998.09-2014.12	Front Axle	Saloon FWD APK/AQY/AZG/AZJ/CBPA		Stabiliser Bushing	510232
	1998.09-2014.12	Front Axle	Saloon FWD APK/AQY/AZG/AZJ/CBPA	Engine Code:ADYAPK,AEI,AGZ,BBW,AZJ,BEV,AVH,AZH	Stabiliser Bushing	510316
	1998.09-2014.12	Front Axle	Saloon FWD APK/AQY/AZG/AZJ/CBPA		Stabiliser Bushing	517166
	1998.09-2014.12	Front Axle	Saloon FWD APK/AQY/AZG/AZJ/CBPA		Steering Boot	540227
	1998.09-2014.12	Front Axle	Saloon FWD APK/AQY/AZG/AZJ/CBPA		Stabiliser Bushing Kit	510066S
Caddy						
1.6 (65 kw)	1996.04-2004.12	Front Axle Left & Right Lower	MPV Van FWD UVC		Control Arm Bushing	510084
Campmobile						
2.4 (55 kw)	1997.05-2002.04	Front Axle Left Lower	BUS FWD AJA		Track Control Arm	S061409
	1997.05-2002.04	Front Axle Right Lower	BUS FWD AJA		Track Control Arm	S061410
	1997.05-2002.04	Front Axle Left & Right Lower	BUS FWD AJA		Ball Joint	S080245
	1997.05-2002.04	Front Axle Left & Right Upper	BUS FWD AJA		Ball Joint	S080262
	1997.05-2002.04	Front Axle Left & Right Lower	BUS FWD AJA		Control Arm Bushing	510158
	1997.05-2002.04	Front Axle Left & Right Lower	BUS FWD AJA		Control Arm Bushing	510159
	1997.05-2002.04	Front Axle Left & Right Lower	BUS FWD AJA		Control Arm Bushing	510255
	1997.05-2002.04	Front Axle Left & Right Upper	BUS FWD AJA		Control Arm Bushing	510155
	1997.05-2002.04	Front Axle Left & Right Upper	BUS FWD AJA		Control Arm Bushing	510156
	1997.05-2002.04	Rear Axle Left & Right Lower	BUS FWD AJA		Control Arm Bushing	530212
	1997.05-2002.04	Front Axle Left	BUS FWD AJA		Tie Rod End	S070493
	1997.05-2002.04	Front Axle Right	BUS FWD AJA		Tie Rod End	S071631
	1997.05-2002.04	Front Axle Left & Right	BUS FWD AJA		Rod/Strut, stabiliser	520525
	1997.05-2002.04	Front Axle Left & Right	BUS FWD AJA		Rod/Strut, stabiliser	S050447
	1997.05-2002.04	Front Axle	BUS FWD AJA		Stabiliser Bushing	510160
	1997.05-2002.04	Front Axle	BUS FWD AJA	for vehicles without heavy duty suspension	Stabiliser Bushing	510286
	1997.05-2002.04	Front Axle	BUS FWD AJA		Stabiliser Bushing	517812
	1997.05-2002.04	Front Axle	BUS FWD AJA		Stabiliser Bushing	530221
	1997.05-2002.04	Front Axle Left & Right	BUS FWD AJA		Steering Bushing	510320
Caravelle						
2.4 (55 kw)	1997.04-2003.06	Front Axle Left Lower	BUS FWD AJA		Track Control Arm	S061409
	1997.04-2003.06	Front Axle Right Lower	BUS FWD AJA		Track Control Arm	S061410
	1997.04-2003.06	Front Axle Left & Right Lower	BUS FWD AJA		Ball Joint	S080245
	1997.04-2003.06	Front Axle Left & Right Upper	BUS FWD AJA		Ball Joint	S080262
	1997.04-2003.06	Front Axle Left & Right Lower	BUS FWD AJA		Control Arm Bushing	510158
	1997.04-2003.06	Front Axle Left & Right Lower	BUS FWD AJA		Control Arm Bushing	510159
	1997.04-2003.06	Front Axle Left & Right Lower	BUS FWD AJA		Control Arm Bushing	510255
	1997.04-2003.06	Front Axle Left & Right Upper	BUS FWD AJA		Control Arm Bushing	510155
	1997.04-2003.06	Front Axle Left & Right Upper	BUS FWD AJA		Control Arm Bushing	510156
	1997.04-2003.06	Rear Axle Left & Right Lower	BUS FWD AJA		Control Arm Bushing	530212
	1997.04-2003.06	Front Axle Left	BUS FWD AJA		Tie Rod End	S070493
	1997.04-2003.06	Front Axle Right	BUS FWD AJA		Tie Rod End	S071631
	1997.04-2003.06	Front Axle Left & Right	BUS FWD AJA		Rod/Strut, stabiliser	520525



	 YEAR	FITTING POSITION	BODY STYLE & DRIVE TYPE & ENGINE	REMARKS	PRODUCT	GSP Ref.
VW						
Caravelle						
2.4 (55 kw)	1997.04-2003.06	Front Axle Left & Right	BUS FWD AJA		Rod/Strut, stabiliser	S050447
	1997.04-2003.06	Front Axle	BUS FWD AJA		Stabiliser Bushing	510160
	1997.04-2003.06	Front Axle	BUS FWD AJA	for vehicles without heavy duty suspension	Stabiliser Bushing	510286
	1997.04-2003.06	Front Axle	BUS FWD AJA		Stabiliser Bushing	517812
	1997.04-2003.06	Front Axle	BUS FWD AJA		Stabiliser Bushing	530221
	1997.04-2003.06	Front Axle Left & Right	BUS FWD AJA		Steering Bushing	510320
CC						
2.0 (155 kw)	2011.11-2016.12	Front Axle Left Lower	Coupe FWD CCZB		Track Control Arm	S061577
	2011.11-2016.12	Front Axle Right Lower	Coupe FWD CCZB		Track Control Arm	S061578
	2011.11-2016.12	Front Axle Left & Right Lower	Coupe FWD CCZB		Track Control Arm	S060762
	2011.11-2016.12	Rear Axle Left Centre	Coupe FWD CCZB		Track Control Arm	S063095
	2011.11-2016.12	Rear Axle Left Lower Inner	Coupe FWD CCZB		Track Control Arm	510349
	2011.11-2016.12	Rear Axle Right Centre	Coupe FWD CCZB		Track Control Arm	S063094
	2011.11-2016.12	Rear Axle Right Lower Inner	Coupe FWD CCZB		Track Control Arm	510350
	2011.11-2016.12	Rear Axle Left & Right Lower Outer	Coupe FWD CCZB		Track Control Arm	S061468
	2011.11-2016.12	Front Axle Left Lower	Coupe FWD CCZB		Ball Joint	S080258
	2011.11-2016.12	Front Axle Right Lower	Coupe FWD CCZB		Ball Joint	S080259
	2011.11-2016.12	Front Axle Left & Right Lower	Coupe FWD CCZB		Control Arm Bushing	510356
	2011.11-2016.12	Front Axle Left & Right Lower	Coupe FWD CCZB		Control Arm Bushing	510361
	2011.11-2016.12	Rear Axle Left & Right Centre	Coupe FWD CCZB		Control Arm Bushing	530530
	2011.11-2016.12	Rear Axle Left & Right Upper	Coupe FWD CCZB		Control Arm Bushing	516372
	2011.11-2016.12	Rear Axle Left & Right Upper	Coupe FWD CCZB		Control Arm Bushing	516408
	2011.11-2016.12	Rear Axle Left & Right Lower Inner	Coupe FWD CCZB		Control Arm Bushing	510351
	2011.11-2016.12	Rear Axle Left & Right Lower Inner	Coupe FWD CCZB		Control Arm Bushing	510352
	2011.11-2016.12	Rear Axle Left & Right Lower Outer	Coupe FWD CCZB		Control Arm Bushing	516370
	2011.11-2016.12	Front Axle	Coupe FWD CCZB		Suspension Repair Kit	S990017SK
	2011.11-2016.12	Front Axle Left & Right	Coupe FWD CCZB		Tie Rod Axle Joint	S030009
	2011.11-2016.12	Front Axle Left	Coupe FWD CCZB		Tie Rod End	S070032
	2011.11-2016.12	Front Axle Right	Coupe FWD CCZB		Tie Rod End	S070033
	2011.11-2016.12	Front Axle Left & Right	Coupe FWD CCZB		Rod/Strut, stabiliser	S050040
	2011.11-2016.12	Rear Axle Left & Right	Coupe FWD CCZB		Rod/Strut, stabiliser	S050035
	2011.11-2016.12	Front Axle	Coupe FWD CCZB		Stabiliser Bushing	535187K
	2011.11-2016.12	Rear Axle	Coupe FWD CCZB		Stabiliser Bushing	516447
3.6 (220 kw)	2011.11-2016.12	Front Axle Left Lower	Coupe 4WD BWS		Track Control Arm	S061577
	2011.11-2016.12	Front Axle Right Lower	Coupe 4WD BWS		Track Control Arm	S061578
	2011.11-2016.12	Front Axle Left & Right Lower	Coupe 4WD BWS		Track Control Arm	S060762
	2011.11-2016.12	Rear Axle Left Centre	Coupe 4WD BWS		Track Control Arm	S063095
	2011.11-2016.12	Rear Axle Left Lower Inner	Coupe 4WD BWS		Track Control Arm	510349
	2011.11-2016.12	Rear Axle Right Centre	Coupe 4WD BWS		Track Control Arm	S063094
	2011.11-2016.12	Rear Axle Right Lower Inner	Coupe 4WD BWS		Track Control Arm	510350
	2011.11-2016.12	Rear Axle Left & Right Lower Outer	Coupe 4WD BWS		Track Control Arm	S061468
	2011.11-2016.12	Front Axle Left Lower	Coupe 4WD BWS		Ball Joint	S080258
	2011.11-2016.12	Front Axle Right Lower	Coupe 4WD BWS		Ball Joint	S080259
	2011.11-2016.12	Front Axle Left & Right Lower	Coupe 4WD BWS		Control Arm Bushing	510356
	2011.11-2016.12	Front Axle Left & Right Lower	Coupe 4WD BWS		Control Arm Bushing	510361
	2011.11-2016.12	Rear Axle Left & Right Centre	Coupe 4WD BWS		Control Arm Bushing	530530
	2011.11-2016.12	Rear Axle Left & Right Upper	Coupe 4WD BWS		Control Arm Bushing	516372
	2011.11-2016.12	Rear Axle Left & Right Upper	Coupe 4WD BWS		Control Arm Bushing	516408
	2011.11-2016.12	Rear Axle Left & Right Lower Inner	Coupe 4WD BWS		Control Arm Bushing	510351
	2011.11-2016.12	Rear Axle Left & Right Lower Inner	Coupe 4WD BWS		Control Arm Bushing	510352
	2011.11-2016.12	Rear Axle Left & Right Lower Outer	Coupe 4WD BWS		Control Arm Bushing	516370
	2011.11-2016.12	Front Axle	Coupe 4WD BWS		Suspension Repair Kit	S990017SK
	2011.11-2016.12	Front Axle Left & Right	Coupe 4WD BWS		Tie Rod Axle Joint	S030009
	2011.11-2016.12	Front Axle Left	Coupe 4WD BWS		Tie Rod End	S070032
	2011.11-2016.12	Front Axle Right	Coupe 4WD BWS		Tie Rod End	S070033
	2011.11-2016.12	Front Axle Left & Right	Coupe 4WD BWS		Rod/Strut, stabiliser	S050040
	2011.11-2016.12	Rear Axle Left & Right	Coupe 4WD BWS		Rod/Strut, stabiliser	S050035
	2011.11-2016.12	Front Axle	Coupe 4WD BWS		Stabiliser Bushing	535187K
	2011.11-2016.12	Rear Axle	Coupe 4WD BWS		Stabiliser Bushing	516447
Eos						
2.0 (147 kw)	2006.05-2015.08	Front Axle Left Lower	Cabriolet FWD BPY/BWA/CAWB/CBFA/CCTA/CCZA		Track Control Arm	S060342
	2006.05-2015.08	Front Axle Left Lower	Cabriolet FWD BPY/BWA/CAWB/CBFA/CCTA/CCZA		Track Control Arm	S060344
	2006.05-2015.08	Front Axle Left Lower	Cabriolet FWD BPY/BWA/CAWB/CBFA/CCTA/CCZA		Track Control Arm	S062032
	2006.05-2015.08	Front Axle Left Lower	Cabriolet FWD BPY/BWA/CAWB/CBFA/CCTA/CCZA		Track Control Arm	S063005



	 YEAR	FITTING POSITION	BODY STYLE & DRIVE TYPE & ENGINE	REMARKS	PRODUCT	GSP Ref.
VW Eos						
2.0 (147 kw)	2006.05-2015.08	Front Axle Right Lower	Cabriolet FWD BPY/BWA/CAWB/CBFA/CCTA/CCZA		Track Control Arm	S060341
	2006.05-2015.08	Front Axle Right Lower	Cabriolet FWD BPY/BWA/CAWB/CBFA/CCTA/CCZA	Engine code: BWA, CCZA, CAWB, 1F-A-004 450	Track Control Arm	S060343
	2006.05-2015.08	Front Axle Right Lower	Cabriolet FWD BPY/BWA/CAWB/CBFA/CCTA/CCZA		Track Control Arm	S062033
	2006.05-2015.08	Front Axle Right Lower	Cabriolet FWD BPY/BWA/CAWB/CBFA/CCTA/CCZA		Track Control Arm	S063006
	2006.05-2015.08	Rear Axle Left Centre	Cabriolet FWD BPY/BWA/CAWB/CBFA/CCTA/CCZA		Track Control Arm	S061407
	2006.05-2015.08	Rear Axle Left Lower Inner	Cabriolet FWD BPY/BWA/CAWB/CBFA/CCTA/CCZA		Track Control Arm	S10349
	2006.05-2015.08	Rear Axle Right Centre	Cabriolet FWD BPY/BWA/CAWB/CBFA/CCTA/CCZA		Track Control Arm	S061408
	2006.05-2015.08	Rear Axle Right Lower Inner	Cabriolet FWD BPY/BWA/CAWB/CBFA/CCTA/CCZA		Track Control Arm	510350
	2006.05-2015.08	Rear Axle Left & Right Lower Outer	Cabriolet FWD BPY/BWA/CAWB/CBFA/CCTA/CCZA		Track Control Arm	S061468
	2006.05-2015.08	Front Axle Left Lower	Cabriolet FWD BPY/BWA/CAWB/CBFA/CCTA/CCZA		Ball Joint	S080013
	2006.05-2015.08	Front Axle Right Lower	Cabriolet FWD BPY/BWA/CAWB/CBFA/CCTA/CCZA		Ball Joint	S080012
	2006.05-2015.08	Front Axle Left Lower	Cabriolet FWD BPY/BWA/CAWB/CBFA/CCTA/CCZA		Control Arm Bushing	510333
	2006.05-2015.08	Front Axle Right Lower	Cabriolet FWD BPY/BWA/CAWB/CBFA/CCTA/CCZA		Control Arm Bushing	510334
	2006.05-2015.08	Front Axle Left & Right Lower	Cabriolet FWD BPY/BWA/CAWB/CBFA/CCTA/CCZA		Control Arm Bushing	510332
	2006.05-2015.08	Front Axle Left & Right Lower	Cabriolet FWD BPY/BWA/CAWB/CBFA/CCTA/CCZA		Control Arm Bushing	510361
	2006.05-2015.08	Rear Axle Left & Right Upper	Cabriolet FWD BPY/BWA/CAWB/CBFA/CCTA/CCZA		Control Arm Bushing	516372
	2006.05-2015.08	Rear Axle Left & Right Upper	Cabriolet FWD BPY/BWA/CAWB/CBFA/CCTA/CCZA		Control Arm Bushing	516408
	2006.05-2015.08	Rear Axle Left & Right Lower Inner	Cabriolet FWD BPY/BWA/CAWB/CBFA/CCTA/CCZA		Control Arm Bushing	510351
	2006.05-2015.08	Rear Axle Left & Right Lower Inner	Cabriolet FWD BPY/BWA/CAWB/CBFA/CCTA/CCZA		Control Arm Bushing	510352
	2006.05-2015.08	Rear Axle Left & Right Lower Outer	Cabriolet FWD BPY/BWA/CAWB/CBFA/CCTA/CCZA		Control Arm Bushing	516370
	2006.05-2015.08	Rear Axle	Cabriolet FWD BPY/BWA/CAWB/CBFA/CCTA/CCZA		Suspension Repair Kit	S990019SK
	2006.05-2015.08	Front Axle Left & Right	Cabriolet FWD BPY/BWA/CAWB/CBFA/CCTA/CCZA		Tie Rod Axle Joint	S030009
	2006.05-2015.08	Front Axle Left	Cabriolet FWD BPY/BWA/CAWB/CBFA/CCTA/CCZA		Tie Rod End	S070032
	2006.05-2015.08	Front Axle Right	Cabriolet FWD BPY/BWA/CAWB/CBFA/CCTA/CCZA		Tie Rod End	S070033
	2006.05-2015.08	Front Axle Left & Right	Cabriolet FWD BPY/BWA/CAWB/CBFA/CCTA/CCZA		Rod/Strut, stabiliser	S050040
	2006.05-2015.08	Rear Axle Left & Right	Cabriolet FWD BPY/BWA/CAWB/CBFA/CCTA/CCZA		Rod/Strut, stabiliser	S050035
	2006.05-2015.08	Front Axle	Cabriolet FWD BPY/BWA/CAWB/CBFA/CCTA/CCZA		Stabiliser Bushing	535187K
	2006.05-2015.08	Rear Axle	Cabriolet FWD BPY/BWA/CAWB/CBFA/CCTA/CCZA	for PR no.:0BE	Stabiliser Bushing	516447
	2006.05-2015.08	Rear Axle	Cabriolet FWD BPY/BWA/CAWB/CBFA/CCTA/CCZA		Stabiliser Bushing	530183
Fox						
1.0 (53 kw)	2003.08-2009.12	Front Axle Left & Right Lower	Hatchback FWD AQZ/BNX		Track Control Arm	S060716
	2003.08-2009.12	Front Axle Left & Right Lower	Hatchback FWD BJE		Track Control Arm	S060716
	2003.08-2009.12	Front Axle Left Lower	Hatchback FWD AQZ/BNX		Ball Joint	S080010
	2003.08-2009.12	Front Axle Left Lower	Hatchback FWD BJE		Ball Joint	S080010
	2003.08-2009.12	Front Axle Left Lower	Hatchback FWD AQZ/BNX		Ball Joint	S080816
	2003.08-2009.12	Front Axle Left Lower	Hatchback FWD BJE		Ball Joint	S080816
	2003.08-2009.12	Front Axle Right Lower	Hatchback FWD AQZ/BNX		Ball Joint	S080011
	2003.08-2009.12	Front Axle Right Lower	Hatchback FWD BJE		Ball Joint	S080011
	2003.08-2009.12	Front Axle Right Lower	Hatchback FWD AQZ/BNX	VIN from:5Z74036001	Ball Joint	S080817
	2003.08-2009.12	Front Axle Right Lower	Hatchback FWD BJE	VIN from:5Z74036001	Ball Joint	S080817
	2003.08-2009.12	Front Axle Left & Right Lower	Hatchback FWD AQZ/BNX		Control Arm Bushing	510151
	2003.08-2009.12	Front Axle Left & Right Lower	Hatchback FWD BJE		Control Arm Bushing	510151
	2003.08-2009.12	Front Axle Left & Right Lower	Hatchback FWD AQZ/BNX		Control Arm Bushing	510332
	2003.08-2009.12	Front Axle Left & Right Lower	Hatchback FWD BJE	Engine Code:AQZ	Control Arm Bushing	510332
	2003.08-2009.12	Front Axle Left & Right Lower	Hatchback FWD BJE	Engine Code:AQZ;Engine Code:BJE	Control Arm Bushing	510332
	2003.08-2009.12	Front Axle	Hatchback FWD AQZ/BNX		Suspension Repair Kit	S990013SK
	2003.08-2009.12	Front Axle	Hatchback FWD BJE		Suspension Repair Kit	S990013SK
	2003.08-2009.12	Front Axle Left	Hatchback FWD AQZ/BNX		Rod Assembly	S100115
	2003.08-2009.12	Front Axle Left	Hatchback FWD BJE		Rod Assembly	S100115
	2003.08-2009.12	Front Axle Right	Hatchback FWD AQZ/BNX		Rod Assembly	S100116
	2003.08-2009.12	Front Axle Right	Hatchback FWD BJE		Rod Assembly	S100116
	2003.08-2009.12	Front Axle Left & Right	Hatchback FWD AQZ/BNX		Tie Rod Axle Joint	S030632
	2003.08-2009.12	Front Axle Left & Right	Hatchback FWD BJE		Tie Rod Axle Joint	S030632
	2003.08-2009.12	Front Axle Left	Hatchback FWD AQZ/BNX		Tie Rod End	S070014
	2003.08-2009.12	Front Axle Left	Hatchback FWD BJE		Tie Rod End	S070014
	2003.08-2009.12	Front Axle Right	Hatchback FWD AQZ/BNX		Tie Rod End	S070015
	2003.08-2009.12	Front Axle Right	Hatchback FWD BJE		Tie Rod End	S070015
	2003.08-2009.12	Front Axle Left & Right	Hatchback FWD AQZ/BNX		Rod/Strut, stabiliser	S050038
	2003.08-2009.12	Front Axle Left & Right	Hatchback FWD BJE		Rod/Strut, stabiliser	S050038
	2003.08-2009.12	Front Axle	Hatchback FWD AQZ/BNX	for PR no.:0AQ	Stabiliser Bushing	517167
	2003.08-2009.12	Front Axle	Hatchback FWD BJE	for PR no.:0AQ	Stabiliser Bushing	517167
	2003.08-2009.12	Front Axle	Hatchback FWD AQZ/BNX	for PR no.:0AR	Stabiliser Bushing	517168
	2003.08-2009.12	Front Axle	Hatchback FWD BJE	for PR no.:0AR	Stabiliser Bushing	517168
	2003.08-2009.12	Front Axle	Hatchback FWD AQZ/BNX		Stabiliser Bushing	517169



	 YEAR	FITTING POSITION	BODY STYLE & DRIVE TYPE & ENGINE	REMARKS	PRODUCT	GSP Ref.
VW						
Fox						
1.0 (53 kw)	2003.08-2009.12	Front Axle	Hatchback FWD BJE		Stabiliser Bushing	517169
	2003.08-2009.12	Front Axle	Hatchback FWD AQZ/BNX	for vehicles with power steering for PR number:1N2	Steering Rack Bellow Kit	540203S
	2003.08-2009.12	Front Axle	Hatchback FWD BJE	for vehicles with power steering for PR number:1N2	Steering Rack Bellow Kit	540203S
1.0 (54 kw)	2005.05-2014.10	Front Axle Left & Right Lower	Hatchback FWD BNX		Track Control Arm	S060716
	2005.05-2014.10	Front Axle Left Lower	Hatchback FWD BNX		Ball Joint	S080010
	2005.05-2014.10	Front Axle Left Lower	Hatchback FWD BNX		Ball Joint	S080816
	2005.05-2014.10	Front Axle Right Lower	Hatchback FWD BNX		Ball Joint	S080011
	2005.05-2014.10	Front Axle Right Lower	Hatchback FWD BNX	VIN from:5Z74036001	Ball Joint	S080817
	2005.05-2014.10	Front Axle Left & Right Lower	Hatchback FWD BNX		Control Arm Bushing	510151
	2005.05-2014.10	Front Axle Left & Right Lower	Hatchback FWD BNX		Control Arm Bushing	510332
	2005.05-2014.10	Front Axle	Hatchback FWD BNX		Suspension Repair Kit	S990013SK
	2005.05-2014.10	Front Axle Left	Hatchback FWD BNX		Rod Assembly	S100115
	2005.05-2014.10	Front Axle Right	Hatchback FWD BNX		Rod Assembly	S100116
	2005.05-2014.10	Front Axle Left & Right	Hatchback FWD BNX		Tie Rod Axle Joint	S030632
	2005.05-2014.10	Front Axle Left	Hatchback FWD BNX		Tie Rod End	S070014
	2005.05-2014.10	Front Axle Right	Hatchback FWD BNX		Tie Rod End	S070015
	2005.05-2014.10	Front Axle Left & Right	Hatchback FWD BNX		Rod/Strut,stabiliser	S050038
	2005.05-2014.10	Front Axle	Hatchback FWD BNX	for PR no.:0AQ	Stabiliser Bushing	517167
	2005.05-2014.10	Front Axle	Hatchback FWD BNX	for PR no.:0AR	Stabiliser Bushing	517168
	2005.05-2014.10	Front Axle	Hatchback FWD BNX	VIN from:5Z54672 187 for vehicles with sports suspension for PR no.:18D	Stabiliser Bushing	517169
	2005.05-2014.10	Front Axle	Hatchback FWD BNX	for vehicles with power steering for PR number:1N2	Steering Rack Bellow Kit	540203S
	2008.04-2009.12	Front Axle Left & Right Lower	Hatchback FWD CCNA		Track Control Arm	S060716
	2008.04-2009.12	Front Axle Left Lower	Hatchback FWD CCNA		Ball Joint	S080010
	2008.04-2009.12	Front Axle Left Lower	Hatchback FWD CCNA		Ball Joint	S080816
	2008.04-2009.12	Front Axle Right Lower	Hatchback FWD CCNA		Ball Joint	S080011
	2008.04-2009.12	Front Axle Right Lower	Hatchback FWD CCNA		Ball Joint	S080817
	2008.04-2009.12	Front Axle Left & Right Lower	Hatchback FWD CCNA		Control Arm Bushing	510151
	2008.04-2009.12	Front Axle Left & Right Lower	Hatchback FWD CCNA		Control Arm Bushing	510332
	2008.04-2009.12	Front Axle	Hatchback FWD CCNA		Suspension Repair Kit	S990013SK
	2008.04-2009.12	Front Axle Left	Hatchback FWD CCNA		Rod Assembly	S100115
	2008.04-2009.12	Front Axle Right	Hatchback FWD CCNA		Rod Assembly	S100116
	2008.04-2009.12	Front Axle Left & Right	Hatchback FWD CCNA		Tie Rod Axle Joint	S030632
	2008.04-2009.12	Front Axle Left	Hatchback FWD CCNA		Tie Rod End	S070014
	2008.04-2009.12	Front Axle Right	Hatchback FWD CCNA		Tie Rod End	S070015
	2008.04-2009.12	Front Axle Left & Right	Hatchback FWD CCNA		Rod/Strut,stabiliser	S050038
	2008.04-2009.12	Front Axle	Hatchback FWD CCNA	for PR no.:0AQ	Stabiliser Bushing	517167
	2008.04-2009.12	Front Axle	Hatchback FWD CCNA	for PR no.:0AR	Stabiliser Bushing	517168
	2008.04-2009.12	Front Axle	Hatchback FWD CCNA		Stabiliser Bushing	517169
	2008.04-2009.12	Front Axle	Hatchback FWD CCNA	for vehicles with power steering for PR number:1N2	Steering Rack Bellow Kit	540203S
1.0 (56 kw)	2008.05-2014.10	Front Axle Left & Right Lower	Hatchback FWD CCNA/CPBA		Track Control Arm	S060716
	2008.05-2014.10	Front Axle Left Lower	Hatchback FWD CCNA/CPBA	Engine Code:CCNA VIN to:5Z-D4174 096 for vehicles without sports suspension	Ball Joint	S080010
	2008.05-2014.10	Front Axle Left Lower	Hatchback FWD CCNA/CPBA		Ball Joint	S080816
	2008.05-2014.10	Front Axle Right Lower	Hatchback FWD CCNA/CPBA	Engine Code:CCNA VIN to:5Z-D4174 096 for vehicles without sports suspension	Ball Joint	S080011
	2008.05-2014.10	Front Axle Right Lower	Hatchback FWD CCNA/CPBA		Ball Joint	S080817
	2008.05-2014.10	Front Axle Left & Right Lower	Hatchback FWD CCNA/CPBA	Engine Code:CCNA	Control Arm Bushing	510151
	2008.05-2014.10	Front Axle Left & Right Lower	Hatchback FWD CCNA/CPBA	Engine Code:CCNA VIN to:5Z-D4190 000 Engine Code:CCNA	Control Arm Bushing	510332
	2008.05-2014.10	Front Axle	Hatchback FWD CCNA/CPBA		Suspension Repair Kit	S990013SK
	2008.05-2014.10	Front Axle Left	Hatchback FWD CCNA/CPBA		Rod Assembly	S100115
	2008.05-2014.10	Front Axle Right	Hatchback FWD CCNA/CPBA		Rod Assembly	S100116
	2008.05-2014.10	Front Axle Left & Right	Hatchback FWD CCNA/CPBA		Tie Rod Axle Joint	S030632
	2008.05-2014.10	Front Axle Left	Hatchback FWD CCNA/CPBA		Tie Rod End	S070014
	2008.05-2014.10	Front Axle Right	Hatchback FWD CCNA/CPBA		Tie Rod End	S070015
	2008.05-2014.10	Front Axle Left & Right	Hatchback FWD CCNA/CPBA		Rod/Strut,stabiliser	S050038
	2008.05-2014.10	Front Axle	Hatchback FWD CCNA/CPBA	Engine Code:CCNA for PR no.:0AQ	Stabiliser Bushing	517167
	2008.05-2014.10	Front Axle	Hatchback FWD CCNA/CPBA	Engine Code:CCNA for PR no.:0AR	Stabiliser Bushing	517168
	2008.05-2014.10	Front Axle	Hatchback FWD CCNA/CPBA	for PR no.:0AS	Stabiliser Bushing	517169
	2008.05-2014.10	Front Axle	Hatchback FWD CCNA/CPBA	Engine Code:CCNA for vehicles with power steering for PR number:1N2	Steering Rack Bellow Kit	540203S
	2014.08-2015.12	Front Axle Left & Right	Hatchback FWD CPBA		Rod/Strut,stabiliser	S050038
1.0 (60 kw)	2013.07-2014.08	Front Axle Left & Right Lower	Hatchback FWD CSEA		Track Control Arm	S060716
	2013.07-2014.08	Front Axle Left Lower	Hatchback FWD CSEA	VIN to:5Z-D4174 096 for vehicles without sports suspension	Ball Joint	S080010
	2013.07-2014.08	Front Axle Left Lower	Hatchback FWD CSEA		Ball Joint	S080816
	2013.07-2014.08	Front Axle Right Lower	Hatchback FWD CSEA	VIN to:5Z-D4174 096 for vehicles without sports suspension	Ball Joint	S080011
	2013.07-2014.08	Front Axle Right Lower	Hatchback FWD CSEA		Ball Joint	S080817
	2013.07-2014.08	Front Axle Left & Right Lower	Hatchback FWD CSEA		Control Arm Bushing	510151



	 YEAR	FITTING POSITION	BODY STYLE & DRIVE TYPE & ENGINE	REMARKS	PRODUCT	GSP Ref.
VW						
Fox						
1.0 (60 kw)	2013.07-2014.08	Front Axle Left & Right Lower	Hatchback FWD CSEA		Control Arm Bushing	510332
	2013.07-2014.08	Front Axle	Hatchback FWD CSEA		Suspension Repair Kit	S990013SK
	2013.07-2014.08	Front Axle Left	Hatchback FWD CSEA		Tie Rod End	S070014
	2013.07-2014.08	Front Axle Right	Hatchback FWD CSEA		Tie Rod End	S070015
	2013.07-2014.08	Front Axle Left & Right	Hatchback FWD CSEA		Rod/Strut, stabiliser	S050038
	2013.07-2014.08	Front Axle	Hatchback FWD CSEA		Stabiliser Bushing	517167
	2013.07-2014.08	Front Axle	Hatchback FWD CSEA		Stabiliser Bushing	517168
	2013.07-2014.08	Front Axle	Hatchback FWD CSEA	for PR no.:0AS	Stabiliser Bushing	517169
	2014.08-	Front Axle Left & Right	Hatchback FWD CSEA		Rod/Strut, stabiliser	S050038
1.6 (74 kw)	2003.10-	Front Axle Left & Right Lower	Hatchback FWD BAH/BJA/BLH/CFZA		Track Control Arm	S060716
	2003.10-	Front Axle Left Lower	Hatchback FWD BAH/BJA/BLH/CFZA		Ball Joint	S080010
	2003.10-	Front Axle Left Lower	Hatchback FWD BAH/BJA/BLH/CFZA		Ball Joint	S080816
	2003.10-	Front Axle Right Lower	Hatchback FWD BAH/BJA/BLH/CFZA		Ball Joint	S080011
	2003.10-	Front Axle Right Lower	Hatchback FWD BAH/BJA/BLH/CFZA		Ball Joint	S080817
	2003.10-	Front Axle Left & Right Lower	Hatchback FWD BAH/BJA/BLH/CFZA		Control Arm Bushing	510151
	2003.10-	Front Axle Left & Right Lower	Hatchback FWD BAH/BJA/BLH/CFZA	Engine Code:BAH,CFZA,BJA,BLH	Control Arm Bushing	510332
	2003.10-	Front Axle	Hatchback FWD BAH/BJA/BLH/CFZA		Suspension Repair Kit	S990013SK
	2003.10-	Front Axle Left	Hatchback FWD BAH/BJA/BLH/CFZA		Rod Assembly	S100115
	2003.10-	Front Axle Right	Hatchback FWD BAH/BJA/BLH/CFZA		Rod Assembly	S100116
	2003.10-	Front Axle Left & Right	Hatchback FWD BAH/BJA/BLH/CFZA		Tie Rod Axle Joint	S030632
	2003.10-	Front Axle Left	Hatchback FWD BAH/BJA/BLH/CFZA		Tie Rod End	S070014
	2003.10-	Front Axle Right	Hatchback FWD BAH/BJA/BLH/CFZA		Tie Rod End	S070015
	2003.10-	Front Axle Left & Right	Hatchback FWD BAH/BJA/BLH/CFZA		Rod/Strut, stabiliser	S050038
	2003.10-	Front Axle	Hatchback FWD BAH/BJA/BLH/CFZA		Stabiliser Bushing	517167
	2003.10-	Front Axle	Hatchback FWD BAH/BJA/BLH/CFZA		Stabiliser Bushing	517168
	2003.10-	Front Axle	Hatchback FWD BAH/BJA/BLH/CFZA		Stabiliser Bushing	517169
	2003.10-	Front Axle	Hatchback FWD BAH/BJA/BLH/CFZA		Steering Boot	540203
	2003.10-	Front Axle	Hatchback FWD BAH/BJA/BLH/CFZA		Steering Rack Bellow Kit	540203S
1.6 (75 kw)	2015.10-	Front Axle Left & Right Lower	Hatchback FWD CFZA		Control Arm Bushing	510084
	2015.10-	Front Axle Left & Right	Hatchback FWD CFZA		Rod/Strut, stabiliser	S050038
1.6 (77 kw)	2003.10-2009.12	Front Axle Left & Right Lower	Hatchback FWD BPA		Track Control Arm	S060716
	2003.10-2009.12	Front Axle Left Lower	Hatchback FWD BPA		Ball Joint	S080010
	2003.10-2009.12	Front Axle Left Lower	Hatchback FWD BPA		Ball Joint	S080816
	2003.10-2009.12	Front Axle Right Lower	Hatchback FWD BPA		Ball Joint	S080011
	2003.10-2009.12	Front Axle Right Lower	Hatchback FWD BPA		Ball Joint	S080817
	2003.10-2009.12	Front Axle Left & Right Lower	Hatchback FWD BPA		Control Arm Bushing	510151
	2003.10-2009.12	Front Axle Left & Right Lower	Hatchback FWD BPA		Control Arm Bushing	510332
	2003.10-2009.12	Front Axle	Hatchback FWD BPA		Suspension Repair Kit	S990013SK
	2003.10-2009.12	Front Axle Left	Hatchback FWD BPA		Rod Assembly	S100115
	2003.10-2009.12	Front Axle Right	Hatchback FWD BPA		Rod Assembly	S100116
	2003.10-2009.12	Front Axle Left & Right	Hatchback FWD BPA		Tie Rod Axle Joint	S030632
	2003.10-2009.12	Front Axle Left	Hatchback FWD BPA		Tie Rod End	S070014
	2003.10-2009.12	Front Axle Right	Hatchback FWD BPA		Tie Rod End	S070015
	2003.10-2009.12	Front Axle Left & Right	Hatchback FWD BPA		Rod/Strut, stabiliser	S050038
	2003.10-2009.12	Front Axle	Hatchback FWD BPA	for PR no.:0AQ	Stabiliser Bushing	517167
	2003.10-2009.12	Front Axle	Hatchback FWD BPA	for PR no.:0AR	Stabiliser Bushing	517168
	2003.10-2009.12	Front Axle	Hatchback FWD BPA		Stabiliser Bushing	517169
	2003.10-2009.12	Front Axle	Hatchback FWD BPA	for vehicles with power steering, for PR number:1N2	Steering Rack Bellow Kit	540203S
	2008.05-2014.10	Front Axle Left & Right Lower	Hatchback FWD CCRA		Track Control Arm	S060716
	2008.05-2014.10	Front Axle Left Lower	Hatchback FWD CCRA	VIN to:5Z-D4174-096,for vehicles without sports suspension	Ball Joint	S080010
	2008.05-2014.10	Front Axle Left Lower	Hatchback FWD CCRA		Ball Joint	S080816
	2008.05-2014.10	Front Axle Right Lower	Hatchback FWD CCRA	VIN to:5Z-D4174-096,for vehicles without sports suspension	Ball Joint	S080011
	2008.05-2014.10	Front Axle Right Lower	Hatchback FWD CCRA	VIN from:5Z74036001	Ball Joint	S080817
	2008.05-2014.10	Front Axle Left & Right Lower	Hatchback FWD CCRA		Control Arm Bushing	510151
	2008.05-2014.10	Front Axle Left & Right Lower	Hatchback FWD CCRA		Control Arm Bushing	510332
	2008.05-2014.10	Front Axle	Hatchback FWD CCRA		Suspension Repair Kit	S990013SK
	2008.05-2014.10	Front Axle Left	Hatchback FWD CCRA		Rod Assembly	S100115
	2008.05-2014.10	Front Axle Right	Hatchback FWD CCRA		Rod Assembly	S100116
	2008.05-2014.10	Front Axle Left & Right	Hatchback FWD CCRA		Tie Rod Axle Joint	S030632
	2008.05-2014.10	Front Axle Left	Hatchback FWD CCRA		Tie Rod End	S070014
	2008.05-2014.10	Front Axle Right	Hatchback FWD CCRA		Tie Rod End	S070015
	2008.05-2014.10	Front Axle Left & Right	Hatchback FWD CCRA		Rod/Strut, stabiliser	S050038
	2008.05-2014.10	Front Axle	Hatchback FWD CCRA		Stabiliser Bushing	517167
	2008.05-2014.10	Front Axle	Hatchback FWD CCRA		Stabiliser Bushing	517168



	 YEAR	FITTING POSITION	BODY STYLE & DRIVE TYPE & ENGINE	REMARKS	PRODUCT	GSP Ref.	
VW Fox							
1.6 (77 kw)	2008.05-2014.10	Front Axle	Hatchback FWD CCRA	VN from 05-04072 107 for vehicles with sports suspension for PR no.:100	Stabiliser Bushing	517169	
	2008.05-2014.10	Front Axle	Hatchback FWD CCRA	for vehicles with power steering for PR number:1N2	Steering Rack Bellow Kit	540203S	
	2014.08-	Front Axle Left & Right	Hatchback FWD CCRA		Rod/Strut,stabiliser	S050038	
1.6 (81 kw)	2015.12-2017.12	Front Axle Left & Right Lower	Hatchback FWD CWSA		Control Arm Bushing	510084	
	2015.12-2017.12	Front Axle Left & Right	Hatchback FWD CWSA		Rod/Strut,stabiliser	S050038	
1.6 (88 kw)	2014.08-2018.12	Front Axle Left & Right	Hatchback FWD CNXA		Rod/Strut,stabiliser	S050038	
1.9 (47 kw)	2008.08-2009.12	Front Axle Left & Right Lower	Hatchback FWD ASY		Track Control Arm	S060716	
	2008.08-2009.12	Front Axle Left Lower	Hatchback FWD ASY		Ball Joint	S080010	
	2008.08-2009.12	Front Axle Left Lower	Hatchback FWD ASY		Ball Joint	S080816	
	2008.08-2009.12	Front Axle Right Lower	Hatchback FWD ASY		Ball Joint	S080011	
	2008.08-2009.12	Front Axle Right Lower	Hatchback FWD ASY		Ball Joint	S080817	
	2008.08-2009.12	Front Axle Left & Right Lower	Hatchback FWD ASY		Control Arm Bushing	510151	
	2008.08-2009.12	Front Axle Left & Right Lower	Hatchback FWD ASY		Control Arm Bushing	510332	
	2008.08-2009.12	Front Axle	Hatchback FWD ASY		Suspension Repair Kit	S990013SK	
	2008.08-2009.12	Front Axle Left	Hatchback FWD ASY		Rod Assembly	S100115	
	2008.08-2009.12	Front Axle Right	Hatchback FWD ASY		Rod Assembly	S100116	
	2008.08-2009.12	Front Axle Left & Right	Hatchback FWD ASY		Tie Rod Axle Joint	S030632	
	2008.08-2009.12	Front Axle Left	Hatchback FWD ASY		Tie Rod End	S070014	
	2008.08-2009.12	Front Axle Right	Hatchback FWD ASY		Tie Rod End	S070015	
	2008.08-2009.12	Front Axle Left & Right	Hatchback FWD ASY		Rod/Strut,stabiliser	S050038	
	2008.08-2009.12	Front Axle	Hatchback FWD ASY	for PR no.:0AQ	Stabiliser Bushing	517167	
	2008.08-2009.12	Front Axle	Hatchback FWD ASY	for PR no.:0AR	Stabiliser Bushing	517168	
	2008.08-2009.12	Front Axle	Hatchback FWD ASY		Stabiliser Bushing	517169	
	2008.08-2009.12	Front Axle	Hatchback FWD ASY	for vehicles with power steering for PR number:1N2	Steering Rack Bellow Kit	540203S	
	Gol						
	1.0 (51 kw)	2010.05-	Front Axle Left & Right Lower	Hatchback FWD CCNA		Control Arm Bushing	510084
2010.05-		Front Axle Left & Right	Hatchback FWD CCNA		Rod/Strut,stabiliser	S050038	
1.0 (56 kw)	2008.07-	Front Axle Left & Right Lower	Hatchback FWD CCNA/CPBA		Control Arm Bushing	510084	
	2008.07-	Front Axle Left & Right	Hatchback FWD CCNA/CPBA		Rod/Strut,stabiliser	S050038	
	2012.08-2016.12	Front Axle Left & Right Lower	Hatchback FWD CCNA/CPBA		Control Arm Bushing	510084	
	2012.08-2016.12	Front Axle Left & Right	Hatchback FWD CCNA/CPBA		Rod/Strut,stabiliser	S050038	
1.0 (60 kw)	2016.01-	Front Axle Left & Right Lower	Hatchback FWD CSEA		Control Arm Bushing	510084	
	2016.01-	Front Axle Left & Right	Hatchback FWD CSEA		Rod/Strut,stabiliser	S050038	
1.6 (74 kw)	2008.06-	Front Axle Left & Right Lower	Hatchback FWD CCRA		Control Arm Bushing	510084	
	2008.06-	Front Axle Left & Right	Hatchback FWD CCRA		Rod/Strut,stabiliser	S050038	
	2009.07-	Front Axle Left & Right Lower	Hatchback FWD CCRA/CFZA		Control Arm Bushing	510084	
	2009.07-	Front Axle Left & Right	Hatchback FWD CCRA/CFZA		Rod/Strut,stabiliser	S050038	
1.6 (75 kw)	2009.09-	Front Axle Left & Right Lower	Hatchback FWD CCRA/CFZA		Control Arm Bushing	510084	
	2009.09-	Front Axle Left & Right	Hatchback FWD CCRA/CFZA		Rod/Strut,stabiliser	S050038	
1.6 (76 kw)	2012.08-	Front Axle Left & Right Lower	Hatchback FWD CCRA		Control Arm Bushing	510084	
	2012.08-	Front Axle Left & Right	Hatchback FWD CCRA		Rod/Strut,stabiliser	S050038	
	2016.01-	Front Axle Left & Right Lower	Hatchback FWD CCRA		Control Arm Bushing	510084	
	2016.01-	Front Axle Left & Right	Hatchback FWD CCRA		Rod/Strut,stabiliser	S050038	
	2018.10-	Front Axle Left & Right Lower	Hatchback FWD CCRA		Control Arm Bushing	510084	
	2018.10-	Front Axle Left & Right	Hatchback FWD CCRA		Rod/Strut,stabiliser	S050038	
1.6 (77 kw)	2008.07-	Front Axle Left & Right Lower	Hatchback FWD CCRA		Control Arm Bushing	510084	
	2008.07-	Front Axle Left & Right	Hatchback FWD CCRA		Rod/Strut,stabiliser	S050038	
1.6 (88 kw)	2014.03-2015.12	Front Axle Left & Right Lower	Hatchback FWD CNXA		Control Arm Bushing	510084	
	2014.03-2015.12	Front Axle Left & Right	Hatchback FWD CNXA		Rod/Strut,stabiliser	S050038	
Golf							
1.0 (92 kw)	2015.06-	Front Axle Left Lower	Hatchback FWD DHSA		Track Control Arm	S062137	
	2015.06-	Front Axle Right Lower	Hatchback FWD DHSA		Track Control Arm	S062134	
	2015.06-	Rear Axle Left & Right Lower Inner	Hatchback FWD DHSA		Control Arm Bushing	535309	
	2015.06-	Front Axle Left	Hatchback FWD DHSA		Rod Assembly	S100435	
	2015.06-	Front Axle Right	Hatchback FWD DHSA		Rod Assembly	S100434	
	2015.06-	Front Axle Left & Right	Hatchback FWD DHSA		Rod/Strut,stabiliser	S050040	
	2015.06-	Rear Axle Left & Right	Hatchback FWD DHSA		Rod/Strut,stabiliser	S051234	
	2015.06-	Front Axle	Hatchback FWD DHSA		Steering Boot	541209	
	2015.06-	Front Axle	Hatchback FWD DHSA		Steering Rack Bellow Kit	541209S	
	1.0 (94 kw)	2018.08-	Rear Axle Left & Right Lower Inner	Hatchback FWD DHSA		Control Arm Bushing	535309
2018.08-		Front Axle Left	Hatchback FWD DHSA		Rod Assembly	S100435	
2018.08-		Front Axle Right	Hatchback FWD DHSA		Rod Assembly	S100434	
2018.08-		Front Axle Left & Right	Hatchback FWD DHSA		Rod/Strut,stabiliser	S050040	
2018.08-		Front Axle	Hatchback FWD DHSA		Steering Boot	541209	



	 YEAR	FITTING POSITION	BODY STYLE & DRIVE TYPE & ENGINE	REMARKS	PRODUCT	GSP Ref.	
VW Golf							
1.0 (94 kw)	2018.08-	Front Axle	Hatchback FWD DHSB		Steering Rack Bellow Kit	541209S	
1.4 (103 kw)	2012.08-2017.03	Front Axle Left Lower	Hatchback FWD CHPA/CPTA	Date to:2019.06	Track Control Arm	S062137	
	2012.08-2017.03	Front Axle Left Lower	Hatchback FWD CHPA/CPTA	For OE no.5QM407151A,With ball joint	Track Control Arm	S062976	
	2012.08-2017.03	Front Axle Right Lower	Hatchback FWD CHPA/CPTA	Date to:2019.06	Track Control Arm	S062134	
	2012.08-2017.03	Front Axle Right Lower	Hatchback FWD CHPA/CPTA	With ball joint	Track Control Arm	S062977	
	2012.08-2017.03	Rear Axle Left & Right Lower Inner	Hatchback FWD CHPA/CPTA		Track Control Arm	S062791	
	2012.08-2017.03	Rear Axle Left & Right Lower Outer	Hatchback FWD CHPA/CPTA		Track Control Arm	S062899	
	2012.08-2017.03	Front Axle Left Lower	Hatchback FWD CHPA/CPTA		Ball Joint	S080258	
	2012.08-2017.03	Front Axle Right Lower	Hatchback FWD CHPA/CPTA		Ball Joint	S080259	
	2012.08-2017.03	Front Axle Left & Right Lower	Hatchback FWD CHPA/CPTA		Control Arm Bushing	510361	
	2012.08-2017.03	Front Axle Left & Right Lower	Hatchback FWD CHPA/CPTA		Control Arm Bushing	531431	
	2012.08-2017.03	Rear Axle Left & Right Centre	Hatchback FWD CHPA/CPTA		Control Arm Bushing	512203	
	2012.08-2017.03	Rear Axle Left & Right Upper	Hatchback FWD CHPA/CPTA		Control Arm Bushing	516372	
	2012.08-2017.03	Rear Axle Left & Right Upper	Hatchback FWD CHPA/CPTA		Control Arm Bushing	516408	
	2012.08-2017.03	Rear Axle Left & Right Lower Inner	Hatchback FWD CHPA/CPTA		Control Arm Bushing	535309	
	2012.08-2017.03	Front Axle	Hatchback FWD CHPA/CPTA		Suspension Repair Kit	S990061SK	
	2012.08-2017.03	Front Axle Left & Right	Hatchback FWD CHPA/CPTA		Tie Rod Axle Joint	S030009	
	2012.08-2017.03	Front Axle Left	Hatchback FWD CHPA/CPTA		Tie Rod End	S070032	
	2012.08-2017.03	Front Axle Right	Hatchback FWD CHPA/CPTA		Tie Rod End	S070033	
	2012.08-2017.03	Front Axle Left & Right	Hatchback FWD CHPA/CPTA		Rod/Strut, stabiliser	S050040	
	2012.08-2017.03	Rear Axle Left & Right	Hatchback FWD CHPA/CPTA		Rod/Strut, stabiliser	S051234	
1.4 (110 kw)	2014.05-	Front Axle Left Lower	Hatchback FWD CUKB	Date to:2019.06	Track Control Arm	S062137	
	2014.05-	Front Axle Left Lower	Hatchback FWD CUKB	For OE no.5QM407151A,With ball joint	Track Control Arm	S062976	
	2014.05-	Front Axle Right Lower	Hatchback FWD CUKB	Date to:2019.06	Track Control Arm	S062134	
	2014.05-	Front Axle Right Lower	Hatchback FWD CUKB	With ball joint	Track Control Arm	S062977	
	2014.05-	Rear Axle Left & Right Lower Inner	Hatchback FWD CUKB		Track Control Arm	S062791	
	2014.05-	Rear Axle Left & Right Lower Outer	Hatchback FWD CUKB		Track Control Arm	S062899	
	2014.05-	Front Axle Left Lower	Hatchback FWD CUKB	Equipment Var. PR-12E 12F 12P STEEL WHEEL BEARING	Ball Joint	S080013	
	2014.05-	Front Axle Left Lower	Hatchback FWD CUKB		Ball Joint	S080258	
	2014.05-	Front Axle Right Lower	Hatchback FWD CUKB	Equipment Var. PR-12E 12F 12P STEEL WHEEL BEARING	Ball Joint	S080012	
	2014.05-	Front Axle Right Lower	Hatchback FWD CUKB		Ball Joint	S080259	
	2014.05-	Front Axle Left & Right Lower	Hatchback FWD CUKB		Control Arm Bushing	510361	
	2014.05-	Front Axle Left & Right Lower	Hatchback FWD CUKB		Control Arm Bushing	531431	
	2014.05-	Rear Axle Left & Right Centre	Hatchback FWD CUKB		Control Arm Bushing	512203	
	2014.05-	Rear Axle Left & Right Upper	Hatchback FWD CUKB		Control Arm Bushing	516372	
	2014.05-	Rear Axle Left & Right Upper	Hatchback FWD CUKB		Control Arm Bushing	516408	
	2014.05-	Rear Axle Left & Right Lower Inner	Hatchback FWD CUKB		Control Arm Bushing	535309	
	2014.05-	Front Axle Left & Right	Hatchback FWD CUKB		Tie Rod Axle Joint	S030009	
	2014.05-	Front Axle Left	Hatchback FWD CUKB		Tie Rod End	S070032	
	2014.05-	Front Axle Right	Hatchback FWD CUKB		Tie Rod End	S070033	
	2014.05-	Front Axle Left & Right	Hatchback FWD CUKB		Rod/Strut, stabiliser	S050040	
	2014.05-	Rear Axle Left & Right	Hatchback FWD CUKB		Rod/Strut, stabiliser	S051234	
	2015.06-	Rear Axle Left & Right Lower Inner	Estate FWD CWLA		Control Arm Bushing	535309	
	2015.06-	Front Axle Left	Estate FWD CWLA		Rod Assembly	S100435	
	2015.06-	Front Axle Right	Estate FWD CWLA		Rod Assembly	S100434	
	2015.06-	Front Axle Left & Right	Estate FWD CWLA		Rod/Strut, stabiliser	S050040	
	2015.06-	Rear Axle Left & Right	Estate FWD CWLA		Rod/Strut, stabiliser	S051234	
	2015.06-	Front Axle	Estate FWD CWLA		Steering Boot	541209	
	2015.06-	Front Axle	Estate FWD CWLA		Steering Rack Bellow Kit	541209S	
	2015.08-2019.05	Front Axle Left Lower	Hatchback FWD CWLA		Track Control Arm	S062137	
	2015.08-2019.05	Front Axle Right Lower	Hatchback FWD CWLA		Track Control Arm	S062134	
	2015.08-2019.05	Rear Axle Left & Right Lower Inner	Hatchback FWD CWLA		Control Arm Bushing	535309	
	2015.08-2019.05	Front Axle Left	Hatchback FWD CWLA		Rod Assembly	S100435	
	2015.08-2019.05	Front Axle Right	Hatchback FWD CWLA		Rod Assembly	S100434	
	2015.08-2019.05	Front Axle Left & Right	Hatchback FWD CWLA		Rod/Strut, stabiliser	S050040	
	2015.08-2019.05	Rear Axle Left & Right	Hatchback FWD CWLA		Rod/Strut, stabiliser	S051234	
	2015.08-2019.05	Front Axle	Hatchback FWD CWLA		Steering Boot	541209	
	2015.08-2019.05	Front Axle	Hatchback FWD CWLA		Steering Rack Bellow Kit	541209S	
	1.6 (74 kw)	1997.10-2004.05	Front Axle Left Lower	Hatchback FWD AEH/AKL/APF		Track Control Arm	S060339
		1997.10-2004.05	Front Axle Right Lower	Hatchback FWD AEH/AKL/APF		Track Control Arm	S060340
		1997.10-2004.05	Front Axle Left & Right Lower	Hatchback FWD AEH/AKL/APF		Track Control Arm	S061643
1997.10-2004.05		Front Axle Left Lower	Hatchback FWD AEH/AKL/APF		Ball Joint	S080016	
1997.10-2004.05		Front Axle Right Lower	Hatchback FWD AEH/AKL/APF		Ball Joint	S080017	
1997.10-2004.05		Front Axle Left & Right Lower	Hatchback FWD AEH/AKL/APF		Control Arm Bushing	510065	



	 YEAR	FITTING POSITION	BODY STYLE & DRIVE TYPE & ENGINE	REMARKS	PRODUCT	GSP Ref.
VW Golf						
1.6 (74 kw)	1997.10-2004.05	Front Axle Left & Right Lower	Hatchback FWD AEH/AKL/APF		Control Arm Bushing	510084
	1997.10-2004.05	Front Axle	Hatchback FWD AEH/AKL/APF		Suspension Repair Kit	S990016SK
	1997.10-2004.05	Front Axle Left	Hatchback FWD AEH/AKL/APF		Rod Assembly	S100011
	1997.10-2004.05	Front Axle Left	Hatchback FWD AEH/AKL/APF		Rod Assembly	S100015
	1997.10-2004.05	Front Axle Right	Hatchback FWD AEH/AKL/APF		Rod Assembly	S100010
	1997.10-2004.05	Front Axle Right	Hatchback FWD AEH/AKL/APF		Rod Assembly	S100016
	1997.10-2004.05	Front Axle Left & Right	Hatchback FWD AEH/AKL/APF		Tie Rod Axle Joint	S030011
	1997.10-2004.05	Front Axle Left	Hatchback FWD AEH/AKL/APF	Engine code:AKL,Date to:1998.01	Tie Rod End	S070039
	1997.10-2004.05	Front Axle Left	Hatchback FWD AEH/AKL/APF	Engine code:AEH,APF,Engine code:AKL,Date from:1998.01	Tie Rod End	S071340
	1997.10-2004.05	Front Axle Right	Hatchback FWD AEH/AKL/APF	Engine code:AKL,Date to:1998.01	Tie Rod End	S070040
	1997.10-2004.05	Front Axle Right	Hatchback FWD AEH/AKL/APF	Engine code:AEH,APF,Engine code:AKL,Date from:1998.01	Tie Rod End	S071341
	1997.10-2004.05	Front Axle Left	Hatchback FWD AEH/AKL/APF		Rod/Strut, stabiliser	S050043
	1997.10-2004.05	Front Axle Right	Hatchback FWD AEH/AKL/APF		Rod/Strut, stabiliser	S050036
	1997.10-2004.05	Front Axle Left & Right	Hatchback FWD AEH/AKL/APF	for PR no.:0AL/0AM	Rod/Strut, stabiliser	510067
	1997.10-2004.05	Front Axle Left & Right	Hatchback FWD AEH/AKL/APF		Rod/Strut, stabiliser	510067S
	1997.10-2004.05	Front Axle Left & Right	Hatchback FWD AEH/AKL/APF		Rod/Strut, stabiliser	510068
	1997.10-2004.05	Front Axle Left & Right	Hatchback FWD AEH/AKL/APF		Rod/Strut, stabiliser	510068S
	1997.10-2004.05	Front Axle Left & Right	Hatchback FWD AEH/AKL/APF		Rod/Strut, stabiliser	512249
	1997.10-2004.05	Front Axle Left & Right	Hatchback FWD AEH/AKL/APF	Date from-to:2000.08-2001.04,For PR code: 0AE	Rod/Strut, stabiliser	S050052
	1997.10-2004.05	Front Axle	Hatchback FWD AEH/AKL/APF		Stabiliser Bushing	510232
	1997.10-2004.05	Front Axle	Hatchback FWD AEH/AKL/APF	for PR no.:0AL/0AM,for PR no.:0AE	Stabiliser Bushing	510316
	1997.10-2004.05	Front Axle	Hatchback FWD AEH/AKL/APF		Stabiliser Bushing	517166
	1997.10-2004.05	Front Axle	Hatchback FWD AEH/AKL/APF		Steering Boot	540227
	1997.10-2004.05	Front Axle	Hatchback FWD AEH/AKL/APF		Stabiliser Bushing Kit	510066S
	1999.08-2007.03	Front Axle Left	Hatchback FWD BAH		Rod Assembly	S100015
	1999.08-2007.03	Front Axle Right	Hatchback FWD BAH		Rod Assembly	S100016
	1999.08-2007.03	Front Axle Left & Right	Hatchback FWD BAH		Tie Rod Axle Joint	S030011
	1999.08-2007.03	Front Axle Left	Hatchback FWD BAH		Tie Rod End	S070039
	1999.08-2007.03	Front Axle Right	Hatchback FWD BAH		Tie Rod End	S070040
	1999.08-2007.03	Front Axle Left	Hatchback FWD BAH		Rod/Strut, stabiliser	S050043
	1999.08-2007.03	Front Axle Right	Hatchback FWD BAH		Rod/Strut, stabiliser	S050036
	1999.08-2007.03	Front Axle	Hatchback FWD BAH		Stabiliser Bushing	510066
	1999.08-2007.03	Front Axle	Hatchback FWD BAH		Stabiliser Bushing	510232
	1999.08-2007.03	Front Axle	Hatchback FWD BAH		Stabiliser Bushing	517166
1.6 (76 kw)	2001.02-2007.12	Front Axle Left Lower	Hatchback FWD BAH		Track Control Arm	S060339
	2001.02-2007.12	Front Axle Right Lower	Hatchback FWD BAH		Track Control Arm	S060340
	2001.02-2007.12	Front Axle Left & Right Lower	Hatchback FWD BAH		Track Control Arm	S061643
	2001.02-2007.12	Front Axle Left & Right Lower	Hatchback FWD BAH		Control Arm Bushing	510084
	2001.02-2007.12	Front Axle Left	Hatchback FWD BAH		Rod Assembly	S100011
	2001.02-2007.12	Front Axle Left	Hatchback FWD BAH		Rod Assembly	S100015
	2001.02-2007.12	Front Axle Right	Hatchback FWD BAH		Rod Assembly	S100010
	2001.02-2007.12	Front Axle Right	Hatchback FWD BAH		Rod Assembly	S100016
	2001.02-2007.12	Front Axle Left & Right	Hatchback FWD BAH		Tie Rod Axle Joint	S030011
	2001.02-2007.12	Front Axle Left	Hatchback FWD BAH		Tie Rod End	S070039
	2001.02-2007.12	Front Axle Left	Hatchback FWD BAH		Tie Rod End	S071340
	2001.02-2007.12	Front Axle Right	Hatchback FWD BAH		Tie Rod End	S070040
	2001.02-2007.12	Front Axle Right	Hatchback FWD BAH		Tie Rod End	S071341
	2001.02-2007.12	Front Axle Left & Right	Hatchback FWD BAH	for PR no.:0AL	Rod/Strut, stabiliser	510067
	2001.02-2007.12	Front Axle Left & Right	Hatchback FWD BAH		Rod/Strut, stabiliser	510067S
	2001.02-2007.12	Front Axle Left & Right	Hatchback FWD BAH	for PR no.:0AE	Rod/Strut, stabiliser	510068
	2001.02-2007.12	Front Axle Left & Right	Hatchback FWD BAH	for PR no.:0AE	Rod/Strut, stabiliser	510068S
	2001.02-2007.12	Front Axle	Hatchback FWD BAH		Stabiliser Bushing	510066
	2001.02-2007.12	Front Axle	Hatchback FWD BAH		Stabiliser Bushing	510232
	2001.02-2007.12	Front Axle	Hatchback FWD BAH		Stabiliser Bushing	517166
1.6 (88 kw)	2015.06-	Front Axle Left Lower	Hatchback FWD CNXA		Track Control Arm	S062137
	2015.06-	Front Axle Right Lower	Hatchback FWD CNXA		Track Control Arm	S062134
	2015.06-	Front Axle Left Lower	Hatchback FWD CNXA		Ball Joint	S080258
	2015.06-	Rear Axle Left & Right Lower Inner	Hatchback FWD CNXA		Control Arm Bushing	535309
	2015.06-	Front Axle Left	Hatchback FWD CNXA		Rod Assembly	S100435
	2015.06-	Front Axle Right	Hatchback FWD CNXA		Rod Assembly	S100434
	2015.06-	Front Axle Left & Right	Hatchback FWD CNXA		Rod/Strut, stabiliser	S050040
	2015.06-	Rear Axle Left & Right	Hatchback FWD CNXA		Rod/Strut, stabiliser	S051234
	2015.06-	Front Axle	Hatchback FWD CNXA		Steering Boot	541209
	2015.06-	Front Axle	Hatchback FWD CNXA		Steering Rack Bellow Kit	541209S



	 YEAR	FITTING POSITION	BODY STYLE & DRIVE TYPE & ENGINE	REMARKS	PRODUCT	GSP Ref.
VW Golf						
1.8 (66 kw)	1991.08-1997.12	Front Axle Left & Right Lower	Hatchback FWD ABS/ACC/ADZ		Track Control Arm	S060765
	1991.08-1997.12	Front Axle Left & Right Lower	Hatchback FWD ABS/ACC/ADZ		Ball Joint	S080211
	1991.08-1997.12	Front Axle Left & Right Lower	Hatchback FWD ABS/ACC/ADZ		Control Arm Bushing	510025
	1991.08-1997.12	Front Axle Left & Right Lower	Hatchback FWD ABS/ACC/ADZ		Control Arm Bushing	510084
	1991.08-1997.12	Front Axle Left	Hatchback FWD ABS/ACC/ADZ		Rod Assembly	S100128
	1991.08-1997.12	Front Axle Left	Hatchback FWD ABS/ACC/ADZ		Rod Assembly	S100148
	1991.08-1997.12	Front Axle Right	Hatchback FWD ABS/ACC/ADZ		Rod Assembly	S100129
	1991.08-1997.12	Front Axle Right	Hatchback FWD ABS/ACC/ADZ	for vehicles without power steering	Rod Assembly	S100149
	1991.08-1997.12	Front Axle Left & Right	Hatchback FWD ABS/ACC/ADZ		Tie Rod Axle Joint	S030313
	1991.08-1997.12	Front Axle Left & Right	Hatchback FWD ABS/ACC/ADZ	for vehicles with power steering.For PR no.:1N1	Tie Rod Axle Joint	S030641
	1991.08-1997.12	Front Axle Left & Right	Hatchback FWD ABS/ACC/ADZ	for vehicles with power steering	Tie Rod Axle Joint	S030822
	1991.08-1997.12	Front Axle Left	Hatchback FWD ABS/ACC/ADZ		Tie Rod End	S070419
	1991.08-1997.12	Front Axle Right	Hatchback FWD ABS/ACC/ADZ		Tie Rod End	S070418
	1991.08-1997.12	Front Axle Left & Right	Hatchback FWD ABS/ACC/ADZ		Rod/Strut, stabiliser	510030
	1991.08-1997.12	Front Axle	Hatchback FWD ABS/ACC/ADZ		Stabiliser Bushing	510219
	1991.08-1997.12	Front Axle	Hatchback FWD ABS/ACC/ADZ		Steering Boot	540016
	1991.08-1997.12	Front Axle	Hatchback FWD ABS/ACC/ADZ		Steering Boot	540384
	1991.08-1997.12	Front Axle	Hatchback FWD ABS/ACC/ADZ	for vehicles with power steering	Steering Rack Bellow Kit	541026S
	1991.08-1997.12	Front Axle Left & Right	Hatchback FWD ABS/ACC/ADZ		Securing Plate, ball joint	510023S
1.8 (81 kw)	2000.01-2002.12	Front Axle Left & Right	Convertible FWD		Tie Rod Axle Joint	S030313
1.8 (110 kw)	1997.08-2005.06	Front Axle Left Lower	Hatchback FWD AGU/AQA/ARZ/AUM/AWD		Track Control Arm	S060339
	1997.08-2005.06	Front Axle Right Lower	Hatchback FWD AGU/AQA/ARZ/AUM/AWD		Track Control Arm	S060340
	1997.08-2005.06	Front Axle Left & Right Lower	Hatchback FWD AGU/AQA/ARZ/AUM/AWD		Track Control Arm	S061643
	1997.08-2005.06	Front Axle Left Lower	Hatchback FWD AGU/AQA/ARZ/AUM/AWD		Ball Joint	S080016
	1997.08-2005.06	Front Axle Right Lower	Hatchback FWD AGU/AQA/ARZ/AUM/AWD		Ball Joint	S080017
	1997.08-2005.06	Front Axle Left & Right Lower	Hatchback FWD AGU/AQA/ARZ/AUM/AWD		Control Arm Bushing	510065
	1997.08-2005.06	Front Axle Left & Right Lower	Hatchback FWD AGU/AQA/ARZ/AUM/AWD		Control Arm Bushing	510084
	1997.08-2005.06	Front Axle	Hatchback FWD AGU/AQA/ARZ/AUM/AWD		Suspension Repair Kit	S990016SK
	1997.08-2005.06	Front Axle Left	Hatchback FWD AGU/AQA/ARZ/AUM/AWD		Rod Assembly	S100011
	1997.08-2005.06	Front Axle Left	Hatchback FWD AGU/AQA/ARZ/AUM/AWD	Engine code:AGU,AUM,Date to:1998.01	Rod Assembly	S100015
	1997.08-2005.06	Front Axle Right	Hatchback FWD AGU/AQA/ARZ/AUM/AWD		Rod Assembly	S100010
	1997.08-2005.06	Front Axle Right	Hatchback FWD AGU/AQA/ARZ/AUM/AWD		Rod Assembly	S100016
	1997.08-2005.06	Front Axle Left & Right	Hatchback FWD AGU/AQA/ARZ/AUM/AWD		Tie Rod Axle Joint	S030011
	1997.08-2005.06	Front Axle Left	Hatchback FWD AGU/AQA/ARZ/AUM/AWD	Engine code:AGU,AUM,Date to:1998.01	Tie Rod End	S070039
	1997.08-2005.06	Front Axle Left	Hatchback FWD AGU/AQA/ARZ/AUM/AWD	Engine code:AGU,AUM,Date from:1988.01;Engine code:ARZ,ARV,AGU,AGA,AWD	Tie Rod End	S071340
	1997.08-2005.06	Front Axle Right	Hatchback FWD AGU/AQA/ARZ/AUM/AWD	Engine code:AGU,AUM,Date to:1998.01	Tie Rod End	S070040
	1997.08-2005.06	Front Axle Right	Hatchback FWD AGU/AQA/ARZ/AUM/AWD	Engine code:AGU,AUM,Date from:1988.01;Engine code:ARZ,ARV,AGU,AGA,AWD	Tie Rod End	S071341
	1997.08-2005.06	Front Axle Left	Hatchback FWD AGU/AQA/ARZ/AUM/AWD		Rod/Strut, stabiliser	S050043
	1997.08-2005.06	Front Axle Right	Hatchback FWD AGU/AQA/ARZ/AUM/AWD		Rod/Strut, stabiliser	S050036
	1997.08-2005.06	Front Axle Left & Right	Hatchback FWD AGU/AQA/ARZ/AUM/AWD	Engine code:AGU,AUM,Date from:1988.01;Engine code:ARZ,ARV,AGU,AGA,AWD	Rod/Strut, stabiliser	510067
	1997.08-2005.06	Front Axle Left & Right	Hatchback FWD AGU/AQA/ARZ/AUM/AWD		Rod/Strut, stabiliser	510067S
	1997.08-2005.06	Front Axle Left & Right	Hatchback FWD AGU/AQA/ARZ/AUM/AWD		Rod/Strut, stabiliser	510068
	1997.08-2005.06	Front Axle Left & Right	Hatchback FWD AGU/AQA/ARZ/AUM/AWD		Rod/Strut, stabiliser	510068S
	1997.08-2005.06	Front Axle Left & Right	Hatchback FWD AGU/AQA/ARZ/AUM/AWD		Rod/Strut, stabiliser	512249
	1997.08-2005.06	Front Axle Left & Right	Hatchback FWD AGU/AQA/ARZ/AUM/AWD	Date from-to:2000.06-2001.04,For PR code: 04E	Rod/Strut, stabiliser	S050052
	1997.08-2005.06	Front Axle	Hatchback FWD AGU/AQA/ARZ/AUM/AWD		Stabiliser Bushing	510232
	1997.08-2005.06	Front Axle	Hatchback FWD AGU/AQA/ARZ/AUM/AWD	Engine Code: ARZ, ARV, AGU, AWD, ARZ for PR no. 04L,04M for PR no. 04E	Stabiliser Bushing	510316
	1997.08-2005.06	Front Axle	Hatchback FWD AGU/AQA/ARZ/AUM/AWD		Stabiliser Bushing	517166
	1997.08-2005.06	Front Axle	Hatchback FWD AGU/AQA/ARZ/AUM/AWD		Steering Boot	540227
	1997.08-2005.06	Front Axle	Hatchback FWD AGU/AQA/ARZ/AUM/AWD		Stabiliser Bushing Kit	510066S
1.8 (127 kw)	1999.09-2005.06	Front Axle Left	Hatchback FWD		Rod Assembly	S100015
	1999.09-2005.06	Front Axle Right	Hatchback FWD		Rod Assembly	S100016
	1999.09-2005.06	Front Axle Left & Right	Hatchback FWD		Tie Rod Axle Joint	S030011
	1999.09-2005.06	Front Axle Left	Hatchback FWD		Tie Rod End	S070039
	1999.09-2005.06	Front Axle Right	Hatchback FWD		Tie Rod End	S070040
	1999.09-2005.06	Front Axle	Hatchback FWD		Stabiliser Bushing	510066
	1999.09-2005.06	Front Axle	Hatchback FWD		Stabiliser Bushing	510232
	1999.09-2005.06	Front Axle	Hatchback FWD		Stabiliser Bushing	517166
1.8 (132 kw)	2001.06-2007.03	Front Axle Left Lower	Hatchback FWD AUQ		Track Control Arm	S060339
	2001.06-2007.03	Front Axle Right Lower	Hatchback FWD AUQ		Track Control Arm	S060340
	2001.06-2007.03	Front Axle Left & Right Lower	Hatchback FWD AUQ		Track Control Arm	S061643
	2001.06-2007.03	Front Axle Left Lower	Hatchback FWD AUQ		Ball Joint	S080016
	2001.06-2007.03	Front Axle Right Lower	Hatchback FWD AUQ		Ball Joint	S080017
	2001.06-2007.03	Front Axle Left & Right Lower	Hatchback FWD AUQ		Control Arm Bushing	510065



	 YEAR	FITTING POSITION	BODY STYLE & DRIVE TYPE & ENGINE	REMARKS	PRODUCT	GSP Ref.
VW Golf						
1.8 (132 kw)	2001.06-2007.03	Front Axle Left & Right Lower	Hatchback FWD AUQ		Control Arm Bushing	510084
	2001.06-2007.03	Front Axle	Hatchback FWD AUQ		Suspension Repair Kit	S990016SK
	2001.06-2007.03	Front Axle Left	Hatchback FWD AUQ		Rod Assembly	S100011
	2001.06-2007.03	Front Axle Left	Hatchback FWD AUQ		Rod Assembly	S100015
	2001.06-2007.03	Front Axle Right	Hatchback FWD AUQ		Rod Assembly	S100010
	2001.06-2007.03	Front Axle Right	Hatchback FWD AUQ		Rod Assembly	S100016
	2001.06-2007.03	Front Axle Left & Right	Hatchback FWD AUQ		Tie Rod Axle Joint	S030011
	2001.06-2007.03	Front Axle Left	Hatchback FWD AUQ		Tie Rod End	S070039
	2001.06-2007.03	Front Axle Left	Hatchback FWD AUQ		Tie Rod End	S071340
	2001.06-2007.03	Front Axle Right	Hatchback FWD AUQ		Tie Rod End	S070040
	2001.06-2007.03	Front Axle Right	Hatchback FWD AUQ		Tie Rod End	S071341
	2001.06-2007.03	Front Axle Left	Hatchback FWD AUQ		Rod/Strut, stabiliser	S050043
	2001.06-2007.03	Front Axle Right	Hatchback FWD AUQ		Rod/Strut, stabiliser	S050036
	2001.06-2007.03	Front Axle Left & Right	Hatchback FWD AUQ	Engine Code: AUG for PR no. 0AL/0AM Engine Code: AHP for PR no. 0AL	Rod/Strut, stabiliser	510067
	2001.06-2007.03	Front Axle Left & Right	Hatchback FWD AUQ		Rod/Strut, stabiliser	510067S
	2001.06-2007.03	Front Axle Left & Right	Hatchback FWD AUQ		Rod/Strut, stabiliser	510068
	2001.06-2007.03	Front Axle Left & Right	Hatchback FWD AUQ		Rod/Strut, stabiliser	510068S
	2001.06-2007.03	Front Axle Left & Right	Hatchback FWD AUQ	For PR code: 0AE	Rod/Strut, stabiliser	S050052
	2001.06-2007.03	Front Axle	Hatchback FWD AUQ		Stabiliser Bushing	510232
	2001.06-2007.03	Front Axle	Hatchback FWD AUQ	Engine Code: AUG for PR no. 0AL/0AM for PR no. 0AE	Stabiliser Bushing	510316
	2001.06-2007.03	Front Axle	Hatchback FWD AUQ		Stabiliser Bushing	517166
2001.06-2007.03	Front Axle	Hatchback FWD AUQ		Steering Boot	540227	
2001.06-2007.03	Front Axle	Hatchback FWD AUQ		Stabiliser Bushing Kit	510066S	
1.8 (142 kw)	2007.04-2008.05	Front Axle Left & Right Lower	Hatchback FWD AUQ		Control Arm Bushing	510084
	2007.04-2008.05	Front Axle Left	Hatchback FWD AUQ		Rod Assembly	S100011
	2007.04-2008.05	Front Axle Right	Hatchback FWD AUQ		Rod Assembly	S100010
	2007.04-2008.05	Front Axle Left & Right	Hatchback FWD AUQ		Tie Rod Axle Joint	S030011
	2007.04-2008.05	Front Axle Left	Hatchback FWD AUQ		Tie Rod End	S071340
	2007.04-2008.05	Front Axle Right	Hatchback FWD AUQ		Tie Rod End	S071341
2.0 (85 kw)	1991.11-1997.08	Front Axle Left & Right Lower	Hatchback FWD 2E/ABA/ADY/AGG/AKR		Track Control Arm	S060765
	1991.11-1997.08	Front Axle Left & Right Lower	Hatchback FWD 2E/ABA/ADY/AGG/AKR	Engine code: ABA, AGG, ADY, 2E, Date to: 1996.12.AT	Ball Joint	S080211
	1991.11-1997.08	Front Axle Left & Right Lower	Hatchback FWD 2E/ABA/ADY/AGG/AKR		Ball Joint	S080212
	1991.11-1997.08	Front Axle Left & Right Lower	Hatchback FWD 2E/ABA/ADY/AGG/AKR		Control Arm Bushing	510025
	1991.11-1997.08	Front Axle Left & Right Lower	Hatchback FWD 2E/ABA/ADY/AGG/AKR	Engine Code: ADC, ABA, AGG, ADY, 2E	Control Arm Bushing	510084
	1991.11-1997.08	Front Axle Left	Hatchback FWD 2E/ABA/ADY/AGG/AKR		Rod Assembly	S100128
	1991.11-1997.08	Front Axle Left	Hatchback FWD 2E/ABA/ADY/AGG/AKR		Rod Assembly	S100148
	1991.11-1997.08	Front Axle Right	Hatchback FWD 2E/ABA/ADY/AGG/AKR		Rod Assembly	S100129
	1991.11-1997.08	Front Axle Right	Hatchback FWD 2E/ABA/ADY/AGG/AKR	for vehicles without power steering	Rod Assembly	S100149
	1991.11-1997.08	Front Axle Left & Right	Hatchback FWD 2E/ABA/ADY/AGG/AKR		Tie Rod Axle Joint	S030313
	1991.11-1997.08	Front Axle Left & Right	Hatchback FWD 2E/ABA/ADY/AGG/AKR	Engine code: AGG, ABA, AGG, ADY, 2E for vehicles with power steering for PR no. 2E1	Tie Rod Axle Joint	S030641
	1991.11-1997.08	Front Axle Left	Hatchback FWD 2E/ABA/ADY/AGG/AKR		Tie Rod End	S070419
	1991.11-1997.08	Front Axle Right	Hatchback FWD 2E/ABA/ADY/AGG/AKR		Tie Rod End	S070418
	1991.11-1997.08	Front Axle Left & Right	Hatchback FWD 2E/ABA/ADY/AGG/AKR		Rod/Strut, stabiliser	510030
	1991.11-1997.08	Front Axle Left & Right	Hatchback FWD 2E/ABA/ADY/AGG/AKR	Engine code: AGG, ABA, AGG, ADY, 2E, ABA for PR no. 2E1	Rod/Strut, stabiliser	S100127
	1991.11-1997.08	Front Axle	Hatchback FWD 2E/ABA/ADY/AGG/AKR		Stabiliser Bushing	510219
	1991.11-1997.08	Front Axle	Hatchback FWD 2E/ABA/ADY/AGG/AKR		Steering Boot	540016
	1991.11-1997.08	Front Axle	Hatchback FWD 2E/ABA/ADY/AGG/AKR		Steering Boot	540384
	1991.11-1997.08	Front Axle	Hatchback FWD 2E/ABA/ADY/AGG/AKR	for vehicles with power steering	Steering Rack Bellow Kit	541026S
	1991.11-1997.08	Front Axle Left & Right	Hatchback FWD 2E/ABA/ADY/AGG/AKR		Securing Plate, ball joint	510023S
	1998.08-2004.07	Front Axle Left Lower	Hatchback FWD AEG/APK/AQY/AZG/AZJ		Track Control Arm	S060339
	1998.08-2004.07	Front Axle Right Lower	Hatchback FWD AEG/APK/AQY/AZG/AZJ		Track Control Arm	S060340
	1998.08-2004.07	Front Axle Left & Right Lower	Hatchback FWD AEG/APK/AQY/AZG/AZJ		Track Control Arm	S061643
	1998.08-2004.07	Front Axle Left Lower	Hatchback FWD AEG/APK/AQY/AZG/AZJ		Ball Joint	S080016
	1998.08-2004.07	Front Axle Right Lower	Hatchback FWD AEG/APK/AQY/AZG/AZJ		Ball Joint	S080017
	1998.08-2004.07	Front Axle Left & Right Lower	Hatchback FWD AEG/APK/AQY/AZG/AZJ		Control Arm Bushing	510065
	1998.08-2004.07	Front Axle Left & Right Lower	Hatchback FWD AEG/APK/AQY/AZG/AZJ		Control Arm Bushing	510084
	1998.08-2004.07	Front Axle	Hatchback FWD AEG/APK/AQY/AZG/AZJ		Suspension Repair Kit	S990016SK
	1998.08-2004.07	Front Axle Left	Hatchback FWD AEG/APK/AQY/AZG/AZJ		Rod Assembly	S100011
	1998.08-2004.07	Front Axle Left	Hatchback FWD AEG/APK/AQY/AZG/AZJ		Rod Assembly	S100015
1998.08-2004.07	Front Axle Right	Hatchback FWD AEG/APK/AQY/AZG/AZJ		Rod Assembly	S100010	
1998.08-2004.07	Front Axle Right	Hatchback FWD AEG/APK/AQY/AZG/AZJ		Rod Assembly	S100016	
1998.08-2004.07	Front Axle Left & Right	Hatchback FWD AEG/APK/AQY/AZG/AZJ		Tie Rod Axle Joint	S030011	
1998.08-2004.07	Front Axle Left	Hatchback FWD AEG/APK/AQY/AZG/AZJ		Tie Rod End	S070039	
1998.08-2004.07	Front Axle Left	Hatchback FWD AEG/APK/AQY/AZG/AZJ		Tie Rod End	S071340	

	 YEAR	FITTING POSITION	BODY STYLE & DRIVE TYPE & ENGINE	REMARKS	PRODUCT	GSP Ref.
VW Golf						
2.0 (85 kw)	1998.08-2004.07	Front Axle Right	Hatchback FWD AEG/APK/AQY/AZG/AZJ		Tie Rod End	S070040
	1998.08-2004.07	Front Axle Right	Hatchback FWD AEG/APK/AQY/AZG/AZJ		Tie Rod End	S071341
	1998.08-2004.07	Front Axle Left	Hatchback FWD AEG/APK/AQY/AZG/AZJ		Rod/Strut, stabiliser	S050043
	1998.08-2004.07	Front Axle Right	Hatchback FWD AEG/APK/AQY/AZG/AZJ		Rod/Strut, stabiliser	S050036
	1998.08-2004.07	Front Axle Left & Right	Hatchback FWD AEG/APK/AQY/AZG/AZJ		Rod/Strut, stabiliser	510067
	1998.08-2004.07	Front Axle Left & Right	Hatchback FWD AEG/APK/AQY/AZG/AZJ		Rod/Strut, stabiliser	510067S
	1998.08-2004.07	Front Axle Left & Right	Hatchback FWD AEG/APK/AQY/AZG/AZJ		Rod/Strut, stabiliser	510068
	1998.08-2004.07	Front Axle Left & Right	Hatchback FWD AEG/APK/AQY/AZG/AZJ		Rod/Strut, stabiliser	510068S
	1998.08-2004.07	Front Axle Left & Right	Hatchback FWD AEG/APK/AQY/AZG/AZJ		Rod/Strut, stabiliser	512249
	1998.08-2004.07	Front Axle Left & Right	Hatchback FWD AEG/APK/AQY/AZG/AZJ	Date from-to 2000.08-2001.04, For PR code: 04E	Rod/Strut, stabiliser	S050052
	1998.08-2004.07	Front Axle	Hatchback FWD AEG/APK/AQY/AZG/AZJ		Stabiliser Bushing	510232
	1998.08-2004.07	Front Axle	Hatchback FWD AEG/APK/AQY/AZG/AZJ	Engine Code: AQY/AZG/AZK/PR no. 04L/04M for PR no. 04E	Stabiliser Bushing	510316
	1998.08-2004.07	Front Axle	Hatchback FWD AEG/APK/AQY/AZG/AZJ		Stabiliser Bushing	517166
	1998.08-2004.07	Front Axle	Hatchback FWD AEG/APK/AQY/AZG/AZJ		Steering Boot	540227
	1998.08-2004.07	Front Axle	Hatchback FWD AEG/APK/AQY/AZG/AZJ		Stabiliser Bushing Kit	510066S
	2007.01-2010.12	Front Axle Left & Right Lower	Hatchback FWD BER/BEV/CBPA		Control Arm Bushing	510084
	2007.01-2010.12	Front Axle Left	Hatchback FWD BER/BEV/CBPA		Rod Assembly	S100011
	2007.01-2010.12	Front Axle Right	Hatchback FWD BER/BEV/CBPA		Rod Assembly	S100010
	2007.01-2010.12	Front Axle Left & Right	Hatchback FWD BER/BEV/CBPA		Tie Rod Axle Joint	S030011
	2007.01-2010.12	Front Axle Left	Hatchback FWD BER/BEV/CBPA		Tie Rod End	S071340
2007.01-2010.12	Front Axle Right	Hatchback FWD BER/BEV/CBPA		Tie Rod End	S071341	
2.0 (162 kw)	2013.04-	Front Axle Left Lower	Hatchback FWD CHHB/CNTC/CXDA	Engine Code: CHHB, CNTC, CXDA	Track Control Arm	S062137
	2013.04-	Front Axle Left Lower	Hatchback FWD CHHB/CNTC/CXDA	For OE no. 5QM407151A, With ball joint	Track Control Arm	S062976
	2013.04-	Front Axle Right Lower	Hatchback FWD CHHB/CNTC/CXDA	Engine code: CHHB, CXCB, CXDA, Date to 2019.06	Track Control Arm	S062134
	2013.04-	Front Axle Right Lower	Hatchback FWD CHHB/CNTC/CXDA	With ball joint	Track Control Arm	S062977
	2013.04-	Rear Axle Left & Right Lower Inner	Hatchback FWD CHHB/CNTC/CXDA		Track Control Arm	S062791
	2013.04-	Rear Axle Left & Right Lower Outer	Hatchback FWD CHHB/CNTC/CXDA		Track Control Arm	S062899
	2013.04-	Front Axle Left Lower	Hatchback FWD CHHB/CNTC/CXDA	Equipment Vari. PR-12E, 12F, 12P STEEL WHEEL BEARING	Ball Joint	S080013
	2013.04-	Front Axle Left Lower	Hatchback FWD CHHB/CNTC/CXDA	Engine code: CHHB, CNTC, CXDA, Engine code: CXCB, CXDA	Ball Joint	S080258
	2013.04-	Front Axle Right Lower	Hatchback FWD CHHB/CNTC/CXDA	Equipment Vari. PR-12E, 12F, 12P STEEL WHEEL BEARING	Ball Joint	S080012
	2013.04-	Front Axle Right Lower	Hatchback FWD CHHB/CNTC/CXDA	Engine Code: CHHB, CNTC, CXDA, Engine Code: CXCB, CXDA	Ball Joint	S080259
	2013.04-	Front Axle Left & Right Lower	Hatchback FWD CHHB/CNTC/CXDA		Control Arm Bushing	510361
	2013.04-	Front Axle Left & Right Lower	Hatchback FWD CHHB/CNTC/CXDA		Control Arm Bushing	531431
	2013.04-	Rear Axle Left & Right Centre	Hatchback FWD CHHB/CNTC/CXDA		Control Arm Bushing	512203
	2013.04-	Rear Axle Left & Right Upper	Hatchback FWD CHHB/CNTC/CXDA		Control Arm Bushing	516372
	2013.04-	Rear Axle Left & Right Upper	Hatchback FWD CHHB/CNTC/CXDA		Control Arm Bushing	516408
	2013.04-	Rear Axle Left & Right Lower Inner	Hatchback FWD CHHB/CNTC/CXDA		Control Arm Bushing	535309
	2013.04-	Front Axle	Hatchback FWD CHHB/CNTC/CXDA		Suspension Repair Kit	S990061SK
	2013.04-	Front Axle Left & Right	Hatchback FWD CHHB/CNTC/CXDA		Tie Rod Axle Joint	S030009
	2013.04-	Front Axle Left	Hatchback FWD CHHB/CNTC/CXDA		Tie Rod End	S070032
	2013.04-	Front Axle Right	Hatchback FWD CHHB/CNTC/CXDA		Tie Rod End	S070033
	2013.04-	Front Axle Left & Right	Hatchback FWD CHHB/CNTC/CXDA		Rod/Strut, stabiliser	S050040
	2013.04-	Rear Axle Left & Right	Hatchback FWD CHHB/CNTC/CXDA		Rod/Strut, stabiliser	S051234
	2.0 (169 kw)	2013.04-	Front Axle Left Lower	Hatchback FWD CHHA	Engine Code: CHHA	Track Control Arm
2013.04-		Front Axle Left Lower	Hatchback FWD CHHA	For OE no. 5QM407151A, With ball joint	Track Control Arm	S062976
2013.04-		Front Axle Right Lower	Hatchback FWD CHHA	Engine Code: CHHA	Track Control Arm	S062134
2013.04-		Front Axle Right Lower	Hatchback FWD CHHA	With ball joint	Track Control Arm	S062977
2013.04-		Rear Axle Left & Right Lower Inner	Hatchback FWD CHHA		Track Control Arm	S062791
2013.04-		Rear Axle Left & Right Lower Outer	Hatchback FWD CHHA		Track Control Arm	S062899
2013.04-		Front Axle Left Lower	Hatchback FWD CHHA	Equipment Vari. PR-12E, 12F, 12P STEEL WHEEL BEARING	Ball Joint	S080013
2013.04-		Front Axle Left Lower	Hatchback FWD CHHA	Engine code: CXDB, CHHA, Engine code: CXDB	Ball Joint	S080258
2013.04-		Front Axle Right Lower	Hatchback FWD CHHA	Equipment Vari. PR-12E, 12F, 12P STEEL WHEEL BEARING	Ball Joint	S080012
2013.04-		Front Axle Right Lower	Hatchback FWD CHHA	Engine Code: CXDB, CHHA, Engine Code: CXDB	Ball Joint	S080259
2013.04-		Front Axle Left & Right Lower	Hatchback FWD CHHA		Control Arm Bushing	510361
2013.04-		Front Axle Left & Right Lower	Hatchback FWD CHHA		Control Arm Bushing	531431
2013.04-		Rear Axle Left & Right Centre	Hatchback FWD CHHA		Control Arm Bushing	512203
2013.04-		Rear Axle Left & Right Upper	Hatchback FWD CHHA		Control Arm Bushing	516372
2013.04-		Rear Axle Left & Right Upper	Hatchback FWD CHHA		Control Arm Bushing	516408
2013.04-		Rear Axle Left & Right Lower Inner	Hatchback FWD CHHA		Control Arm Bushing	535309
2013.04-		Front Axle	Hatchback FWD CHHA		Suspension Repair Kit	S990061SK
2013.04-		Front Axle Left & Right	Hatchback FWD CHHA		Tie Rod Axle Joint	S030009
2013.04-		Front Axle Left	Hatchback FWD CHHA		Tie Rod End	S070032
2013.04-		Front Axle Right	Hatchback FWD CHHA		Tie Rod End	S070033
2013.04-		Front Axle Left & Right	Hatchback FWD CHHA		Rod/Strut, stabiliser	S050040



	 YEAR	FITTING POSITION	BODY STYLE & DRIVE TYPE & ENGINE	REMARKS	PRODUCT	GSP Ref.
VW Golf						
2.0 (169 kw)	2013.04-	Rear Axle Left & Right	Hatchback FWD CHHA		Rod/Strut, stabiliser	S051234
2.0 (170 kw)	2018.09-	Front Axle Left Lower	Hatchback FWD DKFA		Ball Joint	S080258
	2018.09-	Rear Axle Left & Right Lower Inner	Hatchback FWD DKFA		Control Arm Bushing	535309
	2018.09-	Front Axle Left	Hatchback FWD DKFA		Rod Assembly	S100435
	2018.09-	Front Axle Right	Hatchback FWD DKFA		Rod Assembly	S100434
	2018.09-	Front Axle Left & Right	Hatchback FWD DKFA		Rod/Strut, stabiliser	S050040
	2018.09-	Front Axle	Hatchback FWD DKFA		Steering Boot	541209
	2018.09-	Front Axle	Hatchback FWD DKFA		Steering Rack Bellow Kit	541209S
2.8 (128 kw)	1992.01-1997.12	Front Axle Left & Right Lower	Hatchback FWD AAA		Ball Joint	S080212
	1992.01-1997.12	Front Axle Left & Right Lower	Hatchback FWD AAA		Control Arm Bushing	510025
	1992.01-1997.12	Front Axle Left & Right Lower	Hatchback FWD AAA		Control Arm Bushing	510084
	1992.01-1997.12	Front Axle Left	Hatchback FWD AAA		Rod Assembly	S100148
	1992.01-1997.12	Front Axle Right	Hatchback FWD AAA		Rod Assembly	S100129
	1992.01-1997.12	Front Axle Right	Hatchback FWD AAA	for vehicles without power steering	Rod Assembly	S100149
	1992.01-1997.12	Front Axle Left & Right	Hatchback FWD AAA		Tie Rod Axle Joint	S030313
	1992.01-1997.12	Front Axle Left & Right	Hatchback FWD AAA	for vehicles with power steering, For PR no.:1N1	Tie Rod Axle Joint	S030641
	1992.01-1997.12	Front Axle Left	Hatchback FWD AAA		Tie Rod End	S070419
	1992.01-1997.12	Front Axle Right	Hatchback FWD AAA		Tie Rod End	S070418
	1992.01-1997.12	Front Axle Left & Right	Hatchback FWD AAA		Rod/Strut, stabiliser	S100127
	1992.01-1997.12	Front Axle	Hatchback FWD AAA		Steering Boot	540016
	1992.01-1997.12	Front Axle	Hatchback FWD AAA		Steering Boot	540384
	1992.01-1997.12	Front Axle	Hatchback FWD AAA	for vehicles with power steering	Steering Rack Bellow Kit	541026S
2.8 (147 kw)	2002.03-2005.10	Front Axle Left Lower	Hatchback FWD BDF		Track Control Arm	S060339
	2002.03-2005.10	Front Axle Right Lower	Hatchback FWD BDF		Track Control Arm	S060340
	2002.03-2005.10	Front Axle Left & Right Lower	Hatchback FWD BDF		Track Control Arm	S061643
	2002.03-2005.10	Front Axle Left & Right Lower	Hatchback FWD BDF		Control Arm Bushing	510084
	2002.03-2005.10	Front Axle Left	Hatchback FWD BDF		Rod Assembly	S100011
	2002.03-2005.10	Front Axle Left	Hatchback FWD BDF		Rod Assembly	S100015
	2002.03-2005.10	Front Axle Right	Hatchback FWD BDF		Rod Assembly	S100010
	2002.03-2005.10	Front Axle Right	Hatchback FWD BDF		Rod Assembly	S100016
	2002.03-2005.10	Front Axle Left & Right	Hatchback FWD BDF		Tie Rod Axle Joint	S030011
	2002.03-2005.10	Front Axle Left	Hatchback FWD BDF		Tie Rod End	S070039
	2002.03-2005.10	Front Axle Left	Hatchback FWD BDF		Tie Rod End	S071340
	2002.03-2005.10	Front Axle Right	Hatchback FWD BDF		Tie Rod End	S070040
	2002.03-2005.10	Front Axle Right	Hatchback FWD BDF		Tie Rod End	S071341
	2002.03-2005.10	Front Axle Left & Right	Hatchback FWD BDF	for PR no.:0AL	Rod/Strut, stabiliser	510067
	2002.03-2005.10	Front Axle Left & Right	Hatchback FWD BDF		Rod/Strut, stabiliser	510067S
	2002.03-2005.10	Front Axle Left & Right	Hatchback FWD BDF	for PR no.:0AE	Rod/Strut, stabiliser	510068
	2002.03-2005.10	Front Axle Left & Right	Hatchback FWD BDF	for PR no.:0AE	Rod/Strut, stabiliser	510068S
	2002.03-2005.10	Front Axle	Hatchback FWD BDF		Stabiliser Bushing	510066
	2002.03-2005.10	Front Axle	Hatchback FWD BDF		Stabiliser Bushing	510232
	2002.03-2005.10	Front Axle	Hatchback FWD BDF		Stabiliser Bushing	517166
Golf Cabrio						
2.0 (85 kw)	1994.05-1998.05	Front Axle Left & Right Lower	Cabriolet FWD 2E/ADY/AGG/AKR		Track Control Arm	S060765
	1994.05-1998.05	Front Axle Left & Right Lower	Cabriolet FWD 2E/ADY/AGG/AKR		Ball Joint	S080211
	1994.05-1998.05	Front Axle Left & Right Lower	Cabriolet FWD 2E/ADY/AGG/AKR		Control Arm Bushing	510024
	1994.05-1998.05	Front Axle Left & Right Lower	Cabriolet FWD 2E/ADY/AGG/AKR		Control Arm Bushing	510025
	1994.05-1998.05	Front Axle Left & Right Lower	Cabriolet FWD 2E/ADY/AGG/AKR		Control Arm Bushing	510084
	1994.05-1998.05	Front Axle Left & Right Lower	Cabriolet FWD 2E/ADY/AGG/AKR		Control Arm Bushing Kit	510312S
	1994.05-1998.05	Front Axle Left	Cabriolet FWD 2E/ADY/AGG/AKR		Rod Assembly	S100128
	1994.05-1998.05	Front Axle Left	Cabriolet FWD 2E/ADY/AGG/AKR	Engine Code 2E, for vehicles without power steering	Rod Assembly	S100148
	1994.05-1998.05	Front Axle Right	Cabriolet FWD 2E/ADY/AGG/AKR		Rod Assembly	S100129
	1994.05-1998.05	Front Axle Right	Cabriolet FWD 2E/ADY/AGG/AKR	Engine Code 2E, for vehicles without power steering	Rod Assembly	S100149
	1994.05-1998.05	Front Axle Left & Right	Cabriolet FWD 2E/ADY/AGG/AKR		Tie Rod Axle Joint	S030313
	1994.05-1998.05	Front Axle Left & Right	Cabriolet FWD 2E/ADY/AGG/AKR	Chassis no. to:1E-R-030 000	Tie Rod Axle Joint	S030641
	1994.05-1998.05	Front Axle Left & Right	Cabriolet FWD 2E/ADY/AGG/AKR	for vehicles with power steering	Tie Rod Axle Joint	S030822
	1994.05-1998.05	Front Axle Left	Cabriolet FWD 2E/ADY/AGG/AKR		Tie Rod End	S070419
	1994.05-1998.05	Front Axle Right	Cabriolet FWD 2E/ADY/AGG/AKR		Tie Rod End	S070418
	1994.05-1998.05	Front Axle Left & Right	Cabriolet FWD 2E/ADY/AGG/AKR		Rod/Strut, stabiliser	510030
	1994.05-1998.05	Front Axle	Cabriolet FWD 2E/ADY/AGG/AKR		Stabiliser Bushing	510031
	1994.05-1998.05	Front Axle	Cabriolet FWD 2E/ADY/AGG/AKR		Stabiliser Bushing	510219
	1994.05-1998.05	Front Axle	Cabriolet FWD 2E/ADY/AGG/AKR		Steering Boot	540384
	1994.05-1998.05	Front Axle	Cabriolet FWD 2E/ADY/AGG/AKR		Steering Rack Bellow Kit	541026S



	 YEAR	FITTING POSITION	BODY STYLE & DRIVE TYPE & ENGINE	REMARKS	PRODUCT	GSP Ref.
VW						
Golf Estate/Variant						
1.4 (103 kw)	2013.05-2017.03	Front Axle Left Lower	Estate FWD CHPA	Engine code:CHPA,Date to:2019.06;Engine code:CHPA	Track Control Arm	S062137
	2013.05-2017.03	Front Axle Left Lower	Estate FWD CHPA		Track Control Arm	S062976
	2013.05-2017.03	Front Axle Right Lower	Estate FWD CHPA	Engine code:CHPA,Date to:2019.06;Engine code:CHPA	Track Control Arm	S062134
	2013.05-2017.03	Front Axle Right Lower	Estate FWD CHPA		Track Control Arm	S062977
	2013.05-2017.03	Rear Axle Left & Right Lower Inner	Estate FWD CHPA		Track Control Arm	S062791
	2013.05-2017.03	Rear Axle Left & Right Lower Outer	Estate FWD CHPA		Track Control Arm	S062899
	2013.05-2017.03	Front Axle Left Lower	Estate FWD CHPA		Ball Joint	S080258
	2013.05-2017.03	Front Axle Right Lower	Estate FWD CHPA		Ball Joint	S080259
	2013.05-2017.03	Front Axle Left & Right Lower	Estate FWD CHPA		Control Arm Bushing	510361
	2013.05-2017.03	Front Axle Left & Right Lower	Estate FWD CHPA		Control Arm Bushing	531431
	2013.05-2017.03	Rear Axle Left & Right Centre	Estate FWD CHPA		Control Arm Bushing	512203
	2013.05-2017.03	Rear Axle Left & Right Upper	Estate FWD CHPA		Control Arm Bushing	516372
	2013.05-2017.03	Rear Axle Left & Right Upper	Estate FWD CHPA		Control Arm Bushing	516408
	2013.05-2017.03	Rear Axle Left & Right Lower Inner	Estate FWD CHPA		Control Arm Bushing	535309
	2013.05-2017.03	Front Axle	Estate FWD CHPA		Suspension Repair Kit	S990061SK
	2013.05-2017.03	Front Axle Left & Right	Estate FWD CHPA		Tie Rod Axle Joint	S030009
	2013.05-2017.03	Front Axle Left	Estate FWD CHPA		Tie Rod End	S070032
	2013.05-2017.03	Front Axle Right	Estate FWD CHPA		Tie Rod End	S070033
	2013.05-2017.03	Front Axle Left & Right	Estate FWD CHPA		Rod/Strut,stabiliser	S050040
	2013.05-2017.03	Rear Axle Left & Right	Estate FWD CHPA		Rod/Strut,stabiliser	S051234
Jetta						
1.4 (110 kw)	2014.08-	Front Axle Left Lower	Saloon FWD CZDA		Track Control Arm	S062032
	2014.08-	Front Axle Left Lower	Saloon FWD CZDA		Track Control Arm	S062241
	2014.08-	Front Axle Right Lower	Saloon FWD CZDA		Track Control Arm	S061610
	2014.08-	Front Axle Right Lower	Saloon FWD CZDA		Track Control Arm	S062033
	2014.08-	Rear Axle Left Centre	Saloon FWD CZDA		Track Control Arm	S061407
	2014.08-	Rear Axle Left Lower Inner	Saloon FWD CZDA		Track Control Arm	510349
	2014.08-	Rear Axle Right Centre	Saloon FWD CZDA		Track Control Arm	S061408
	2014.08-	Rear Axle Right Lower Inner	Saloon FWD CZDA		Track Control Arm	510350
	2014.08-	Rear Axle Left & Right Lower Outer	Saloon FWD CZDA		Track Control Arm	S061468
	2014.08-	Front Axle Left Lower	Saloon FWD CZDA		Ball Joint	S080013
	2014.08-	Front Axle Right Lower	Saloon FWD CZDA		Ball Joint	S080012
	2014.08-	Front Axle Left & Right Lower	Saloon FWD CZDA		Control Arm Bushing	510361
	2014.08-	Front Axle Left & Right Lower	Saloon FWD CZDA		Control Arm Bushing	531423
	2014.08-	Rear Axle Left & Right Upper	Saloon FWD CZDA		Control Arm Bushing	516372
	2014.08-	Rear Axle Left & Right Upper	Saloon FWD CZDA		Control Arm Bushing	516408
	2014.08-	Rear Axle Left & Right Lower Inner	Saloon FWD CZDA		Control Arm Bushing	510351
	2014.08-	Rear Axle Left & Right Lower Inner	Saloon FWD CZDA		Control Arm Bushing	510352
	2014.08-	Rear Axle Left & Right Lower Outer	Saloon FWD CZDA		Control Arm Bushing	516370
	2014.08-	Front Axle Left & Right	Saloon FWD CZDA		Tie Rod Axle Joint	S030009
	2014.08-	Front Axle Left	Saloon FWD CZDA		Tie Rod End	S070032
	2014.08-	Front Axle Right	Saloon FWD CZDA		Tie Rod End	S070033
	2014.08-	Front Axle Left & Right	Saloon FWD CZDA		Rod/Strut,stabiliser	S050040
	2014.08-	Rear Axle Left & Right	Saloon FWD CZDA		Rod/Strut,stabiliser	S050035
	2014.08-	Rear Axle	Saloon FWD CZDA		Stabiliser Bushing	530183
	2014.08-	Rear Axle	Saloon FWD CZDA	for PR no.:0BH	Stabiliser Bushing	530199
	2018.05-	Front Axle Left	Saloon FWD CWLA		Rod Assembly	S100435
	2018.05-	Front Axle Right	Saloon FWD CWLA		Rod Assembly	S100434
	2018.05-	Front Axle Left & Right	Saloon FWD CWLA		Rod/Strut,stabiliser	S050040
	2018.05-	Rear Axle Left & Right	Saloon FWD CWLA		Rod/Strut,stabiliser	S051234
	2018.05-	Front Axle	Saloon FWD CWLA		Steering Boot	541209
	2018.05-	Front Axle	Saloon FWD CWLA		Steering Rack Bellow Kit	541209S
1.8 (127 kw)	1999.09-2001.12	Front Axle Left	Estate FWD		Rod Assembly	S100015
	1999.09-2001.12	Front Axle Right	Estate FWD		Rod Assembly	S100016
	1999.09-2001.12	Front Axle Left & Right	Estate FWD		Tie Rod Axle Joint	S030011
	1999.09-2001.12	Front Axle Left	Estate FWD		Tie Rod End	S070039
	1999.09-2001.12	Front Axle Right	Estate FWD		Tie Rod End	S070040
	1999.09-2001.12	Front Axle	Estate FWD		Stabiliser Bushing	510066
	1999.09-2001.12	Front Axle	Estate FWD		Stabiliser Bushing	510232
	1999.09-2001.12	Front Axle	Estate FWD		Stabiliser Bushing	517166
2.0 (85 kw)	2011.01-2014.07	Front Axle Left & Right	Estate FWD CBPA		Rod/Strut,stabiliser	S050040
	2011.01-2014.07	Rear Axle Left & Right	Estate FWD CBPA		Rod/Strut,stabiliser	S050035
2.0 (88 kw)	2010.10-2016.12	Rear Axle Right Lower Inner	Saloon FWD CKJA		Track Control Arm	510350
	2010.10-2016.12	Front Axle Left Lower	Saloon FWD CKJA		Ball Joint	S080013



	 YEAR	FITTING POSITION	BODY STYLE & DRIVE TYPE & ENGINE	REMARKS	PRODUCT	GSP Ref.
VW						
Jetta						
2.0 (88 kw)	2010.10-2016.12	Front Axle Left & Right	Saloon FWD CKJA		Rod/Strut,stabiliser	S050040
	2010.10-2016.12	Rear Axle Left & Right	Saloon FWD CKJA		Rod/Strut,stabiliser	S050035
	2010.10-2016.12	Rear Axle	Saloon FWD CKJA	for PR no.:0BJ	Stabiliser Bushing	530183
	2010.10-2016.12	Rear Axle	Saloon FWD CKJA	for PR no.:0BH	Stabiliser Bushing	530199
	2010.10-2016.12	Front Axle	Saloon FWD CKJA		Steering Boot	541209
	2010.10-2016.12	Front Axle	Saloon FWD CKJA		Steering Rack Bellow Kit	541209S
2.0 (147 kw)	2010.10-2014.07	Front Axle Left Lower	Saloon FWD CBFA/CCTA/CCZA		Track Control Arm	S062032
	2010.10-2014.07	Front Axle Left Lower	Saloon FWD CBFA/CCTA/CCZA		Track Control Arm	S062241
	2010.10-2014.07	Front Axle Right Lower	Saloon FWD CBFA/CCTA/CCZA		Track Control Arm	S061610
	2010.10-2014.07	Front Axle Right Lower	Saloon FWD CBFA/CCTA/CCZA		Track Control Arm	S062033
	2010.10-2014.07	Rear Axle Left Centre	Saloon FWD CBFA/CCTA/CCZA		Track Control Arm	S061407
	2010.10-2014.07	Rear Axle Right Centre	Saloon FWD CBFA/CCTA/CCZA		Track Control Arm	S061408
	2010.10-2014.07	Rear Axle Left & Right Lower Outer	Saloon FWD CBFA/CCTA/CCZA		Track Control Arm	S061468
	2010.10-2014.07	Front Axle Left Lower	Saloon FWD CBFA/CCTA/CCZA		Ball Joint	S080013
	2010.10-2014.07	Front Axle Right Lower	Saloon FWD CBFA/CCTA/CCZA		Ball Joint	S080012
	2010.10-2014.07	Front Axle Left & Right Lower	Saloon FWD CBFA/CCTA/CCZA		Control Arm Bushing	510361
	2010.10-2014.07	Front Axle Left & Right Lower	Saloon FWD CBFA/CCTA/CCZA		Control Arm Bushing	531423
	2010.10-2014.07	Rear Axle Left & Right Upper	Saloon FWD CBFA/CCTA/CCZA		Control Arm Bushing	516372
	2010.10-2014.07	Rear Axle Left & Right Upper	Saloon FWD CBFA/CCTA/CCZA		Control Arm Bushing	516408
	2010.10-2014.07	Rear Axle Left & Right Lower Inner	Saloon FWD CBFA/CCTA/CCZA		Control Arm Bushing	510351
	2010.10-2014.07	Rear Axle Left & Right Lower Inner	Saloon FWD CBFA/CCTA/CCZA		Control Arm Bushing	510352
	2010.10-2014.07	Rear Axle Left & Right Lower Outer	Saloon FWD CBFA/CCTA/CCZA		Control Arm Bushing	516370
	2010.10-2014.07	Front Axle Left & Right	Saloon FWD CBFA/CCTA/CCZA		Tie Rod Axle Joint	S030009
	2010.10-2014.07	Front Axle Left	Saloon FWD CBFA/CCTA/CCZA		Tie Rod End	S070032
	2010.10-2014.07	Front Axle Right	Saloon FWD CBFA/CCTA/CCZA		Tie Rod End	S070033
	2010.10-2014.07	Front Axle Left & Right	Saloon FWD CBFA/CCTA/CCZA		Rod/Strut,stabiliser	S050040
	2010.10-2014.07	Rear Axle Left & Right	Saloon FWD CBFA/CCTA/CCZA		Rod/Strut,stabiliser	S050035
	2010.10-2014.07	Rear Axle	Saloon FWD CBFA/CCTA/CCZA		Stabiliser Bushing	530183
	2010.10-2014.07	Rear Axle	Saloon FWD CBFA/CCTA/CCZA	Axle:Four-link axle,for PR no.:0BH	Stabiliser Bushing	530199
	2.0 (155 kw)	2012.12-2017.12	Front Axle Left Lower	Saloon FWD CPLA/CPPA		Track Control Arm
2012.12-2017.12		Front Axle Left Lower	Saloon FWD CPLA/CPPA		Track Control Arm	S062241
2012.12-2017.12		Front Axle Right Lower	Saloon FWD CPLA/CPPA		Track Control Arm	S061610
2012.12-2017.12		Front Axle Right Lower	Saloon FWD CPLA/CPPA		Track Control Arm	S062033
2012.12-2017.12		Rear Axle Left Centre	Saloon FWD CPLA/CPPA		Track Control Arm	S061407
2012.12-2017.12		Rear Axle Left Lower Inner	Saloon FWD CPLA/CPPA		Track Control Arm	510349
2012.12-2017.12		Rear Axle Right Centre	Saloon FWD CPLA/CPPA		Track Control Arm	S061408
2012.12-2017.12		Rear Axle Right Lower Inner	Saloon FWD CPLA/CPPA		Track Control Arm	510350
2012.12-2017.12		Rear Axle Left & Right Lower Outer	Saloon FWD CPLA/CPPA		Track Control Arm	S061468
2012.12-2017.12		Front Axle Left Lower	Saloon FWD CPLA/CPPA		Ball Joint	S080013
2012.12-2017.12		Front Axle Right Lower	Saloon FWD CPLA/CPPA		Ball Joint	S080012
2012.12-2017.12		Front Axle Left & Right Lower	Saloon FWD CPLA/CPPA		Control Arm Bushing	510361
2012.12-2017.12		Front Axle Left & Right Lower	Saloon FWD CPLA/CPPA		Control Arm Bushing	531423
2012.12-2017.12		Rear Axle Left & Right Upper	Saloon FWD CPLA/CPPA		Control Arm Bushing	516372
2012.12-2017.12		Rear Axle Left & Right Upper	Saloon FWD CPLA/CPPA		Control Arm Bushing	516408
2012.12-2017.12		Rear Axle Left & Right Lower Inner	Saloon FWD CPLA/CPPA		Control Arm Bushing	510351
2012.12-2017.12		Rear Axle Left & Right Lower Inner	Saloon FWD CPLA/CPPA		Control Arm Bushing	510352
2012.12-2017.12		Rear Axle Left & Right Lower Outer	Saloon FWD CPLA/CPPA		Control Arm Bushing	516370
2012.12-2017.12		Front Axle Left & Right	Saloon FWD CPLA/CPPA		Tie Rod Axle Joint	S030009
2012.12-2017.12		Front Axle Left	Saloon FWD CPLA/CPPA		Tie Rod End	S070032
2012.12-2017.12		Front Axle Right	Saloon FWD CPLA/CPPA		Tie Rod End	S070033
2012.12-2017.12		Front Axle Left & Right	Saloon FWD CPLA/CPPA		Rod/Strut,stabiliser	S050040
2012.12-2017.12		Rear Axle Left & Right	Saloon FWD CPLA/CPPA		Rod/Strut,stabiliser	S050035
2012.12-2017.12		Rear Axle	Saloon FWD CPLA/CPPA		Stabiliser Bushing	530183
2012.12-2017.12	Rear Axle	Saloon FWD CPLA/CPPA	Engine code:CPA,CPLA for vehicles with PR no.:0BH;engine code:CPA,CPLA for PR no.:	Stabiliser Bushing	530199	
2.5 (110 kw)	2005.01-2008.06	Front Axle Left Lower	Saloon FWD BGP/BTK		Track Control Arm	S060342
	2005.01-2008.06	Front Axle Left Lower	Saloon FWD BGP/BTK	Engine code:BGQ,BGP for vehicles with headlamp levelling	Track Control Arm	S060344
	2005.01-2008.06	Front Axle Left Lower	Saloon FWD BGP/BTK	Engine code:BGQ,BGP for vehicles with headlamp levelling	Track Control Arm	S062032
	2005.01-2008.06	Front Axle Left Lower	Saloon FWD BGP/BTK	Engine code:BGQ,BGP for vehicles without headlamp levelling	Track Control Arm	S063005
	2005.01-2008.06	Front Axle Right Lower	Saloon FWD BGP/BTK		Track Control Arm	S060341
	2005.01-2008.06	Front Axle Right Lower	Saloon FWD BGP/BTK	Engine code:BGQ,BGP for vehicles with headlamp levelling	Track Control Arm	S060343
	2005.01-2008.06	Front Axle Right Lower	Saloon FWD BGP/BTK	Engine code:BGQ,BGP for vehicles with headlamp levelling	Track Control Arm	S062033
	2005.01-2008.06	Front Axle Right Lower	Saloon FWD BGP/BTK	Engine code:BGQ,BGP for vehicles without headlamp levelling	Track Control Arm	S063006
	2005.01-2008.06	Rear Axle Left Centre	Saloon FWD BGP/BTK		Track Control Arm	S061407
	2005.01-2008.06	Rear Axle Left Lower Inner	Saloon FWD BGP/BTK		Track Control Arm	510349



	 YEAR	FITTING POSITION	BODY STYLE & DRIVE TYPE & ENGINE	REMARKS	PRODUCT	GSP Ref.
VW						
Jetta						
2.5 (110 kw)	2005.01-2008.06	Rear Axle Right Centre	Saloon FWD BGP/BTK		Track Control Arm	S061408
	2005.01-2008.06	Rear Axle Right Lower Inner	Saloon FWD BGP/BTK		Track Control Arm	510350
	2005.01-2008.06	Rear Axle Left & Right Lower Outer	Saloon FWD BGP/BTK		Track Control Arm	S061468
	2005.01-2008.06	Front Axle Left Lower	Saloon FWD BGP/BTK		Ball Joint	S080013
	2005.01-2008.06	Front Axle Right Lower	Saloon FWD BGP/BTK		Ball Joint	S080012
	2005.01-2008.06	Front Axle Left Lower	Saloon FWD BGP/BTK		Control Arm Bushing	510333
	2005.01-2008.06	Front Axle Right Lower	Saloon FWD BGP/BTK		Control Arm Bushing	510334
	2005.01-2008.06	Front Axle Left & Right Lower	Saloon FWD BGP/BTK		Control Arm Bushing	510332
	2005.01-2008.06	Front Axle Left & Right Lower	Saloon FWD BGP/BTK		Control Arm Bushing	510361
	2005.01-2008.06	Rear Axle Left & Right Upper	Saloon FWD BGP/BTK		Control Arm Bushing	516372
	2005.01-2008.06	Rear Axle Left & Right Upper	Saloon FWD BGP/BTK		Control Arm Bushing	516408
	2005.01-2008.06	Rear Axle Left & Right Lower Inner	Saloon FWD BGP/BTK		Control Arm Bushing	510351
	2005.01-2008.06	Rear Axle Left & Right Lower Inner	Saloon FWD BGP/BTK		Control Arm Bushing	510352
	2005.01-2008.06	Rear Axle Left & Right Lower Outer	Saloon FWD BGP/BTK		Control Arm Bushing	516370
	2005.01-2008.06	Rear Axle	Saloon FWD BGP/BTK		Suspension Repair Kit	S990019SK
	2005.01-2008.06	Front Axle Left & Right	Saloon FWD BGP/BTK		Tie Rod Axle Joint	S030009
	2005.01-2008.06	Front Axle Left	Saloon FWD BGP/BTK		Tie Rod End	S070032
	2005.01-2008.06	Front Axle Right	Saloon FWD BGP/BTK		Tie Rod End	S070033
	2005.01-2008.06	Front Axle Left & Right	Saloon FWD BGP/BTK		Rod/Strut, stabiliser	S050040
	2005.01-2008.06	Rear Axle Left & Right	Saloon FWD BGP/BTK		Rod/Strut, stabiliser	S050035
	2005.01-2008.06	Rear Axle	Saloon FWD BGP/BTK		Stabiliser Bushing	516447
	2005.01-2008.06	Rear Axle	Saloon FWD BGP/BTK		Stabiliser Bushing	530183
	2005.01-2008.06	Rear Axle	Saloon FWD BGP/BTK	Engin code BGP for PR no.:0BH, engine code BGC, BGP for PR no.:0BH	Stabiliser Bushing	530199
2.5 (125 kw)	2007.07-2010.10	Front Axle Left Lower	Saloon FWD CBTA		Track Control Arm	S060342
	2007.07-2010.10	Front Axle Left Lower	Saloon FWD CBTA	for vehicles with headlamp levelling	Track Control Arm	S060344
	2007.07-2010.10	Front Axle Left Lower	Saloon FWD CBTA	for vehicles with headlamp levelling	Track Control Arm	S062032
	2007.07-2010.10	Front Axle Left Lower	Saloon FWD CBTA	for vehicles without headlamp levelling	Track Control Arm	S063005
	2007.07-2010.10	Front Axle Right Lower	Saloon FWD CBTA		Track Control Arm	S060341
	2007.07-2010.10	Front Axle Right Lower	Saloon FWD CBTA	for vehicles with headlamp levelling	Track Control Arm	S060343
	2007.07-2010.10	Front Axle Right Lower	Saloon FWD CBTA	for vehicles with headlamp levelling	Track Control Arm	S062033
	2007.07-2010.10	Front Axle Right Lower	Saloon FWD CBTA	for vehicles without headlamp levelling	Track Control Arm	S063006
	2007.07-2010.10	Rear Axle Left Centre	Saloon FWD CBTA		Track Control Arm	S061407
	2007.07-2010.10	Rear Axle Left Lower Inner	Saloon FWD CBTA		Track Control Arm	510349
	2007.07-2010.10	Rear Axle Right Centre	Saloon FWD CBTA		Track Control Arm	S061408
	2007.07-2010.10	Rear Axle Right Lower Inner	Saloon FWD CBTA		Track Control Arm	510350
	2007.07-2010.10	Rear Axle Left & Right Lower Outer	Saloon FWD CBTA		Track Control Arm	S061468
	2007.07-2010.10	Front Axle Left Lower	Saloon FWD CBTA		Ball Joint	S080013
	2007.07-2010.10	Front Axle Right Lower	Saloon FWD CBTA		Ball Joint	S080012
	2007.07-2010.10	Front Axle Left Lower	Saloon FWD CBTA		Control Arm Bushing	510333
	2007.07-2010.10	Front Axle Right Lower	Saloon FWD CBTA		Control Arm Bushing	510334
	2007.07-2010.10	Front Axle Left & Right Lower	Saloon FWD CBTA		Control Arm Bushing	510332
	2007.07-2010.10	Front Axle Left & Right Lower	Saloon FWD CBTA		Control Arm Bushing	510361
	2007.07-2010.10	Rear Axle Left & Right Upper	Saloon FWD CBTA		Control Arm Bushing	516372
	2007.07-2010.10	Rear Axle Left & Right Upper	Saloon FWD CBTA		Control Arm Bushing	516408
	2007.07-2010.10	Rear Axle Left & Right Lower Inner	Saloon FWD CBTA		Control Arm Bushing	510351
	2007.07-2010.10	Rear Axle Left & Right Lower Inner	Saloon FWD CBTA		Control Arm Bushing	510352
	2007.07-2010.10	Rear Axle Left & Right Lower Outer	Saloon FWD CBTA		Control Arm Bushing	516370
	2007.07-2010.10	Front Axle Left & Right	Saloon FWD CBTA		Tie Rod Axle Joint	S030009
	2007.07-2010.10	Front Axle Left	Saloon FWD CBTA		Tie Rod End	S070032
	2007.07-2010.10	Front Axle Right	Saloon FWD CBTA		Tie Rod End	S070033
	2007.07-2010.10	Front Axle Left & Right	Saloon FWD CBTA		Rod/Strut, stabiliser	S050040
	2007.07-2010.10	Rear Axle Left & Right	Saloon FWD CBTA		Rod/Strut, stabiliser	S050035
	2007.07-2010.10	Rear Axle	Saloon FWD CBTA		Stabiliser Bushing	516447
	2007.07-2010.10	Rear Axle	Saloon FWD CBTA		Stabiliser Bushing	530183
	2007.07-2010.10	Rear Axle	Saloon FWD CBTA	for PR no.:0BH	Stabiliser Bushing	530199
2.8 (130 kw)	1999.09-2004.12	Front Axle Left Lower	Saloon FWD AFP		Track Control Arm	S060339
	1999.09-2004.12	Front Axle Right Lower	Saloon FWD AFP		Track Control Arm	S060340
	1999.09-2004.12	Front Axle Left & Right Lower	Saloon FWD AFP		Track Control Arm	S061643
	1999.09-2004.12	Front Axle Left & Right Lower	Saloon FWD AFP		Control Arm Bushing	510084
	1999.09-2004.12	Front Axle Left	Saloon FWD AFP		Rod Assembly	S100011
	1999.09-2004.12	Front Axle Right	Saloon FWD AFP		Rod Assembly	S100010
	1999.09-2004.12	Front Axle Left & Right	Saloon FWD AFP		Tie Rod Axle Joint	S030011
	1999.09-2004.12	Front Axle Left	Saloon FWD AFP		Tie Rod End	S071340
	1999.09-2004.12	Front Axle Right	Saloon FWD AFP		Tie Rod End	S071341



	 YEAR	FITTING POSITION	BODY STYLE & DRIVE TYPE & ENGINE	REMARKS	PRODUCT	GSP Ref.	
VW Jetta							
2.8 (130 kw)	1999.09-2004.12	Front Axle Left & Right	Saloon FWD AFP	Engine Code:AFP;Chassis no.to:1J-X-999 000	Rod/Strut,stabiliser	510067	
	1999.09-2004.12	Front Axle Left & Right	Saloon FWD AFP		Rod/Strut,stabiliser	510067S	
	1999.09-2004.12	Front Axle Left & Right	Saloon FWD AFP	Engine Code:AFP;Chassis no.from:1J-1-480 001	Rod/Strut,stabiliser	510068	
	1999.09-2004.12	Front Axle Left & Right	Saloon FWD AFP	Engine Code:AFP;Chassis no.from:1J-1-480 001	Rod/Strut,stabiliser	510068S	
	1999.09-2004.12	Front Axle Left & Right	Saloon FWD AFP	Chassis no.:98A-Y-000 001;98A-1-187 945;for PR no.:04E	Rod/Strut,stabiliser	512249	
	1999.09-2004.12	Front Axle	Saloon FWD AFP		Stabiliser Bushing	510066	
	1999.09-2004.12	Front Axle	Saloon FWD AFP		Stabiliser Bushing	510232	
	1999.09-2004.12	Front Axle	Saloon FWD AFP		Stabiliser Bushing	517166	
	2000.09-2004.12	Front Axle Left	Estate FWD AFP		Rod Assembly	S100015	
	2000.09-2004.12	Front Axle Right	Estate FWD AFP		Rod Assembly	S100016	
	2000.09-2004.12	Front Axle Left & Right	Estate FWD AFP		Tie Rod Axle Joint	S030011	
	2000.09-2004.12	Front Axle Left	Estate FWD AFP		Tie Rod End	S070039	
	2000.09-2004.12	Front Axle Right	Estate FWD AFP		Tie Rod End	S070040	
	2000.09-2004.12	Front Axle	Estate FWD AFP		Stabiliser Bushing	510066	
	2000.09-2004.12	Front Axle	Estate FWD AFP		Stabiliser Bushing	510232	
	2000.09-2004.12	Front Axle	Estate FWD AFP		Stabiliser Bushing	517166	
	2.8 (147 kw)	2002.02-2005.07	Front Axle Left Lower	Saloon FWD BDF		Track Control Arm	S060339
		2002.02-2005.07	Front Axle Right Lower	Saloon FWD BDF		Track Control Arm	S060340
		2002.02-2005.07	Front Axle Left & Right Lower	Saloon FWD BDF		Track Control Arm	S061643
		2002.02-2005.07	Front Axle Left & Right Lower	Saloon FWD BDF		Control Arm Bushing	510084
2002.02-2005.07		Front Axle Left	Saloon FWD BDF		Rod Assembly	S100011	
2002.02-2005.07		Front Axle Right	Saloon FWD BDF		Rod Assembly	S100010	
2002.02-2005.07		Front Axle Left & Right	Saloon FWD BDF		Tie Rod Axle Joint	S030011	
2002.02-2005.07		Front Axle Left	Saloon FWD BDF		Tie Rod End	S071340	
2002.02-2005.07		Front Axle Right	Saloon FWD BDF		Tie Rod End	S071341	
2002.02-2005.07		Front Axle Left & Right	Saloon FWD BDF	Chassis no.to:1J-X-999 000	Rod/Strut,stabiliser	510067	
2002.02-2005.07		Front Axle Left & Right	Saloon FWD BDF		Rod/Strut,stabiliser	510067S	
2002.02-2005.07		Front Axle Left & Right	Saloon FWD BDF	Engine Code:BDF;Chassis no.from:1J-1-480 001	Rod/Strut,stabiliser	510068	
2002.02-2005.07		Front Axle Left & Right	Saloon FWD BDF	Engine Code:AFP;Chassis no.from:1J-1-480 001	Rod/Strut,stabiliser	510068S	
2002.02-2005.07		Front Axle	Saloon FWD BDF		Stabiliser Bushing	510066	
2002.02-2005.07		Front Axle	Saloon FWD BDF		Stabiliser Bushing	510232	
2002.02-2005.07		Front Axle	Saloon FWD BDF		Stabiliser Bushing	517166	
Jetta City							
2.0 (85 kw)	2006.09-2009.12	Front Axle Left & Right Lower	Saloon FWD BEV		Control Arm Bushing	510084	
	2006.09-2009.12	Front Axle Left & Right Lower	Estate FWD BEV		Control Arm Bushing	510084	
	2006.09-2009.12	Front Axle Left	Saloon FWD BEV		Rod Assembly	S100011	
	2006.09-2009.12	Front Axle Left	Estate FWD BEV		Rod Assembly	S100011	
	2006.09-2009.12	Front Axle Right	Saloon FWD BEV		Rod Assembly	S100010	
	2006.09-2009.12	Front Axle Right	Estate FWD BEV		Rod Assembly	S100010	
	2006.09-2009.12	Front Axle Left & Right	Saloon FWD BEV		Tie Rod Axle Joint	S030011	
	2006.09-2009.12	Front Axle Left & Right	Estate FWD BEV		Tie Rod Axle Joint	S030011	
	2006.09-2009.12	Front Axle Left	Saloon FWD BEV		Tie Rod End	S071340	
	2006.09-2009.12	Front Axle Left	Estate FWD BEV		Tie Rod End	S071340	
	2006.09-2009.12	Front Axle Right	Saloon FWD BEV		Tie Rod End	S071341	
	2006.09-2009.12	Front Axle Right	Estate FWD BEV		Tie Rod End	S071341	
	2006.09-2009.12	Front Axle Left & Right	Estate FWD BEV		Rod/Strut,stabiliser	S050040	
Kaefer/Kaver							
1.5 (32 kw)	1966.08-1970.07	Front Axle Left & Right Lower Outer	Saloon RWD H		Track Control Arm	S060054	
	1966.08-1970.07	Front Axle Left & Right Lower	Saloon RWD H		Ball Joint	S080247	
	1966.08-1970.07	Front Axle Left & Right Upper	Saloon RWD H		Ball Joint	S080246	
	1966.08-1970.07	Front Axle Left	Saloon RWD H		Tie Rod End	S070499	
	1966.08-1970.07	Front Axle Left	Saloon RWD H	for vehicles without steering damper	Tie Rod End	S070732	
	1966.08-1970.07	Front Axle Left	Saloon RWD H		Tie Rod End	S070732	
	1966.08-1970.07	Front Axle Right	Saloon RWD H	for vehicles without steering damper	Tie Rod End	S070495	
	1966.08-1970.07	Front Axle Right	Saloon RWD H		Tie Rod End	S070495	
1966.08-1970.07	Front Axle Right	Saloon RWD H		Tie Rod End	S070498		
Lupo							
1.6 (74 kw)	2004.01-2009.12	Front Axle Left & Right Lower	Hatchback FWD BLH		Control Arm Bushing	510332	
	2004.01-2009.12	Front Axle Left & Right	Hatchback FWD BLH		Rod/Strut,stabiliser	S050038	
Multivan							
2.4 (55 kw)	1997.04-2003.04	Front Axle Left Lower	BUS FWD AJA		Track Control Arm	S061409	
	1997.04-2003.04	Front Axle Right Lower	BUS FWD AJA		Track Control Arm	S061410	
	1997.04-2003.04	Front Axle Left & Right Lower	BUS FWD AJA		Ball Joint	S080245	
	1997.04-2003.04	Front Axle Left & Right Upper	BUS FWD AJA		Ball Joint	S080262	



	 YEAR	FITTING POSITION	BODY STYLE & DRIVE TYPE & ENGINE	REMARKS	PRODUCT	GSP Ref.
VW Multivan						
2.4 (55 kw)	1997.04-2003.04	Front Axle Left & Right Lower	BUS FWD AJA		Control Arm Bushing	510158
	1997.04-2003.04	Front Axle Left & Right Lower	BUS FWD AJA		Control Arm Bushing	510159
	1997.04-2003.04	Front Axle Left & Right Lower	BUS FWD AJA		Control Arm Bushing	510255
	1997.04-2003.04	Front Axle Left & Right Upper	BUS FWD AJA		Control Arm Bushing	510155
	1997.04-2003.04	Front Axle Left & Right Upper	BUS FWD AJA		Control Arm Bushing	510156
	1997.04-2003.04	Rear Axle Left & Right Lower	BUS FWD AJA		Control Arm Bushing	530212
	1997.04-2003.04	Front Axle Left	BUS FWD AJA		Tie Rod End	S070493
	1997.04-2003.04	Front Axle Right	BUS FWD AJA		Tie Rod End	S071631
	1997.04-2003.04	Front Axle Left & Right	BUS FWD AJA		Rod/Strut, stabiliser	520525
	1997.04-2003.04	Front Axle Left & Right	BUS FWD AJA		Rod/Strut, stabiliser	S050447
	1997.04-2003.04	Front Axle	BUS FWD AJA		Stabiliser Bushing	510160
	1997.04-2003.04	Front Axle	BUS FWD AJA	for vehicles without heavy duty suspension	Stabiliser Bushing	510286
	1997.04-2003.04	Front Axle	BUS FWD AJA		Stabiliser Bushing	517812
	1997.04-2003.04	Front Axle	BUS FWD AJA		Stabiliser Bushing	530221
	1997.04-2003.04	Front Axle Left & Right	BUS FWD AJA		Steering Bushing	510320
New Beetle						
2.0 (85 kw)	1998.01-2010.09	Front Axle Left Lower	Hatchback FWD AEGAPKIAQY/AVHAZGAZJBEJBERBEV/BHPICBPA		Track Control Arm	S060339
	1998.01-2010.09	Front Axle Right Lower	Hatchback FWD AEGAPKIAQY/AVHAZGAZJBEJBERBEV/BHPICBPA		Track Control Arm	S060340
	1998.01-2010.09	Front Axle Left & Right Lower	Hatchback FWD AEGAPKIAQY/AVHAZGAZJBEJBERBEV/BHPICBPA		Track Control Arm	S061643
	1998.01-2010.09	Front Axle Left Lower	Hatchback FWD AEGAPKIAQY/AVHAZGAZJBEJBERBEV/BHPICBPA		Ball Joint	S080016
	1998.01-2010.09	Front Axle Right Lower	Hatchback FWD AEGAPKIAQY/AVHAZGAZJBEJBERBEV/BHPICBPA		Ball Joint	S080017
	1998.01-2010.09	Front Axle Left & Right Lower	Hatchback FWD AEGAPKIAQY/AVHAZGAZJBEJBERBEV/BHPICBPA		Control Arm Bushing	510065
	1998.01-2010.09	Front Axle Left & Right Lower	Hatchback FWD AEGAPKIAQY/AVHAZGAZJBEJBERBEV/BHPICBPA		Control Arm Bushing	510084
	1998.01-2010.09	Front Axle	Hatchback FWD AEGAPKIAQY/AVHAZGAZJBEJBERBEV/BHPICBPA		Suspension Repair Kit	S990016SK
	1998.01-2010.09	Front Axle Left	Hatchback FWD AEGAPKIAQY/AVHAZGAZJBEJBERBEV/BHPICBPA	Engine code ADYAPKBERAZJAE5 Chassis no from 1C-W-047 125	Rod Assembly	S100011
	1998.01-2010.09	Front Axle Left	Hatchback FWD AEGAPKIAQY/AVHAZGAZJBEJBERBEV/BHPICBPA	Engine code ADYAZGAE5APK Chassis no from 1C-W-047 124	Rod Assembly	S100015
	1998.01-2010.09	Front Axle Right	Hatchback FWD AEGAPKIAQY/AVHAZGAZJBEJBERBEV/BHPICBPA	Engine code ADYAPKBERAZJAE5 Chassis no from 1C-W-047 125	Rod Assembly	S100010
	1998.01-2010.09	Front Axle Right	Hatchback FWD AEGAPKIAQY/AVHAZGAZJBEJBERBEV/BHPICBPA	Engine code ADYAZGAE5APK Chassis no from 1C-W-047 124	Rod Assembly	S100016
	1998.01-2010.09	Front Axle Left & Right	Hatchback FWD AEGAPKIAQY/AVHAZGAZJBEJBERBEV/BHPICBPA		Tie Rod Axle Joint	S030011
	1998.01-2010.09	Front Axle Left	Hatchback FWD AEGAPKIAQY/AVHAZGAZJBEJBERBEV/BHPICBPA	Engine code HEGADY Chassis no to 1C-W-047 124 Country spec model USA	Tie Rod End	S070039
	1998.01-2010.09	Front Axle Left	Hatchback FWD AEGAPKIAQY/AVHAZGAZJBEJBERBEV/BHPICBPA		Tie Rod End	S071340
	1998.01-2010.09	Front Axle Right	Hatchback FWD AEGAPKIAQY/AVHAZGAZJBEJBERBEV/BHPICBPA	Engine code HEGADY Chassis no to 1C-W-047 124 Country spec model USA	Tie Rod End	S070040
	1998.01-2010.09	Front Axle Right	Hatchback FWD AEGAPKIAQY/AVHAZGAZJBEJBERBEV/BHPICBPA		Tie Rod End	S071341
	1998.01-2010.09	Front Axle Left	Hatchback FWD AEGAPKIAQY/AVHAZGAZJBEJBERBEV/BHPICBPA		Rod/Strut, stabiliser	S050043
	1998.01-2010.09	Front Axle Right	Hatchback FWD AEGAPKIAQY/AVHAZGAZJBEJBERBEV/BHPICBPA		Rod/Strut, stabiliser	S050036
	1998.01-2010.09	Front Axle Left & Right	Hatchback FWD AEGAPKIAQY/AVHAZGAZJBEJBERBEV/BHPICBPA	Engine code HEGADY Chassis no to 1C-X-499 900-9-9-989 9003A PR 044	Rod/Strut, stabiliser	510067
	1998.01-2010.09	Front Axle Left & Right	Hatchback FWD AEGAPKIAQY/AVHAZGAZJBEJBERBEV/BHPICBPA		Rod/Strut, stabiliser	510067S
	1998.01-2010.09	Front Axle Left & Right	Hatchback FWD AEGAPKIAQY/AVHAZGAZJBEJBERBEV/BHPICBPA		Rod/Strut, stabiliser	510068
	1998.01-2010.09	Front Axle Left & Right	Hatchback FWD AEGAPKIAQY/AVHAZGAZJBEJBERBEV/BHPICBPA		Rod/Strut, stabiliser	510068S
	1998.01-2010.09	Front Axle Left & Right	Hatchback FWD AEGAPKIAQY/AVHAZGAZJBEJBERBEV/BHPICBPA		Rod/Strut, stabiliser	512249
	1998.01-2010.09	Front Axle Left & Right	Hatchback FWD AEGAPKIAQY/AVHAZGAZJBEJBERBEV/BHPICBPA	Date from:2001.01	Rod/Strut, stabiliser	S050052
	1998.01-2010.09	Front Axle	Hatchback FWD AEGAPKIAQY/AVHAZGAZJBEJBERBEV/BHPICBPA		Stabiliser Bushing	510232
	1998.01-2010.09	Front Axle	Hatchback FWD AEGAPKIAQY/AVHAZGAZJBEJBERBEV/BHPICBPA	Engine Code AEG ADY Chassis no to 1C-X-499 900-9-9-989 9003A PR 044	Stabiliser Bushing	510316
	1998.01-2010.09	Front Axle	Hatchback FWD AEGAPKIAQY/AVHAZGAZJBEJBERBEV/BHPICBPA		Stabiliser Bushing	517166
	1998.01-2010.09	Front Axle	Hatchback FWD AEGAPKIAQY/AVHAZGAZJBEJBERBEV/BHPICBPA		Steering Boot	540227
	1998.01-2010.09	Front Axle	Hatchback FWD AEGAPKIAQY/AVHAZGAZJBEJBERBEV/BHPICBPA		Stabiliser Bushing Kit	510066S
Passat						
1.8 (92 kw)	1996.12-2000.08	Front Axle Left Lower Inner	Saloon FWD ADR/APT/ARG		Track Control Arm	S060055
	1996.12-2000.08	Front Axle Left Upper Inner	Saloon FWD ADR/APT/ARG	Engine code ADR Chassis no. to 3B-VE583 008 3B-VP102 593	Track Control Arm	S060021
	1996.12-2000.08	Front Axle Left Upper Inner	Saloon FWD ADR/APT/ARG	Engine code WGL4PT104 Chassis code ADR Chassis no from 3B-VE583 008 3B-VP102 594	Track Control Arm	S062331
	1996.12-2000.08	Front Axle Left Upper Outer	Saloon FWD ADR/APT/ARG		Track Control Arm	S060048
	1996.12-2000.08	Front Axle Left Upper Outer	Saloon FWD ADR/APT/ARG		Track Control Arm	S060798
	1996.12-2000.08	Front Axle Left Upper Outer	Saloon FWD ADR/APT/ARG		Track Control Arm	S062530
	1996.12-2000.08	Front Axle Right Lower Inner	Saloon FWD ADR/APT/ARG		Track Control Arm	S060056
	1996.12-2000.08	Front Axle Right Upper Inner	Saloon FWD ADR/APT/ARG	Engine code ADR Chassis no. to 3B-VE583 008 3B-VP102 593	Track Control Arm	S060022
	1996.12-2000.08	Front Axle Right Upper Inner	Saloon FWD ADR/APT/ARG	Engine code WGL4PT104 Chassis code ADR Chassis no from 3B-VE583 008 3B-VP102 594	Track Control Arm	S062332
	1996.12-2000.08	Front Axle Right Upper Outer	Saloon FWD ADR/APT/ARG		Track Control Arm	S060049
	1996.12-2000.08	Front Axle Right Upper Outer	Saloon FWD ADR/APT/ARG		Track Control Arm	S062531
	1996.12-2000.08	Front Axle Left & Right Lower Outer	Saloon FWD ADR/APT/ARG		Track Control Arm	S060054
	1996.12-2000.08	Front Axle Left & Right Upper	Saloon FWD ADR/APT/ARG		Control Arm Bushing	510136
	1996.12-2000.08	Front Axle Left & Right Lower Inner	Saloon FWD ADR/APT/ARG		Control Arm Bushing	510135
	1996.12-2000.08	Front Axle Left & Right Lower Inner	Saloon FWD ADR/APT/ARG		Control Arm Bushing	510287
	1996.12-2000.08	Front Axle Left & Right Lower Outer	Saloon FWD ADR/APT/ARG		Control Arm Bushing	510133
	1996.12-2000.08	Front Axle Left & Right Lower Outer	Saloon FWD ADR/APT/ARG		Control Arm Bushing	510134



	 YEAR	FITTING POSITION	BODY STYLE & DRIVE TYPE & ENGINE	REMARKS	PRODUCT	GSP Ref.
VW						
Passat						
1.8 (92 kw)	1996.12-2000.08	Front Axle	Saloon FWD ADR/APT/ARG		Suspension Repair Kit	S990001SK
	1996.12-2000.08	Front Axle Left & Right	Saloon FWD ADR/APT/ARG		Rod Assembly	S100014
	1996.12-2000.08	Front Axle Left & Right	Saloon FWD ADR/APT/ARG		Tie Rod End	S070038
	1996.12-2000.08	Front Axle Left	Saloon FWD ADR/APT/ARG		Rod/Strut, stabiliser	520008
	1996.12-2000.08	Front Axle Left	Saloon FWD ADR/APT/ARG		Rod/Strut, stabiliser	S050034
	1996.12-2000.08	Front Axle Right	Saloon FWD ADR/APT/ARG		Rod/Strut, stabiliser	520010
	1996.12-2000.08	Front Axle Right	Saloon FWD ADR/APT/ARG		Rod/Strut, stabiliser	S050033
	1996.12-2000.08	Front Axle	Saloon FWD ADR/APT/ARG	Stabiliser Ø:26,8 mm	Stabiliser Bushing	510138
	1996.12-2000.08	Front Axle	Saloon FWD ADR/APT/ARG	Stabiliser Ø:29 mm	Stabiliser Bushing	510139
	1996.12-2000.08	Front Axle Left	Saloon FWD ADR/APT/ARG		Steering Boot	540043
	1996.12-2000.08	Front Axle Left	Saloon FWD ADR/APT/ARG		Steering Rack Bellow Kit	540043S
1.8 (110 kw)	1996.10-2000.11	Front Axle Left Lower Inner	Saloon FWD AEB/ANB/APU		Track Control Arm	S060055
	1996.10-2000.11	Front Axle Left Upper Inner	Saloon FWD AEB/ANB/APU	Engine code:AEB Chassis no. 10-3B-VF093 008,3B-VF102 593	Track Control Arm	S060021
	1996.10-2000.11	Front Axle Left Upper Inner	Saloon FWD AEB/ANB/APU	Engine code:AEB AEG 070A/071 Engine code:AEB Chassis no.10-3B-000 000, 000, 07102 000	Track Control Arm	S062331
	1996.10-2000.11	Front Axle Left Upper Outer	Saloon FWD AEB/ANB/APU		Track Control Arm	S060048
	1996.10-2000.11	Front Axle Left Upper Outer	Saloon FWD AEB/ANB/APU		Track Control Arm	S060798
	1996.10-2000.11	Front Axle Left Upper Outer	Saloon FWD AEB/ANB/APU		Track Control Arm	S062530
	1996.10-2000.11	Front Axle Right Lower Inner	Saloon FWD AEB/ANB/APU		Track Control Arm	S060056
	1996.10-2000.11	Front Axle Right Upper Inner	Saloon FWD AEB/ANB/APU	Engine code:AEB Chassis no. 10-3B-VF093 008,3B-VF102 593	Track Control Arm	S060022
	1996.10-2000.11	Front Axle Right Upper Inner	Saloon FWD AEB/ANB/APU	Engine code:AEB AEG 070A/071 Engine code:AEB Chassis no.10-3B-000 000, 000, 07102 000	Track Control Arm	S062332
	1996.10-2000.11	Front Axle Right Upper Outer	Saloon FWD AEB/ANB/APU		Track Control Arm	S060049
	1996.10-2000.11	Front Axle Right Upper Outer	Saloon FWD AEB/ANB/APU		Track Control Arm	S062531
	1996.10-2000.11	Front Axle Left & Right Lower Outer	Saloon FWD AEB/ANB/APU		Track Control Arm	S060054
	1996.10-2000.11	Front Axle Left & Right Upper	Saloon FWD AEB/ANB/APU		Control Arm Bushing	510136
	1996.10-2000.11	Front Axle Left & Right Lower Inner	Saloon FWD AEB/ANB/APU		Control Arm Bushing	510135
	1996.10-2000.11	Front Axle Left & Right Lower Inner	Saloon FWD AEB/ANB/APU		Control Arm Bushing	510287
	1996.10-2000.11	Front Axle Left & Right Lower Outer	Saloon FWD AEB/ANB/APU		Control Arm Bushing	510133
	1996.10-2000.11	Front Axle Left & Right Lower Outer	Saloon FWD AEB/ANB/APU		Control Arm Bushing	510134
	1996.10-2000.11	Front Axle	Saloon FWD AEB/ANB/APU		Suspension Repair Kit	S990001SK
	1996.10-2000.11	Front Axle Left & Right	Saloon FWD AEB/ANB/APU		Rod Assembly	S100014
	1996.10-2000.11	Front Axle Left & Right	Saloon FWD AEB/ANB/APU		Tie Rod End	S070038
	1996.10-2000.11	Front Axle Left & Right	Saloon FWD AEB/ANB/APU		Tie Rod End	S070866
	1996.10-2000.11	Front Axle Left	Saloon FWD AEB/ANB/APU		Rod/Strut, stabiliser	520008
	1996.10-2000.11	Front Axle Left	Saloon FWD AEB/ANB/APU		Rod/Strut, stabiliser	S050034
	1996.10-2000.11	Front Axle Right	Saloon FWD AEB/ANB/APU		Rod/Strut, stabiliser	520010
	1996.10-2000.11	Front Axle Right	Saloon FWD AEB/ANB/APU		Rod/Strut, stabiliser	S050033
	1996.10-2000.11	Front Axle	Saloon FWD AEB/ANB/APU	Stabiliser Ø:26,8 mm	Stabiliser Bushing	510138
	1996.10-2000.11	Front Axle	Saloon FWD AEB/ANB/APU	Stabiliser Ø:29 mm	Stabiliser Bushing	510139
	1996.10-2000.11	Front Axle Left	Saloon FWD AEB/ANB/APU		Steering Boot	540043
	1996.10-2000.11	Front Axle Left	Saloon FWD AEB/ANB/APU		Steering Rack Bellow Kit	540043S
2.0 (85 kw)	1990.03-1996.12	Front Axle Left & Right Lower	Saloon FWD 2E/ADY/AGG		Track Control Arm	S060758
	1990.03-1996.12	Front Axle Left & Right Lower	Saloon FWD 2E/ADY/AGG		Ball Joint	S080211
	1990.03-1996.12	Front Axle Left & Right Lower	Saloon FWD 2E/ADY/AGG		Control Arm Bushing	510024
	1990.03-1996.12	Front Axle Left & Right Lower	Saloon FWD 2E/ADY/AGG		Control Arm Bushing	510025
	1990.03-1996.12	Front Axle Left & Right Lower	Saloon FWD 2E/ADY/AGG		Control Arm Bushing	510084
	1990.03-1996.12	Front Axle Left & Right Lower	Saloon FWD 2E/ADY/AGG		Control Arm Bushing Kit	510312S
	1990.03-1996.12	Front Axle Left	Saloon FWD 2E/ADY/AGG	for vehicles without power steering	Rod Assembly	S100146
	1990.03-1996.12	Front Axle Left	Saloon FWD 2E/ADY/AGG	Engine code:2E,for vehicles with power steering	Rod Assembly	S100210
	1990.03-1996.12	Front Axle Right	Saloon FWD 2E/ADY/AGG	for vehicles without power steering	Rod Assembly	S100147
	1990.03-1996.12	Front Axle Right	Saloon FWD 2E/ADY/AGG		Rod Assembly	S100156
	1990.03-1996.12	Front Axle Left & Right	Saloon FWD 2E/ADY/AGG		Tie Rod Axle Joint	S030490
	1990.03-1996.12	Front Axle Left & Right	Saloon FWD 2E/ADY/AGG		Tie Rod Axle Joint	S030495
	1990.03-1996.12	Front Axle Left & Right	Saloon FWD 2E/ADY/AGG		Tie Rod Axle Joint	S030842
	1990.03-1996.12	Front Axle Left & Right	Saloon FWD 2E/ADY/AGG	for vehicles with power steering	Tie Rod Axle Joint	S030970
	1990.03-1996.12	Front Axle Left	Saloon FWD 2E/ADY/AGG		Tie Rod End	S070419
	1990.03-1996.12	Front Axle Right	Saloon FWD 2E/ADY/AGG		Tie Rod End	S070418
	1990.03-1996.12	Front Axle Left & Right	Saloon FWD 2E/ADY/AGG		Rod/Strut, stabiliser	510087
	1990.03-1996.12	Front Axle Left & Right	Saloon FWD 2E/ADY/AGG		Rod/Strut, stabiliser	510088
	1990.03-1996.12	Front Axle Left & Right	Saloon FWD 2E/ADY/AGG		Rod/Strut, stabiliser	510407
	1990.03-1996.12	Front Axle	Saloon FWD 2E/ADY/AGG		Stabiliser Bushing	510085
	1990.03-1996.12	Front Axle	Saloon FWD 2E/ADY/AGG		Stabiliser Bushing	510089
	1990.03-1996.12	Front Axle	Saloon FWD 2E/ADY/AGG		Stabiliser Bushing	510205
	1990.03-1996.12	Front Axle	Saloon FWD 2E/ADY/AGG		Steering Boot	540016
	1990.03-1996.12	Front Axle	Saloon FWD 2E/ADY/AGG		Steering Boot	540384



	 YEAR	FITTING POSITION	BODY STYLE & DRIVE TYPE & ENGINE	REMARKS	PRODUCT	GSP Ref.	
VW							
Passat							
2.0 (85 kw)	1990.03-1996.12	Front Axle	Saloon FWD 2E/ADY/AGG	for vehicles with power steering	Steering Rack Bellow Kit	541026S	
	1990.03-1996.12	Front Axle Left & Right	Saloon FWD 2E/ADY/AGG		Securing Plate,ball joint	510023S	
2.0 (110 kw)	2005.03-2010.11	Front Axle Left & Right Lower	Saloon FWD BLR/BLY/BVY/BVZ		Track Control Arm	S060762	
	2005.03-2010.11	Rear Axle Left Centre	Saloon FWD BLR/BLY/BVY/BVZ		Track Control Arm	S063095	
	2005.03-2010.11	Rear Axle Left Lower Inner	Saloon FWD BLR/BLY/BVY/BVZ		Track Control Arm	510349	
	2005.03-2010.11	Rear Axle Right Centre	Saloon FWD BLR/BLY/BVY/BVZ		Track Control Arm	S063094	
	2005.03-2010.11	Rear Axle Right Lower Inner	Saloon FWD BLR/BLY/BVY/BVZ		Track Control Arm	510350	
	2005.03-2010.11	Rear Axle Left & Right Lower Outer	Saloon FWD BLR/BLY/BVY/BVZ		Track Control Arm	S061468	
	2005.03-2010.11	Front Axle Left Lower	Saloon FWD BLR/BLY/BVY/BVZ		Ball Joint	S080258	
	2005.03-2010.11	Front Axle Right Lower	Saloon FWD BLR/BLY/BVY/BVZ		Ball Joint	S080259	
	2005.03-2010.11	Front Axle Left & Right Lower	Saloon FWD BLR/BLY/BVY/BVZ		Control Arm Bushing	510356	
	2005.03-2010.11	Front Axle Left & Right Lower	Saloon FWD BLR/BLY/BVY/BVZ		Control Arm Bushing	510361	
	2005.03-2010.11	Rear Axle Left & Right Centre	Saloon FWD BLR/BLY/BVY/BVZ		Control Arm Bushing	530530	
	2005.03-2010.11	Rear Axle Left & Right Upper	Saloon FWD BLR/BLY/BVY/BVZ		Control Arm Bushing	516372	
	2005.03-2010.11	Rear Axle Left & Right Upper	Saloon FWD BLR/BLY/BVY/BVZ		Control Arm Bushing	516408	
	2005.03-2010.11	Rear Axle Left & Right Lower Inner	Saloon FWD BLR/BLY/BVY/BVZ		Control Arm Bushing	510351	
	2005.03-2010.11	Rear Axle Left & Right Lower Inner	Saloon FWD BLR/BLY/BVY/BVZ		Control Arm Bushing	510352	
	2005.03-2010.11	Rear Axle Left & Right Lower Outer	Saloon FWD BLR/BLY/BVY/BVZ		Control Arm Bushing	516370	
	2005.03-2010.11	Front Axle	Saloon FWD BLR/BLY/BVY/BVZ		Suspension Repair Kit	S990017SK	
	2005.03-2010.11	Front Axle Left & Right	Saloon FWD BLR/BLY/BVY/BVZ		Tie Rod Axle Joint	S030009	
	2005.03-2010.11	Front Axle Left	Saloon FWD BLR/BLY/BVY/BVZ		Tie Rod End	S070032	
	2005.03-2010.11	Front Axle Right	Saloon FWD BLR/BLY/BVY/BVZ		Tie Rod End	S070033	
	2005.03-2010.11	Front Axle Left & Right	Saloon FWD BLR/BLY/BVY/BVZ		Rod/Strut,stabliser	S050040	
	2005.03-2010.11	Rear Axle Left & Right	Saloon FWD BLR/BLY/BVY/BVZ		Rod/Strut,stabliser	S050035	
	2005.03-2010.11	Front Axle	Saloon FWD BLR/BLY/BVY/BVZ		Stabiliser Bushing	535187K	
	2005.03-2010.11	Rear Axle	Saloon FWD BLR/BLY/BVY/BVZ	Stabiliser Ø:20,7 mm	Stabiliser Bushing	516447	
	2005.03-2010.11	Rear Axle	Saloon FWD BLR/BLY/BVY/BVZ		Stabiliser Bushing	530183	
	2.0 (155 kw)	2010.11-2014.12	Front Axle Left Lower	Saloon FWD CCZB		Track Control Arm	S061577
2010.11-2014.12		Front Axle Right Lower	Saloon FWD CCZB		Track Control Arm	S061578	
2010.11-2014.12		Front Axle Left & Right Lower	Saloon FWD CCZB		Track Control Arm	S060762	
2010.11-2014.12		Rear Axle Left Centre	Saloon FWD CCZB		Track Control Arm	S063095	
2010.11-2014.12		Rear Axle Left Lower Inner	Saloon FWD CCZB		Track Control Arm	510349	
2010.11-2014.12		Rear Axle Right Centre	Saloon FWD CCZB		Track Control Arm	S063094	
2010.11-2014.12		Rear Axle Right Lower Inner	Saloon FWD CCZB		Track Control Arm	510350	
2010.11-2014.12		Rear Axle Left & Right Lower Outer	Saloon FWD CCZB		Track Control Arm	S061468	
2010.11-2014.12		Front Axle Left Lower	Saloon FWD CCZB		Ball Joint	S080258	
2010.11-2014.12		Front Axle Right Lower	Saloon FWD CCZB		Ball Joint	S080259	
2010.11-2014.12		Front Axle Left & Right Lower	Saloon FWD CCZB	for driving school cars,for ambulances,for taxis,for PE no. F4E4K0FF75C	Control Arm Bushing	510353	
2010.11-2014.12		Front Axle Left & Right Lower	Saloon FWD CCZB		Control Arm Bushing	510356	
2010.11-2014.12		Front Axle Left & Right Lower	Saloon FWD CCZB		Control Arm Bushing	510361	
2010.11-2014.12		Front Axle Left & Right Lower	Saloon FWD CCZB		Control Arm Bushing	531423	
2010.11-2014.12		Rear Axle Left & Right Centre	Saloon FWD CCZB		Control Arm Bushing	530530	
2010.11-2014.12		Rear Axle Left & Right Upper	Saloon FWD CCZB		Control Arm Bushing	516372	
2010.11-2014.12		Rear Axle Left & Right Upper	Saloon FWD CCZB		Control Arm Bushing	516408	
2010.11-2014.12		Rear Axle Left & Right Lower Inner	Saloon FWD CCZB		Control Arm Bushing	510351	
2010.11-2014.12		Rear Axle Left & Right Lower Inner	Saloon FWD CCZB		Control Arm Bushing	510352	
2010.11-2014.12		Rear Axle Left & Right Lower Outer	Saloon FWD CCZB		Control Arm Bushing	516370	
2010.11-2014.12		Front Axle	Saloon FWD CCZB		Suspension Repair Kit	S990017SK	
2010.11-2014.12		Front Axle Left & Right	Saloon FWD CCZB		Tie Rod Axle Joint	S030009	
2010.11-2014.12		Front Axle Left	Saloon FWD CCZB		Tie Rod End	S070032	
2010.11-2014.12		Front Axle Right	Saloon FWD CCZB		Tie Rod End	S070033	
2010.11-2014.12		Front Axle Left & Right	Saloon FWD CCZB		Tie Rod End	S070824	
2010.11-2014.12		Front Axle Left & Right	Saloon FWD CCZB		Tie Rod End	S070840	
2010.11-2014.12		Rear Axle Left & Right	Saloon FWD CCZB		Rod/Strut,stabliser	S050040	
2010.11-2014.12		Rear Axle Left & Right	Saloon FWD CCZB		Rod/Strut,stabliser	S050035	
2010.11-2014.12		Front Axle	Saloon FWD CCZB		Stabiliser Bushing	535187K	
2010.11-2014.12		Rear Axle	Saloon FWD CCZB		Stabiliser Bushing	516447	
2.0 (162 kw)		2015.05-	Front Axle Left Lower	Saloon FWD CHHB/CXDA		Track Control Arm	S062790
		2015.05-	Front Axle Right Lower	Saloon FWD CHHB/CXDA		Track Control Arm	S062789
		2015.05-	Rear Axle Left & Right Lower Inner	Saloon FWD CHHB/CXDA		Track Control Arm	S062791
		2015.05-	Rear Axle Left & Right Lower Outer	Saloon FWD CHHB/CXDA		Track Control Arm	S062900
	2015.05-	Front Axle Left Lower	Saloon FWD CHHB/CXDA		Ball Joint	S080258	
	2015.05-	Front Axle Right Lower	Saloon FWD CHHB/CXDA		Ball Joint	S080259	
	2015.05-	Front Axle Left & Right Lower	Saloon FWD CHHB/CXDA		Control Arm Bushing	510361	



	 YEAR	FITTING POSITION	BODY STYLE & DRIVE TYPE & ENGINE	REMARKS	PRODUCT	GSP Ref.
VW						
Passat						
2.0 (162 kw)	2015.05-	Front Axle Left & Right Lower	Saloon FWD CHHB/CXDA		Control Arm Bushing	531431
	2015.05-	Rear Axle Left & Right Centre	Saloon FWD CHHB/CXDA		Control Arm Bushing	512203
	2015.05-	Rear Axle Left & Right Upper	Saloon FWD CHHB/CXDA		Control Arm Bushing	516372
	2015.05-	Rear Axle Left & Right Upper	Saloon FWD CHHB/CXDA		Control Arm Bushing	516408
	2015.05-	Rear Axle Left & Right Lower Inner	Saloon FWD CHHB/CXDA		Control Arm Bushing	535309
	2015.05-	Front Axle Left & Right	Saloon FWD CHHB/CXDA		Tie Rod Axle Joint	S030928
	2015.05-	Front Axle Left	Saloon FWD CHHB/CXDA		Tie Rod End	S070032
	2015.05-	Front Axle Right	Saloon FWD CHHB/CXDA		Tie Rod End	S070033
	2015.05-	Front Axle Left & Right	Saloon FWD CHHB/CXDA		Rod/Strut, stabiliser	S050040
	2015.05-	Rear Axle Left & Right	Saloon FWD CHHB/CXDA		Rod/Strut, stabiliser	S051234
2.8 (128 kw)	1991.06-1996.12	Front Axle Left & Right Lower	Saloon FWD AAA		Track Control Arm	S060758
	1991.06-1996.12	Front Axle Left & Right Lower	Saloon FWD AAA	Engine Code:AAA,Chassis no.31-N-205 989,Engine Code:AAA	Ball Joint	S080211
	1991.06-1996.12	Front Axle Left & Right Lower	Saloon FWD AAA	Date from:1991.01,Chassis no.from:31-N-205 990-31-N-205 990,Engine code:AAA	Ball Joint	S080212
	1991.06-1996.12	Front Axle Left & Right Lower	Saloon FWD AAA		Control Arm Bushing	510024
	1991.06-1996.12	Front Axle Left & Right Lower	Saloon FWD AAA		Control Arm Bushing	510025
	1991.06-1996.12	Front Axle Left & Right Lower	Saloon FWD AAA		Control Arm Bushing	510084
	1991.06-1996.12	Front Axle Left & Right Lower	Saloon FWD AAA		Control Arm Bushing Kit	510312S
	1991.06-1996.12	Front Axle Left	Saloon FWD AAA		Rod Assembly	S100146
	1991.06-1996.12	Front Axle Right	Saloon FWD AAA	for vehicles without power steering	Rod Assembly	S100147
	1991.06-1996.12	Front Axle Right	Saloon FWD AAA	for vehicles with power steering	Rod Assembly	S100156
	1991.06-1996.12	Front Axle Left & Right	Saloon FWD AAA		Tie Rod Axle Joint	S030490
	1991.06-1996.12	Front Axle Left & Right	Saloon FWD AAA		Tie Rod Axle Joint	S030495
	1991.06-1996.12	Front Axle Left	Saloon FWD AAA		Tie Rod End	S070419
	1991.06-1996.12	Front Axle Right	Saloon FWD AAA		Tie Rod End	S070418
	1991.06-1996.12	Front Axle Left & Right	Saloon FWD AAA		Tie Rod End	S071200
	1991.06-1996.12	Front Axle Left & Right	Saloon FWD AAA		Rod/Strut, stabiliser	510087
	1991.06-1996.12	Front Axle Left & Right	Saloon FWD AAA		Rod/Strut, stabiliser	510088
	1991.06-1996.12	Front Axle Left & Right	Saloon FWD AAA		Rod/Strut, stabiliser	510407
	1991.06-1996.12	Front Axle	Saloon FWD AAA		Stabiliser Bushing	510085
	1991.06-1996.12	Front Axle	Saloon FWD AAA		Stabiliser Bushing	510089
	1991.06-1996.12	Front Axle	Saloon FWD AAA		Stabiliser Bushing	510205
	1991.06-1996.12	Front Axle	Saloon FWD AAA		Steering Boot	540016
	1991.06-1996.12	Front Axle	Saloon FWD AAA		Steering Boot	540384
	1991.06-1996.12	Front Axle	Saloon FWD AAA	for vehicles with power steering	Steering Rack Bellow Kit	541026S
	1991.06-1996.12	Front Axle Left & Right	Saloon FWD AAA		Securing Plate, ball joint	510023S
2.8 (142 kw)	1997.06-2000.08	Front Axle Left Lower Inner	Saloon FWD APR/AQD		Track Control Arm	S060055
	1997.06-2000.08	Front Axle Left Upper Inner	Saloon FWD APR/AQD		Track Control Arm	S062331
	1997.06-2000.08	Front Axle Left Upper Outer	Saloon FWD APR/AQD		Track Control Arm	S060048
	1997.06-2000.08	Front Axle Left Upper Outer	Saloon FWD APR/AQD		Track Control Arm	S060798
	1997.06-2000.08	Front Axle Left Upper Outer	Saloon FWD APR/AQD		Track Control Arm	S062530
	1997.06-2000.08	Front Axle Right Lower Inner	Saloon FWD APR/AQD		Track Control Arm	S060056
	1997.06-2000.08	Front Axle Right Upper Inner	Saloon FWD APR/AQD		Track Control Arm	S062332
	1997.06-2000.08	Front Axle Right Upper Outer	Saloon FWD APR/AQD		Track Control Arm	S060049
	1997.06-2000.08	Front Axle Right Upper Outer	Saloon FWD APR/AQD		Track Control Arm	S062531
	1997.06-2000.08	Front Axle Left & Right Lower Outer	Saloon FWD APR/AQD		Track Control Arm	S060054
	1997.06-2000.08	Front Axle Left & Right Upper	Saloon FWD APR/AQD		Control Arm Bushing	510136
	1997.06-2000.08	Front Axle Left & Right Lower Inner	Saloon FWD APR/AQD		Control Arm Bushing	510135
	1997.06-2000.08	Front Axle Left & Right Lower Inner	Saloon FWD APR/AQD		Control Arm Bushing	510287
	1997.06-2000.08	Front Axle Left & Right Lower Outer	Saloon FWD APR/AQD		Control Arm Bushing	510133
	1997.06-2000.08	Front Axle Left & Right Lower Outer	Saloon FWD APR/AQD		Control Arm Bushing	510134
	1997.06-2000.08	Front Axle	Saloon FWD APR/AQD		Suspension Repair Kit	S990001SK
	1997.06-2000.08	Front Axle Left & Right	Saloon FWD APR/AQD		Rod Assembly	S100014
	1997.06-2000.08	Front Axle Left & Right	Saloon FWD APR/AQD		Tie Rod End	S070038
	1997.06-2000.08	Front Axle Left	Saloon FWD APR/AQD		Rod/Strut, stabiliser	520008
	1997.06-2000.08	Front Axle Left	Saloon FWD APR/AQD		Rod/Strut, stabiliser	S050034
	1997.06-2000.08	Front Axle Right	Saloon FWD APR/AQD		Rod/Strut, stabiliser	520010
	1997.06-2000.08	Front Axle Right	Saloon FWD APR/AQD		Rod/Strut, stabiliser	S050033
	1997.06-2000.08	Front Axle	Saloon FWD APR/AQD	Stabiliser Ø:26,8 mm	Stabiliser Bushing	510138
	1997.06-2000.08	Front Axle	Saloon FWD APR/AQD	Stabiliser Ø:29 mm	Stabiliser Bushing	510139
	1997.06-2000.08	Front Axle Left	Saloon FWD APR/AQD		Steering Boot	540043
	1997.06-2000.08	Front Axle Left	Saloon FWD APR/AQD		Steering Rack Bellow Kit	540043S
3.2 (184 kw)	2005.09-2010.11	Front Axle Left & Right Lower	Saloon 4WD AXZ		Track Control Arm	S060762
	2005.09-2010.11	Rear Axle Left Centre	Saloon 4WD AXZ		Track Control Arm	S063095
	2005.09-2010.11	Rear Axle Left Lower Inner	Saloon 4WD AXZ		Track Control Arm	510349

	 YEAR	FITTING POSITION	BODY STYLE & DRIVE TYPE & ENGINE	REMARKS	PRODUCT	GSP Ref.
VW						
Passat						
3.2 (184 kw)	2005.09-2010.11	Rear Axle Right Centre	Saloon 4WD AXZ		Track Control Arm	S063094
	2005.09-2010.11	Rear Axle Right Lower Inner	Saloon 4WD AXZ		Track Control Arm	510350
	2005.09-2010.11	Rear Axle Left & Right Lower Outer	Saloon 4WD AXZ		Track Control Arm	S061468
	2005.09-2010.11	Front Axle Left Lower	Saloon 4WD AXZ		Ball Joint	S080258
	2005.09-2010.11	Front Axle Right Lower	Saloon 4WD AXZ		Ball Joint	S080259
	2005.09-2010.11	Front Axle Left & Right Lower	Saloon 4WD AXZ		Control Arm Bushing	510356
	2005.09-2010.11	Front Axle Left & Right Lower	Saloon 4WD AXZ		Control Arm Bushing	510361
	2005.09-2010.11	Rear Axle Left & Right Centre	Saloon 4WD AXZ		Control Arm Bushing	530530
	2005.09-2010.11	Rear Axle Left & Right Upper	Saloon 4WD AXZ		Control Arm Bushing	516372
	2005.09-2010.11	Rear Axle Left & Right Upper	Saloon 4WD AXZ		Control Arm Bushing	516408
	2005.09-2010.11	Rear Axle Left & Right Lower Inner	Saloon 4WD AXZ		Control Arm Bushing	510351
	2005.09-2010.11	Rear Axle Left & Right Lower Inner	Saloon 4WD AXZ		Control Arm Bushing	510352
	2005.09-2010.11	Rear Axle Left & Right Lower Outer	Saloon 4WD AXZ		Control Arm Bushing	516370
	2005.09-2010.11	Front Axle	Saloon 4WD AXZ		Suspension Repair Kit	S990017SK
	2005.09-2010.11	Front Axle Left & Right	Saloon 4WD AXZ		Tie Rod Axle Joint	S030009
	2005.09-2010.11	Front Axle Left	Saloon 4WD AXZ		Tie Rod End	S070032
	2005.09-2010.11	Front Axle Right	Saloon 4WD AXZ		Tie Rod End	S070033
	2005.09-2010.11	Front Axle Left & Right	Saloon 4WD AXZ		Rod/Strut, stabiliser	S050040
	2005.09-2010.11	Rear Axle Left & Right	Saloon 4WD AXZ		Rod/Strut, stabiliser	S050035
	2005.09-2010.11	Front Axle	Saloon 4WD AXZ		Stabiliser Bushing	535187K
	2005.09-2010.11	Rear Axle	Saloon 4WD AXZ		Stabiliser Bushing	516447
	2005.09-2010.11	Rear Axle	Saloon 4WD AXZ		Stabiliser Bushing	530183
Passat CC						
3.6 (220 kw)	2008.02-2011.12	Front Axle Left Lower	Coupe 4WD BWS		Track Control Arm	S061577
	2008.02-2011.12	Front Axle Right Lower	Coupe 4WD BWS		Track Control Arm	S061578
	2008.02-2011.12	Front Axle Left & Right Lower	Coupe 4WD BWS		Track Control Arm	S060762
	2008.02-2011.12	Rear Axle Left Centre	Coupe 4WD BWS		Track Control Arm	S063095
	2008.02-2011.12	Rear Axle Left Lower Inner	Coupe 4WD BWS		Track Control Arm	510349
	2008.02-2011.12	Rear Axle Right Centre	Coupe 4WD BWS		Track Control Arm	S063094
	2008.02-2011.12	Rear Axle Right Lower Inner	Coupe 4WD BWS		Track Control Arm	510350
	2008.02-2011.12	Rear Axle Left & Right Lower Outer	Coupe 4WD BWS		Track Control Arm	S061468
	2008.02-2011.12	Front Axle Left Lower	Coupe 4WD BWS		Ball Joint	S080258
	2008.02-2011.12	Front Axle Right Lower	Coupe 4WD BWS		Ball Joint	S080259
	2008.02-2011.12	Front Axle Left & Right Lower	Coupe 4WD BWS		Control Arm Bushing	510356
	2008.02-2011.12	Front Axle Left & Right Lower	Coupe 4WD BWS		Control Arm Bushing	510361
	2008.02-2011.12	Rear Axle Left & Right Centre	Coupe 4WD BWS		Control Arm Bushing	530530
	2008.02-2011.12	Rear Axle Left & Right Upper	Coupe 4WD BWS		Control Arm Bushing	516372
	2008.02-2011.12	Rear Axle Left & Right Upper	Coupe 4WD BWS		Control Arm Bushing	516408
	2008.02-2011.12	Rear Axle Left & Right Lower Inner	Coupe 4WD BWS		Control Arm Bushing	510351
	2008.02-2011.12	Rear Axle Left & Right Lower Inner	Coupe 4WD BWS		Control Arm Bushing	510352
	2008.02-2011.12	Rear Axle Left & Right Lower Outer	Coupe 4WD BWS		Control Arm Bushing	516370
	2008.02-2011.12	Front Axle	Coupe 4WD BWS		Suspension Repair Kit	S990017SK
	2008.02-2011.12	Front Axle Left & Right	Coupe 4WD BWS		Tie Rod Axle Joint	S030009
	2008.02-2011.12	Front Axle Left	Coupe 4WD BWS		Tie Rod End	S070032
	2008.02-2011.12	Front Axle Right	Coupe 4WD BWS		Tie Rod End	S070033
	2008.02-2011.12	Front Axle Left & Right	Coupe 4WD BWS		Rod/Strut, stabiliser	S050040
	2008.02-2011.12	Rear Axle Left & Right	Coupe 4WD BWS		Rod/Strut, stabiliser	S050035
	2008.02-2011.12	Front Axle	Coupe 4WD BWS		Stabiliser Bushing	535187K
	2008.02-2011.12	Rear Axle	Coupe 4WD BWS		Stabiliser Bushing	516447
Passat Estate/Variant						
1.8 (92 kw)	1996.12-2000.08	Front Axle Left Lower Inner	Estate FWD ADR/APT/ARG		Track Control Arm	S060055
	1996.12-2000.08	Front Axle Left Upper Inner	Estate FWD ADR/APT/ARG	Engine code ADR, Chassis no. 1J3B-H5383 008.35-VP102 593	Track Control Arm	S060021
	1996.12-2000.08	Front Axle Left Upper Inner	Estate FWD ADR/APT/ARG		Track Control Arm	S062331
	1996.12-2000.08	Front Axle Left Upper Outer	Estate FWD ADR/APT/ARG		Track Control Arm	S060048
	1996.12-2000.08	Front Axle Left Upper Outer	Estate FWD ADR/APT/ARG		Track Control Arm	S060798
	1996.12-2000.08	Front Axle Left Upper Outer	Estate FWD ADR/APT/ARG		Track Control Arm	S062530
	1996.12-2000.08	Front Axle Right Lower Inner	Estate FWD ADR/APT/ARG		Track Control Arm	S060056
	1996.12-2000.08	Front Axle Right Upper Inner	Estate FWD ADR/APT/ARG	Engine code ADR, Chassis no. 1J3B-H5383 008.35-VP102 593	Track Control Arm	S060022
	1996.12-2000.08	Front Axle Right Upper Inner	Estate FWD ADR/APT/ARG		Track Control Arm	S062332
	1996.12-2000.08	Front Axle Right Upper Outer	Estate FWD ADR/APT/ARG		Track Control Arm	S060049
	1996.12-2000.08	Front Axle Right Upper Outer	Estate FWD ADR/APT/ARG		Track Control Arm	S062531
	1996.12-2000.08	Front Axle Left & Right Lower Outer	Estate FWD ADR/APT/ARG		Track Control Arm	S060054
	1996.12-2000.08	Front Axle Left & Right Upper	Estate FWD ADR/APT/ARG		Control Arm Bushing	510136
	1996.12-2000.08	Front Axle Left & Right Lower Inner	Estate FWD ADR/APT/ARG		Control Arm Bushing	510135



	 YEAR	FITTING POSITION	BODY STYLE & DRIVE TYPE & ENGINE	REMARKS	PRODUCT	GSP Ref.
VW						
Passat Estate/Variant						
1.8 (92 kw)	1996.12-2000.08	Front Axle Left & Right Lower Inner	Estate FWD ADR/APT/ARG		Control Arm Bushing	510287
	1996.12-2000.08	Front Axle Left & Right Lower Outer	Estate FWD ADR/APT/ARG		Control Arm Bushing	510133
	1996.12-2000.08	Front Axle Left & Right Lower Outer	Estate FWD ADR/APT/ARG		Control Arm Bushing	510134
	1996.12-2000.08	Front Axle	Estate FWD ADR/APT/ARG		Suspension Repair Kit	S990001SK
	1996.12-2000.08	Front Axle Left & Right	Estate FWD ADR/APT/ARG		Rod Assembly	S100014
	1996.12-2000.08	Front Axle Left & Right	Estate FWD ADR/APT/ARG		Tie Rod End	S070038
	1996.12-2000.08	Front Axle Left	Estate FWD ADR/APT/ARG		Rod/Strut,stabiliser	520008
	1996.12-2000.08	Front Axle Left	Estate FWD ADR/APT/ARG		Rod/Strut,stabiliser	S050034
	1996.12-2000.08	Front Axle Right	Estate FWD ADR/APT/ARG		Rod/Strut,stabiliser	520010
	1996.12-2000.08	Front Axle Right	Estate FWD ADR/APT/ARG		Rod/Strut,stabiliser	S050033
	1996.12-2000.08	Front Axle	Estate FWD ADR/APT/ARG	Stabiliser Ø:25 mm	Stabiliser Bushing	510138
	1996.12-2000.08	Front Axle	Estate FWD ADR/APT/ARG	Stabiliser Ø:29 mm	Stabiliser Bushing	510139
	1996.12-2000.08	Front Axle Left	Estate FWD ADR/APT/ARG		Steering Boot	540043
	1996.12-2000.08	Front Axle Left	Estate FWD ADR/APT/ARG		Steering Rack Bellow Kit	540043S
1.8 (110 kw)	1997.05-2000.11	Front Axle Left Lower Inner	Estate FWD AEB/ANB/APU		Track Control Arm	S060055
	1997.05-2000.11	Front Axle Left Upper Inner	Estate FWD AEB/ANB/APU		Track Control Arm	S062331
	1997.05-2000.11	Front Axle Left Upper Outer	Estate FWD AEB/ANB/APU		Track Control Arm	S060048
	1997.05-2000.11	Front Axle Left Upper Outer	Estate FWD AEB/ANB/APU		Track Control Arm	S060798
	1997.05-2000.11	Front Axle Left Upper Outer	Estate FWD AEB/ANB/APU		Track Control Arm	S062530
	1997.05-2000.11	Front Axle Right Lower Inner	Estate FWD AEB/ANB/APU		Track Control Arm	S060056
	1997.05-2000.11	Front Axle Right Upper Inner	Estate FWD AEB/ANB/APU		Track Control Arm	S062332
	1997.05-2000.11	Front Axle Right Upper Outer	Estate FWD AEB/ANB/APU		Track Control Arm	S060049
	1997.05-2000.11	Front Axle Right Upper Outer	Estate FWD AEB/ANB/APU		Track Control Arm	S062531
	1997.05-2000.11	Front Axle Left & Right Lower Outer	Estate FWD AEB/ANB/APU		Track Control Arm	S060054
	1997.05-2000.11	Front Axle Left & Right Upper	Estate FWD AEB/ANB/APU		Control Arm Bushing	510136
	1997.05-2000.11	Front Axle Left & Right Lower Inner	Estate FWD AEB/ANB/APU		Control Arm Bushing	510135
	1997.05-2000.11	Front Axle Left & Right Lower Inner	Estate FWD AEB/ANB/APU		Control Arm Bushing	510287
	1997.05-2000.11	Front Axle Left & Right Lower Outer	Estate FWD AEB/ANB/APU		Control Arm Bushing	510133
	1997.05-2000.11	Front Axle Left & Right Lower Outer	Estate FWD AEB/ANB/APU		Control Arm Bushing	510134
	1997.05-2000.11	Front Axle	Estate FWD AEB/ANB/APU		Suspension Repair Kit	S990001SK
	1997.05-2000.11	Front Axle Left & Right	Estate FWD AEB/ANB/APU		Rod Assembly	S100014
	1997.05-2000.11	Front Axle Left & Right	Estate FWD AEB/ANB/APU		Tie Rod Axle Joint	S030013
	1997.05-2000.11	Front Axle Left & Right	Estate FWD AEB/ANB/APU		Tie Rod End	S070038
	1997.05-2000.11	Front Axle Left	Estate FWD AEB/ANB/APU		Rod/Strut,stabiliser	520008
	1997.05-2000.11	Front Axle Left	Estate FWD AEB/ANB/APU		Rod/Strut,stabiliser	S050034
	1997.05-2000.11	Front Axle Right	Estate FWD AEB/ANB/APU		Rod/Strut,stabiliser	520010
	1997.05-2000.11	Front Axle Right	Estate FWD AEB/ANB/APU		Rod/Strut,stabiliser	S050033
	1997.05-2000.11	Front Axle	Estate FWD AEB/ANB/APU	Stabiliser Ø:25 mm	Stabiliser Bushing	510138
	1997.05-2000.11	Front Axle	Estate FWD AEB/ANB/APU	Stabiliser Ø:29 mm	Stabiliser Bushing	510139
	1997.05-2000.11	Front Axle Left	Estate FWD AEB/ANB/APU		Steering Boot	540043
	1997.05-2000.11	Front Axle Left	Estate FWD AEB/ANB/APU		Steering Rack Bellow Kit	540043S
	2000.09-2005.05	Front Axle Left Lower Inner	Estate FWD AWT		Track Control Arm	S060055
	2000.09-2005.05	Front Axle Left Upper Inner	Estate FWD AWT		Track Control Arm	S062331
	2000.09-2005.05	Front Axle Left Upper Outer	Estate FWD AWT		Track Control Arm	S060048
	2000.09-2005.05	Front Axle Left Upper Outer	Estate FWD AWT		Track Control Arm	S060798
	2000.09-2005.05	Front Axle Left Upper Outer	Estate FWD AWT		Track Control Arm	S062530
	2000.09-2005.05	Front Axle Right Lower Inner	Estate FWD AWT		Track Control Arm	S060056
	2000.09-2005.05	Front Axle Right Upper Inner	Estate FWD AWT		Track Control Arm	S062332
	2000.09-2005.05	Front Axle Right Upper Outer	Estate FWD AWT		Track Control Arm	S060049
	2000.09-2005.05	Front Axle Right Upper Outer	Estate FWD AWT		Track Control Arm	S062531
	2000.09-2005.05	Front Axle Left & Right Lower Outer	Estate FWD AWT	Chassis no. from:3B-3E072 001,3B-3P102 578	Track Control Arm	S060023
	2000.09-2005.05	Front Axle Left & Right Lower Outer	Estate FWD AWT	Chassis no. to:3B-3E072 000,3B-3P102 577	Track Control Arm	S060054
	2000.09-2005.05	Front Axle Left & Right Lower Inner	Estate FWD AWT		Control Arm Bushing	510287
	2000.09-2005.05	Front Axle Left & Right Lower Outer	Estate FWD AWT		Control Arm Bushing	510133
	2000.09-2005.05	Front Axle Left & Right Lower Outer	Estate FWD AWT		Control Arm Bushing	510134
	2000.09-2005.05	Front Axle	Estate FWD AWT	Chassis no.to:3B-3-072 000	Suspension Repair Kit	S990001SK
	2000.09-2005.05	Front Axle	Estate FWD AWT	Chassis no.from:3B-3-072-001	Suspension Repair Kit	S990067SK
	2000.09-2005.05	Front Axle Left & Right	Estate FWD AWT		Tie Rod Axle Joint	S030013
	2000.09-2005.05	Front Axle Left & Right	Estate FWD AWT		Tie Rod End	S070038
	2000.09-2005.05	Front Axle Left	Estate FWD AWT		Rod/Strut,stabiliser	520008
2000.09-2005.05	Front Axle Left	Estate FWD AWT		Rod/Strut,stabiliser	S050034	
2000.09-2005.05	Front Axle Right	Estate FWD AWT		Rod/Strut,stabiliser	520010	
2000.09-2005.05	Front Axle Right	Estate FWD AWT		Rod/Strut,stabiliser	S050033	
2000.09-2005.05	Rear Axle Left & Right	Estate FWD AWT		Rod/Strut,stabiliser	S050035	



	 YEAR	FITTING POSITION	BODY STYLE & DRIVE TYPE & ENGINE	REMARKS	PRODUCT	GSP Ref.	
VW							
Passat Estate/Variant							
1.8 (110 kw)	2000.09-2005.05	Front Axle	Estate FWD AWT	Stabiliser Ø:25 mm	Stabiliser Bushing	510138	
	2000.09-2005.05	Front Axle	Estate FWD AWT		Stabiliser Bushing	510139	
	2000.09-2005.05	Front Axle Left	Estate FWD AWT		Steering Boot	540043	
2.0 (85 kw)	1990.02-1996.12	Front Axle Left & Right	Estate FWD 2E/ADY/AGG	for vehicles with power steering	Tie Rod Axle Joint	S030970	
	1990.02-1996.12	Front Axle Left	Estate FWD 2E/ADY/AGG	Date to: 1993.12; Chassis no. to: 3AR099264	Tie Rod End	S070419	
	1990.02-1996.12	Front Axle Left	Estate FWD 2E/ADY/AGG	Engine code: JE; Date to: 12.1994; Chassis no. to: 3A-F-999-264; Engine code: JE	Tie Rod End	S070419	
	1990.02-1996.12	Front Axle Left & Right	Estate FWD 2E/ADY/AGG		Securing Plate, ball joint	510023S	
2.0 (110 kw)	2005.03-2010.11	Front Axle Left & Right Lower	Estate FWD BLR/BLY/BVY/BVZ		Track Control Arm	S060762	
	2005.03-2010.11	Rear Axle Left Centre	Estate FWD BLR/BLY/BVY/BVZ		Track Control Arm	S063095	
	2005.03-2010.11	Rear Axle Left Lower Inner	Estate FWD BLR/BLY/BVY/BVZ		Track Control Arm	510349	
	2005.03-2010.11	Rear Axle Right Centre	Estate FWD BLR/BLY/BVY/BVZ		Track Control Arm	S063094	
	2005.03-2010.11	Rear Axle Right Lower Inner	Estate FWD BLR/BLY/BVY/BVZ		Track Control Arm	510350	
	2005.03-2010.11	Rear Axle Left & Right Upper	Estate FWD BLR/BLY/BVY/BVZ		Track Control Arm	510346	
	2005.03-2010.11	Rear Axle Left & Right Lower Outer	Estate FWD BLR/BLY/BVY/BVZ		Track Control Arm	S061468	
	2005.03-2010.11	Front Axle Left Lower	Estate FWD BLR/BLY/BVY/BVZ		Ball Joint	S080258	
	2005.03-2010.11	Front Axle Right Lower	Estate FWD BLR/BLY/BVY/BVZ		Ball Joint	S080259	
	2005.03-2010.11	Front Axle Left & Right Lower	Estate FWD BLR/BLY/BVY/BVZ		Control Arm Bushing	510356	
	2005.03-2010.11	Front Axle Left & Right Lower	Estate FWD BLR/BLY/BVY/BVZ		Control Arm Bushing	510361	
	2005.03-2010.11	Rear Axle Left & Right Centre	Estate FWD BLR/BLY/BVY/BVZ		Control Arm Bushing	530530	
	2005.03-2010.11	Rear Axle Left & Right Upper	Estate FWD BLR/BLY/BVY/BVZ		Control Arm Bushing	516372	
	2005.03-2010.11	Rear Axle Left & Right Upper	Estate FWD BLR/BLY/BVY/BVZ		Control Arm Bushing	516408	
	2005.03-2010.11	Rear Axle Left & Right Lower Inner	Estate FWD BLR/BLY/BVY/BVZ		Control Arm Bushing	510351	
	2005.03-2010.11	Rear Axle Left & Right Lower Inner	Estate FWD BLR/BLY/BVY/BVZ		Control Arm Bushing	510352	
	2005.03-2010.11	Rear Axle Left & Right Lower Outer	Estate FWD BLR/BLY/BVY/BVZ		Control Arm Bushing	516370	
	2005.03-2010.11	Front Axle	Estate FWD BLR/BLY/BVY/BVZ		Suspension Repair Kit	S990017SK	
	2005.03-2010.11	Front Axle Left & Right	Estate FWD BLR/BLY/BVY/BVZ		Tie Rod Axle Joint	S030009	
	2005.03-2010.11	Front Axle Left	Estate FWD BLR/BLY/BVY/BVZ		Tie Rod End	S070032	
	2005.03-2010.11	Front Axle Right	Estate FWD BLR/BLY/BVY/BVZ		Tie Rod End	S070033	
	2005.03-2010.11	Front Axle Left & Right	Estate FWD BLR/BLY/BVY/BVZ		Rod/Strut, stabiliser	S050040	
	2005.03-2010.11	Rear Axle Left & Right	Estate FWD BLR/BLY/BVY/BVZ		Rod/Strut, stabiliser	S050035	
	2005.03-2010.11	Front Axle	Estate FWD BLR/BLY/BVY/BVZ		Stabiliser Bushing	535187K	
	2005.03-2010.11	Rear Axle	Estate FWD BLR/BLY/BVY/BVZ		Stabiliser Bushing	516447	
	2.0 (147 kw)	2005.07-2010.12	Front Axle Left & Right Lower	Estate FWD AXX/BPY/BWA/CAWB/CBFA/CCTA/CCZA		Track Control Arm	S060762
		2005.07-2010.12	Rear Axle Left Centre	Estate FWD AXX/BPY/BWA/CAWB/CBFA/CCTA/CCZA		Track Control Arm	S063095
		2005.07-2010.12	Rear Axle Left Lower Inner	Estate FWD AXX/BPY/BWA/CAWB/CBFA/CCTA/CCZA		Track Control Arm	510349
2005.07-2010.12		Rear Axle Right Centre	Estate FWD AXX/BPY/BWA/CAWB/CBFA/CCTA/CCZA		Track Control Arm	S063094	
2005.07-2010.12		Rear Axle Right Lower Inner	Estate FWD AXX/BPY/BWA/CAWB/CBFA/CCTA/CCZA		Track Control Arm	510350	
2005.07-2010.12		Rear Axle Left & Right Upper	Estate FWD AXX/BPY/BWA/CAWB/CBFA/CCTA/CCZA		Track Control Arm	510346	
2005.07-2010.12		Rear Axle Left & Right Lower Outer	Estate FWD AXX/BPY/BWA/CAWB/CBFA/CCTA/CCZA		Track Control Arm	S061468	
2005.07-2010.12		Front Axle Left Lower	Estate FWD AXX/BPY/BWA/CAWB/CBFA/CCTA/CCZA		Ball Joint	S080258	
2005.07-2010.12		Front Axle Right Lower	Estate FWD AXX/BPY/BWA/CAWB/CBFA/CCTA/CCZA		Ball Joint	S080259	
2005.07-2010.12		Front Axle Left & Right Lower	Estate FWD AXX/BPY/BWA/CAWB/CBFA/CCTA/CCZA		Control Arm Bushing	510356	
2005.07-2010.12		Front Axle Left & Right Lower	Estate FWD AXX/BPY/BWA/CAWB/CBFA/CCTA/CCZA		Control Arm Bushing	510361	
2005.07-2010.12		Rear Axle Left & Right Centre	Estate FWD AXX/BPY/BWA/CAWB/CBFA/CCTA/CCZA		Control Arm Bushing	530530	
2005.07-2010.12		Rear Axle Left & Right Upper	Estate FWD AXX/BPY/BWA/CAWB/CBFA/CCTA/CCZA		Control Arm Bushing	516372	
2005.07-2010.12		Rear Axle Left & Right Upper	Estate FWD AXX/BPY/BWA/CAWB/CBFA/CCTA/CCZA		Control Arm Bushing	516408	
2005.07-2010.12		Rear Axle Left & Right Lower Inner	Estate FWD AXX/BPY/BWA/CAWB/CBFA/CCTA/CCZA		Control Arm Bushing	510351	
2005.07-2010.12		Rear Axle Left & Right Lower Inner	Estate FWD AXX/BPY/BWA/CAWB/CBFA/CCTA/CCZA		Control Arm Bushing	510352	
2005.07-2010.12		Rear Axle Left & Right Lower Outer	Estate FWD AXX/BPY/BWA/CAWB/CBFA/CCTA/CCZA		Control Arm Bushing	516370	
2005.07-2010.12		Front Axle	Estate FWD AXX/BPY/BWA/CAWB/CBFA/CCTA/CCZA		Suspension Repair Kit	S990017SK	
2005.07-2010.12		Front Axle Left & Right	Estate FWD AXX/BPY/BWA/CAWB/CBFA/CCTA/CCZA		Tie Rod Axle Joint	S030009	
2005.07-2010.12		Front Axle Left	Estate FWD AXX/BPY/BWA/CAWB/CBFA/CCTA/CCZA		Tie Rod End	S070032	
2005.07-2010.12		Front Axle Right	Estate FWD AXX/BPY/BWA/CAWB/CBFA/CCTA/CCZA		Tie Rod End	S070033	
2005.07-2010.12		Front Axle Left & Right	Estate FWD AXX/BPY/BWA/CAWB/CBFA/CCTA/CCZA		Rod/Strut, stabiliser	S050040	
2005.07-2010.12		Rear Axle Left & Right	Estate FWD AXX/BPY/BWA/CAWB/CBFA/CCTA/CCZA		Rod/Strut, stabiliser	S050035	
2005.07-2010.12		Front Axle	Estate FWD AXX/BPY/BWA/CAWB/CBFA/CCTA/CCZA		Stabiliser Bushing	535187K	
2005.07-2010.12		Rear Axle	Estate FWD AXX/BPY/BWA/CAWB/CBFA/CCTA/CCZA		Stabiliser Bushing	516447	
2.0 (155 kw)		2010.11-2015.12	Front Axle Left Lower	Estate FWD CCZB		Track Control Arm	S061577
		2010.11-2015.12	Front Axle Right Lower	Estate FWD CCZB		Track Control Arm	S061578
		2010.11-2015.12	Front Axle Left & Right Lower	Estate FWD CCZB		Track Control Arm	S060762
	2010.11-2015.12	Rear Axle Left Centre	Estate FWD CCZB		Track Control Arm	S063095	
	2010.11-2015.12	Rear Axle Left Lower Inner	Estate FWD CCZB		Track Control Arm	510349	
	2010.11-2015.12	Rear Axle Right Centre	Estate FWD CCZB		Track Control Arm	S063094	
	2010.11-2015.12	Rear Axle Right Lower Inner	Estate FWD CCZB		Track Control Arm	510350	



	 YEAR	FITTING POSITION	BODY STYLE & DRIVE TYPE & ENGINE	REMARKS	PRODUCT	GSP Ref.
VW						
Passat Estate/Variant						
2.0 (155 kw)	2010.11-2015.12	Rear Axle Left & Right Upper	Estate FWD CCZB		Track Control Arm	510346
	2010.11-2015.12	Rear Axle Left & Right Lower Outer	Estate FWD CCZB		Track Control Arm	S061468
	2010.11-2015.12	Front Axle Left Lower	Estate FWD CCZB		Ball Joint	S080258
	2010.11-2015.12	Front Axle Right Lower	Estate FWD CCZB		Ball Joint	S080259
	2010.11-2015.12	Front Axle Left & Right Lower	Estate FWD CCZB	for driving without power for vehicles with 915 hp, no. 1162630775C	Control Arm Bushing	510353
	2010.11-2015.12	Front Axle Left & Right Lower	Estate FWD CCZB		Control Arm Bushing	510356
	2010.11-2015.12	Front Axle Left & Right Lower	Estate FWD CCZB		Control Arm Bushing	510361
	2010.11-2015.12	Rear Axle Left & Right Centre	Estate FWD CCZB		Control Arm Bushing	530530
	2010.11-2015.12	Rear Axle Left & Right Upper	Estate FWD CCZB		Control Arm Bushing	516372
	2010.11-2015.12	Rear Axle Left & Right Upper	Estate FWD CCZB		Control Arm Bushing	516408
	2010.11-2015.12	Rear Axle Left & Right Lower Inner	Estate FWD CCZB		Control Arm Bushing	510351
	2010.11-2015.12	Rear Axle Left & Right Lower Inner	Estate FWD CCZB		Control Arm Bushing	510352
	2010.11-2015.12	Rear Axle Left & Right Lower Outer	Estate FWD CCZB		Control Arm Bushing	516370
	2010.11-2015.12	Front Axle	Estate FWD CCZB		Suspension Repair Kit	S990017SK
	2010.11-2015.12	Front Axle Left & Right	Estate FWD CCZB		Tie Rod Axle Joint	S030009
	2010.11-2015.12	Front Axle Left	Estate FWD CCZB		Tie Rod End	S070032
	2010.11-2015.12	Front Axle Right	Estate FWD CCZB		Tie Rod End	S070033
	2010.11-2015.12	Front Axle Left & Right	Estate FWD CCZB		Rod/Strut, stabiliser	S050040
	2010.11-2015.12	Rear Axle Left & Right	Estate FWD CCZB		Rod/Strut, stabiliser	S050035
	2010.11-2015.12	Front Axle	Estate FWD CCZB		Stabiliser Bushing	535187K
	2010.11-2015.12	Rear Axle	Estate FWD CCZB		Stabiliser Bushing	516447
2.8 (128 kw)	1991.06-1996.12	Front Axle Left & Right Lower	Estate FWD AAA		Track Control Arm	S060758
	1991.06-1996.12	Front Axle Left & Right Lower	Estate FWD AAA	Engine Code AAA, Chassis no. 31-N-255 915, Engine Code AAA	Ball Joint	S080211
	1991.06-1996.12	Front Axle Left & Right Lower	Estate FWD AAA	Date from: 1992.01, Chassis no. from: 31-N-255 990	Ball Joint	S080212
	1991.06-1996.12	Front Axle Left & Right Lower	Estate FWD AAA		Control Arm Bushing	510024
	1991.06-1996.12	Front Axle Left & Right Lower	Estate FWD AAA		Control Arm Bushing	510025
	1991.06-1996.12	Front Axle Left & Right Lower	Estate FWD AAA		Control Arm Bushing	510084
	1991.06-1996.12	Front Axle Left & Right Lower	Estate FWD AAA		Control Arm Bushing Kit	510312S
	1991.06-1996.12	Front Axle Left	Estate FWD AAA		Rod Assembly	S100146
	1991.06-1996.12	Front Axle Right	Estate FWD AAA	for vehicles without power steering	Rod Assembly	S100147
	1991.06-1996.12	Front Axle Right	Estate FWD AAA	for vehicles with power steering	Rod Assembly	S100156
	1991.06-1996.12	Front Axle Left & Right	Estate FWD AAA		Tie Rod Axle Joint	S030490
	1991.06-1996.12	Front Axle Left & Right	Estate FWD AAA		Tie Rod Axle Joint	S030495
	1991.06-1996.12	Front Axle Left & Right	Estate FWD AAA		Tie Rod Axle Joint	S030842
	1991.06-1996.12	Front Axle Left	Estate FWD AAA		Tie Rod End	S070419
	1991.06-1996.12	Front Axle Right	Estate FWD AAA		Tie Rod End	S070418
	1991.06-1996.12	Front Axle Left & Right	Estate FWD AAA		Tie Rod End	S071200
	1991.06-1996.12	Front Axle Left & Right	Estate FWD AAA		Rod/Strut, stabiliser	510087
	1991.06-1996.12	Front Axle Left & Right	Estate FWD AAA		Rod/Strut, stabiliser	510088
	1991.06-1996.12	Front Axle Left & Right	Estate FWD AAA		Rod/Strut, stabiliser	510407
	1991.06-1996.12	Front Axle	Estate FWD AAA		Stabiliser Bushing	510085
	1991.06-1996.12	Front Axle	Estate FWD AAA		Stabiliser Bushing	510089
	1991.06-1996.12	Front Axle	Estate FWD AAA		Stabiliser Bushing	510205
	1991.06-1996.12	Front Axle	Estate FWD AAA		Steering Boot	540016
	1991.06-1996.12	Front Axle	Estate FWD AAA		Steering Boot	540384
	1991.06-1996.12	Front Axle	Estate FWD AAA	for vehicles with power steering	Steering Rack Bellow Kit	541026S
	1991.06-1996.12	Front Axle Left & Right	Estate FWD AAA		Securing Plate, ball joint	510023S
2.8 (140 kw)	2000.10-2005.05	Front Axle Left Lower Inner	Estate FWD BBG		Track Control Arm	S060055
	2000.10-2005.05	Front Axle Left Upper Outer	Estate FWD BBG		Track Control Arm	S060798
	2000.10-2005.05	Front Axle Left	Estate FWD BBG		Rod/Strut, stabiliser	520008
	2000.10-2005.05	Front Axle Left	Estate FWD BBG		Rod/Strut, stabiliser	S050034
	2000.10-2005.05	Front Axle Right	Estate FWD BBG		Rod/Strut, stabiliser	520010
	2000.10-2005.05	Front Axle Right	Estate FWD BBG		Rod/Strut, stabiliser	S050033
	2000.10-2005.05	Rear Axle Left & Right	Estate FWD BBG		Rod/Strut, stabiliser	S050035
	2000.10-2005.05	Front Axle	Estate FWD BBG	Stabiliser Ø:25 mm	Stabiliser Bushing	510138
	2000.10-2005.05	Front Axle	Estate FWD BBG		Stabiliser Bushing	510139
2.8 (142 kw)	1999.01-2000.08	Front Axle Left Lower Inner	Estate FWD APR		Track Control Arm	S060055
	1999.01-2000.08	Front Axle Left Upper Inner	Estate FWD APR		Track Control Arm	S062331
	1999.01-2000.08	Front Axle Left Upper Outer	Estate FWD APR		Track Control Arm	S060048
	1999.01-2000.08	Front Axle Left Upper Outer	Estate FWD APR		Track Control Arm	S060798
	1999.01-2000.08	Front Axle Left Upper Outer	Estate FWD APR		Track Control Arm	S062530
	1999.01-2000.08	Front Axle Right Lower Inner	Estate FWD APR		Track Control Arm	S060056
	1999.01-2000.08	Front Axle Right Upper Inner	Estate FWD APR		Track Control Arm	S062332
	1999.01-2000.08	Front Axle Right Upper Outer	Estate FWD APR		Track Control Arm	S060049

	 YEAR	FITTING POSITION	BODY STYLE & DRIVE TYPE & ENGINE	REMARKS	PRODUCT	GSP Ref.
VW						
Passat Estate/Variant						
2.8 (142 kw)						
	1999.01-2000.08	Front Axle Right Upper Outer	Estate FWD APR		Track Control Arm	S062531
	1999.01-2000.08	Front Axle Left & Right Lower Outer	Estate FWD APR		Track Control Arm	S060054
	1999.01-2000.08	Front Axle Left & Right Upper	Estate FWD APR		Control Arm Bushing	510136
	1999.01-2000.08	Front Axle Left & Right Lower Inner	Estate FWD APR		Control Arm Bushing	510135
	1999.01-2000.08	Front Axle Left & Right Lower Inner	Estate FWD APR		Control Arm Bushing	510287
	1999.01-2000.08	Front Axle Left & Right Lower Outer	Estate FWD APR		Control Arm Bushing	510133
	1999.01-2000.08	Front Axle Left & Right Lower Outer	Estate FWD APR		Control Arm Bushing	510134
	1999.01-2000.08	Front Axle	Estate FWD APR		Suspension Repair Kit	S990001SK
	1999.01-2000.08	Front Axle Left & Right	Estate FWD APR		Rod Assembly	S100014
	1999.01-2000.08	Front Axle Left & Right	Estate FWD APR		Tie Rod End	S070038
	1999.01-2000.08	Front Axle Left	Estate FWD APR		Rod/Strut, stabiliser	520008
	1999.01-2000.08	Front Axle Left	Estate FWD APR		Rod/Strut, stabiliser	S050034
	1999.01-2000.08	Front Axle Right	Estate FWD APR		Rod/Strut, stabiliser	520010
	1999.01-2000.08	Front Axle Right	Estate FWD APR		Rod/Strut, stabiliser	S050033
	1999.01-2000.08	Front Axle	Estate FWD APR	Stabiliser Ø:25 mm	Stabiliser Bushing	510138
	1999.01-2000.08	Front Axle	Estate FWD APR	Stabiliser Ø:29 mm	Stabiliser Bushing	510139
	1999.01-2000.08	Front Axle Left	Estate FWD APR		Steering Boot	540043
	1999.01-2000.08	Front Axle Left	Estate FWD APR		Steering Rack Bellow Kit	540043S
3.2 (184 kw)						
	2005.09-2010.11	Front Axle Left & Right Lower	Estate 4WD AXZ		Track Control Arm	S060762
	2005.09-2010.11	Rear Axle Left Centre	Estate 4WD AXZ		Track Control Arm	S063095
	2005.09-2010.11	Rear Axle Left Lower Inner	Estate 4WD AXZ		Track Control Arm	510349
	2005.09-2010.11	Rear Axle Right Centre	Estate 4WD AXZ		Track Control Arm	S063094
	2005.09-2010.11	Rear Axle Right Lower Inner	Estate 4WD AXZ		Track Control Arm	510350
	2005.09-2010.11	Rear Axle Left & Right Upper	Estate 4WD AXZ		Track Control Arm	510346
	2005.09-2010.11	Rear Axle Left & Right Lower Outer	Estate 4WD AXZ		Track Control Arm	S061468
	2005.09-2010.11	Front Axle Left Lower	Estate 4WD AXZ		Ball Joint	S080258
	2005.09-2010.11	Front Axle Right Lower	Estate 4WD AXZ		Ball Joint	S080259
	2005.09-2010.11	Front Axle Left & Right Lower	Estate 4WD AXZ		Control Arm Bushing	510356
	2005.09-2010.11	Front Axle Left & Right Lower	Estate 4WD AXZ		Control Arm Bushing	510361
	2005.09-2010.11	Rear Axle Left & Right Centre	Estate 4WD AXZ		Control Arm Bushing	530530
	2005.09-2010.11	Rear Axle Left & Right Upper	Estate 4WD AXZ		Control Arm Bushing	516372
	2005.09-2010.11	Rear Axle Left & Right Upper	Estate 4WD AXZ		Control Arm Bushing	516408
	2005.09-2010.11	Rear Axle Left & Right Lower Inner	Estate 4WD AXZ		Control Arm Bushing	510351
	2005.09-2010.11	Rear Axle Left & Right Lower Inner	Estate 4WD AXZ		Control Arm Bushing	510352
	2005.09-2010.11	Rear Axle Left & Right Lower Outer	Estate 4WD AXZ		Control Arm Bushing	516370
	2005.09-2010.11	Front Axle	Estate 4WD AXZ		Suspension Repair Kit	S990017SK
	2005.09-2010.11	Front Axle Left & Right	Estate 4WD AXZ		Tie Rod Axle Joint	S030009
	2005.09-2010.11	Front Axle Left	Estate 4WD AXZ		Tie Rod End	S070032
	2005.09-2010.11	Front Axle Right	Estate 4WD AXZ		Tie Rod End	S070033
	2005.09-2010.11	Front Axle Left & Right	Estate 4WD AXZ		Rod/Strut, stabiliser	S050040
	2005.09-2010.11	Rear Axle Left & Right	Estate 4WD AXZ		Rod/Strut, stabiliser	S050035
	2005.09-2010.11	Front Axle	Estate 4WD AXZ		Stabiliser Bushing	535187K
	2005.09-2010.11	Rear Axle	Estate 4WD AXZ		Stabiliser Bushing	516447
Polo						
1.0 (58 kw)						
	2002.07-2004.01	Front Axle Left Lower	Hatchback FWD ARA		Track Control Arm	S061484
	2002.07-2004.01	Front Axle Right Lower	Hatchback FWD ARA	VIN from:9N-9Y 035 001,9N-9B 031 001,9N-9U 022 151	Track Control Arm	S061485
	2002.07-2004.01	Front Axle Left & Right Lower	Hatchback FWD ARA	VIN to:9N-9Y 035 000,9N-9B 031 000,9N-9U 022 150	Track Control Arm	S060716
	2002.07-2004.01	Front Axle Left & Right	Hatchback FWD ARA		Tie Rod Axle Joint	S030622
	2002.07-2004.01	Front Axle Left & Right	Hatchback FWD ARA	to:9N-9B 035 000,9N-9B 031 000,9N-9U 022 151	Tie Rod Axle Joint	S030632
	2002.07-2004.01	Front Axle Left	Hatchback FWD ARA		Tie Rod End	S070014
	2002.07-2004.01	Front Axle Right	Hatchback FWD ARA		Tie Rod End	S070015
	2002.07-2004.01	Front Axle Left & Right	Hatchback FWD ARA		Rod/Strut, stabiliser	S050038
	2002.07-2004.01	Front Axle	Hatchback FWD ARA	VIN from:9N3 190001	Steering Rack Bellow Kit	540203S
1.0 (62 kw)						
	2017.09-	Front Axle Right Lower	Hatchback FWD CSEB		Ball Joint	S080012
	2017.09-	Front Axle Left & Right Lower	Hatchback FWD CSEB		Control Arm Bushing	510084
	2017.09-	Front Axle Left	Hatchback FWD CSEB		Tie Rod End	S070032
	2017.09-	Front Axle Right	Hatchback FWD CSEB		Tie Rod End	S070033
	2017.09-	Front Axle Left & Right	Hatchback FWD CSEB		Rod/Strut, stabiliser	S050038
1.0 (94 kw)						
	2017.09-	Front Axle Right Lower	Hatchback FWD DHSB		Ball Joint	S080012
	2017.09-	Front Axle Left & Right Lower	Hatchback FWD DHSB		Control Arm Bushing	510084
	2017.09-	Front Axle Left	Hatchback FWD DHSB		Tie Rod End	S070032
	2017.09-	Front Axle Right	Hatchback FWD DHSB		Tie Rod End	S070033
	2017.09-	Front Axle Left & Right	Hatchback FWD DHSB		Rod/Strut, stabiliser	S050038



 YEAR	FITTING POSITION	BODY STYLE & DRIVE TYPE & ENGINE	REMARKS	PRODUCT	GSP Ref.
VW Polo					
1.4 (110 kw)	2019.11-	Front Axle Right Lower	Hatchback FWD CWLA		Ball Joint S080012
	2019.11-	Front Axle Left	Hatchback FWD CWLA		Tie Rod End S070032
	2019.11-	Front Axle Right	Hatchback FWD CWLA		Tie Rod End S070033
	2019.11-	Front Axle Left & Right	Hatchback FWD CWLA		Rod/Strut, stabiliser S050038
1.6 (74 kw)	2002.02-2006.07	Front Axle Left Lower	Hatchback FWD BAH/BPA		Track Control Arm S061484
	2002.02-2006.07	Front Axle Right Lower	Hatchback FWD BAH/BPA	VIN from:9N-9U022 151	Track Control Arm S061485
	2002.02-2006.07	Front Axle Left & Right Lower	Hatchback FWD BAH/BPA	Engine Code:BAH,VIN to:9N-9U022 150 Engine Code:BAH	Track Control Arm S060716
	2002.02-2006.07	Front Axle Left & Right Lower	Hatchback FWD BAH/BPA	Chassis no.from:9N-9U022 151	Control Arm Bushing 510084
	2002.02-2006.07	Front Axle Left & Right Lower	Hatchback FWD BAH/BPA	Engine Code:BAH,Chassis no.to:9N-9U022 150	Control Arm Bushing 510332
	2002.02-2006.07	Front Axle Left	Hatchback FWD BAH/BPA		Rod Assembly S100115
	2002.02-2006.07	Front Axle Right	Hatchback FWD BAH/BPA		Rod Assembly S100116
	2002.02-2006.07	Front Axle Left & Right	Hatchback FWD BAH/BPA		Tie Rod Axle Joint S030622
	2002.02-2006.07	Front Axle Left & Right	Hatchback FWD BAH/BPA	for vehicles with power steering,for PR no.:1N2	Tie Rod Axle Joint S030632
	2002.02-2006.07	Front Axle Left	Hatchback FWD BAH/BPA		Tie Rod End S070014
	2002.02-2006.07	Front Axle Right	Hatchback FWD BAH/BPA		Tie Rod End S070015
	2002.02-2006.07	Front Axle	Hatchback FWD BAH/BPA		Stabiliser Bushing 530229
	2002.02-2006.07	Front Axle	Hatchback FWD BAH/BPA		Steering Rack Bellow Kit 540203S
	2002.11-2006.07	Front Axle Left Lower	Saloon FWD BAH		Track Control Arm S061029
	2002.11-2006.07	Front Axle Right Lower	Saloon FWD BAH		Track Control Arm S061028
	2002.11-2006.07	Front Axle Left & Right Lower	Saloon FWD BAH	Engine code:BAH	Track Control Arm S060716
	2002.11-2006.07	Front Axle Left Lower	Saloon FWD BAH		Ball Joint S080010
	2002.11-2006.07	Front Axle Right Lower	Saloon FWD BAH		Ball Joint S080011
	2002.11-2006.07	Front Axle Left & Right Lower	Saloon FWD BAH		Control Arm Bushing 510151
	2002.11-2006.07	Front Axle Left & Right Lower	Saloon FWD BAH		Control Arm Bushing 510332
	2002.11-2006.07	Front Axle Left	Saloon FWD BAH		Rod Assembly S100115
	2002.11-2006.07	Front Axle Right	Saloon FWD BAH		Rod Assembly S100116
	2002.11-2006.07	Front Axle Left & Right	Saloon FWD BAH	Engine code:BAH for vehicles with electro-hydraulic steering,for PR no.:1N21DK	Tie Rod Axle Joint S030622
	2002.11-2006.07	Front Axle Left & Right	Saloon FWD BAH	Engine code:BAH for vehicles with power steering,for PR no.:1N21DK	Tie Rod Axle Joint S030632
	2002.11-2006.07	Front Axle Left	Saloon FWD BAH		Tie Rod End S070014
	2002.11-2006.07	Front Axle Right	Saloon FWD BAH		Tie Rod End S070015
	2002.11-2006.07	Front Axle Left & Right	Saloon FWD BAH		Rod/Strut, stabiliser S050038
	2002.11-2006.07	Front Axle	Saloon FWD BAH		Stabiliser Bushing 517168
	2002.11-2006.07	Front Axle	Saloon FWD BAH		Stabiliser Bushing 517169
	2002.11-2006.07	Front Axle	Saloon FWD BAH		Stabiliser Bushing 530229
	2002.11-2006.07	Front Axle	Saloon FWD BAH		Steering Boot 540203
	1.6 (76 kw)	2004.12-2008.04	Front Axle Left Lower	Hatchback FWD BPA	
2004.12-2008.04		Front Axle Right Lower	Hatchback FWD BPA	VIN from:9N-9Y 035 001,9N-9B 031 001,9N-9U 022 151	Track Control Arm S061485
2004.12-2008.04		Front Axle Left & Right Lower	Hatchback FWD BPA	VIN to:9N-9Y 035 000,9N-9B 031 000,9N-9U 022 150	Track Control Arm S060716
2004.12-2008.04		Front Axle Left & Right Lower	Saloon FWD BPA		Control Arm Bushing 510332
2004.12-2008.04		Front Axle Left	Saloon FWD BPA		Rod Assembly S100115
2004.12-2008.04		Front Axle Right	Saloon FWD BPA		Rod Assembly S100116
2004.12-2008.04		Front Axle Left & Right	Hatchback FWD BPA		Tie Rod Axle Joint S030622
2004.12-2008.04		Front Axle Left & Right	Hatchback FWD BPA	for vehicles with power steering	Tie Rod Axle Joint S030632
2004.12-2008.04		Front Axle Left	Hatchback FWD BPA		Tie Rod End S070014
2004.12-2008.04		Front Axle Right	Hatchback FWD BPA		Tie Rod End S070015
2004.12-2008.04		Front Axle Left & Right	Hatchback FWD BPA		Rod/Strut, stabiliser S050038
2004.12-2008.04		Front Axle	Hatchback FWD BPA	VIN from:9N3 190001	Steering Rack Bellow Kit 540203S
1.8 (110 kw)	2005.09-2009.11	Front Axle Left Lower	Hatchback FWD BJX		Track Control Arm S061029
	2005.09-2009.11	Front Axle Left Lower	Hatchback FWD BJX	Chassis no.from:9N-9B031 001,9N-9U022 151,9N-9Y035 001	Track Control Arm S061484
	2005.09-2009.11	Front Axle Right Lower	Hatchback FWD BJX		Track Control Arm S061028
	2005.09-2009.11	Front Axle Right Lower	Hatchback FWD BJX	Chassis no.from:9N-9B031 001,9N-9U022 151,9N-9Y035 001	Track Control Arm S061485
	2005.09-2009.11	Front Axle Left & Right Lower	Hatchback FWD BJX	Chassis no.to:9N-9B031 000,9N-9U022 150,9N-9Y035 000	Track Control Arm S060716
	2005.09-2009.11	Front Axle Left Lower	Hatchback FWD BJX	Chassis no.to:9N-9B031 000,9N-9U022 150,9N-9Y035 000	Ball Joint S080010
	2005.09-2009.11	Front Axle Left Lower	Hatchback FWD BJX	Chassis no.from:9N-9B031 001,9N-9U022 151,9N-9Y035 001	Ball Joint S080015
	2005.09-2009.11	Front Axle Right Lower	Hatchback FWD BJX	Chassis no.to:9N-9B031 000,9N-9U022 150,9N-9Y035 000	Ball Joint S080011
	2005.09-2009.11	Front Axle Right Lower	Hatchback FWD BJX	Chassis no.from:9N-9B031 001,9N-9U022 151,9N-9Y035 001	Ball Joint S080014
	2005.09-2009.11	Front Axle Left & Right Lower	Hatchback FWD BJX		Control Arm Bushing 510065
	2005.09-2009.11	Front Axle Left & Right Lower	Hatchback FWD BJX	Chassis no.from:9N-9B031 001,9N-9U022 151,9N-9Y035 001	Control Arm Bushing 510084
	2005.09-2009.11	Front Axle Left & Right Lower	Hatchback FWD BJX	To Chassis:9N9050000	Control Arm Bushing 510151
	2005.09-2009.11	Front Axle Left & Right Lower	Hatchback FWD BJX		Control Arm Bushing 510151
	2005.09-2009.11	Front Axle Left & Right Lower	Hatchback FWD BJX	Chassis no.to:9N-9B031 000,9N-9U022 150,9N-9Y035 000	Control Arm Bushing 510332
	2005.09-2009.11	Front Axle	Hatchback FWD BJX		Suspension Repair Kit S990013SK
	2005.09-2009.11	Front Axle Left	Hatchback FWD BJX		Rod Assembly S100115
	2005.09-2009.11	Front Axle Right	Hatchback FWD BJX		Rod Assembly S100116



	 YEAR	FITTING POSITION	BODY STYLE & DRIVE TYPE & ENGINE	REMARKS	PRODUCT	GSP Ref.
VW Polo						
1.8 (110 kw)	2005.09-2009.11	Front Axle Left & Right	Hatchback FWD BJB		Tie Rod Axle Joint	S030622
	2005.09-2009.11	Front Axle Left & Right	Hatchback FWD BJB	for vehicles with power steering,For PR no.:1N2/1N5	Tie Rod Axle Joint	S030632
	2005.09-2009.11	Front Axle Left	Hatchback FWD BJB		Tie Rod End	S070014
	2005.09-2009.11	Front Axle Right	Hatchback FWD BJB		Tie Rod End	S070015
	2005.09-2009.11	Front Axle Left & Right	Hatchback FWD BJB		Rod/Strut,stabiliser	S050038
	2005.09-2009.11	Front Axle	Hatchback FWD BJB	for PR no.:0AQ	Stabiliser Bushing	517167
	2005.09-2009.11	Front Axle	Hatchback FWD BJB		Stabiliser Bushing	517168
	2005.09-2009.11	Front Axle	Hatchback FWD BJB		Stabiliser Bushing	517169
	2005.09-2009.11	Front Axle	Hatchback FWD BJB		Steering Boot	540203
	2005.09-2009.11	Front Axle	Hatchback FWD BJB		Steering Rack Bellow Kit	540203S
2.0 (85 kw)	2002.04-2006.07	Front Axle Left Lower	Hatchback FWD BBX		Track Control Arm	S061484
	2002.04-2006.07	Front Axle Right Lower	Hatchback FWD BBX	VIN from:9N-9U022 151	Track Control Arm	S061485
	2002.04-2006.07	Front Axle Left & Right Lower	Hatchback FWD BBX	Engine Code:BBX,VIN to:9N-9U022 150,Engine Code:BBX	Track Control Arm	S060716
	2002.04-2006.07	Front Axle Left & Right Lower	Hatchback FWD BBX	Chassis no.from:9N-9U022 151	Control Arm Bushing	510084
	2002.04-2006.07	Front Axle Left & Right Lower	Hatchback FWD BBX	Engine Code:BBX,Chassis no.to:9N-9U022 150,Engine Code:BBX	Control Arm Bushing	510332
	2002.04-2006.07	Front Axle Left & Right	Hatchback FWD BBX		Tie Rod Axle Joint	S030622
	2002.04-2006.07	Front Axle Left & Right	Hatchback FWD BBX	for vehicles with power steering,for PR no.:1N2	Tie Rod Axle Joint	S030632
	2002.04-2006.07	Front Axle Left	Hatchback FWD BBX		Tie Rod End	S070014
	2002.04-2006.07	Front Axle Right	Hatchback FWD BBX		Tie Rod End	S070015
	2002.04-2006.07	Front Axle Left & Right	Hatchback FWD BBX		Rod/Strut,stabiliser	S050038
	2002.04-2006.07	Front Axle	Hatchback FWD BBX		Stabiliser Bushing	530229
	2002.04-2006.07	Front Axle	Hatchback FWD BBX		Steering Rack Bellow Kit	540203S
2.0 (88 kw)	2008.05-2014.12	Front Axle Left & Right Lower	Saloon FWD CFEA		Control Arm Bushing	510332
	2008.05-2014.12	Front Axle Left	Saloon FWD CFEA		Rod Assembly	S100115
	2008.05-2014.12	Front Axle Right	Saloon FWD CFEA		Rod Assembly	S100116
	2008.10-2012.01	Front Axle Left Lower	Hatchback FWD CFEA		Track Control Arm	S061484
	2008.10-2012.01	Front Axle Right Lower	Hatchback FWD CFEA	VIN from:9N-9Y 035 001,9N-9B 031 001,9N-9U 022 151	Track Control Arm	S061485
	2008.10-2012.01	Front Axle Left & Right Lower	Hatchback FWD CFEA	VIN to:9N-9Y 035 000,9N-9B 031 000,9N-9U 022 150	Track Control Arm	S060716
	2008.10-2012.01	Front Axle Left & Right Lower	Hatchback FWD CFEA		Control Arm Bushing	510332
	2008.10-2012.01	Front Axle Left & Right	Hatchback FWD CFEA		Tie Rod Axle Joint	S030632
	2008.10-2012.01	Front Axle Left	Hatchback FWD CFEA		Tie Rod End	S070014
	2008.10-2012.01	Front Axle Right	Hatchback FWD CFEA		Tie Rod End	S070015
	2008.10-2012.01	Front Axle Left & Right	Hatchback FWD CFEA		Rod/Strut,stabiliser	S050038
	2008.10-2012.01	Front Axle	Hatchback FWD CFEA	for vehicles with power steering	Steering Rack Bellow Kit	540203S
Polo Classic						
1.4 (61 kw)	2003.01-2010.12	Front Axle Left & Right Lower	Saloon FWD BLM		Control Arm Bushing	510332
	2003.01-2010.12	Front Axle Left & Right	Saloon FWD BLM		Rod/Strut,stabiliser	S050038
1.6 (74 kw)	2002.09-2005.05	Front Axle Left & Right Lower	Saloon FWD BAH		Control Arm Bushing	510332
	2002.09-2005.05	Front Axle Left & Right	Saloon FWD BAH		Rod/Strut,stabiliser	S050038
	2002.09-2005.05	Front Axle	Saloon FWD BAH		Stabiliser Bushing	530229
1.6 (77 kw)	2007.01-2010.12	Front Axle Left & Right Lower	Saloon FWD BTS		Control Arm Bushing	510332
	2007.01-2010.12	Front Axle Left & Right	Saloon FWD BTS		Rod/Strut,stabiliser	S050038
1.8 (82 kw)	2000.08-2002.07	Front Axle Left & Right Lower	Saloon FWD AFV		Control Arm Bushing	510084
Polo Vivo						
1.4 (55 kw)	2010.02-2017.09	Front Axle Left & Right Lower	Saloon FWD CLPB		Control Arm Bushing	510084
	2010.02-2017.09	Front Axle Left & Right	Saloon FWD CLPB		Rod/Strut,stabiliser	S050038
1.4 (63 kw)	2010.02-2017.09	Front Axle Left & Right Lower	Saloon FWD CLPA		Control Arm Bushing	510084
	2010.02-2017.09	Front Axle Left & Right	Saloon FWD CLPA		Rod/Strut,stabiliser	S050038
1.6 (77 kw)	2010.02-2017.09	Front Axle Left & Right Lower	Saloon FWD CLSA		Control Arm Bushing	510084
	2010.02-2017.09	Front Axle Left & Right	Saloon FWD CLSA		Rod/Strut,stabiliser	S050038
Quantum						
1.7 (58 kw)	1981.09-1983.12	Front Axle	Hatchback FWD WT		Stabiliser Bushing	510164
	1981.09-1983.12	Front Axle	Estate FWD WT		Stabiliser Bushing	510164
	1981.09-1983.12	Front Axle	Saloon FWD WT		Stabiliser Bushing	510164
1.8 (66 kw)	1983.09-1985.12	Front Axle	Saloon FWD JN		Stabiliser Bushing	510164
1.8 (76 kw)	1984.08-1985.12	Front Axle	Saloon FWD JN		Stabiliser Bushing	510164
2.2 (79 kw)	1982.09-1983.12	Front Axle	Hatchback FWD WE		Stabiliser Bushing	510164
	1982.09-1984.12	Front Axle	Estate FWD WE		Stabiliser Bushing	510164
	1982.09-1984.12	Front Axle	Saloon FWD WE		Stabiliser Bushing	510164
2.2 (82 kw)	1985.08-1986.12	Front Axle	Hatchback FWD KX		Stabiliser Bushing	510164
2.2 (88 kw)	1984.09-1985.12	Front Axle	Saloon FWD KX		Stabiliser Bushing	510164
	1985.08-1988.12	Front Axle	Saloon FWD KX		Stabiliser Bushing	510164
	1985.09-1988.12	Front Axle	Estate AWD KX		Stabiliser Bushing	510164



	 YEAR	FITTING POSITION	BODY STYLE & DRIVE TYPE & ENGINE	REMARKS	PRODUCT	GSP Ref.
VW						
Saveiro						
1.6 (74 kw)	2009.09-	Front Axle Left & Right Lower	Pick up FWD CCRA		Control Arm Bushing	510084
	2009.09-	Front Axle Left & Right Lower	Pick up FWD CCRA/CFZA		Control Arm Bushing	510084
	2009.09-	Front Axle Left & Right	Pick up FWD CCRA/CFZA		Rod/Strut,stabiliser	S050038
	2009.09-	Front Axle Left & Right	Pick up FWD CCRA		Rod/Strut,stabiliser	S050038
	2016.01-	Front Axle Left & Right	Pick up FWD CFZA		Rod/Strut,stabiliser	S050038
1.6 (76 kw)	2009.09-2016.10	Front Axle Left & Right Lower	Pick up FWD CCRA		Control Arm Bushing	510084
	2009.09-2016.10	Front Axle Left & Right	Pick up FWD CCRA		Rod/Strut,stabiliser	S050038
	2014.10-2016.10	Front Axle Left & Right Lower	Pick up FWD CCRA		Control Arm Bushing	510084
	2014.10-2016.10	Front Axle Left & Right	Pick up FWD CCRA		Rod/Strut,stabiliser	S050038
	2016.01-	Front Axle Left & Right	Pick up FWD CCRA		Rod/Strut,stabiliser	S050038
1.6 (81 kw)	2014.10-	Front Axle Left & Right Lower	Pick up FWD CWSA		Control Arm Bushing	510084
	2014.10-	Front Axle Left & Right	Pick up FWD CWSA		Rod/Strut,stabiliser	S050038
1.6 (88 kw)	2014.03-2016.10	Front Axle Left & Right Lower	Pick up FWD CNXA		Control Arm Bushing	510084
	2014.03-2016.10	Front Axle Left & Right	Pick up FWD CNXA		Rod/Strut,stabiliser	S050038
	2016.01-	Front Axle Left & Right	Pick up FWD CNXA		Rod/Strut,stabiliser	S050038
Spacefox/Space Cross						
1.6 (76 kw)	2006.03-	Front Axle Left & Right Lower	Estate FWD BPA/CCRA		Control Arm Bushing	510332
	2006.03-	Front Axle Left & Right	Estate FWD BPA/CCRA		Rod/Strut,stabiliser	S050038
1.6 (81 kw)	2015.04-	Front Axle Left & Right Lower	Estate FWD CWSA		Control Arm Bushing	510084
	2015.04-	Front Axle Left & Right	Estate FWD CWSA		Rod/Strut,stabiliser	S050038
1.6 (88 kw)	2014.10-2018.12	Front Axle Left & Right Lower	Estate FWD CNXA		Control Arm Bushing	510084
	2014.10-2018.12	Front Axle Left & Right	Estate FWD CNXA		Rod/Strut,stabiliser	S050038
Suran						
1.9 (47 kw)	2007.11-2010.11	Front Axle Left & Right Lower	Estate FWD ASY		Control Arm Bushing	510332
	2007.11-2010.11	Front Axle Left & Right	Estate FWD ASY		Rod/Strut,stabiliser	S050038
Suran Variant						
1.6 (74 kw)	2015.10-	Front Axle Left & Right Lower	Estate FWD CFZA		Control Arm Bushing	510332
	2015.10-	Front Axle Left & Right	Estate FWD CFZA		Rod/Strut,stabiliser	S050038
T-Cross						
1.0 (94 kw)	2019.01-	Front Axle Left & Right Lower	SUV FWD DHSB		Control Arm Bushing	510084
	2019.01-	Front Axle Left & Right	SUV FWD DHSB		Rod/Strut,stabiliser	S050038
1.4 (110 kw)	2019.01-	Front Axle Left & Right Lower	SUV FWD CWLA		Control Arm Bushing	510084
	2019.01-	Front Axle Left & Right	SUV FWD CWLA		Rod/Strut,stabiliser	S050038
Tiguan						
1.4 (110 kw)	2015.05-2018.07	Front Axle Left Lower	SUV FWD CZDA		Track Control Arm	S061577
	2015.05-2018.07	Front Axle Right Lower	SUV FWD CZDA		Track Control Arm	S061578
	2015.05-2018.07	Rear Axle Left Centre	SUV FWD CZDA		Track Control Arm	S063095
	2015.05-2018.07	Rear Axle Left Lower Inner	SUV FWD CZDA		Track Control Arm	510349
	2015.05-2018.07	Rear Axle Right Centre	SUV FWD CZDA		Track Control Arm	S063094
	2015.05-2018.07	Rear Axle Right Lower Inner	SUV FWD CZDA		Track Control Arm	510350
	2015.05-2018.07	Rear Axle Left & Right Upper	SUV FWD CZDA		Track Control Arm	510346
	2015.05-2018.07	Rear Axle Left & Right Lower Outer	SUV FWD CZDA		Track Control Arm	S061468
	2015.05-2018.07	Front Axle Left Lower	SUV FWD CZDA		Ball Joint	S080013
	2015.05-2018.07	Front Axle Right Lower	SUV FWD CZDA		Ball Joint	S080012
	2015.05-2018.07	Front Axle Left & Right Lower	SUV FWD CZDA		Control Arm Bushing	510356
	2015.05-2018.07	Front Axle Left & Right Lower	SUV FWD CZDA		Control Arm Bushing	510361
	2015.05-2018.07	Rear Axle Left & Right Upper	SUV FWD CZDA		Control Arm Bushing	516372
	2015.05-2018.07	Rear Axle Left & Right Upper	SUV FWD CZDA		Control Arm Bushing	516408
	2015.05-2018.07	Rear Axle Left & Right Lower Inner	SUV FWD CZDA		Control Arm Bushing	510351
	2015.05-2018.07	Rear Axle Left & Right Lower Inner	SUV FWD CZDA		Control Arm Bushing	510352
	2015.05-2018.07	Rear Axle Left & Right Lower Outer	SUV FWD CZDA		Control Arm Bushing	516370
	2015.05-2018.07	Front Axle Left & Right	SUV FWD CZDA		Tie Rod Axle Joint	S030009
	2015.05-2018.07	Front Axle Left	SUV FWD CZDA		Tie Rod End	S070032
	2015.05-2018.07	Front Axle Right	SUV FWD CZDA		Tie Rod End	S070033
	2015.05-2018.07	Front Axle Left & Right	SUV FWD CZDA		Rod/Strut,stabiliser	S050040
	2015.05-2018.07	Rear Axle Left & Right	SUV FWD CZDA		Rod/Strut,stabiliser	S050035
	2015.05-2018.07	Front Axle	SUV FWD CZDA		Stabiliser Bushing	535187K
	2015.05-2018.07	Rear Axle	SUV FWD CZDA	Stabiliser Ø:20,7 mm	Stabiliser Bushing	516447
	2015.05-2018.07	Rear Axle	SUV FWD CZDA		Stabiliser Bushing	530183
2.0 (147 kw)	2007.11-2018.07	Front Axle Left Lower	SUV FWD CAWB/CCTA		Track Control Arm	S061577
	2007.11-2018.07	Front Axle Right Lower	SUV FWD CAWB/CCTA		Track Control Arm	S061578
	2007.11-2018.07	Front Axle Left & Right Lower	SUV FWD CAWB/CCTA		Track Control Arm	S060762
	2007.11-2018.07	Rear Axle Left Centre	SUV FWD CAWB/CCTA		Track Control Arm	S063095
	2007.11-2018.07	Rear Axle Left Lower Inner	SUV FWD CAWB/CCTA		Track Control Arm	510349



	 YEAR	FITTING POSITION	BODY STYLE & DRIVE TYPE & ENGINE	REMARKS	PRODUCT	GSP Ref.
VW Tiguan						
2.0 (147 kw)	2007.11-2018.07	Rear Axle Right Centre	SUV FWD CAWB/CCTA		Track Control Arm	S063094
	2007.11-2018.07	Rear Axle Right Lower Inner	SUV FWD CAWB/CCTA		Track Control Arm	510350
	2007.11-2018.07	Rear Axle Left & Right Upper	SUV FWD CAWB/CCTA		Track Control Arm	510346
	2007.11-2018.07	Rear Axle Left & Right Lower Outer	SUV FWD CAWB/CCTA		Track Control Arm	S061468
	2007.11-2018.07	Front Axle Left Lower	SUV FWD CAWB/CCTA		Ball Joint	S080013
	2007.11-2018.07	Front Axle Right Lower	SUV FWD CAWB/CCTA		Ball Joint	S080012
	2007.11-2018.07	Front Axle Left & Right Lower	SUV FWD CAWB/CCTA		Control Arm Bushing	510356
	2007.11-2018.07	Front Axle Left & Right Lower	SUV FWD CAWB/CCTA	Engine Code:CCTA	Control Arm Bushing	510361
	2007.11-2018.07	Rear Axle Left & Right Upper	SUV FWD CAWB/CCTA		Control Arm Bushing	516372
	2007.11-2018.07	Rear Axle Left & Right Upper	SUV FWD CAWB/CCTA	Engine Code:CCTA,Date to:2012.05,Engine Code:CCTA	Control Arm Bushing	516408
	2007.11-2018.07	Rear Axle Left & Right Lower Inner	SUV FWD CAWB/CCTA	Engine Code:CCTA,Date from-to:2008.11-2009.06,Engine Code:CCTA	Control Arm Bushing	510351
	2007.11-2018.07	Rear Axle Left & Right Lower Inner	SUV FWD CAWB/CCTA	Engine Code:CCTA	Control Arm Bushing	510352
	2007.11-2018.07	Rear Axle Left & Right Lower Outer	SUV FWD CAWB/CCTA		Control Arm Bushing	516370
	2007.11-2018.07	Front Axle Left & Right	SUV FWD CAWB/CCTA		Tie Rod Axle Joint	S030009
	2007.11-2018.07	Front Axle Left	SUV FWD CAWB/CCTA		Tie Rod End	S070032
	2007.11-2018.07	Front Axle Right	SUV FWD CAWB/CCTA		Tie Rod End	S070033
	2007.11-2018.07	Front Axle Left & Right	SUV FWD CAWB/CCTA		Rod/Strut,stabiliser	S050040
	2007.11-2018.07	Rear Axle Left & Right	SUV FWD CAWB/CCTA		Rod/Strut,stabiliser	S050035
	2007.11-2018.07	Front Axle	SUV FWD CAWB/CCTA		Stabiliser Bushing	535187K
	2007.11-2018.07	Rear Axle	SUV FWD CAWB/CCTA	Engine Code:CCTA,Date from-to:2008.11-2009.06,for PFR no.:08E	Stabiliser Bushing	516447
	2007.11-2018.07	Rear Axle	SUV FWD CAWB/CCTA	Date from-to:2008.11-2009.06,Stabiliser Ø21.7 mm,for PFR no.:08E	Stabiliser Bushing	530183
	2007.11-2018.07	Rear Axle	SUV FWD CAWB/CCTA	Date from-to:2008.11-2009.06,for PFR no.:08C	Stabiliser Bushing	530199
2.0 (155 kw)	2011.05-2018.07	Front Axle Left Lower	SUV 4WD CCZB		Track Control Arm	S061577
	2011.05-2018.07	Front Axle Right Lower	SUV 4WD CCZB		Track Control Arm	S061578
	2011.05-2018.07	Rear Axle Left Centre	SUV 4WD CCZB		Track Control Arm	S063095
	2011.05-2018.07	Rear Axle Left Lower Inner	SUV 4WD CCZB		Track Control Arm	510349
	2011.05-2018.07	Rear Axle Right Centre	SUV 4WD CCZB		Track Control Arm	S063094
	2011.05-2018.07	Rear Axle Right Lower Inner	SUV 4WD CCZB		Track Control Arm	510350
	2011.05-2018.07	Rear Axle Left & Right Upper	SUV 4WD CCZB		Track Control Arm	510346
	2011.05-2018.07	Rear Axle Left & Right Lower Outer	SUV 4WD CCZB		Track Control Arm	S061468
	2011.05-2018.07	Front Axle Left Lower	SUV 4WD CCZB		Ball Joint	S080013
	2011.05-2018.07	Front Axle Right Lower	SUV 4WD CCZB		Ball Joint	S080012
	2011.05-2018.07	Front Axle Left & Right Lower	SUV 4WD CCZB		Control Arm Bushing	510356
	2011.05-2018.07	Front Axle Left & Right Lower	SUV 4WD CCZB		Control Arm Bushing	510361
	2011.05-2018.07	Rear Axle Left & Right Upper	SUV 4WD CCZB		Control Arm Bushing	516372
	2011.05-2018.07	Rear Axle Left & Right Upper	SUV 4WD CCZB		Control Arm Bushing	516408
	2011.05-2018.07	Rear Axle Left & Right Lower Inner	SUV 4WD CCZB		Control Arm Bushing	510351
	2011.05-2018.07	Rear Axle Left & Right Lower Inner	SUV 4WD CCZB		Control Arm Bushing	510352
	2011.05-2018.07	Rear Axle Left & Right Lower Outer	SUV 4WD CCZB		Control Arm Bushing	516370
	2011.05-2018.07	Front Axle Left & Right	SUV 4WD CCZB		Tie Rod Axle Joint	S030009
	2011.05-2018.07	Front Axle Left	SUV 4WD CCZB		Tie Rod End	S070032
	2011.05-2018.07	Front Axle Right	SUV 4WD CCZB		Tie Rod End	S070033
	2011.05-2018.07	Front Axle Left & Right	SUV 4WD CCZB		Rod/Strut,stabiliser	S050040
	2011.05-2018.07	Rear Axle Left & Right	SUV 4WD CCZB		Rod/Strut,stabiliser	S050035
	2011.05-2018.07	Front Axle	SUV 4WD CCZB		Stabiliser Bushing	535187K
	2011.05-2018.07	Rear Axle	SUV 4WD CCZB	Stabiliser Ø:20,7 mm	Stabiliser Bushing	516447
	2011.05-2018.07	Rear Axle	SUV 4WD CCZB		Stabiliser Bushing	530183
Tiguan Allspace						
1.4 (110 kw)	2017.07-	Front Axle Left Lower	SUV FWD CWLA		Track Control Arm	S062790
	2017.07-	Front Axle Right Lower	SUV FWD CWLA		Track Control Arm	S062789
	2017.07-	Rear Axle Left & Right Lower Inner	SUV FWD CWLA		Track Control Arm	S062791
	2017.07-	Rear Axle Left & Right Lower Outer	SUV FWD CWLA		Track Control Arm	S062900
	2017.07-	Front Axle Left Lower	SUV FWD CWLA		Ball Joint	S080258
	2017.07-	Front Axle Right Lower	SUV FWD CWLA		Ball Joint	S080259
	2017.07-	Front Axle Left & Right Lower	SUV FWD CWLA		Control Arm Bushing	510361
	2017.07-	Front Axle Left & Right Lower	SUV FWD CWLA		Control Arm Bushing	531431
	2017.07-	Rear Axle Left & Right Centre	SUV FWD CWLA		Control Arm Bushing	512203
	2017.07-	Rear Axle Left & Right Upper	SUV FWD CWLA		Control Arm Bushing	516372
	2017.07-	Rear Axle Left & Right Upper	SUV FWD CWLA		Control Arm Bushing	516408
	2017.07-	Front Axle Left & Right	SUV FWD CWLA		Tie Rod Axle Joint	S030928
	2017.07-	Front Axle Left	SUV FWD CWLA		Tie Rod End	S070032
	2017.07-	Front Axle Right	SUV FWD CWLA		Tie Rod End	S070033
	2017.07-	Front Axle Left & Right	SUV FWD CWLA		Rod/Strut,stabiliser	S050040
	2017.07-	Rear Axle Left & Right	SUV FWD CWLA		Rod/Strut,stabiliser	S051234

 YEAR	FITTING POSITION	BODY STYLE & DRIVE TYPE & ENGINE	REMARKS	PRODUCT	GSP Ref.
VW					
Tiguan Allspace					
2.0 (162 kw)					
2017.06-	Front Axle Left Lower	SUV 4WD CXDA/DNJA		Track Control Arm	S062790
2017.06-	Front Axle Right Lower	SUV 4WD CXDA/DNJA		Track Control Arm	S062789
2017.06-	Rear Axle Left & Right Lower Inner	SUV 4WD CXDA/DNJA		Track Control Arm	S062791
2017.06-	Rear Axle Left & Right Lower Outer	SUV 4WD CXDA/DNJA		Track Control Arm	S062900
2017.06-	Front Axle Left Lower	SUV 4WD CXDA/DNJA		Ball Joint	S080258
2017.06-	Front Axle Right Lower	SUV 4WD CXDA/DNJA		Ball Joint	S080259
2017.06-	Front Axle Left & Right Lower	SUV 4WD CXDA/DNJA		Control Arm Bushing	510361
2017.06-	Front Axle Left & Right Lower	SUV 4WD CXDA/DNJA		Control Arm Bushing	531431
2017.06-	Rear Axle Left & Right Centre	SUV 4WD CXDA/DNJA		Control Arm Bushing	512203
2017.06-	Rear Axle Left & Right Upper	SUV 4WD CXDA/DNJA		Control Arm Bushing	516372
2017.06-	Rear Axle Left & Right Upper	SUV 4WD CXDA/DNJA		Control Arm Bushing	516408
2017.06-	Front Axle Left & Right	SUV 4WD CXDA/DNJA		Tie Rod Axle Joint	S030928
2017.06-	Front Axle Left	SUV 4WD CXDA/DNJA		Tie Rod End	S070032
2017.06-	Front Axle Right	SUV 4WD CXDA/DNJA		Tie Rod End	S070033
2017.06-	Front Axle Left & Right	SUV 4WD CXDA/DNJA		Rod/Strut, stabiliser	S050040
2017.06-	Rear Axle Left & Right	SUV 4WD CXDA/DNJA		Rod/Strut, stabiliser	S051234
Touareg					
3.2 (162 kw)					
2002.11-2006.11	Front Axle Left Lower	SUV 4WD AZZ/BKJ/BMV/BMX/BRJ		Track Control Arm	S060347
2002.11-2006.11	Front Axle Right Lower	SUV 4WD AZZ/BKJ/BMV/BMX/BRJ		Track Control Arm	S060348
2002.11-2006.11	Front Axle Left & Right Upper	SUV 4WD AZZ/BKJ/BMV/BMX/BRJ		Track Control Arm	S060349
2002.11-2006.11	Rear Axle Left Lower Inner	SUV 4WD AZZ/BKJ/BMV/BMX/BRJ		Track Control Arm	S062095
2002.11-2006.11	Rear Axle Left Upper Outer	SUV 4WD AZZ/BKJ/BMV/BMX/BRJ		Track Control Arm	S060045
2002.11-2006.11	Rear Axle Right Lower Inner	SUV 4WD AZZ/BKJ/BMV/BMX/BRJ		Track Control Arm	S062784
2002.11-2006.11	Rear Axle Right Upper Outer	SUV 4WD AZZ/BKJ/BMV/BMX/BRJ		Track Control Arm	S060024
2002.11-2006.11	Rear Axle Left & Right Upper Inner	SUV 4WD AZZ/BKJ/BMV/BMX/BRJ		Track Control Arm	S060808
2002.11-2006.11	Rear Axle Left & Right Lower Outer	SUV 4WD AZZ/BKJ/BMV/BMX/BRJ		Track Control Arm	510395
2002.11-2006.11	Front Axle Left & Right Lower	SUV 4WD AZZ/BKJ/BMV/BMX/BRJ		Control Arm Bushing	511490
2002.11-2006.11	Front Axle Left & Right Lower	SUV 4WD AZZ/BKJ/BMV/BMX/BRJ		Control Arm Bushing	516054
2002.11-2006.11	Front Axle Left & Right Upper	SUV 4WD AZZ/BKJ/BMV/BMX/BRJ		Control Arm Bushing	510362
2002.11-2006.11	Rear Axle Left & Right Lower Inner	SUV 4WD AZZ/BKJ/BMV/BMX/BRJ	for vehicles without ABS.Date from-to:2003-2005	Control Arm Bushing	516063
2002.11-2006.11	Rear Axle Left & Right Upper Inner	SUV 4WD AZZ/BKJ/BMV/BMX/BRJ	for vehicles without ABS.Date from-to:2003-2005	Control Arm Bushing	516109
2002.11-2006.11	Rear Axle Left & Right Upper Inner	SUV 4WD AZZ/BKJ/BMV/BMX/BRJ		Control Arm Bushing	516120
2002.11-2006.11	Rear Axle Left & Right Outer	SUV 4WD AZZ/BKJ/BMV/BMX/BRJ		Control Arm Bushing	516121
2002.11-2006.11	Front Axle,Rear Axle Left & Right Lower	SUV 4WD AZZ/BKJ/BMV/BMX/BRJ		Control Arm Bushing	516090
2002.11-2006.11	Front Axle Left	SUV 4WD AZZ/BKJ/BMV/BMX/BRJ		Rod Assembly	S100263
2002.11-2006.11	Front Axle Right	SUV 4WD AZZ/BKJ/BMV/BMX/BRJ		Rod Assembly	S100264
2002.11-2006.11	Front Axle Left & Right	SUV 4WD AZZ/BKJ/BMV/BMX/BRJ		Tie Rod Axle Joint	S030010
2002.11-2006.11	Front Axle Left	SUV 4WD AZZ/BKJ/BMV/BMX/BRJ		Tie Rod End	S070036
2002.11-2006.11	Front Axle Right	SUV 4WD AZZ/BKJ/BMV/BMX/BRJ		Tie Rod End	S070037
2002.11-2006.11	Front Axle Left & Right	SUV 4WD AZZ/BKJ/BMV/BMX/BRJ		Rod/Strut, stabiliser	S050047
2002.11-2006.11	Rear Axle Left	SUV 4WD AZZ/BKJ/BMV/BMX/BRJ		Rod/Strut, stabiliser	S050049
2002.11-2006.11	Rear Axle Right	SUV 4WD AZZ/BKJ/BMV/BMX/BRJ		Rod/Strut, stabiliser	S050050
2002.11-2006.11	Front Axle	SUV 4WD AZZ/BKJ/BMV/BMX/BRJ		Stabiliser Bushing	530227
2002.11-2006.11	Rear Axle	SUV 4WD AZZ/BKJ/BMV/BMX/BRJ		Stabiliser Bushing	518122
2002.11-2006.11	Front Axle	SUV 4WD AZZ/BKJ/BMV/BMX/BRJ		Steering Boot	540440
2002.11-2006.11	Front Axle	SUV 4WD AZZ/BKJ/BMV/BMX/BRJ		Stabiliser Bushing Kit	530227S
3.6 (206 kw)					
2005.10-2010.12	Front Axle Left Lower	SUV 4WD BHK		Track Control Arm	S060347
2005.10-2010.12	Front Axle Right Lower	SUV 4WD BHK		Track Control Arm	S060348
2005.10-2010.12	Front Axle Left & Right Upper	SUV 4WD BHK		Track Control Arm	S060349
2005.10-2010.12	Rear Axle Left Lower Inner	SUV 4WD BHK		Track Control Arm	S062095
2005.10-2010.12	Rear Axle Left Upper Outer	SUV 4WD BHK		Track Control Arm	S060045
2005.10-2010.12	Rear Axle Right Lower Inner	SUV 4WD BHK		Track Control Arm	S062784
2005.10-2010.12	Rear Axle Right Upper Outer	SUV 4WD BHK		Track Control Arm	S060024
2005.10-2010.12	Rear Axle Left & Right Upper Inner	SUV 4WD BHK		Track Control Arm	S060808
2005.10-2010.12	Rear Axle Left & Right Lower Outer	SUV 4WD BHK		Track Control Arm	510395
2005.10-2010.12	Front Axle Left & Right Lower	SUV 4WD BHK		Control Arm Bushing	511490
2005.10-2010.12	Front Axle Left & Right Lower	SUV 4WD BHK		Control Arm Bushing	516054
2005.10-2010.12	Front Axle Left & Right Lower	SUV 4WD BHK		Control Arm Bushing	517469
2005.10-2010.12	Front Axle Left & Right Upper	SUV 4WD BHK		Control Arm Bushing	510362
2005.10-2010.12	Rear Axle Left & Right Lower Inner	SUV 4WD BHK	for vehicles without ABS.Date from:2005	Control Arm Bushing	516063
2005.10-2010.12	Rear Axle Left & Right Upper Inner	SUV 4WD BHK	for vehicles without ABS.Date from:2006	Control Arm Bushing	516109
2005.10-2010.12	Rear Axle Left & Right Upper Inner	SUV 4WD BHK		Control Arm Bushing	516120
2005.10-2010.12	Rear Axle Left & Right Outer	SUV 4WD BHK		Control Arm Bushing	516121
2005.10-2010.12	Front Axle,Rear Axle Left & Right Lower	SUV 4WD BHK		Control Arm Bushing	516090

	 YEAR	FITTING POSITION	BODY STYLE & DRIVE TYPE & ENGINE	REMARKS	PRODUCT	GSP Ref.
VW						
Touareg						
3.6 (206 kw)	2005.10-2010.12	Front Axle Left	SUV 4WD BHK		Rod Assembly	S100263
	2005.10-2010.12	Front Axle Right	SUV 4WD BHK		Rod Assembly	S100264
	2005.10-2010.12	Front Axle Left & Right	SUV 4WD BHK		Tie Rod Axle Joint	S030010
	2005.10-2010.12	Front Axle Left	SUV 4WD BHK		Tie Rod End	S070036
	2005.10-2010.12	Front Axle Right	SUV 4WD BHK		Tie Rod End	S070037
	2005.10-2010.12	Front Axle Left & Right	SUV 4WD BHK		Rod/Strut,stabiliser	S050047
	2005.10-2010.12	Rear Axle Left	SUV 4WD BHK		Rod/Strut,stabiliser	S050049
	2005.10-2010.12	Rear Axle Right	SUV 4WD BHK		Rod/Strut,stabiliser	S050050
	2005.10-2010.12	Front Axle	SUV 4WD BHK		Stabiliser Bushing	530227
	2005.10-2010.12	Front Axle	SUV 4WD BHK		Stabiliser Bushing	530532
	2005.10-2010.12	Rear Axle	SUV 4WD BHK		Stabiliser Bushing	518122
	2005.10-2010.12	Front Axle	SUV 4WD BHK		Steering Boot	540440
	2005.10-2010.12	Front Axle	SUV 4WD BHK		Stabiliser Bushing Kit	530227S
	2010.04-2018.03	Front Axle Left Lower	SUV 4WD CGRA		Track Control Arm	S060043
	2010.04-2018.03	Front Axle Right Lower	SUV 4WD CGRA		Track Control Arm	S060044
	2010.04-2018.03	Rear Axle Left Upper Outer	SUV 4WD CGRA		Track Control Arm	S060045
	2010.04-2018.03	Rear Axle Right Upper Outer	SUV 4WD CGRA		Track Control Arm	S060024
	2010.04-2018.03	Rear Axle Left & Right Upper Inner	SUV 4WD CGRA		Track Control Arm	S060808
	2010.04-2018.03	Front Axle Left & Right Lower	SUV 4WD CGRA		Control Arm Bushing	516054
	2010.04-2018.03	Front Axle Left & Right Lower	SUV 4WD CGRA		Control Arm Bushing	517469
	2010.04-2018.03	Front Axle Left & Right Upper	SUV 4WD CGRA		Control Arm Bushing	533398
	2010.04-2018.03	Rear Axle Left & Right Lower Inner	SUV 4WD CGRA	Date from:2011	Control Arm Bushing	516063
	2010.04-2018.03	Rear Axle Left & Right Upper Inner	SUV 4WD CGRA	Date from:2011	Control Arm Bushing	516109
	2010.04-2018.03	Rear Axle Left & Right Upper Inner	SUV 4WD CGRA		Control Arm Bushing	516120
	2010.04-2018.03	Rear Axle Left & Right Outer	SUV 4WD CGRA		Control Arm Bushing	516121
	2010.04-2018.03	Front Axle;Rear Axle Left & Right Lower	SUV 4WD CGRA		Control Arm Bushing	516090
	2010.04-2018.03	Front Axle Left	SUV 4WD CGRA		Rod Assembly	S100263
	2010.04-2018.03	Front Axle Right	SUV 4WD CGRA		Rod Assembly	S100264
	2010.04-2018.03	Front Axle Left & Right	SUV 4WD CGRA		Tie Rod Axle Joint	S030010
	2010.04-2018.03	Front Axle Left	SUV 4WD CGRA		Tie Rod End	S070036
	2010.04-2018.03	Front Axle Right	SUV 4WD CGRA		Tie Rod End	S070037
	2010.04-2018.03	Front Axle Left & Right	SUV 4WD CGRA		Rod/Strut,stabiliser	S050047
	2010.04-2018.03	Rear Axle Left	SUV 4WD CGRA		Rod/Strut,stabiliser	S050049
	2010.04-2018.03	Rear Axle Right	SUV 4WD CGRA		Rod/Strut,stabiliser	S050050
	2010.04-2018.03	Front Axle	SUV 4WD CGRA		Stabiliser Bushing	530532
	2010.04-2018.03	Front Axle	SUV 4WD CGRA		Steering Boot	540440
4.2 (228 kw)	2002.12-2006.11	Front Axle Left Lower	SUV 4WD AXQ		Track Control Arm	S060347
	2002.12-2006.11	Front Axle Right Lower	SUV 4WD AXQ		Track Control Arm	S060348
	2002.12-2006.11	Front Axle Left & Right Upper	SUV 4WD AXQ		Track Control Arm	S060349
	2002.12-2006.11	Rear Axle Left Lower Inner	SUV 4WD AXQ		Track Control Arm	S062095
	2002.12-2006.11	Rear Axle Left Upper Outer	SUV 4WD AXQ		Track Control Arm	S060045
	2002.12-2006.11	Rear Axle Right Lower Inner	SUV 4WD AXQ		Track Control Arm	S062784
	2002.12-2006.11	Rear Axle Right Upper Outer	SUV 4WD AXQ		Track Control Arm	S060024
	2002.12-2006.11	Rear Axle Left & Right Upper Inner	SUV 4WD AXQ		Track Control Arm	S060808
	2002.12-2006.11	Rear Axle Left & Right Lower Outer	SUV 4WD AXQ		Track Control Arm	510395
	2002.12-2006.11	Front Axle Left & Right Lower	SUV 4WD AXQ		Control Arm Bushing	511490
	2002.12-2006.11	Front Axle Left & Right Lower	SUV 4WD AXQ		Control Arm Bushing	516054
	2002.12-2006.11	Front Axle Left & Right Upper	SUV 4WD AXQ		Control Arm Bushing	510362
	2002.12-2006.11	Rear Axle Left & Right Lower Inner	SUV 4WD AXQ	for vehicles without ABS.Date from-to:2003-2005	Control Arm Bushing	516063
	2002.12-2006.11	Rear Axle Left & Right Upper Inner	SUV 4WD AXQ	for vehicles without ABS.Date from-to:2003-2005	Control Arm Bushing	516109
	2002.12-2006.11	Rear Axle Left & Right Upper Inner	SUV 4WD AXQ		Control Arm Bushing	516120
	2002.12-2006.11	Rear Axle Left & Right Outer	SUV 4WD AXQ		Control Arm Bushing	516121
	2002.12-2006.11	Front Axle;Rear Axle Left & Right Lower	SUV 4WD AXQ		Control Arm Bushing	516090
	2002.12-2006.11	Front Axle Left	SUV 4WD AXQ		Rod Assembly	S100263
	2002.12-2006.11	Front Axle Right	SUV 4WD AXQ		Rod Assembly	S100264
	2002.12-2006.11	Front Axle Left & Right	SUV 4WD AXQ		Tie Rod Axle Joint	S030010
	2002.12-2006.11	Front Axle Left	SUV 4WD AXQ		Tie Rod End	S070036
	2002.12-2006.11	Front Axle Right	SUV 4WD AXQ		Tie Rod End	S070037
	2002.12-2006.11	Front Axle Left & Right	SUV 4WD AXQ		Rod/Strut,stabiliser	S050047
	2002.12-2006.11	Rear Axle Left	SUV 4WD AXQ		Rod/Strut,stabiliser	S050049
	2002.12-2006.11	Rear Axle Right	SUV 4WD AXQ		Rod/Strut,stabiliser	S050050
	2002.12-2006.11	Front Axle	SUV 4WD AXQ		Stabiliser Bushing	530227
	2002.12-2006.11	Rear Axle	SUV 4WD AXQ		Stabiliser Bushing	518122
	2002.12-2006.11	Front Axle	SUV 4WD AXQ		Steering Boot	540440





	 YEAR	FITTING POSITION	BODY STYLE & DRIVE TYPE & ENGINE	REMARKS	PRODUCT	GSP Ref.	
VW							
Touareg							
4.2 (228 kw)	2002.12-2006.11	Front Axle	SUV 4WD AXQ		Stabiliser Bushing Kit	530227S	
4.2 (257 kw)	2006.06-2010.05	Front Axle Left Lower	SUV 4WD BAR		Track Control Arm	S060347	
	2006.06-2010.05	Front Axle Right Lower	SUV 4WD BAR		Track Control Arm	S060348	
	2006.06-2010.05	Front Axle Left & Right Upper	SUV 4WD BAR		Track Control Arm	S060349	
	2006.06-2010.05	Rear Axle Left Lower Inner	SUV 4WD BAR		Track Control Arm	S062095	
	2006.06-2010.05	Rear Axle Left Upper Outer	SUV 4WD BAR		Track Control Arm	S060045	
	2006.06-2010.05	Rear Axle Right Lower Inner	SUV 4WD BAR		Track Control Arm	S062784	
	2006.06-2010.05	Rear Axle Right Upper Outer	SUV 4WD BAR		Track Control Arm	S060024	
	2006.06-2010.05	Rear Axle Left & Right Upper Inner	SUV 4WD BAR		Track Control Arm	S060808	
	2006.06-2010.05	Rear Axle Left & Right Lower Outer	SUV 4WD BAR		Track Control Arm	510395	
	2006.06-2010.05	Front Axle Left & Right Lower	SUV 4WD BAR		Control Arm Bushing	511490	
	2006.06-2010.05	Front Axle Left & Right Lower	SUV 4WD BAR		Control Arm Bushing	516054	
	2006.06-2010.05	Front Axle Left & Right Lower	SUV 4WD BAR		Control Arm Bushing	517469	
	2006.06-2010.05	Front Axle Left & Right Upper	SUV 4WD BAR		Control Arm Bushing	510362	
	2006.06-2010.05	Rear Axle Left & Right Lower Inner	SUV 4WD BAR	for vehicles without ABS	Control Arm Bushing	516063	
	2006.06-2010.05	Rear Axle Left & Right Upper Inner	SUV 4WD BAR	for vehicles without ABS	Control Arm Bushing	516109	
	2006.06-2010.05	Rear Axle Left & Right Upper Inner	SUV 4WD BAR		Control Arm Bushing	516120	
	2006.06-2010.05	Rear Axle Left & Right Outer	SUV 4WD BAR		Control Arm Bushing	516121	
	2006.06-2010.05	Front Axle;Rear Axle Left & Right Lower	SUV 4WD BAR		Control Arm Bushing	516090	
	2006.06-2010.05	Front Axle Left	SUV 4WD BAR		Rod Assembly	S100263	
	2006.06-2010.05	Front Axle Right	SUV 4WD BAR		Rod Assembly	S100264	
	2006.06-2010.05	Front Axle Left & Right	SUV 4WD BAR		Tie Rod Axle Joint	S030010	
	2006.06-2010.05	Front Axle Left	SUV 4WD BAR		Tie Rod End	S070036	
	2006.06-2010.05	Front Axle Right	SUV 4WD BAR		Tie Rod End	S070037	
	2006.06-2010.05	Front Axle Left & Right	SUV 4WD BAR		Rod/Strut,stabiliser	S050047	
	2006.06-2010.05	Rear Axle Left	SUV 4WD BAR		Rod/Strut,stabiliser	S050049	
	2006.06-2010.05	Rear Axle Right	SUV 4WD BAR		Rod/Strut,stabiliser	S050050	
	2006.06-2010.05	Front Axle	SUV 4WD BAR		Stabiliser Bushing	530227	
	2006.06-2010.05	Front Axle	SUV 4WD BAR		Stabiliser Bushing	530532	
	2006.06-2010.05	Rear Axle	SUV 4WD BAR		Stabiliser Bushing	518122	
	2006.06-2010.05	Front Axle	SUV 4WD BAR		Steering Boot	540440	
	4.2 (265 kw)	2011.01-2018.03	Front Axle Left Lower	SUV 4WD CGNA		Track Control Arm	S060043
		2011.01-2018.03	Front Axle Right Lower	SUV 4WD CGNA		Track Control Arm	S060044
2011.01-2018.03		Rear Axle Left Lower Inner	SUV 4WD CGNA		Track Control Arm	S062095	
2011.01-2018.03		Rear Axle Left Upper Outer	SUV 4WD CGNA		Track Control Arm	S060045	
2011.01-2018.03		Rear Axle Right Upper Outer	SUV 4WD CGNA		Track Control Arm	S060024	
2011.01-2018.03		Rear Axle Left & Right Upper Inner	SUV 4WD CGNA		Track Control Arm	S060808	
2011.01-2018.03		Front Axle Left & Right Lower	SUV 4WD CGNA		Control Arm Bushing	516054	
2011.01-2018.03		Front Axle Left & Right Lower	SUV 4WD CGNA		Control Arm Bushing	517469	
2011.01-2018.03		Front Axle Left & Right Upper	SUV 4WD CGNA		Control Arm Bushing	533398	
2011.01-2018.03		Rear Axle Left & Right Lower Inner	SUV 4WD CGNA		Control Arm Bushing	516063	
2011.01-2018.03		Rear Axle Left & Right Upper Inner	SUV 4WD CGNA		Control Arm Bushing	516109	
2011.01-2018.03		Rear Axle Left & Right Upper Inner	SUV 4WD CGNA		Control Arm Bushing	516120	
2011.01-2018.03		Rear Axle Left & Right Outer	SUV 4WD CGNA		Control Arm Bushing	516121	
2011.01-2018.03		Front Axle;Rear Axle Left & Right Lower	SUV 4WD CGNA		Control Arm Bushing	516090	
2011.01-2018.03		Front Axle Left	SUV 4WD CGNA		Rod Assembly	S100263	
2011.01-2018.03		Front Axle Right	SUV 4WD CGNA		Rod Assembly	S100264	
2011.01-2018.03		Front Axle Left & Right	SUV 4WD CGNA		Tie Rod Axle Joint	S030010	
2011.01-2018.03		Front Axle Left	SUV 4WD CGNA		Tie Rod End	S070036	
2011.01-2018.03		Front Axle Right	SUV 4WD CGNA		Tie Rod End	S070037	
2011.01-2018.03		Front Axle Left & Right	SUV 4WD CGNA		Rod/Strut,stabiliser	S050047	
2011.01-2018.03		Rear Axle Left	SUV 4WD CGNA		Rod/Strut,stabiliser	S050049	
2011.01-2018.03		Rear Axle Right	SUV 4WD CGNA		Rod/Strut,stabiliser	S050050	
2011.01-2018.03		Front Axle	SUV 4WD CGNA		Stabiliser Bushing	530532	
2011.01-2018.03		Front Axle	SUV 4WD CGNA		Steering Boot	540440	
Transporter							
1.9 (77 kw)		2003.04-2009.11	Front Axle Left Lower	VAN FWD AXB		Track Control Arm	S060760
		2003.04-2009.11	Front Axle Right Lower	VAN FWD AXB		Track Control Arm	S060761
		2003.04-2009.11	Front Axle Left & Right Lower	VAN FWD AXB	Check no. 3: 714-020-020; Check no. 4: 714-020-021; For PR no. 191	Ball Joint	S080249
		2003.04-2009.11	Front Axle Left & Right Lower	VAN FWD AXB	Check no. 3: 714-020-020; Check no. 4: 714-020-021; For PR no. 191	Ball Joint	S080260
		2003.04-2009.11	Front Axle Left & Right Lower	VAN FWD AXB		Control Arm Bushing	510358
		2003.04-2009.11	Front Axle Left & Right Lower	VAN FWD AXB		Control Arm Bushing	510359
		2003.04-2009.11	Front Axle Left & Right Lower	VAN FWD AXB		Control Arm Bushing	530226
	2003.04-2009.11	Rear Axle Left & Right	VAN FWD AXB		Control Arm Bushing	516383	



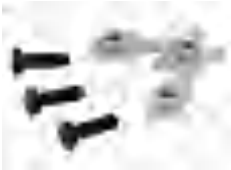

	 YEAR	FITTING POSITION	BODY STYLE & DRIVE TYPE & ENGINE	REMARKS	PRODUCT	GSP Ref.
VW						
Transporter						
1.9 (77 kw)	2003.04-2009.11	Rear Axle Left & Right	VAN FWD AXB		Control Arm Bushing	516409
	2003.04-2009.11	Front Axle Left	VAN FWD AXB		Rod Assembly	S100299
	2003.04-2009.11	Front Axle Right	VAN FWD AXB		Rod Assembly	S100298
	2003.04-2009.11	Front Axle Left & Right	VAN FWD AXB		Tie Rod Axle Joint	S030840
	2003.04-2009.11	Front Axle Left	VAN FWD AXB		Tie Rod End	S070500
	2003.04-2009.11	Front Axle Right	VAN FWD AXB		Tie Rod End	S070501
	2003.04-2009.11	Front Axle Left & Right	VAN FWD AXB		Rod/Strut,stabiliser	S050449
	2003.04-2009.11	Front Axle	VAN FWD AXB		Stabiliser Bushing	517171
	2003.04-2009.11	Front Axle	VAN FWD AXB		Stabiliser Bushing	518051
	2003.04-2009.11	Front Axle	VAN FWD AXB		Stabiliser Bushing	535155
	2003.04-2009.11	Rear Axle Left & Right Inner	VAN FWD AXB		Stabiliser Bushing	535170
	2003.04-2009.11	Rear Axle Left & Right Inner	VAN FWD AXB		Stabiliser Bushing	535437
	2003.04-2009.11	Rear Axle Left & Right Outer	VAN FWD AXB		Stabiliser Bushing	535150
	2003.04-2009.11	Rear Axle Left & Right Outer	VAN FWD AXB		Stabiliser Bushing	535315
	2003.04-2009.11	Front Axle	VAN FWD AXB		Steering Boot	540208
	2003.04-2009.11	Front Axle	VAN FWD AXB		Steering Rack Bellow Kit	540208S
2.4 (55 kw)	1997.04-2003.06	Front Axle Left Lower	Bus FWD AJA		Track Control Arm	S061409
	1997.04-2003.06	Front Axle Right Lower	Bus FWD AJA		Track Control Arm	S061410
	1997.04-2003.06	Front Axle Left & Right Lower	Bus FWD AJA		Ball Joint	S080245
	1997.04-2003.06	Front Axle Left & Right Upper	Bus FWD AJA		Ball Joint	S080262
	1997.04-2003.06	Front Axle Left & Right Lower	Bus FWD AJA		Control Arm Bushing	510158
	1997.04-2003.06	Front Axle Left & Right Lower	Bus FWD AJA		Control Arm Bushing	510159
	1997.04-2003.06	Front Axle Left & Right Lower	Bus FWD AJA		Control Arm Bushing	510255
	1997.04-2003.06	Front Axle Left & Right Upper	Bus FWD AJA		Control Arm Bushing	510155
	1997.04-2003.06	Front Axle Left & Right Upper	Bus FWD AJA		Control Arm Bushing	510156
	1997.04-2003.06	Rear Axle Left & Right Lower	Bus FWD AJA		Control Arm Bushing	530212
	1997.04-2003.06	Front Axle Left	Bus FWD AJA		Tie Rod End	S070493
	1997.04-2003.06	Front Axle Right	Bus FWD AJA		Tie Rod End	S071631
	1997.04-2003.06	Front Axle Left & Right	Bus FWD AJA		Rod/Strut,stabiliser	520525
	1997.04-2003.06	Front Axle Left & Right	Bus FWD AJA		Rod/Strut,stabiliser	S050447
	1997.04-2003.06	Front Axle	Bus FWD AJA		Stabiliser Bushing	510160
	1997.04-2003.06	Front Axle	Bus FWD AJA	for vehicles without heavy duty suspension	Stabiliser Bushing	510286
	1997.04-2003.06	Front Axle	Bus FWD AJA		Stabiliser Bushing	517812
	1997.04-2003.06	Front Axle	Bus FWD AJA		Stabiliser Bushing	530221
	1997.04-2003.06	Front Axle Left & Right	Bus FWD AJA		Steering Bushing	510320
2.4 (57 kw)	1990.09-1998.04	Front Axle Left Lower	VAN FWD AAB	Chassis no.from:70T200000	Track Control Arm	S061409
	1990.09-1998.04	Front Axle Left Lower	VAN FWD AAB	VIN from:70-M-083 343,70-S-002-791	Track Control Arm	S063176
	1990.09-1998.04	Front Axle Right Lower	VAN FWD AAB	Chassis no.from:70T200000	Track Control Arm	S061410
	1990.09-1998.04	Front Axle Right Lower	VAN FWD AAB	VIN from:70-M-083 343,70-S-002-791	Track Control Arm	S063175
	1990.09-1998.04	Front Axle Left & Right Lower	VAN FWD AAB	Chassis no.from:70-T-200 000	Ball Joint	S080245
	1990.09-1998.04	Front Axle Left & Right Lower	VAN FWD AAB	Engine code:AAB,Chassis no.to:70-T-199 999,Engine code:AAB	Ball Joint	S080358
	1990.09-1998.04	Front Axle Left & Right Upper	VAN FWD AAB		Ball Joint	S080262
	1990.09-1998.04	Front Axle Left & Right Lower	VAN FWD AAB		Control Arm Bushing	510157
	1990.09-1998.04	Front Axle Left & Right Lower	VAN FWD AAB		Control Arm Bushing	510158
	1990.09-1998.04	Front Axle Left & Right Lower	VAN FWD AAB		Control Arm Bushing	510159
	1990.09-1998.04	Front Axle Left & Right Lower	VAN FWD AAB		Control Arm Bushing	510255
	1990.09-1998.04	Front Axle Left & Right Upper	VAN FWD AAB		Control Arm Bushing	510155
	1990.09-1998.04	Front Axle Left & Right Upper	VAN FWD AAB		Control Arm Bushing	510156
	1990.09-1998.04	Rear Axle Left & Right Lower	VAN FWD AAB		Control Arm Bushing	530212
	1990.09-1998.04	Front Axle Left	VAN FWD AAB	Chassis no.from:70-S-002 792,70-T-199 999,for vehicles with power steering,For PR no.:1ND	Rod Assembly	S100154
	1990.09-1998.04	Front Axle Left	VAN FWD AAB	Chassis no.to:70-M-096 448,for vehicles with power steering,For PR no.:1ND	Rod Assembly	S100161
	1990.09-1998.04	Front Axle Right	VAN FWD AAB	Chassis no.to:70-M-096 448,for vehicles with power steering,For PR no.:1ND	Rod Assembly	S100152
	1990.09-1998.04	Front Axle Right	VAN FWD AAB	Chassis no.from:70-S-002 792,70-T-199 999,for vehicles with power steering,For PR no.:1ND	Rod Assembly	S100153
	1990.09-1998.04	Front Axle Left & Right	VAN FWD AAB		Tie Rod Axle Joint	S030314
	1990.09-1998.04	Front Axle Left & Right	VAN FWD AAB	for vehicles without power steering,For PR no.:1ND	Tie Rod Axle Joint	S030431
	1990.09-1998.04	Front Axle Left	VAN FWD AAB	Engine code:AAB,Chassis no.from:70-S-002 792	Tie Rod End	S070493
	1990.09-1998.04	Front Axle Left	VAN FWD AAB	Chassis no.to:70-M-096 448	Tie Rod End	S070508
	1990.09-1998.04	Front Axle Left	VAN FWD AAB	Chassis no.:70-M-096 449-70-S-002 791	Tie Rod End	S070509
	1990.09-1998.04	Front Axle Right	VAN FWD AAB	Engine code:AAB,Chassis no.from:70-S-002 792	Tie Rod End	S070507
	1990.09-1998.04	Front Axle Right	VAN FWD AAB	Chassis no.:70-M-096 449-70-S-002 791	Tie Rod End	S070511
	1990.09-1998.04	Front Axle Right	VAN FWD AAB	Engine code:AAB,Chassis no.from:70-S-002 792,70-T-199 999,for vehicles with power steering,For PR no.:1ND	Tie Rod End	S071631
	1990.09-1998.04	Front Axle Left & Right	VAN FWD AAB		Rod/Strut,stabiliser	520525
	1990.09-1998.04	Front Axle Left & Right	VAN FWD AAB		Rod/Strut,stabiliser	S050447
	1990.09-1998.04	Front Axle	VAN FWD AAB		Stabiliser Bushing	510160

	 YEAR	FITTING POSITION	BODY STYLE & DRIVE TYPE & ENGINE	REMARKS	PRODUCT	GSP Ref.
VW						
Transporter						
2.4 (57 kw)	1990.09-1998.04	Front Axle	VAN FWD AAB		Stabiliser Bushing	510233
	1990.09-1998.04	Front Axle	VAN FWD AAB	For PR code:0AB	Stabiliser Bushing	510286
	1990.09-1998.04	Front Axle	VAN FWD AAB		Stabiliser Bushing	517812
	1990.09-1998.04	Front Axle	VAN FWD AAB		Stabiliser Bushing	530221
UP!						
1.0 (77 kw)	2015.08-	Front Axle Left Lower	Hatchback FWD CYTA		Track Control Arm	S061482
	2015.08-	Front Axle Right Lower	Hatchback FWD CYTA		Track Control Arm	S061483
	2015.08-	Front Axle Left Lower	Hatchback FWD CYTA		Ball Joint	S080015
	2015.08-	Front Axle Right Lower	Hatchback FWD CYTA		Ball Joint	S080014
	2015.08-	Front Axle Left & Right Lower	Hatchback FWD CYTA		Control Arm Bushing	510065
	2015.08-	Front Axle Left & Right Lower	Hatchback FWD CYTA		Control Arm Bushing	510084
	2015.08-	Front Axle Left & Right	Hatchback FWD CYTA		Tie Rod Axle Joint	S030656
	2015.08-	Front Axle Left & Right	Hatchback FWD CYTA		Rod/Strut,stabiliser	S050038
2015.08-	Front Axle	Hatchback FWD CYTA		Stabiliser Bushing	517167	
Virtus						
1.0 (94 kw)	2018.01-	Front Axle Left & Right Lower	Saloon FWD DHSB		Control Arm Bushing	510084
	2018.01-	Front Axle Left & Right	Saloon FWD DHSB		Rod/Strut,stabiliser	S050038
1.6 (81 kw)	2017.10-	Front Axle Left & Right Lower	Saloon FWD CWSA		Control Arm Bushing	510084
	2017.10-	Front Axle Left & Right	Saloon FWD CWSA		Rod/Strut,stabiliser	S050038
1.6 (86 kw)	2018.09-	Front Axle Left & Right Lower	Saloon FWD CNXC		Control Arm Bushing	510084
	2018.09-	Front Axle Left & Right	Saloon FWD CNXC		Rod/Strut,stabiliser	S050038
Voyage						
1.0 (56 kw)	2008.07-	Front Axle Left & Right Lower	Saloon FWD CCNA/CPBA		Control Arm Bushing	510084

Cross References List And Photo

Photo.....

510023S		510024		510025		510028	
SEAT	191407175	SEAT	191407181A	SEAT	191407181D	AUDI	191411315AS
		SEAT	191407181B	SEAT	191407181E		
				SEAT	357407181		
							

510030		510031		510032		510065	
SEAT	191411315	SEAT	191411327	SEAT	191411329	AUDI	180407181
SEAT	191411315B			SEAT	6N0411329	AUDI	1J0407181
SEAT	191411315BS1					AUDI	1J0407181A
							

510066		510066S		510067		510067S	
AUDI	1J0411314G	AUDI	1J0411314T	AUDI	1J0411315C	AUDI	1J0411315
AUDI	1J0411314R	AUDI	1J0411314TS1	AUDI	1J0411315J	AUDI	1J0411315B
AUDI	1J0411314T			VW	1J0411315	AUDI	1J0411315C
							

Cross References List And Photo

Photo.....

510068		510068S		510084		510085	
SEAT	1J0411315H	AUDI	1J0411315H	AUDI	191407182	VW	357411309
SEAT	1J0411315K	AUDI	1J0411315K	AUDI	357407182	VW	357411313A
VW	1JD411315			AUDI	357407182F		
							





510087		510088		510089		510114	
AUDI	357411315B	AUDI	357411315CS	VW	357411329	AUDI	443511247C
VW	357411315A					AUDI	443511247D
VW	357411315D						
							

510126		510127		510128		510132	
AUDI	4A0407181	AUDI	4A0407183C	AUDI	4A0411327A	AUDI	4A0511247B
AUDI	4A0407181A	AUDI	4A0407183D				
AUDI	4A0407181AG	VW	R4A0407183C				
							

Cross References List And Photo

Photo.....

510133		510134		510135		510136	
AUDI	4D0407181F	AUDI	4D0407182E	AUDI	4D0407183M	AUDI	4B0407515
AUDI	4D0407181H	AUDI	4D0407182G	AUDI	4D0407183N	AUDI	4D0407515C
		AUDI	4Z7407182	AUDI	4D0407183P	AUDI	4E0407515C
							

510137		510138		510139		510151	
AUDI	4D0407516A	AUDI	4D0411327E	AUDI	4D0411327F	SEAT	6Q0407151E
AUDI	4D0407516C	AUDI	4D0411327G	AUDI	4D0411327H	SEAT	6Q0407151L
						SEAT	6Q0407182A
							

510155		510156		510157		510158	
VW	701407077	VW	701407087	AUDI	701407183	VW	701407140B
VW	701407077A			VW	701407151A	VW	701407140C
						VW	7D0407140
							

Cross References List And Photo

Photo.....

510159		510160		510164		510167	
AUDI	7D0407183C	VW	701411045	AUDI	321199313A	AUDI	823411313A
VW	701407183C	VW	7D0411045	AUDI	321199313B		
VW	7D0407183			AUDI	811411327A		
							





510169		510205		510217		510219	
AUDI	857407181	VW	357411309	AUDI	857407181	SEAT	1H0411309
AUDI	893407147E	VW	357411314A	AUDI	8A0407181	SEAT	1H0411314
AUDI	8A0407181					VW	191411309
							

510232		510233		510253		510255	
AUDI	1J0411314C	VW	701411041	AUDI	893407181	VW	701407140B
AUDI	1J0411314P					VW	701407140C
AUDI	1J0411314R					VW	7D0407140
							

Cross References List And Photo

Photo.....





510286		510287		510288		510299	
VW	701411329	AUDI	4D0407183AB	SKODA	6U0407182C	AUDI	4E0407181B
VW	7D0411049	AUDI	4D0407183AC			AUDI	4E0407181D
		AUDI	4D0407183P			AUDI	8K0407151B
							

510301		510312S		510313S		510316	
AUDI	4F0407183A	SEAT	191407181AS	SEAT	191407181DS	AUDI	1J0411327
AUDI	4F0407183B	SEAT	191407181BS	SEAT	191407181ES		
AUDI	4F0407183C	SEAT	191407181BS1	SEAT	191407181ES1		
							

510320		510332		510333		510334	
VW	701419081A	AUDI	1K0407183A	AUDI	1K0199231G	AUDI	1K0199232G
		AUDI	1K0407183E	AUDI	1K0199231GS1	AUDI	1K0199232GS1
		AUDI	1KD407183	AUDI	1K0199231J	AUDI	1K0199232J
							

Cross References List And Photo

Photo.....

510346		510349		510350		510351	
AUDI	1K0505323G	AUDI	1K0501529E	AUDI	1K0501530B	AUDI	1K0501529F
AUDI	1K0505323H	AUDI	1K0501529F	AUDI	1K0501530C	AUDI	1K0501529J
AUDI	1K0505323N			AUDI	1K0501530H	AUDI	1K0501541C
							





510352		510353		510354		510355	
AUDI	1K0501529F	AUDI	1K0199231K	AUDI	1K0199231H	AUDI	1K0199232H
AUDI	1K0501530C	AUDI	1K0199231KSK	AUDI	1K0199231K	AUDI	1K0199232K
AUDI	1K0505543A	AUDI	1K0407183G				
							

510356		510358		510359		510361	
SEAT	3C0199231A	VW	7H0407182A	VW	2H0407183A	AUDI	1K0407182
SEAT	3C0199231B			VW	7H0407151B	AUDI	1K0407182A
SEAT	3C0199231D			VW	7H0407183	AUDI	1K0407182F
							

Cross References List And Photo

Photo.....

510362		510393		510394		510395	
AUDI	7L0407077	AUDI	4F0501529C	AUDI	4F0501529C	AUDI	7L0501529C
PORSCHE	95534102700	AUDI	4F0501529E	AUDI	4F0501529E	AUDI	7L0501529D
PORSCHE	95534102701	AUDI	8E0501538F	AUDI	8E0501537M	AUDI	7L8501529A
							

510407		510426S		510427		510428	
AUDI	357411315DS	MERCEDES-BENZ	1243300275	MERCEDES-BENZ	1243334214	MERCEDES-BENZ	1243334314
		MERCEDES-BENZ	1243300575	MERCEDES-BENZ	A1243334214	MERCEDES-BENZ	A1243334314
		MERCEDES-BENZ	1243300675				
							

510430		510431		510444S		510445	
MERCEDES-BENZ	1243523465	MERCEDES-BENZ	1243500575	MERCEDES-BENZ	1403306007	MERCEDES-BENZ	1403330514
MERCEDES-BENZ	1243529065	MERCEDES-BENZ	1243523565	MERCEDES-BENZ	1403306307	MERCEDES-BENZ	1403331814
MERCEDES-BENZ	A1243523465	MERCEDES-BENZ	A1243500575	MERCEDES-BENZ	1403308207	MERCEDES-BENZ	140333181426
							

Cross References List And Photo

Photo.....

510446	510450	510456	510468
<p>MERCEDES-BENZ 1403522965 MERCEDES-BENZ 1403528065 MERCEDES-BENZ 1403528465</p> 	<p>MERCEDES-BENZ 2013335114 MERCEDES-BENZ A2013335114</p> 	<p>MERCEDES-BENZ 2023336214 MERCEDES-BENZ 2023337714 MERCEDES-BENZ 2103308707</p> 	<p>MERCEDES-BENZ 1703300075 MERCEDES-BENZ 2023336414 MERCEDES-BENZ 2023338414</p> 

510470S	510471	510472	510478
<p>MERCEDES-BENZ 2103300175 MERCEDES-BENZ 2103300475 MERCEDES-BENZ A2103300175</p> 	<p>MERCEDES-BENZ 2103335514 MERCEDES-BENZ A2103335514</p> 	<p>MERCEDES-BENZ 1403230985 MERCEDES-BENZ A1403230985</p> 	<p>MERCEDES-BENZ 2103202189 MERCEDES-BENZ 2103203689 MERCEDES-BENZ A2103202189</p> 

510479	510483S	510491	510493
<p>MERCEDES-BENZ 2103202289 MERCEDES-BENZ 2103203789 MERCEDES-BENZ A2103202289</p> 	<p>MERCEDES-BENZ 2023300075 MERCEDES-BENZ A2023300075</p> 	<p>MERCEDES-BENZ 2033330214 MERCEDES-BENZ 2033331014 MERCEDES-BENZ A2033331014</p> 	<p>MERCEDES-BENZ 2213500406 MERCEDES-BENZ 2213500606 MERCEDES-BENZ 2213521465</p> 

Cross References List And Photo

Photo.....

510495	510496	510497	510498
<p>MERCEDES-BENZ 1403524565 MERCEDES-BENZ 1403524865 MERCEDES-BENZ 2103520665</p> 	<p>MERCEDES-BENZ 2213522265 MERCEDES-BENZ A2213522265</p> 	<p>MERCEDES-BENZ 2213501153 MERCEDES-BENZ 2213501253 MERCEDES-BENZ 2213522165</p> 	<p>MERCEDES-BENZ 2203301711 MERCEDES-BENZ 2203301811 MERCEDES-BENZ 2203331814</p> 

510499	510500	510502	510505
<p>MERCEDES-BENZ 1403524765 MERCEDES-BENZ A1403524765</p> 	<p>MERCEDES-BENZ 1403524465 MERCEDES-BENZ A1403524465</p> 	<p>MERCEDES-BENZ 2213300307 MERCEDES-BENZ 2213300407 MERCEDES-BENZ 2213330214</p> 	<p>MERCEDES-BENZ 2213500206 MERCEDES-BENZ 2213501006 MERCEDES-BENZ 2213521265</p> 

510506	510507	510508	510509
<p>MERCEDES-BENZ 2213500206 MERCEDES-BENZ 2213501006 MERCEDES-BENZ 2213521165</p> 	<p>MERCEDES-BENZ 2203309307 MERCEDES-BENZ 2203309407 MERCEDES-BENZ 2303330314</p> 	<p>MERCEDES-BENZ 2213330814 MERCEDES-BENZ A2213330814</p> 	<p>MERCEDES-BENZ 1633300175 MERCEDES-BENZ 1633300175</p> 

Cross References List And Photo

Photo.....

510509S	510514	510515	510516
<p>MERCEDES-BENZ 1633300175 MERCEDES-BENZ A1633300175</p> 	<p>MERCEDES-BENZ 2113230285 MERCEDES-BENZ A2113230285</p> 	<p>MERCEDES-BENZ 2113201089 MERCEDES-BENZ 2113201089S1 MERCEDES-BENZ 2113203889</p> 	<p>MERCEDES-BENZ 2113200989 MERCEDES-BENZ 2113203989 MERCEDES-BENZ A2113203989</p> 

510517	510518	510520	510521
<p>MERCEDES-BENZ 2023300075 MERCEDES-BENZ 2023336714 MERCEDES-BENZ A2023336714</p> 	<p>MERCEDES-BENZ 2113331014 MERCEDES-BENZ 2113332514 MERCEDES-BENZ 2113332814</p> 	<p>MERCEDES-BENZ 1163330117 MERCEDES-BENZ 1163334014 MERCEDES-BENZ A1163334014</p> 	<p>MERCEDES-BENZ 2303503506 MERCEDES-BENZ 2303503506S1 MERCEDES-BENZ 2303521865</p> 





510522	510529	510557	510558S
<p>MERCEDES-BENZ 2303502706 MERCEDES-BENZ 2303502706S1 MERCEDES-BENZ 2303521465</p> 	<p>MERCEDES-BENZ 2053305501 MERCEDES-BENZ 2053305601 MERCEDES-BENZ 2113332214</p> 	<p>MERCEDES-BENZ 2203308607 MERCEDES-BENZ 2203333114 MERCEDES-BENZ 2303330114</p> 	<p>MERCEDES-BENZ 2203308607 MERCEDES-BENZ 2203308707 MERCEDES-BENZ 2203309107</p> 

Cross References List And Photo

Photo.....

510563	510564	510565	510595
MERCEDES-BENZ 1243333714 MERCEDES-BENZ A1243333714	MERCEDES-BENZ 2013335214 MERCEDES-BENZ A2013335214	MERCEDES-BENZ 2033330314 MERCEDES-BENZ 2033330914 MERCEDES-BENZ A2033330314	BMW 31121136605 BMW 31121136606 BMW 31121139456
			

510605	510608	510609	510609S
BMW 31126755432 BMW 6755432	BMW 31121124622 BMW 31121133236 BMW 31121139826	BMW 001092010 BMW 31121092010 BMW 31129068753	BMW 31121092010 BMW 31129068753
			





510610	510616	510619	510620
BMW 31121092019 BMW 31121094235	BMW 33326770775 BMW 33326770776 BMW 33326772241	BMW 33321090102	BMW 31120302754 BMW 31120304308 BMW 31126765991
			

Cross References List And Photo

Photo.....





510620S		510621		510630		510652	
BMW	31120302754	BMW	001093707	BMW	31121141752	BMW	31103412781
BMW	31120304308	BMW	1093707	BMW	31129068734	BMW	31121096372
				BMW	31129069829	BMW	31126769715
							

510654		510680		510681		510682	
BMW	31351097021	PEUGEOT	3523AG	PEUGEOT	352376	CITROËN	352392
						PEUGEOT	352377
							





510685		510686		510687		510688	
PEUGEOT	352340	PEUGEOT	352342	CITROËN	352378	PEUGEOT	352361
		PEUGEOT	352354	PEUGEOT	352360		
		PEUGEOT	352389				
							

Cross References List And Photo

Photo.....





510689		510690		510698		510701	
CITROËN	3520H5	CITROËN	3520H5	PEUGEOT	509434	CITROËN	96158745
CITROËN	3520H5S1	CITROËN	352362			PEUGEOT	509464
CITROËN	96110483	CITROËN	352375			PEUGEOT	509480
							





510713		510714		510715S		510716	
CITROËN	352351	CITROËN	352394	CITROËN	352393	CITROËN	352350
CITROËN	96106474	CITROËN	3523AP	FIAT	1300507080		
		FIAT	1339464080	FIAT	1339464080		
							

510719		510724		510731		510735	
CITROËN	352327	CITROËN	3520Q1	CITROËN	352395	CITROËN	3523CJ
CITROËN	352349	PEUGEOT	3520N6	CITROËN	3523AR	PEUGEOT	352380
PEUGEOT	252329	PEUGEOT	3521J6				
							

Cross References List And Photo

Photo.....





510740		510741		510742		510743	
RENAULT	8200002868	OPEL	4408958	RENAULT	8200041166	MERCEDES-BENZ	4153300200
RENAULT	8200389135	OPEL	4412934	RENAULT	8200298454	RENAULT	8200242025
RENAULT	8200452716	OPEL	4418224	RENAULT	8200298455	RENAULT	8200586564
							

510748		510756		510758		510761	
DACIA	6001547138	RENAULT	7700789478	MERCEDES-BENZ	3814922641	RENAULT	7700418941
NISSAN	5461600QAA	RENAULT	7700840741	RENAULT	7700224699	RENAULT	7700419066
RENAULT	7700799404	RENAULT	8200651163			RENAULT	8200651162
							

510776		510796		510797		510843	
DACIA	6001547140	VOLVO	9173618	VOLVO	30760590	DAEWOO	90335966
DACIA	6001549311	VOLVO	9443882	VOLVO	8630604	OPEL	0352349
DACIA	8200262344	VOLVO	9465971	VOLVO	9461626	OPEL	352334
							

Cross References List And Photo

Photo.....

510844	510886	510891	510892
CHEVROLET 90235040 OPEL 0352335 OPEL 352335	CHEVROLET 96259768 DAEWOO 96298000 DAEWOO 96492383	CHEVROLET 96308617	DAEWOO 96308618
			

510897	510899	510903	510925
CHEVROLET 96380613 DAEWOO 45261A78B00000 SUZUKI 0931910030	DAEWOO 02875013 DAEWOO 2875013 OPEL 0350153	DAEWOO 02875013S1 DAEWOO 2875013S1 OPEL 1603148	GENERAL MOTORS 352319 OPEL 0352319 VAUXHALL 12786412
			

510925S	510926	510948	510956
OPEL 0352319 OPEL 352319 SAAB 12786412	OPEL 0352357 OPEL 0352364 OPEL 352357	HYUNDAI 5455102000 HYUNDAI 5455122100 HYUNDAI 5455122200	HYUNDAI 5455128000 HYUNDAI 5455128070
			

Cross References List And Photo

Photo.....

510964		511036		511040		511042	
HYUNDAI	5458417000	TOYOTA	4881528060	TOYOTA	4863526010	TOYOTA	4806812190
HYUNDAI	545842D000	TOYOTA	4881528061			TOYOTA	4806812190S3
						TOYOTA	4806812191
							

511043		511051		511111		511113	
TOYOTA	4865412090	TOYOTA	4865533040	HONDA	51392SR3004	HONDA	52380SR3003
				HONDA	51392SR3014	HONDA	52385SR3000
				HONDA	51392SR3024	ROVER	RGX10007
							

511117		511118		511157		511158	
HONDA	51391S01004	HONDA	51810SH3003	KIA	0K9A234470	MAZDA	GA2A34460
HONDA	51391S04005	HONDA	51810SH3004	MAZDA	GA2B34470		
HONDA	51391S47005	ROVER	RBX100681	MAZDA	GA2B34470A		
							

Cross References List And Photo

Photo.....

511194		511196		511206		511209	
FORD	1954757	INFINITI	545002Y411	NISSAN	54476F0200	INFINITI	545000M010
NISSAN	54506B9500	NISSAN	545602Y020			INFINITI	545010M060
MITSUBISHI	MB430462					INFINITI	5457069Y10
							

511223		511224		511231		511257	
GENERAL MOTORS	09160394	GENERAL MOTORS	09160395	NISSAN	54570CA000	MITSUBISHI	MB109662
NISSAN	5457000QAA	NISSAN	5442300QAA				
OPEL	4500094	OPEL	4500095				
							

511259		511260		511275		511284	
MITSUBISHI	MB584041	HYUNDAI	MB584021A	MITSUBISHI	MB109684	SUBARU	4642060B02
MITSUBISHI	MB631492	MITSUBISHI	MB584166	MITSUBISHI	MB633870	SUZUKI	4554060B00
						SUZUKI	4554060B02
							

Cross References List And Photo

Photo.....

511293		511294		511295		511296	
SUZUKI	0931912045	SUZUKI	0931912044	SUZUKI	0931912047	SUZUKI	0931914007
SUZUKI	931912045	SUZUKI	0931912044000	SUZUKI	4621365D00	SUZUKI	0931914007000
		SUZUKI	4525385C00	SUZUKI	4621365D01	SUZUKI	4525485C00
							

511307		511352		511366		511367	
BUICK	10285683	CHRYSLER	04656012AC	CHRYSLER	52088425	DODGE	45G9232
BUICK	10403402	CHRYSLER	4656012AB			DODGE	52088649AC
BUICK	10427801	CHRYSLER	4656012AC			DODGE	5651231
							

511374		511375		511376		511378	
FORD	1061670	FORD	1000445	FORD	1035929	FORD	6790115
FORD	735839128	FORD	1829508	FORD	89FB3A262AC	FORD	93BB3063AA
FORD	98AG5K896AB	FORD	89FB3063AD	FORD	91AB3A262AA		
							

Cross References List And Photo

Photo.....

511379		511382		511383		511398	
FORD	6870549	FORD	1039511	FORD	6701505	FORD	1023058
FORD USA	93BB3A262BA	FORD	1054209	FORD	7014210	FORD	1074282
		FORD	93BB5K566AG	FORD USA	93BB5K566AC	FORD USA	95BG3A262AA
							

511399		511416		511417		511456	
FORD	1014654	FORD	1061570	FORD	1207974	FIAT	46421522
FORD	1063372	FORD USA	98AG3063AE	FORD	1344966	FIAT	46454597
MAZDA	1E0134153A			FORD	1344968	FIAT	46454598
							

511465S		511477		511478		511480	
ALFA ROMEO	46519894	SUBARU	20201AA000	SUBARU	20251AA000	SUBARU	20251AA010
ALFA ROMEO	46519898	SUBARU	20201AA070	SUBARU	20251AA040	SUBARU	20254SA010
							

Cross References List And Photo

Photo.....

511481		511482		511490		511527	
SUBARU	20420AA002	SUBARU	20481AA000	AUDI	7L0407182C	HYUNDAI	5455502000
SUBARU	20420AA003	SUBARU	20481AA001	AUDI	7L0407182E	HYUNDAI	5455502001
SUBARU	20420AA004			PORSCHE	95534124203	HYUNDAI	5455522102
							





511528		511539		511541		511546S	
HYUNDAI	5455602000	RENAULT	7700314855	MERCEDES-BENZ	2013234885	MERCEDES-BENZ	2013200047
HYUNDAI	5455602001	RENAULT	7700784170	MERCEDES-BENZ	2013234985	MERCEDES-BENZ	2013200847
HYUNDAI	5455602002			MERCEDES-BENZ	A2013234885	MERCEDES-BENZ	A2013200047
							





511548		511550		511551		511552S	
MERCEDES-BENZ	6383230285	CHRYSLER	05104066AA	CHRYSLER	05104065AA	MERCEDES-BENZ	1243200047
MERCEDES-BENZ	9063260981	CHRYSLER	5104066AA	CHRYSLER	5104065AA	MERCEDES-BENZ	1243201847
VW	2E0511413D	VW	2D0411041A	MERCEDES-BENZ	9013230185	MERCEDES-BENZ	A1243201847
							

Cross References List And Photo

Photo.....





511553	511560	511588	511593
MERCEDES-BENZ 1243232385 MERCEDES-BENZ 1243234985 MERCEDES-BENZ A1243232385	MERCEDES-BENZ 1243527065 MERCEDES-BENZ 1243528465 MERCEDES-BENZ 2023520065	BMW 33551094550 BMW 33551131155	BMW 31121135079 BMW 31121135352 BMW 31129059288
			

511658	511659	511663	511664
FORD 6701499 FORD 7144202 FORD USA 93BB4A037AC	FORD 7144204 FORD USA 93BB4A037EA	FORD 1117749 FORD 1124418 FORD USA 1S714A037DC	FORD 1128725 FORD 6714195 FORD 93BB5484AB
			





511673	511675	511720	511725
FORD 4042024 FORD 4372132 FORD 4540787	FORD 4041450 FORD 4131788 FORD USA YC153069AF	HONDA 51306S04N01	HONDA 52364S5A004 HONDA 52364S6M004
			

Cross References List And Photo

Photo.....

511726		511727		511728		511739	
HONDA	52366S7A000	HONDA	51392S5A004	HONDA	51391S5A024	HONDA	52341S04000
HONDA	52390S5C010	HONDA	51392S5A701	HONDA	51391S5A801	HONDA	52341S04A00
HONDA	52395S5A004	HONDA	51392S5A851	HONDA	51391S7A801		
							

511843		511844		511888		511908	
MITSUBISHI	MB430145	MITSUBISHI	MB808909	NISSAN	5456001G00	CITROËN	352383
MITSUBISHI	MB598017	MITSUBISHI	MR102653	NISSAN	545600F001		
MITSUBISHI	MR319537	VOLVO	30872510				
							

511909		511915		511916		511919	
CITROËN	352335	CITROËN	3523AA	CITROËN	352398	CITROËN	352391
CITROËN	352345	CITROËN	3523AT	CITROËN	9636191080	PEUGEOT	3523AJ
PEUGEOT	352396	CITROËN	9640877080				
							

Cross References List And Photo

Photo.....

511937		512018		512019		512020	
RENAULT	7700824042	LEXUS	4863260020	TOYOTA	4865404040	LEXUS	4865504020
		TOYOTA	4863204010	TOYOTA	4865460030	TOYOTA	486550K040
		TOYOTA	4863204020			TOYOTA	4865560030
							

512038		512057		512072		512081	
TOYOTA	4872512460	LEXUS	4870660060	TOYOTA	4865433040	TOYOTA	4863235050
TOYOTA	4878012010	LEXUS	4874035040				
TOYOTA	4878032060						
							

512190		512203		512249		512252	
VOLVO	1273235	AUDI	1K0505541B	AUDI	1J0411315E	MERCEDES-BENZ	1243524365
VOLVO	3530388	AUDI	1K0505541C	AUDI	1J0411315G	MERCEDES-BENZ	2013528765
		AUDI	1K0505541D			MERCEDES-BENZ	2013528865
							

Cross References List And Photo

Photo.....

512257		512260		512266		512278	
CITROËN	96083570	MITSUBISHI MB633820 MITSUBISHI MB831035 MITSUBISHI MR124880		TOYOTA 4881730010 TOYOTA 4881730020		AUDI 893411327C AUDI 893411327E	
							

512284		512285		512298		512299	
CITROËN	352343	TOYOTA 4881506020 TOYOTA 4881507010 TOYOTA 4881533010		BMW 31351091555		BMW 33551093663	
							

512300		512305		512317		512319	
BMW	33551096893	BMW 33321092248 BMW 33321138383 BMW 33326770824		DODGE 05104577AA MERCEDES-BENZ 9043230085 VW 2D0411041B		CHRYSLER 05118800AA CHRYSLER 5118800AA VW 2D0511413B	
							

Cross References List And Photo

Photo.....





512389		512425		512499		512500	
PEUGEOT	517239	RENAULT	6025307746	CITROËN	509457	CITROËN	509465
PEUGEOT	517243	RENAULT	7700822503			CITROËN	96051355
						CITROËN	96051391
							

512523		512575S		512580		512581	
MAZDA	B45728156	MERCEDES-BENZ	1633200044	CHRYSLER	05104059AA	CHRYSLER	05104060AA
MAZDA	BW0A28156A	MERCEDES-BENZ	1633200144	VW	2D0411051	VW	2D0411052
		MERCEDES-BENZ	1633230285	VW	2D0411051S1	VW	2D0411052S1
							



512608		512609		512613		512614	
MERCEDES-BENZ	1243232785	MERCEDES-BENZ	1243235485	MERCEDES-BENZ	2023230285	MERCEDES-BENZ	2033230685
MERCEDES-BENZ	1243235085	MERCEDES-BENZ	A1243235485	MERCEDES-BENZ	A2023230285	MERCEDES-BENZ	2033232085
MERCEDES-BENZ	A1243232785					MERCEDES-BENZ	A2033230685
							

Cross References List And Photo

Photo.....





512615	512616	512642S	512710
MERCEDES-BENZ 2033230585 MERCEDES-BENZ 2033232185 MERCEDES-BENZ A2033230585	MERCEDES-BENZ 2103231485 MERCEDES-BENZ 2103231585 MERCEDES-BENZ A2103231485	MERCEDES-BENZ 1263300075 MERCEDES-BENZ 1265860033 MERCEDES-BENZ A1263300075	BMW 1092247 BMW 33321092247 BMW 33321137571
			

512754	512757	512759	512765
BMW 31351090268	BMW 31351097179	BMW 33552226315	MERCEDES-BENZ 1403231085 MERCEDES-BENZ A1403231085
			

512766	512784	512800	512801
MERCEDES-BENZ 1633300075 MERCEDES-BENZ 1633500075 MERCEDES-BENZ A1633300075	CITROËN 352320 CITROËN 96096727 PEUGEOT 352373	CITROËN 509466	CITROËN 509479 CITROËN 9615872080
			

Cross References List And Photo

Photo.....

512843	512844	512846	512847
<p> 512843 MITSUBISHI MR150091 </p>	<p> 512844 MITSUBISHI MR150094 MITSUBISHI MR150095 </p>	<p> 512846 MITSUBISHI MR374520 </p>	<p> 512847 MITSUBISHI MR150767 </p>
			

512849	512850	512851	512853
<p> 512849 MITSUBISHI MB430201 </p>	<p> 512850 HYUNDAI 5444943000 MITSUBISHI MB430200 </p>	<p> 512851 CHERY A21BJ2909070 CHRYSLER 05105040AA MITSUBISHI MR403441 </p>	<p> 512853 HYUNDAI 54564H1000 MITSUBISHI MB633870 </p>
			

512854	512857	512859	512860
<p> 512854 MITSUBISHI MR519398 </p>	<p> 512857 MITSUBISHI MR112891 </p>	<p> 512859 MITSUBISHI MR374672 </p>	<p> 512860 MITSUBISHI MR510418 </p>
			

Cross References List And Photo

Photo.....

512861		512866		512871		512881	
MITSUBISHI	MB809388	INFINITI	546132Y002	NISSAN	5504560Y00	HONDA	51306S84A01
				NISSAN	55045D0100	HONDA	51306S87A01
				NISSAN	55045D0101		
							





512883		512884		512886		512887	
HONDA	51306SNAA02	HONDA	51306S04003	HONDA	52306S9A005	HONDA	51306S5A003
				HONDA	52306T1WA01	HONDA	51306S5D005
						HONDA	51306S7B014
							

512889		512890		512892		512896	
HONDA	51391SM4013	HONDA	51391S84A01	HONDA	51393SDAA02	HONDA	52390SM1A03
				HONDA	51393SEA004	HONDA	52393SM4004
				HONDA	51393TP6A01	HONDA	52393SM4013
							

Cross References List And Photo

Photo.....

512937		512938		512939		512941	
TOYOTA	4881542040	TOYOTA	4881510060	LEXUS	4881506050	LEXUS	4881833040
		TOYOTA	4881542050	LEXUS	4881506070		
				LEXUS	4881533050		
							

512942		512943		512944		512947	
TOYOTA	4881806100	LEXUS	4881833050	TOYOTA	4881533040	LEXUS	4881506200
						LEXUS	4881533100
						TOYOTA	4881533101
							

512952		512954		512960		512965	
LEXUS	4881514140	TOYOTA	4881560180	TOYOTA	4881542020	TOYOTA	4881502060
TOYOTA	4811526100	TOYOTA	4881560350			TOYOTA	4881512310
TOYOTA	4881526100						
							

Cross References List And Photo

Photo.....





512974	512982	512986	512987
TOYOTA 4865412050	TOYOTA 4865528010	TOYOTA 486100K010 TOYOTA 4863204010 TOYOTA 486320K010	TOYOTA 486540K010
			





512988	512989	512992	513014
TOYOTA 486540K040	TOYOTA 4806802020 TOYOTA 4806812220 TOYOTA 4865512170	TOYOTA 4870228080 TOYOTA 4871035010 TOYOTA 4872035010	TOYOTA 4870626020 TOYOTA 4870628010 TOYOTA 4870628020
			

513034	513074	513083	513091
TOYOTA 4230520090 TOYOTA 4872533050 TOYOTA 4878012020	TOYOTA 4230520090 TOYOTA 4872533050 TOYOTA 4878012020	TOYOTA MB633908 TOYOTA 9094801061	TOYOTA 4881710020 TOYOTA 4881910010 TOYOTA 9094802032
			

Cross References List And Photo

Photo.....

513105		513111		513126		513127	
TOYOTA	4881812220	LEXUS	4881812160	TOYOTA	4881510090	TOYOTA	4881548030
		TOYOTA	4881802060				
							

513129		513135		513136		513150	
TOYOTA	4881505030	TOYOTA	4881833011	LEXUS	4881806160	TOYOTA	4881542070
TOYOTA	4881520060			TOYOTA	4881821030	TOYOTA	4881547020
							



513152		513205		513211		513219	
TOYOTA	4881542080	TOYOTA	4865502080	TOYOTA	480680K010	TOYOTA	4806828140
TOYOTA	4881547030			TOYOTA	486550K010	TOYOTA	4806842051
						TOYOTA	4806942051
							

Cross References List And Photo

Photo.....

513234		513238		513239		513242	
TOYOTA	4865528020	HONDA	52315SR3900	HONDA	52315SK7900	HONDA	06510SWY305
TOYOTA	4865533050					HONDA	51306SWAA01
						HONDA	51306SWAA02
							

513248		513255		513256		513277	
HONDA	51450SDAA01	HONDA	51381SM4013	HONDA	51314SM4000	MAZDA	GA2A34156
HONDA	51450SDAA01B			HONDA	51314SM4010		
HONDA	51460SDAA01			HONDA	51314SM4020		
							

513287		513290		513291		513298	
NISSAN	54560W000	NISSAN	546130E015	INFINITI	562430E015	NISSAN	546137S000
						NISSAN	54613EA000
						NISSAN	54613ZS20A
							

Cross References List And Photo

Photo.....





513299	513327	513328	513332
NISSAN 54613EA520	mitsubishi MB573784	HYUNDAI MB338595 mitsubishi MB338596 mitsubishi MR267685	mitsubishi MN100250
			

513334	513353	513354S	513355
mitsubishi MB338594 mitsubishi MR267684	mitsubishi MB633926	mitsubishi MB831039	mitsubishi MB598098 mitsubishi MR344624 mitsubishi MR586053
			

513357	513542	513602	513605
mitsubishi MB527385	TOYOTA 4865487401	HYUNDAI 550450W011 HYUNDAI 550450W023 NISSAN 550451W201	SUZUKI 4241260A00 SUZUKI 4241260A00000
			

Cross References List And Photo

Photo.....





513610		513612		513646		513647	
TOYOTA	488150K010	MITSUBISHI	MR150090	HONDA	52306S0KA01	HONDA	52306SNAA01
TOYOTA	488150K020			HONDA	52306SWAA01	HONDA	52306SNAA02
TOYOTA	488150K040					HONDA	52306SNGJ01
							

513656		513670		513681		513682	
HONDA	51391SNA305	CHRYSLER	05105040AA	HYUNDAI	5481328001	HYUNDAI	5551329000
		CITROËN	05105040AD	HYUNDAI	548132D101	HYUNDAI	5551329020
		CITROËN	05105040AE	HYUNDAI	548132D102	HYUNDAI	5551329100
							

513683		513686		513688		513689	
HYUNDAI	5481339000	HYUNDAI	5525438000	HYUNDAI	545841G000	HYUNDAI	5271838000
HYUNDAI	5481339001			HYUNDAI	545842E000	HYUNDAI	551181D000
HYUNDAI	5481339100					HYUNDAI	551181H000
							

Cross References List And Photo

Photo.....

513713		513768S		513770		513811	
RENAULT	7700835929	VOLVO	30620989	MITSUBISHI	MB809239	INFINITI	545000W000
		VOLVO	30620990	MITSUBISHI	MR102012	INFINITI	545000W001
		VOLVO	30623966	MITSUBISHI	MR244851	INFINITI	545010W001
							





513844		513910		513955		513956	
SEAT	6K0411315	CITROËN	352399	NISSAN	5461300QAD	RENAULT	7700784171
		CITROËN	3523AA	RENAULT	7700436014		
		CITROËN	3523AT	RENAULT	7700785788		
							

513969		513971		514003		514024	
RENAULT	7700428666	TOYOTA	4806812171S	TOYOTA	4872542080	TOYOTA	4871020270
RENAULT	8200150759	TOYOTA	4865412120				
		TOYOTA	4865512100				
							

Cross References List And Photo

Photo.....

514025		514031		514033		514054S	
FORD	1305960	FORD	1348231	FORD	1254285	SUZUKI	4550050800
FORD	3M515484CA	MAZDA	BP4K34156A	FORD	1301732		
VOLVO	30666266	MAZDA	BP4K34156B	FORD	1337965		
							





514056		514249		514273		514274	
DAIHATSU	4865487402	HONDA	52303SH3020	SUBARU	20201AA061	SUBARU	20201AA051
		HONDA	52303SK3010	SUBARU	20201FA060	SUBARU	20201FA050
		HONDA	RGD10001	SUBARU	20201FA080	SUBARU	20201FA070
							

514291		514292		514296		514297	
HYUNDAI	545512C500	HYUNDAI	5455126000	LEXUS	4806806070	LEXUS	4806833010
HYUNDAI	545512D000	HYUNDAI	545513A000	TOYOTA	4806828120	LEXUS	4806833020
				TOYOTA	4865533010	LEXUS	4806933020
							

Cross References List And Photo

Photo.....

514314		514363		514447		514502	
HYUNDAI	5455138000	NISSAN	545009W200	FORD	1234371	NISSAN	54500CC40E
HYUNDAI	5455138010	NISSAN	54570CA000	FORD	1570284	MAZDA	B32H34300E
							

514504		514520		514710		514827	
NISSAN	MR554381	LEXUS	4806908020	FORD	1207973	DACIA	6040002245
TOYOTA	4806808020	TOYOTA	4806808020	FORD	1344966	RENAULT	6001547519
				FORD	1344968	RENAULT	6040096299
							

514839		514845		514847		514854	
NISSAN	MR491345	HONDA	52622SH3003	HYUNDAI	5458438000	NISSAN	5512050C00
NISSAN	MR491346	HONDA	52622SH3004	HYUNDAI	5458438010	NISSAN	551208H500
VOLVO	30620785					NISSAN	5515250J00
							

Cross References List And Photo

Photo.....

514855		514869		514886		514889	
LEXUS	4871053010	MITSUBISHI	4056A161	HYUNDAI	5455526000	FORD	1061659
LEXUS	4872553040	MITSUBISHI	MR241349			FORD	1220005
		MITSUBISHI	MR954887			FORD	1524422
							

514892		514893		514900		514903	
LEXUS	4806806010	HYUNDAI	545104B001	HONDA	52371S7S000	HYUNDAI	5450007100
LEXUS	4806833010	HYUNDAI	545224B000	HONDA	52371SM4010	HYUNDAI	5455107000
LEXUS	4806833031	HYUNDAI	545224B010	HONDA	52371SX0000	HYUNDAI	5455107001
							

514904		514905		514906		514907	
FORD	1061668	KIA	0K2FA28300	KIA	0K2FA28300	MITSUBISHI	MB633003
HYUNDAI	552561H000					MITSUBISHI	MB633004
HYUNDAI	552562G000						
							

Cross References List And Photo

Photo.....

514909S		514912		514914		514916	
HONDA	52390SR3000	SUBARU	20271AA020	HYUNDAI	545511D000	HYUNDAI	5510026000
HONDA	52393SK7004	SUBARU	20271AA021	HYUNDAI	545512E000	HYUNDAI	5511826000
HONDA	52393SR0004			HYUNDAI	545512H000		
							

514917		514918		514922		514925	
DAIHATSU	4865487202	TOYOTA	4872533020	TOYOTA	4871002070	MITSUBISHI	4113A062
DAIHATSU	4865487203	TOYOTA	4878048010	TOYOTA	4871012200	MITSUBISHI	MN100107
DAIHATSU	4865487203000	TOYOTA	4878048040	TOYOTA	4873012110	MITSUBISHI	MR197915
							

514927		514930		514932		514934	
KIA	0K9A63446X	CITROËN	5131G1	LEXUS	4871033051	CHRYSLER	05105271AA
MAZDA	GA2A3446XC	MITSUBISHI	4110A125	TOYOTA	4871006030	CHRYSLER	05105271AB
MAZDA	GA2A3446XE	MITSUBISHI	MN100110	TOYOTA	4871033050	MITSUBISHI	MN100107
							

Cross References List And Photo

Photo.....

514935		514940		514944		514945	
TOYOTA	4872028070	TOYOTA	4806802190	HONDA	52370SEAE00	MITSUBISHI	4120A001
TOYOTA	4872028071	TOYOTA	4806812160			MITSUBISHI	MR519127
TOYOTA	4873028070	TOYOTA	4806812171				
							

514949		514953		514954		514956	
FORD	1061666	INFINITI	551302Y010	NISSAN	545008H310	HONDA	52622SH3010
FORD	1064128	NISSAN	551302Y610	NISSAN	545018H310	HONDA	52622SR0004
FORD	1150353			NISSAN	545018H31A		
							

514957		514962		514967		514968	
FORD	1061666	TOYOTA	4806802020	INFINITI	551302Y010	MITSUBISHI	4410A025
FORD	1064128	TOYOTA	4806812220	NISSAN	551302Y610	MITSUBISHI	MR403503
FORD	BV615K652ED	TOYOTA	4806842040				
							

Cross References List And Photo

Photo.....

514972		514974		514977		514980	
NISSAN	545008H310	CHERY	A212906025	MAZDA	E11232123	HYUNDAI	5521538000
NISSAN	545008H31A						
NISSAN	545018H31A						
							

514982		514988		514994		514996	
SUBARU	20250FG020	SUBARU	20254AE040	HYUNDAI	5513038000	HYUNDAI	5520026500
SUBARU	20254AE010			HYUNDAI	5513038001	HYUNDAI	5520326700
SUBARU	20254FG020			HYUNDAI	5513038002	HYUNDAI	5520426700
							

515000		516001		516004		516012	
CHEVROLET	96213131	CHEVROLET	96213130	HYUNDAI	545842B000	HYUNDAI	5554335000
				HYUNDAI	5458438100	HYUNDAI	5554335010
				KIA	545840Q000	HYUNDAI	555433K000
							

Cross References List And Photo

Photo.....

516015		516017		516018		516019	
HYUNDAI	54430H1100	mitsubishi	MR210731	MITSUBISHI	4113A085	HYUNDAI	5444038000
		MITSUBISHI	MR448511	MITSUBISHI	MR210729	HYUNDAI	5444338000
				MITSUBISHI	MR234271	HYUNDAI	5444338600
							

516024		516025S		516026		516027	
NISSAN	550460W001	HONDA	52341S04000	SUBARU	20250AE000	SUBARU	20251AA031
				SUBARU	20250AE060		
							

516029		516030		516031		516032	
MITSUBISHI	3770A015	HYUNDAI	552102D000	HONDA	52622SH3013	INFINITI	551302F000
MITSUBISHI	MR418065	HYUNDAI	552152D000			NISSAN	551350M000
MITSUBISHI	MR418066	HYUNDAI	552272D000				
							

Cross References List And Photo

Photo.....

516044		516045		516050		516051	
<p> mitsubishi MR162579 mitsubishi MR296295 mitsubishi MR972465 </p>	<p> mitsubishi MB831555 </p>	<p> KIA 0K01128830 KIA 0K72A28830 KIA 0K72A28830B </p>	<p> KIA 0K01128820 KIA 0K01128820A </p>				





516054		516055		516057		516059	
<p> AUDI 7L0412333 AUDI 7L0412333A PORSCHE 95534324301 </p>	<p> KIA 0K01134830 KIA 0K01134830A KIA 0K72A34830 </p>	<p> KIA 0K01134840 KIA 0K08034840 KIA 0K72A34840A </p>	<p> MITSUBISHI 4013A036 MITSUBISHI MR594325 MITSUBISHI MR594326 </p>				

516063		516069		516070		516080	
<p> AUDI 7L0505311B PORSCHE 95533101711 VW 7P0505311E </p>	<p> MITSUBISHI MN184123 </p>	<p> DAIHATSU 48654B2010 DAIHATSU 48654B2010000 TOYOTA 4877042020 </p>	<p> MITSUBISHI MR130982 MITSUBISHI MR198168 VOLVO 30818467 </p>				

Cross References List And Photo

Photo.....

516081		516082		516087		516090	
HYUNDAI	5455238000	mitsubishi	MR162584	KIA	0K01128840	AUDI	7L0407183A
MITSUBISHI	MR162581	MITSUBISHI	MR296290	KIA	0K72A28840A	AUDI	7L8407183
MITSUBISHI	MR296296	MITSUBISHI	MR325251			PORSCHE	95534158810
							

516092		516093		516094		516095	
KIA	0K01134820	INFINITI	54468AC70A	INFINITI	54500AL500	MITSUBISHI	MR594320
KIA	0K01134820A			NISSAN	54500AM601		
KIA	0K72A34820						
							

516099		516100		516108		516109	
CHERY	T112909080	INFINITI	551101BA0B	INFINITI	545241CA0A	AUDI	7L0505323A
CHERY	T212909080			INFINITI	54524AL500	AUDI	7L0505323ASK
				INFINITI	54524CF00A	AUDI	7L0505554
							

Cross References List And Photo

Photo.....

516112		516115		516118		516120	
LEXUS	4877030080	HONDA	52350SDAA00	HYUNDAI	552254A000	AUDI	7L0501529C
LEXUS	4877030090	HONDA	52350SEA000	MITSUBISHI	MB951815	AUDI	7L0505323AS2
						AUDI	7L0505553
							

516121		516122		516123		516133S	
AUDI	7L0501529C	HONDA	52350S1AE00	LEXUS	4872035060	TOYOTA	4862030290
AUDI	7L0505397			LEXUS	4872535020	TOYOTA	4864030290
AUDI	7L0505397SK			TOYOTA	4872035061	TOYOTA	4865430300
							

516135		516137		516138		516141	
MITSUBISHI	MR316028	LEXUS	4807530020	HONDA	52360S1AE00	HONDA	52365SK7A00
		LEXUS	4807630020	HONDA	52360SEA000	HONDA	52365SK7A02
		TOYOTA	4807530030	HONDA	52360SEAE10	HONDA	52365ST3E01
							

Cross References List And Photo

Photo.....

516145		516147		516149		516150	
HYUNDAI	551002B100	NISSAN	54444CA000	HYUNDAI	552102E100	HYUNDAI	545004H000
HYUNDAI	551182B100			HYUNDAI	552152E500	HYUNDAI	545502P000
				KIA	552102E000	HYUNDAI	545512B000
							

516151		516153		516155		516158	
SUBARU	20204AG000	SUZUKI	4633165J00	DODGE	05272714AA	SUBARU	20254FG010
SUBARU	20204AG040	SUZUKI	4633165J01	MITSUBISHI	4120A125	SUBARU	20254FJ000
SUBARU	20204AJ000			PEUGEOT	5131G0	SUBARU	20254XA00A
							

516163		516164		516166		516170	
SUZUKI	4875060A00	SUZUKI	0931912039	HYUNDAI	4612265J00	MITSUBISHI	4110A012
		SUZUKI	4628281A00	HYUNDAI	552103K000	MITSUBISHI	4110A085
		SUZUKI	4628281A30	HYUNDAI	552153K000	MITSUBISHI	MR491911
							

Cross References List And Photo

Photo.....

516171		516172		516174		516175	
HYUNDAI	551103K000	HYUNDAI	552182B000	INFINITI	55501CG000	CHRYSLER	04766910AE
HYUNDAI	553422P000			INFINITI	55502CG000	MITSUBISHI	4013A129
HYUNDAI	553423K000			NISSAN	550458J000	MITSUBISHI	4013A131
							

516176		516178		516180		516181	
SUZUKI	0931965000	SUZUKI	4611054G60	HYUNDAI	551162E000	INFINITI	545241LA0A
SUZUKI	4620165D00					INFINITI	54524EB300
SUZUKI	4620165D50					INFINITI	54542EB70D
							

516186		516187		516188		516190	
NISSAN	545001KA0A	SUZUKI	4520165J00	NISSAN	54500BB00A	SUZUKI	4620054G10
NISSAN	54500BR30A	SUZUKI	4520178K00	NISSAN	54500BR30A		
NISSAN	54500JD000	SUZUKI	4520265J00	NISSAN	54500JD000		
							

Cross References List And Photo

Photo.....

516192		516196		516197		516198	
NISSAN	55153EB30B	SUBARU	20204AG010	INFINITI	551B0AL500	NISSAN	55045EB30B
		SUBARU	20204AG011			NISSAN	55501EB300
		SUBARU	20204AG01B			NISSAN	55502EB300
							



516199		516200		516202		516204	
NISSAN	55153EB30A	NISSAN	551B01LB0A	SUZUKI	4526165J00	SUBARU	20204XA00A
		NISSAN	551B0EB300	SUZUKI	4553165J00		
							

516207		516208		516213		516214	
NISSAN	54500EA000	NISSAN	55045EB30A	SSANGYONG	4630052D00	TOYOTA	4876042010
NISSAN	54500EA00A	NISSAN	55501EB300			TOYOTA	4876042030
NISSAN	54560EB70A	NISSAN	55502EB300			TOYOTA	4878042010
							

Cross References List And Photo

Photo.....

516216		516217		516220		516222	
NISSAN	556181KD0A	LEXUS	4806802130	MITSUBISHI	4117A025	MITSUBISHI	3770A015
NISSAN	55618JD00A	LEXUS	4806812300	MITSUBISHI	MR508134	MITSUBISHI	MR992532
NISSAN	55619JD00A	LEXUS	4806912300	MITSUBISHI	MR990882		
							

516223		516223S		516228		516229	
LEXUS	4872542100	TOYOTA	4872542100	NISSAN	55153JA00A	LEXUS	4873005070
TOYOTA	4876042010	TOYOTA	4876042010	NISSAN	551A0CC40A	LEXUS	4873042050
TOYOTA	4878042010	TOYOTA	4878042010	NISSAN	551A1CC40A	TOYOTA	4873042040
							



516230		516232		516233		516234	
INFINITI	55045AG000	HONDA	52345S0XA01	INFINITI	54500CG200	INFINITI	55110CG000
INFINITI	55501CA000	HYUNDAI	551182S000	INFINITI	54501CG200		
INFINITI	55502CA000	HYUNDAI	552532S100	INFINITI	54570CG200		
							

Cross References List And Photo

Photo.....

516235		516236		516237		516242	
NISSAN	55110CA000	INFINITI	551B0CG000	INFINITI	551A0CG000	INFINITI	54500CG200
						INFINITI	55044CG000
							

516243		516244		516245		516248	
TOYOTA	4806842040	DODGE	05133818AA	HONDA	51350S01000	HONDA	51350SAA013
TOYOTA	4806842041	MERCEDES-BENZ	9013330214	HONDA	51350S04G00	HONDA	51350SAAE11
TOYOTA	4806942040	VW	2D0407083	HONDA	51350S10G00	HONDA	51360SAAE11
							

516249		516250		516253		516254	
HONDA	51350SAA013	NISSAN	55045EN100	MITSUBISHI	4010A013	NISSAN	54500WL000
HONDA	51350SAAE11	NISSAN	55121JD000	MITSUBISHI	4010A014	NISSAN	54501WL000
HONDA	51360SAAE11	NISSAN	55121JD00B	MITSUBISHI	4010A117		
							

Cross References List And Photo

Photo.....

516255		516259		516265S		516268	
HONDA	52390SNA900	MITSUBISHI	MB864741	HONDA	52210SNAA00	NISSAN	551300F500
HONDA	52390SNAA00	MITSUBISHI	MB912515	HONDA	52210SNAA50		
HONDA	52400SNA900						
							

516269		516270		516272		516273S	
HONDA	52390SNA900	NISSAN	55044JG00A	NISSAN	55045JY00C	HONDA	52370SMA040
HONDA	52400SNA900	NISSAN	55501JG000	NISSAN	55110JG000	HONDA	52370SNAA04
HONDA	52400SNA900S	NISSAN	55501JY00A	NISSAN	55111JG00A	HONDA	52370SNAA06
							

516276		516290		516294		516298	
TOYOTA	4870228060	NISSAN	551B09Y000	MITSUBISHI	4010A037	INFINITI	551350W000
		NISSAN	551B0CA000	MITSUBISHI	4010A038		
				MITSUBISHI	MR496793		
							

Cross References List And Photo

Photo.....

516300		516304		516308		516310	
MITSUBISHI	MR316051	MITSUBISHI	4013A209	SUBARU	20254XA04A	BMW	33321095261
MITSUBISHI	MR316054	MITSUBISHI	4013A213			BMW	33321095262
MITSUBISHI	MR589033	MITSUBISHI	MR510417S			BMW	33321095287
							



516311		516313		516314		516316	
TOYOTA	486320K040	KIA	0K2A1341460	BMW	33326754557	SUBARU	20252FG000
		KIA	0K2A134460	BMW	33326754558	SUBARU	20252XA004
		KIA	0K2C034460	BMW	33326770743	SUBARU	20252XA01A
							

516319		516320		516321		516329	
SUBARU	34112AG000	SUBARU	20254XA03A	SUBARU	20252XA00A	HYUNDAI	552214H000
SUBARU	34112AG001			SUBARU	20252XA01A	HYUNDAI	552703E000
						HYUNDAI	552704H100
							

Cross References List And Photo

Photo.....

516330		516331		516332		516333	
KIA	552803E000	mitsubishi	MR554381	KIA	552903E000	KIA	545803E001
KIA	552803E001			KIA	552903E001		
KIA	552803E002			KIA	552903E002		
							

516334		516338		516339		516341	
MITSUBISHI	4117A007	HYUNDAI	544433K000	MITSUBISHI	MB864921	TOYOTA	4211046010
MITSUBISHI	MR403485	HYUNDAI	544433K001	MITSUBISHI	MR223651	TOYOTA	4872510040
				MITSUBISHI	MR333867	TOYOTA	4872516150
							

516342		516343		516344		516346	
KIA	545002J002	HYUNDAI	556303E000	HYUNDAI	556203E000	KIA	0K2A13446X
KIA	545803E002	HYUNDAI	556304H000	HYUNDAI	556204H000	KIA	0K2A13446Y
KIA	545803E100						
							

Cross References List And Photo

Photo.....

516348		516349		516355		516357	
HYUNDAI	545513K000	KIA	544803E001	LEXUS	4871035050	MITSUBISHI	MB864711
HYUNDAI	545513L000			LEXUS	4871035070	MITSUBISHI	MB914431
				TOYOTA	4871035060	MITSUBISHI	MB914432
							

516361		516370		516372		516373	
HYUNDAI	552152G000	AUDI	1K0505171C	AUDI	1K0505203A	HYUNDAI	552701H000
HYUNDAI	552152W000	AUDI	1K0505173C	AUDI	1K0505323D	HYUNDAI	552802H000
HYUNDAI	552153V000	AUDI	1K0505311AA	AUDI	1K0505323H	HYUNDAI	555431H000
							

516377		516377S		516380		516380S	
LEXUS	4420035051	TOYOTA	4420035051	LEXUS	4420035051	TOYOTA	4420035051
		TOYOTA	4420035061	LEXUS	4420035061	TOYOTA	4420035061
							

Cross References List And Photo

Photo.....

516383		516384		516388		516389	
VW	7H0501132	CHRYSLER	52088217AB	MITSUBISHI	MN103500	SSANGYONG	4560108000
VW	7H0501132A	JEEP	52088220			SSANGYONG	4562105000
		JEEP	K52088167			SSANGYONG	4562105002
							

516394		516395		516396		516397	
SSANGYONG	4542105000	SSANGYONG	4441208000	SSANGYONG	4475008000	SSANGYONG	4451708000
SSANGYONG	4544008000	SSANGYONG	4441209000	SSANGYONG	4475208000		
							

516399		516400		516401		516407	
SSANGYONG	4451508000	SSANGYONG	4451608000	NISSAN	551807S000	LEXUS	4806808020
SSANGYONG	4451508001	SSANGYONG	4455309010	NISSAN	551B07S000		
		SSANGYONG	4455309013	NISSAN	551B0EA500		
							

Cross References List And Photo

Photo.....

516408		516409		516411S		516418	
AUDI	1K0505279A	VW	7H0501131	HONDA	52370S5A030	HONDA	51810S1AE01
AUDI	1K0505323D	VW	7H0501131A	HONDA	52370S5AA50	HONDA	51810SM4003
AUDI	1K0505323H			HONDA	52371S5AA50	HONDA	51810SV4003
							

516420		516421		516422		516436	
SUBARU	20251AA020	TOYOTA	4872028070	MITSUBISHI	MB809170	FORD	1234371
SUBARU	20251AA021	TOYOTA	4873028H00			FORD	1477858S2
						VOLVO	31277462
							

516438		516439		516445		516447	
HONDA	51395SWAA01	HONDA	51350SWAA01	HONDA	51312SD4020	AUDI	1K0511327AR
HONDA	51395SWAE01	HONDA	51350SWAE01	TOYOTA	4881712010	AUDI	1K0511327AS
HONDA	51396SWAA01	HONDA	51360SWAA01			SEAT	1K0511327A
							

Cross References List And Photo

Photo.....

516450		516452		516457		516458	
FORD	1385593	HONDA	51391SFE003	FORD	1117857	FORD	1206474
FORD	1469024	HONDA	51391TA0A01	FORD	1117859	FORD	1S715K898AG
FORD	1507181			JAGUAR	C2S50863		
							

516461		516463		516464S		516479	
FORD	1385593	FORD	1149802	HONDA	52370SJH010	SUBARU	20201AA030
FORD	1469024	FORD	1311416	HONDA	52370SWAA01	SUBARU	20201AA031
LAND ROVER	LR002624	JAGUAR	C2S39661S2	HONDA	52370SWAA10	SUBARU	20201FC130
							

516481		516482		516483		516489	
LAND ROVER	RGX000070	LAND ROVER	LR051611	LAND ROVER	LR001175	INFINITI	551A0AL500
LAND ROVER	RGX000071	LAND ROVER	RGX500101	LAND ROVER	LR001176		
		LAND ROVER	RGX500290	LAND ROVER	LR001182		
							

Cross References List And Photo

Photo.....

516490	516493	516494	516496
LAND ROVER RGD000060 LAND ROVER RGD000110 LAND ROVER RGX101020	LAND ROVER LR002576	HYUNDAI 545224B000 HYUNDAI 545504A000 MITSUBISHI MR112709	LAND ROVER LR054831 LAND ROVER RGX500111
			

516498	516502	516504	516505
LAND ROVER RGD000090 LAND ROVER RGX101000	NISSAN 545001AA1A NISSAN 545009N00A NISSAN 54500JA00B	LAND ROVER LR001184 LAND ROVER LR032308	LAND ROVER LR002575 LAND ROVER LR029576 LAND ROVER LR032308
			

516506	516509	516512	516514
LAND ROVER RGX000060	OPEL 4708299 SUZUKI 4520163J00 SUZUKI 4554063J00	MAZDA B45A28910B TOYOTA 4877042040 TOYOTA 4879042020	LEXUS 4870530100
			

Cross References List And Photo

Photo.....

516515		516516		516522		516536	
FORD	1540724	FORD	1540724	FORD	1377449	LEXUS	4806860040
FORD	1737305	FORD	1737305	FORD	1426770	LEXUS	4865460050
FORD	1737309	FORD	1737309	VOLVO	31262128		
							

516539		516541		516549		516550	
HYUNDAI	556004A600	INFINITI	551B01BA0A	MERCEDES-BENZ	A2513330814	INFINITI	545001BA3A
		NISSAN	551B0JL00A			INFINITI	545001CA0A
						NISSAN	54570EG002
							

516552		516553		516555		516556	
MERCEDES-BENZ	2043500553	MERCEDES-BENZ	2043500553	NISSAN	5512130R10	HYUNDAI	552154D000
MERCEDES-BENZ	2043500653	MERCEDES-BENZ	2043500653			HYUNDAI	552154D001
MERCEDES-BENZ	A2043500553	MERCEDES-BENZ	A2043500553			MITSUBISHI	4062A024
							

Cross References List And Photo

Photo.....

516557		516563		516565		516567	
HONDA	52371SL5000	MERCEDES-BENZ	A2043503306	DAIHATSU	48068BZ080	FORD	1234371
HONDA	52371SM4010			SUBARU	20204AJ010	FORD	1570284
HONDA	52371SM4A01			SUBARU	20204AJ020	MAZDA	B32H34300E
							

516573		516576		516579		516583	
HONDA	52390S5A980	HONDA	52395SH0A01	HONDA	51350S01G00	HONDA	51450S10010
HONDA	52390S5A981	HONDA	52395SH3004	HONDA	51350S10G00	HONDA	51450S10020
HONDA	52390S6MA00	HONDA	52395SH3005	HONDA	51360S04G00	HONDA	51450S30003
							

516587		516589		516591		516592	
HONDA	51393SL4004	HONDA	51455SR0003	HONDA	52350S10A00	HONDA	51450S04023
HONDA	51393SL5013	HONDA	51455SR3003	HONDA	52360S10A00	HONDA	51460S04023
HONDA	51393SV1A01	HONDA	51455SR3004	HONDA	52365SH3014	HONDA	51460S10020
							

Cross References List And Photo

Photo.....

516594		516595		516604		516606	
HONDA	52368SM1A01	HONDA	52350S1AE00	HONDA	51350SAAE01	MITSUBISHI	30851257
HONDA	52368SM4003			HONDA	51350SAAE11	MITSUBISHI	MB809262
HONDA	52368SM4004			HONDA	51360SAAE11	MITSUBISHI	MR102063
							





516607		516609		516610		516611	
MITSUBISHI	MB808910	MITSUBISHI	MR131913	MITSUBISHI	MB573524	MITSUBISHI	MR296095
MITSUBISHI	MR102654	MITSUBISHI	MR223570			MITSUBISHI	MR296096
VOLVO	30872511	MITSUBISHI	MR297950				
							

516612		516613		516614		516615	
MITSUBISHI	4013A209	MITSUBISHI	4110A075	MITSUBISHI	MR333422	CHRYSLER	MB864731
MITSUBISHI	4013A213	MITSUBISHI	MR508132	MITSUBISHI	MR369986	MITSUBISHI	MB864730
MITSUBISHI	MR510417	MITSUBISHI	MR519399			MITSUBISHI	MB864736
							

Cross References List And Photo

Photo.....



516617		516618		516628		516648	
MITSUBISHI	30620785	MITSUBISHI	MB892320	MAZDA	S24A34460	INFINITI	545002Y411
MITSUBISHI	MR491345	MITSUBISHI	MR162803	MAZDA	UB3934460B	INFINITI	545002Y412
MITSUBISHI	MR491346	MITSUBISHI	MR162804	MAZDA	UC8634460A	INFINITI	545012Y412
							

516652		516676		516684		516685	
INFINITI	551302J000	FORD	1954795	SUBARU	20201AA040	SUBARU	20201AA030
INFINITI	55130AD000	NISSAN	5504541G00	SUBARU	20201AC110	SUBARU	20201AC100
INFINITI	551360M000	NISSAN	5504641G00	SUBARU	20201FC130	SUBARU	20201FC120
							

516687		516688		516689		516698	
SUZUKI	4526165D00	SUZUKI	4526265D00	LEXUS	4806806010	TOYOTA	4865442010
SUZUKI	4526165D00000	SUZUKI	4526265D01	LEXUS	4865533030	TOYOTA	4865442020
SUZUKI	4526165D01	SUZUKI	4526265D01000	TOYOTA	4865507020		
							

Cross References List And Photo

Photo.....

516703		516704		516708		516709	
TOYOTA	4012032290	TOYOTA	4012032290	LEXUS	4806806070	TOYOTA	4806816040
TOYOTA	4551002171	TOYOTA	4424002050	TOYOTA	4806828120	TOYOTA	4806816060
		TOYOTA	4425001020	TOYOTA	4806833050	TOYOTA	4806916060
							

516710		516714		516773		516777	
LEXUS	4861029055	TOYOTA	4878012080	SUZUKI	4241265D00	TOYOTA	4881502110
LEXUS	4861029115	TOYOTA	4878020080	SUZUKI	4241270A00		
TOYOTA	4861059045	TOYOTA	4878020150	SUZUKI	4241284C00		
							

516779		516780		516781		516801	
HYUNDAI	5557726600	HYUNDAI	5481326000	SUZUKI	4241266D00	DAIHATSU	4881587401
		HYUNDAI	5481326100	SUZUKI	4241268D00	DAIHATSU	4881587401000
							

Cross References List And Photo

Photo.....

516811		516814		516815		516821	
TOYOTA	4881505170	CHRYSLER	04782681AB	CHRYSLER	04782684AB	HONDA	52316692010
TOYOTA	4881542090			CHRYSLER	4782684AB	MAZDA	071028775
TOYOTA	4881542110					NISSAN	54627HC000
							

516826		516828		516829		516832	
MAZDA	GA2A28156A	INFINITI	54613CG024	FORD	1959419	GENERAL MOTORS	09209466
MAZDA	GA2B34156	INFINITI	54613JK01A	NISSAN	546137F001	SUBARU	4245176G00
						SUZUKI	4245176G00000
							

516832S		516838		516839		516842	
CHEVROLET	9209466	MITSUBISHI	MR267649	MITSUBISHI	MB871062	MITSUBISHI	MB633239
							

Cross References List And Photo

Photo.....

517169		517171		517172		517177	
SEAT	6Q0411314E	VW	7H0411313	MERCEDES-BENZ	1243232485	FORD	1061626
SEAT	6Q0411314N			MERCEDES-BENZ	1243234185	FORD	1073217
SEAT	6Q0411314R			MERCEDES-BENZ	1243235685	FORD	98AG5484DA
							

517178		517179		517182		517214S	
FORD	1067976	FORD	1010037	OPEL	0350145	NISSAN	562600W001
FORD	1073249	FORD	1055191	OPEL	350145	NISSAN	5626041G11
FORD	98AG4A037BA	FORD	96FB3063AB	SAAB	9191188		
							

517231		517258		517261		517262	
HONDA	52400SNA900B	TOYOTA	4877005010	RENAULT	7701056678	FIAT	51803162
		TOYOTA	4877012010			OPEL	24434894
		TOYOTA	4877021011			SAAB	13320276
							

Cross References List And Photo

Photo.....

517263		517269		517271		517272	
HYUNDAI	545511E000	MERCEDES-BENZ	1243260081	SUBARU	20401AA020	SUBARU	20401FA000
KIA	545512K000	MERCEDES-BENZ	1243260181			SUBARU	20464FE060
							

517273		517274		517277		517278	
SUBARU	20414AG020	SUBARU	20401AC031	SUBARU	20464AE060	SUBARU	20464FG000
SUBARU	20414AG030	SUBARU	20414SA000				
SUBARU	20414AG070						
							

517279		517300		517301		517302	
SUBARU	20464SC010	HONDA	51306TLOG01	HONDA	51307TLOG01	HONDA	52306S6D005
							

Cross References List And Photo

Photo.....

517303		517304		517305		517306	
HONDA	52306TA0A02	HYUNDAI	545512S000	HYUNDAI	545842S000	INFINITI	54613CG006
HONDA	52306TA1A01	HYUNDAI	545512Y000	HYUNDAI	545842S100		
HONDA	52306TA1A02			HYUNDAI	545843S000		
							

517307		517310		517312		517313	
NISSAN	546133UB0A	KIA	5481207100	HYUNDAI	548121G100	KIA	548132F000
NISSAN	54613JD03A	KIA	5481207200	KIA	548131H100	KIA	548132F100
NISSAN	54613JG02A						
							

517314		517317		517319		517320	
HYUNDAI	548132S000	KIA	548303E020	HYUNDAI	555132B000	HYUNDAI	555132E000
				HYUNDAI	555132B200	KIA	555130Z000
						KIA	555132E100
							

Cross References List And Photo

Photo.....

517321		517322		517328		517330	
KIA	555132F000	KIA	555132Y001	mitsubishi	MR272717	TOYOTA	4881542030
KIA	555132F100						
							





517333		517337		517340		517342	
NISSAN	545700W020	HONDA	51360S04G00	HONDA	52393SK7004	TOYOTA	4871033070
NISSAN	5457052F10			HONDA	52393SR0004		
NISSAN	545960W001			HONDA	52393SR3004		
							

517343S		517345		517347		517348	
TOYOTA	4870033100	FORD	1748361	FORD	1128483	FORD	1116602
TOYOTA	4874033080	FORD	3C115484CA	FORD	1522130	FORD	1118695
		FORD	3C115484CB	FORD	C2S39661S1	FORD	1307891
							

Cross References List And Photo

Photo.....

517351	517352	517353	517356
GENERAL MOTORS 13131231 OPEL 0350148 OPEL 0350159	BMW 33326774796	BMW 33326777424	BMW 31351135805
			



517357	517363	517364	517365
BMW 31351095271	TOYOTA 4806802030 TOYOTA 4806805070 TOYOTA 4806905070	TOYOTA 4806842050 TOYOTA 4806942050 TOYOTA 4865542060	HONDA 51398SMGE01
			

517366	517367	517368	517369
FIAT 1352225080 FIAT 1352226080 FIAT 1352227080	FIAT 1352225080 FIAT 1352226080 FIAT 1352227080	CITROËN 5094C6 MITSUBISHI 4056A079	MITSUBISHI 4056A049 MITSUBISHI 4056A078
			

Cross References List And Photo

Photo.....

517370		517390		517449		517450	
CITROËN	517258	FORD	1702970	DAIHATSU	9004385149	TOYOTA	4874016080
MITSUBISHI	4156A028	MAZDA	3M513063CB				
		MAZDA	B32H34350S				
							

517451		517469		517477		517478	
HONDA	53685S1AE01	AUDI	7L0407182D	MERCEDES-BENZ	2123330014	BMW	31126756064
		AUDI	7L0407182F	MERCEDES-BENZ	A2123330014	BMW	31126757623
		AUDI	7L0407182G			BMW	31126757623R
							



517479		517484		517496		517516	
BMW	31126756063	CITROËN	3520W1	MERCEDES-BENZ	2203201589	NISSAN	5461343G00
BMW	31126757623	CITROËN	3521S4	MERCEDES-BENZ	A2203201589		
BMW	31126757623L	CITROËN	3523AQ				
							

Cross References List And Photo

Photo.....

517527		517543		517544		517546	
TOYOTA	4881506040	HONDA	51306SR3000	HYUNDAI	54816H1000	HYUNDAI	55816H1000
		HONDA	51306SR3010	HYUNDAI	54816H1100		
							





517547		517549		517552		517554	
HONDA	51381S1AE01	HONDA	53685SL5000	MITSUBISHI	MR150092	MITSUBISHI	MN103392
						MITSUBISHI	MR151327
							

517564		517567		517569		517571	
MITSUBISHI	MR130896	MITSUBISHI	MR316227	MITSUBISHI	MR244116	MITSUBISHI	MB109219
						MITSUBISHI	MR133706
							

Cross References List And Photo

Photo.....













517572		517573		517578		517583	
SUBARU	20401AC010	SUZUKI	4664160G10	IVECO	008581021	HONDA	90112SE0000
SUBARU	20401AC011	SUZUKI	4664160G30	IVECO	08581021	HONDA	90112SK7000
				IVECO	8581021	ROVER	EAP7170
							

517584		517586		517587		517590	
HONDA	90112SM4000	IVECO	0093801623	IVECO	0093803960	NISSAN	54423B9500
HONDA	90112SM4020	IVECO	093801623	IVECO	093803960		
HONDA	90112SM4020S1	IVECO	93801623	IVECO	93803960		
							

517591		517592		517596		517600	
HONDA	52370S04000	HONDA	52343SH3004	mitsubishi	4410A166	IVECO	0093802629
HONDA	52385SK7N02	HONDA	52343SK7003			IVECO	093802629
HONDA	52385ST3G01	HONDA	52343SK7004			IVECO	93802629
							

Cross References List And Photo

Photo.....

517629	517633	517667	517672													
MERCEDES-BENZ 1683330214 MERCEDES-BENZ 1683330614 MERCEDES-BENZ A1683330214	<table border="0"> <tr> <td> <table border="0"> <tr> <td>MITSUBISHI</td> <td>4056A121</td> </tr> <tr> <td>MITSUBISHI</td> <td>MR554271</td> </tr> </table> </td> <td> <table border="0"> <tr> <td>HONDA</td> <td>52315SR3000</td> </tr> </table> </td> <td> <table border="0"> <tr> <td>MITSUBISHI</td> <td>MR171441</td> </tr> </table> </td> </tr> <tr> <td></td> <td></td> <td></td> <td></td> </tr> </table>	<table border="0"> <tr> <td>MITSUBISHI</td> <td>4056A121</td> </tr> <tr> <td>MITSUBISHI</td> <td>MR554271</td> </tr> </table>	MITSUBISHI	4056A121	MITSUBISHI	MR554271	<table border="0"> <tr> <td>HONDA</td> <td>52315SR3000</td> </tr> </table>	HONDA	52315SR3000	<table border="0"> <tr> <td>MITSUBISHI</td> <td>MR171441</td> </tr> </table>	MITSUBISHI	MR171441				
<table border="0"> <tr> <td>MITSUBISHI</td> <td>4056A121</td> </tr> <tr> <td>MITSUBISHI</td> <td>MR554271</td> </tr> </table>	MITSUBISHI	4056A121	MITSUBISHI	MR554271	<table border="0"> <tr> <td>HONDA</td> <td>52315SR3000</td> </tr> </table>	HONDA	52315SR3000	<table border="0"> <tr> <td>MITSUBISHI</td> <td>MR171441</td> </tr> </table>	MITSUBISHI	MR171441						
MITSUBISHI	4056A121															
MITSUBISHI	MR554271															
HONDA	52315SR3000															
MITSUBISHI	MR171441															
																

517673	517674	517681	517748										
<table border="0"> <tr> <td>MITSUBISHI</td> <td>MR150093</td> </tr> </table>	MITSUBISHI	MR150093	<table border="0"> <tr> <td>MITSUBISHI</td> <td>MB809437</td> </tr> </table>	MITSUBISHI	MB809437	<table border="0"> <tr> <td>VOLVO</td> <td>30666394</td> </tr> <tr> <td>VOLVO</td> <td>31277896</td> </tr> </table>	VOLVO	30666394	VOLVO	31277896	<table border="0"> <tr> <td>KIA</td> <td>545842F000</td> </tr> </table>	KIA	545842F000
MITSUBISHI	MR150093												
MITSUBISHI	MB809437												
VOLVO	30666394												
VOLVO	31277896												
KIA	545842F000												
													





517758	517760	517761	517762																						
<table border="0"> <tr> <td>BMW</td> <td>33321090031</td> </tr> <tr> <td>BMW</td> <td>33326755471</td> </tr> <tr> <td>BMW</td> <td>33326755472</td> </tr> </table>	BMW	33321090031	BMW	33326755471	BMW	33326755472	<table border="0"> <tr> <td>CITROËN</td> <td>3520Y5</td> </tr> <tr> <td>MITSUBISHI</td> <td>4013A045</td> </tr> <tr> <td>MITSUBISHI</td> <td>MR316074</td> </tr> </table>	CITROËN	3520Y5	MITSUBISHI	4013A045	MITSUBISHI	MR316074	<table border="0"> <tr> <td>CHRYSLER</td> <td>05105270AA</td> </tr> <tr> <td>JEEP</td> <td>05105270AB</td> </tr> <tr> <td>MITSUBISHI</td> <td>4110A033</td> </tr> </table>	CHRYSLER	05105270AA	JEEP	05105270AB	MITSUBISHI	4110A033	<table border="0"> <tr> <td>MITSUBISHI</td> <td>4125A020</td> </tr> <tr> <td>MITSUBISHI</td> <td>MR403570</td> </tr> </table>	MITSUBISHI	4125A020	MITSUBISHI	MR403570
BMW	33321090031																								
BMW	33326755471																								
BMW	33326755472																								
CITROËN	3520Y5																								
MITSUBISHI	4013A045																								
MITSUBISHI	MR316074																								
CHRYSLER	05105270AA																								
JEEP	05105270AB																								
MITSUBISHI	4110A033																								
MITSUBISHI	4125A020																								
MITSUBISHI	MR403570																								
																									

Cross References List And Photo

Photo.....

517763		517763S		517765		517766	
SUBARU	20252FG000	SUBARU	20252FG000	BMW	33321090031	CHRYSLER	05168158AA
				BMW	33326755471	MERCEDES-BENZ	A1643301707
				BMW	33326755472	MERCEDES-BENZ	A1643303407
							

517771		517773		517775		517776	
TOYOTA	4876005010	MERCEDES-BENZ	2513300707	MERCEDES-BENZ	1643330414	MERCEDES-BENZ	1643330314
TOYOTA	4876012010	MERCEDES-BENZ	2513300807	MERCEDES-BENZ	1663330200	MERCEDES-BENZ	A1643330314
TOYOTA	4878005030	MERCEDES-BENZ	A2513330114	MERCEDES-BENZ	1663330414		
							

517779		517781		517785		517786	
FIAT	71740113	BMW	31351093263	HONDA	52315S10A01	TOYOTA	4881505160
GENERAL MOTORS	024457386	BMW	31351093794			TOYOTA	4881542100
OPEL	0444161					TOYOTA	4881542120
							

Cross References List And Photo

Photo.....





517793S		517794		517795		517797	
TOYOTA	4873033080	TOYOTA	488180R010	FORD	1102950	FORD	1405532
		TOYOTA	4881842010	FORD USA	YS713063AA	FORD	1453257
						FORD	1469020
							

517800		517802		517804		517805	
FORD	4041490	BMW	33326470859	BMW	0305612	BMW	31303404065
FORD	YC155484BD	BMW	33326470860	BMW	31120305612		
		BMW	33326767831	BMW	31126767992		
							

517806		517807		517809		517812	
AUDI	4D0411327J	AUDI	4B0511327	MERCEDES-BENZ	1243528665	AUDI	701411041C
AUDI (FAW)	L4D0411327J			MERCEDES-BENZ	2103503306	VW	701411041D
				MERCEDES-BENZ	2103520965		
							

Cross References List And Photo

Photo.....





517815		517817		517820		517821	
DACIA	8200852550	HONDA	51450S0A003	TOYOTA	4881812170	HYUNDAI	548133K100
NISSAN	546114237R	HONDA	51450S1AE01	TOYOTA	4881833100	HYUNDAI	548134H000
		HONDA	51460S1AE01	TOYOTA	4881833101	KIA	548133K000
							





517822		517823		517824		517825	
HYUNDAI	555132C300	NISSAN	54613CA000	NISSAN	54613CA006	SUBARU	20401FA020
HYUNDAI	555132G100	NISSAN	54613CC48A	NISSAN	54613CA00A	SUBARU	20401FA021
						SUBARU	21047GA821
							

517832		517835		517838		517842	
HONDA	52306S0A015	HONDA	51810SM4003	BMW	31126760181	TOYOTA	4865587401
HONDA	52306SDAA01	HONDA	51810SM4004				
HONDA	52306SDBA02	HONDA	51810SN7000				
							

Cross References List And Photo

Photo.....

517870	517914	517969	517974
MERCEDES-BENZ 1683301707 MERCEDES-BENZ 1683330014 MERCEDES-BENZ 1683330714	FORD 1477858 FORD 1477858S1 FORD 3M5J3A262BP	MERCEDES-BENZ 2043306711 MERCEDES-BENZ 2043306711S1 MERCEDES-BENZ 2043330414	AUDI 8R0407515
			





517996	517997	518051	518059
CHRYSLER 68012169AA VW 2E0407523 VW 2E0407523A	BMW 31356753928 BMW 31356761591 BMW 31356766509	VW 7H5411313B	MERCEDES-BENZ 9063231485 VW 2E0411041C VW 2E0411041E
			

518072	518073	518074	518086
CHRYSLER 05104073AA MERCEDES-BENZ 9013260081 VW 2D0511413A	BMW 31121136532 BMW 31121139790	BMW 31121126256 BMW 31121136531 BMW 31121139789	VW 2H0407021B VW 2H0407021BSK VW 2H0407077A
			

Cross References List And Photo

Photo.....





518087		518088		518115		518119	
VW	2H0407151A	VW	2H0407151A	AUDI	6R0407181B	MERCEDES-BENZ 2113308107	
VW	2H0407151ASK	VW	2H0407151ASK	AUDI	8N0407181B	MERCEDES-BENZ 2113308207	
VW	2H0412333A	VW	2H0407182A			MERCEDES-BENZ 2113331914	
							





518120		518122		518959		519041	
MERCEDES-BENZ 2113331114		AUDI	7L0511413C	KIA	0K2A13446X	NISSAN 5447601W00	
MERCEDES-BENZ 2303330614		AUDI	7L0511413E				
MERCEDES-BENZ 2303330614S1		PORSCHE	95533379250				
							

519053		519066		519067		519241	
AUDI	4H0407515	ALFA ROMEO	50706954	ALFA ROMEO	50706955	SUBARU	20481AA000
AUDI	4H0407515A	ALFA ROMEO	50708721	ALFA ROMEO	50708722	SUBARU	20481AA001
AUDI	4H0407515B			ALFA ROMEO	51795446		
							

Cross References List And Photo

Photo.....

519279		519335		519357		519360	
VOLVO	6819057	FIAT	46738807	BMW	31356765574	BMW	31351094556
		FIAT	46738808			BMW	31351096061
		FIAT	46790552				
							

519361		519364		519452S		519558	
BMW	31351093108	BMW	31124012193	MERCEDES-BENZ	0140320104	VOLVO	013595996
		BMW	31126757551	MERCEDES-BENZ	1243200147	VOLVO	1229297
		BMW	31126767530	MERCEDES-BENZ	A1243200147	VOLVO	1229299
							

519624		519635		519641S		519652	
JEEP	52003918	JEEP	52003636	JEEP	52037830	CHRYSLER	68002123AB
JEEP	52007118			JEEP	52087720		
				JEEP	52088167		
							

Cross References List And Photo

Photo.....

519661		519687		519697		519941	
CHRYSLER	68002123AB	DODGE	52088634AB	HYUNDAI	5513038000	DODGE	52001161
		JEEP	89050294	HYUNDAI	5513038002	DODGE	52002539
						DODGE	52037882
							

519971		520008		520010		520093	
VOLVO	30645847	AUDI	8D0411317D	AUDI	8D0411318D	BMW	1131131
VOLVO	31201003	AUDI	8D0411506K			BMW	33551131131
VOLVO	31304040					BMW	33551135307
							

520376		520378		520379		520398	
MITSUBISHI	4056A138	FORD	1500682	INFINITI	551200M000	HONDA	51312SD4020
		FORD	1719542	NISSAN	551200M001		
		FORD	8M515E494AB	NISSAN	551202J000		
							

Cross References List And Photo

Photo.....

520473		520523		520524		520525	
INFINITI	551202Y000	AUDI	8E0411317	AUDI	8E0411318	VW	701411049
						VW	7D0411049
							

520526		530005		530066		530131	
AUDI	4D0411317G	MITSUBISHI	4125A006	TOYOTA	4872520070	MERCEDES-BENZ	9063231685
AUDI	4D0411317J					VW	2E0407473E
AUDI	4D0411317K					VW	2E0411041F
							

530133		530158		530166		530168	
MERCEDES-BENZ	2113332914	BMW	31106778015	LAND ROVER	RBX500431	MERCEDES-BENZ	1643231185
MERCEDES-BENZ	A2113332914	BMW	31126863171	LAND ROVER	RBX500432	MERCEDES-BENZ	1643231185S1
		BMW	6778015			MERCEDES-BENZ	A1643231185
							

Cross References List And Photo

Photo.....



530183		530193		530196		530199	
AUDI	1K0511327AQ	VOLVO	1205991	AUDI	4A0399413A	AUDI	1K0511327AE
						AUDI	1K0511327AP
						VW	1K0511327BA
							

530201		530206		530207		530212	
VOLVO	1229608	AUDI	4A0511249	AUDI	443511523B	VW	251501131A
				AUDI	4D0511523A		
				AUDI	4D0511523B		
							

530214		530215		530221		530226	
AUDI	8K0407183A	AUDI	8K0407182A	VW	7D1411041	VW	7H0407182
AUDI	8K0407183B	AUDI	8K0407182B				
		AUDI	8K0407182C				
							

Cross References List And Photo

Photo.....





530227		530227S		530229		530232	
VW	7L0411313H	AUDI	7L0411313G	AUDI	8Z0411314B	MERCEDES-BENZ	2023338714
		AUDI	7L0411313H			MERCEDES-BENZ	A2023338714
		VW	7L0411313HS1				
							

530236		530238		530239		530244	
CHRYSLER	05118801AA	MERCEDES-BENZ	1693330014	BMW	33536765584	FORD	1041683
CHRYSLER	5118801AA	MERCEDES-BENZ	A1693300707			FORD	6829045
MERCEDES-BENZ	9043261081	MERCEDES-BENZ	A1693330014			FORD USA	93BB5K653AB
							

530247		530248		530253		530254	
FORD	1540724S1	FORD	6769035	VOLVO	3411810	VOLVO	1229399
		FORD	6829046			VOLVO	1329655
		FORD	93BB5K792AB				
							

Cross References List And Photo

Photo.....

530255		530255S		530256		530256S	
VOLVO	3530202	VOLVO	3530202	VOLVO	3516496	VOLVO	3516496
VOLVO	9181013	VOLVO	9181013	VOLVO	3616496	VOLVO	9181027
							

530257		530258		530259		530261	
VOLVO	3350052	VOLVO	1273184	VOLVO	30620972	VOLVO	8630605
VOLVO	3530050			VOLVO	30818103		
VOLVO	3530051						
							

530268		530502		530504		530508	
ALFA ROMEO	55703232	MITSUBISHI	4056A121	MERCEDES-BENZ	2043502106	FORD	1387624
OPEL	0352947	MITSUBISHI	4056A219	MERCEDES-BENZ	2043502206	FORD	1405523
OPEL	352947	MITSUBISHI	MR554271	MERCEDES-BENZ	2043520365	VOLVO	30748926
							

Cross References List And Photo

Photo.....

530511		530512		530518		530523	
TOYOTA	4872042020	LEXUS	4872060070	NISSAN	555017S001	FORD	1377447
TOYOTA	4872542070	SSANGYONG	4551334000	NISSAN	55501ZC30A	FORD	1421954
		TOYOTA	4870260140	NISSAN	555027S001	FORD	1469125
							

530524		530527		530528		530529	
FORD	1377447	CHRYSLER	04743244AA	MERCEDES-BENZ	A4603330314	HYUNDAI	545843X000
FORD	1421954	MERCEDES-BENZ	A2043502706			KIA	545841J000
FORD	1469125	MERCEDES-BENZ	A2043530043			KIA	545844L000
							





530530		530532		530541		530553	
AUDI	3C0505541	AUDI	7L0411313K	TOYOTA	4807542050	FORD	1387629
		AUDI	7L8411313B	TOYOTA	4807642050	FORD	1457609
		PORSCHE	95534379261			FORD	1509830
							

Cross References List And Photo

Photo.....

530559		530560		530569		530589S	
FORD	1469024	FORD	1469026	FORD	1508128	TOYOTA	4882028030
FORD	1507181	FORD	1507182	FORD	1566810		
VOLVO	31200775	VOLVO	31200776	FORD	1566837		
							

530590S		530602		530621		530682	
LEXUS	4882033010	HYUNDAI	5455129000	HONDA	51392SNA903	HYUNDAI	545003L000
TOYOTA	4882002010	HYUNDAI	5455129010	HONDA	51392TR0305	HYUNDAI	545523K000
						HYUNDAI	545523K600
							

530731		530744		530751S		530752S	
HONDA	51350SWAE01B	TOYOTA	4881526090	BMW	31121136531	BMW	31121095277
		TOYOTA	4881526220	BMW	31121136531S1	BMW	31121096983
		TOYOTA	4881526221	BMW	31121136532	BMW	31126757623
							

Cross References List And Photo

Photo.....



530787	530789	530810	530811
MITSUBISHI MB109557	HONDA 52364SH0A01 HONDA 52365SH3000	HYUNDAI 552752S000 HYUNDAI 552752S001	HYUNDAI 552742S000 HYUNDAI 552742S001
			

530812	530813	530814	530815
HYUNDAI 552742S800 HYUNDAI 552743W000	HYUNDAI 552752S800 HYUNDAI 552753W000	HYUNDAI 552152S200 HYUNDAI 552162S200	HYUNDAI 552152S000 HYUNDAI 552153Q000 HYUNDAI 552153R000
			

530816	530817	530829	530830
HYUNDAI 551182S100 KIA 551182Y100	VOLVO 30639368 VOLVO 31277881	RENAULT 7700819928 RENAULT 7700831364 RENAULT 8200651168	RENAULT 7700819929 RENAULT 7700820921 RENAULT 8200651164
			

Cross References List And Photo

Photo.....

530846		530847		530889		530890	
PEUGEOT	509488	VOLVO	9461625	RENAULT	545009207R	RENAULT	545009207R
PEUGEOT	5094E0	VOLVO	9492181	RENAULT	545009207RSK	RENAULT	545009207RSK
				RENAULT	545600005R	RENAULT	545600004R
							

530899		530937		530969		530970	
PEUGEOT	509482	CHRYSLER	4721483AD	MERCEDES-BENZ	2033260181	MERCEDES-BENZ	2033260281
		CHRYSLER	4721484AD	MERCEDES-BENZ	A2033260181	MERCEDES-BENZ	A2033260281
		CHRYSLER	4766910AE				
							

530971		530972		530973		530993	
BMW	31351094554	MERCEDES-BENZ	2033260381	MERCEDES-BENZ	2033231685	FIAT	46748578
BMW	31351094555	MERCEDES-BENZ	A2033260381	MERCEDES-BENZ	2033232285	FIAT	46794066
				MERCEDES-BENZ	A2033232285	FIAT	51769074
							

Cross References List And Photo

Photo.....

530998		530999		531006		531191	
FIAT	46450462	FIAT	46450461	ALFA ROMEO	7544738	NISSAN	545242S486
						NISSAN	545422S610
							

531423		531431		531449		531450	
SKODA	1K0407183M	AUDI	5Q0407183D	MERCEDES-BENZ	1663330100	MERCEDES-BENZ	2043331114
SKODA	1K0407183P	AUDI	5Q0407183E	MERCEDES-BENZ	1663330214	MERCEDES-BENZ	A2043331014
SKODA	5C0407183A	SEAT	5Q0407183G	MERCEDES-BENZ	A1663330100	MERCEDES-BENZ	A2043331114
							

531451		531452		531454		531455S	
MERCEDES-BENZ	2043308011	MERCEDES-BENZ	2123330514	MERCEDES-BENZ	2043520865	MERCEDES-BENZ	1243235685
MERCEDES-BENZ	2123330214	MERCEDES-BENZ	A2123330514	MERCEDES-BENZ	A2043520865	MERCEDES-BENZ	1243235685S1
							

Cross References List And Photo

Photo.....

531456S	531459	531494	531501
MERCEDES-BENZ 2023230285 MERCEDES-BENZ 2023230285S1	MERCEDES-BENZ A9063260381 MERCEDES-BENZ A9063260781 VW 2E0511413C	MITSUBISHI MB573524	MAZDA BC1F3446X
			





531502	531505	531506	531525
MAZDA BC1F3446Y	MAZDA GA2A3446XA MAZDA GA2A3446XB MAZDA GA2A3446XC	MAZDA GA2A3446YA MAZDA GA2A3446YB MAZDA GA2A3446YC	NISSAN 54560EB70A
			

531545S	531650	531686	531687
LEXUS 4420035051 LEXUS 4420035061	FIAT 46748579 FIAT 46777741 FIAT 46777741SK	FORD 1727222 FORD USA AB313068BB MAZDA UC3C34470A	FORD 1735761 FORD USA AB313A493BB MAZDA UC3C34450A
			

Cross References List And Photo

Photo.....



531735		531748		531775		531779	
KIA	0K2A13446Y	PEUGEOT	5094C2	CITROËN	509491	KIA	545803E200
							

531805		531832		531849S		531927	
GENERAL MOTORS	22980140	HYUNDAI	548132Y000	BMW	31121096982	BMW	31106771897
GENERAL MOTORS	22980140R			BMW	31121096983	BMW	31126855509
				BMW	31126750057		
							

531928		531929		531930		531931	
BMW	31106771194	AUDI	4G0407183	AUDI	4H0407182	AUDI	8K0407183
		AUDI	4G0407183A	AUDI	4H0407182B	AUDI	8K0407183D
		AUDI	4H0407183	AUDI	4H0407182C	AUDI	8K0407183F
							

Cross References List And Photo

Photo.....

531934		531935		531936		531937	
BMW	31106784569	BMW	31126775971	BMW	31126763699	MERCEDES-BENZ 1643302507S1	
BMW	31126784569	BMW	31126775971SK	BMW	31126770849	MERCEDES-BENZ 1643302607	
BMW	31126794204	BMW	31126775972	BMW	31126770850	MERCEDES-BENZ 1643302907	
							

531938		531939		531944		531951	
BMW	31124083313	BMW	31120410791	JAGUAR	C2C15234	ALFA ROMEO 60686891	
BMW	31126775145	BMW	31126768818	JAGUAR	C2C26261		
BMW	4083313			JAGUAR	C2C39683		
							





531954		531998		532001		532033	
AUDI	4E0407182B	NISSAN	54613EB71A	TOYOTA	486320K040	FIAT 7603476	
AUDI	4E0407182C			TOYOTA	4863234010		
							

Cross References List And Photo

Photo.....

532161		532335		532353		532354	
MITSUBISHI	MB809262	RENAULT	7700789477	CHRYSLER	4764453AA	CHRYSLER	4616736
VOLVO	30851257	RENAULT	8200651169				
VOLVO	30871221						
							

532355		532407		532412		532420	
CHRYSLER	4764456AA	NISSAN	545001AA1A	HONDA	51350SWAE01S	NISSAN	54500JN00A
		NISSAN	54560JP00B			NISSAN	54560JP00B
						CHRYSLER	4764456AA
							

532427		532429		532430		532431	
CHRYSLER	5085889AA	LEXUS	4807530020	LEXUS	4807630020	TOYOTA	4865542040
CHRYSLER	5273731AB	LEXUS	4807553010	LEXUS	4807653010		
		LEXUS	4807553020	LEXUS	4807653020		
							

Cross References List And Photo

Photo.....

532432		532433		532435		532436	
TOYOTA	4881548070	NISSAN	545608H300	HONDA	51395SWAE00	HONDA	51396SWAE00
				HONDA	51395SWAE01	HONDA	51396SWAE01
				HONDA	51395SWAE02	HONDA	51396SWAE02
							

532478		532572		532578		532579	
MERCEDES-BENZ	1663260281	BMW	006775980	AUDI	8K0411327A	AUDI	8K0411327B
MERCEDES-BENZ	A1643260681	BMW	006791455				
MERCEDES-BENZ	A1663260281	BMW	31126775980				
							





532581		532583		532624		532625	
BMW	31106786951	BMW	31106786959	FORD	1566810	FORD	1566837
BMW	31106787673	BMW	31106857329	FORD	6G915K896BA	FORD	6G915A969FNJ
BMW	31106787674	BMW	31106857330	VOLVO	31387281	VOLVO	31406337
							

Cross References List And Photo

Photo.....

532626S		532648		532662S		532745	
CITROËN	3520X6	HONDA	52393SH3004	SUBARU	20252XA00A	MITSUBISHI	MB891518
CITROËN	3521T7			SUBARU	20252XA01A		
							

532746		532749		532764		532767	
MITSUBISHI	MB864699	NISSAN	54613EB71B	TOYOTA	4881848060	TOYOTA	4881528210
MITSUBISHI	MR297500						
							

532769		532779		532780		532786	
TOYOTA	488150K050	MITSUBISHI	MR151326	MITSUBISHI	MR403082	NISSAN	4241278K00
		MITSUBISHI	MR267649				
							

Cross References List And Photo

Photo.....

532789		532790		532866		532867	
TOYOTA	4865550011	TOYOTA	4872530230	MERCEDES-BENZ	2463330014	MERCEDES-BENZ	2463330200
TOYOTA	4865550012	TOYOTA	4873030080	MERCEDES-BENZ	2463330100	MERCEDES-BENZ	2463330214
				MERCEDES-BENZ	A2463330014	MERCEDES-BENZ	A2463330200
							

532971		532973		532976		532977	
CHRYSLER	04743238AA	ALFA ROMEO	K52088214	LAND ROVER	LR023715	LAND ROVER	LR051585
MERCEDES-BENZ	1643501306	CHRYSLER	52088214	LAND ROVER	LR025986	LAND ROVER	RBX500311
MERCEDES-BENZ	1643501406			LAND ROVER	LR073366		
							

532978		533085		533395		533398	
CITROËN	5175CG	TOYOTA	4872530350	AUDI	8K0411327C	AUDI	7P0407077
CITROËN	5175CN					PORSCHE	95834105100
CITROËN	5175CP						
							

Cross References List And Photo

Photo.....

533443	533444	533477	533478
PEUGEOT 509460	PEUGEOT 509459	AUDI 8K0501529K AUDI 8K0501529L AUDI 8K0501529N	AUDI 4E0407183A AUDI 4E0407183B AUDI 4E0407183H
			

533480	533481	533482	533483
MERCEDES-BENZ 2043502106 MERCEDES-BENZ 2043502206 MERCEDES-BENZ 2043521465	MERCEDES-BENZ 2053306101 MERCEDES-BENZ 2053306201 MERCEDES-BENZ 2053330214	MERCEDES-BENZ 2053306101 MERCEDES-BENZ 2053306201 MERCEDES-BENZ 2053332200	BMW 31126851255 BMW 31126851261 BMW 31126855743
			

533502	533511	533513	533520
AUDI 8J0199231	BMW 31126864000 BMW 31126864821 BMW 31126864822	BMW 31106861169 BMW 31106861170 BMW 31126861156	CITROËN 9676035280 CITROËN 9800596580 PEUGEOT 9807892380
			

Cross References List And Photo

Photo.....

533521		533522		533523		533527	
CITROËN	5094A6	AUDI	4N0407515	BMW	31126863333	HONDA	52510TA0A02
		AUDI	8W0407515	BMW	31126863334	HONDA	52510TL0E01
				BMW	31126863787	HONDA	52520TA0A01
							

533862		533863		533876		533897	
AUDI	1K0199231N	AUDI	1K0199232N	HYUNDAI	545513X000	PEUGEOT	3520Y0
						PEUGEOT	3521V1
						PEUGEOT	9677547880
							

533901		533902		533910		533918	
AUDI	4M0407515A	BMW	31126851693	LAND ROVER	RGX000080	LAND ROVER	LR051621
						LAND ROVER	RGX500131
						LAND ROVER	RGX500300
							

Cross References List And Photo

Photo.....

533928	533949	535006	535008
LAND ROVER LR084108 LAND ROVER LR100072 LAND ROVER LR148836	LAND ROVER LR063744 LAND ROVER RGX500200 LAND ROVER RGX500201	TOYOTA 488150K090	HONDA 51306TE1A01
			





535009	535010	535016	535104
FORD 1728257 FORD AB315484BB MAZDA UC3C34156A	TOYOTA 488180R030 TOYOTA 4881812290 TOYOTA 4881842020	CHRYSLER 04782613AD CHRYSLER 04782613ADSK CHRYSLER 05180607AA	HONDA 52340TA0A00 HONDA 52345TA0A00
			





535105	535106	535107	535108
HONDA 52340TA0A00 HONDA 52345TA0A00	HONDA 52370TA0A00 HONDA 52370TL0E00 HONDA 52375TA0A00	HONDA 52210TA0A00 HONDA 52210TC0T00 HONDA 52210TL0G50	HONDA 52210TA0A00 HONDA 52210TC0T00 HONDA 52210TL0G50
			

Cross References List And Photo

Photo.....

535115		535123		535135		535136	
HONDA	51450S84A01	CHEVROLET	96626425	SSANGYONG	4451709000	SSANGYONG	4451809000
HONDA	51460S84A01	OPEL	4804807	SSANGYONG	4451709001		
							





535137		535142		535143		535150	
SSANGYONG	4455209000	MINI	31126772235	MINI	31126772236	AUDI	7H0511414
SSANGYONG	4455209001						
SSANGYONG	4455209002						
							

535155		535156		535157		535169	
VW	7H5411313A	TOYOTA	486550K080	TOYOTA	486540K080	MERCEDES-BENZ	1663300243
						MERCEDES-BENZ	A1663300243
							

Cross References List And Photo

Photo.....

535170		535176		535186		535187K	
VW	7H5511413B	HYUNDAI	555133N200	HYUNDAI	548133S110	AUDI	3C0411303AA
						AUDI	3C0411303T
							

535196		535219		535221		535223	
LEXUS	4881550200	HONDA	51396T0AE01	HONDA	51395T0AE01	NISSAN	545019W50A
							

535259		535261		535262		535264	
CITROËN	3523CZ	MERCEDES-BENZ	2463501006	HYUNDAI	552502S100	CITROËN	3523EC
CITROËN	3523EA	MERCEDES-BENZ	A2463501006			CITROËN	3523EE
PEUGEOT	9670771480					PEUGEOT	9670771480
							

Cross References List And Photo

Photo.....

535266	535282	535283	535302
MERCEDES-BENZ 2463500053 MERCEDES-BENZ A2463500053	LAND ROVER LR018343 LAND ROVER RBJ000120 LAND ROVER RBX000200	BMW 33503404616	BMW 33556761002
			

535304	535305	535306	535307
BMW 33556766510	BMW 33556761360	BMW 31303413134	BMW 33556761001
			

535309	535310	535313	535314
VW 5Q0501529C VW 5Q0505543B	MERCEDES-BENZ 2463330114 MERCEDES-BENZ A2463330114	AUDI 8N0407182A	BMW 31106861185 BMW 31106864374 BMW 31126870025
			

Cross References List And Photo

Photo.....

535315		535342		535395		535411	
VW	7H5511414A	AUDI	1K0199231N	CITROËN	9800596580	MERCEDES-BENZ	2053305801
		AUDI	1K0199232N			MERCEDES-BENZ	A2053305801
		AUDI	8J0407183			MERCEDES-BENZ	A2053333800
							

535418		535437		535451		535452	
MERCEDES-BENZ	2053305801	VW	7H5511413C	NISSAN	54613AL524	HYUNDAI	54813C1100
MERCEDES-BENZ	A2053305801						
							

535456		535460		535464		535465	
MERCEDES-BENZ	2053301605	SUBARU	20204AG000	HYUNDAI	55215A2000	HYUNDAI	551183R000
MERCEDES-BENZ	2053301705	SUBARU	20204AJ000	HYUNDAI	55215A6100		
MERCEDES-BENZ	2053301805						
MERCEDES-BENZ	A2053301605						
MERCEDES-BENZ	A2053301705						
MERCEDES-BENZ	A2053301805						
							

Cross References List And Photo

Photo.....

535629		535630		540008		540009	
BMW	33556788058	BMW	31126850403	HONDA	53534SR3N52	HONDA	53534SV1003
		BMW	31126874341			HONDA	53537SA5000
		BMW	31126882843			HONDA	53537SH3000
							

540012S		540016		540021		540022	
HONDA	53537SH3000	SEAT	171419831B	AUDI	431419831	BMW	32111127104
		SEAT	6N0419831	VW	823419831		
		SEAT	6N0419831A				
							

540034		540040		540041		540043	
TOYOTA	4553512040	HONDA	53534S30003	BMW	32131092876	AUDI	4D0419831B
TOYOTA	4553516020	NISSAN	4820405F00	BMW	32131096910	AUDI	4D0419831DS1
		NISSAN	4820453A00			AUDI	4D0419831E
							

Cross References List And Photo

Photo.....



540043S		540045		540045S		540061	
AUDI	4D0419831B	HONDA	53536S1AE01	HONDA	53536S1AE01	MAZDA	A00132126
AUDI	4D0419831D					SUZUKI	4857260B10
						SUZUKI	4857282000
							

540061S		540075		540075S		540076	
CITROËN	406643	DACIA	6001547607	DACIA	6001547607	NISSAN	48203AV600
CITROËN	406643S1	NISSAN	4820300QAD	NISSAN	4820300QAD	SKODA	6Q0423831A
		OPEL	4501260	OPEL	4501260	VOLVO	9191409
							

540079		540101		540134		540156	
TOYOTA	455360K010	HYUNDAI	5652802000	TOYOTA	4553526030	HONDA	53534SL4J01
		HYUNDAI	5777424000				
		MITSUBISHI	MB266166				
							

Cross References List And Photo

Photo.....





540163	540178	540178S	540183S
MITSUBISHI MR297971	HYUNDAI 5777433100 MITSUBISHI MB350581 MITSUBISHI MB350770	MITSUBISHI MB350581 MITSUBISHI MB501711 MITSUBISHI MR369122	MERCEDES-BENZ 9014620096 MERCEDES-BENZ A9014620096 MERCEDES-BENZ A9014620396
			

540184	540184S	540186	540186S
FORD 1012814 FORD 3043575 FORD 3047747	FORD 1012814 FORD 3043575 FORD 7138554	BMW 32111137070 BMW 32111139772 BMW 32131094933	BMW 32131094933 BMW 32131096465 BMW 32131096910
			





540187S	540188	540188S	540189
FORD 1085517 FORD 4045250 FORD 6182818	MERCEDES-BENZ 2204601000 MERCEDES-BENZ 2204630296 MERCEDES-BENZ A2204630296	MERCEDES-BENZ 2204601000 MERCEDES-BENZ 2204630296	CITROËN 400622 CITROËN 401815 FIAT 9946982
			

Cross References List And Photo

Photo.....

540189S		540190		540190S		540191S	
CITROËN	400622	CITROËN	406657	CITROËN	406673	BMW	31111137070
CITROËN	401815	CITROËN	406673	CITROËN	406682	BMW	32211139786
FIAT	9946982	CITROËN	406682	PEUGEOT	406657		
							

540192		540192S		540193		540193S	
VOLVO	9191409	VOLVO	9191409	VOLVO	271601	VOLVO	271601
							

540194		540194S		540195		540195S	
CITROËN	400622	CITROËN	400622	RENAULT	7701038840	RENAULT	7701038840
CITROËN	401815	CITROËN	401815				
FIAT	9946982	FIAT	9946982				
							

Cross References List And Photo

Photo.....

540196S		540197		540197S		540198	
MITSUBISHI	MR244902	VOLVO	272418	VOLVO	272418	FORD	1S7C3K661AB
MITSUBISHI	MR510406					FORD	4119193
VOLVO	3345796					FORD	4775683
							

540198S		540199		540199S		540201	
FORD	1S7C3K661AB	RENAULT	7701038839	RENAULT	7701038839	ALFA ROMEO	9947921
FORD	4119193						
FORD	4775683						
							

540201S		540202		540202S		540203	
ALFA ROMEO	9551287	RENAULT	7701472765	RENAULT	7701472765	AUDI	6Q0423831D
ALFA ROMEO	9947921						
ALFA ROMEO	9951287						
							

Cross References List And Photo

Photo.....

540203S		540204		540204S		540205	
AUDI	6Q0423831D	MERCEDES-BENZ 2034630396		MERCEDES-BENZ 2034630396		CITROËN	406664
		MERCEDES-BENZ 2104602300		MERCEDES-BENZ 2104602300		CITROËN	406674
		MERCEDES-BENZ A2034630396		MERCEDES-BENZ A2034630396			
							





540206		540206S		540207		540207S	
MERCEDES-BENZ 1634600096		MERCEDES-BENZ 1634600196		CITROËN	406670	CITROËN	406670
MERCEDES-BENZ 1634600196		MERCEDES-BENZ A1634600196		FIAT	77364276	FIAT	77364276
MERCEDES-BENZ A1634600196				LANCIA	77362281		
							

540208		540208S		540209		540209S	
VW	7H0422831	BMW	32106779622	MERCEDES-BENZ 1644600096		MERCEDES-BENZ 1644600096	
		VW	7H0422523	MERCEDES-BENZ A1644600096		MERCEDES-BENZ 9064600096	
		VW	7H0422831	VW	2E0713115	VW	2E0713115
							

Cross References List And Photo

Photo.....

540211		540211K		540211S		540213	
VAG	4D0419831A	HONDA	53534S0A900	AUDI	4D0419831A	TOYOTA	4553512070
		MAZDA	GA2A3212X			TOYOTA	4553512100
		TOYOTA	4553502020				
							

540217S		540220S		540223		540223S	
HONDA	53534SL4J01	NISSAN	4820300QAA	NISSAN	4820300QAA	NISSAN	4820300QAA
HONDA	53534SR3N52	RENAULT	6000025546	RENAULT	6000025546	RENAULT	6000025546
HONDA	53534SV4N01	RENAULT	6000025671	RENAULT	6000025671	RENAULT	6000025671
NISSAN	4820453A00			RENAULT	6000025671		
							

540224S		540227		540230S		540231	
TOYOTA	455360K010	KIA	5774007600	ACURA	53534SV4003	ACURA	53534SV4003
							

Cross References List And Photo

Photo.....





540235S		540245S		540246S		540249S	
FORD	1655456	AUDI	4J042281	FORD	3904122	GENERAL MOTORS	09118132
FORD	1660158	AUDI	4J0422831	FORD	6772173	OPEL	1609527
FORD	1662210	AUDI	811419831B	FORD	F33C3K661AA	VAUXHALL	9118132
							

540252S		540256S		540266		540266S	
BMW	1127104	CITROËN	406630	HYUNDAI	577400U000	CITROËN	406684
BMW	32111127104	CITROËN	95639173	MINIBUS	4410A125	MITSUBISHI	4410A125
				PEUGEOT	406684	MITSUBISHI	4410A452
							





540267		540267S		540268		540276	
SUZUKI	4857165J00	SUZUKI	4857165J00	NISSAN	48203JD01A	DAEWOO	26021070
							

Cross References List And Photo

Photo.....





540285	540285S	540286	540286S
RENAULT 482036715R	RENAULT 482036715R	FORD 1251936 FORD 1328882 FORD 1334215	FORD 1251936 FORD 1334215 FORD 31317782
			





540288S	540289S	540291	540326
HYUNDAI 5772817000	DACIA 8201108358	HYUNDAI 577401H000	HYUNDAI 577402D000
			

540326S	540328	540330	540330S
HYUNDAI 577402D000	AUDI 8N0422831 OPEL 13278357 OPEL 902010	TOYOTA 4553509040	TOYOTA 4553509040 TOYOTA 9046057006 TOYOTA 9046622003
			

Cross References List And Photo

Photo.....

540332		540332S		540333		540335	
CITROËN	406620	CITROËN	406615	RENAULT	7701469486	RENAULT	7700678649
CITROËN	91510923	CITROËN	406620			RENAULT	7700678697
PEUGEOT	406615	PEUGEOT	7910030073			RENAULT	7701469497
							





540335S		540337S		540341		540341S	
RENAULT	7700678649	RENAULT	7701471141	CITROËN	406662	CITROËN	406662
RENAULT	7700781097						
RENAULT	7701469497						
							

540342		540342S		540343		540343S	
BMW	32136751026	BMW	32136751026	MERCEDES-BENZ	2034630296	MERCEDES-BENZ	2034602300
		BMW	32136753546	MERCEDES-BENZ	A2034630296	MERCEDES-BENZ	2034630296
		LAND ROVER	QFW000010			MERCEDES-BENZ	A2034630296
							

Cross References List And Photo

Photo.....

540344		540344S		540345		540345S	
FORD	6935233	FORD	6177346	IVECO	2992592	IVECO	2992592
MAZDA	1E0032125	FORD	6177347				
		FORD	6935233				
							





540346		540384		540414		540415S	
CITROËN	406637	SEAT	175422831	CITROËN	406622	FORD	1545456
CITROËN	96127397	SEAT	191422831	CITROËN	91510864	FORD	1871102
		SEAT	1H0422831	CITROËN	95510864	OPEL	1609347
							

540416S		540417S		540420		540420S	
CITROËN	406641	BMW	32102454428	HYUNDAI	577402E000	HYUNDAI	577402E000
FIAT	9404066418	BMW	32106765782				
		BMW	32106785993				
							

Cross References List And Photo

Photo.....





540421		540432		540439		540440	
HONDA	53534ST0003	FIAT	7520850	FORD	1545456	AUDI	2H0422831
HONDA	53534ST0013			GENERAL MOTORS	093189041	BMW	32106765782
				OPEL	01609347	BMW	32106785993
							

540443		540448		540449S		540481S	
CITROËN	406641	CITROËN	406613	HONDA	53534SV4N01	FORD	1433372
FIAT	9404066418	PEUGEOT	406615			FORD USA	6G913L575AA
		PEUGEOT	406627			VOLVO	30776251
							

541014		541014S		541025		541026S	
MITSUBISHI	MR510271	MITSUBISHI	MR510271	HYUNDAI	577402K001	SEAT	191422831
				HYUNDAI	577402K010	SEAT	1H0422831B
						SEAT	357422831A
							

Cross References List And Photo

Photo.....

541029S	541030	541033	541033S
CITROËN 406642	MERCEDES-BENZ 2054630096 MERCEDES-BENZ A2054630096	BMW 32106778560	BMW 32106778560
			

541034	541034S	541119S	541149S
PEUGEOT 1608652080 PEUGEOT 406680	PEUGEOT 1608652080 PEUGEOT 406680	FIAT 71742757 SUZUKI 4857179J00 SUZUKI 4857179J00000	CITROËN 406664 CITROËN 406674
			

541209	541209S	541218	S010002
AUDI 1K0423831A AUDI 1K0423831B VW 5C0423831	AUDI 1K0423831A AUDI 1K0423831B VW 5C0423831	AUDI 4G0423831	MITSUBISHI MB831042
			

Cross References List And Photo

Photo.....





S010003		S010010		S010013		S010026	
<p> MITSUBISHI MB831040 MITSUBISHI MR592811 MITSUBISHI MR592811A </p>	<p> MITSUBISHI MR296272 MITSUBISHI MR344654 </p>	<p> MITSUBISHI MR296508 MITSUBISHI MR376996 MITSUBISHI MR592120 </p>	<p> KIA 0K01132320A KIA 0K01132320B </p>				

S010037		S010041		S010070		S010100	
<p> TOYOTA 4540135260 </p>	<p> MITSUBISHI MR296273 MITSUBISHI MR296509 </p>	<p> SUZUKI 4872160A00 </p>	<p> MAZDA UH7132320 </p>				



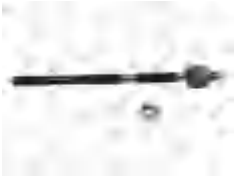

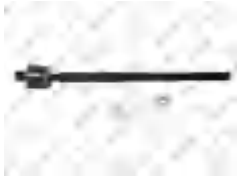
S030001		S030002		S030005		S030006	
<p> ALFA ROMEO 9947923 </p>	<p> ALFA ROMEO 9948297 </p>	<p> ALFA ROMEO 9947371 ALFA ROMEO 9947718 ALFA ROMEO 9950774 </p>	<p> OPEL 1603456 OPEL 1603543 VAUXHALL 93189022 </p>				

Cross References List And Photo

Photo.....





S030009		S030010		S030011		S030013	
AUDI	1K0423810A	AUDI	7L0422803C	AUDI	1J0422803A	AUDI	4D0422821
AUDI	3C0423810A	AUDI	7L0422804C	AUDI	1J0422804A	AUDI	4D0422821A
VW	1K0423821C	AUDI	7L0422821	VAG	1J0422803H	AUDI	8E0422821
							





S030014		S030018		S030019		S030020	
BMW	1125186	CITROËN	3812C8	CITROËN	38120000	CITROËN	1607294480
BMW	32111127124			CITROËN	3812C6	CITROËN	3812E2
BMW	32111130449					FIAT	77362280
							





S030021		S030022		S030024		S030025	
CITROËN	3812C0	CITROËN	1607291780	CITROËN	3812F0	CITROËN	3812E9
CITROËN	3812E4	CITROËN	3812E5	FIAT	1401381380		
CITROËN	85048214			FIAT	1497552080		
							

Cross References List And Photo

Photo.....





S030026		S030027		S030028		S030029	
CITROËN	1607292780	CITROËN	3812A9	CITROËN	1607293380	CITROËN	3812E3
CITROËN	400624			CITROËN	3812E1	CITROËN	3812E7
FIAT	1471654080					PEUGEOT	96288787
							





S030032		S030033		S030035		S030039	
CITROËN	3812A4	CITROËN	381225	CITROËN	381299	DACIA	6001547606
FIAT	9566950880	CITROËN	381294	CITROËN	96032460	DACIA	6001550441
FIAT	9947713	CITROËN	96136394	OPEL	4403806	DACIA	6001551453
							





S030041		S030050		S030052		S030057	
CHEVROLET	520672	ALFA ROMEO	9941625	FIAT	7079382	FIAT	7079388
CHEVROLET	520808	FIAT	09941625				
DAEWOO	520838	FIAT	9939675				
							

Cross References List And Photo

Photo.....





S030059		S030063		S030064		S030065	
FIAT	4410145	FIAT	5960321	FIAT	7081842	FIAT	2170345
FIAT	5958244	FIAT	SE127162449A			FIAT	7081851
SEAT	22162449B	FIAT	SE141162449A				
							





S030071		S030072		S030073		S030074	
FORD	1024130	FORD	6180922	FORD	1659374	FORD	1S7C3280BB
FORD	547419803B	FORD	6197238	FORD	4048739	FORD	4097484
FORD	6180350	FORD	91AB3L519CB	FORD	6639188	FORD	4111327
							





S030075		S030079		S030080		S030083	
FORD	1085520	FORD	1370710	FORD	1370709	FORD	1251937
FORD	3043523	FORD	4059924	FORD	4059923	FORD	1510270
FORD	3707333	FORD	4577976	FORD	4602028	FORD	1714484
							

Cross References List And Photo

Photo.....



S030087		S030088		S030089		S030091	
FORD	6737692	FORD	6832049	FORD	1044014	FORD	1317453
FORD	7294415	FORD	7294416	FORD	96FB3L519BA	FORD	1377655
FORD	F5RC3280BA	FORD	F5RC3280DA	MAZDA	1E0032240	FORD USA	4M513L519AA
							





S030092		S030093		S030096		S030097	
FORD	1433271	FORD	1545457	FORD	F57Z3280AA	HONDA	53010SR3010
FORD	1596574	FORD USA	8V513L519AA			HONDA	53010ST0000
VOLVO	30776250					HONDA	53010ST7J61
							

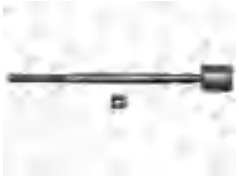



S030098		S030110		S030111		S030112	
HONDA	53521SM4003	HONDA	53521S9A003	HYUNDAI	5654002000	HYUNDAI	5654025000
HONDA	53521SM4013			HYUNDAI	5775502000	HYUNDAI	5654028020
ROVER	GSV1211					HYUNDAI	5775525000
							

Cross References List And Photo

Photo.....

S030116		S030117		S030118		S030119	
HYUNDAI	5773029000	CHRYSLER	4333450	HYUNDAI	5771634000	HYUNDAI	5772438000
HYUNDAI	5773029001	HYUNDAI	5773024100	HYUNDAI	577243A000	HYUNDAI	5772438010
				HYUNDAI	5775517000	HYUNDAI	577243C010
							





S030121		S030123		S030124		S030127	
HYUNDAI	577242B000	HYUNDAI	577242D000	HYUNDAI	5778526200	HYUNDAI	577242E000
		HYUNDAI	577242D020				
		HYUNDAI	577242F000				
							





S030130		S030135		S030137		S030138	
HYUNDAI	565402H000	KIA	5772407000	KIA	577323E010	KIA	577313E010
		KIA	5772407100				
		KIA	5772407101				
							

Cross References List And Photo

Photo.....



S030140		S030161		S030162		S030164	
KIA	0K20132240	MERCEDES-BENZ	1633380215	MERCEDES-BENZ	1683301335	MERCEDES-BENZ	1693300703
KIA	0K2A132240	MERCEDES-BENZ	A1633380215	MERCEDES-BENZ	168330133505	MERCEDES-BENZ	1693300903
KIA	0K9A232240			MERCEDES-BENZ	A168330133505	MERCEDES-BENZ	A1693300703
							



S030168		S030170		S030171		S030175	
VW	2E0713410	MERCEDES-BENZ	1644600005	MERCEDES-BENZ	2043380015	MERCEDES-BENZ	9014600155
VW	2E0713491	MERCEDES-BENZ	A1644600005	MERCEDES-BENZ	2043380415	MERCEDES-BENZ	9014600255
VW	2E0713491SK			MERCEDES-BENZ	A2043380015	VW	2D0422803
							



S030177		S030180		S030181		S030182	
MERCEDES-BENZ	2043380315	MITSUBISHI	MB266152	MITSUBISHI	MB910690	MITSUBISHI	MB532971
MERCEDES-BENZ	2043380515	MITSUBISHI	MB315160	MITSUBISHI	MB949343	MITSUBISHI	MR210221
MERCEDES-BENZ	A2043380315	MITSUBISHI	MB350577	MITSUBISHI	MR198987		
							

Cross References List And Photo

Photo.....





S030186		S030187		S030199		S030201	
MITSUBISHI MB13087 MITSUBISHI MB910934 MITSUBISHI MB910961	MITSUBISHI MR510267	NISSAN 485210C000 NISSAN 485210C005 NISSAN 485210C025	NISSAN 48521CB025 NISSAN 48521CB026 NISSAN 48521CB027				





S030202		S030203		S030204		S030206	
NISSAN 48521EA000	NISSAN 4852100QAG NISSAN 4852100QAGSK RENAULT 7701472120SK	NISSAN 4852100Q0B OPEL 4418780 OPEL 4501261	NISSAN 4852100QAA NISSAN 4852100QAASK RENAULT 7701472113				



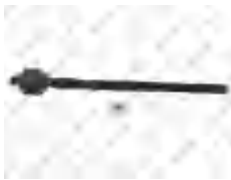

S030228		S030229		S030231		S030234	
CITROËN 3812C4 PEUGEOT 3812C1 PEUGEOT 3812C3	CITROËN 3812E0 CITROËN VTR995 PEUGEOT 1607293680	CITROËN 3812C5 CITROËN VTR1045	CITROËN 381247 PEUGEOT 381250 PEUGEOT 381298				

Cross References List And Photo

Photo.....





S030235		S030236		S030240		S030241	
PEUGEOT	381292	CITROËN	1610936980	DACIA	7701469502	DACIA	7701469280
		CITROËN	3812F2	RENAULT	7701468952	RENAULT	7701469280SK
				RENAULT	7701468953		
							

S030242		S030243		S030244		S030245	
DACIA	7701471124	DACIA	7701471143	DACIA	7701472087	DACIA	7701471844
RENAULT	7701471124SK	RENAULT	7701471143SK	RENAULT	7701472087SK	RENAULT	7701471844SK
		RENAULT	7701471144	RENAULT	7701472088	RENAULT	N99031
							





S030246		S030247		S030250		S030252	
RENAULT	7701472766	DACIA	7701471125	DACIA	7701474448	DACIA	7701472734
RENAULT	7701472766SK	RENAULT	7701471125SK	RENAULT	7701474448SK	RENAULT	7701472734SK
RENAULT	7701478551	RENAULT	7701472115			RENAULT	7701472735
							

Cross References List And Photo

Photo.....





S030257		S030259		S030260		S030261	
DACIA	7701473498	DACIA	7701464015	RENAULT	7701467218	RENAULT	6000022819
RENAULT	7701473498SK	RENAULT	7700754706	RENAULT	7701469517	RENAULT	7701469251
		RENAULT	7701467235	RENAULT	7701469517SK	RENAULT	7701469665SK
							



S030262		S030265		S030270		S030272	
RENAULT	485215612R	AUDI	191419821	SUBARU	34140AA001	PONTIAC	96060605
RENAULT	485215612RSK	AUDI	6K0422803A	SUBARU	34140AA003	SUZUKI	4883060B00
RENAULT	485215961R	SEAT	191419803ASK	SUBARU	34140AA010	SUZUKI	4883060B00000
							



S030273		S030275		S030276		S030279	
SUZUKI	4883063B00	NISSAN	485213J225	SUZUKI	4883060G00	SUZUKI	4883065J00
SUZUKI	4883063B00000	SUZUKI	4883065D00	SUZUKI	4883060G00000	SUZUKI	4883065J00000
SUZUKI	4883082000	SUZUKI	4883065D00000				
							

Cross References List And Photo

Photo.....



S030284		S030285		S030286		S030297	
TOYOTA	4550319205	TOYOTA	4550319155	TOYOTA	4550309130	TOYOTA	4550302080
TOYOTA	4550329385	TOYOTA	4550319185	TOYOTA	4550319175	TOYOTA	4550312130
		TOYOTA	4550319195	TOYOTA	4550319215	TOYOTA	4550319255
							

S030299		S030303		S030304		S030305	
TOYOTA	4550349055	LEXUS	4550309230	TOYOTA	4550329285	TOYOTA	4504629355
		LEXUS	4550339225	TOYOTA	4550329295	TOYOTA	4550309030
		TOYOTA	4550308230			TOYOTA	4550329355
							



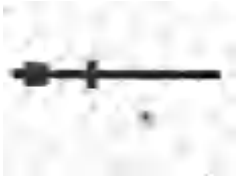

S030306		S030313		S030314		S030315	
LEXUS	4550339235	AUDI	1H0419821	VW	701419810A	VOLVO	274353
LEXUS	4550339265	VW	1H0419807	VW	701419810B		
TOYOTA	4950339265	VW	1H0419821A	VW	701419821		
							

Cross References List And Photo

Photo.....





S030324		S030327		S030328		S030329	
VOLVO	9191410	VOLVO	1387356	VOLVO	1273126	VOLVO	1387463
VOLVO	91914101	VOLVO	271389	VOLVO	12731261	VOLVO	9140504
		VOLVO	2713899	VOLVO	1359347	VOLVO	91405043
							





S030330		S030332		S030334		S030339	
VOLVO	31476353	VOLVO	274179	BMW	32111126620	CHRYSLER	5272500AE
VOLVO	3546266	VOLVO	8663288	BMW	32111130451		
VOLVO	35462662	VOLVO	8663289				
							





S030341		S030342		S030347		S030348	
AUDI	4F0422821	AUDI	4H0422810	BMW	32106777268	BMW	32106774347
AUDI	4F0422821D	AUDI	4H0422810A	BMW	32106777268SK	BMW	32106777479
AUDI	4F0422822	AUDI	8J0423810	BMW	32216756368	BMW	32216762403
							

Cross References List And Photo

Photo.....





S030350		S030351		S030354		S030360	
BMW	32106765235SK	BMW	1095956	BMW	32106784716	CITROËN	1610937780
BMW	32106765236	BMW	32211095955	BMW	32106784719	CITROËN	1635770680
BMW	32106765236SK	BMW	32211095956	BMW	32106784792	CITROËN	3812F3
							





S030361		S030366		S030369		S030372	
CITROËN	3812F6	CHEVROLET	521410	FIAT	51875887	HONDA	53010SWCG01
		CHEVROLET	93740701	FORD	1541354	HONDA	53010SWCG02
				FORD	1541355		
							

S030385		S030387		S030388		S030389	
LAND ROVER	QFK500030	LAND ROVER	QFK500020	LAND ROVER	QFK500010	MAZDA	GE4T32240
						MAZDA	GE4T32240A
							

Cross References List And Photo

Photo.....





S030392		S030396		S030397		S030425	
NISSAN	48001JD900	PEUGEOT	1610938580	CITROËN	3812F1	AUDI	8N0422803A
NISSAN	485219204R	PEUGEOT	381232	CITROËN	400169	AUDI	8N0422804A
NISSAN	D8521JD00B	PEUGEOT	381238	CITROËN	400169S1	AUDI	8N0422807
							





S030431		S030446		S030451		S030459	
VW	701419803D	TOYOTA	4550309320	LEXUS	4550339275	NISSAN	485210W025
VW	701419810	TOYOTA	4550309321	TOYOTA	4550309420	NISSAN	485210W026
VW	701419822C	TOYOTA	4550309330	TOYOTA	4550309500		
							





S030478		S030480		S030481		S030490	
HONDA	53010S04000	HONDA	53011SEL003	HONDA	53010SEL003	VW	357419821
HONDA	53010S04J51						
							

Cross References List And Photo

Photo.....





S030495		S030514		S030524		S030528	
VW	357422803A	HYUNDAI	565403X000	DAIHATSU	4550387111	HYUNDAI	577304F000
VW	357422804A			DAIHATSU	4550387703000		
VW	357422807A			DAIHATSU	4550387708		
							





S030529		S030533		S030538		S030544	
NISSAN	48521ET00A	FORD	1L2Z3280CA	FIAT	9948282	HYUNDAI	577243K000
						HYUNDAI	577243K500
							





S030558		S030569		S030574		S030575	
TOYOTA	4550342020	MITSUBISHI	4422A057	CHRYSLER	68028831AA	HYUNDAI	577242S000
TOYOTA	4550349165	MITSUBISHI	4422A079	CHRYSLER	68028831AB	HYUNDAI	577242S010
TOYOTA	4551068020	MITSUBISHI	MR403100	CHRYSLER	68028831AC	HYUNDAI	577242S100
							

Cross References List And Photo

Photo.....



S030577		S030578		S030579		S030581	
NISSAN	48521EB70A	HYUNDAI	577242T000	FIAT	6000609635	SUBARU	4883078F00
NISSAN	D8521EB70A			MITSUBISHI	4410A173	SUBARU	4883078F01
NISSAN	D8E21EB70A			MITSUBISHI	4410A173T	SUZUKI	4883078F00000
							





S030590		S030593		S030597		S030602	
MITSUBISHI	MB844695	IVECO	002992593	CHEVROLET	93296754	HONDA	53010T0AA01
MITSUBISHI	MR131830	IVECO	02992593				
		IVECO	099477984				
							

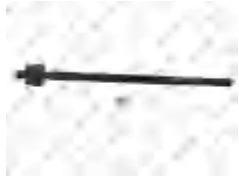

S030614		S030620		S030622		S030623	
DACIA	7701471885	HYUNDAI	577294A000	SEAT	6Q0423803G	CITROËN	381747
RENAULT	7701471885SK	HYUNDAI	5773043000	SEAT	6Q0423804G		
		HYUNDAI	5773043010	SKODA	6Q0423810C		
							

Cross References List And Photo

Photo.....

S030626		S030629		S030632		S030640	
MITSUBISHI	4422A036	BMW	32106780985	SEAT	6Q0423803B	SEAT	191422803ASK
MITSUBISHI	4422A121	BMW	32106780985SK	SEAT	6Q0423803BSK	SEAT	191422803SK
		BMW	32106793496	SEAT	6Q0423803E	SEAT	191422804A
							

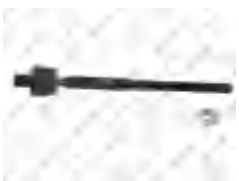
S030641		S030644		S030647		S030649	
AUDI	1H0422803A	MITSUBISHI	4422A055	HONDA	53610TL1G01	MERCEDES-BENZ	2123302000
SEAT	1H0422803	MITSUBISHI	4422A077			MERCEDES-BENZ	2123302103
SEAT	1H0422803ASK	MITSUBISHI	MN103259			MERCEDES-BENZ	A2123302000
							

S030654		S030655		S030656		S030658	
AUDI	4G0423810	BMW	32106768879	SEAT	1S0423810A	AUDI	6R0423810C
AUDI	4G0423810A	BMW	32106768879SK			AUDI	8Z0423803C
AUDI	4M0423810C	BMW	32106768880SK			AUDI	8Z0423804C
							

Cross References List And Photo

Photo.....



S030677		S030678		S030681		S030683	
HYUNDAI	577244H000	HYUNDAI	577244H100	KIA	0K55232250B	HONDA	53610SNBJ01
						HONDA	53610SNRA01
							



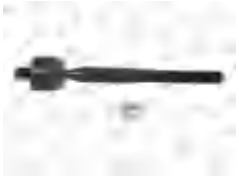

S030690		S030709		S030713		S030717	
SUBARU	34160AE000	CITROËN	1610817680	AUDI	6C0423810A	HYUNDAI	577243J000
SUBARU	34160AE001	OPEL	93476592	AUDI	6C0423810B		
SUBARU	34160AG020			AUDI	6C0423810C		
							

S030719		S030720		S030721		S030723	
HYUNDAI	577242P100	KIA	577242P000	HYUNDAI	565402K000	SUBARU	34160XA010
							

Cross References List And Photo

Photo.....

S030724		S030727		S030729		S030732	
VOLVO	31280409	FORD	1775547	SEAT	6K0422803SK	NISSAN	48521AL500
VOLVO	31280409SK	FORD USA	AB313280AB	SEAT	6K0422804	NISSAN	48521AL525
		MAZDA	EG2132240	SEAT	6K0422804SK	NISSAN	D8521AL500
							





S030738		S030744		S030747		S030761	
SUBARU	34160AE010	FORD	1F1Z3280AA	NISSAN	MR519046	CHRYSLER	88910567
SUBARU	3416EAE010	FORD USA	F6DZ3280AA				
							





S030776		S030777		S030783		S030785	
FORD	4933608	BMW	1136133	NISSAN	48521CA025	HONDA	53010TA0A01
FORD USA	4R3Z3280A	BMW	1139315				
FORD USA	9R333D032AA	BMW	32111136133				
							

Cross References List And Photo

Photo.....



S030786		S030793		S030794		S030799	
DODGE	52109970AA	KIA	577243F500	FORD	7T4Z3280A	FIAT	51967456
						FIAT	52005180
							

S030821		S030822		S030827		S030829	
FORD	9L3Z3280A	VW	191422821C	TOYOTA	4550302060	MAZDA	E0163224X
FORD	BL3Z3280A	VW	1H0422807	TOYOTA	4550302070	MAZDA	E01632250
		VW	1H0422807D	TOYOTA	4550309400	MAZDA	E0163225X
							



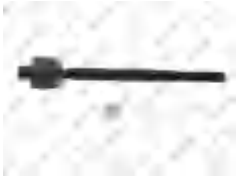

S030834		S030837		S030840		S030842	
TOYOTA	4550306080	MITSUBISHI	MR455091	VAG	7H0419821D	VW	357422821
TOYOTA	455038Y001	NISSAN	485217Y000				
		NISSAN	485218J000				
							

Cross References List And Photo

Photo.....

S030843		S030847		S030848		S030850	
HONDA	53010SNAA01	BMW	32216762243	SEAT	6K0422803E	CHRYSLER	68105872AB
HONDA	53010SNEA01	BMW	32216762243SK	SEAT	6K0422804E	JEEP	68105872AA
		BMW	32216762244SK	SEAT	6K0422807E		
							





S030851		S030853		S030884		S030900	
ALFA ROMEO	K04782952AB	MERCEDES-BENZ	2103380415	HONDA	53010SDBA01	KIA	577241M000
CHRYSLER	04782952AB	MERCEDES-BENZ	2113302903				
CHRYSLER	4782952AB	MERCEDES-BENZ	A2103380415				
							

S030912		S030926		S030928		S030931	
INFINITI	48521CG025	MERCEDES-BENZ	2054600805	AUDI	5Q0423810	AUDI	8W0423810
		MERCEDES-BENZ	A2054600805	SEAT	561423810	AUDI	8W0423810A
							

Cross References List And Photo

Photo.....





S030932	S030935	S030936	S030946
MERCEDES-BENZ 2073300500	RENAULT 7701473656	CITROËN 1623140880	FIAT 1341019080 FIAT 1341021080 FIAT 1345854080
			

S030948	S030951	S030955	S030956
CHRYSLER 68040223AB CHRYSLER 68040223AD CHRYSLER 68040223AE	MINI 32106854733 MINI 32106854736 MINI 32106899813	PEUGEOT 1607142380 PEUGEOT 3812G3	JAGUAR J9C7533 LAND ROVER LR026271 TESLA 600707100B
			





S030958	S030960	S030966	S030968
KIA 5654007600	LAND ROVER LR033529 LAND ROVER LR045193	TOYOTA 4551012390 TOYOTA 4551012391	SSANGYONG 4651008000 SSANGYONG 4651008300
			

Cross References List And Photo

Photo.....





S030970		S030975		S030976		S030985	
VW	357422803	SUBARU	34160XA000	FORD	1824228	HYUNDAI	577242W500
VW	357422804			FORD	DG9C3D032BA		
							

S030988		S030989		S030993		S030994	
BMW	32106867404	HYUNDAI	577242W550	BMW	1091767	JEEP	K52089292AC
BMW	32106867405			BMW	1091768		
BMW	32106899815			BMW	1093769		
							





S030997		S031000		S031004		S031005	
HYUNDAI	577242T500	HYUNDAI	57724C1100	CHRYSLER	68158377AA	VOLVO	274224
HYUNDAI	577242W000	KIA	57724C1000	CHRYSLER	68158378AA		
HYUNDAI	577243Q000			CHRYSLER	K68158377AA		
							

Cross References List And Photo

Photo.....





S031057		S031058		S031060		S031067	
TESLA	104474100E	TESLA	107080100E	RENAULT	485211071R	RENAULT	485211375R
							

S031071		S031072		S031079		S031081	
KIA	57724C5100	KIA	57724C5000	SUBARU	34160SC020	FORD	9S4Z3280A
KIA	57724C5600	KIA	57724C5500				
							

S031088		S031111		S040002		S040017	
INFINITI	485215DA0A	RENAULT	485210001R	SUZUKI	4885060A00	JEEP	52037994
MERCEDES-BENZ	2463380000			SUZUKI	4885060A00000		
MERCEDES-BENZ	A2463380000			SUZUKI	4885085C00		
							

Cross References List And Photo

Photo.....

S050002	S050009	S050010	S050015
ALFA ROMEO 46841498 ALFA ROMEO 46843389 ALFA ROMEO 60625029	ALFA ROMEO 50704362 ALFA ROMEO 50706991 ALFA ROMEO 51795455	ALFA ROMEO 50704361 ALFA ROMEO 50706990 ALFA ROMEO 51795454	ALFA ROMEO 60613575 ALFA ROMEO 60699021
			





S050016	S050017	S050021	S050022
ALFA ROMEO 60809242 FIAT 60570627 FIAT 7601647	ALFA ROMEO 50515276 ALFA ROMEO 50531823 OPEL 350616	AUDI 1J0505466C	AUDI 4E0411317C AUDI 4E0411317E AUDI 4E0411317F
			





S050023	S050024	S050025	S050027
AUDI 4D0505547C AUDI 4E0505547A AUDI 4E0505547L	AUDI 4D0505548C AUDI 4E0505548A AUDI 4E0505548L	AUDI 4F0505465N AUDI 4F0505465Q	AUDI 893407465 AUDI 893407465A AUDI 8A0407465
			

Cross References List And Photo

Photo.....

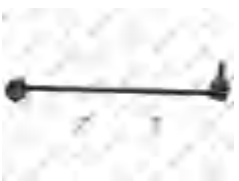

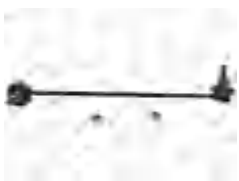

S050030		S050031		S050032		S050033	
AUDI	8A0505465C	AUDI	8A0505466C	AUDI	4D0411317D	AUDI	4D0411318G
AUDI	8D0505465	AUDI	8D0505466	AUDI	4D0411317G	AUDI	8D0411318D
				AUDI	4D0411317J	AUDI	8D0411318DS1
							





S050034		S050035		S050036		S050038	
AUDI	4D0411317G	AUDI	1K0505465AA	AUDI	1J0411316D	AUDI	6Q0411315A
AUDI	4D0411317J	AUDI	1K0505465C			AUDI	6Q0411315B
AUDI	8D0411317D	AUDI	1K0505465J			AUDI	6Q0411315C
							

S050040		S050042		S050043		S050044	
AUDI	1K0411315E	AUDI	8E0505465AC	AUDI	1J0411315D	AUDI	4D0501529A
AUDI	1K0411315G	AUDI	8E0505465AF			AUDI	4D0501529E
AUDI	1K0411315P	AUDI	8E0505465K			AUDI	4D0501529F
							

Cross References List And Photo

Photo.....



S050047		S050048		S050049		S050050	
AUDI	7L0411317	AUDI	1J0505466B	AUDI	7L0505465A	AUDI	7L0505466A
PORSCHE	95534306900			AUDI	7L0505465B	AUDI	7L0505466B
				AUDI	7L0505465C	AUDI	7L0505466C
							

S050052		S050054		S050055		S050056	
AUDI	1J0411315H	BMW	1092304	BMW	1094619	BMW	1095694
AUDI	1J0411315K	BMW	31351092304	BMW	33551094619	BMW	31351095694
		BMW	31351095664			BMW	31356780847
							



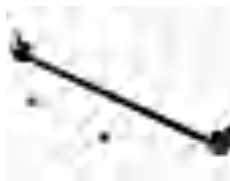
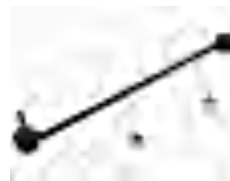

S050057		S050058		S050060		S050061	
BMW	1092292	BMW	1124375	BMW	31356750703	BMW	31356750704
BMW	33551092292	BMW	33551124375	BMW	6750703	BMW	6750704
BMW	33551095532	BMW	33551126932				
							

Cross References List And Photo

Photo.....





S050062		S050063		S050064		S050065	
BMW	1096735	BMW	31306781546	BMW	31306781545	BMW	31306781547
BMW	33551096735	BMW	31356753768	BMW	31356753767	BMW	31354014531
		BMW	31356778070	BMW	31356778069	BMW	31356760985
							



S050066		S050067		S050068		S050069	
BMW	31306781548	BMW	33506781540	BMW	31356765933	BMW	31356765934
BMW	31354014532	BMW	33556761000	BMW	6765933	BMW	6765934
BMW	31356760986	BMW	6761000				
							

S050070		S050071		S050072		S050073	
BMW	33556764428	BMW	33503413197	BMW	31303413201	BMW	31303413202
		BMW	33503414297	BMW	31303414299	BMW	31303414300
		BMW	3413197				
							

Cross References List And Photo

Photo.....

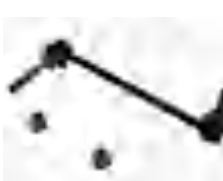



S050077		S050078		S050082		S050083	
BMW	31351091764	BMW	31351124380	BMW	33556771937	BMW	37116771929
BMW	31351127689	BMW	31351127194	BMW	33556857626	BMW	37116857627
BMW	31351128737	BMW	31351128050	BMW	6771937	BMW	37116859653
							





S050084		S050085		S050086		S050087	
BMW	37116771930	BMW	31356773023	BMW	31356773024	BMW	33506781538
BMW	37116857628	BMW	31356857623	BMW	31356857624	BMW	33556757460
BMW	37116859654	BMW	31356859651	BMW	31356859652	BMW	6757460
							





S050088		S050095		S050096		S050099	
CHEVROLET	95994977	CHRYSLER	04743669AA	CHRYSLER	05272190	CITROËN	508751
CHEVROLET	96275798	CHRYSLER	4694855	CHRYSLER	5272190	FIAT	1331209080
CHEVROLET	96391875	CHRYSLER	4743454AA			VOLVO	30884179
							

Cross References List And Photo

Photo.....





S050100		S050105		S050106		S050107	
CITROËN	508737	CITROËN	5081N9	CITROËN	5170F5	CITROËN	508748
FIAT	1300716080	FIAT	1300720080	CITROËN	5170F6	CITROËN	508760
		FIAT	1357572080	FIAT	1355449080	PEUGEOT	508743
							





S050109		S050110		S050111		S050112	
CITROËN	508750	CITROËN	508735	CITROËN	508745	CITROËN	508752
CITROËN	508757	FIAT	1308664080	CITROËN	508759		
CITROËN	508762	FIAT	1317425080	CITROËN	96288787		
							





S050113		S050114		S050115		S050116	
CITROËN	508753	CITROËN	1607326080	CITROËN	508734	CHEVROLET	96225859
		CITROËN	517846	CITROËN	508739	CITROËN	517848
		CITROËN	517852	CITROËN	508746	MITSUBISHI	4156A014
							

Cross References List And Photo

Photo.....

S050117		S050118		S050119		S050124	
CHEVROLET	96225858	CITROËN	1610930380	CHEVROLET	96300222	FIAT	46413122
CITROËN	517849	CITROËN	508758	CHEVROLET	96391876	FIAT	51701045
MITSUBISHI	MN184194	MITSUBISHI	MN101368	DAEWOO	96288865	FIAT	60813377
							





S050126		S050131		S050132		S050133	
CITROËN	508765	GENERAL MOTORS	13237130	FORD	1004018	FORD	1061702
CITROËN	508770	GENERAL MOTORS	24417251	FORD	1061631	FORD	1203093
CITROËN	508779	OPEL	0350603	FORD	1067818	FORD	1487402
							





S050134		S050135		S050144		S050145	
FORD	1117800	FORD	1117698	FORD	1117698	FORD	1310333
FORD	1127648	FORD	1127646	FORD	1127646	FORD	1335548
FORD USA	1S715C486AC	FORD	1219697	FORD	1219697	FORD	1469208
							

Cross References List And Photo

Photo.....





S050146		S050147		S050150		S050151	
MAZDA	BBM234170	FORD	1954821	FORD	4346344	FORD	1377416
MAZDA	BBM234170A	NISSAN	562600F001	FORD	4440885	FORD	1425853
MAZDA	BBM334170			FORD USA	YC155C486AF	VOLVO	30760678
							

S050154		S050155		S050159		S050160	
FORD	1495685	FORD	1954778	HONDA	51321SNAA02	HONDA	51320SNAA02
FORD USA	3C113B438AC	NISSAN	546180F000	NISSAN	546184U000		
FORD USA	3C113B438AD	NISSAN	54618MB40A	NISSAN	54618BU00		
							





S050161		S050162		S050163		S050164	
HONDA	90112SE0000	HONDA	51320S04003	HONDA	52321S04003	HONDA	52320S04003
HONDA	90112SJ8000	HONDA	51330S10020	HONDA	53321S04003		
HONDA	90112SK7000						
							

Cross References List And Photo

Photo.....

S050165		S050166		S050167		S050168	
HONDA	52320S84A01	HONDA	52325S84A01	HONDA	51321S5A003	HONDA	51320S5A003
HONDA	52320SDAA01	HONDA	52325SDAA01	HONDA	51321S5A305	HONDA	51320S5A305
HONDA	52320SFYJ01	HONDA	52325SFYJ01				
							





S050169		S050174		S050175		S050176	
HONDA	52321S10003	HONDA	51321S84A01	HONDA	51320S84A01	HONDA	52320S10003
				HONDA	51320S84A02		
							





S050177		S050178		S050180		S050181	
HONDA	52321S9A003	HONDA	52320S9A003	HONDA	51320SDAA04	HONDA	52321S5A013
				HONDA	51320SEAE01		
				HONDA	51320TA0A01		
							

Cross References List And Photo

Photo.....





S050182		S050183		S050184		S050185	
HONDA	52320S5A013	HONDA	51320SMGE01	HONDA	52321SNAA01	HONDA	52320SNAA01
							

S050186		S050187		S050188		S050191	
HONDA	51320STKA01	GREAT WALL	2916100XKZ09A	GREAT WALL	2916200XKZ09A	HYUNDAI	5483017010
HONDA	51320T0AA01	HONDA	52321SWAA01	HONDA	52320SWAA01	HYUNDAI	5483025010
HONDA	51320T0NT01					MITSUBISHI	4056A016
							

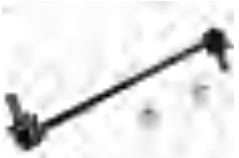

S050192		S050195		S050198		S050199	
HYUNDAI	5483029000	HYUNDAI	5483017020	HYUNDAI	5558037020	HYUNDAI	5483026000
HYUNDAI	5483029500	HYUNDAI	5483025020	HYUNDAI	5558037030	HYUNDAI	5483026100
HYUNDAI	5483029500AS	MITSUBISHI	4056A015	MITSUBISHI	4056A019	HYUNDAI	5483026100AS
							

Cross References List And Photo

Photo.....

S050200		S050203		S050204		S050205	
HYUNDAI	5484026000	HYUNDAI	548302D000	HYUNDAI	5483038100	HYUNDAI	5553038000
HYUNDAI	5484026100	HYUNDAI	5483034000	HYUNDAI	5483038110	HYUNDAI	5553038010
HYUNDAI	5484026100AS	HYUNDAI	5483034500	HYUNDAI	5483039000		
							



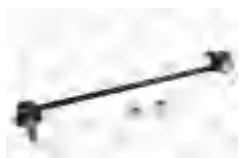

S050207		S050208		S050209		S050210	
HYUNDAI	555301F000	HYUNDAI	548301F000	HYUNDAI	548304A000	HYUNDAI	555304A000
HYUNDAI	555302E000	HYUNDAI	548302E000	HYUNDAI	548304A002	HYUNDAI	555304A001
HYUNDAI	555302E100	HYUNDAI	548302E100	HYUNDAI	548304A003	HYUNDAI	555304A801
							

S050211		S050212		S050215		S050216	
HYUNDAI	5553026600	HYUNDAI	5554026600	HYUNDAI	548303K000	HYUNDAI	548302B000
HYUNDAI	5553026700	HYUNDAI	5554026700	HYUNDAI	548303K010	HYUNDAI	548302B200
HYUNDAI	5553026700AS	HYUNDAI	5554026700AS	HYUNDAI	548303L000		
							

Cross References List And Photo

Photo.....

S050217		S050218		S050222		S050223	
HYUNDAI	548402B000	HYUNDAI	555302B000	HYUNDAI	548302H000	HYUNDAI	555301H000
HYUNDAI	548402B200	HYUNDAI	555302B200	HYUNDAI	548302H100	HYUNDAI	555301H100
				HYUNDAI	548302H200	HYUNDAI	555302H000
							



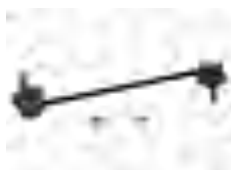

S050224		S050225		S050226		S050227	
HYUNDAI	5553017000	MITSUBISHI	4056A014	JEEP	52088283	JEEP	52088319
HYUNDAI	5553029000	MITSUBISHI	MB518892			JEEP	52088319AB
HYUNDAI	5553029500	MITSUBISHI	MB573043			JEEP	K52088319AB
							

S050229		S050230		S050234		S050237	
KIA	0K2A534150	KIA	0K2A134150A	KIA	0K55234160B	KIA	5483007000
KIA	0K2A534150A	KIA	0K2A134150B			KIA	548300X000
KIA	0K2A534150B	KIA	0K2M228150				
							

Cross References List And Photo

Photo.....





S050238		S050239		S050240		S050241	
KIA	5484007000	KIA	548302F000	KIA	548402F000	KIA	0K01134150A
KIA	548400X000					KIA	0K01134160A
							



S050242		S050243		S050244		S050246	
KIA	548103E000	KIA	548113E010	KIA	548113E060	FORD	3410592
KIA	548103E000AS	KIA	548113E010AS	KIA	548113E060AS	KIA	KGA2A34170A
KIA	548103E000S1	KIA	548113E110	KIA	548113E160	MAZDA	L20634170A
							

S050247		S050249		S050251		S050256	
FORD	3410591	FORD	3799085	MAZDA	EA0334170	CHEVROLET	96207628
KIA	KGA2A34150A	MAZDA	GA2B28170	MAZDA	EA0334170A	MAZDA	LC6234170
MAZDA	GA2A34150	MAZDA	GA2B28170A			MAZDA	LC6234170A
							

Cross References List And Photo

Photo.....





S050296	S050298	S050299	S050300
<p>CHRYSLER 68013720AA MERCEDES-BENZ 9063201889 VW 2E0411318C</p> 	<p>MERCEDES-BENZ 2213201989 MERCEDES-BENZ A2213201989</p> 	<p>MERCEDES-BENZ 2213202289 MERCEDES-BENZ A2213202289</p> 	<p>MERCEDES-BENZ 1643201332 MERCEDES-BENZ 1643202132 MERCEDES-BENZ 2513201232</p> 

S050301	S050302	S050303	S050304
<p>MERCEDES-BENZ 9013200689 MERCEDES-BENZ 9063201389 VW 2E0511051F</p> 	<p>MERCEDES-BENZ 2033200789 MERCEDES-BENZ A2033200789</p> 	<p>MERCEDES-BENZ 2033200889 MERCEDES-BENZ A2033200889</p> 	<p>MERCEDES-BENZ 2043201789 MERCEDES-BENZ 2043203789 MERCEDES-BENZ A2043203789</p> 

S050305	S050306	S050307	S050308
<p>MERCEDES-BENZ 2043201889 MERCEDES-BENZ 2043203889 MERCEDES-BENZ A2043203889</p> 	<p>MERCEDES-BENZ 2043200589 MERCEDES-BENZ A2043200589</p> 	<p>MERCEDES-BENZ 2043200489 MERCEDES-BENZ A2043200489</p> 	<p>CHRYSLER 05103920AA MERCEDES-BENZ 1233200989 MERCEDES-BENZ A1233200989</p> 

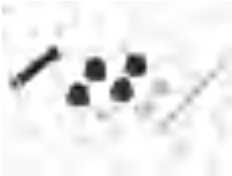
Cross References List And Photo

Photo.....





S050309	S050314	S050315	S050317
MERCEDES-BENZ 1633200032 MERCEDES-BENZ A1633200032 	CHRYSLER 05118696AA MERCEDES-BENZ 9013200589 VW 2D0511329A 	MERCEDES-BENZ 2033202189 MERCEDES-BENZ 2033202689 MERCEDES-BENZ 2033202989 	AUDI 4D0505465D MITSUBISHI 4056A026 MITSUBISHI MB892981 





S050319	S050321	S050322	S050323
MITSUBISHI 4056A021 MITSUBISHI MB879354 MITSUBISHI MR272117 	MITSUBISHI 4056A012 MITSUBISHI MB672370 	MITSUBISHI 4056A013 MITSUBISHI MB808076 	MITSUBISHI 4056A106 MITSUBISHI MB267877 MITSUBISHI MR374521 

S050324	S050325	S050326	S050327
MITSUBISHI 4056A105 MITSUBISHI MB267876 MITSUBISHI MR374522 	MITSUBISHI 4056A111 MITSUBISHI MR418052 	MITSUBISHI 4056A112 MITSUBISHI MR418053 	MITSUBISHI MR132551 MITSUBISHI MR267876 

Cross References List And Photo

Photo.....



S050328	S050329	S050330	S050334
MITSUBISHI MR132552 MITSUBISHI MR267877	MITSUBISHI MB633926 MITSUBISHI MB633926S1 MITSUBISHI MR633926	MITSUBISHI MB527385	MITSUBISHI 4056A133 MITSUBISHI MR992191
			

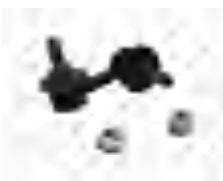



S050335	S050336	S050343	S050349
MITSUBISHI 4056A134 MITSUBISHI MR992192	VOLVO 30871770 VOLVO 30873100 VOLVO 30884358	NISSAN 546180E000 NISSAN 546180Z000 NISSAN 546180Z800	NISSAN 546688H300
			

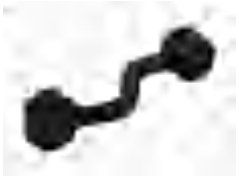



S050350	S050353	S050354	S050356
NISSAN 546188H300	NISSAN 54618EA000 NISSAN 54618EA010 NISSAN 562617S010	NISSAN 54668EA000 NISSAN 54668EA010 NISSAN 562617S000	NISSAN 546681AA0A NISSAN 546681AA0E NISSAN 54668JD00A
			

Cross References List And Photo

Photo.....

S050357		S050360		S050361		S050363	
NISSAN	546181AA0A	NISSAN	55618JD00A	NISSAN	55619JD00A	GENERAL MOTORS	009160498
NISSAN	546181AA0E	NISSAN	55618JE20A	NISSAN	55619JE20A	GENERAL MOTORS	9160498
NISSAN	54618JD00A	NISSAN	55618JY00B	NISSAN	55619JY00B	GENERAL MOTORS	93192673
							

S050364		S050365		S050366		S050367	
GENERAL MOTORS	009160499	NISSAN	5461600QAC	LEXUS	4883032040	NISSAN	54668CA000
GENERAL MOTORS	9160499	OPEL	4408904	NISSAN	54618AX600	NISSAN	54668CA00E
GENERAL MOTORS	93192674	RENAULT	8200002870	NISSAN	54618BC40A	NISSAN	54668CK000
							





S050384		S050385		S050388		S050389	
PEUGEOT	517839	PEUGEOT	508727	CITROËN	1607326880	CITROËN	1607326980
PEUGEOT	96287831			CITROËN	508768	CITROËN	508769
				PEUGEOT	508755	PEUGEOT	508754
							

Cross References List And Photo

Photo.....

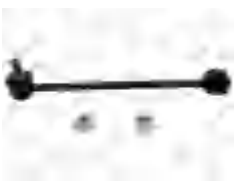



S050392	S050396	S050398	S050402
MERCEDES-BENZ 4153200000 RENAULT 8200166159 RENAULT 8200669065	RENAULT 8200166160 RENAULT 8200669066 SSANGYONG 4475035000	SEAT 191411315A	AUDI 6K0411315
			





S050403	S050404	S050405	S050410
SUZUKI 4664080F00 SUZUKI 4664080F00000	SUZUKI 4663080F00 SUZUKI 4663080F00000	SUZUKI 4242065J00 SUZUKI 4242065J00000	LEXUS 4883032010 TOYOTA 4883012060 TOYOTA 4883020010
			





S050414	S050415	S050416	S050418
TOYOTA 4881028010 TOYOTA 4881028020	TOYOTA 4882028010 TOYOTA 4882028030	TOYOTA 4882002020 TOYOTA 4882032010 TOYOTA 4882042020	TOYOTA 4882042020
			

Cross References List And Photo

Photo.....





S050419		S050421		S050427		S050428	
LEXUS	4882006040	LEXUS	488100K010	CHERY	T112916030	CHERY	T112916040
LEXUS	4882028050	LEXUS	4881060040	TOYOTA	4884042010	TOYOTA	4883042010
TOYOTA	4882033030	TOYOTA	4881004010				
							



S050430		S050431		S050437		S050439	
LEXUS	4881006030	LEXUS	4882006030	TOYOTA	4883060030	TOYOTA	4882042010
LEXUS	4881033010	LEXUS	4882033020	TOYOTA	4883060030S1		
							

S050440		S050441		S050447		S050449	
LEXUS	4882002070	TOYOTA	488300R010	AUDI	701411019B	VW	7H0411317
LEXUS	4882042030	TOYOTA	4883042020	VW	701411049B	VW	7H0411317A
TOYOTA	488200R010	TOYOTA	4883042021			VW	7H5411317
							

Cross References List And Photo

Photo.....



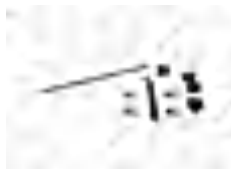

S050452		S050453		S050454		S050455	
VOLVO	272991	VOLVO	3064792	VOLVO	1229391	VOLVO	274303
VOLVO	6819253	VOLVO	30647920	VOLVO	3530230	VOLVO	274456
VOLVO	9492837	VOLVO	30714678	VOLVO	9157725	VOLVO	30714685
							

S050462		S050463		S050466		S050469	
VOLVO	3416129	VOLVO	3416130	JEEP	52003360	FORD	2L2Z5K483BA
VOLVO	3467713	VOLVO	3467714				
VOLVO	8416129	VOLVO	8416130				
							



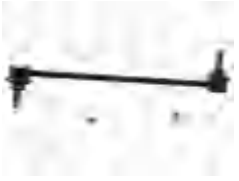

S050470		S050471		S050472		S050473	
CHRYSLER	05272324	AUDI	4E0505465E	AUDI	8K0505465E	AUDI	8K0411317C
CHRYSLER	5272324AB	AUDI	4E0505465G	AUDI	8K0505465ES1	AUDI	8K0411317D
CHRYSLER	5272324AC	AUDI	8E0505465E	AUDI	8K0505465G	AUDI	8K0411317E
							

Cross References List And Photo

Photo.....



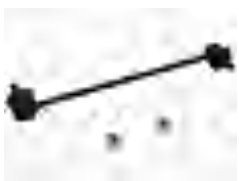

S050475		S050476		S050483		S050484	
MINI	31356759537	MINI	33506772789	CHEVROLET	S4475005000	FORD	1106269
MINI	31356778831	MINI	33506781133	DAEWOO	4475005000	FORD	5106995
MINI	6759537	MINI	33551507999	DAEWOO	4475005001	FORD	6710541
							

S050490		S050491		S050497		S050501	
FORD	1023149	FORD	1513343	HYUNDAI	5482002000	HYUNDAI	555803E000
FORD	1072446	MAZDA	BC1D28170			KIA	555803E000AS
FORD	97BG5776AC	MAZDA	BC1D28170A			TOYOTA	555803E000DS
							

S050502		S050505		S050506		S050509	
KIA	555803E050	KIA	0K2N134150A	KIA	0K2N134170A	LAND ROVER	RBM100170
KIA	555803E050AS	KIA	0K2N134150AAS	KIA	0K2N134170AAS	LAND ROVER	RBM100171
TOYOTA	555803E050DS					LAND ROVER	RBM100172
							

Cross References List And Photo

Photo.....



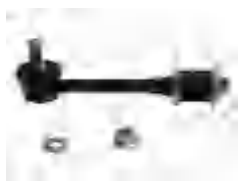

S050564		S050565		S050568		S050569	
TOYOTA	4882006050	LEXUS	4883033040	INFINITI	546182Y000	NISSAN	546682Y000
TOYOTA	4882033040	TOYOTA	4883006060	NISSAN	5461833P00	NISSAN	5466833P00
TOYOTA	4882033070						
							

S050570		S050581		S050586		S050590	
NISSAN	546180W000	HYUNDAI	5453038600	TOYOTA	4882002030	HYUNDAI	555303R000
NISSAN	546180W001	HYUNDAI	5553038600	TOYOTA	4882002040	HYUNDAI	555403R000
NISSAN	546183W400			TOYOTA	4882047010	HYUNDAI	555403Z001
							



S050592		S050598		S050612		S050615	
HYUNDAI	548302S000	SUBARU	4663060B11	LEXUS	488200K030	TOYOTA	488200K010
HYUNDAI	548302S200	SUZUKI	4663060B00	LEXUS	488200K040	TOYOTA	488200K020
HYUNDAI	548303W300	SUZUKI	4663060B01	LEXUS	4882060050		
							

Cross References List And Photo

Photo.....





S050622		S050626		S050627		S050632	
HYUNDAI	548300U000	mitsubishi	4056A193	MITSUBISHI	4056A192	MITSUBISHI	MR333762
HYUNDAI	548302V000	MITSUBISHI	MR992310	MITSUBISHI	MR992309		
HYUNDAI	548304L000						
							



S050640		S050643		S050648		S050652	
CADILLAC	10385580	GENERAL MOTORS	15257472	NISSAN	54618CA000	HYUNDAI	548303R000
FORD	6W1Z5664AA	JEEP	52060011AB	NISSAN	54618CA00E		
FORD USA	F0VY5A486A			NISSAN	54618CK000		
							

S050653		S050655		S050657		S050658	
HYUNDAI	555303K000	HONDA	51321SDAA02	HONDA	52325TA0A01	ACURA	52320TA0A01
HYUNDAI	555303K001	HONDA	51321SDAA03				
HYUNDAI	555303K002	HONDA	51321SEAE01				
							

Cross References List And Photo

Photo.....

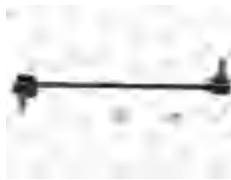

S050659		S050664		S050666		S050667	
KIA	0K01134150	HONDA	51321S30N21	HYUNDAI	54822H1000	HYUNDAI	555302S100
		NISSAN	54668CA010			HYUNDAI	555302S200
						HYUNDAI	555302Z100
							

S050674		S050675		S050685		S050694	
HONDA	51320S30N21	INFINITI	562617S011	NISSAN	5461600QAA	KIA	0K2FA34150
NISSAN	54618CA010	NISSAN	562611LB1A	RENAULT	7700799404		
		NISSAN	56261EA510	RENAULT	7700803387		
							





S050695		S050700		S050704		S050714	
NISSAN	546188B501	KIA	0K2FA34170	CHRYSLER	4766962AA	CHRYSLER	05174185AA
				DODGE	04766962AA	CHRYSLER	5174185AB
				FIAT	K04766962AA	CHRYSLER	5174185AC
							

Cross References List And Photo

Photo.....





S050717		S050718		S050724		S050726	
FORD	1732874	FORD	1732872	HONDA	52320SS0003	INFINITI	54618AL510
FORD USA	AB313053CA	FORD USA	AB313052CA			INFINITI	54618EG010
MAZDA	UC7C34170	MAZDA	UC7C34150			INFINITI	54618EG01A
							





S050728		S050729		S050730		S050735	
INFINITI	54618AL501	HYUNDAI	54823H1000	HYUNDAI	55823H1000	MITSUBISHI	4056A040
NISSAN	54618AL502					MITSUBISHI	4056A040S1
						MITSUBISHI	MR319147
							





S050737		S050742		S050753		S050760	
CHRYSLER	04695626	NISSAN	54618BA60B	HONDA	51320SS0003	BMW	33506768493
CHRYSLER	4695626	NISSAN	54618CY00A			BMW	33506781537
		NISSAN	54618ET00A			BMW	33556761492
							

Cross References List And Photo

Photo.....





S050761		S050796		S050803		S050804	
BMW	33556777635	GENERAL MOTORS	093197325	MERCEDES-BENZ	2123201289	MERCEDES-BENZ	2123201189
BMW	6777635	OPEL	04419291	MERCEDES-BENZ	A2123201289	MERCEDES-BENZ	A2123201189
							

S050815		S050816		S050817		S050818	
JEEP	52088662AB	JEEP	52089467AB	JEEP	52089486AC	CHRYSLER	04656934AA
				JEEP	52089486AD	CHRYSLER	04656934AB
				JEEP	52089486AE	CHRYSLER	4656934AB
							





S050819		S050820		S050823		S050825	
CHRYSLER	4782716AA	CHRYSLER	4782717AA	MITSUBISHI	MB001622	MITSUBISHI	MR594340
CHRYSLER	4895482AA	CHRYSLER	4895483AA	MITSUBISHI	MB241429		
CHRYSLER	4895482AB	CHRYSLER	4895483AB	MITSUBISHI	MB241798		
							

Cross References List And Photo

Photo.....

S050831		S050843		S050844		S050849	
HYUNDAI	555301D000	JAGUAR	C2C18572	JAGUAR	C2C18571	SUBARU	20420XA000
HYUNDAI	555302G500	JAGUAR	C2D49529	JAGUAR	C2D49528		
HYUNDAI	555302H200	JAGUAR	XR81693	JAGUAR	XR81692		
							





S050885		S050901		S050904		S050905	
ALFA ROMEO	K52125295AC	AUDI	8K0411317B	MERCEDES-BENZ	2043200789	MERCEDES-BENZ	2043202289
DODGE	52125295AC	AUDI	8K0411317BS1	MERCEDES-BENZ	2043200789S1		
							





S050912		S050913		S050917		S050922	
LEXUS	4883006020	TOYOTA	4883006030	RENAULT	546180009R	HONDA	52320S3N013
LEXUS	4883033010	TOYOTA	4883006050	RENAULT	546182198R	MAZDA	L20628170
		TOYOTA	4883021010				
							

Cross References List And Photo

Photo.....





S050924		S050925		S050937		S050940	
SUBARU	20470AJ010	CHRYSLER	05151803AA	FORD	YL2Z5K484AA	FORD USA	1W4Z5K484AA
SUBARU	20470SC000	CHRYSLER	4762137			FORD USA	5W4Z5K483AA
		CHRYSLER	5151803AA			JAGUAR	XR81694
							





S050942		S050957		S050958		S050959	
JEEP	52001132	NISSAN	54668AL501	INFINITI	546681CA0A	INFINITI	546181CA0A
JEEP	52037849	NISSAN	54668AL502	NISSAN	546681CA2B	NISSAN	546181CA2B
				NISSAN	546681CA3B	NISSAN	546181CA3B
							



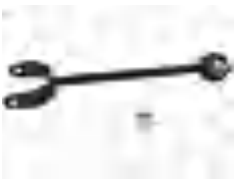

S050964		S050965		S050980		S050982	
INFINITI	546681CA1A	INFINITI	546181CA1A	LEXUS	4880248010	SUBARU	20470XA010
INFINITI	546681CA2A	INFINITI	546181CA2A			TOYOTA	488300C020
INFINITI	546681CA3A	INFINITI	546181CA3A				
							

Cross References List And Photo

Photo.....





S050983		S050984		S050985		S050986	
SUBARU	20470XA000	INFINITI	54668WL010	INFINITI	54618WL010	TOYOTA	4884050020
TOYOTA	488400C010	INFINITI	54668WL01A	INFINITI	54618WL01A		
							





S050987		S050988		S050999		S051045	
TOYOTA	4883050040	FORD	1691815	CHRYSLER	4581264	CHEVROLET	15146379
		FORD	1714891				
		FORD	1767896				
							





S051047		S051048		S051055		S051063	
HUMMER	15120888	FORD USA	7T4Z5K483A	MERCEDES-BENZ	1243500153	CHRYSLER	4782254AB
HUMMER	15150888			MERCEDES-BENZ	2013503253		
HUMMER	19168015			MERCEDES-BENZ	2103500653		
							

Cross References List And Photo

Photo.....

S051070		S051076		S051121		S051193	
JEEP	5105270AA	FORD	1107069	SUZUKI	4242067D00	HYUNDAI	548403R000
JEEP	5105270AB	FORD	1111769			HYUNDAI	548403R000AS
MITSUBISHI	MN100109	FORD	1209035				
							





S051198		S051200		S051229		S051234	
VOLVO	30852103	MERCEDES-BENZ	1693200589	OPEL	350611	AUDI	5Q0505465A
VOLVO	30871765	MERCEDES-BENZ	A1693200589	OPEL	350614	AUDI	5Q0505465C
VOLVO	30873101			VAUXHALL	13169439		
							

S051237		S051241		S051242		S051243	
FORD	1513343	FIAT	51939949	MINI	31306862863	BMW	33506862865
FORD	1745924	FIAT	53403318				
FORD	1790310	FIAT	53477126				
							

Cross References List And Photo

Photo.....

S051245		S051247		S051248		S051249	
INFINITI	54668AL510	MERCEDES-BENZ	2053260317	MERCEDES-BENZ	2053260417	MERCEDES-BENZ	2053230817
INFINITI	54668EG01B	MERCEDES-BENZ	A2053260317	MERCEDES-BENZ	A2053260417	MERCEDES-BENZ	A2053230817
INFINITI	54668EG03B						
							





S051250		S051251		S051255		S051257	
MERCEDES-BENZ	2053230717	MERCEDES-BENZ	2463200100	GENERAL MOTORS	93168675	CITROËN	508776
MERCEDES-BENZ	A2053230717	MERCEDES-BENZ	2463200789	OPEL	4419304		
		MERCEDES-BENZ	A2463200100	OPEL	4420954		
							



S051258		S051259		S051260		S051261	
AUDI	4G0411317A	BMW	31306792211	BMW	31306792212	BMW	33506785607
AUDI	4H0411317A						
AUDI	4H0411317C						
							

Cross References List And Photo

Photo.....



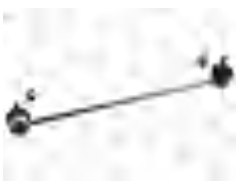

S051262		S051263		S051265		S051266	
BMW	33506785608	MERCEDES-BENZ	2463200489	HYUNDAI	555302W110	HYUNDAI	555402W110
		MERCEDES-BENZ	2463200789				
		MERCEDES-BENZ	A2463200489				
							

S051273		S051274		S051275		S051276	
VW	2H0411317	NISSAN	546183JA0C	NISSAN	546683JA0B	CADILLAC	20984481
VW	2H0411317B	NISSAN	546189N00A	NISSAN	546689N00A	GENERAL MOTORS	15870889
							



S051285		S051286		S051287		S051288	
BMW	31356768771	BMW	31356768772	HYUNDAI	1325110001	LAND ROVER	RBM500140
				HYUNDAI	1325110003		
				HYUNDAI	5471643160		
							

Cross References List And Photo

Photo.....

S051330		S051331		S051332		S051334	
FORD	1732869	FORD	5182780	BMW	33552282182	BMW	31306862864
FORD USA	AB313052AA	FORD USA	DG9C3B438ANC	BMW	33552283743	BMW	6862864
MAZDA	UC2R34150	FORD USA	DG9Z5K484A				
							

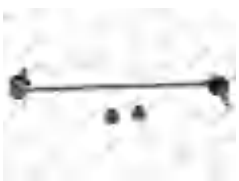



S051343		S051344		S051347		S051348	
DODGE	68069654AB	DODGE	68069655AB	SSANGYONG	4475008001	SSANGYONG	4475508000
DODGE	68069654AC	DODGE	68069655AC				
							

S051353		S051359		S051363		S051371	
BMW	31306792211	MERCEDES-BENZ	2473204200	MERCEDES-BENZ	2043200789	MITSUBISHI	MR151937
		MERCEDES-BENZ	2473207503	MERCEDES-BENZ	A2043200789		
		MERCEDES-BENZ	2473207603				
							

Cross References List And Photo

Photo.....

S051373	S051374	S051377	S051379
MERCEDES-BENZ 2533230217 MERCEDES-BENZ A2533230217	MERCEDES-BENZ 2533230117 MERCEDES-BENZ A2533230117	IVECO 500383975	IVECO 500315622
			





S051380	S051381	S051391	S051392
SSANGYONG 4475109000	LAND ROVER RGD000180 LAND ROVER RGD500100 LAND ROVER RGD500180	LAND ROVER RGD500131	LAND ROVER LR035489
			





S051396	S051397	S051398	S051399
BMW 31306787163	LAND ROVER LR042976	LAND ROVER LR042975	BMW 31306787164
			

Cross References List And Photo

Photo.....





S051405	S051406	S051407	S051410
BMW 33322406281 BMW 33356764428	LAND ROVER LR033242 LAND ROVER LR048092	LAND ROVER LR033243 LAND ROVER LR048093	MERCEDES-BENZ 2463200689 MERCEDES-BENZ A2463200689
			





S051412	S051413	S051414	S051415
MERCEDES-BENZ 2043202289 MERCEDES-BENZ A2043202289	TESLA 104439600D TESLA 118839600B	TESLA 104439100D TESLA 118839100B	TESLA 102739100B
			





S051416	S051426	S051427	S051428
TESLA 103060300B	MITSUBISHI 4056A035 MITSUBISHI MR316436	MITSUBISHI 4056A034 MITSUBISHI MR316435	MERCEDES-BENZ 2473205300 MERCEDES-BENZ A2473205300
			

Cross References List And Photo

Photo.....





S051429	S051432	S051433	S051434
MERCEDES-BENZ 4703260100 NISSAN 562614KH0A NISSAN 562615XA0A	AUDI 4M0505465D PORSCHE 958505465D VW 4K0505465	AUDI 4N0505465F AUDI 8W0505465B	MERCEDES-BENZ 6393260616 MERCEDES-BENZ A6393260616
			





S051441	S051443	S051461	S051471
JEEP 52059975AC	BMW 31356777319	BMW 37106775189	FORD 2031926 FORD FR3C5K483AB
			





S051472	S051473	S051475	S051477
HYUNDAI 55540C1100	HYUNDAI 55530C1100	TOYOTA 488300K010	LEXUS 4882050030
			

Cross References List And Photo

Photo.....

S051478	S051480	S051481	S051483
LAND ROVER J9C1131 LAND ROVER J9C35D498AA LAND ROVER K8D25D498AA LAND ROVER LR114304	LAND ROVER J9C1129 LAND ROVER J9C35C486AA LAND ROVER K8D25C486AA LAND ROVER LR114303	MERCEDES-BENZ 4473200489 MERCEDES-BENZ A4473200489	LEXUS 4881050020
			





S051488	S051489	S051492	S051497
MERCEDES-BENZ A4703202200 NISSAN 546684KH0A NISSAN 546685XA0A	MERCEDES-BENZ A4703202300 NISSAN 546184KH0A NISSAN 546185XA0A	FORD 9L3Z5K483D	LANCIA 46545749 LANCIA 50701813
			





S051498	S060001	S060002	S060003
FORD 2463429 FORD 5282207 FORD 5295981	ALFA ROMEO 51776327 ALFA ROMEO 51834093 ALFA ROMEO 60651939	ALFA ROMEO 51776326 ALFA ROMEO 60651940 ALFA ROMEO 60657246	ALFA ROMEO 50509340 ALFA ROMEO 60642465 ALFA ROMEO 60652465
			

Cross References List And Photo

Photo.....

S060004	S060007	S060008	S060009
ALFA ROMEO 50509339 ALFA ROMEO 60652466 ALFA ROMEO 60678135	ALFA ROMEO 46802680 ALFA ROMEO 46802681 ALFA ROMEO 51749713	ALFA ROMEO 46802682 ALFA ROMEO 60629903	ALFA ROMEO 50704947 ALFA ROMEO 50707481 ALFA ROMEO 51787337
			





S060010	S060011	S060012	S060017
ALFA ROMEO 50704948 ALFA ROMEO 50707480 ALFA ROMEO 51787336	ALFA ROMEO 50704306 ALFA ROMEO 50706858 ALFA ROMEO 50707029	ALFA ROMEO 50704307 ALFA ROMEO 50706859 ALFA ROMEO 50707030	ALFA ROMEO 60627290 ALFA ROMEO 60665804 ALFA ROMEO 60695895
			





S060018	S060019	S060020	S060021
ALFA ROMEO 60627291 ALFA ROMEO 60665805 ALFA ROMEO 60695896	ALFA ROMEO 46423824 ALFA ROMEO 46456049 ALFA ROMEO 46462626	ALFA ROMEO 46423825 ALFA ROMEO 46456050 ALFA ROMEO 46462627	AUDI 4D0407509B AUDI 4D0407509D AUDI 4D0407509K
			

Cross References List And Photo

Photo.....

S060022		S060023		S060024		S060026	
AUDI	4D0407510B	AUDI	4B0407151	AUDI	7L0505398	AUDI	8E0407693AA
AUDI	4D0407510D	AUDI	4B3407151A	PORSCHE	95533105000	AUDI	8E0407693AC
AUDI	4D0407510K	AUDI	4B3407151C			AUDI	8E0407693AD
							





S060027		S060028		S060029		S060030	
AUDI	8E0407694AA	AUDI	4F0407151	AUDI	4F0407693	AUDI	4F0407694
AUDI	8E0407694AC	AUDI	4F0407151A	AUDI	4F0407693B	AUDI	4F0407694B
AUDI	8E0407694AD	AUDI	4F0407152	AUDI	4F0407693C	AUDI	4F0407694H
							





S060031		S060032		S060033		S060036	
AUDI	4E0407151G	AUDI	4E0407693C	AUDI	4E0407694C	AUDI	443505351P
AUDI	4E0407151L	AUDI	4E0407693F	AUDI	4E0407694F		
		AUDI	4E0407693N	AUDI	4E0407694N		
							

Cross References List And Photo

Photo.....





S060037		S060038		S060039		S060040	
AUDI	443505352P	AUDI	8K0407693AE	AUDI	8K0407694AE	AUDI	4A0407151
		AUDI	8K0407693R	AUDI	8K0407694R		
							





S060041		S060042		S060043		S060044	
AUDI	4A0407152	AUDI	4D0407505B	AUDI	7L8407151D	AUDI	7L8407152D
		AUDI	4D0407505D	AUDI	7L8407151F	AUDI	7L8407152F
		AUDI	4D0407505F	AUDI	7L8407151K	AUDI	7L8407152K
							





S060045		S060047		S060048		S060049	
AUDI	7L0505397	AUDI	8E0407151E	AUDI	4Z7407505A	AUDI	4Z7407506A
PORSCHE	95533104900	AUDI	8E0407151K	AUDI	8D0407505B	AUDI	8D0407506B
		AUDI	8E0407151L	AUDI	8D0407505F	AUDI	8D0407506F
							

Cross References List And Photo

Photo.....

S060050		S060051		S060052		S060053	
AUDI	4E0407505B	AUDI	4E0407506B	AUDI	4E0407509B	AUDI	4E0407510B
AUDI	4E0407505E	AUDI	4E0407506E	AUDI	4E0407509E	AUDI	4E0407510E
BENTLEY	4E0407505F	AUDI	4E0407506F	AUDI	4E0407509K	AUDI	4E0407510K
							

S060054		S060055		S060056		S060057	
AUDI	4D0407151A	AUDI	4D0407693	AUDI	4D0407694	BMW	33321090816
AUDI	4D0407151B	AUDI	4D0407693E	AUDI	4D0407694E	BMW	33321094210
AUDI	4D0407151C	AUDI	4D0407693H	AUDI	4D0407694H	BMW	33326767832
							

S060058		S060059		S060060		S060061	
BMW	33306773941	BMW	31121092024	BMW	31121092023	BMW	1090745
BMW	33326759157	BMW	31121141718	BMW	31121141717	BMW	1097264
BMW	33326767753	BMW	31121141718S1	BMW	31121141717S1	BMW	33321090745
							

Cross References List And Photo

Photo.....





S060062		S060063		S060064		S060065	
BMW	1096316	BMW	1096315	BMW	1096170	BMW	1096169
BMW	31121096316	BMW	31121096315	BMW	31121096170	BMW	31121096169
BMW	31126760276	BMW	31126760275	BMW	31126769718	BMW	31126769717
							





S060066		S060067		S060068		S060073	
BMW	1141962	BMW	1141961	BMW	33321090030	BMW	1090905
BMW	2339998	BMW	2339999	BMW	33321091620	BMW	33321090905
BMW	31122339998	BMW	31122339999	BMW	33326770749	BMW	33326770059
							

S060074		S060075		S060076		S060077	
BMW	33321095414	BMW	33321095411	BMW	33321095412	BMW	1090906
BMW	33326768269	BMW	33326768273	BMW	33326768274	BMW	33321090906
BMW	33326770742	BMW	33326770747	BMW	33326770748	BMW	33326770060
							

Cross References List And Photo

Photo.....





S060078		S060079		S060080		S060081	
BMW	31122347951	BMW	31122347965	BMW	31104026719	BMW	31104026720
BMW	31124028607	BMW	31124028608	BMW	31124046437	BMW	31124046438
BMW	31126768297	BMW	31124028608S1	BMW	31126760183	BMW	31126760184
							





S060082		S060085		S060086		S060087	
BMW	33320300946	BMW	31124036269	BMW	31124036270	BMW	31126763699
BMW	33320398361	BMW	31126763703	BMW	31126763704	BMW	31126769793
BMW	33320403294	BMW	31126763707	BMW	31126763708	BMW	31126770849
							





S060088		S060089		S060091		S060092	
BMW	31126763700	BMW	33326765425	BMW	33322406290	BMW	31103412135
BMW	31126769794			BMW	33326763471	BMW	31103415027
BMW	31126770850					BMW	31103418337
							

Cross References List And Photo

Photo.....



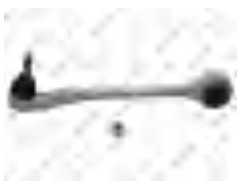

S060093		S060094		S060095		S060098	
BMW	31103412136	BMW	31100363477	BMW	31100363478	BMW	1092237
BMW	31103415028	BMW	31103412137	BMW	31103412138	BMW	1138380
BMW	31103418338	BMW	31103443127	BMW	31103443128	BMW	3411651
							





S060099		S060100		S060103		S060104	
BMW	31121124401	BMW	31121124402	BMW	31121130089	BMW	31121130090
BMW	31121131587	BMW	31121131582	BMW	31121130597	BMW	31121130598
BMW	31121139991	BMW	31121131588	BMW	31121139999	BMW	31121133490
							





S060105		S060106		S060107		S060108	
BMW	31121093450	BMW	1094233	BMW	1142088	BMW	1142087
BMW	31121094234	BMW	31121093449	BMW	31121142088	BMW	31121142087
BMW	31129069568	BMW	31129069568				
							

Cross References List And Photo

Photo.....





S060109		S060110		S060111		S060112	
BMW	31121141721	BMW	31121141722	BMW	1127726	BMW	31121127725
BMW	31121141723	BMW	31121141724	BMW	31121127726	BMW	31121701059
		BMW	3112141724	BMW	31121701060		
							





S060113		S060114		S060115		S060116	
BMW	31121094276	BMW	31121094275	BMW	31121133238	BMW	31121133237
BMW	31121136530	BMW	31121136529	BMW	31121139988	BMW	31121139987
BMW	31121140400	BMW	31126758513				
							

S060117		S060118		S060122		S060123	
BMW	31122282121	BMW	31122282122	BMW	31126771893	BMW	31126771894
BMW	31122341297	BMW	31122341828	BMW	6771893	BMW	6771894
BMW	31122343353R	BMW	31122343352R				
							

Cross References List And Photo

Photo.....

S060124		S060125		S060127		S060128	
BMW	31126773949	BMW	31126773950	CITROËN	352086	CITROËN	352158
BMW	31126863169	BMW	31126863170	CITROËN	3520C1	CITROËN	352181
				CITROËN	3520C2		
							

S060129		S060130		S060131		S060132	
CITROËN	3521H5	CITROËN	3520L4	CITROËN	3521G3	CITROËN	3520K3
CITROËN	3521H6	CITROËN	3520R0	CITROËN	3521K0	CITROËN	3520P0
CITROËN	3521J1	CITROËN	3520V1				
							





S060135		S060136		S060143		S060144	
CITROËN	3520S0	CITROËN	3521P1	FIAT	1313083080	FIAT	1313084080
FIAT	1352227080	FIAT	1352225080	FIAT	1316735080	FIAT	1316736080
FIAT	1352228080	FIAT	1352226080	FIAT	1317389080	FIAT	1317390080
							

Cross References List And Photo

Photo.....





S060145		S060146		S060149		S060150	
CITROËN	3521G8	CITROËN	3520K8	CITROËN	352048	CITROËN	352131
CITROËN	3521K3	CITROËN	3520P3	CITROËN	352049	CITROËN	352133
CITROËN	3521P3	CITROËN	3520S2	CITROËN	91516336	CITROËN	352134
							





S060158		S060169		S060170		S060179	
ALFA ROMEO	7536271	FORD	1540244	FORD	1540246	OPEL	352051
ALFA ROMEO	7543760	FORD	1580514	FORD	1580515	SAAB	12796013
ALFA ROMEO	7591277	FORD	1639574	FORD	1639575	SAAB	12799199
							

S060180		S060181		S060182		S060183	
OPEL	0352052	OPEL	0423008	FORD	1061659	FORD	1061668
OPEL	352052	OPEL	0423035	FORD	1136072	FORD	1105524
SAAB	12796014	VAUXHALL	13105744	FORD	1317609	VOLVO	30683067
							

Cross References List And Photo

Photo.....

S060193		S060197		S060198		S060204	
FORD	1061664	HONDA	52400SM1A03	HONDA	52390SM1A03	HYUNDAI	545004A000
FORD	1061666	HONDA	52400SM1A04	HONDA	52390SM1A04	HYUNDAI	545004A600
FORD	1064128	HONDA	52400SM4A04	HONDA	52390SM4033		
							

S060205		S060206		S060207		S060214	
HYUNDAI	545014A000	HYUNDAI	5454043150	HYUNDAI	5451043150	MERCEDES-BENZ	2023301907
HYUNDAI	545014A600	HYUNDAI	5454043151	HYUNDAI	5451043151	MERCEDES-BENZ	2023303007
		HYUNDAI	5454043152	HYUNDAI	5451043152	MERCEDES-BENZ	2023303607
							





S060215		S060216		S060217		S060218	
MERCEDES-BENZ	2023302007	MERCEDES-BENZ	2013503906	MERCEDES-BENZ	1243500129	MERCEDES-BENZ	1243507606
MERCEDES-BENZ	2023303107	MERCEDES-BENZ	2013504706	MERCEDES-BENZ	2103500029	MERCEDES-BENZ	1243507706
MERCEDES-BENZ	2023303707	MERCEDES-BENZ	2013505606	MERCEDES-BENZ	2103503806	MERCEDES-BENZ	1293500506
							

Cross References List And Photo

Photo.....





S060219	S060220	S060221	S060222
MERCEDES-BENZ 2033301911 MERCEDES-BENZ 2033303311 MERCEDES-BENZ 2043301911	MERCEDES-BENZ 2033302011 MERCEDES-BENZ 2033303411 MERCEDES-BENZ 2043302011	MERCEDES-BENZ 2033300111 MERCEDES-BENZ 2033301611 MERCEDES-BENZ 2033303511	MERCEDES-BENZ 2033300211 MERCEDES-BENZ 2033301711 MERCEDES-BENZ 2033303611
			





S060223	S060224	S060225	S060226
MERCEDES-BENZ 2113300138 MERCEDES-BENZ 2113304307 MERCEDES-BENZ 2113306707	MERCEDES-BENZ 2113300138 MERCEDES-BENZ 2113304407 MERCEDES-BENZ 2113306807	MERCEDES-BENZ 2113308107 MERCEDES-BENZ 2113309107 MERCEDES-BENZ A2113308107	MERCEDES-BENZ 2113308207 MERCEDES-BENZ 2113309207 MERCEDES-BENZ A2113308207
			

S060227	S060228	S060229	S060230
MERCEDES-BENZ 2113301111 MERCEDES-BENZ 2113301511 MERCEDES-BENZ 2113302911	MERCEDES-BENZ 2113301211 MERCEDES-BENZ 2113301611 MERCEDES-BENZ 2113303011	MERCEDES-BENZ 2303502706 MERCEDES-BENZ A2303502706	MERCEDES-BENZ 2303502806 MERCEDES-BENZ A2303502806
			

Cross References List And Photo

Photo.....

S060231	S060232	S060233	S060239
MERCEDES-BENZ 2303503506 MERCEDES-BENZ A2303503506	MERCEDES-BENZ 2303503606 MERCEDES-BENZ A2303503606	MERCEDES-BENZ 2303502006 MERCEDES-BENZ A2303502006	MERCEDES-BENZ 2203301811 MERCEDES-BENZ 2203303311 MERCEDES-BENZ 2203304311
			





S060240	S060241	S060242	S060243
MERCEDES-BENZ 2203301711 MERCEDES-BENZ 2203303411 MERCEDES-BENZ 2203304411	MERCEDES-BENZ 2203301407 MERCEDES-BENZ 2203308307 MERCEDES-BENZ 2203309307	MERCEDES-BENZ 2203301507 MERCEDES-BENZ 2203308407 MERCEDES-BENZ 2203309407	MERCEDES-BENZ 2203302407 MERCEDES-BENZ 2203304307 MERCEDES-BENZ 2203307707
			

S060244	S060245	S060246	S060247
MERCEDES-BENZ 2203302507 MERCEDES-BENZ 2203304407 MERCEDES-BENZ 2203307807	MERCEDES-BENZ 1633520001 MERCEDES-BENZ 1633520401 MERCEDES-BENZ A1633520001	MERCEDES-BENZ 1633520101 MERCEDES-BENZ 1633520501 MERCEDES-BENZ A1633520101	MERCEDES-BENZ 2203501606 MERCEDES-BENZ 2203502206 MERCEDES-BENZ A2203501606
			

Cross References List And Photo

Photo.....





S060248	S060249	S060250	S060251
MERCEDES-BENZ 2203501506 MERCEDES-BENZ 2203502406 MERCEDES-BENZ A2203501506 	MERCEDES-BENZ 1403503406 MERCEDES-BENZ 2203502606 MERCEDES-BENZ 2203502706 	MERCEDES-BENZ 2203500453 MERCEDES-BENZ 2203500453S1 MERCEDES-BENZ A2203500453 	MERCEDES-BENZ 2213306707 MERCEDES-BENZ 2213308107 MERCEDES-BENZ A2213306707 

S060252	S060253	S060254	S060258
MERCEDES-BENZ 2213306807 MERCEDES-BENZ 2213308207 MERCEDES-BENZ A2213306807 	MERCEDES-BENZ 2213302311 MERCEDES-BENZ 2213306311 MERCEDES-BENZ 2213306311S1 	MERCEDES-BENZ 2213302411 MERCEDES-BENZ 2213306411 MERCEDES-BENZ A2213306411 	MERCEDES-BENZ 2213500706 MERCEDES-BENZ 2223500129 MERCEDES-BENZ A2213500706 





S060259	S060260	S060261	S060262
MERCEDES-BENZ 2213500806 MERCEDES-BENZ 2223500229 MERCEDES-BENZ A2213500806 	MERCEDES-BENZ 2213501153 MERCEDES-BENZ A2213501153 	MERCEDES-BENZ 2213501253 MERCEDES-BENZ A2213501253 	MERCEDES-BENZ 2043303111 MERCEDES-BENZ 2043306711 MERCEDES-BENZ A2043303111 

Cross References List And Photo

Photo.....



S060263	S060267	S060268	S060269
MERCEDES-BENZ 2043303211 MERCEDES-BENZ 2043306811 MERCEDES-BENZ A2043303211	MERCEDES-BENZ 1403305407 MERCEDES-BENZ 1403305807 MERCEDES-BENZ 1403307607	MERCEDES-BENZ 1403305507 MERCEDES-BENZ 1403305907 MERCEDES-BENZ 1403307707	MERCEDES-BENZ 1633500053 MERCEDES-BENZ 1633500353 MERCEDES-BENZ 1633500553
			





S060270	S060271	S060272	S060285
MERCEDES-BENZ 1633500153 MERCEDES-BENZ 1633500453 MERCEDES-BENZ 1633500653	MERCEDES-BENZ 1403503506 MERCEDES-BENZ A1403503506	MERCEDES-BENZ 1403503606 MERCEDES-BENZ A1403503606	CITROËN 352047 CITROËN 3520A6 CITROËN 3520A7
			

S060286	S060287	S060288	S060289
CITROËN 352176 CITROËN 352177 CITROËN 3521G4	PEUGEOT 3520C0 PEUGEOT 3520H1	PEUGEOT 352180 PEUGEOT 3521C0 PEUGEOT 3521E1	CITROËN 3521H9 PEUGEOT 3521C8 PEUGEOT 3521P5
			

Cross References List And Photo

Photo.....

S060290		S060304		S060306		S060307	
CITROËN	3520L8	SUZUKI	4520060810	SUZUKI	4520265J00	SUZUKI	4520165J00
PEUGEOT	3520G8	SUZUKI	4520060812	SUZUKI	4520265J00000	SUZUKI	4520165J00000
PEUGEOT	3520S4	SUZUKI	4520150G10	SUZUKI	4520278K00	SUZUKI	4520178K00
							

S060308		S060313		S060314		S060315	
SUZUKI	4520076G00	VOLVO	30639780	VOLVO	30639781	VOLVO	30635231
SUZUKI	4520076G10	VOLVO	30645845	VOLVO	30645846	VOLVO	30736387
SUZUKI	4520076G20	VOLVO	30681614	VOLVO	30681615	VOLVO	8623959
							





S060316		S060322		S060323		S060328	
VOLVO	30635232	ALFA ROMEO	60653551	ALFA ROMEO	60653552	ALFA ROMEO	46519897
VOLVO	30736388	ALFA ROMEO	60666021	ALFA ROMEO	60666020	ALFA ROMEO	46519898
VOLVO	8623960					ALFA ROMEO	60815431
							

Cross References List And Photo

Photo.....





S060329	S060332	S060333	S060336
ALFA ROMEO 46519893 ALFA ROMEO 46519894 ALFA ROMEO 60815432	ALFA ROMEO 51783056 CITROËN 3521S6 CITROËN 3521V5	ALFA ROMEO 51783057 CITROËN 3520W3 CITROËN 3520Y4	AUDI 895407147A
			





S060337	S060338	S060339	S060340
AUDI 8N0407151 AUDI 8N0407152 AUDI 8N0407152A	AUDI 8N0407151 AUDI 8N0407151A AUDI 8N0407151D	AUDI 1J0407151A AUDI 1J0407151AS1 AUDI 1J0407151B	AUDI 1J0407151A AUDI 1J0407151AS2 AUDI 1J0407151B
			





S060341	S060342	S060343	S060344
AUDI 1K0407152AA AUDI 1K0407152AB AUDI 1K0407152AH	AUDI 1K0407151AA AUDI 1K0407151AB AUDI 1K0407151AH	AUDI 1K0407152AC AUDI 1K0407152AD AUDI 1K0407152T	AUDI 1K0407151AC AUDI 1K0407151AD AUDI 1K0407151AL
			

Cross References List And Photo

Photo.....





S060347		S060348		S060349		S060350	
PORSCHE	7L0407151C	AUDI	7L0407152C	AUDI	7L0407021	AUDI	6R0407151A
PORSCHE	7L0407151E	AUDI	7L0407152E	AUDI	7L0407021A	AUDI	6R0407151F
PORSCHE	7L0407151H	VW	7L0407152D	AUDI	7L0407021B		
							





S060351		S060352		S060353		S060354	
AUDI	6R0407152A	BMW	31121092609	BMW	31121092610	BMW	31126755835
AUDI	6R0407152F	BMW	31121092609S1	BMW	31121092610S1	BMW	31126770121
		BMW	31121092819	BMW	31121092820	BMW	31126770771
							





S060355		S060356		S060357		S060358	
BMW	31126755836	BMW	31124026453	BMW	31124026454	BMW	31121094465
BMW	31126770122	BMW	31124046441	BMW	31124046442	BMW	31122343353
BMW	31126770772	BMW	31126750519	BMW	31126750520	BMW	31122343359
							

Cross References List And Photo

Photo.....





S060359		S060372		S060372B		S060373	
BMW	31121094466	CITROËN	3520A3	CITROËN	1614418380	CITROËN	352171
BMW	31122343352	CITROËN	3520F7	CITROËN	1635773180	CITROËN	352172
BMW	31126752318	CITROËN	95658882	CITROËN	3520A1	CITROËN	3521E5
							

S060373B		S060374		S060375		S060376	
CITROËN	352171	PEUGEOT	352155	CITROËN	3520H4	CITROËN	3520H9
CITROËN	96658884	PEUGEOT	352156	PEUGEOT	352083	CITROËN	3520J3
PEUGEOT	3521A6	PEUGEOT	352168	PEUGEOT	3520H3	CITROËN	3520J4
							





S060377		S060378		S060379		S060380	
CITROËN	3521E9	CITROËN	3520P6	CITROËN	3521H1	FIAT	1331937080
CITROËN	3521F3	FIAT	1346384080	CITROËN	3521K6	FIAT	1339464080
CITROËN	3521F4	FIAT	93501487	FIAT	1346385080	PEUGEOT	3520L1
							

Cross References List And Photo

Photo.....





S060381		S060382		S060383		S060384	
FIAT	1331939080	FIAT	1308601080	FIAT	1308600080	FIAT	1308760080
FIAT	1339466080	FIAT	1317241080	FIAT	1317240080	FIAT	1317239080
FIAT	1607301380	FIAT	1320787080	FIAT	1320786080	FIAT	1320756080
							





S060385		S060396		S060397		S060398	
FIAT	1308759080	CITROËN	352079	CITROËN	352078	DACIA	545011362R
FIAT	1317238080	CITROËN	95658979	CITROËN	95658978	DACIA	6001547520
FIAT	1320755080					DACIA	6001550446
							





S060399		S060400		S060401		S060402	
DACIA	545004269R	DAEWOO	96268440	CHEVROLET	96268439	CHEVROLET 96268455	
DACIA	6001547519	DAEWOO	96275014	CHEVROLET	96305974		
DACIA	6001550447	DAEWOO	96275015				
							

Cross References List And Photo

Photo.....





S060403	S060404	S060405	S060408
CHEVROLET 96268454	OPEL 352123 OPEL 352147 OPEL 352161	OPEL 352124 OPEL 352127 OPEL 352148	FIAT 46454597 FIAT 46539278 FIAT 46546777
			





S060409	S060414	S060415	S060417
FIAT 46454598 FIAT 46539279 FIAT 46546776	FIAT 46522142 FIAT 46764747 FIAT 51832938	FIAT 46525407 FIAT 46764746 FIAT 51832937	FIAT 46539000 FIAT 46777741 FIAT 46794065
			





S060418	S060419	S060420	S060422
FIAT 46454596 FIAT 46546774	FIAT 46454595 FIAT 46546775	FIAT 46539001 FIAT 46777742 FIAT 46794066	FIAT 5939683 FIAT 7705615
			

Cross References List And Photo

Photo.....

S060423		S060439		S060440		S060441	
FIAT	5939645	FORD	1028447	FORD	1012404	FORD	1061563
FIAT	5939685	FORD	1046458	FORD	1028441	FORD	1061565
FIAT	7705616	FORD	1046461	FORD	1046445	FORD	1148931
							





S060442		S060447		S060448		S060455	
FORD	1073215	FORD	1116579	FORD	1116578	FORD	1438315
FORD	1148932	FORD	1139928	FORD	1124016	FORD	1438316
FORD	1212810	FORD	1149803	FORD	1128483	FORD	1495666
							

S060456		S060459		S060460		S060461	
FORD	1438350	FORD	1058279	FORD	1058280	FORD	6193086
FORD	1735890	FORD	6525843	FORD	6525844	FORD	6645156
FORD	4042023	FORD	6615742	FORD	6615743	FORD	7152281
							

Cross References List And Photo

Photo.....





S060462		S060466		S060467		S060468	
FORD	6193085	FORD	1009582	FORD	1009598	FORD	1023028
FORD	6645154	FORD	1046039	FORD	1046073	FORD	1030278
FORD	7152278	FORD	1710791	FORD	1058331	FORD	1043158
							

S060469		S060470		S060471		S060472	
FORD	1023026	FORD	1003585	FORD	1015260	FORD	1385594
FORD	1030277	FORD	1009596	FORD	1021219	FORD	1403410
FORD	1043159	FORD	1015264	FORD	1045655	FORD	1419815
							





S060473		S060475		S060478		S060479	
FORD	1469024	FORD	1520778	FORD	1234375	FORD	1234371
FORD	1507181	FORD	1532421	FORD	1254311	FORD	1254310
VOLVO	31200775	FORD	1700809	FORD	1305342	FORD	1305341
							

Cross References List And Photo

Photo.....





S060480		S060481		S060482		S060483	
FORD	F5TZ3082A	HONDA	51460SR0A02	HONDA	51450SR0A02	HONDA	51450SM1A03
		HONDA	51460SR3003	HONDA	51450SR3003	HONDA	51450SM4003
		HONDA	51460SR3013	HONDA	51450SR3013	HONDA	51450SM4013
							





S060484		S060489		S060490		S060491	
HONDA	51460SM1A03	HONDA	51460S1AE01	HONDA	51450S1AE01	HONDA	51350S01000
HONDA	51460SM4003	HONDA	51460S2X003	HONDA	51450S2X003	HONDA	51350S04000
HONDA	51460SM4013	HONDA	51460S84A01	HONDA	51450S84A01	HONDA	51350S04G00
							





S060492		S060493		S060494		S060495	
HONDA	51360S01000	HONDA	51460S01003	HONDA	41450S04003	HONDA	52400SH0A00
HONDA	51360S04000	HONDA	51460S01013	HONDA	51450S01003	HONDA	52400SH3000
HONDA	51360S04G00	HONDA	51460S01023	HONDA	51450S01023	HONDA	52400SR3000
							

Cross References List And Photo

Photo.....





S060496		S060499		S060500		S060501	
HONDA	52390SH0A00	HONDA	51365S1AE00	HONDA	51355S1AE00	HONDA	51365SV4000
HONDA	52390SH3000	HONDA	51365S84A00	HONDA	51355S84A00	HONDA	51365SV7A00
HONDA	52390SR3000						
							





S060502		S060503		S060504		S060505	
HONDA	51355SV4000	HONDA	51460S10000	HONDA	51450S10000	HONDA	51360S10000
HONDA	51355SV7A00	HONDA	51460S10010	HONDA	51450S10010	HONDA	51360S10A00
		HONDA	51460S10020	HONDA	51450S10020	HONDA	51360S10G00
							





S060506		S060508		S060509		S060512	
HONDA	51350S10000	HONDA	51360S9A000	HONDA	51350S9A010	HONDA	51360SWAA20
HONDA	51350S10A00	HONDA	51360S9A010	HONDA	51350S9AA00	HONDA	51360SWAE00
HONDA	51350S10G00	HONDA	51360S9AA00	HONDA	51350S9AA01	HONDA	51360SWAE01
							

Cross References List And Photo

Photo.....



S060513		S060514		S060515		S060516	
HONDA	51350SWAA01	HONDA	51350SR3020	HONDA	51360SR3020	HYUNDAI	5450126000
HONDA	51350SWAA20	HONDA	51350SR3A01	HONDA	51360SR3A01		
HONDA	51350SWAE01	HONDA	51350ST3E02	HONDA	51360SR3A02		
							





S060517		S060520		S060521		S060526	
HYUNDAI	5450226000	HYUNDAI	5450002000	HYUNDAI	5450102050	HYUNDAI	545002D000
		HYUNDAI	5450002050	HYUNDAI	5450102051	HYUNDAI	545002D001
		HYUNDAI	5450002051	HYUNDAI	5450102052	HYUNDAI	545002D002
							

S060527		S060536		S060537		S060538	
HYUNDAI	545012D000	HYUNDAI	5441043002	HYUNDAI	5443043002	HYUNDAI	5441038000
HYUNDAI	545012D001	HYUNDAI	5441043004	HYUNDAI	5443043004	HYUNDAI	5441038600
HYUNDAI	545012D002	HYUNDAI	5441043005	HYUNDAI	5443043005		
							

Cross References List And Photo

Photo.....

S060539		S060540		S060541		S060542	
HYUNDAI	5442038000	HYUNDAI	5450038000	HYUNDAI	5450138000	HYUNDAI	545002H000
HYUNDAI	5442038600	HYUNDAI	5450038010	HYUNDAI	5450138010	HYUNDAI	545002H100
HYUNDAI	544203F100	HYUNDAI	5450038620	HYUNDAI	5450138620		
							

S060543		S060544		S060545		S060548	
HYUNDAI	545012H000	KIA	5450007100	KIA	5450107100	KIA	545203E000
HYUNDAI	545012H100	KIA	5450007150	KIA	5450107150	KIA	545203E001
		KIA	5450007200	KIA	5450107200	KIA	545203E002
							





S060549		S060554		S060555		S060556	
KIA	545103E000	LAND ROVER	LR002624	LAND ROVER	LR002625	MAZDA	GA2A34350
KIA	545103E001	LAND ROVER	LR007205	LAND ROVER	LR007206	MAZDA	GA2A34350A
KIA	545103E002					MAZDA	GA2B34350A
							

Cross References List And Photo

Photo.....





S060557		S060575		S060576		S060577	
MAZDA	GA2A34300A	MERCEDES-BENZ	1703300107	MERCEDES-BENZ	1703300207	MERCEDES-BENZ	2103303507
MAZDA	GA2B34300	MERCEDES-BENZ	2023302607	MERCEDES-BENZ	2023302707	MERCEDES-BENZ	2103304507
MAZDA	GA2B34300A	MERCEDES-BENZ	2023304107	MERCEDES-BENZ	2023304207	MERCEDES-BENZ	2103306207
							





S060578		S060579		S060580		S060581	
MERCEDES-BENZ	2103303407	MERCEDES-BENZ	1243303807	MERCEDES-BENZ	1243303907	MERCEDES-BENZ	1243303007
MERCEDES-BENZ	2103306107	MERCEDES-BENZ	2013303807	MERCEDES-BENZ	2013303907	MERCEDES-BENZ	A1243303007
MERCEDES-BENZ	2103307607	MERCEDES-BENZ	A1243303807	MERCEDES-BENZ	A1243303907		
							





S060582		S060593		S060594		S060607	
MERCEDES-BENZ	1243303107	MERCEDES-BENZ	1633330001	MERCEDES-BENZ	1633330101	mitsubishi	MB907116
MERCEDES-BENZ	A1243303107	MERCEDES-BENZ	A1633330001	MERCEDES-BENZ	A1633330101	mitsubishi	MB907164
						mitsubishi	MB907166
							

Cross References List And Photo

Photo.....

S060608		S060609		S060610		S060613	
mitsubishi	MB907115	mitsubishi	MB912506	mitsubishi	MB912505	mitsubishi	MB912509
mitsubishi	MB907163	mitsubishi	MB912508	mitsubishi	MB912507	mitsubishi	MR162579
mitsubishi	MB907165	mitsubishi	MR162804	mitsubishi	MR162803	mitsubishi	MR296295
							





S060614		S060615		S060616		S060617	
mitsubishi	MB912510	mitsubishi	MB912511	mitsubishi	MB912512	mitsubishi	MB809220
mitsubishi	MR296296	mitsubishi	MR162581	mitsubishi	MR162582	mitsubishi	MR491345
mitsubishi	MR325576	mitsubishi	MR162583	mitsubishi	MR162584	volvo	30818096
							





S060618		S060621		S060622		S060645	
mitsubishi	MB809221	volvo	30821650	volvo	30821651	nissan	545000QAH
mitsubishi	MR491346	volvo	30863988	volvo	30863989	renault	7700313945
volvo	30818097	volvo	30883988	volvo	30883989	renault	7700425228
							

Cross References List And Photo

Photo.....

S060646		S060647		S060648		S060675	
NISSAN	5450100QAH	NISSAN	5450100QAC	NISSAN	5450000QAC	RENAULT	7700413493
RENAULT	7700310809	NISSAN	5450100QAD	NISSAN	5450000QAD	RENAULT	7700823097
RENAULT	7700313944	OPEL	4404047	OPEL	4404048		
							



S060676		S060677		S060678		S060688	
DACIA	7700676325	RENAULT	7700820028	RENAULT	7700820029	RENAULT	8200298454
RENAULT	7700413494	RENAULT	8200737125	RENAULT	8200737126	RENAULT	8200457208
RENAULT	7700823098					RENAULT	8200679063
							





S060689		S060692		S060693		S060702	
RENAULT	8200298455	RENAULT	8200026655	RENAULT	8200026654	RENAULT	7700436303
RENAULT	8200457209	RENAULT	8200232032	RENAULT	8200232030	RENAULT	7700781035
RENAULT	8200679067	RENAULT	8200602613	RENAULT	8200602612	RENAULT	7700818052
							

Cross References List And Photo

Photo.....

S060703		S060708		S060709		S060716	
RENAULT	7700425724	RENAULT	545008682R	RENAULT	545014055R	SEAT	6Q0407151D
RENAULT	7700430765	RENAULT	545009207R	RENAULT	545018194R	SEAT	6Q0407151E
RENAULT	8200737132					SEAT	6Q0407151L
							

S060719		S060724		S060725		S060726	
SEAT	191407151B	SUZUKI	4520260G00	SUZUKI	4520160G00	SUZUKI	4520265D00
SEAT	191407153	SUZUKI	4520260G00000	SUZUKI	4520160G00000	SUZUKI	4520265D00000
VW	191407151A	SUZUKI	4520263G01	SUZUKI	4520163G01	SUZUKI	4520265D01000
							





S060727		S060731		S060735		S060737	
SUZUKI	4520165D00	TOYOTA	4806942010	TOYOTA	4806802010	TOYOTA	4806906040
SUZUKI	4520165D01000	TOYOTA	4806942012	TOYOTA	4806812160	TOYOTA	4806933030
SUZUKI	4520167D01	TOYOTA	4806942022	TOYOTA	4806812170	TOYOTA	4806933031
							

Cross References List And Photo

Photo.....





S060738		S060743		S060744		S060747	
LEXUS	4806806040	TOYOTA	4806902020	TOYOTA	4806802020	TOYOTA	4806902010
LEXUS	4806833030	TOYOTA	4806902021	TOYOTA	4806802030	TOYOTA	4806912160
		TOYOTA	4806902070	TOYOTA	4806802070	TOYOTA	4806912170
							





S060758		S060760		S060761		S060762	
VW	357407151	VW	7H0407151E	VW	7H0407152E	AUDI	3C0407151A
VW	357407153	VW	7H0407151F	VW	7H0407152F	SEAT	3C0407151B
		VW	7H0407151G	VW	7H0407152G	SEAT	3C0407151E
							



S060765		S060767		S060768		S060769	
VW	1H0407151	VOLVO	30635229	VOLVO	30635230	VOLVO	272341
		VOLVO	30736378	VOLVO	30736379	VOLVO	274452
		VOLVO	8623957	VOLVO	8623958		
							

Cross References List And Photo

Photo.....





S060770		S060771		S060772		S060775	
VOLVO	272340	VOLVO	271629	VOLVO	271628	VOLVO	272273
VOLVO	274446	VOLVO	271902	VOLVO	271901	VOLVO	272336
VOLVO	274451	VOLVO	8628492	VOLVO	8628491	VOLVO	8628493
							

S060776		S060777		S060778		S060781	
VOLVO	272227	VOLVO	30635227	VOLVO	30635228	AUDI	895407148A
VOLVO	272274	VOLVO	30736376	VOLVO	30736377		
VOLVO	272337	VOLVO	8623955	VOLVO	8623956		
							





S060792		S060795		S060796		S060798	
SUZUKI	4520060820	ALFA ROMEO	51777717	ALFA ROMEO	51777718	AUDI	8D0407505D
SUZUKI	4520060820000	FIAT	60622623	FIAT	60622624	AUDI	8D0407505L
SUZUKI	4520260B01	FIAT	60651935	FIAT	60651934	AUDI	8E0407505C
							

Cross References List And Photo

Photo.....

S060799		S060801		S060802		S060803	
AUDI	8D0407506D	AUDI	8E0407510C	AUDI	8K0407505A	AUDI	8K0407506A
AUDI	8D0407506E	AUDI	8E0407510E	AUDI	8K0407505F	AUDI	8K0407506F
AUDI	8D0407506L	AUDI	8E0407510P	AUDI	8K0407505N	AUDI	8K0407506N
							

S060804		S060805		S060806		S060807	
AUDI	8K0407509A	AUDI	8K0407510A	AUDI	8K0407151F	AUDI	8K0407152F
AUDI	8K0407509F	AUDI	8K0407510F	AUDI	8K0407151G	AUDI	8K0407152G
AUDI	8K0407509N	AUDI	8K0407510N				
							





S060808		S060809		S060810		S060813	
AUDI	7L0505323A	MINI	31124048627	MINI	31124048628	CHRYSLER	4656731AD
AUDI	7L0505375A	MINI	31126772301	MINI	31126772302	CHRYSLER	4656731AE
PORSCHE	95533104710					CHRYSLER	4656731AF
							

Cross References List And Photo

Photo.....





S060814		S060819		S060820		S060823	
CHRYSLER	04656730AD	CITROËN	3521S9	CITROËN	3520W7	FORD	1054985
CHRYSLER	04656730AE	CITROËN	3521T0	CITROËN	3520W8	FORD	6555474
CHRYSLER	04656730AF	CITROËN	3521T3	CITROËN	3520X1	FORD	6645157
							





S060833		S060834		S060835		S060836	
KIA	0K55234350A	KIA	0K55234300A	HYUNDAI	545001F000	HYUNDAI	545011F000
KIA	0K55234350B	KIA	0K55234300B	HYUNDAI	545001F100	HYUNDAI	545011F100
KIA	0K55234350C	KIA	0K55234300C	HYUNDAI	545002E000	HYUNDAI	545012E000
							

S060841		S060842		S060846		S060847	
LAND ROVER	RBJ102450	LAND ROVER	RBJ102440	LAND ROVER	RBJ000062	LAND ROVER	LR018344
LAND ROVER	RBJ102930	LAND ROVER	RBJ102920	LAND ROVER	RBJ500710	LAND ROVER	RBJ000130
LAND ROVER	RBJ500690	LAND ROVER	RBJ500680	LAND ROVER	RBJ500920		
							

Cross References List And Photo

Photo.....

S060848	S060849	S060850	S060851
LAND ROVER LR018343 LAND ROVER RBJ000120	LAND ROVER LR028252 LAND ROVER LR029306 LAND ROVER RBJ500450	LAND ROVER LR028248 LAND ROVER LR029304 LAND ROVER RBJ500440	MERCEDES-BENZ 1683300907 MERCEDES-BENZ 1683301207 MERCEDES-BENZ 1683301807
			





S060852	S060854	S060855	S060864
MERCEDES-BENZ 1683300807 MERCEDES-BENZ 1683301107 MERCEDES-BENZ 1683301707	CHRYSLER 68012165AA VW 2E0407151L VW 2E0407151M	CHRYSLER 68012164AA VW 2E0407152L VW 2E0407152M	NISSAN 54501BB00A NISSAN 54501BR30A RENAULT 545055212R
			

S060865	S060873	S060874	S060879
NISSAN 54500BB00A NISSAN 54500BR30A RENAULT 545040445R	OPEL 4418629 RENAULT 8200750273 VAUXHALL 93194853	NISSAN 5450000Q0E OPEL 4418630 RENAULT 8200750274	PEUGEOT 3520L8 PEUGEOT 3520S3 PEUGEOT 3520V7
			

Cross References List And Photo

Photo.....





S060880		S060883		S060884		S060886	
PEUGEOT	3521E7	CITROËN	1643189180	CITROËN	1610938080	CITROËN	3520V0
PEUGEOT	3521K2	CITROËN	3521R3	CITROËN	1643188780	CITROËN	3520X9
PEUGEOT	3521R7	PEUGEOT	1610938180	CITROËN	3520V2	MITSUBISHI	4013A009
							

S060887		S060904		S060905		S060907	
CITROËN	3521R1	SUBARU	200200AC200F	SUBARU	200200AC210F	SUZUKI	4520050E00
CITROËN	3521V0	SUBARU	20200AA040	SUBARU	20200AA050	SUZUKI	4520069D00
MITSUBISHI	4013A010	SUBARU	20200AA200	SUBARU	20200AA210	SUZUKI	4520069DV0
							





S060914		S060915		S060916		S060917	
TOYOTA	4806842012	TOYOTA	4806942040	TOYOTA	4806842040	TOYOTA	480690R010
TOYOTA	4806842022	TOYOTA	4806942041	TOYOTA	4806842041	TOYOTA	4806942050
						TOYOTA	4806942051
							

Cross References List And Photo

Photo.....

S060918		S060921		S060922		S060939	
TOYOTA	4806842050	FORD	1420858	FORD	1420859	NISSAN	5450141U00
TOYOTA	4806842051	FORD	1488111	FORD	1488110	NISSAN	5450141U01
TOYOTA	4806842060	FORD	1570285	FORD	1570284	NISSAN	5450141U02
							

S060940		S060952		S060953		S060954	
INFINITI	5450041U02	NISSAN	545002Y411	NISSAN	545012Y411	MITSUBISHI	MB809223
NISSAN	5450041U00	NISSAN	545002Y412	NISSAN	545012Y412	MITSUBISHI	MB910842
NISSAN	5450041U01	NISSAN	545002Y470	NISSAN	545015Y720	MITSUBISHI	MR491348
							

S060955		S060956		S060957		S060985	
MITSUBISHI	MB809222	MITSUBISHI	MB831035	MITSUBISHI	MB831036	FORD	YS4Z3078BA
MITSUBISHI	MB910841	MITSUBISHI	MR124879	MITSUBISHI	MR124880		
MITSUBISHI	MR491347	MITSUBISHI	MR296093	MITSUBISHI	MR296094		
							

Cross References List And Photo

Photo.....

S060986		S061002		S061026		S061027	
FORD	YS4Z3079BA	ALFA ROMEO	4332457	KIA	5450107160	KIA	5450007160
		AUTOBIANCHI	4338056	KIA	5450107161	KIA	5450007161
		AUTOBIANCHI	4362467	KIA	5450107361	KIA	5450007361
							

S061028		S061029		S061044		S061045	
SEAT	5U0407152A	SEAT	5U0407151A	NISSAN	545010W000	NISSAN	545000W000
				NISSAN	545010W001	NISSAN	545000W001
							

S061050		S061051		S061052		S061053	
HYUNDAI	544103F600	HYUNDAI	544203F600	MITSUBISHI	MR241342	MITSUBISHI	MR241341
HYUNDAI	544103F601	HYUNDAI	544203F601	MITSUBISHI	MR241344	MITSUBISHI	MR241343
HYUNDAI	544103K000	HYUNDAI	544203K000	MITSUBISHI	MR439702	MITSUBISHI	MR439701
							

Cross References List And Photo

Photo.....





S061056	S061057	S061063	S061064
MITSUBISHI 4013A256 MITSUBISHI 4013A274 MITSUBISHI MR403420	MITSUBISHI 4013A255 MITSUBISHI 4013A273 MITSUBISHI MR403419	MITSUBISHI 4010A037 MITSUBISHI 4010A041 MITSUBISHI 4010A139	MITSUBISHI 4010A038 MITSUBISHI 4010A042 MITSUBISHI 4010A140
			

S061071	S061072	S061079	S061080
FIAT 71742731 SUZUKI 4520154L00 SUZUKI 4520179J00	FIAT 71742732 SUZUKI 4520254L00 SUZUKI 4520279J00	MITSUBISHI 4013A131 MITSUBISHI MN101741 MITSUBISHI MR961391	MITSUBISHI 4013A132 MITSUBISHI MN101742 MITSUBISHI MR961392
			





S061087	S061088	S061105	S061106
MITSUBISHI MB809231 MITSUBISHI MB809233	MITSUBISHI MB809230 MITSUBISHI MB809232	KIA 545002D002A KIA 545002F000 KIA 545002F001	KIA 545012F000 KIA 545012F001 KIA 545012F501
			

Cross References List And Photo

Photo.....

S061107		S061108		S061110		S061111	
HYUNDAI	545003K000	HYUNDAI	545013K000	DAIHATSU	4806987401	DAIHATSU	4806887401
HYUNDAI	545003K060	HYUNDAI	545013K060	DAIHATSU	4806987402	DAIHATSU	4806887403
HYUNDAI	545003K500	HYUNDAI	545013K500	DAIHATSU	4806987403	DAIHATSU	4806887405
							

S061112		S061113		S061118		S061119	
HYUNDAI	545004H000	HYUNDAI	545014H000	NISSAN	54501CC40A	NISSAN	54500CC40A
				NISSAN	54501CC40B	NISSAN	54500CC40B
				NISSAN	54501CC40E	NISSAN	54500CC40E
							





S061120		S061121		S061124		S061125	
HONDA	51360SNAA03	HONDA	51350SNAA03	HONDA	51460SS0003	HONDA	51450SS0003
				HONDA	51460SS0A01	HONDA	51450SS0A01
							

Cross References List And Photo

Photo.....

S061136		S061137		S061150		S061151	
DAIHATSU	4806897202	DAIHATSU	4806997202	BMW	31126775963	BMW	31126775964
DAIHATSU	4806897203	DAIHATSU	4806997203	BMW	31126798107	BMW	31126798108
DAIHATSU	4806897203000	DAIHATSU	4906997202	BMW	31126850781	BMW	31126850782
							

S061152		S061153		S061154		S061155	
BMW	31124083311	BMW	31124083312	BMW	31126775967	BMW	31126776417
BMW	31126775959	BMW	31126775960			BMW	31126863785
BMW	4083311	BMW	4083312			BMW	6776417
							

S061156		S061164		S061165		S061166	
BMW	31126776418	BMW	31121096985	BMW	31121096986	BMW	31126775971
BMW	31126863786	BMW	31126750223	BMW	31126750224		
BMW	6776418	BMW	31126752317	BMW	31126752318		
							

Cross References List And Photo

Photo.....



S061167		S061168		S061169		S061172	
BMW	31126775972	BMW	31126794203	BMW	31126794204	DODGE	05105041AA
						DODGE	05105041AB
						DODGE	05105041AC
							

S061173		S061174		S061175		S061176	
DODGE	05105040AA	CHRYSLER	4782613AC	CHRYSLER	4782612AC	CHRYSLER	04782561AE
DODGE	05105040AB	CHRYSLER	5180607AA	CHRYSLER	5180606AA	CHRYSLER	4782561AC
DODGE	05105040AC	CHRYSLER	5180607AB	CHRYSLER	5180606AB	CHRYSLER	4782561AE
							

S061179		S061180		S061184		S061185	
JEEP	52088217	JEEP	52088355	CHRYSLER	05290829AA	CHRYSLER	05290828AA
JEEP	52088217AB	JEEP	52088355AB	CHRYSLER	05290829AB	CHRYSLER	05290828AB
JEEP	52088217AD	JEEP	52088355AD	CHRYSLER	5290829AA	CHRYSLER	5290828AA
							

Cross References List And Photo

Photo.....





S061189		S061219		S061231		S061232	
JEEP	05105272AA	FORD	1381443	HONDA	51360TA0A00	HONDA	51350TA0A00
JEEP	5105272AB	FORD	1426770				
JEEP	5105272AE	VOLVO	31262930				
							

S061251		S061252		S061253		S061254	
HYUNDAI	545002B000	HYUNDAI	545012B000	HYUNDAI	545104B000	HYUNDAI	545404B000
HYUNDAI	545002B100	HYUNDAI	545012B100	HYUNDAI	545104B001	HYUNDAI	545404B001
HYUNDAI	545002B500	HYUNDAI	545012B500	HYUNDAI	545104F000	HYUNDAI	545404F000
							





S061255		S061256		S061257		S061258	
HYUNDAI	5440147000	HYUNDAI	5440047000	HYUNDAI	545002V000	HYUNDAI	545012V000
HYUNDAI	544014A000	HYUNDAI	544004A000	HYUNDAI	545003X000	HYUNDAI	545013X000
HYUNDAI	544014A600	HYUNDAI	544004A600				
							

Cross References List And Photo

Photo.....

S061259		S061260		S061263		S061268	
HYUNDAI	545002S000	HYUNDAI	545012S000	KIA	0K01134200	KIA	544103E000
HYUNDAI	545002Y001	HYUNDAI	545012Y001	KIA	0K01134200A	KIA	544103E001
HYUNDAI	545002Y002	HYUNDAI	545012Y002			KIA	544103E002
							





S061269		S061270		S061271		S061275	
KIA	544203E000	KIA	545001D000	KIA	545011D000	HYUNDAI	54500A2700
KIA	544203E001					HYUNDAI	54500A6200
KIA	544203E002						
							





S061276		S061279		S061280		S061286	
HYUNDAI	54501A6200	KIA	0K2NA34350	KIA	0K2NA34300	FORD	1223951
		KIA	0K2NA34350A	KIA	0K2NA34300A	FORD	1231454
		KIA	0K2NA34350B	KIA	0K2NA34300B	FORD	1253733
							

Cross References List And Photo

Photo.....

S061294	S061295	S061302	S061303
<p>MERCEDES-BENZ 2213300307 MERCEDES-BENZ 2213308907 MERCEDES-BENZ A2213300307</p> 	<p>MERCEDES-BENZ 2213300407 MERCEDES-BENZ 2213309007 MERCEDES-BENZ A2213300407</p> 	<p>MERCEDES-BENZ 1633300807</p> 	<p>MERCEDES-BENZ 1633300907</p> 





S061305	S061306	S061307	S061308
<p>MERCEDES-BENZ 2513300807 MERCEDES-BENZ 2513302600 MERCEDES-BENZ A2513302600</p> 	<p>MERCEDES-BENZ 2513300707 MERCEDES-BENZ 2513302500 MERCEDES-BENZ A2513302500</p> 	<p>MERCEDES-BENZ 1643301807 MERCEDES-BENZ 1643302607 MERCEDES-BENZ 1643303007</p> 	<p>MERCEDES-BENZ 1643301707 MERCEDES-BENZ 1643302507 MERCEDES-BENZ 1643303407</p> 





S061309	S061310	S061321	S061322
<p>MERCEDES-BENZ 2213307107 MERCEDES-BENZ 2213308707 MERCEDES-BENZ A2213307107</p> 	<p>MERCEDES-BENZ 2213307207 MERCEDES-BENZ 2213308807 MERCEDES-BENZ A2213307207</p> 	<p>MINI 4010A013 MITSUBISHI 4010A103 MITSUBISHI 4010A117</p> 	<p>MINI 4010A014 MITSUBISHI 4010A104 MITSUBISHI 4010A118</p> 

Cross References List And Photo

Photo.....

S061338		S061339		S061344		S061345	
NISSAN	54524EB300	NISSAN	54525EB300	NISSAN	54500EB300	NISSAN	54501EB300
NISSAN	54524EB30A	NISSAN	54525EB30A	NISSAN	54500EB31A	NISSAN	54501EB31A
							

S061358		S061365		S061366		S061369	
PORSCHE	99634105305	LEXUS	4806906070	TOYOTA	4806806070	LEXUS	4863060020
PORSCHE	99634105306	LEXUS	4806933060	TOYOTA	4806818120	LEXUS	4863060040
PORSCHE	99634105307	TOYOTA	4806928120	TOYOTA	4806828120		
							

S061370		S061371		S061372		S061389	
LEXUS	4861060050	TOYOTA	480690K040	TOYOTA	480680K040	VOLVO	30681487
LEXUS	4861060070	TOYOTA	480690K050	TOYOTA	480680K050	VOLVO	31277525
						VOLVO	31317665
							

Cross References List And Photo

Photo.....

S061390		S061397		S061398		S061399	
VOLVO	30681488	AUDI	8K0505323D	AUDI	8K0505324D	AUDI	2H0407151A
VOLVO	31277526	AUDI	8K0505323F	AUDI	8K0505324F		
VOLVO	31317666	AUDI	8K0505323H	AUDI	8K0505324H		
							

S061400		S061401		S061402		S061407	
AUDI	2H0407152A	AUDI	2H0407021B	VW	2H0407022A	AUDI	1K0505223E
		VW	2H0407021A	VW	2H0407022B	AUDI	1K0505223H
						AUDI	1K0505223K
							





S061408		S061409		S061410		S061415	
AUDI	1K0505224E	VW	7D0407151A	AUDI	7D0407152A	CHRYSLER	04616922
AUDI	1K0505224H					CHRYSLER	4616922
AUDI	1K0505224K						
							

Cross References List And Photo

Photo.....

S061416	S061425	S061448	S061449
CHRYSLER 4616923	HONDA 52350S04000	TOYOTA 4806960010	TOYOTA 4806860010
			

S061450	S061451	S061453	S061454
TOYOTA 486100K040	TOYOTA 4863004020 TOYOTA 4863004021 TOYOTA 486300K040	TOYOTA 4806816100 TOYOTA 4806816120	TOYOTA 4806916100 TOYOTA 4806916120
			





S061457	S061461	S061462	S061468
CHRYSLER 4616403	FORD 1F6035211A FORD 2L5Z3083AA FORD USA F5TZ3083A	FORD 5026931 FORD USA 1F2034211A FORD USA 6L5Z3084AA	AUDI 1K0505311AA AUDI 1K0505311AB AUDI 1K0505311H
			

Cross References List And Photo

Photo.....

S061472		S061480		S061481		S061482	
JAGUAR	C2S19669	NISSAN	551A1EB300	NISSAN	551A0EB300	SEAT	1S0407151
JAGUAR	C2S20741	NISSAN	551A1EB31A	NISSAN	551A0EB31A		
JAGUAR	C2S25024						
							



S061483		S061484		S061485		S061486	
SEAT	1S0407152	AUDI	6R0407151	SEAT	6R0407152	SSANGYONG	4450108000
		AUDI	6R0407151E	SEAT	6R0407152ES1	SSANGYONG	4450108005
		SEAT	6R0407151ES1	SEAT	6R0407152S1	SSANGYONG	4450108006
							

S061487		S061488		S061492		S061493	
SSANGYONG	4450208000	SSANGYONG	4450109001	VW	561407151A	VW	561407152A
SSANGYONG	4450208005	SSANGYONG	4450109002	VW	561407151C	VW	561407152C
SSANGYONG	4450208006	SSANGYONG	4450109003				
							

Cross References List And Photo

Photo.....



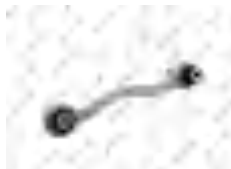

S061504		S061506		S061526		S061527	
FORD	F65Z3084AB	AUDI	4F0501529C	HONDA	51520TA0A02	HONDA	51510TA0A03
FORD USA	F75Z3084AA	AUDI	4F0501529E	HONDA	51520TA0A03		
FORD USA	XL3Z3084AA						
							

S061530		S061531		S061566		S061567	
HYUNDAI	5511038000	HYUNDAI	5512038000	MERCEDES-BENZ	2043500553	MERCEDES-BENZ	2043500653
HYUNDAI	5511038600	HYUNDAI	5512038600	MERCEDES-BENZ	2053506503	MERCEDES-BENZ	2053506603
HYUNDAI	5511038601	HYUNDAI	5512038601	MERCEDES-BENZ	A2043500553	MERCEDES-BENZ	A2043500653
							



S061574		S061575		S061576		S061577	
AUDI	8K0501529K	AUDI	8K0501530K	BMW	33326775683	VW	5N0407151
AUDI	8K0501529N	AUDI	8K0501530N	BMW	6775683		
							

Cross References List And Photo

Photo.....



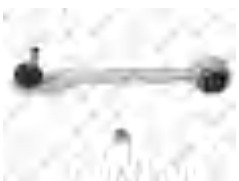

S061578		S061590		S061601		S061602	
VW	5N0407152	SUZUKI	4520081A10	AUDI	8K0407693T	AUDI	8K0407694T
		SUZUKI	4520081A10000				
		SUZUKI	4520081A11				
							



S061607		S061608		S061610		S061614	
MERCEDES-BENZ	2123302911	MERCEDES-BENZ	2123303011	VW	5C0407152A	BMW	31126851259
MERCEDES-BENZ	2123303900	MERCEDES-BENZ	2123304000	VW	5C0407152B	BMW	31126855741
MERCEDES-BENZ	A2123302911	MERCEDES-BENZ	A2123303011	VW	5C0407152D	BMW	6851259
							

S061615		S061616		S061617		S061621	
BMW	31126851260	BMW	31126852991	BMW	31126852992	FORD	4W4Z3085AA
BMW	31126855742					FORD	6W4Z3085AA
BMW	6851260					JAGUAR	XR81764
							

Cross References List And Photo

Photo.....

S061622		S061623		S061624		S061637	
FORD	4W4Z3084AA	JAGUAR	C2Z2279	JAGUAR	C2Z2278	MERCEDES-BENZ 2123302711	
FORD	6W4Z3084AA	JAGUAR	XR822285	JAGUAR	XR822284	MERCEDES-BENZ 2123302711S1	
JAGUAR	XR81763	JAGUAR	XR842383	JAGUAR	XR842382	MERCEDES-BENZ A2123302711	
							

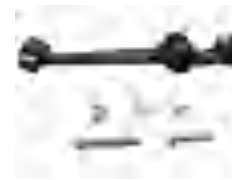



S061638		S061642		S061643		S061655	
MERCEDES-BENZ 2123302811		BMW	2405863	AUDI	1J0407151A	CHRYSLER 4616402	
MERCEDES-BENZ 2123302811S1		BMW	31122405863	AUDI	1J0407151B		
MERCEDES-BENZ A2123302811		BMW	31126768989	AUDI	1J0407151C		
							





S061656		S061657		S061658		S061663	
NISSAN	54469CD00C	NISSAN	54468CD00C	CITROËN	5175EH	FORD	1041683
				MITSUBISHI	4110A085	FORD	1093772
				MITSUBISHI	MR491911	FORD	1116608
							

Cross References List And Photo

Photo.....





S061664		S061671		S061672		S061673	
FORD	1072453	HYUNDAI	545001M100	HYUNDAI	545011M100	LAND ROVER	LR024473
FORD	6710265					LAND ROVER	LR045802
FORD	6829061					LAND ROVER	LR073522
							





S061674		S061677		S061678		S061681	
LAND ROVER	LR024472	MERCEDES-BENZ	1563300100	MERCEDES-BENZ	1563300200	DACIA	545010294R
LAND ROVER	LR045803	MERCEDES-BENZ	2463301707	MERCEDES-BENZ	2463301807	DACIA	545011727R
LAND ROVER	LR073521	MERCEDES-BENZ	2463304700	MERCEDES-BENZ	2463304800	DACIA	545017081R
							





S061682		S061685		S061686		S061688	
DACIA	545001064R	HYUNDAI	54502H1002	HYUNDAI	54503H1002	HYUNDAI	0K2A128600C
DACIA	545004529R	HYUNDAI	54512H1002	HYUNDAI	54513H1002		
DACIA	545006623R						
							

Cross References List And Photo

Photo.....

S061692		S061693		S061694		S061695	
NISSAN	551208H505	NISSAN	551208H500	CHERY	T112919010	HYUNDAI	5521038000
NISSAN	551208H515	NISSAN	551208H510	TOYOTA	4877042020		
							





S061698		S061699		S061700		S061701	
MITSUBISHI	4117A025	SUBARU	20252FG010	SUBARU	20252FG000	SUBARU	20250AE010
MITSUBISHI	MR990822						
							

S061703		S061704		S061705		S061706	
NISSAN	55501EB300	CHRYSLER	4782666AB	CHRYSLER	4782665AB	NISSAN	545019CD0A
NISSAN	55501EB31A	CHRYSLER	4782666AC	CHRYSLER	4782665AC	NISSAN	54501EA00A
		CHRYSLER	4782666AE	CHRYSLER	4782665AF	SUZUKI	4520282Z10
							

Cross References List And Photo

Photo.....





S061707		S061708		S061709		S061710	
NISSAN	54500EA00A	HYUNDAI	552202E500	KIA	545104E000	KIA	545404E000
		HYUNDAI	552202E600				
							

S061713		S061714		S061719		S061720	
TOYOTA	480690T011	TOYOTA	480680T011	LEXUS	4863059095	LEXUS	4861059095
TOYOTA	4806948040	TOYOTA	4806848040	TOYOTA	4863059135	TOYOTA	4861059135
TOYOTA	4806948041	TOYOTA	4806848041				
							

S061721		S061722		S061723		S061724	
LEXUS	4863059085	LEXUS	4861059085	LEXUS	4871050080	TOYOTA	4871050090
TOYOTA	4863059125	TOYOTA	4861059125				
							

Cross References List And Photo

Photo.....





S061726	S061757	S061758	S061763
TOYOTA 4870650020	SSANGYONG 4440109000 SSANGYONG 4440109001 SSANGYONG 4440109002	SSANGYONG 4440209000 SSANGYONG 4440209001 SSANGYONG 4440209002	MITSUBISHI MN150411 MITSUBISHI MR296267
			





S061764	S061765	S061766	S061773
MITSUBISHI MN150412 MITSUBISHI MR296268	LAND ROVER LR014133 LAND ROVER LR051615	LAND ROVER LR014132 LAND ROVER LR051614	BMW 33326792525 BMW 6792525
			





S061774	S061775	S061776	S061780
BMW 33326792533 BMW 6792533	BMW 33326792539 BMW 6792539	BMW 33326792540 BMW 6792540	INFINITI 54501CG200
			

Cross References List And Photo

Photo.....

S061781	S061790	S061791	S061805
INFiniti 54500CG200 	TOYOTA 4862059015 	TOYOTA 4864059015 	HYUNDAI 545003J000 

S061806	S061809	S061810	S061826
HYUNDAI 545013J000 	HYUNDAI 54400H1150 	HYUNDAI 54401H1150 	TOYOTA 480690K010 





S061827	S061840	S061841	S061848
TOYOTA 480680K010 	NISSAN 54500EB70A 	NISSAN 54501EB70A 	HONDA 52520TA0A02 

Cross References List And Photo

Photo.....

S061849		S061852		S061853		S061854	
HONDA	52510TA0A02	NISSAN	54501AM602	NISSAN	54500AM602	HONDA	52360SV4A10
							





S061855		S061861		S061867		S061908	
HONDA	52355SV4A10	JEEP	52090206AF	CHRYSLER	4743835AA	CHEVROLET	4766622AA
		JEEP	52090206AG	DODGE	4766623AA	CHRYSLER	4743834AA
		JEEP	52090206AH				
							

S061925		S061948		S061949		S061952	
JEEP	52088312	MITSUBISHI	MB860831	MITSUBISHI	MB860832	MITSUBISHI	4013A091
		MITSUBISHI	MN161353	MITSUBISHI	MN161354	MITSUBISHI	4013A381
							

Cross References List And Photo

Photo.....





S061953		S061954		S061955		S061956	
MITSUBISHI	4013A092	HYUNDAI	5450224000	HYUNDAI	5450324000	HYUNDAI	545002T010
MITSUBISHI	4013A382					HYUNDAI	545002T030
						HYUNDAI	545003S100
							

S061957		S061981		S061997		S061998	
HYUNDAI	545012T010	SSANGYONG	4450209001	TOYOTA	486300K010	TOYOTA	486100K010
HYUNDAI	545012T030	SSANGYONG	4450209002				
HYUNDAI	545013S100	SSANGYONG	4450209003				
							

S062001		S062002		S062013		S062014	
MITSUBISHI	4013A213	MITSUBISHI	4013A214	CHRYSLER	4895041AC	CHRYSLER	4895040AC
MITSUBISHI	MR496795	MITSUBISHI	MR496796	CHRYSLER	4895041AF	CHRYSLER	4895040AF
							

Cross References List And Photo

Photo.....

S062024		S062025		S062026		S062027	
AUDI	4H0407151A	AUDI	4H0407152A	AUDI	4H0407693C	AUDI	4H0407694C
AUDI	4H0407151B	AUDI	4H0407152B	AUDI	4H0407693D	AUDI	4H0407694D
AUDI	4H0407151C	AUDI	4H0407152C	AUDI	4H0407693E	AUDI	4H0407694E
							



S062028		S062029		S062030		S062031	
AUDI	4H0407505D	AUDI	4H0407506D	AUDI	4H0407509A	AUDI	4H0407510A
AUDI	4H0407505E	AUDI	4H0407506E	AUDI	4H0407509D	AUDI	4H0407510D
AUDI	4H0407505F	AUDI	4H0407506F	AUDI	4H0407509E	AUDI	4H0407510E
							

S062032		S062033		S062034		S062039	
AUDI	1K0407151AC	AUDI	1K0407152AC	CHRYSLER	04782836AA	LEXUS	4873050110
AUDI	1K0407151AD	AUDI	1K0407152AD	CHRYSLER	05180480AA	LEXUS	4873050111
AUDI	1K0407151M	AUDI	1K0407152M	CHRYSLER	DA782836AB		
							

Cross References List And Photo

Photo.....



S062045		S062046		S062049		S062050	
VOLVO	31262473	VOLVO	31262475	mitsubishi	MR316053	MITSUBISHI	MR316054
VOLVO	31340127	VOLVO	31340128	MITSUBISHI	MR589033	MITSUBISHI	MR589034
VOLVO	31429320	VOLVO	31429321				
							

S062053		S062054		S062055		S062060	
JEEP	52059623AA	FORD	YS4Z5500AA	JEEP	52088208	FORD	1070172
JEEP	52087710	FORD	YS4Z5500BA	JEEP	52088208AC	FORD	1124079
JEEP	52087711			JEEP	52088208AD	FORD	1138525
							





S062061		S062062		S062063		S062068	
FORD	1070171	CHRYSLER	4764409AB	CHRYSLER	4764408AB	MINI	31129804431
FORD	1124077	CHRYSLER	4764409AC	CHRYSLER	4764408AC	MINI	31129806519
FORD	4628189	CHRYSLER	4782975AA	CHRYSLER	4782974AA		
							

Cross References List And Photo

Photo.....

S062069		S062081		S062082		S062083	
MINI	31129804432	MERCEDES-BENZ	2153300307	SSANGYONG	4440109000	SSANGYONG	4440209010
MINI	31129806520	MERCEDES-BENZ	2153300607	SSANGYONG	4440109010	SSANGYONG	4440209011
		MERCEDES-BENZ	2153300707	SSANGYONG	4440109011		
							

S062086		S062087		S062090		S062095	
SUBARU	20202AG190	SUBARU	20202AG180	FORD	XL3Z3085AA	AUDI	7L0505311B
SUBARU	20202AG191	SUBARU	20202AG181	FORD USA	F65Z3085AB	PORSCHE	95533101711
SUBARU	20202FJ010	SUBARU	20202FJ000				
							





S062098		S062115		S062116		S062118	
NISSAN	54524EB70A	FORD	1731006	FORD	1723681	NISSAN	54501JL01A
NISSAN	54524EB70D	FORD	5232167	FORD	1725696	NISSAN	54501JL01B
NISSAN	54524EB72C	FORD	AB313091BD	FORD	5232166		
							

Cross References List And Photo

Photo.....

S062119		S062126		S062134		S062137	
NISSAN	54500JL01A	TOYOTA	4873033050	AUDI	5Q0407152G	AUDI	5Q0407151G
NISSAN	54500JL03B			VW	5Q0407152J	VW	5Q0407151J
				VW	5QM407152A	VW	5QM407151A
							

S062144		S062145		S062177		S062188	
MAZDA	UC3C34250D	MAZDA	UC3C34200D	AUDI	8K0407694AF	HYUNDAI	551002S100
MAZDA	UL0R34250	MAZDA	UL0R34200	AUDI	8K0407694S	HYUNDAI	551002S150
				AUDI	8KD407694C		
							





S062190		S062191		S062207		S062214	
HYUNDAI	552502W110	HYUNDAI	552501D000	VOLVO	30620786	SUZUKI	4620050830
HYUNDAI	552502W650	HYUNDAI	552501H000	VOLVO	30862174		
HYUNDAI	552503W100	HYUNDAI	552502S000	VOLVO	30862175		
							

Cross References List And Photo

Photo.....





S062222		S062241		S062261		S062298	
HYUNDAI	551002G000	VW	5C0407151A	AUDI	8K0407693AF	TOYOTA	4873048070
KIA	551001H000	VW	5C0407151B	AUDI	8K0407693S	TOYOTA	4874048030
		VW	5C0407151D	AUDI	8KD407693C		
							





S062311		S062312		S062328		S062331	
BMW	31126768983	BMW	31126768984	CHRYSLER	5105271AC	AUDI	4D0407509F
				MITSUBISHI	MN100086	AUDI	4D0407509G
				MITSUBISHI	MN100107	AUDI	4D0407509H
							

S062332		S062530		S062531		S062579	
AUDI	4D0407510F	AUDI	4Z7407505	AUDI	4Z7407506	LEXUS	4877042040
AUDI	4D0407510G	AUDI	8D0407505B	AUDI	4Z7407506A		
AUDI	4D0407510H	AUDI	8D0407505F	AUDI	8D0407506B		
							

Cross References List And Photo

Photo.....





S062580		S062622		S062623		S062629	
TOYOTA	4879042020	JEEP	52088637AD	JEEP	52088636AD	FORD	1686184
TOYOTA	4879042040	JEEP	52088637AF	JEEP	52088636AF	FORD	1752736
		JEEP	52088637AG	JEEP	52088636AG	VOLVO	31406582
							





S062634		S062645		S062646		S062657	
CITROËN	5175EG	MITSUBISHI	MB349943	MITSUBISHI	MB349944	BMW	31122405859
MITSUBISHI	4117A007					BMW	31126763699
MITSUBISHI	MR403485					BMW	31126770849
							





S062658		S062713		S062714		S062715	
BMW	31122405860	KIA	545002K200	KIA	545012K200	LAND ROVER	RBJ500231
BMW	31126763700	KIA	545002K500	KIA	545012K500	LAND ROVER	RBJ500232
BMW	31126770850						
							

Cross References List And Photo

Photo.....





S062716	S062717	S062718	S062719
LAND ROVER RBJ500221 LAND ROVER RBJ500222	LAND ROVER LR010527 LAND ROVER LR063718 LAND ROVER RGG500292	LAND ROVER LR010526 LAND ROVER LR063719 LAND ROVER RGG500282	LAND ROVER LR019978 LAND ROVER RGG500313 LAND ROVER RGG500314
			



S062720	S062738	S062739	S062740
LAND ROVER LR019977 LAND ROVER RGG500303 LAND ROVER RGG500304	MERCEDES-BENZ 2223302301	MERCEDES-BENZ 2223302401	MERCEDES-BENZ 2223300107 MERCEDES-BENZ A2223300107 MERCEDES-BENZ A222330010728
			



S062741	S062746	S062747	S062748
MERCEDES-BENZ 2223300207 MERCEDES-BENZ A2223300207 MERCEDES-BENZ A222330020728	NISSAN 54500AM601	NISSAN 54501AM601	AUDI 8K0505311G AUDI 8K0505311H AUDI 8K0505311J
			

Cross References List And Photo

Photo.....





S062749		S062750		S062751		S062758	
AUDI	8K0505312G	BMW	33324069467	BMW	33324069468	DAIMLER	2W933C255CA
AUDI	8K0505312H	BMW	33326782131	BMW	33326782132	DAIMLER	2W933C255CB
AUDI	8K0505312J					DAIMLER	2W933C255DA
							

S062759		S062774		S062782		S062783	
DAIMLER	2W933C254CA	HYUNDAI	5443044000	TOYOTA	4864050070	LEXUS	4862050070
DAIMLER	2W933C254CB						
DAIMLER	2W933C254DA						
							

S062784		S062789		S062790		S062791	
AUDI	7L0505312A	AUDI	3Q0407152F	AUDI	3Q0407151F	AUDI	5Q0501529C
AUDI	7L0505312B	AUDI	3Q0407152G	AUDI	3Q0407151G	AUDI	5Q0501529D
PORSCHE	95533101811	AUDI	3Q0407152S	AUDI	3Q0407151S	AUDI	5Q0501529E
							

Cross References List And Photo

Photo.....





S062796	S062797	S062798	S062799
INFINITI 551205DA0A MERCEDES-BENZ 2463501006 MERCEDES-BENZ A2463501006	MERCEDES-BENZ 2043501606 MERCEDES-BENZ 2053506203 MERCEDES-BENZ A2043501606	MERCEDES-BENZ 2043501506 MERCEDES-BENZ 2053506103 MERCEDES-BENZ A2043501506	MERCEDES-BENZ 2043500029 MERCEDES-BENZ 2043502706 MERCEDES-BENZ 2043521205
			

S062800	S062801	S062802	S062803
BMW 33326851569	MERCEDES-BENZ 2053305601 MERCEDES-BENZ A2053305601	MERCEDES-BENZ 2053305501 MERCEDES-BENZ A2053305501	INFINITI 555025DA0A MERCEDES-BENZ 2463500406 MERCEDES-BENZ A2463500406
			





S062805	S062806	S062807	S062810
MERCEDES-BENZ 2053301907 MERCEDES-BENZ 2053305901 MERCEDES-BENZ 2053306101	MERCEDES-BENZ 2053302007 MERCEDES-BENZ 2053306001 MERCEDES-BENZ 2053306201	MERCEDES-BENZ 2463500053 MERCEDES-BENZ A2463500053	HYUNDAI 552502S100
			

Cross References List And Photo

Photo.....

S062830		S062835		S062836		S062837	
FORD	1532433	CITROËN	9678311380	CITROËN	9678311280	BMW	31122785114
FORD	1700810	PEUGEOT	9807914280	PEUGEOT	9607914180S1	BMW	31126851204
FORD	1708226	PEUGEOT	9820381680	PEUGEOT	9678311280S2	BMW	31126879844
							

S062839		S062840		S062841		S062842	
BMW	33322406292	BMW	31122785113	CITROËN	9800596680	MERCEDES-BENZ	2053304507
BMW	33326763473	BMW	31126851203	CITROËN	9820081380	MERCEDES-BENZ	2053305801
BMW	33326763473S1	BMW	31126879843	PEUGEOT	9800596680S2	MERCEDES-BENZ	2053306710
							

S062843		S062844		S062845		S062869	
CITROËN	9800596580	MERCEDES-BENZ	2053301305	MERCEDES-BENZ	2053301405	NISSAN	55502EB300
CITROËN	9820081280	MERCEDES-BENZ	2053301505	MERCEDES-BENZ	2053301605	NISSAN	55502EB31A
		MERCEDES-BENZ	2053304303	MERCEDES-BENZ	2053304403	NISSAN	55504EB300
							

Cross References List And Photo

Photo.....





S062886		S062887		S062894		S062895	
MITSUBISHI 4013A235 MITSUBISHI MR594325	MITSUBISHI 4013A036 MITSUBISHI 4013A236 MITSUBISHI MR594326	KIA 544104E200	KIA 544204E200				





S062899		S062900		S062905		S062906	
AUDI 5Q0505311C AUDI 5Q0505311D VW 5Q0505311F	AUDI 3Q0505311F AUDI 3Q0505311G SKODA 3Q0505311E	SUBARU 20202AL010 SUBARU 20202AL011	SUBARU 20202AL000 SUBARU 20202AL001				





S062907		S062908		S062909		S062910	
SUBARU 20202SG010	SUBARU 20202SG000	SUBARU 20202FJ050 SUBARU 20202FJ051	SUBARU 20202FJ040 SUBARU 20202FJ041				

Cross References List And Photo

Photo.....





S062911		S062912		S062915		S062916	
SUBARU	20202AJ010	SUBARU	20202AJ000	FIAT	51939755	JEEP	51939751
SUBARU	20202AJ050	SUBARU	20202AJ040				
SUBARU	20219AJ000						
							





S062921		S062922		S062923		S062924	
SUBARU	20202SC010	SUBARU	20202SC000	SMART	4513300010	AUDI	8W0407151A
SUBARU	20202SC012	SUBARU	20202SC001	SMART	A4513300010	AUDI	8W0407151B
SUBARU	20202SC013	SUBARU	20202SC002			AUDI	8W0407151C
							

S062925		S062926		S062927		S062928	
AUDI	8W0407152A	AUDI	8W0407693A	AUDI	8W0407694A	AUDI	8W0407505A
AUDI	8W0407152B	AUDI	8W0407693B	AUDI	8W0407694B	AUDI	8W0407505C
AUDI	8W0407152C					AUDI	8W0407505E
							

Cross References List And Photo

Photo.....





S062929		S062930		S062931		S062932	
AUDI	8W0407506A	AUDI	8W0407509A	AUDI	8W0407510A	AUDI	4M0407505B
AUDI	8W0407506C	AUDI	8W0407509B	AUDI	8W0407510B	AUDI	4M0407505C
AUDI	8W0407506E	AUDI	8W0407509E	AUDI	8W0407510E	AUDI	80A407505
							

S062933		S062934		S062935		S062938	
AUDI	4M0407506B	AUDI	4M0407509B	AUDI	4M0407510B	AUDI	4M0407151E
AUDI	4M0407506C	AUDI	4M0407509C	AUDI	4M0407510C	AUDI	4M0407151F
AUDI	80A407506	AUDI	80A407509	AUDI	80A407510	AUDI	4M0407151H
							

S062939		S062950		S062951		S062952	
AUDI	4M0407152E	CITROËN	517847	FORD	1117857	HYUNDAI	55100A6000
AUDI	4M0407152F			FORD	1118920	HYUNDAI	55100A6005
AUDI	4M0407152H			FORD USA	1S715K652AB		
							

Cross References List And Photo

Photo.....

S062954		S062955		S062956		S062959	
CITROËN	5175CF	FORD	1117871	FORD	1117859	FORD	6701506
		FORD	1118922	FORD	1118921	FORD	6829059
		FORD	1124242	FORD	1S715K743AB	FORD	6867577
						FORD USA	93BB5K652AC
							

S062960		S062964		S062965		S062966	
TOYOTA	4878007010	AUDI	8K0501529L	AUDI	8E0501529F	BMW	33324069283
TOYOTA	4878033040			AUDI	8E0501529G	BMW	33326782135
TOYOTA	4878048020			AUDI	8E0501529K		
							

S062967		S062970		S062971		S062972	
BMW	33324069284	FORD	1719007	HYUNDAI	545002K300	HYUNDAI	545012K300
BMW	33326782136	FORD	1744422	HYUNDAI	545002K600	HYUNDAI	545012K600
		FORD	1787961				
							

Cross References List And Photo

Photo.....





S062973		S062974		S062976		S062977	
HONDA	52390SNA900	HONDA	52400SNA900	AUDI	5Q0407151G	AUDI	5Q0407152G
				AUDI	5Q0407153E	AUDI	5Q0407152J
				VAG	5QM407151A	AUDI	5Q0407154E
							



S062978		S062979		S062980		S062981	
JEEP	52001162	HONDA	51360T0AA02	HONDA	51350T0TH11	FIAT	51959809
		HONDA	51360T0TH11	HONDA	51350T1GE01	JEEP	68246739AA
		HONDA	51360T1GE01			JEEP	68309201AA
							

S062994		S062995		S063005		S063006	
TOYOTA	4873042020	TOYOTA	4872042020	AUDI	1K0407151AA	AUDI	1K0407152AA
				AUDI	1K0407151AE	AUDI	1K0407152AB
				AUDI	1K0407151AH	AUDI	1K0407152AE
							

Cross References List And Photo

Photo.....



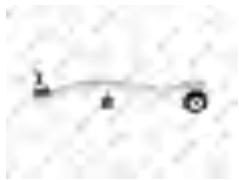

S063011		S063014		S063015		S063016	
HYUNDAI	551003Q000	CITROËN	3520G2	PEUGEOT	3521A1	PEUGEOT	3520A1
HYUNDAI	551003R000	PEUGEOT	1614447080	PEUGEOT	3521A3		
		PEUGEOT	3520F1	PEUGEOT	3521E3		
		PEUGEOT	3520F3				
		PEUGEOT	3520H3				
		PEUGEOT	3520H4				
							



S063017		S063020S		S063021S		S063022S	
PEUGEOT	352171	TESLA	102735100C	TESLA	104895100A	TESLA	104157000A
				TESLA	104895100B	TESLA	104157000B
				TESLA	600799700D	TESLA	600799800C
							



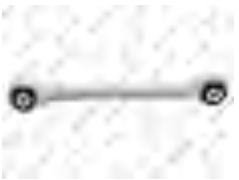
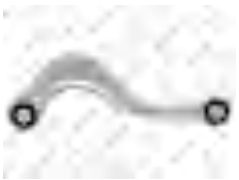

S063023S		S063024		S063025		S063026S	
TESLA	104157500A	TESLA	104396600B	TESLA	104396500B	TESLA	104435100C
TESLA	104157500B					TESLA	104435400A
TESLA	600666400C						
							

Cross References List And Photo

Photo.....





S063027S		S063028		S063029		S063030	
TESLA	104435600C	TESLA	102742600C	TESLA	102742100E	BMW	33326775902
TESLA	104435900A						
							

S063035		S063036		S063038		S063039	
PORSCHE	97033104300	PORSCHE	97033104700	PORSCHE	97034105304	PORSCHE	97034105404
							

S063043		S063044		S063045		S063046	
PORSCHE	99734104300	MINI	31122785111	MINI	31122785112	HONDA	52390S5A000
PORSCHE	99734114300	MINI	31126850397	MINI	31126850398		
		MINI	31126879841	MINI	31126879842		
							

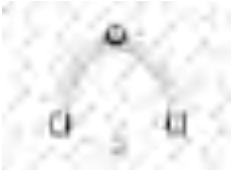
Cross References List And Photo

Photo.....





S063047	S063048	S063049	S063050
MERCEDES-BENZ 1663301707 MERCEDES-BENZ A1663301707 	MERCEDES-BENZ 1663301807 MERCEDES-BENZ A1663301807 	MERCEDES-BENZ 2043308111 MERCEDES-BENZ 2043308311 MERCEDES-BENZ A2043308111 	MERCEDES-BENZ 2043308211 MERCEDES-BENZ 2043308411 MERCEDES-BENZ A2043308211 





S063051	S063052	S063055	S063056
BMW 33326770969 BMW 33326796001 	BMW 33326770970 BMW 33326796002 	BMW 33326851563 BMW 33326870773 BMW 33326884693 	MERCEDES-BENZ 2463500506 MERCEDES-BENZ A2463500506 



S063061	S063066	S063067	S063068
TOYOTA 4870550030 	HYUNDAI 5527038000 	KIA 54500C5000 	KIA 54501C5000 

Cross References List And Photo

Photo.....





S063072	S063073	S063079	S063080
LAND ROVER LR034219 LAND ROVER LR045244 LAND ROVER LR072470	LAND ROVER LR034220 LAND ROVER LR045245 LAND ROVER LR072468	CHRYSLER 68217809AB JEEP 68217809AA	JEEP 68046196AG JEEP 68046196AH JEEP 68217808AA
			

S063082	S063083	S063084	S063085
AUDI 4Z7407693 AUDI 4Z7407693C AUDI 4Z7407693D	AUDI 4Z7407694 AUDI 4Z7407694C AUDI 4Z7407694D	AUDI 4Z7407151 AUDI 4Z7407151C	AUDI 7L8407021 PORSCHE 95834105100 VW 7P0407021
			





S063090	S063091	S063093	S063094
HYUNDAI 5525038000	HYUNDAI 552503Z000	TOYOTA 4873042010	AUDI 3C0505224B AUDI 3C0505224C AUDI 3C0505224D
			

Cross References List And Photo

Photo.....





S063095		S063099		S063100		S063101	
VW	3C0505223B	MERCEDES-BENZ	2043308011	BMW	31106787674	BMW	31106787673
VW	3C0505223C	MERCEDES-BENZ	A2043308011				
VW	3C0505223D						
							





S063105		S063106		S063115		S063116	
RENAULT	545050399R	RENAULT	545046817R	BMW	33322406288	BMW	33322406289
RENAULT	545050510R	RENAULT	545048506R	BMW	33322409890	BMW	33326782237
RENAULT	545052354R	RENAULT	545049968R	BMW	33326782238		
							

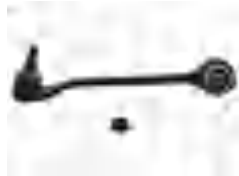



S063121		S063122		S063124		S063126	
HYUNDAI	5520026500	HYUNDAI	5520126500	HYUNDAI	552202E000	FIAT	51939960
HYUNDAI	5520026550	HYUNDAI	5520126550	HYUNDAI	552202E010	JEEP	68246734AA
				HYUNDAI	552202E110	JEEP	68309202AA
							

Cross References List And Photo

Photo.....

S063127	S063128	S063129	S063130
MERCEDES-BENZ 1643500053 MERCEDES-BENZ 1663500053 MERCEDES-BENZ A1643500053	BMW 31126787670	BMW 31126787669	LAND ROVER LR044844 LAND ROVER LR113268
			





S063131	S063146	S063148	S063149
LAND ROVER LR044841 LAND ROVER LR113262	JEEP 52089630AA JEEP 52089630AB JEEP 52089630AC	NISSAN 55111JG00B RENAULT 551115HA0A RENAULT 551115HA0B	NISSAN 55110JG00B RENAULT 551105HA0A RENAULT 551105HA0B
			

S063152	S063156	S063166	S063167
FIAT 51755681 OPEL 423002 VAUXHALL 24428548	MERCEDES-BENZ 1663300207 MERCEDES-BENZ A1663300207	MERCEDES-BENZ 1663300107 MERCEDES-BENZ A1663300107	MERCEDES-BENZ 2173303900 MERCEDES-BENZ 2223300507 MERCEDES-BENZ A2173303900
			

Cross References List And Photo

Photo.....

S063168	S063169	S063170	S063175
MERCEDES-BENZ 2173304000 MERCEDES-BENZ 2223300607 MERCEDES-BENZ A2173304000	HYUNDAI 552400W000 HYUNDAI 552401U000 HYUNDAI 552402P000	HYUNDAI 552300W000 HYUNDAI 552302P000	VW 701407152A
			





S063176	S063178	S063179	S063180
VW 701407151A	HYUNDAI 5520226500	HYUNDAI 5520326500	IVECO 42551297 IVECO 500344888 IVECO 500379802
			

S063181	S063182	S063196	S063201
IVECO 42551296 IVECO 500344887 IVECO 500379801	HYUNDAI 552101H100 HYUNDAI 552102H000 HYUNDAI 552102H100	LEXUS 487100R030 LEXUS 4871042030	FORD 7T4Z5500A
			

Cross References List And Photo

Photo.....





S063203		S063204		S063205		S063209	
FORD	CMS4012521	FORD	CMS401252	CHRYSLER	68079723AA	HYUNDAI	551002B100
FORD	E1GZ5500C	FORD	E1GZ5500D	CHRYSLER	68079723AB		
							





S063218		S063219		S063220		S063221	
MERCEDES-BENZ	2053301705	MERCEDES-BENZ	2053301805	HYUNDAI	552502W000	KIA	552504D000
MERCEDES-BENZ	A2053301705	MERCEDES-BENZ	A2053301805				
							





S063222		S063223		S063224		S063227	
TOYOTA	4874033060	NISSAN	5450000Q1E	NISSAN	5450100Q1C	MERCEDES-BENZ	2043502106
		OPEL	4419216	OPEL	4419215	MERCEDES-BENZ	A2043502106
		RENAULT	8200688875	RENAULT	8200688871		
							

Cross References List And Photo

Photo.....





S063228	S063233	S063234	S063235
MERCEDES-BENZ 2043502206 MERCEDES-BENZ A2043502206 	HYUNDAI 5520326700 	HYUNDAI 5520426700 	MERCEDES-BENZ 2473300600 MERCEDES-BENZ 2473305400 MERCEDES-BENZ 2473307602 MERCEDES-BENZ A2473305400 MERCEDES-BENZ A2473307602 



S063236	S063237	S063238	S063239
MERCEDES-BENZ 2473300500 MERCEDES-BENZ 2473307502 MERCEDES-BENZ A2473300500 MERCEDES-BENZ A2473307502 	KIA 552404D000 KIA 552404D001 	KIA 552304D000 KIA 552304D001 	HYUNDAI 551103K000 

S063242	S063243	S063246	S063247
HYUNDAI 551203K000 	BMW 31122284532 	BMW 31106870972 BMW 31106871468 	BMW 31126854724 

Cross References List And Photo

Photo.....

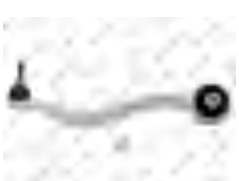
S063248		S063250		S063251		S063252	
BMW	31106870971	BMW	31122284529	BMW	31106870978	BMW	31106870977
				BMW	31106890904	BMW	31106890903
				BMW	31106890906	BMW	31106890905
							

S063253		S063254		S063258		S063260	
BMW	31126854723	BMW	31122284531	BMW	31102283578	BMW	31106861185
						BMW	31126866240
							



S063261		S063543		S070002		S070003	
TOYOTA	4871006130	HONDA	51350SLNA02	ALFA ROMEO	36025748	ALFA ROMEO	36025749
TOYOTA	4871007010			ALFA ROMEO	9947919	ALFA ROMEO	9947920
TOYOTA	4871033100			ALFA ROMEO	9951288	ALFA ROMEO	9951289
							

Cross References List And Photo

Photo.....

S070005	S070006	S070009	S070010
ALFA ROMEO 77363706	ALFA ROMEO 77363707	ALFA ROMEO 9947720 ALFA ROMEO 9947926 ALFA ROMEO 9950775	ALFA ROMEO 60565706 ALFA ROMEO 60806356 ALFA ROMEO 60809495
			

S070011	S070012	S070013	S070014
ALFA ROMEO 60565705 LANCIA 60806355 LANCIA 60809494	FIAT 77364568 OPEL 1603544 OPEL 1609457	ALFA ROMEO 77363830 OPEL 1603545 OPEL 1609458	VW 5U0422811A VW 5Z1419811 VW 6Q0419811C
			

S070015	S070016	S070017	S070018
SEAT 6Q0419812C SEAT 6Q0423812 SEAT 6Q0423812C	AUDI 4B0419811G AUDI 4D0419811J AUDI 4F0419811C	AUDI 8E0505465C AUDI 8E0505465D	AUDI 811419812A AUDI 811419812B AUDI 8A0419812
			

Cross References List And Photo

Photo.....

S070022		S070023		S070024		S070025	
AUDI	433419811D	AUDI	433419812D	AUDI	4G0423811A	AUDI	4G0423812A
AUDI	443419811B	AUDI	443419812B	AUDI	4G0423811AS1	AUDI	4G0423812AS1
AUDI	443419811D	AUDI	443419812D	AUDI	8K0422817A	AUDI	8K0422818A
							

S070028		S070029		S070032		S070033	
AUDI	6E0419812	AUDI	6E0419811	AUDI	1K0423811A	AUDI	1K0423812A
AUDI	6K0422812	AUDI	6K0422811	AUDI	1K0423811B	AUDI	1K0423812B
AUDI	6X0422812	AUDI	6X0422811	AUDI	1K0423811C	AUDI	1K0423812C
							

S070034		S070035		S070036		S070037	
AUDI	8N0422812	AUDI	8N0422811	AUDI	7L0422817B	AUDI	7L0422818B
AUDI	8N0422812A	AUDI	8N0422811A	AUDI	7L0422817C	AUDI	7L0422818C
				VW	2H0422817	AUDI	7L0422818D
							

Cross References List And Photo

Photo.....

S070038		S070039		S070040		S070041	
AUDI	4B0419811B	AUDI	1J0422811	AUDI	1J0422812	BMW	1095958
AUDI	4B0419811C	AUDI	1J0422811A	AUDI	1J0422812A	BMW	32106774221
AUDI	4B0419811E	AUDI	1J0422811C	AUDI	1J0422812C	BMW	32211095958
							





S070042		S070045		S070046		S070048	
BMW	1095957	BMW	32106765089	BMW	32106765090	BMW	32211127917
BMW	32106774220	BMW	32106767781	BMW	32106767782	BMW	32211130004
BMW	32211095957	BMW	6767781	BMW	6767782	BMW	32211135820
							





S070049		S070050		S070051		S070052	
BMW	32211127918	BMW	32111091769	BMW	32111091724	BMW	07129922770
BMW	32211130001			BMW	32111091768	BMW	1126757
BMW	32211135819			BMW	32111091770	BMW	32111126757
							

Cross References List And Photo

Photo.....

S070054		S070055		S070056		S070057	
BMW	1139313	BMW	1139314	BMW	1141345	BMW	1141346
BMW	32111139313	BMW	32111139314	BMW	32211141345	BMW	32211141346
							





S070058		S070059		S070060		S070061	
BMW	1091724	BMW	1091723	BMW	32106774335	BMW	32106780984
BMW	32211091724	BMW	32111093771	BMW	32211096327	BMW	32303418202
BMW	33111093772	BMW	32211091723	BMW	32216760354	BMW	32413413476
							

S070063		S070064		S070079		S070080	
BMW	32106769073	BMW	32106769074	CITROËN	1607321480	CITROËN	1607321380
BMW	32106793623	BMW	32106793624	CITROËN	381756	CITROËN	381755
BMW	6769073	BMW	6769074				
							

Cross References List And Photo

Photo.....





S070081		S070082		S070084		S070085	
CITROËN	381754	CITROËN	381753	CITROËN	4018E0	CITROËN	1607315280
CITROËN	381760	CITROËN	381759	FIAT	77362278	CITROËN	405912
		CITROËN	400122			FIAT	77362279
							





S070090		S070091		S070092		S070093	
CITROËN	1610976480	CITROËN	1610976380	CITROËN	1610935780	CITROËN 381772	
CITROËN	381777	CITROËN	381770	CITROËN	1635773080		
FIAT	77364253	FIAT	77364009	CITROËN	381771		
							





S070094		S070098		S070099		S070100	
CITROËN	381773	CITROËN	4018A3	CITROËN	381738	CITROËN	381737
CITROËN	3817A5	CITROËN	4018H4	CITROËN	381744	CITROËN	381743
FIAT	9403817738	FIAT	1306716080				
							

Cross References List And Photo

Photo.....





S070101		S070102		S070103		S070104	
PEUGEOT	381757	PEUGEOT	381758	CITROËN	405909	CITROËN	381718
				FIAT	1306003080	CITROËN	381750
				FIAT	9404059080	PEUGEOT	381710
							





S070105		S070106		S070107		S070108	
CITROËN	1607316280	CITROËN	1607316380	CITROËN	1610936880	CITROËN	1610936580
CITROËN	381714	CITROËN	381716	CITROËN	381776	CITROËN	381775
CITROËN	381730	CITROËN	381731	CITROËN	381789	CITROËN	381788
							





S070109		S070110		S070111		S070116	
CITROËN	1607502480	DACIA	485202867R	DACIA	485200410R	DAEWOO	07846495
CITROËN	381774	DACIA	6001547610	DACIA	6001547611	DAEWOO	26001807
MITSUBISHI	4422A018	DACIA	6001550442	DACIA	6001550443	OPEL	0324039
							

Cross References List And Photo

Photo.....





S070117		S070118		S070119		S070120	
DAEWOO	26001806	DAIHATSU	4504787781	DAIHATSU	4504687401	DAIHATSU	4504687282
OPEL	0324038	DAIHATSU	4504787782	DAIHATSU	4504687401000	DAIHATSU	4504687283
VAUXHALL	07846485	DAIHATSU	4504787783	DAIHATSU	4504687402	DAIHATSU	4504687285
							





S070121		S070122		S070123		S070124	
DAIHATSU	4504787280	DAIHATSU	4504687781	FIAT	46456189	FIAT	46456660
DAIHATSU	4504787281	DAIHATSU	4504687782	FIAT	46745365	FIAT	46745364
DAIHATSU	4504787282	DAIHATSU	4504687783	FIAT	98845032	FIAT	98845031
							





S070126		S070130		S070131		S070133	
FIAT	7543028	FIAT	77362507	FIAT	77362508	FIAT	5958246
FIAT	7584628	FIAT	77367001	FIAT	77367002	FIAT	5958247
		FORD	1546259	FORD	1546260	FIAT	5983404
							

Cross References List And Photo

Photo.....





S070140		S070141		S070142		S070145	
OPEL	1603227	OPEL	1603228	FORD	1447222	FORD	1138313
SAAB	12801423	SAAB	12787822	FORD	1571221	FORD	1138314
SAAB	5235650	SAAB	12801424	FORD	5021410	FORD USA	1S7C3290AB
							

S070146		S070147		S070148		S070157	
FORD	1138275	FORD	1074305	FORD	1074306	FORD	1315083
FORD	1370741	FORD	1107013	FORD	1107015	FORD	1317447
FORD	1490759	FORD USA	98AG3289AA	FORD USA	98AG3290AA	FORD	1328881
							



S070158		S070165		S070166		S070168	
FORD	1315074	FORD	1015546	FORD	1015547	FORD	5027452
FORD	1317446	FORD	5024332	FORD	5024333	FORD	93BX3270BA
FORD	1328877	FORD	6555936	FORD	6555938		
							

Cross References List And Photo

Photo.....





S070169		S070170		S070171		S070172	
FORD	5027451	FORD	1032567	FORD	1011858	FORD	1011857
FORD	93BX3270AA	FORD	1032689	FORD	1020175	FORD	1020174
		FORD	1034417	MAZDA	1E0132280A	MAZDA	1E0032280A
							

S070173		S070174		S070175		S070176	
FORD	1035691	FORD	1035690	FORD	1433274	FORD	1433273
FORD	1097323	FORD	1097316	VOLVO	30776249	VOLVO	30776248
FORD USA	97BX3290AA	FORD USA	97BX3289AA	VOLVO	31280000	VOLVO	31280001
							





S070177		S070178		S070183		S070186	
FORD	1545339	FORD	1545338	FORD	1961669	FORD USA	5L5Z3A130AA
FORD	BE8Z3A131A	FORD	BE8Z3A130A	NISSAN	485207F001	FORD USA	F87Z3A130BA
FORD USA	8V513C437AA	FORD USA	8V513C367AA	NISSAN	4852131G25		
							

Cross References List And Photo

Photo.....

S070187		S070188		S070189		S070190	
FIAT	4193224	HONDA	53560S04003	HONDA	53540S04003	HONDA	53541S5A003
FIAT	4327142	HONDA	53560S04013	HONDA	53540S04013		
LADA	21013003057	HONDA	53560SH3000	HONDA	53540SR0A01		
							

S070196		S070197		S070201		S070202	
HONDA	53560SS0003	HONDA	53540SS0003	HONDA	53560SDAA01	HONDA	53540SDAA01
HONDA	53560SS0004	HONDA	53540SS0004			HONDA	53540SDAA02
							

S070206		S070207		S070209		S070210	
HONDA	53560S1AE01	HONDA	53540S1AE01	HYUNDAI	5682022000	HYUNDAI	5687243000
HONDA	53560S84A01	HONDA	53540S84A01	HYUNDAI	5682025000	HYUNDAI	5687243010
HONDA	53560SM4003	HONDA	53540SM4003	HYUNDAI	5682028500	HYUNDAI	5770556820
							

Cross References List And Photo

Photo.....

S070211		S070213		S070215		S070216	
HYUNDAI	5682002500	HYUNDAI	5654024000	HYUNDAI	5682038000	HYUNDAI	5682038900
HYUNDAI	568201X000	HYUNDAI	5773024000	HYUNDAI	5778038000	HYUNDAI	5682039000
HYUNDAI	5682028000	HYUNDAI	5773028000			HYUNDAI	5778038010
							





S070217		S070218		S070219		S070220	
HYUNDAI	568202E900	HYUNDAI	568202E000	HYUNDAI	568203F100	HYUNDAI	568203F110
				HYUNDAI	568203K000	HYUNDAI	568203K010
				HYUNDAI	568203K500	HYUNDAI	568203K510
							

S070223		S070224		S070225		S070226	
HYUNDAI	568202B000	HYUNDAI	568202B900	HYUNDAI	568202H000	HYUNDAI	568202H090
HYUNDAI	568202P900	HYUNDAI	568202P000				
HYUNDAI	568212B000	HYUNDAI	568212B900				
							

Cross References List And Photo

Photo.....

S070227		S070228		S070229		S070230	
HYUNDAI	568200X000	HYUNDAI	568202K050	HYUNDAI	568202K000	HYUNDAI	5682021000
HYUNDAI	568200X010					HYUNDAI	5682021100
HYUNDAI	568200X900					HYUNDAI	5682021110
							





S070231		S070232		S070237		S070238	
HYUNDAI	HB568110	HYUNDAI	HB568120	JEEP	52005741	KIA	5682007000
MINIBUSHI	MB241206	MINIBUSHI	MB241171			KIA	MDX5032280
MINIBUSHI	MB315776	MINIBUSHI	MB315775			MAZDA	B45532280
							

S070240		S070241		S070243		S070244	
KIA	0K20132280	KIA	0K55232240	KIA	568203E900	KIA	568203E000
KIA	0K20132280A						
KIA	0K9A232280						
							

Cross References List And Photo

Photo.....

S070245		S070246		S070247		S070248	
LADA	21083414056	LADA	21083414057	LADA	21013414116	LADA	21013003050
				LADA	21210341413800	LADA	4183729
				LADA	21213414116		
							

S070249		S070252		S070259		S070262	
LADA	21013003064	FORD	3405915	MAZDA	E17Z3A130A	FORD	3665759
LADA	4183728	MAZDA	8AG332280	MAZDA	E17Z3A130B	FORD	4089654
		MAZDA	8AG432280	MAZDA	EZ7Z3A130A	MAZDA	8AU232270
							





S070263		S070264		S070270		S070271	
FORD	3669093	MAZDA	8AB032280	MERCEDES-BENZ	0003380710	MERCEDES-BENZ	0003380810
MAZDA	8AU132280	MAZDA	8AB232280	MERCEDES-BENZ	0003381910	MERCEDES-BENZ	0003382010
MAZDA	UH7432280	MAZDA	B45532280	MERCEDES-BENZ	0003385210	MERCEDES-BENZ	0003385010
							

Cross References List And Photo

Photo.....





S070275	S070276	S070277	S070278
<p>MERCEDES-BENZ 1633300203 MERCEDES-BENZ 1633300403 MERCEDES-BENZ 1633380115</p> 	<p>MERCEDES-BENZ 1633300003 MERCEDES-BENZ 1633300103 MERCEDES-BENZ 1633380015</p> 	<p>MERCEDES-BENZ 1683301235 MERCEDES-BENZ 1683301635 MERCEDES-BENZ A1683301235</p> 	<p>MERCEDES-BENZ 1683301135 MERCEDES-BENZ 1683301535 MERCEDES-BENZ A1683301135</p> 





S070282	S070283	S070284	S070285
<p>MERCEDES-BENZ 1693300503 MERCEDES-BENZ A1693300503</p> 	<p>MERCEDES-BENZ 1693300603 MERCEDES-BENZ A1693300603</p> 	<p>MERCEDES-BENZ 2033301903 MERCEDES-BENZ 2033302303 MERCEDES-BENZ 2033303903</p> 	<p>MERCEDES-BENZ 2033302003 MERCEDES-BENZ 2033302403 MERCEDES-BENZ 2033304003</p> 

S070286	S070287	S070289	S070290
<p>MERCEDES-BENZ 2113300103 MERCEDES-BENZ 2113302303 MERCEDES-BENZ 2113302503</p> 	<p>MERCEDES-BENZ 2113300203 MERCEDES-BENZ 2113302403 MERCEDES-BENZ 2113302603</p> 	<p>MERCEDES-BENZ 0013306235 MERCEDES-BENZ A0013306235</p> 	<p>MERCEDES-BENZ 0013306335 MERCEDES-BENZ A0013306335</p> 

Cross References List And Photo

Photo.....





S070295	S070296	S070297	S070298
<p>MERCEDES-BENZ 0003384210 MERCEDES-BENZ 0003384410 MERCEDES-BENZ 0003386110</p> 	<p>MERCEDES-BENZ 0003384310 MERCEDES-BENZ 0003384510 MERCEDES-BENZ 0003386010</p> 	<p>MERCEDES-BENZ 0003384910 MERCEDES-BENZ 0003386310 MERCEDES-BENZ A0003384910</p> 	<p>MERCEDES-BENZ 2203380515 MERCEDES-BENZ 2203381015 MERCEDES-BENZ 2303300203</p> 

S070302	S070303	S070304	S070308
<p>MERCEDES-BENZ 2213301503 MERCEDES-BENZ 2213303903 MERCEDES-BENZ A2213301503</p> 	<p>MERCEDES-BENZ 1643301103 MERCEDES-BENZ A1643301103</p> 	<p>MERCEDES-BENZ 1643301203 MERCEDES-BENZ A1643301203</p> 	<p>MERCEDES-BENZ 0003385610 MERCEDES-BENZ 0003385910 MERCEDES-BENZ A0003385910</p> 

S070309	S070312	S070313	S070315
<p>MERCEDES-BENZ 0003307435 MERCEDES-BENZ 0013307435 MERCEDES-BENZ 0013307735</p> 	<p>MERCEDES-BENZ 2103380515 MERCEDES-BENZ A2103380515</p> 	<p>MERCEDES-BENZ 2103380615 MERCEDES-BENZ A2103380615</p> 	<p>DODGE 05133905AA MERCEDES-BENZ 9014600048 VW 2D0422811</p> 

Cross References List And Photo

Photo.....

S070316		S070317		S070321		S070322					
<p> mitsubishi MB831043 mitsubishi MR296275 mitsubishi MR831043 </p>	<p> mitsubishi MB831044 </p>	<p> hyundai 5682028000 volvo 30870695 volvo 30875012 </p>	<p> mitsubishi 4422A009 mitsubishi 4422A096 mitsubishi MR508135 </p>								





S070323		S070324		S070325		S070340					
<p> mitsubishi 4422A010 mitsubishi 4422A097 mitsubishi MR508136 </p>	<p> mitsubishi 4422A037 </p>	<p> mitsubishi 4422A038 </p>	<p> nissan 48520C025 nissan 48520M085 nissan 4852015U25 </p>								





S070346		S070347		S070348		S070350					
<p> nissan 48520EA01J nissan 48520EA026 </p>	<p> nissan 48640EA01J nissan 48640EA026 </p>	<p> nissan 48520CB025 nissan D8520CB025 </p>	<p> nissan 48647JD01A nissan D8640JG00A renault D8640JY00A </p>								

Cross References List And Photo

Photo.....





S070351		S070352		S070353		S070354	
NISSAN	48527JD01A	NISSAN	4852000QAN	NISSAN	4852000QAP	NISSAN	4852000QAH
NISSAN	D8520JG00A	NISSAN	48640AX602	NISSAN	48520AX602	OPEL	4501262
RENAULT	D8520JY00A	RENAULT	7701047415	RENAULT	7701047416	RENAULT	7701470363
							





S070355		S070356		S070357		S070371	
NISSAN	4852000QAJ	NISSAN	4852000QAL	NISSAN	4852000QAK	OPEL	0324042
OPEL	4501263	OPEL	4408511	OPEL	4408510	OPEL	0324050
RENAULT	7701470364	RENAULT	485209446R	RENAULT	485202714R	VAUXHALL	07840452
							





S070376		S070377		S070378		S070379	
OPEL	4709195	PEUGEOT	381739	PEUGEOT	381740	CITROËN	1610935180
SUZUKI	4881061J00					PEUGEOT	1608652280
SUZUKI	4881063J00					PEUGEOT	381767
							

Cross References List And Photo

Photo.....





S070380		S070381		S070382		S070383	
CITROËN	1610935280	PEUGEOT	381721	PEUGEOT	381722	PORSCHE	99134713100
PEUGEOT	1608652380	PEUGEOT	381726	PEUGEOT	381727	PORSCHE	99634713103
PEUGEOT	381768	PEUGEOT	381748	PEUGEOT	381749	PORSCHE	99634713104
							





S070387		S070388		S070391		S070392	
RENAULT	7701471127	RENAULT	7701471126	RENAULT	7701054583	RENAULT	7701054584
RENAULT	7701471146	RENAULT	7701471145	RENAULT	7701054585	RENAULT	7701474796
RENAULT	7701476763	RENAULT	7701476762	RENAULT	7701474795		
							





S070399		S070400		S070401		S070402	
RENAULT	6000030047	RENAULT	6000030048	RENAULT	7701464019	DACIA	6000022714
				RENAULT	7701464441		
				RENAULT	7701469230		
							

Cross References List And Photo

Photo.....





S070403		S070404		S070405		S070406	
DACIA	6000022715	DACIA	6000022730	DACIA	6000022731	DACIA	6000022752
						RENAULT	6000022720
						RENAULT	7701041311
							

S070407		S070408		S070409		S070414	
DACIA	6000022753	RENAULT	6000022737	RENAULT	6000022736	DACIA	485204680R
RENAULT	6000022721	RENAULT	6020022737	RENAULT	6020022736	RENAULT	485205192R
RENAULT	7701041312					RENAULT	8660003554
							

S070415		S070418		S070419		S070423	
DACIA	485202710R	SEAT	191419812	SEAT	191419811	SUBARU	34141AA040
RENAULT	485209049R	SEAT	3A0422812	SEAT	3A0422811	SUBARU	34141AA041
RENAULT	8660003555	SEAT	6N0419812	SEAT	6N0419811	SUBARU	34141AA042
							

Cross References List And Photo

Photo.....





S070425		S070426		S070431		S070434	
SUZUKI	4881060A00	SUZUKI	4882060A00	SUZUKI	4881060B00	SUZUKI	4882065D00
SUZUKI	4881080000	SUZUKI	4882060A00000	SUZUKI	4881076G00	SUZUKI	4882065D00000
SUZUKI	4881081A01	SUZUKI	4882077E00	SUZUKI	4881082000	SUZUKI	4882065D01000
							

S070435		S070443		S070450		S070455	
SUZUKI	4881065D00	TOYOTA	4504619205	LEXUS	4504619175	TOYOTA	4504709150
SUZUKI	4881065D00000	TOYOTA	4504619206	TOYOTA	4504609090	TOYOTA	4504719115
SUZUKI	4881067D00	TOYOTA	4504619213	TOYOTA	4504629265	TOYOTA	4504749045
							





S070456		S070459		S070460		S070464	
TOYOTA	4504609360	SCION	4504749025	CHERY	T213003060	LEXUS	4547039215
TOYOTA	4504619265			SCION	4504649095	TOYOTA	4547009010
TOYOTA	4504649115					TOYOTA	4547029185
							

Cross References List And Photo

Photo.....

S070465		S070468		S070469		S070470	
LEXUS	4546039615	TOYOTA	4504729065	TOYOTA	4504629235	LEXUS	4504609020
TOYOTA	4546009010					LEXUS	4504629255
TOYOTA	4546029425					TOYOTA	4504609230
							





S070485		S070490		S070491		S070493	
LEXUS	4504639505	LEXUS	4504749135	LEXUS	4504649195	AUDI	701419811E
		TOYOTA	4504709310	TOYOTA	4504609650	VW	701419803E
							





S070495		S070498		S070499		S070500	
AUDI	131415812	VW	113415812C	AUDI	131415813D	VW	7E0422817
		VW	311415812B	VW	131415813E	VW	7H0422817A
		VW	311415812C	VW	131415813F	VW	7H0422817B
							

Cross References List And Photo

Photo.....





S070501		S070507		S070508		S070509	
VW	7E0422818	AUDI	701419812B	AUDI	701419811	VW	701407311
VW	7H0422818A	VW	701407312	AUDI	701419811A	VW	701407311A
VW	7H0422818B	VW	701407312A	AUDI	701419811B	VW	701407311B
							





S070511		S070516		S070517		S070518	
AUDI	701419812	VOLVO	274175	VOLVO	274176	VOLVO	274225
AUDI	701419812A	VOLVO	274496	VOLVO	274497	VOLVO	2742250
VW	701407312	VOLVO	30761719	VOLVO	30761718		
							





S070519		S070520		S070521		S070522	
VOLVO	274226	VOLVO	272416	VOLVO	272417	VOLVO	1205658
						VOLVO	1329675
						VOLVO	3516944
							

Cross References List And Photo

Photo.....





S070523		S070524		S070525		S070526	
VOLVO	274192	VOLVO	274191	VOLVO	271599	VOLVO	271598
VOLVO	274352	VOLVO	274351	VOLVO	2715993	VOLVO	2715985
VOLVO	274499	VOLVO	274498	VOLVO	3546268	VOLVO	3546267
							





S070535		S070539		S070540		S070541	
JEEP	52000598	JEEP	52005740	JEEP	52005739	CHRYSLER	04762861AA
						CHRYSLER	4762861
						CHRYSLER	4762861AA
							





S070544		S070545		S070546		S070547	
JEEP	52088461	JEEP	52088511	JEEP	05072445AA	JEEP	05072444AA
				JEEP	5072445AA	JEEP	5072444AA
				JEEP	52128521AA	JEEP	52128520AA
							

Cross References List And Photo

Photo.....





S070548		S070551		S070552		S070553	
CHRYSLER	04766321AB	BMW	32106774361	BMW	32106778437	BMW	32106778438
CHRYSLER	04766321AC	BMW	32106776946	MINI	6778437	MINI	6778438
CHRYSLER	04766321AD	BMW	32216756369				
							





S070557		S070558		S070559		S070560	
CITROËN	1610936280	CITROËN	1610936380	CITROËN	1609948280	CITROËN	1609942380
CITROËN	381791	CITROËN	381792	CITROËN	1610937380	CITROËN	1609948380
				CITROËN	381780	CITROËN	381781
							





S070562		S070565		S070578		S070579	
ALFA ROMEO	46527567	IVECO	500310933	LAND ROVER	JQB100230	LAND ROVER	JQB100220
ALFA ROMEO	9947714	IVECO	93802209	LAND ROVER	QJB100230	LAND ROVER	QJB100220
FIAT	98845030	IVECO	93804060				
							

Cross References List And Photo

Photo.....

S070581	S070582	S070584	S070588
LAND ROVER QJB500050 LAND ROVER TIQ000030 	LAND ROVER LR010671 LAND ROVER QJB500010 	LAND ROVER LR010675 LAND ROVER QJB500040 	MERCEDES-BENZ 2513300703 MERCEDES-BENZ A2513300703 





S070589	S070594	S070595	S070598
MERCEDES-BENZ 2513300803 MERCEDES-BENZ A2513300803 	CITROËN 381765 	CITROËN 381766 	LAND ROVER QFS000010 LAND ROVER QFS100060 LAND ROVER STC1871 





S070613	S070639	S070647	S070648
SUZUKI 4881065J00 SUZUKI 4881079J00 SUZUKI 4881079J01 	DAIHATSU 4504787303 DAIHATSU 4504787380 	TOYOTA 4504609280 TOYOTA 4504609281 TOYOTA 4504609310 	TOYOTA 4504609250 TOYOTA 4504609251 TOYOTA 4504609260 

Cross References List And Photo

Photo.....





S070681		S070682		S070690		S070691	
NISSAN	48640EA025	NISSAN	48520EA025	HYUNDAI	5682036000	MITSUBISHI	MB288119
				MITSUBISHI	MB192430		
				MITSUBISHI	MB192499		
							

S070695		S070724		S070728		S070732	
MITSUBISHI	MB241982	DAIHATSU	4504687303	SUZUKI	4881077E00	AUDI	131415811D
		DAIHATSU	4504687601	SUZUKI	4881077E00000	VW	131415811
		DAIHATSU	4504687680				
							





S070734		S070737		S070738		S070742	
HYUNDAI	568204A600	CHEVROLET	15254061	ALFA ROMEO	4254520	BMW	32211113447
				FIAT	4254519	BMW	32211113448
				FIAT	4257066	BMW	32211114843
							

Cross References List And Photo

Photo.....





S070744		S070745		S070747		S070750	
TOYOTA	4504702030	TOYOTA	4504602070	CHEVROLET	93296756	FIAT	7524715
TOYOTA	4504709080	TOYOTA	4504609200	GMC	1543080		
TOYOTA	4504759145	TOYOTA	4504659205	GMC	93284364		
							

S070763		S070766		S070767		S070770	
MITSUBISHI	4422A002	HYUNDAI	568202S000	HYUNDAI	568202S050	HONDA	53540SNAA01
MITSUBISHI	4422A052	HYUNDAI	568202T190	HYUNDAI	568202T100	HONDA	53540SNAA02
MITSUBISHI	MR548285	HYUNDAI	568203Q000	HYUNDAI	568203Q500	HONDA	53540SNEA01
							





S070771		S070772		S070782		S070789	
HONDA	53560SNAA01	HONDA	53540S7S003	FORD	3669079	KIA	0K67032450
HONDA	53560SNAA02	HONDA	53540SWAA01	MAZDA	E17Z3A131A		
HONDA	53560SNEA02	HONDA	53540SWAA02	MAZDA	UA0199324		
							

Cross References List And Photo

Photo.....





S070790		S070791		S070801		S070802	
KIA	0K67032510	KIA	0K01132280	FORD FORD	2L3Z3A130AA F65Z3A130AA	FORD FORD	2L3Z3A130BA F65Z3A130BA
							

S070803		S070810		S070811		S070821	
TOYOTA TOYOTA	4504609340 4504669245	LEXUS LEXUS	4546009180 4546049055	LEXUS LEXUS	4547009020 4547049025	HONDA HONDA HONDA	53540TA0A01 53540TR0A01 53540TR0A02
							

S070822		S070824		S070826		S070827	
HONDA HONDA HONDA	53560TA0A01 53560TR0A01 53560TR0A02	MERCEDES-BENZ MERCEDES-BENZ MERCEDES-BENZ	0003300135 0003300248 0003303235	KIA	568202G000	KIA	568202G900
							

Cross References List And Photo

Photo.....





S070840	S070852	S070853	S070862
MERCEDES-BENZ 0004600148 MERCEDES-BENZ 0004602648 MERCEDES-BENZ 0004602748	TOYOTA 4546009050 TOYOTA 4546009110 TOYOTA 4546009140	TOYOTA 4547009040 TOYOTA 4547009080 TOYOTA 4547009090	MERCEDES-BENZ 120082405100 MERCEDES-BENZ 120082405200 MERCEDES-BENZ 3503307235
			

S070866	S070889	S070927	S070928
IVECO 002984511 MERCEDES-BENZ 0003300035 MERCEDES-BENZ 0003300148	SUZUKI 4882080000 SUZUKI 4882080001	NISSAN D8640EB70A	NISSAN D8520EB70A
			





S070937	S070938	S070940	S070941
HYUNDAI 568203X000 HYUNDAI 56820A6000 KIA 56820A6500	HYUNDAI 568203X090 HYUNDAI 56820A6090 KIA 56820A6590	NISSAN 486404FJ0A NISSAN D85401KA0A NISSAN D86404FJ0A	NISSAN 485204FJ0A NISSAN D85201KA0A NISSAN D85204FJ0A
			

Cross References List And Photo

Photo.....





S070970		S070982		S070996		S070997	
TOYOTA	4504609610	KIA	0K01132240A	IVECO	42534911	MERCEDES-BENZ	2123302203
TOYOTA	4504609640			IVECO	42556991	MERCEDES-BENZ	2123308200
TOYOTA	4504619425			IVECO	503643948	MERCEDES-BENZ	2183300400
							

S070998		S070999		S071000		S071007	
MERCEDES-BENZ	2123302303	BMW	32106784790	BMW	32106784796	JEEP	5143555AA
MERCEDES-BENZ	2123308100	BMW	6784790	BMW	6784796	JEEP	5143555AB
MERCEDES-BENZ	2183300300					JEEP	5143555AC
							





S071008		S071009		S071010		S071011	
JEEP	5143556AA	CHRYSLER	05003930AA	CHRYSLER	68033171AA	DODGE	52125367AA
JEEP	5143556AB	CHRYSLER	05086282AA	CHRYSLER	68033171AB		
JEEP	5143556AC	CHRYSLER	5003930AA	CHRYSLER	68156146AA		
							

Cross References List And Photo

Photo.....

S071012		S071013		S071015		S071021	
DODGE	52125366AA	CHRYSLER	52013468AB	JEEP	52125483AA	SSANGYONG	4666008001
		CHRYSLER	52013468AC	JEEP	68003671AA	SSANGYONG	4666009001
		CHRYSLER	52013468AD	JEEP	K68003671AA	SSANGYONG	4666009002
							





S071022		S071024		S071025		S071053	
SSANGYONG	4666008011	HYUNDAI	568204H000	HYUNDAI	568204H100	NISSAN	4852000Q0F
SSANGYONG	4666009010					OPEL	4420097
SSANGYONG	4666009011					RENAULT	485206730R
							

S071054		S071074		S071075		S071086	
NISSAN	4852000Q0E	JAGUAR	XR81771	JAGUAR	XR81770	CHEVROLET	520262
OPEL	4420098					DAEWOO	96129753
RENAULT	485200780R					DAEWOO	96205808
							

Cross References List And Photo

Photo.....





S071092		S071093		S071095		S071096	
JEEP	52088466	JEEP	52088467	LEXUS	4546430060	LEXUS	4546330130
JEEP	52088870AA	JEEP	52088869AA				
JEEP	52088870AB	JEEP	52088879AA				
							





S071098		S071099		S071106		S071107	
INFINITI	D8640CG80A	INFINITI	D8520CG80A	NISSAN	48640AL585	NISSAN	48520AL525
INFINITI	D8F40CG80A	INFINITI	D8E20CG80A	NISSAN	48640CD725	NISSAN	48520CD725
NISSAN	48640CG085	NISSAN	48520CG025	NISSAN	D8640CD725	NISSAN	D8520CD725
							





S071123		S071124		S071133		S071134	
KIA	0K67032280	KIA	0K67032240	CHRYSLER	5017460AA	CHRYSLER	5017461AA
							

Cross References List And Photo

Photo.....

S071136		S071137		S071140		S071141	
CHRYSLER	5103320AA	FORD	4L2Z3A130AA	CHRYSLER	4796864	CHRYSLER	04796865
CHRYSLER	5103320AB	FORD	5L2Z3A130AA	CHRYSLER	5094006AA	CHRYSLER	05093857AA
DODGE	68033477AA					CHRYSLER	4796865
							





S071157		S071158		S071162		S071163	
JAGUAR	C2C20177	DAIMLER	2W933289CA	MERCEDES-BENZ	2033303303	MERCEDES-BENZ	2033303403
JAGUAR	C2C35783	JAGUAR	C2C20176	MERCEDES-BENZ	A2033303303	MERCEDES-BENZ	A2033303403
JAGUAR	C2C8371	JAGUAR	C2C8370	STEYR	48210481003	STEYR	48210481004
							

S071200		S071205		S071218		S071219	
VW	357422811	BUICK	26055104	FORD USA	YS4Z3A130AA	FORD USA	YS4Z3A130BA
		BUICK	26086073	FORD USA	YS4Z3A130CB	FORD USA	YS4Z3A130CA
							

Cross References List And Photo

Photo.....





S071261		S071263		S071271		S071274	
FORD USA	F5TZ3A131A	NISSAN	48520CA025	CHRYSLER	5142938AA	KIA	0K01132230
				DODGE	5142938AB		
							

S071279		S071283		S071284		S071288	
NISSAN	48520EG025	HONDA	53560T0AA01	HONDA	53540T0AA01	NISSAN	D8640ET00A
NISSAN	48520EG026	HONDA	53560T0AA11	HONDA	53540T0AA11		
NISSAN	D8520EG025	HONDA	53560T1WA01	HONDA	53540T1WA01		
							

S071289		S071290		S071291		S071298	
NISSAN	D8520ET00A	FORD USA	8S4Z3A130A	FORD USA	8S4Z3A130B	FORD	1729241
						FORD	1910478
						FORD	AB313290BA
							

Cross References List And Photo

Photo.....





S071299		S071300		S071312		S071313	
FORD	1727227	GENERAL MOTORS	26028478	JEEP	52000608	JEEP	52000599
FORD	1910477	PONTIAC	26063859				
FORD	AB313289BA						
							

S071319		S071320		S071321		S071322	
JEEP	52060049AE	JEEP	051894419AA	DAIHATSU	45047B9020	DAIHATSU	45046B9020
		JEEP	5189419AA				
		JEEP	52125484AA				
							

S071328		S071329		S071337		S071340	
CHRYSLER	68069646AA	CHRYSLER	68069647AA	FORD	1961668	AUDI	1J0422811B
JEEP	68069646AB	JEEP	68069647AB	NISSAN	4852031G25	AUDI	1J0422811D
				NISSAN	485207F000	SEAT	1J0422811E
							

Cross References List And Photo

Photo.....





S071341		S071367		S071368		S071388	
AUDI	1J0422812B	INFINITI	486305DF0A	INFINITI	485105DF0A	DACIA	485200368R
AUDI	1J0422812D	MERCEDES-BENZ	2463301700	MERCEDES-BENZ	2463301800		
SEAT	1J0422812E	MERCEDES-BENZ	A2463301700	MERCEDES-BENZ	A2463301800		
							





S071389		S071544		S071567		S071568	
DACIA	485208355R	KIA	0K01132250A	FORD	1729240	FORD	1727226
				FORD	AB313290AA	FORD	AB313289AA
							





S071616		S071617		S071621		S071622	
MERCEDES-BENZ	2054600605	MERCEDES-BENZ	2054600705	FIAT	77366165	FIAT	77366166
MERCEDES-BENZ	A2054600605	MERCEDES-BENZ	A2054600705	FIAT	77366698	FIAT	77366699
							

Cross References List And Photo

Photo.....





S071631		S071632		S071634		S071639	
VW	701419812D	AUDI	8W0423811B	AUDI	8W0423812B	CITROËN	1610817880
		AUDI	8W0423811C	AUDI	8W0423812C	CITROËN	1611242280
						CITROËN	1642547580
							

S071651		S071652		S071654		S071656	
BMW	32106854737	BMW	32106854734	CITROËN	1610817780	CITROËN	1623141180
MINI	32105A018C9	MINI	32105A018B9	CITROËN	1611242180		
MINI	5A018C9	MINI	5A018B9	CITROËN	1642547480		
							

S071657		S071665		S071668		S071669	
CITROËN	1623141080	BMW	32106792674	PEUGEOT	3817A1	PEUGEOT	3817A2
							

Cross References List And Photo

Photo.....





S071672		S071677		S071686		S071689	
INFINITI	48640EG025	LAND ROVER	LR010676	MINIBISHI	MB166426	JAGUAR	T4N20185
INFINITI	48640EG026	LAND ROVER	LR059261			LAND ROVER	LR027570
INFINITI	D86404GA0A	LAND ROVER	QJB500070				
							





S071690		S071695		S071698		S071700	
JAGUAR	T4N20184	LAND ROVER	LR033534	TOYOTA	4504609600	BMW	32106797617
LAND ROVER	LR026267						
							

S071701		S071704		S071706		S071707	
BMW	32106797618	TOYOTA	4504609800	HYUNDAI	568202W000	HYUNDAI	568202W050
				HYUNDAI	568202W500	HYUNDAI	568202W550
				HYUNDAI	568204Z000	HYUNDAI	568204Z050
							

Cross References List And Photo

Photo.....

S071733		S071734		S071738		S071739	
TOYOTA	4547009140	FORD	1802977	FORD	1802974	MERCEDES-BENZ 2043301903	
TOYOTA	4547009150	FORD	5333724	FORD	5333720	MERCEDES-BENZ 2123301303	
TOYOTA	4547039345	FORD USA	DG9C3290CA	FORD USA	DG9C3289CA	MERCEDES-BENZ A2043301903	
							

S071740		S071762		S071763		S071764	
MERCEDES-BENZ 2043302003		MERCEDES-BENZ 1773308600		MERCEDES-BENZ 1773308700		LAND ROVER RTC5869	
MERCEDES-BENZ 2123301403		MERCEDES-BENZ A1773308600		MERCEDES-BENZ A1773308700			
MERCEDES-BENZ A2043302003							
							



S071766		S071771		S071772		S071773	
TOYOTA	4546009230	HONDA	53560T5A003	HONDA	53540T5A003	MERCEDES-BENZ 2054600005	
TOYOTA	4546009240	HONDA	53560T5R003	HONDA	53540T5R003	MERCEDES-BENZ 2054604702	
TOYOTA	4546080005					MERCEDES-BENZ A2054600005	
							

Cross References List And Photo

Photo.....





S071774	S071775	S071776	S071777
<p>MERCEDES-BENZ 2054600105 MERCEDES-BENZ 2054604602 MERCEDES-BENZ A2054604602</p> 	<p>LAND ROVER NTC1887D LAND ROVER RTC5870</p> 	<p>MERCEDES-BENZ 1773308500 MERCEDES-BENZ A1773308500</p> 	<p>MERCEDES-BENZ 1773308400 MERCEDES-BENZ A1773308400</p> 





S071784	S071785	S071807	S071812
<p>SUBARU 31320GA190</p> 	<p>SUBARU 31320GA200</p> 	<p>TOYOTA 4504749165</p> 	<p>TESLA 600707100A TESLA 600707100B</p> 

S071814	S071815	S071817	S071818
<p>TESLA 104484100E</p> 	<p>TESLA 102784100B</p> 	<p>HYUNDAI 56820M0000</p> 	<p>HYUNDAI 56825M0000</p> 

Cross References List And Photo

Photo.....





S071819	S071823	S071824	S071839
JAGUAR T4A12525 JAGUAR T4A28746 LAND ROVER LR111480	SSANGYONG 4666034000	TOYOTA 4504649225	FORD 7T4Z3A130B
			





S071840	S071841	S071842	S071843
FORD 7T4Z3A130A	PORSCHE 958423811A	PORSCHE 97034713201	PORSCHE 97034713101
			





S080005	S080008	S080009	S080010
ALFA ROMEO 51783056 OPEL 352067 OPEL 352087	AUDI 893407365B AUDI 895407365 AUDI 8A0407365	AUDI 893407366B AUDI 895407366 AUDI 8A0407366	AUDI 6Q0407365A AUDI 6Q0407365D AUDI 6Q0407365E
			

Cross References List And Photo

Photo.....





S080011		S080012		S080013		S080014	
AUDI	6Q0407366A	AUDI	1K0407366B	AUDI	1K0407365B	AUDI	5U0407366A
AUDI	6Q0407366E	AUDI	1K0407366C	AUDI	1K0407365C	AUDI	6R0407366
AUDI	6Q0407366M	AUDI	1K0407366E	AUDI	1K0407365E	AUDI	6R0407366A
							





S080015		S080016		S080017		S080018	
AUDI	5U0407365A	AUDI	1J0407365	AUDI	1J0407366A	BMW	31121096425
AUDI	6R0407365	AUDI	1J0407365A	AUDI	1J0407366C	BMW	31122180455
AUDI	6R0407365A	AUDI	1J0407365C	AUDI	1J0407366H	BMW	31126756491
							





S080019		S080020		S080025		S080026	
BMW	31103412726	ALPINA	31121126253	ALPINA	31121096685	BMW	0363476
BMW	31103418341	ALPINA	31121126296	ALPINA	31121140398	BMW	31103438623
		BMW	31121139131	ALPINA	31126758510	BMW	3438623
							

Cross References List And Photo

Photo.....





S080030		S080031		S080032		S080033	
CHRYSLER	04656010	CITROËN	364050	CITROËN	1607298480	CITROËN	364038
CHRYSLER	4364782	CITROËN	364050S1	CITROËN	364056	CITROËN	364039
CHRYSLER	4656010	CITROËN	364051	CITROËN	364065	CITROËN	364042
							





S080035		S080037		S080038		S080039	
CITROËN	364054	CITROËN	364067	CITROËN	364055	CITROËN	364033
FIAT	1300473080	CITROËN	364076	FIAT	1330515080	FIAT	1300473080
FIAT	1331641080	FIAT	50705629	FIAT	1331640080		
							





S080040		S080042		S080043		S080044	
CITROËN	1607297480	CITROËN	364058	CITROËN	1607298680	CITROËN	364028
CITROËN	364053	CITROËN	364069	CITROËN	364057	CITROËN	364034
CITROËN	364060	CITROËN	364072	CITROËN	364074	CITROËN	364071
							

Cross References List And Photo

Photo.....





S080045		S080048		S080051		S080052	
CITROËN	1614439280	CITROËN	364020	DAEWOO	96300648	DAEWOO	96213119
CITROËN	364036	CITROËN	364021	KIA	0K20134550D		
CITROËN	96093233	CITROËN	95494204	MAZDA	B00134550		
							





S080053		S080054		S080055		S080056	
GMC	52282309	FIAT	46437951	FIAT	46543045	FIAT	46779293
OPEL	1603120	FIAT	46437959	FIAT	7081835	FIAT	46842581
OPEL	1603164	FIAT	46454599			FIAT	7082812
							





S080057		S080058		S080061		S080062	
FORD	96FB3395AB	FORD	1451914	FORD	1679390	FORD	1033616
		FORD	4120734	FORD	93BB3395AC	FORD	1047853
		FORD	4173761	FORD	ME93BB3395AA	FORD	89FB3395AB
							

Cross References List And Photo

Photo.....





S080065		S080066		S080067		S080069	
FORD	1030025	FORD	1954430	FORD	1954431	FORD	1234382
FORD	1030026	NISSAN	4011001G00	NISSAN	401600F000	FORD	1679384
FORD	1047797	NISSAN	4011001G25	NISSAN	4016050W00	VOLVO	31212979
							

S080070		S080071		S080073		S080074	
FORD	1470387	FORD	2L3Z3050AA	HONDA	51220S04003	ACURA	51220SB0003
FORD	1679388	FORD	F57Z3050BB	HONDA	51220SR0A01	ACURA	51220SB0023
VOLVO	31201180	FORD	F5TZ3078A	HONDA	51220SR0A03	ACURA	51220SE0000
							

S080075		S080076		S080078		S080080	
HONDA	51230SNAA02	HONDA	51220SNAA02	HONDA	51220SAA013	ACURA	51220S0AJ01
HONDA	51230SNAA03	HONDA	51220SNAA03	HONDA	51220SAAE01	ACURA	51220S4KA00
HONDA	51230SNLT01	HONDA	51220SNLT01	HONDA	51220SELT01	ACURA	51220S84A01
							

Cross References List And Photo

Photo.....





S080082		S080083		S080084		S080085	
HYUNDAI	5453024000	HYUNDAI	5450334A00	HYUNDAI	5441743000	HYUNDAI	5453047000
HYUNDAI	5453024A00	HYUNDAI	5450334A01	HYUNDAI	5441743001	HYUNDAI	545304A000
HYUNDAI	5453028000	HYUNDAI	5453034A01	HYUNDAI	5441743A00	HYUNDAI	545304AA00
							





S080086		S080090		S080091		S080092	
HYUNDAI	5453002000	HYUNDAI	545032BA00	HYUNDAI	5176038000	HYUNDAI	517602E000
HYUNDAI	5453002050	HYUNDAI	545302B000	HYUNDAI	5176038000AT	HYUNDAI	517602E010
HYUNDAI	5453002500	HYUNDAI	545303B000	HYUNDAI	5176138A00	HYUNDAI	517702E010
							





S080093		S080095		S080096		S080097	
HYUNDAI	517603K000	HYUNDAI	5453007000	HYUNDAI	517600Q000	HYUNDAI	5452443000
		HYUNDAI	5453007000S1	HYUNDAI	517602G000	HYUNDAI	5452443001
		HYUNDAI	545300X000	HYUNDAI	517602H000	HYUNDAI	5452443002
							

Cross References List And Photo

Photo.....

S080098		S080103		S080106		S080107	
HYUNDAI	5450322A00	JEEP	05012432AA	KIA	0K2A134550A	HYUNDAI	0G03034550B
HYUNDAI	5450325A00	JEEP	5012432AA	KIA	0K2FA34550	MAZDA	G03099356
HYUNDAI	5450331600	JEEP	68004085AA			MAZDA	GA6A99356
							





S080109		S080111		S080112		S080116	
KIA	0K01134510B	LADA	21082904185	LADA	21012904185	MAZDA	E17Z3049A
		LADA	21082904192	LADA	21012904192	MAZDA	UA0199354
		LADA	21102904192	LADA	4186630		
							





S080117		S080119		S080121		S080123	
MAZDA	E17Z3050A	MAZDA	B01A34550	MAZDA	NA0134550	FORD	3665787
MAZDA	UA0199356	MAZDA	B01A34550A	MAZDA	NA0134550A	MAZDA	8AU334510
		MAZDA	BTDA34550	MAZDA	NA0134550B	MAZDA	UH7434550
							

Cross References List And Photo

Photo.....





S080124		S080127		S080130		S080131	
MAZDA	8AU234510	MERCEDES-BENZ	1163330927	MERCEDES-BENZ	1633300035	MERCEDES-BENZ	1633500013
MAZDA	UB3999356	MERCEDES-BENZ	A1163330927	MERCEDES-BENZ	1633300135	MERCEDES-BENZ	1633500013S1
MAZDA	UH7134550			MERCEDES-BENZ	A1633300035	MERCEDES-BENZ	1633500113
							





S080132		S080133		S080134		S080136	
MERCEDES-BENZ	1683300127	MERCEDES-BENZ	1693330127	MERCEDES-BENZ	2113230068	MERCEDES-BENZ	2113300235
MERCEDES-BENZ	1683330127	MERCEDES-BENZ	1693330327	MERCEDES-BENZ	2203230368	MERCEDES-BENZ	2113300435
MERCEDES-BENZ	1683330227	MERCEDES-BENZ	A1693330127	MERCEDES-BENZ	A2113230068	MERCEDES-BENZ	2203330127
							

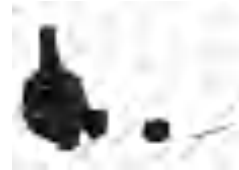



S080138		S080141		S080142		S080143	
MERCEDES-BENZ	1643300935	MERCEDES-BENZ	1243330127	MERCEDES-BENZ	1403330327	MERCEDES-BENZ	2023330027
MERCEDES-BENZ	A1643300935	MERCEDES-BENZ	1243330327	MERCEDES-BENZ	A1403330327	MERCEDES-BENZ	2103300035
		MERCEDES-BENZ	A1243330127			MERCEDES-BENZ	2103300427
							

Cross References List And Photo

Photo.....





S080144	S080145	S080147	S080151
MERCEDES-BENZ 9013330627 VW 2D0407361A VW 2D0407361B	MERCEDES-BENZ 0003301007 MERCEDES-BENZ 2113308907 MERCEDES-BENZ 2113309907	HYUNDAI 5441743A00 HYUNDAI 5441747000 HYUNDAI 544174A000	MITSUBISHI MB831038 MITSUBISHI MR296270
			





S080152	S080153	S080154	S080155
MITSUBISHI MB831037 MITSUBISHI MR296269	MITSUBISHI MB860829 MITSUBISHI MB860830	MITSUBISHI MB52751101	MITSUBISHI MB527351
			



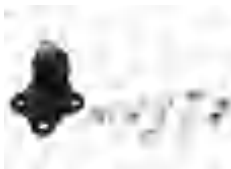

S080156	S080157	S080158	S080159
MITSUBISHI MB527352	MITSUBISHI 4010A015 MITSUBISHI 4010A099 MITSUBISHI MR496792	MITSUBISHI 4013A087T1 MITSUBISHI 4013A088T1 MITSUBISHI 4013A090	MITSUBISHI 4110A072 MITSUBISHI 4110A073 MITSUBISHI MR508130
			

Cross References List And Photo

Photo.....





S080171		S080172		S080173		S080174	
NISSAN	4016000AC	NISSAN	4016000QAB	OPEL	4408958	NISSAN	5450100QAH
NISSAN	4016000QAC	OPEL	4500254	RENAULT	6040002105	RENAULT	7700434177
OPEL	4100255	RENAULT	7700312851	RENAULT	7701476576	RENAULT	7700783447
							





S080176		S080187		S080191		S080197	
NISSAN	4016000Q0B	PEUGEOT	364048	PEUGEOT	364030	RENAULT	7700730765
OPEL	4418631	PEUGEOT	364048S1	PEUGEOT	364031	RENAULT	7700829843
RENAULT	7701070154	PEUGEOT	364049	PEUGEOT	364037	RENAULT	7701468411
							





S080207		S080208		S080210		S080211	
RENAULT	7701464037	RENAULT	7700418693	RENAULT	401600005R	SEAT	357407365
RENAULT	83505212	RENAULT	7700421804	RENAULT	401609060R	SEAT	357407365A
		RENAULT	7700807194	RENAULT	545009207R	SEAT	357407365S
							

Cross References List And Photo

Photo.....





S080212		S080218		S080221		S080233	
SEAT	1H0407365	SUBARU	20206AJ000	TOYOTA	4333009070	TOYOTA	4333029235
SEAT	1H0407365A	SUBARU	20206SJ000	TOYOTA	4333009090		
SEAT	1H0407365S	SUBARU	21067GA050	TOYOTA	4333009230		
							





S080234		S080236		S080237		S080241	
LEXUS	4333006020	LEXUS	4334009010	LEXUS	4333009160	TOYOTA	4334019025
LEXUS	4333006021	LEXUS	4334029175	LEXUS	4333009180		
LEXUS	4333009050	LEXUS	4334029215	LEXUS	4333029405		
							





S080242		S080244		S080245		S080246	
TOYOTA	4333019085	LEXUS	4333009630	VW	4D0407361	VW	131405361E
		LEXUS	4333019245	VW	7D0407361	VW	131405361F
		LEXUS	4333049095			VW	131405361G
							

Cross References List And Photo

Photo.....



S080247		S080249		S080258		S080259	
VW	131405371G	VW	7E0407361	AUDI	3C0407365A	AUDI	3C0407366A
VW	131405371H	VW	7H0407361	AUDI	3C0407365B	AUDI	3C0407366B
VW	131405371J	VW	7H0407361A	VW	35D407365	VW	35D407366
							





S080260		S080262		S080264		S080265	
VW	7E8407361	VW	701407187	VOLVO	1229573	VOLVO	274377
VW	7H8407361	VW	701407187A	VOLVO	1270477	VOLVO	274523
VW	7H8407361A	VW	701407187B	VOLVO	1273819	VOLVO	274573
							

S080269		S080270		S080271		S080273	
VOLVO	3270523	VOLVO	0271591	JEEP	8983500202	JEEP	83500202
VOLVO	3410519	VOLVO	271591			JEEP	83500202AB
VOLVO	3465482	VOLVO	3546524				
							

Cross References List And Photo

Photo.....

S080275		S080278		S080283		S080286	
JEEP	5069161AB	JEEP	52088808AB	AUDI	8K0407689D	MINI	31124048629
JEEP	5114037AB			AUDI	8K0407689E	MINI	31126772303
				AUDI	8K0407689F		
							





S080287		S080292		S080298		S080301	
BMW	31124048630	FORD	1139828	FORD	1417351	FIAT	5939683
BMW	31126772304	FORD	1311416	FORD	1451917		
		FORD	1S713395AE	FORD USA	KT6C113K209AA		
							

S080304		S080309		S080312		S080328	
JAGUAR	C12803	LAND ROVER	RBK000010	LAND ROVER	RBK500030	CHEVROLET	96852964
JAGUAR	CAC9937	LAND ROVER	RBK000011	LAND ROVER	RBK500161	OPEL	4806300
JAGUAR	JLM11860	LAND ROVER	RBK000012	LAND ROVER	RBK500170	VAUXHALL	15293924
							

Cross References List And Photo

Photo.....





S080334		S080337		S080338		S080340	
NISSAN	4011000QAA	LAND ROVER	FTC3570	LAND ROVER	FTC3571	JAGUAR	C15890
OPEL	4401910					JAGUAR	C23024
OPEL	4500090					JAGUAR	CAC9938
							

S080352		S080357		S080358		S080359	
SUZUKI	4570060A00	AUDI	8N0407365A	VW	701407361	VOLVO	274185
SUZUKI	4570060A01	AUDI	8N0407365B	VW	701407361B	VOLVO	274186
SUZUKI	4570085C00	AUDI	8N0407365C			VOLVO	274187
							





S080372		S080374		S080387		S080391	
TOYOTA	4333029225	TOYOTA	4331009015	NISSAN	401600W000	NISSAN	401102S485
TOYOTA	4333029325	TOYOTA	4331009030	NISSAN	401600W025	NISSAN	401102S486
TOYOTA	4333029326	TOYOTA	433100K010	NISSAN	D01600W025	NISSAN	401102S685
							

Cross References List And Photo

Photo.....



S080393		S080398		S080408		S080416	
NISSAN	4016031U00	MITSUBISHI	MB002475	MAZDA	8AU134540	HONDA	51270S01013
NISSAN	4016039U00	MITSUBISHI	MB002476	MAZDA	8UB134540	HONDA	51270S01023
NISSAN	4016041U00	MITSUBISHI	MB109585	MAZDA	8UB3999354	HONDA	51270S04013
							

S080441		S080455		S080459		S080461	
FIAT	4402644	HYUNDAI	545303J000	TOYOTA	4333009295	LEXUS	4334009040
FIAT	4402649	HYUNDAI	545304D000	TOYOTA	4333009490	LEXUS	4334009100
FIAT	SE141140104A			TOYOTA	4333009510	LEXUS	4334039545
							



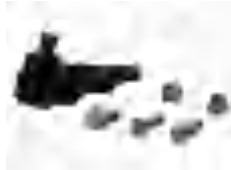

S080462		S080465		S080470		S080473	
LEXUS	4333009330	HONDA	51220STKA01	HYUNDAI	5440338A00	HONDA	51220TA0A01
LEXUS	4333009590	HONDA	51220T0AA01	HYUNDAI	544303F600	HONDA	51220TA0A02
LEXUS	4333039775			HYUNDAI	544303K000		
							

Cross References List And Photo

Photo.....





S080474		S080475		S080476		S080500	
HONDA	51220S9A982	MITSUBISHI MR4034191 MITSUBISHI MR4034201 MITSUBISHI MR403421		TOYOTA	4333060010	HYUNDAI 545302T010 HYUNDAI 545303S100 KIA 545302P100	
							

S080501		S080507		S080510		S080518	
HYUNDAI 545302S500 HYUNDAI 545303S000 KIA 545303R000		HYUNDAI 545302K000 KIA 54530H8000		HYUNDAI 5441744000 HYUNDAI 5443144000		FORD	F6DZ3K185A
							

S080576		S080584		S080591		S080593	
CHEVROLET 15140219 CHEVROLET 19133638 CHEVROLET 22157320		HYUNDAI 54550H1000 HYUNDAI 54550H1010		LEXUS 4331060010 LEXUS 4861060030 TOYOTA 4331060020		NISSAN 40160ED000 NISSAN 40160ED00A NISSAN 54500ET000	
							

Cross References List And Photo

Photo.....





S080594		S080620		S080625		S080639	
NISSAN	40110EA000	FORD	1679401	CHRYSLER	4616570	DODGE	5135651AB
		FORD	98AG3042ZZ	CHRYSLER	4656240	DODGE	5135651AC
		FORD	98AG3395AE	CHRYSLER	4656241	DODGE	5135651AD
							



S080640		S080643		S080648		S080650	
CHRYSLER	05085914AB	HYUNDAI	54440H1000	NISSAN	40110EB300	OPEL	4419219
CHRYSLER	5085914AB			NISSAN	54524EB300	RENAULT	8200688877
CHRYSLER	5085914AC			NISSAN	54524EB30A	VAUXHALL	93197233
							





S080652		S080653		S080666		S080668	
LEXUS	4333039625	LEXUS	4334039505	VAUXHALL	95509251	LEXUS	4334009140
				VAUXHALL	95519325	LEXUS	4334049015
				VAUXHALL	95525924	LEXUS	4334049035
							

Cross References List And Photo

Photo.....

S080669		S080671		S080674		S080677	
LEXUS	4333009780	MERCEDES-BENZ	2123300035	CHRYSLER	68069648AA	JEEP	52090206AF
LEXUS	4333049125	MERCEDES-BENZ	2123300035S1	CHRYSLER	68069648AB	JEEP	52090206AG
LEXUS	4333049165	MERCEDES-BENZ	2123300135			JEEP	52090206AH
							





S080690		S080691		S080695		S080701	
HYUNDAI	517602R000	SSANGYONG	4454109002	CHRYSLER	68012164AAS1	JEEP	52088647AA
		SSANGYONG	4454109003	MERCEDES-BENZ	68012164AA	JEEP	52088647AB
		SSANGYONG	4454109004	VW	2E0407152M		
							

S080703		S080706		S080707		S080708	
HONDA	51210S9A020	NISSAN	545244JA0A	CHRYSLER	4782740AB	FORD	6L5Z3050AA
HONDA	51210S9A982	NISSAN	54524EA000	CHRYSLER	4782740AE	FORD	7L2Z3050A
HONDA	51215S9A020			CHRYSLER	68159271AA		
							

Cross References List And Photo

Photo.....





S080709		S080729		S080749		S080755	
FORD	1521773	FORD	1L2Z3084AA	OPEL	22156822	CHEVROLET	15158958
FORD	8V513051BB			OPEL	22157089	CHEVROLET	19133670
MAZDA	D65134300			OPEL	352068	CHEVROLET	22157319
MAZDA	D65134300B						
MAZDA	D65134300D						
MAZDA	D65134350						
							

S080816		S080817		S080823		S080825	
VW	5Z0407365C	VW	5Z0407366C	CHEVROLET	3986009	NISSAN	401602ZS00
				GENERAL MOTORS	335878	NISSAN	401609W200
				GENERAL MOTORS	338388	NISSAN	401609W20C
							

S080844		S080845		S080856		S080860	
RENAULT	401604793R	NISSAN	40160EA00A	NISSAN	40160EB310	FORD	1377846
RENAULT	8200298454	NISSAN	40160EB300	NISSAN	40160EB70A	FORD	1385593
RENAULT	8200298455	NISSAN	54500EB30C			FORD	1403408
							

Cross References List And Photo

Photo.....

S080861		S080862		S080874		S080931	
JAGUAR	XR841215	IVECO	93802242	CHRYSLER	4766911AD	FORD	104222
		IVECO	93807545	CHRYSLER	4766911AE		
		PEUGEOT	360825				
							





S080935		S080959		S080980		S080985	
MITSUBISHI	MB912505	DACIA	545010294R	MITSUBISHI	4013A090	HYUNDAI	54530C1100
MITSUBISHI	MB912506	DACIA	545011727R	MITSUBISHI	4013A098	HYUNDAI	54530D3100
MITSUBISHI	MR162803	RENAULT	545052737R	MITSUBISHI	4013A211	HYUNDAI	54530D7100
							





S080986		S080987		S080988		S080995	
HYUNDAI	54530C1000	AUDI	4G0407689A	CITROËN	9803434080	LAND ROVER	RBK500040
HYUNDAI	54530D3000	AUDI	4G0407689C	GENERAL MOTORS	3637430	LAND ROVER	RBK500180
HYUNDAI	54530D7000	AUDI	8W0407689B	OPEL	03637430	LAND ROVER	RBK500230
							

Cross References List And Photo

Photo.....





S080996		S080998		S081016		S081021	
BMW	33321095412	AUDI	2H0407021A	FORD	1959337	NISSAN	545001FU0A
BMW	33326768274	AUDI	2H0407021B	NISSAN	401607F000	NISSAN	545011FU0A
BMW	33326770748	AUDI	2H0407022A				
							

S081022		S081024		S081026		S081027	
CHERY	M112909060	SUBARU	20206XA000	MITSUBISHI	4013A036	FIAT	51945321
		SUBARU	20206XA001	MITSUBISHI	4013A235		
		SUBARU	20206XA002	MITSUBISHI	4013A236		
							



S081028		S081031		S081033		S081034	
CITROËN	364078	BMW	31106787665	DAEWOO	4443003010	CITROËN	364032
				DAEWOO	4443003011	FIAT	1302368080
				DAEWOO	4443203010		
							

Cross References List And Photo

Photo.....



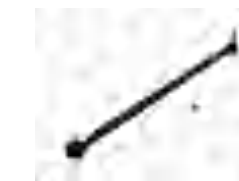

S081036	S081041	S081046	S081051
SSANGYONG 4451834000 SSANGYONG 4451834001	SSANGYONG 4450505001 SSANGYONG 4450505001X	HONDA 06510TBAA00 HONDA 51220TBAA01	HONDA 51220TEAT01
			





S081054	S081068	S100003	S100004
CHRYSLER 5105040AA CHRYSLER 5105040AD CHRYSLER 5105040AE	FORD 9L3Z3078A	AUDI 8N0422804 AUDI 8N0422804A AUDI 8N0422804C	AUDI 8N0422803 AUDI 8N0422803A AUDI 8N0422803C
			





S100005	S100007	S100008	S100010
AUDI 4E0419801C AUDI 4E0419801D AUDI 4E0419801E	AUDI 4A0419801A	AUDI 4A0419802A	AUDI 1J0422804B AUDI 1J0422804E AUDI 1J0422804H
			

Cross References List And Photo

Photo.....

S100011		S100012		S100014		S100015	
AUDI	1J0422803B	AUDI	811419801C	AUDI	4B0419801B	AUDI	1J0422803
AUDI	1J0422803E	AUDI	811419801E	AUDI	4B0419801E	AUDI	1J0422803A
AUDI	1J0422803H			AUDI	4B0419801M	AUDI	1J0422803C
							





S100016		S100017		S100019		S100020	
AUDI	1J0422804	ALPINA	32106774223	ALPINA	32211124231	BMW	33321123463
AUDI	1J0422804A	BMW	32106777504	ALPINA	32211129020	BMW	33321125665
AUDI	1J0422804C	BMW	32111096898	ALPINA	32211135666	BMW	33321126476
							

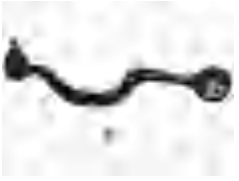
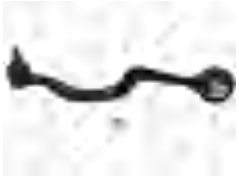
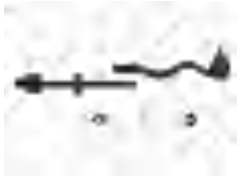
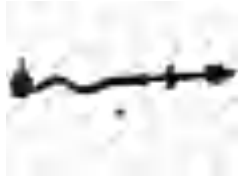

S100022		S100023		S100024		S100026	
ALPINA	32111125186	BMW	1125187	BMW	32211130655	BMW	32211130661
ALPINA	32111126360	BMW	32111125187	BMW	32211133525	BMW	32211133615
BMW	1125186	BMW	32111126362	BMW	32211136681	BMW	32211136685
							

Cross References List And Photo

Photo.....

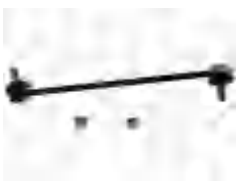

S100027		S100028		S100029		S100030	
BMW	31121132159	BMW	31121132160	ALPINA	32111139315	ALPINA	32111139316
BMW	31121133711	BMW	31121133712	ALPINA	32111139317	BMW	1139316
BMW	31121141097	BMW	31121141098	BMW	1139315		
							





S100031		S100032		S100033		S100034	
ALPINA	32211091913	ALPINA	32111091768	ALPINA	32111091767	BMW	1091856
ALPINA	32211093433	ALPINA	32111093770	ALPINA	32111093769	BMW	31351091856
ALPINA	32211096057	ALPINA	32111094674	ALPINA	32111094673	BMW	31351095662
							



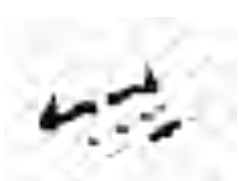

S100035		S100036		S100037		S100043	
BMW	1091855	BMW	1091496	BMW	1091497	CITROËN	508723
BMW	31351091855	BMW	31351091496	BMW	33551091497	CITROËN	508732
BMW	31351095661	BMW	31351095695	BMW	33551095696	CITROËN	508740
							

Cross References List And Photo

Photo.....





S100044		S100050		S100052		S100054	
PEUGEOT	508738	CHEVROLET	96300627	CHEVROLET	7848281	FORD	1954599
PEUGEOT	508742			OPEL	322125	FORD	1960076
				VAUXHALL	90125567	FORD	1960077
							





S100057		S100058		S100059		S100060	
KIA	0K01132290A	KIA	0K55232280	KIA	0K01132270A	LADA	21213414011
				KIA	0K01132270C		
							





S100061		S100063		S100065		S100066	
LADA	21013003011	CHRYSLER	05101545AA	MERCEDES-BENZ	2013300703	MERCEDES-BENZ	2013301203
LADA	4183707	CHRYSLER	5101545AA	MERCEDES-BENZ	2013301503	MERCEDES-BENZ	2013301603
		MERCEDES-BENZ	1243200289	MERCEDES-BENZ	A2013300703	MERCEDES-BENZ	A2013301203
							

Cross References List And Photo

Photo.....





S100070	S100073	S100075	S100076
MERCEDES-BENZ 1163300203 MERCEDES-BENZ 1263300303 MERCEDES-BENZ 1263300403	MERCEDES-BENZ 1243300803 MERCEDES-BENZ 1243300903 MERCEDES-BENZ A1243300803	MERCEDES-BENZ 1244601205 MERCEDES-BENZ A1244601205	MERCEDES-BENZ 1403201189 MERCEDES-BENZ A1403201189
			



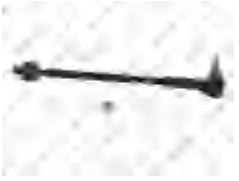

S100077	S100078	S100079	S100086
MERCEDES-BENZ 1403201289 MERCEDES-BENZ A1403201289	MERCEDES-BENZ 1403300003 MERCEDES-BENZ 1403300103 MERCEDES-BENZ A1403300003	MERCEDES-BENZ 2024600405 MERCEDES-BENZ A2024600405	PEUGEOT 517838 PEUGEOT 9615230080
			



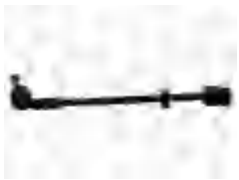

S100090	S100091	S100112	S100115
PEUGEOT 517817 PEUGEOT 517821 PEUGEOT 517830	PEUGEOT 517818 PEUGEOT 517822 PEUGEOT 517831	RENAULT 7700805494	SEAT 6Q0419803B SKODA 6Q0419803D SKODA 6Q0419803F
			

Cross References List And Photo

Photo.....



S100116		S100119		S100120		S100123	
SEAT	6Q0423804B	VW	6K0422803A	VW	6K0422804A	AUDI	191419804A
SEAT	6Q0423804E	VW	6K0422803D	VW	6K0422804D	SEAT	191419804
SEAT	6Q0423804P						
							





S100124		S100125		S100126		S100127	
AUDI	191422803A	AUDI	191422804	AUDI	191419803A	SEAT	535411315
SEAT	191422803	SEAT	191422804A	SEAT	191419803	VW	1H0411315
						VW	1H0411316
							

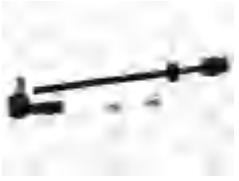
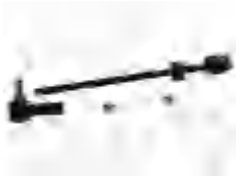

S100128		S100129		S100146		S100147	
VW	1H0422803	VW	1H0422804	AUDI	357419803	AUDI	357419804
				VW	357419803A	VW	357419804A
							

Cross References List And Photo

Photo.....



S100148		S100149		S100152		S100153	
AUDI VW	1H0419803A 1H0419803	AUDI VW	1H0419804A 1H0419804	AUDI VW	701419804A 701419804C	VW	701419804E
							

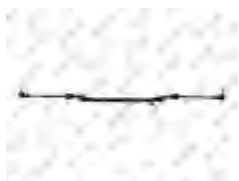



S100154		S100156		S100157		S100161	
VW	701419803E	AUDI VW VW	3A0422804C 357422804 357422804A	VOLVO VOLVO VOLVO	1387860 13878608 30647995	VW VW	701419803A 701419803C
							



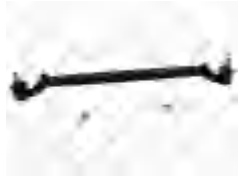

S100172		S100178		S100181		S100183	
LAND ROVER LAND ROVER	TIQ000010 TIQ100000	LAND ROVER LAND ROVER	ANR3826 TIQ000020	MERCEDES-BENZ MERCEDES-BENZ MERCEDES-BENZ	2014601405 2014601505 A2014601405	MERCEDES-BENZ MERCEDES-BENZ	2024600505 A2024600505
							

Cross References List And Photo

Photo.....





S100186	S100189	S100190	S100191
MERCEDES-BENZ 1264600605 MERCEDES-BENZ 1264600805 MERCEDES-BENZ A1264600605	MERCEDES-BENZ 1244600805 MERCEDES-BENZ A1244600805	MERCEDES-BENZ 1244600905 MERCEDES-BENZ A1244600905	MERCEDES-BENZ 1404600805 MERCEDES-BENZ A1404600805
			





S100210	S100254	S100263	S100264
VW 357422803 VW 357422803D	ALPINA 32106774222 ALPINA 32106777503 ALPINA 32111096897	AUDI 7L0422803B AUDI 7L0422803C VW 2H0419803	AUDI 7L0422804B AUDI 7L0422804C VW 2H0419804
			



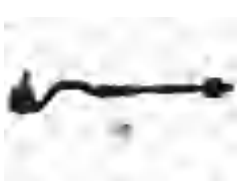

S100290	S100298	S100299	S100329
ALPINA 32211091720 ALPINA 32211096059 BMW 3221096059	VW 7E0419804 VW 7H0419804B VW 7H0419804C	VW 7E0419803 VW 7H0419803B VW 7H0419803C	BMW 32106774347 BMW 32106777479 BMW 32216762403
			

Cross References List And Photo

Photo.....





S100330		S100331		S100332		S100333	
BMW	32106765235	BMW	32106765236	BMW	32216762243	BMW	32216762244
							





S100334		S100335		S100339		S100345	
BMW	32106774360	BMW	32106774336	BMW	32103412798	BMW	32106768879
BMW	32106777268	BMW	32216751277	BMW	32103444999	BMW	32106793621
BMW	32216756368	BMW	32216760470	BMW	32106780985		
							

S100346		S100350		S100351		S100360	
BMW	32106768880	BMW	32106792029	BMW	32106792030	CHEVROLET	07848282
BMW	32106793622					DAEWOO	7848282
						OPEL	322126
							

Cross References List And Photo

Photo.....



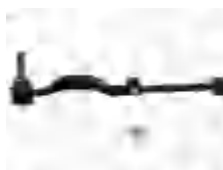

S100368		S100373		S100374		S100383	
HYUNDAI	56850H1001	BMW	32211130662	BMW	32211091914	SUZUKI	4880060A00
HYUNDAI	56850H1011	BMW	32211133618	BMW	32211093434		
		BMW	32211136686	BMW	32211096058		
							



S100390		S100391		S100401		S100406	
MINI	32109803321	MINI	32109803322	MERCEDES-BENZ	9014600048	SUZUKI	4890070A60
MINI	9803321	MINI	9803322	MERCEDES-BENZ	9014600148		
				VW	2D0422833		
							



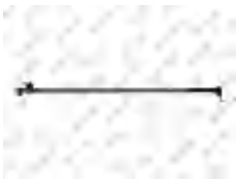

S100407		S100408		S100409		S100410	
MINI	32106854733	MINI	32106854736	BMW	32106867405	BMW	32106867404
MINI	32106899813	MINI	32106899814	BMW	32106899816	BMW	32106899815
MINI	6854733	MINI	6854736				
							

Cross References List And Photo

Photo.....





S100413		S100416		S100417		S100421	
JAGUAR	XR813478	LAND ROVER	ANR3825	LAND ROVER	QHG000040	LAND ROVER	LR019117
JAGUAR	XR81786	LAND ROVER	QHG000070	LAND ROVER	QHG100000	LAND ROVER	RGD500083
JAGUAR	XR825750					LAND ROVER	RGD500190
							



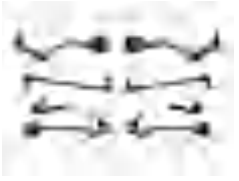

S100424		S100425		S100430		S100434	
LAND ROVER	QEK000050	LAND ROVER	QEK000040	JAGUAR	C2C13835	VW	1K0423810A
LAND ROVER	STC1872	LAND ROVER	STC1873	JAGUAR	C2C1802	VW	1K0423812J
				JAGUAR	C2C18419		
				JAGUAR	C2C24305		
				JAGUAR	C2C36985		
				JAGUAR	C2D51042		
				JAGUAR	C2D51044		
				JAGUAR	C2D5361		
							





S100435		S990001SK		S990002SK		S990003SK	
VW	1K0423810A	AUDI	8D0498998	BMW	31121092023	BMW	31126769717
VW	1K0423811J	AUDI	8D0498998S1	BMW	31121092023S1	BMW	31126769717S1
		VW	4D0407151B				
							

Cross References List And Photo

Photo.....





S990004SK		S990005SK		S990006SK		S990007SK	
BMW	31126769797S1	MERCEDES-BENZ	1683309907	MERCEDES-BENZ	2033303911	MERCEDES-BENZ	2113200989
BMW	31126769798S1	MERCEDES-BENZ	1683309907S1	MERCEDES-BENZ	2033303911S2	MERCEDES-BENZ	2113200989S1
BMW	31126770849S1					MERCEDES-BENZ	2113302911
							





S990008SK		S990009SK		S990011SK		S990012SK	
AUDI	8E0498998	DACIA	6001550446	AUDI	8K0407151B	FORD	1061668
AUDI	8E0498998S1	DACIA	6001550446S1	AUDI	8K0407151BS3	FORD	1061670
				AUDI	8K0407151C	FORD	1310333
							





S990013SK		S990014SK		S990015SK		S990016SK	
SEAT	6Q0407151D	AUDI	4B0419811G	CITROËN	3521C8	AUDI	1J0407151A
SEAT	6Q0407151E	AUDI	4D0419811J	PEUGEOT	3520G8	AUDI	1J0407365C
SEAT	6Q0407151L	AUDI	4E0407505B	PEUGEOT	381716	AUDI	1J0407366C
							

Cross References List And Photo

Photo.....



S990017SK		S990018SK		S990019SK		S990020SK	
AUDI	1K0411315B	BMW	31104026719	AUDI	1K0501529F	BMW	31126863785
AUDI	1K0411315D	BMW	31354014531	AUDI	1K0501530C	BMW	31126863786
AUDI	1K0411315E	BMW	31354014532	AUDI	1K0505223K	BMW	37116771929
							





S990022SK		S990025SK		S990026SK		S990027SK	
FORD	1004018	AUDI	7L0407021	AUDI	1J0411315D	AUDI	4G0411317A
FORD	1032567	AUDI	7L0407021A	AUDI	1J0411316D	AUDI	4H0411317C
FORD	1032689	AUDI	7L0407021B	AUDI	8N0407151A	AUDI	4M0411317
							

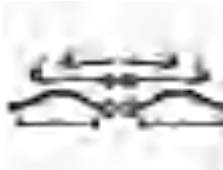



S990030SK		S990031SK		S990033SK		S990034SK	
BMW	31121092023	BMW	31121096985	ALFA ROMEO	36025748	MERCEDES-BENZ	2033200489
BMW	31121092024	BMW	31121096986	ALFA ROMEO	36025749	MERCEDES-BENZ	2033202589
BMW	31121093449	BMW	31122343358	ALFA ROMEO	46843389	MERCEDES-BENZ	2033202889
BMW	31121093450						
BMW	31121094233						
BMW	31121094234						
BMW	31121141717						
BMW	31121141718						
							

Cross References List And Photo

Photo.....





S990035SK	S990036SK	S990037SK	S990038SK
MERCEDES-BENZ 2113203889 MERCEDES-BENZ 2113203989 MERCEDES-BENZ 2113301511	BMW 31121096169 BMW 31121096170 BMW 31121096315	FORD 1061659 FORD 1061668 FORD 98AG5K743AF	MERCEDES-BENZ 1293500406 MERCEDES-BENZ 2013504406 MERCEDES-BENZ 2103500653 MERCEDES-BENZ 2103503806
			



S990039SK	S990040SK	S990042SK	S990044SK
MERCEDES-BENZ 2113203889 MERCEDES-BENZ 2113203989 MERCEDES-BENZ 2113301511	CITROËN 1646621980 PEUGEOT 3520G8 PEUGEOT 3521C8	FORD 1116578 FORD 1116579 FORD 1128483	CITROËN 3520J3 CITROËN 381709 CITROËN 501548
			

S990045SK	S990047SK	S990048SK	S990051SK
CITROËN 352095 CITROËN 352166 CITROËN 508737	HYUNDAI 545002H000 HYUNDAI 545002H100 HYUNDAI 545012H000	OPEL 4401852 OPEL 4401853 OPEL 4418192	BMW 1090815 BMW 1090816 BMW 1092292 BMW 1096797
			

Cross References List And Photo

Photo.....

S990054SK		S990055SK		S990056SK		S990060SK	
BMW	1090030	BMW	31121132159	MERCEDES-BENZ	2303502006	RENAULT	7701049282
BMW	1095411	BMW	31121133712	MERCEDES-BENZ	2303502706	RENAULT	7701049283
BMW	1095412			MERCEDES-BENZ	2303502806	RENAULT	8000273728
							

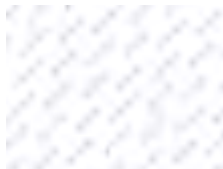
S990061SK		S990063SK		S990065SK		S990067SK	
AUDI	1K0411315B	CITROËN	1610936580	HYUNDAI	545002B000	AUDI	4B0419811B
AUDI	1K0423811F	CITROËN	1610936880	HYUNDAI	545002B100	AUDI	4B0419811E
AUDI	1K0423812F	CITROËN	508750	HYUNDAI	545012B000	AUDI	4B0419811F
							



- Facebook:** GSP Automotive Group
- LinkedIn:** GSP Automotive Group
- Youtube:** GSP Automotive Group
- Instagram:** gsp_automotive_group

GSP NETWORK

GSP Group Headquarter

No.1 GaoXiang Road, Wenzhou, China
Tel: 86-577-8629-3223
Email: info@gsp.cn

GSP Germany Cologne (Business Center)

Leyboldstrasse 10, 50354 Huerth, Germany
Tel: 49-223-3808-8418
Fax: 49-22-1941-0282
Email: info@gsp-europe.com

GSP Germany Hamburg (Distribution Center)

Werkstrasse, 1 22844 Norderstedt, Germany
Tel: 49-406-4669-9460
Fax: 49-22-1941-0282
Email: gsp@elbex-hamburg.de

GSP Poland Gdansk (Distribution Center)

Elbliska 130, 80-718 Gdańsk, Poland

GSP N.A South Carolina (Business Center)

2725 New Cut Road, Spartanburg, SC 29303, USA
Tel: 1-864-578-6900
Fax: 1-864-578-6978
Email: info@gsp-na.com

GSP N.A. Florida (Business Center)

2600 S. Douglas Rd., PH 10, Coral Gables, FL 33134, USA
Tel: 1-305-446-7702
Email: info@gsplatinamerica.com

GSP America Avondale (Distribution Center)

950 N 119th Ave Building A, Avondale, AZ 85323
Tel: 1-562-926-3525

GSP Mexico Queretaro (Business Center)

Manuel Gomez Morin, No EXT. 3960, PISO 1 OFICINA 1D,
Centro Sur, Queretaro, C.P.: 76090
Tel: 52-442-2449414
Email: info@gsplatinamerica.com

GSP Malaysia Johor (Distribution Center)

No. 18 (PLO 36), Jalan Teknologi 4, Taman Teknologi Johor,
81400 Senai, Johor, Malaysia
Tel: 86-577-86293120
Email: internationalsales@gsp.cn

GSP China Nanjing (Distribution Center)

No.59 Shuanghu Road, Gaochun county, Nanjing City
Tel: 0577-8629-3223

GSP China Shanghai (Business Center)

2138, 21/F, Mirae Asset Tower, No. 166 Lujiazui Ring Road,
Pudong District, Shanghai
Tel: 021-60631213



- Facebook:** GSP Automotive Group
- LinkedIn:** GSP Automotive Group
- Youtube:** GSP Automotive Group
- Instagram:** gsp_automotive_group

GSP NETWORK

GSP Group Headquarter

No.1 GaoXiang Road, Wenzhou, China
Tel: 86-577-8629-3223
Email: info@gsp.cn

GSP Germany Cologne (Business Center)

Leyboldstrasse 10, 50354 Huerth, Germany
Tel: 49-223-3808-8418
Fax: 49-22-1941-0282
Email: info@gsp-europe.com

GSP Germany Hamburg (Distribution Center)

Werkstrasse, 1 22844 Norderstedt, Germany
Tel: 49-406-4669-9460
Fax: 49-22-1941-0282
Email: gsp@elbex-hamburg.de

GSP Poland Gdansk (Distribution Center)

Elbląska 130, 80-718 Gdańsk, Poland

GSP N.A South Carolina (Business Center)

2725 New Cut Road, Spartanburg, SC 29303, USA
Tel: 1-864-578-6900
Fax: 1-864-578-6978
Email: info@gsp-na.com

GSP N.A. Florida (Business Center)

2600 S. Douglas Rd., PH 10, Coral Gables, FL 33134, USA
Tel: 1-305-446-7702
Email: info@gsplatinamerica.com

GSP America Avondale (Distribution Center)

950 N 119th Ave Building A, Avondale, AZ 85323
Tel: 1-562-926-3525

GSP Mexico Queretaro (Business Center)

Manuel Gomez Morin, No EXT. 3960, PISO 1 OFICINA 1D,
Centro Sur. Queretaro, C.P.: 76090
Tel: 52-442-2449414
Email: info@gsplatinamerica.com

GSP Malaysia Johor (Distribution Center)

No. 18 (PLO 36), Jalan Teknologi 4, Taman Teknologi Johor,
81400 Senai, Johor, Malaysia
Tel: 86-577-86293120
Email: internationalsales@gsp.cn

GSP China Nanjing (Distribution Center)

No.59 Shuanghu Road, Gaochun county, Nanjing City
Tel: 0577-8629-3223

GSP China Shanghai (Business Center)

2138, 21/F, Mirae Asset Tower, No. 166 Lujiazui Ring Road,
Pudong District, Shanghai
Tel: 021-60631213